



FCC RADIO TEST REPORT

FCC ID : UZ7EC55BK
Equipment : Enterprise Computer
Brand Name : Zebra
Model Name : EC55BK
Applicant : Zebra Technologies Corporation
1 Zebra Plaza, Holtsville, NY 11742
Manufacturer : Zebra Technologies Corporation
1 Zebra Plaza, Holtsville, NY 11742
Standard : FCC Part 15 Subpart C §15.247

The product was received on Jul. 22, 2020 and testing was started from Sep. 23, 2020 and completed on Oct. 20, 2020. We, SPORTON INTERNATIONAL INC., EMC & Wireless Communications Laboratory, would like to declare that the tested sample has been evaluated in accordance with the test procedures and has been in compliance with the applicable technical standards.

The test results in this variant report apply exclusively to the tested model / sample. Without written approval of SPORTON INTERNATIONAL INC. EMC & Wireless Communications Laboratory, the test report shall not be reproduced except in full.

Louis Wu

Approved by: Louis Wu

SPORTON INTERNATIONAL INC. EMC & Wireless Communications Laboratory

No. 52, Huaya 1st Rd., Guishan Dist., Taoyuan City, Taiwan (R.O.C.)



Table of Contents

History of this test report.....	3
Summary of Test Result.....	4
1 General Description.....	5
1.1 Product Feature of Equipment Under Test.....	5
1.2 Product Specification of Equipment Under Test.....	6
1.3 Modification of EUT	6
1.4 Testing Location	7
1.5 Applicable Standards.....	7
2 Test Configuration of Equipment Under Test.....	8
2.1 Carrier Frequency Channel	8
2.2 Test Mode.....	9
2.3 Connection Diagram of Test System.....	10
2.4 EUT Operation Test Setup	10
3 Test Result.....	11
3.1 Output Power Measurement.....	11
3.2 Radiated Band Edges and Spurious Emission Measurement	13
3.3 Antenna Requirements.....	15
4 List of Measuring Equipment	16
5 Uncertainty of Evaluation.....	17
Appendix A. Radiated Spurious Emission	
Appendix B. Radiated Spurious Emission Plots	
Appendix C. Duty Cycle Plots	
Appendix D. Setup Photographs	
Appendix E. Original Report	



History of this test report

Report No.	Version	Description	Issued Date
FR070405B	01	Initial issue of report	Nov. 05, 2020



Summary of Test Result

Report Clause	Ref Std. Clause	Test Items	Result (PASS/FAIL)	Remark
-	15.247(a)(2)	6dB Bandwidth	Not Required	-
-	2.1049	99% Occupied Bandwidth	Not Required	-
3.1	15.247(b)(3)	Output Power	Pass	-
-	15.247(e)	Power Spectral Density	Not Required	-
-	15.247(d)	Conducted Band Edges and Spurious Emission	Not Required	-
3.2	15.247(d)	Radiated Band Edges and Spurious Emission	Pass	Under limit 4.38 dB at 2493.880 MHz for WCN3990 Under limit 4.14 dB at 2483.520 MHz for NRF52810
-	15.207	AC Conducted Emission	Not Required	-
3.3	15.203 & 15.247(b)	Antenna Requirement	Pass	-

Note:

1. Not required means after assessing, test items are not necessary to carry out.
2. This is a variant report. The difference between EC55AK and EC55BK is the performance for cellular bands. The detail of similarity and difference can be found in Operation Description. All the test cases were performed on original report which can be referred to Sporton Report Number FR070401B as appendix E. Based on the original report, the test cases were verified.

Declaration of Conformity: The test results with all measurement uncertainty excluded are presented in accordance with the regulation limits or requirements declared by manufacturers.
Comments and Explanations: The declared of product specification for EUT presented in the report are provided by the manufacturer, and the manufacturer takes all the responsibilities for the accuracy of product specification.

Reviewed by: Wii Chang

Report Producer: Yimin Ho



1 General Description

1.1 Product Feature of Equipment Under Test

Product Feature	
Equipment	Enterprise Computer
Brand Name	Zebra
Model Name	EC55BK
FCC ID	UZ7EC55BK
EUT supports Radios application	GSM/WCDMA/HSPA/LTE/NFC/GNSS WLAN 11a/b/g/n HT20/HT40 WLAN 11ac VHT20/VHT40/VHT80 Bluetooth BR/EDR/LE
HW Version	EV2
SW Version	Android version 10
FW Version	10-13-12.00-QG-U0D-PRD-HEL-04
MFD	02JUL20
EUT Stage	Engineering Sample

Remark: The above EUT's information was declared by manufacturer.

Specification of Accessories				
AC Adapter	Brand Name	Zebra	Part Number	PWR-WUA5V15W0US
USB TYPE-C to TYPE-C cable	Brand Name	Zebra	Part Number	CBL-EC5X-USBC3A-01
Battery 1	Brand Name	Zebra	Part Number	BT-000424-00
Battery 2	Brand Name	Zebra	Part Number	BT-000424-08
Earphone 1	Brand Name	Zebra	Part Number	HDST-35MM-PTVP-01
Earphone 2	Brand Name	Zebra	Part Number	HS2100-OTH
USB TYPE C to 3.5mm audio connector	Brand Name	Symbol	Part Number	ADP-USBC-35MM1-01
3.5mm Jack 43"(1.1m) Standard Cable	Brand Name	Zebra	Part Number	CBL-HS2100-3MS1-01
Trigger Handle	Brand Name	Zebra	Part Number	TRG-EC5X-SNP1-01
Soft Holster	Brand Name	Zebra	Part Number	SG-EC5X-HLSTR1-01
Protective Boot	Brand Name	Zebra	Part Number	SG-EC5X-BOOT1-01



Sample list				
	Sample 1	Sample 2	Sample 3	Sample 4
Operating System	ANDROID	ANDROID	ANDROID	ANDROID
RAM	3GB	3GB	4GB	4GB
FLASH	32GB	32GB	64GB	64GB
Scanner	NO	SE4100	SE4100	SE4100
Front Camera	5MP	NO	5MP	5MP
Rear Camera	13MP	13MP	13MP	13MP
	MICRO SD	MICRO SD	MICRO SD	MICRO SD
	GMS	GMS	GMS	GMS
Back connector	NO I/O CONNECTOR	2-PIN	2-PIN	8-PIN
	ROW - Excludes China	ROW - Excludes China	ROW - Excludes China	ROW - Excludes China

1.2 Product Specification of Equipment Under Test

Product Specification subjective to this standard	
Tx/Rx Frequency Range	2402 MHz ~ 2480 MHz
Number of Channels	40
Carrier Frequency of Each Channel	40 Channel (37 hopping + 3 advertising channel)
Maximum Output Power to Antenna	<WCN3990> 5.60 dBm (0.0036 W) for 1Mbps 5.60 dBm (0.0036 W) for 2Mbps <NRF52810> 2.50 dBm (0.0018 W) for 1Mbps 2.40 dBm (0.0017 W) for 2Mbps
Antenna Type / Gain	PIFA Antenna type with gain 1.5 dBi
Type of Modulation	Bluetooth LE : GFSK

1.3 Modification of EUT

No modifications are made to the EUT during all test items.



1.4 Testing Location

Test Site	SPORTON INTERNATIONAL INC. EMC & Wireless Communications Laboratory
Test Site Location	No.52, Huaya 1st Rd., Guishan Dist., Taoyuan City, Taiwan (R.O.C.) TEL: +886-3-327-3456 FAX: +886-3-328-4978
Test Site No.	Sporton Site No.
	TH05-HY

Test Site	SPORTON INTERNATIONAL INC. EMC & Wireless Communications Laboratory
Test Site Location	No.58, Aly. 75, Ln. 564, Wenhua 3rd, Rd., Guishan Dist., Taoyuan City, Taiwan (R.O.C.) TEL: +886-3-327-0868 FAX: +886-3-327-0855
Test Site No.	Sporton Site No.
	03CH16-HY

Note: The test site complies with ANSI C63.4 2014 requirement.

FCC designation No.: TW1190 and TW0007

1.5 Applicable Standards

According to the specifications of the manufacturer, the EUT must comply with the requirements of the following standards:

- ♦ FCC Part 15 Subpart C §15.247
- ♦ FCC KDB Publication No. 558074 D01 DTS Meas. Guidance v05r02
- ♦ ANSI C63.10-2013

Remark:

1. All test items were verified and recorded according to the standards and without any deviation during the test.
2. The TAF code is not including all the FCC KDB listed without accreditation.
3. This EUT has also been tested and complied with the requirements of FCC Part 15, Subpart B, recorded in a separate test report.



2 Test Configuration of Equipment Under Test

2.1 Carrier Frequency Channel

Frequency Band	Channel	Freq. (MHz)	Channel	Freq. (MHz)
2400-2483.5 MHz	0	2402	21	2444
	1	2404	22	2446
	2	2406	23	2448
	3	2408	24	2450
	4	2410	25	2452
	5	2412	26	2454
	6	2414	27	2456
	7	2416	28	2458
	8	2418	29	2460
	9	2420	30	2462
	10	2422	31	2464
	11	2424	32	2466
	12	2426	33	2468
	13	2428	34	2470
	14	2430	35	2472
	15	2432	36	2474
	16	2434	37	2476
	17	2436	38	2478
	18	2438	39	2480
	19	2440	-	-
20	2442	-	-	



2.2 Test Mode

<WCN3990>

Channel	Frequency	Bluetooth – LE RF Average Output Power
		Data Rate / Modulation
		GFSK
		1Mbps
Ch00	2402MHz	4.90 dBm
Ch19	2440MHz	5.60 dBm
Ch39	2480MHz	5.30 dBm

Channel	Frequency	Bluetooth – LE RF Average Output Power
		Data Rate / Modulation
		GFSK
		2Mbps
Ch00	2402MHz	4.80 dBm
Ch19	2440MHz	5.60 dBm
Ch39	2480MHz	5.30 dBm

<NRF52810>

Channel	Frequency	Bluetooth – LE RF Average Output Power
		Data Rate / Modulation
		GFSK
		1Mbps
Ch00	2402MHz	2.50 dBm
Ch19	2440MHz	2.30 dBm
Ch39	2480MHz	2.40 dBm

Channel	Frequency	Bluetooth – LE RF Average Output Power
		Data Rate / Modulation
		GFSK
		2Mbps
Ch00	2402MHz	2.30 dBm
Ch19	2440MHz	2.30 dBm
Ch39	2480MHz	2.40 dBm

The EUT has been associated with peripherals and configuration operated in a manner tended to maximize its emission characteristics in a typical application. Frequency range investigated: radiation emission (1GHz to the 10th harmonic of the highest fundamental frequency or to 40 GHz, whichever is lower). For radiated measurement, pre-scanned in three orthogonal panels, X, Y, Z and Accessory. The worst cases (X plane) were recorded in this report.

The following summary table is showing all test modes to demonstrate in compliance with the standard.

Summary table of Test Cases	
Test Item	Data Rate / Modulation
	Bluetooth – LE / GFSK
Radiated Test Cases	Mode 1: Bluetooth Tx CH39_2480 MHz_2Mbps
Remark: For Radiated Test Cases, the tests were performed with Battery 1 and Sample 1	

2.3 Connection Diagram of Test System

<Bluetooth–LE Tx Mode>

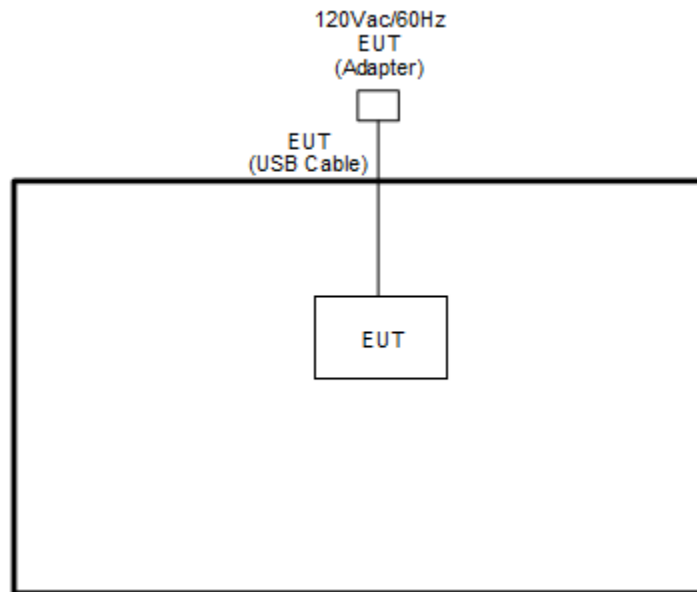

2.4 EUT Operation Test Setup

The RF test items, utility “QRCT v4.0” was installed in Notebook which was programmed in order to make the EUT get into the engineering modes to provide channel selection, power level, data rate and the application type and for continuous transmitting signals.

3 Test Result

3.1 Output Power Measurement

3.1.1 Limit of Output Power

For systems using digital modulation in the 2400-2483.5MHz, the limit for output power is 30dBm. If transmitting antenna of directional gain greater than 6dBi is used, the peak output power from the intentional radiator shall be reduced below the above stated value by the amount in dB that the directional gain of the antenna exceeds 6 dBi. In case of point-to-point operation, the limit has to be reduced by 1dB for every 3dB that the directional gain of the antenna exceeds 6dBi.

3.1.2 Measuring Instruments

See list of measuring equipment of this test report.

3.1.3 Test Procedures

1. For Average Power, the testing follows ANSI C63.10 Section 11.9.2.3.2 Method AVGP-M-G
2. The RF output of EUT was connected to the power meter by RF cable and attenuator.
3. The path loss was compensated to the results for each measurement.
4. Set to the maximum power setting and enable the EUT transmit continuously.
5. Measure the conducted output power and record the results in the test report.

3.1.4 Test Setup

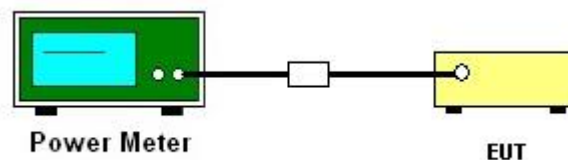



3.1.5 Test Result of Average Output Power

Test Engineer :	Kathy Chen	Temperature :	23.2°C
		Relative Humidity :	54.3%

<WCN3990>

Mod.	Data Rate	NTX	CH.	Freq. (MHz)	Average Conducted Power (dBm)
BLE	1Mbps	1	0	2402	4.90
BLE	1Mbps	1	19	2440	5.60
BLE	1Mbps	1	39	2480	5.30
BLE	2Mbps	1	0	2402	4.80
BLE	2Mbps	1	19	2440	5.60
BLE	2Mbps	1	39	2480	5.30

<NRF52810>

Mod.	Data Rate	NTX	CH.	Freq. (MHz)	Average Conducted Power (dBm)
BLE	1Mbps	1	0	2402	2.50
BLE	1Mbps	1	19	2440	2.30
BLE	1Mbps	1	39	2480	2.40
BLE	2Mbps	1	0	2402	2.30
BLE	2Mbps	1	19	2440	2.30
BLE	2Mbps	1	39	2480	2.40



3.2 Radiated Band Edges and Spurious Emission Measurement

3.2.1 Limit of Radiated Band Edges and Spurious Emission

In any 100 kHz bandwidth outside the intentional radiator frequency band, all harmonics/spurious must be at least 20 dB below the highest emission level within the authorized band. If the output power of this device was measured by spectrum analyzer, the attenuation under this paragraph shall be 30 dB instead of 20 dB. In addition, radiated emissions which fall in the restricted bands must also comply with the limits as below.

Frequency (MHz)	Field Strength (microvolts/meter)	Measurement Distance (meters)
0.009 – 0.490	2400/F(kHz)	300
0.490 – 1.705	24000/F(kHz)	30
1.705 – 30.0	30	30
30 – 88	100	3
88 – 216	150	3
216 - 960	200	3
Above 960	500	3

3.2.2 Measuring Instruments

See list of measuring equipment of this test report.

3.2.3 Test Procedures

1. The testing follows the ANSI C63.10 Section 11.12.1 Radiated emission measurements.
2. The EUT was arranged to its worst case and then tune the antenna tower (from 1 m to 4 m) and turntable (from 0 degree to 360 degrees) to find the maximum reading. A pre-amp and a high pass filter are used for the test in order to get better signal level.
3. The EUT was placed on a turntable with 1.5 meter for frequency above 1GHz respectively above ground.
4. The EUT was set 3 meters from the interference receiving antenna, which was mounted on the top of a variable height antenna tower.
5. Corrected Reading: Antenna Factor + Cable Loss + Read Level - Preamp Factor = Level
6. For testing above 1GHz, the emission level of the EUT in peak mode was 20dB lower than average limit (that means the emission level in average mode also complies with the limit in average mode), then peak values of EUT will be reported, otherwise, the emissions will be measured in average mode again and reported.

7. Use the following spectrum analyzer settings:
- (1) Span shall wide enough to fully capture the emission being measured;
 - (2) Set RBW=100 kHz for $f < 1$ GHz; VBW \geq RBW; Sweep = auto; Detector function = peak; Trace = max hold;
 - (3) Set RBW = 1 MHz, VBW= 3MHz for $f \geq 1$ GHz for peak measurement.
- For average measurement:
- VBW = 10 Hz, when duty cycle is no less than 98 percent.
 - VBW $\geq 1/T$, when duty cycle is less than 98 percent where T is the minimum transmission duration over which the transmitter is on and is transmitting at its maximum power control level for the tested mode of operation.

3.2.4 Test Setup

For radiated emissions above 1GHz

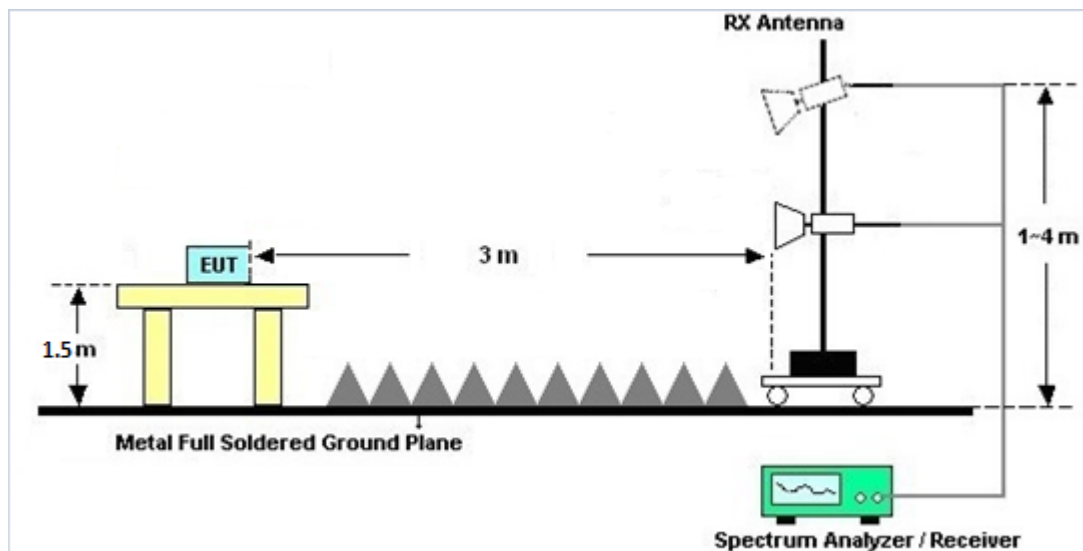

3.2.5 Test Result of Radiated Spurious at Band Edges

Please refer to Appendix A and B.

3.2.6 Duty Cycle

Please refer to Appendix C.

3.2.7 Test Result of Radiated Spurious Emission

Please refer to Appendix A and B.



3.3 Antenna Requirements

3.3.1 Standard Applicable

If directional gain of transmitting antennas is greater than 6dBi, the power shall be reduced by the same level in dB comparing to gain minus 6dBi. The use of a permanently attached antenna or of an antenna that uses a unique coupling to the intentional radiator shall be considered sufficient to comply with the rule.

3.3.2 Antenna Anti-Replacement Construction

An embedded-in antenna design is used.

3.3.3 Antenna Gain

The antenna peak gain of EUT is less than 6 dBi. Therefore, it is not necessary to reduce maximum peak output power limit.



4 List of Measuring Equipment

Instrument	Brand Name	Model No.	Serial No.	Characteristics	Calibration Date	Test Date	Due Date	Remark
Horn Antenna	SCHWARZBECK	BBHA 9120 D	9120D-1212	1G~18GHz	May 20, 2019	Sep. 23, 2020	May 19, 2020	Radiation (03CH16-HY)
Preamplifier	Jet-Power	JPA0118-55-303	1710001800 054001	1GHz~18GHz	Sep. 04, 2020	Sep. 23, 2020	Sep. 03, 2021	Radiation (03CH16-HY)
Preamplifier	Keysight	83017A	MY5327026 4	1GHz~26.5GHz	Dec. 11, 2019	Sep. 23, 2020	Dec. 10, 2020	Radiation (03CH16-HY)
EMI Test Receiver	Keysight	N9038A(MXE)	MY5729011 1	3Hz~26.5GHz	Dec. 05, 2019	Sep. 23, 2020	Dec. 04, 2020	Radiation (03CH16-HY)
RF Cable	HUBER + SUHNER	SUCOFLEX 104	MY11680/4 PE	NA	Aug. 29, 2020	Sep. 23, 2020	Aug. 28, 2021	Radiation (03CH16-HY)
RF Cable	HUBER + SUHNER	SUCOFLEX 104	MY11688/4 PE	NA	Aug. 29, 2020	Sep. 23, 2020	Aug. 28, 2021	Radiation (03CH16-HY)
RF Cable	HUBER + SUHNER	SUCOFLEX 102	EC-A5-300- 5757	NA	Aug. 29, 2020	Sep. 23, 2020	Aug. 28, 2021	Radiation (03CH16-HY)
Hygrometer	TECPEL	DTM-303B	TP162965	N/A	Oct. 25, 2019	Sep. 23, 2020	Oct. 24, 2020	Radiation (03CH16-HY)
Software	Audix	E3 6.2009-8-24	RK-001136	N/A	N/A	Sep. 23, 2020	N/A	Radiation (03CH16-HY)
Controller	ChainTek	3000-1	N/A	Control Turn table & Ant Mast	N/A	Sep. 23, 2020	N/A	Radiation (03CH16-HY)
Antenna Mast	ChainTek	MBS-520-1	N/A	1m~4m	N/A	Sep. 23, 2020	N/A	Radiation (03CH16-HY)
Turn Table	ChainTek	T-200-S-1	N/A	0~360 Degree	N/A	Sep. 23, 2020	N/A	Radiation (03CH16-HY)
Hygrometer	Testo	608-H1	34893241	N/A	Mar. 02, 2020	Oct. 20, 2020	Mar. 01, 2021	Conducted (TH05-HY)
Power Sensor	DARE	RPR3006W	16100054SN O10	10MHz~6GHz	Dec. 23, 2019	Oct. 20, 2020	Dec. 22, 2020	Conducted (TH05-HY)
Signal Analyzer	Rohde & Schwarz	FSV40	101397	10Hz~40GHz	Nov. 15, 2019	Oct. 20, 2020	Nov. 14, 2020	Conducted (TH05-HY)
Switch Box & RF Cable	EM Electronics	EMSW18SE	SW200302	N/A	Mar. 17, 2020	Oct. 20, 2020	Mar. 16, 2021	Conducted (TH05-HY)



5 Uncertainty of Evaluation

Uncertainty of Radiated Emission Measurement (1000 MHz ~ 18000 MHz)

Measuring Uncertainty for a Level of Confidence of 95% ($U = 2Uc(y)$)	6.3
---	-----



Appendix A. Radiated Spurious Emission

Test Engineer :	Jacky Hung, Andy Yang and CR Liao	Temperature :	20~25°C
		Relative Humidity :	50~60%

<WCN3990>

<2Mbps>

2.4GHz 2400~2483.5MHz

BLE (Band Edge @ 3m)

BLE	Note	Frequency	Level	Over	Limit	Read	Antenna	Path	Preamp	Ant	Table	Peak	Pol.
		(MHz)	(dBμV/m)	(dB)	(dBμV/m)	(dBμV)	(dB/m)	(dB)	(dB)	(cm)	(deg)	(P/A)	(H/V)
BLE CH 39 2480MHz	*	2480	101.15	-	-	84.77	27.54	18.66	29.82	101	205	P	H
	*	2480	99.86	-	-	83.48	27.54	18.66	29.82	101	205	A	H
		2493.76	57.9	-16.1	74	41.54	27.51	18.68	29.83	101	205	P	H
		2488	49.11	-4.89	54	32.74	27.52	18.67	29.82	101	205	A	H
													H
													H
	*	2480	96.42	-	-	80.04	27.54	18.66	29.82	400	92	P	V
	*	2480	95	-	-	78.62	27.54	18.66	29.82	400	92	A	V
		2493.56	56.92	-17.08	74	40.56	27.51	18.68	29.83	400	92	P	V
		2493.88	49.62	-4.38	54	33.26	27.51	18.68	29.83	400	92	A	V
													V
													V
Remark	1. No other spurious found. 2. All results are PASS against Peak and Average limit line.												



**2.4GHz 2400~2483.5MHz
BLE (Harmonic @ 3m)**

BLE	Note	Frequency (MHz)	Level (dBµV/m)	Over Limit (dB)	Limit Line (dBµV/m)	Read Level (dBµV)	Antenna Factor (dB/m)	Path Loss (dB)	Preamp Factor (dB)	Ant Pos (cm)	Table Pos (deg)	Peak Avg. (P/A)	Pol. (H/V)
BLE CH 39 2480MHz		4960	37.43	-36.57	74	52.41	31.24	13.36	59.58	100	0	P	H
		7440	43.59	-30.41	74	50	36.38	16.39	59.18	100	0	P	H
													H
													H
		4960	37.46	-36.54	74	52.44	31.24	13.36	59.58	100	0	P	V
		7440	44.86	-29.14	74	51.27	36.38	16.39	59.18	100	0	P	V
													V
													V
Remark	1. No other spurious found. 2. All results are PASS against Peak and Average limit line.												



<NRF52810>

<2Mbps>

2.4GHz 2400~2483.5MHz

BLE (Band Edge @ 3m)

BLE	Note	Frequency	Level	Over	Limit	Read	Antenna	Path	Preamp	Ant	Table	Peak	Pol.	
		(MHz)	(dBμV/m)	(dB)	Limit Line (dBμV/m)	Level (dBμV)	Factor (dB/m)	Loss (dB)	Factor (dB)	Pos (cm)	Pos (deg)	Avg. (P/A)	(H/V)	
BLE CH 39 2480MHz	*	2480	99.15	-	-	82.77	27.54	18.66	29.82	100	146	P	H	
	*	2480	98.02	-	-	81.64	27.54	18.66	29.82	100	146	A	H	
		2484.2	57.71	-16.29	74	41.34	27.53	18.66	29.82	100	146	P	H	
		2483.52	49.86	-4.14	54	33.49	27.53	18.66	29.82	100	146	A	H	
													H	
														H
	*	2480	92.71	-	-	76.33	27.54	18.66	29.82	400	95	P	V	
	*	2480	91.56	-	-	75.18	27.54	18.66	29.82	400	95	A	V	
		2486.88	57.88	-16.12	74	41.5	27.53	18.67	29.82	400	95	P	V	
		2484.04	49.27	-4.73	54	32.9	27.53	18.66	29.82	400	95	A	V	
													V	
												V		
Remark	1. No other spurious found. 2. All results are PASS against Peak and Average limit line.													



2.4GHz 2400~2483.5MHz
BLE (Harmonic @ 3m)

Table with 14 columns: BLE, Note, Frequency (MHz), Level (dBµV/m), Over Limit (dB), Limit Line (dBµV/m), Read Level (dBµV), Antenna Factor (dB/m), Path Loss (dB), Preamp Factor (dB), Ant Pos (cm), Table Pos (deg), Peak Avg. (P/A), Pol. (H/V). Rows include data for BLE CH 39 2480MHz and a Remark section.



Note symbol

*	Fundamental Frequency which can be ignored. However, the level of any unwanted emissions shall not exceed the level of the fundamental frequency.
!	Test result is over limit line.
P/A	Peak or Average
H/V	Horizontal or Vertical



A calculation example for radiated spurious emission is shown as below:

BLE	Note	Frequency	Level	Over	Limit	Read	Antenna	Path	Preamp	Ant	Table	Peak	Pol.
		(MHz)	(dBμV/m)	(dB)	Line	Level	Factor	Loss	Factor	Pos	Pos	Avg.	
					(dBμV/m)	(dBμV)	(dB/m)	(dB)	(dB)	(cm)	(deg)	(P/A)	(H/V)
BLE		2390	55.45	-18.55	74	54.51	32.22	4.58	35.86	103	308	P	H
CH 00		2390	43.54	-10.46	54	42.6	32.22	4.58	35.86	103	308	A	H
2402MHz													

1. Path Loss(dB) = Cable loss(dB) + Filter loss(dB) + Attenuator loss(dB)
2. Level(dBμV/m) =
Antenna Factor(dB/m) + Path Loss(dB) + Read Level(dBμV) - Preamp Factor(dB)
3. Over Limit(dB) = Level(dBμV/m) – Limit Line(dBμV/m)

For Peak Limit @ 2390MHz:

1. Level(dBμV/m)
= Antenna Factor(dB/m) + Path Loss(dB) + Read Level(dBμV) - Preamp Factor(dB)
= 32.22(dB/m) + 4.58(dB) + 54.51(dBμV) – 35.86 (dB)
= 55.45 (dBμV/m)
2. Over Limit(dB)
= Level(dBμV/m) – Limit Line(dBμV/m)
= 55.45(dBμV/m) – 74(dBμV/m)
= -18.55(dB)

For Average Limit @ 2390MHz:

1. Level(dBμV/m)
= Antenna Factor(dB/m) + Path Loss(dB) + Read Level(dBμV) - Preamp Factor(dB)
= 32.22(dB/m) + 4.58(dB) + 42.6(dBμV) – 35.86 (dB)
= 43.54 (dBμV/m)
2. Over Limit(dB)
= Level(dBμV/m) – Limit Line(dBμV/m)
= 43.54(dBμV/m) – 54(dBμV/m)
= -10.46(dB)

Both peak and average measured complies with the limit line, so test result is “PASS”.



Appendix B. Radiated Spurious Emission Plots

Test Engineer :	Jacky Hung, Andy Yang and CR Liao	Temperature :	20~25°C
		Relative Humidity :	50~60%

<WCN3990>

<2Mbps>

2.4GHz 2400~2483.5MHz

BLE (Band Edge @ 3m)

BLE	2.4GHz 2400~2483.5MHz Band Edge @ 3m	
	BLE CH39 2480MHz	
	Horizontal	Fundamental
Peak	<p>Site : 05CP16-14Y Condition : PEAK_BE_74 3m 9120D_1212 HORIZONTAL : RBW:1000.000KHz VBW:3000.000KHz SWT:Auto</p>	<p>Site : 05CP16-14Y Condition : PEAK_74 3m 9120D_1212 HORIZONTAL : RBW:1000.000KHz VBW:3000.000KHz SWT:Auto</p>

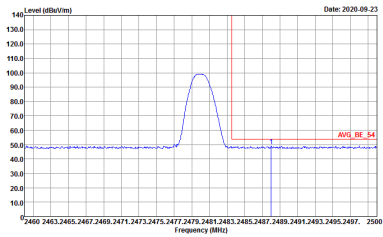
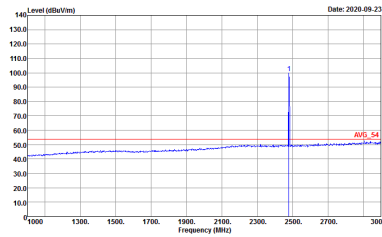

BLE	2.4GHz 2400~2483.5MHz Band Edge @ 3m	
	BLE CH39 2480MHz	
	Horizontal	Fundamental
Avg.	 <p>Date: 2020-09-23</p> <p>Site : 03CH16-HY Condition : AV6_BE_54 3m 91200_1212 HORIZONTAL : RBW:1000.000KHz VBW:10.000KHz SWT:Auto</p>	 <p>Date: 2020-09-23</p> <p>Site : 03CH16-HY Condition : AV6_54 3m 91200_1212 HORIZONTAL : RBW:1000.000KHz VBW:10.000KHz SWT:Auto</p>

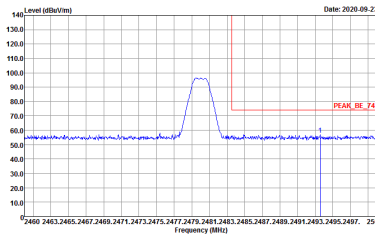
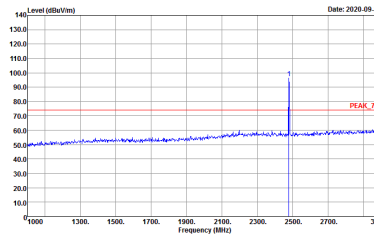
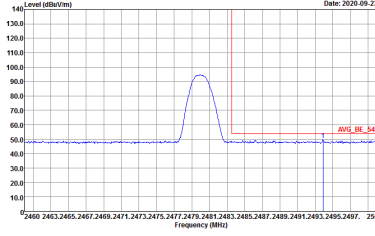
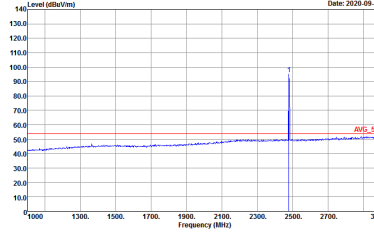

BLE	2.4GHz 2400~2483.5MHz Band Edge @ 3m	
	BLE CH39 2480MHz	
	Vertical	Fundamental
Peak	 <p>Date: 2020-09-23</p> <p>Site : 03CH16-HY Condition : PEAK_BE_74 3m 91200_1212 VERTICAL : RBW:1000.000KHz VBW:3000.000KHz SWT:Auto</p>	 <p>Date: 2020-09-23</p> <p>Site : 03CH16-HY Condition : PEAK_74 3m 91200_1212 VERTICAL : RBW:1000.000KHz VBW:3000.000KHz SWT:Auto</p>
Avg.	 <p>Date: 2020-09-23</p> <p>Site : 03CH16-HY Condition : AVG_BE_54 3m 91200_1212 VERTICAL : RBW:1000.000KHz VBW:30.000KHz SWT:Auto</p>	 <p>Date: 2020-09-23</p> <p>Site : 03CH16-HY Condition : AVG_54 3m 91200_1212 VERTICAL : RBW:1000.000KHz VBW:30.000KHz SWT:Auto</p>



2.4GHz 2400~2483.5MHz

BLE (Harmonic @ 3m)

BLE	2.4GHz 2400~2483.5MHz Harmonic @ 3m	
	BLE CH39 2480MHz	
	Horizontal	Vertical
Peak	<p>Site : 03CH16-14Y Condition : PEAK_74 3m 91200_1212 HORIZONTAL Detector : Peak</p>	<p>Site : 03CH16-14Y Condition : PEAK_74 3m 91200_1212 VERTICAL Detector : Peak</p>



<NRF52810>

<2Mbps>

2.4GHz 2400~2483.5MHz

BLE (Band Edge @ 3m)

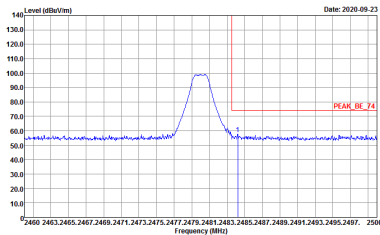
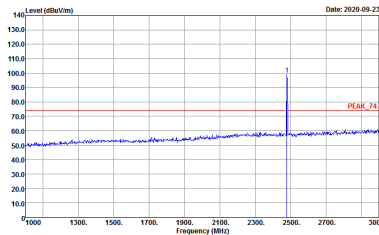
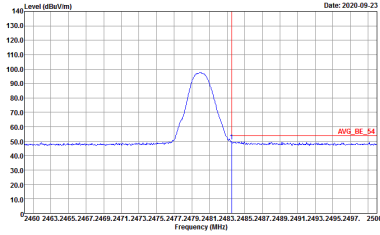
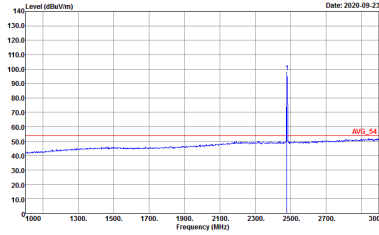
BLE	2.4GHz 2400~2483.5MHz Band Edge @ 3m	
	BLE CH39 2480MHz	
	Horizontal	Fundamental
Peak	 <p>Site : 03CH16-HY Condition : PEAK_BE_74 3m 91200_1212 HORIZONTAL : RBW:1000.000KHz VBW:3000.000KHz SWT:Auto</p>	 <p>Site : 03CH16-HY Condition : PEAK_74 3m 91200_1212 HORIZONTAL : RBW:1000.000KHz VBW:3000.000KHz SWT:Auto</p>
Avg.	 <p>Site : 03CH16-HY Condition : AV6_BE_54 3m 91200_1212 HORIZONTAL : RBW:1000.000KHz VBW:10.000KHz SWT:Auto</p>	 <p>Site : 03CH16-HY Condition : AV6_54 3m 91200_1212 HORIZONTAL : RBW:1000.000KHz VBW:10.000KHz SWT:Auto</p>

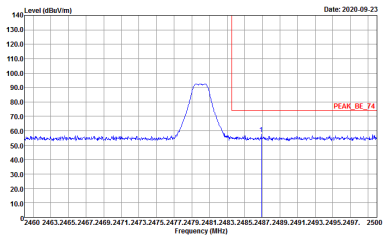
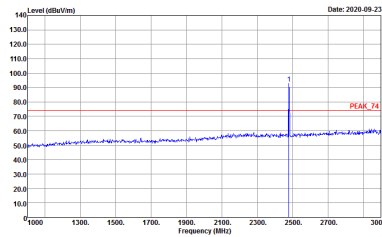
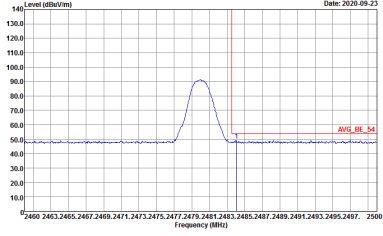
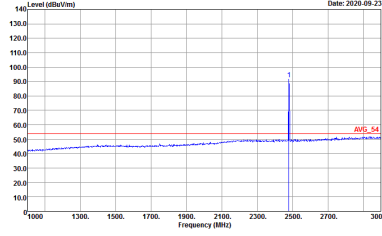

BLE	2.4GHz 2400~2483.5MHz Band Edge @ 3m	
BLE CH39 2480MHz		
Vertical		Fundamental
Peak	 <p>Date: 2020-09-23</p> <p>Site : 03CH16-HY Condition : PEAK_BE_74 3m 91200_1212 VERTICAL : RBW:1000.000KHz VBW:3000.000KHz SWT:Auto</p>	 <p>Date: 2020-09-23</p> <p>Site : 03CH16-HY Condition : PEAK_74 3m 91200_1212 VERTICAL : RBW:1000.000KHz VBW:3000.000KHz SWT:Auto</p>
Avg.	 <p>Date: 2020-09-23</p> <p>Site : 03CH16-HY Condition : AVG_BE_54 3m 91200_1212 VERTICAL : RBW:1000.000KHz VBW:30.000KHz SWT:Auto</p>	 <p>Date: 2020-09-23</p> <p>Site : 03CH16-HY Condition : AVG_54 3m 91200_1212 VERTICAL : RBW:1000.000KHz VBW:30.000KHz SWT:Auto</p>



2.4GHz 2400~2483.5MHz

BLE (Harmonic @ 3m)

BLE	2.4GHz 2400~2483.5MHz Harmonic @ 3m	
	BLE CH39 2480MHz	
	Horizontal	Vertical
Peak	<p>Site : 03CH16-14Y Condition : PEAK_74 3m 91200_1212 HORIZONTAL Detector : Peak</p>	<p>Site : 03CH16-14Y Condition : PEAK_74 3m 91200_1212 VERTICAL Detector : Peak</p>



Appendix C. Duty Cycle Plots

Band	Duty Cycle(%)	T(us)	1/T(kHz)	VBW Setting	Duty Factor(dB)
<WCN3990>					
Bluetooth –LE for 2Mbps	32.59	204	4.90	10kHz	4.87
<NRF52810>					
Bluetooth –LE for 2Mbps	32.69	204	4.90	10kHz	4.86

<WCN3990>

<NRF52810>

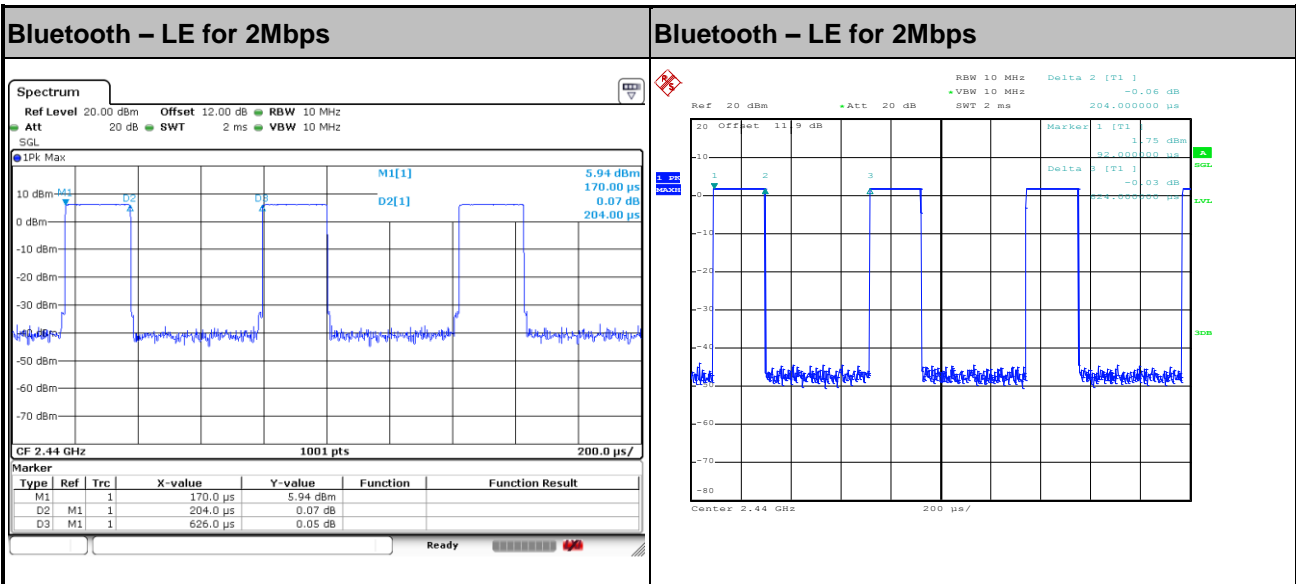



Appendix E. Original Report

Please refer to Sporton report number FR070401B as below.