



FCC RADIO TEST REPORT

FCC ID : UZ7EC55AK
Equipment : Enterprise Computer
Brand Name : Zebra
Model Name : EC55AK
Applicant : Zebra Technologies Corporation
1 Zebra Plaza, Holtsville, NY 11742
Manufacturer : Zebra Technologies Corporation
1 Zebra Plaza, Holtsville, NY 11742
Standard : FCC Part 15 Subpart C §15.247

The product was received on Jul. 22, 2020 and testing was started from Aug. 08, 2020 and completed on Sep. 23, 2020. We, SPORTON INTERNATIONAL INC., EMC & Wireless Communications Laboratory, would like to declare that the tested sample has been evaluated in accordance with the test procedures and has been in compliance with the applicable technical standards.

The test results in this report apply exclusively to the tested model / sample. Without written approval of SPORTON INTERNATIONAL INC. EMC & Wireless Communications Laboratory, the test report shall not be reproduced except in full.

Louis Wu

Approved by: Louis Wu

SPORTON INTERNATIONAL INC. EMC & Wireless Communications Laboratory

No. 52, Huaya 1st Rd., Guishan Dist., Taoyuan City, Taiwan (R.O.C.)



Table of Contents

History of this test report.....	3
Summary of Test Result.....	4
1 General Description	5
1.1 Product Feature of Equipment Under Test.....	5
1.2 Product Specification of Equipment Under Test.....	7
1.3 Modification of EUT	8
1.4 Testing Location	9
1.5 Applicable Standards.....	9
2 Test Configuration of Equipment Under Test	10
2.1 Carrier Frequency and Channel	10
2.2 Test Mode.....	10
2.3 Connection Diagram of Test System.....	18
2.4 Support Unit used in test configuration and system	19
2.5 EUT Operation Test Setup	20
2.6 Measurement Results Explanation Example.....	20
3 Test Result	21
3.1 6dB and 99% Bandwidth Measurement	21
3.2 Output Power Measurement.....	24
3.3 Power Spectral Density Measurement	29
3.4 Conducted Band Edges and Spurious Emission Measurement	33
3.5 Radiated Band Edges and Spurious Emission Measurement	82
3.6 AC Conducted Emission Measurement.....	87
3.7 Antenna Requirements	89
4 List of Measuring Equipment.....	90
5 Uncertainty of Evaluation	92
Appendix A. AC Conducted Emission Test Result	
Appendix B. Radiated Spurious Emission	
Appendix C. Radiated Spurious Emission Plots	
Appendix D. Duty Cycle Plots	
Appendix E. Setup Photographs	



History of this test report

Report No.	Version	Description	Issued Date
FR070401C	01	Initial issue of report	Oct. 27, 2020



Summary of Test Result

Report Clause	Ref Std. Clause	Test Items	Result (PASS/FAIL)	Remark
3.1	15.247(a)(2)	6dB Bandwidth	Pass	-
3.1	2.1049	99% Occupied Bandwidth	Reporting only	-
3.2	15.247(b)	Power Output Measurement	Pass	-
3.3	15.247(e)	Power Spectral Density	Pass	-
3.4	15.247(d)	Conducted Band Edges	Pass	-
		Conducted Spurious Emission	Pass	-
3.5	15.247(d)	Radiated Band Edges and Radiated Spurious Emission	Pass	Under limit 1.08 dB at 2483.520 MHz
3.6	15.207	AC Conducted Emission	Pass	Under limit 12.64 dB at 0.159 MHz
3.7	15.203 & 15.247(b)	Antenna Requirement	Pass	-

Declaration of Conformity:

The test results with all measurement uncertainty excluded are presented in accordance with the regulation limits or requirements declared by manufacturers.

Comments and Explanations:

The declared of product specification for EUT presented in the report are provided by the manufacturer, and the manufacturer takes all the responsibilities for the accuracy of product specification.

Reviewed by: Wii Chang

Report Producer: Lucy Wu



1 General Description

1.1 Product Feature of Equipment Under Test

Product Feature	
Equipment	Enterprise Computer
Brand Name	Zebra
Model Name	EC55AK
FCC ID	UZ7EC55AK
EUT supports Radios application	WCDMA/HSPA/LTE/NFC/GNSS WLAN 11a/b/g/n HT20/HT40 WLAN 11ac VHT20/VHT40/VHT80 Bluetooth BR/EDR/LE
HW Version	EV2
SW Version	Android version 10
FW Version	10-13-12.00-QG-U00-PRD-HEL-04
MFD	22JUN20 17JUN20
EUT Stage	Engineering Sample

Remark: The above EUT's information was declared by manufacturer.

Specification of Accessories				
AC Adapter	Brand Name	Zebra	Part Number	PWR-WUA5V15W0US
USB TYPE-C to TYPE-C cable	Brand Name	Zebra	Part Number	CBL-EC5X-USBC3A-01
Battery 1	Brand Name	Zebra	Part Number	BT-000424-00
Battery 2	Brand Name	Zebra	Part Number	BT-000424-08
Earphone 1	Brand Name	Zebra	Part Number	HDST-35MM-PTVP-01
Earphone 2	Brand Name	Zebra	Part Number	HS2100-OTH
USB TYPE C to 3.5mm audio connector	Brand Name	Symbol	Part Number	ADP-USBC-35MM1-01
3.5mm Jack 43"(1.1m) Standard Cable	Brand Name	Zebra	Part Number	CBL-HS2100-3MS1-01
Trigger Handle	Brand Name	Zebra	Part Number	TRG-EC5X-SNP1-01
Soft Holster	Brand Name	Zebra	Part Number	SG-EC5X-HLSTR1-01
Protective Boot	Brand Name	Zebra	Part Number	SG-EC5X-BOOT1-01



Sample list				
	Sample 1	Sample 2	Sample 3	Sample 4
Operating System	ANDROID	ANDROID	ANDROID	ANDROID
RAM	3GB	3GB	4GB	4GB
FLASH	32GB	32GB	64GB	64GB
Scanner	NO	SE4100	SE4100	SE4100
Front Camera	5MP	NO	5MP	5MP
Rear Camera	13MP	13MP	13MP	13MP
	MICRO SD	MICRO SD	MICRO SD	MICRO SD
	GMS	GMS	GMS	GMS
Back connector	NO I/O CONNECTOR	2-PIN	2-PIN	8-PIN
	US	US	US	US

1.2 Product Specification of Equipment Under Test

Product Specification subjective to this standard	
Tx/Rx Channel Frequency Range	2412 MHz ~ 2462 MHz
Maximum Peak Output Power to antenna	<p><Ant. 0>: 802.11b : 20.26 dBm (0.1062 W) 802.11g : 22.10 dBm (0.1622 W) 802.11n HT20 : 22.56 dBm (0.1803 W) 802.11n HT40 : 22.14 dBm (0.1637 W)</p> <p><Ant. 1>: 802.11b : 20.35 dBm (0.1084 W) 802.11g : 22.42 dBm (0.1746 W) 802.11n HT20 : 22.43 dBm (0.1750 W) 802.11n HT40 : 22.85 dBm (0.1928 W)</p> <p>MIMO <Ant. 0 + 1>: 802.11b : 23.33 dBm (0.2153 W) 802.11g : 25.15 dBm (0.3273 W) 802.11n HT20 : 25.21 dBm (0.3319 W) 802.11n HT40 : 24.87 dBm (0.3069 W)</p>
Maximum Average Output Power to antenna	<p><Ant. 0>: 802.11b : 17.93 dBm (0.0621 W) 802.11g : 17.73 dBm (0.0593 W) 802.11n HT20 : 17.97 dBm (0.0627 W) 802.11n HT40 : 16.92 dBm (0.0492 W)</p> <p><Ant. 1>: 802.11b : 17.92 dBm (0.0619 W) 802.11g : 17.95 dBm (0.0624 W) 802.11n HT20 : 17.80 dBm (0.0603 W) 802.11n HT40 : 17.32 dBm (0.0540 W)</p> <p>MIMO <Ant. 0 + 1>: 802.11b : 20.98 dBm (0.1253 W) 802.11g : 20.86 dBm (0.1219 W) 802.11n HT20 : 20.78 dBm (0.1197 W) 802.11n HT40 : 19.30 dBm (0.0851 W)</p>



Product Specification subjective to this standard														
99% Occupied Bandwidth	<Ant. 0>: 802.11b : 14.20 MHz 802.11g : 17.05 MHz 802.11n HT20 : 18.05 MHz 802.11n HT40 : 36.70 MHz <Ant. 1>: 802.11b : 13.70 MHz 802.11g : 16.95 MHz 802.11n HT20 : 17.95 MHz 802.11n HT40 : 36.70 MHz MIMO <Ant. 0>: 802.11b : 14.40 MHz 802.11g : 17.20 MHz 802.11n HT20 : 18.10 MHz 802.11n HT40 : 36.70 MHz MIMO <Ant. 1>: 802.11b : 13.95 MHz 802.11g : 16.95 MHz 802.11n HT20 : 18.00 MHz 802.11n HT40 : 36.60 MHz													
	Antenna Type / Gain <Ant. 0>: PIFA Antenna with gain 1.50 dBi <Ant. 1>: PIFA Antenna with gain 1.20 dBi													
Type of Modulation 802.11b : DSSS (DBPSK / DQPSK / CCK) 802.11g/n : OFDM (BPSK / QPSK / 16QAM / 64QAM)														
Antenna Function Description	<table border="1"> <thead> <tr> <th></th> <th>Ant. 0</th> <th>Ant. 1</th> </tr> </thead> <tbody> <tr> <td>802.11 b/g/n</td> <td>V</td> <td>V</td> </tr> <tr> <td>802.11 b/g/n</td> <td>V</td> <td>V</td> </tr> <tr> <td>MIMO</td> <td>V</td> <td>V</td> </tr> </tbody> </table>			Ant. 0	Ant. 1	802.11 b/g/n	V	V	802.11 b/g/n	V	V	MIMO	V	V
		Ant. 0	Ant. 1											
	802.11 b/g/n	V	V											
802.11 b/g/n	V	V												
MIMO	V	V												

Note: MIMO Ant. 0+1 is a calculated result from sum of the power MIMO Ant. 0 and MIMO Ant. 1.

1.3 Modification of EUT

No modifications are made to the EUT during all test items.



1.4 Testing Location

Test Site	SPORTON INTERNATIONAL INC. EMC & Wireless Communications Laboratory	
Test Site Location	No.52, Huaya 1st Rd., Guishan Dist., Taoyuan City, Taiwan (R.O.C.) TEL: +886-3-327-3456 FAX: +886-3-328-4978	
Test Site No.	Sporton Site No.	
	TH05-HY	CO05-HY

Note: The test site complies with ANSI C63.4 2014 requirement.

Test Site	SPORTON INTERNATIONAL INC. EMC & Wireless Communications Laboratory	
Test Site Location	No.58, Aly. 75, Ln. 564, Wenhua 3rd, Rd., Guishan Dist., Taoyuan City, Taiwan (R.O.C.) TEL: +886-3-327-0868 FAX: +886-3-327-0855	
Test Site No.	Sporton Site No.	
	03CH16-HY	

Note: The test site complies with ANSI C63.4 2014 requirement.

FCC designation No.: TW1190 and TW0007

1.5 Applicable Standards

According to the specifications of the manufacturer, the EUT must comply with the requirements of the following standards:

- ♦ FCC Part 15 Subpart C §15.247
- ♦ FCC KDB Publication No. 558074 D01 DTS Meas. Guidance v05r02
- ♦ FCC KDB 414788 D01 Radiated Test Site v01r01.
- ♦ FCC KDB 662911 D01 Multiple Transmitter Output v02r01.
- ♦ ANSI C63.10-2013

Remark:

1. All test items were verified and recorded according to the standards and without any deviation during the test.
2. The TAF code is not including all the FCC KDB listed without accreditation.
3. This EUT has also been tested and complied with the requirements of FCC Part 15, Subpart B, recorded in a separate test report.



2 Test Configuration of Equipment Under Test

- a. The EUT has been associated with peripherals and configuration operated in a manner tended to maximize its emission characteristics in a typical application. Frequency range investigated: conduction emission (150 kHz to 30 MHz), radiation emission (9 kHz to the 10th harmonic of the highest fundamental frequency or to 40 GHz, whichever is lower). For radiated measurement, pre-scanned in three orthogonal panels, X, Y, Z. The worst cases (X plane) were recorded in this report.
- b. AC power line Conducted Emission was tested under maximum output power.

2.1 Carrier Frequency and Channel

Frequency Band	Channel	Freq. (MHz)	Channel	Freq. (MHz)
2400-2483.5 MHz	1	2412	7	2442
	2	2417	8	2447
	3	2422	9	2452
	4	2427	10	2457
	5	2432	11	2462
	6	2437		

2.2 Test Mode

Final test modes are considering the modulation and worse data rates as below table.

Modulation	Data Rate
802.11b	1 Mbps
802.11g	6 Mbps
802.11n HT20	MCS0
802.11n HT40	MCS0



Test Cases	
AC Conducted Emission	Mode 1: WCDMA Band V Idle + WLAN (2.4GHz) Link + Bluetooth Link + NFC On + Battery 2 + GPS Rx + USB Cable (Charging from AC Adaptor) + SIM 1 for Sample 2
Remark: For Radiated Test Cases, the tests were performed with Battery 1 and Sample 1.	

Ch. #	2400-2483.5 MHz			
	802.11b	802.11g	802.11n HT20	802.11n HT40
Low	01	01	01	03
Middle	06	06	06	06
High	11	11	11	09

Remark: For radiation spurious emission, the final modulation and the worst data rate was reference the max RF conducted power.

<Ant. 0>

802.11b RF Peak Output Power (dBm)						
Power vs. Channel			Power vs Data Rate			
Channel	Frequency (MHz)	Data Rate (bps)	Channel	Data Rate (bps)		
		1M		2M	5.5M	11M
CH 01	2412	20.08	CH 06	20.22	20.21	20.22
CH 06	2437	20.26				
CH 11	2462	20.07				

802.11g RF Peak Output Power (dBm)										
Power vs. Channel			Power vs Data Rate							
Channel	Frequency (MHz)	Data Rate (bps)	Channel	Data Rate (bps)						
		6M		9Mbps	12Mbps	18Mbps	24Mbps	36Mbps	48Mbps	54Mbps
CH 01	2412	20.53	CH 06	21.90	21.90	22.00	22.00	21.90	21.80	21.80
CH 06	2437	22.10								
CH 11	2462	21.17								



802.11n HT20 RF Peak Output Power (dBm)										
Power vs. Channel			Power vs Data Rate							
Channel	Frequency (MHz)	MCS Index	Channel	MCS Index						
		MCS 0		MCS 1	MCS 2	MCS 3	MCS 4	MCS 5	MCS 6	MCS 7
CH 01	2412	18.94	CH 06	22.46	22.46	22.42	22.37	22.42	22.42	22.42
CH 06	2437	22.56								
CH 11	2462	20.13								

802.11n HT40 RF Peak Output Power (dBm)										
Power vs. Channel			Power vs Data Rate							
Channel	Frequency (MHz)	MCS Index	Channel	MCS Index						
		MCS 0		MCS 1	MCS 2	MCS 3	MCS 4	MCS 5	MCS 6	MCS 7
CH 03	2422	17.13	CH 06	22.04	22.04	22.04	22.04	22.04	22.04	22.04
CH 06	2437	22.14								
CH 09	2452	20.58								

<Ant. 1>

802.11b RF Peak Output Power (dBm)						
Power vs. Channel			Power vs Data Rate			
Channel	Frequency (MHz)	Data Rate (bps)	Channel	Data Rate (bps)		
		1M		2M	5.5M	11M
CH 01	2412	20.34	CH 06	20.25	20.15	20.25
CH 06	2437	20.35				
CH 11	2462	20.19				

802.11g RF Peak Output Power (dBm)										
Power vs. Channel			Power vs Data Rate							
Channel	Frequency (MHz)	Data Rate (bps)	Channel	Data Rate (bps)						
		6M		9Mbps	12Mbps	18Mbps	24Mbps	36Mbps	48Mbps	54Mbps
CH 01	2412	22.21	CH 06	22.31	22.31	22.31	22.34	22.23	22.24	22.26
CH 06	2437	22.42								
CH 11	2462	21.92								



802.11n HT20 RF Peak Output Power (dBm)										
Power vs. Channel			Power vs Data Rate							
Channel	Frequency (MHz)	MCS Index	Channel	MCS Index						
		MCS 0		MCS 1	MCS 2	MCS 3	MCS 4	MCS 5	MCS 6	MCS 7
CH 01	2412	21.54	CH 06	22.33	22.33	22.22	22.22	22.25	22.25	22.27
CH 06	2437	22.43								
CH 11	2462	22.00								

802.11n HT40 RF Peak Output Power (dBm)										
Power vs. Channel			Power vs Data Rate							
Channel	Frequency (MHz)	MCS Index	Channel	MCS Index						
		MCS 0		MCS 1	MCS 2	MCS 3	MCS 4	MCS 5	MCS 6	MCS 7
CH 03	2422	21.62	CH 06	22.78	22.78	22.78	22.74	22.74	22.81	22.81
CH 06	2437	22.85								
CH 09	2452	22.37								

MIMO <Ant. 0+1>

802.11b RF Peak Output Power (dBm)						
Power vs. Channel			Power vs Data Rate			
Channel	Frequency (MHz)	Data Rate (bps)	Channel	Data Rate (bps)		
		1M		2M	5.5M	11M
CH 01	2412	23.12	CH 06	23.29	23.31	23.31
CH 06	2437	23.33				
CH 11	2462	23.29				

802.11g RF Peak Output Power (dBm)										
Power vs. Channel			Power vs Data Rate							
Channel	Frequency (MHz)	Data Rate (bps)	Channel	Data Rate (bps)						
		6M		9Mbps	12Mbps	18Mbps	24Mbps	36Mbps	48Mbps	54Mbps
CH 01	2412	24.05	CH 06	25.01	25.00	24.95	24.95	25.01	25.05	25.05
CH 06	2437	25.15								
CH 11	2462	23.28								



802.11n HT20 RF Peak Output Power (dBm)										
Power vs. Channel			Power vs Data Rate							
Channel	Frequency (MHz)	MCS Index	Channel	MCS Index						
		MCS0		MCS1	MCS2	MCS3	MCS4	MCS5	MCS6	MCS7
CH 01	2412	21.47	CH 06	25.13	25.13	25.13	25.09	25.09	25.07	25.07
CH 06	2437	25.21								
CH 11	2462	22.42								

802.11n HT40 RF Peak Output Power (dBm)										
Power vs. Channel			Power vs Data Rate							
Channel	Frequency (MHz)	MCS Index	Channel	MCS Index						
		MCS0		MCS1	MCS2	MCS3	MCS4	MCS5	MCS6	MCS7
CH 03	2422	20.48	CH 06	24.77	24.77	24.77	24.77	24.77	24.77	24.77
CH 06	2437	24.87								
CH 09	2452	23.03								

<Ant. 0>

802.11b RF Avg. Output Power (dBm)						
Power vs. Channel			Power vs Data Rate			
Channel	Frequency (MHz)	Data Rate (bps)	Channel	Data Rate (bps)		
		1M		2M	5.5M	11M
Duty Cycle (%)		99.12	CH 06	97.72	95.52	93.02
CH 01	2412	17.88		17.89	17.89	17.90
CH 06	2437	17.93				
CH 11	2462	17.86				

802.11g RF Avg. Output Power (dBm)										
Power vs. Channel			Power vs Data Rate							
Channel	Frequency (MHz)	Data Rate (bps)	Channel	Data Rate (bps)						
		6M		9Mbps	12Mbps	18Mbps	24Mbps	36Mbps	48Mbps	54Mbps
Duty Cycle (%)		98.33	CH 06	97.65	95.85	95.35	93.85	91.35	89.45	87.75
CH 01	2412	16.19		17.46	17.50	17.43	17.50	17.51	17.50	17.69
CH 06	2437	17.73								
CH 11	2462	17.06								



802.11n HT20 RF Avg. Output Power (dBm)										
Power vs. Channel			Power vs Data Rate							
Channel	Frequency (MHz)	MCS Index	Channel	MCS Index						
		MCS 0		MCS 1	MCS 2	MCS 3	MCS 4	MCS 5	MCS 6	MCS 7
Duty Cycle (%)		98.21		96.94	95.34	93.84	91.44	89.04	88.04	87.04
CH 01	2412	14.20	CH 06							
CH 06	2437	17.97		17.92	17.90	17.89	17.80	17.83	17.88	17.93
CH 11	2462	15.53								

802.11n HT40 RF Avg. Output Power (dBm)										
Power vs. Channel			Power vs Data Rate							
Channel	Frequency (MHz)	MCS Index	Channel	MCS Index						
		MCS 0		MCS 1	MCS 2	MCS 3	MCS 4	MCS 5	MCS 6	MCS 7
Duty Cycle (%)		94.50		91.16	87.56	84.36	79.46	75.86	73.56	70.76
CH 03	2422	11.35	CH 06							
CH 06	2437	16.92		16.90	16.90	16.88	16.90	16.91	16.90	16.90
CH 09	2452	14.42								

<Ant. 1>

802.11b RF Avg. Output Power (dBm)						
Power vs. Channel			Power vs Data Rate			
Channel	Frequency (MHz)	Data Rate (bps)	Channel	Data Rate (bps)		
		1M		2M	5.5M	11M
Duty Cycle (%)		99.44		98.60	96.40	93.90
CH 01	2412	17.89	CH 06			
CH 06	2437	17.92		17.86	17.86	17.87
CH 11	2462	17.85				



802.11g RF Avg. Output Power (dBm)										
Power vs. Channel			Power vs Data Rate							
Channel	Frequency (MHz)	Data Rate (bps)	Channel	Data Rate (bps)						
		6M		9Mbps	12Mbps	18Mbps	24Mbps	36Mbps	48Mbps	54Mbps
Duty Cycle (%)		98.33		97.89	97.09	95.59	94.09	91.59	89.19	88.09
CH 01	2412	17.92	CH 06							
CH 06	2437	17.95		17.87	17.91	17.92	17.56	17.58	17.70	17.75
CH 11	2462	17.71								

802.11n HT20 RF Avg. Output Power (dBm)										
Power vs. Channel			Power vs Data Rate							
Channel	Frequency (MHz)	MCS Index	Channel	MCS Index						
		MCS 0		MCS 1	MCS 2	MCS 3	MCS 4	MCS 5	MCS 6	MCS 7
Duty Cycle (%)		98.21		96.84	95.24	94.34	90.74	88.64	87.94	86.64
CH 01	2412	16.78	CH 06							
CH 06	2437	17.80		17.76	17.76	17.69	17.66	17.68	17.72	17.78
CH 11	2462	17.53								

802.11n HT40 RF Avg. Output Power (dBm)										
Power vs. Channel			Power vs Data Rate							
Channel	Frequency (MHz)	MCS Index	Channel	MCS Index						
		MCS 0		MCS 1	MCS 2	MCS 3	MCS 4	MCS 5	MCS 6	MCS 7
Duty Cycle (%)		95.00		91.16	87.56	84.36	79.46	75.86	73.56	70.76
CH 03	2422	15.37	CH 06							
CH 06	2437	17.32		17.30	17.29	17.31	17.30	17.27	17.29	17.31
CH 09	2452	16.41								



MIMO <Ant. 0+1>

802.11b RF Avg. Output Power (dBm)						
Power vs. Channel			Power vs Data Rate			
Channel	Frequency (MHz)	Data Rate (bps)	Channel	Data Rate (bps)		
		1M		2M	5.5M	11M
CH 01	2412	20.84	CH 06	23.29	23.31	23.31
CH 06	2437	20.98				
CH 11	2462	20.94				

802.11g RF Avg. Output Power (dBm)										
Power vs. Channel			Power vs Data Rate							
Channel	Frequency (MHz)	Data Rate (bps)	Channel	Data Rate (bps)						
		6M		9Mbps	12Mbps	18Mbps	24Mbps	36Mbps	48Mbps	54Mbps
CH 01	2412	19.77	CH 06	20.68	20.67	20.59	20.65	20.68	20.75	20.85
CH 06	2437	20.86								
CH 11	2462	18.70								

802.11n HT20 RF Avg. Output Power (dBm)										
Power vs. Channel			Power vs Data Rate							
Channel	Frequency (MHz)	MCS Index	Channel	MCS Index						
		MCS0		MCS1	MCS2	MCS3	MCS4	MCS5	MCS6	MCS7
CH 01	2412	16.63	CH 06	20.72	20.67	20.73	20.76	20.75	20.69	20.74
CH 06	2437	20.78								
CH 11	2462	17.57								

802.11n HT40 RF Avg. Output Power (dBm)										
Power vs. Channel			Power vs Data Rate							
Channel	Frequency (MHz)	MCS Index	Channel	MCS Index						
		MCS0		MCS1	MCS2	MCS3	MCS4	MCS5	MCS6	MCS7
CH 03	2422	14.80	CH 06	17.30	17.29	17.31	17.30	17.27	17.29	17.31
CH 06	2437	19.30								
CH 09	2452	16.76								

2.3 Connection Diagram of Test System

<AC Conducted Emission Mode>

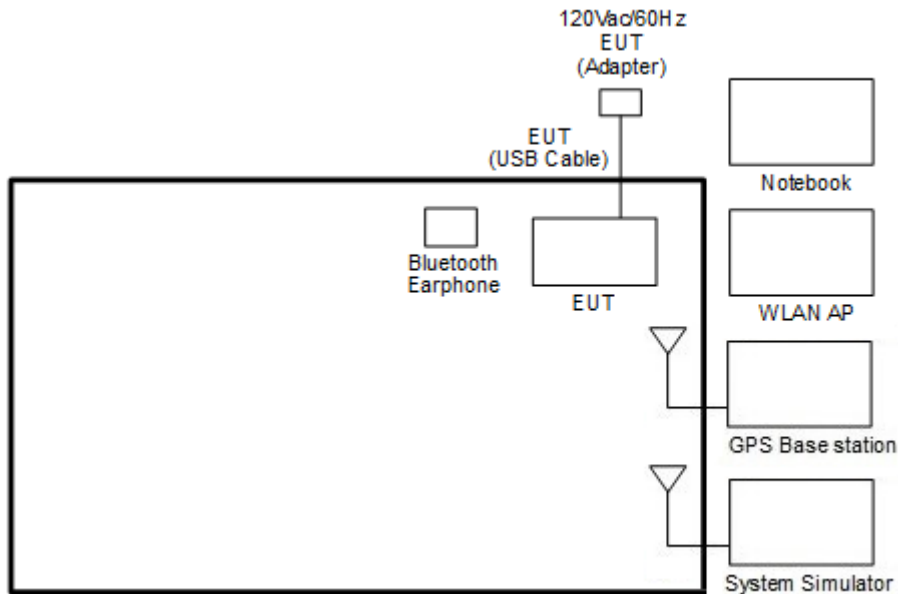

<WLAN Tx Mode>

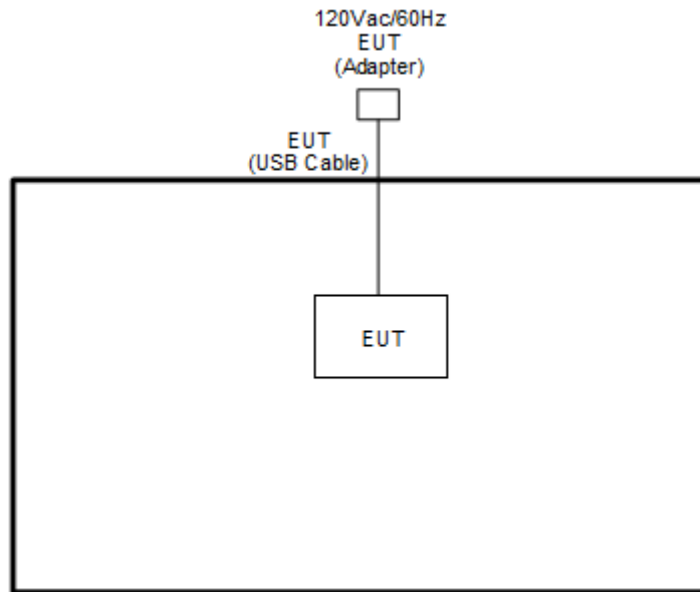

2.4 Support Unit used in test configuration and system

Item	Equipment	Brand Name	Model Name	FCC ID	Data Cable	Power Cord
1.	System Simulator	Anritsu	MT8820C	N/A	N/A	Unshielded, 1.8 m
2.	GPS Station	Pendulum	GSG-54	N/A	N/A	Unshielded, 1.8m
3.	Bluetooth Earphone	Sony Ericsson	MW600	PY7DDA-2029	N/A	N/A
4.	WLAN AP	ASUS	RT-AC66U	MSQ-RTAC66U	N/A	Unshielded, 1.8 m
5.	Notebook	Dell	Latitude 3400	FCC DoC	N/A	AC I/P : Unshielded, 1.2m DC O/P : Shielded, 1.8m
6.	SD Card	SanDisk	MicroSD HC	FCC DoC	N/A	N/A



2.5 EUT Operation Test Setup

The RF test items, utility “QRCT4.0” was installed in Notebook which was programmed in order to make the EUT get into the engineering modes to provide channel selection, power level, data rate and the application type and for continuous transmitting signals.

2.6 Measurement Results Explanation Example

For all conducted test items:

The offset level is set in the spectrum analyzer to compensate the RF cable loss and attenuator factor between EUT conducted output port and spectrum analyzer. With the offset compensation, the spectrum analyzer reading level is exactly the EUT RF output level.

Example:

The spectrum analyzer offset is derived from RF cable loss and attenuator factor.

Offset = RF cable loss + attenuator factor.

Following shows an offset computation example with cable loss 4.2 dB and 10dB attenuator.

$$\begin{aligned} \text{Offset}(dB) &= \text{RF cable loss}(dB) + \text{attenuator factor}(dB). \\ &= 4.2 + 10 = 14.2 \text{ (dB)} \end{aligned}$$

3 Test Result

3.1 6dB and 99% Bandwidth Measurement

3.1.1 Limit of 6dB and 99% Bandwidth

The minimum 6 dB bandwidth shall be at least 500 kHz.

3.1.2 Measuring Instruments

See list of measuring equipment of this test report.

3.1.3 Test Procedures

1. The testing follows the ANSI C63.10 Section 6.9.3 (OBW) and 11.8.1 (6dB BW).
2. The RF output of EUT was connected to the spectrum analyzer by RF cable and attenuator. The path loss was compensated to the results for each measurement.
3. Set to the maximum power setting and enable the EUT transmit continuously.
4. Make the measurement with the spectrum analyzer's resolution bandwidth (RBW) = 100 kHz. Set the Video bandwidth (VBW) = 300 kHz. In order to make an accurate measurement. The 6 dB bandwidth must be greater than 500 kHz.
5. For 99% Bandwidth Measurement, the spectrum analyzer's resolution bandwidth (RBW) is set 1-5% of the emission bandwidth and set the Video bandwidth (VBW) $\geq 3 * RBW$.
6. Measure and record the results in the test report.

3.1.4 Test Setup

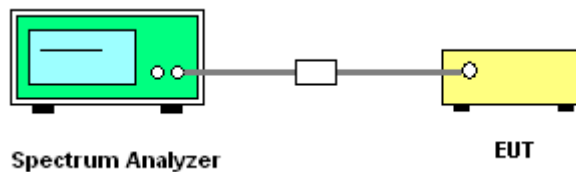



3.1.5 Test Result of 6dB and 99% Occupied Bandwidth

Test Engineer :	Kathy Chen	Temperature :	23.6~24.5°C
		Relative Humidity :	53.6~54.3%

2.4GHz Band										
Mod.	Data Rate	NTX	CH.	Freq. (MHz)	99% Occupied BW (MHz)		6dB BW (MHz)		6dB BW Limit (MHz)	Pass/Fail
					Ant0	Ant1	Ant1	Ant2		
11b	1Mbps	1	1	2412	14.10	13.60	9.02	8.54	0.50	Pass
11b	1Mbps	1	6	2437	13.85	13.60	8.52	8.52	0.50	Pass
11b	1Mbps	1	11	2462	14.20	13.70	9.02	8.52	0.50	Pass
11g	6Mbps	1	1	2412	16.95	16.95	15.90	15.46	0.50	Pass
11g	6Mbps	1	6	2437	16.75	16.70	15.46	15.44	0.50	Pass
11g	6Mbps	1	11	2462	17.05	16.85	15.52	15.48	0.50	Pass
HT20	MCS0	1	1	2412	17.95	17.95	16.78	15.98	0.50	Pass
HT20	MCS0	1	6	2437	17.95	17.90	15.12	15.92	0.50	Pass
HT20	MCS0	1	11	2462	18.05	17.95	15.98	15.96	0.50	Pass
HT40	MCS0	1	3	2422	36.70	36.50	35.72	35.08	0.50	Pass
HT40	MCS0	1	6	2437	36.30	36.40	35.08	35.08	0.50	Pass
HT40	MCS0	1	9	2452	36.70	36.70	35.68	35.72	0.50	Pass
11b	1Mbps	2	1	2412	14.40	13.70	8.08	8.56	0.50	Pass
11b	1Mbps	2	6	2437	13.95	13.60	8.52	8.52	0.50	Pass
11b	1Mbps	2	11	2462	14.35	13.95	9.04	8.52	0.50	Pass
11g	6Mbps	2	1	2412	17.20	16.90	16.28	15.70	0.50	Pass
11g	6Mbps	2	6	2437	16.95	16.95	15.70	15.72	0.50	Pass
11g	6Mbps	2	11	2462	17.10	16.70	16.28	16.28	0.50	Pass
HT20	MCS0	2	1	2412	18.10	18.00	17.16	16.34	0.50	Pass
HT20	MCS0	2	6	2437	18.10	17.95	15.92	16.08	0.50	Pass
HT20	MCS0	2	11	2462	18.10	17.95	16.52	16.28	0.50	Pass
HT40	MCS0	2	3	2422	36.60	36.40	36.08	35.12	0.50	Pass
HT40	MCS0	2	6	2437	36.40	36.50	35.08	35.48	0.50	Pass
HT40	MCS0	2	9	2452	36.70	36.60	35.72	35.72	0.50	Pass

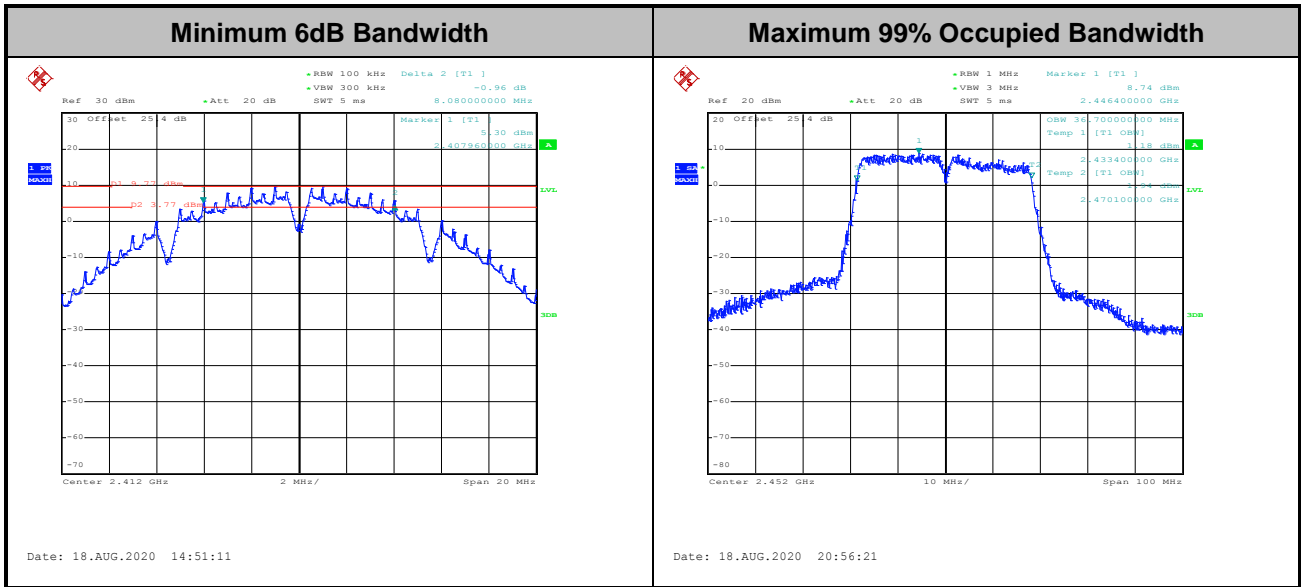

Note: The occupied channel bandwidth is maintained within the band of operation for all of the modulations.

3.2 Output Power Measurement

3.2.1 Limit of Output Power

For systems using digital modulation in the 2400-2483.5MHz, the limit for output power is 30dBm. If transmitting antenna with directional gain greater than 6dBi is used, the peak output power from the intentional radiator shall be reduced below the above stated value by the amount in dB that the directional gain of the antenna exceeds 6 dBi. In case of point-to-point operation, the limit has to be reduced by 1dB for every 3dB that the directional gain of the antenna exceeds 6dBi.

3.2.2 Measuring Instruments

See list of measuring equipment of this test report.

3.2.3 Test Procedures

1. For Peak Power, the testing follows ANSI C63.10 Section 11.9.1.3 PKPM1
2. For Average Power, the testing follows ANSI C63.10 Section 11.9.2.3.1 Method AVGPM
3. The RF output of EUT was connected to the power meter by RF cable and attenuator. The path loss was compensated to the results for each measurement.
4. Set to the maximum power setting and enable the EUT transmit continuously.
5. Measure the conducted output power and record the results in the test report.
6. For MIMO mode, calculation method follows FCC KDB 662911 D01 Multiple Transmitter Output v02r01.

3.2.4 Test Setup

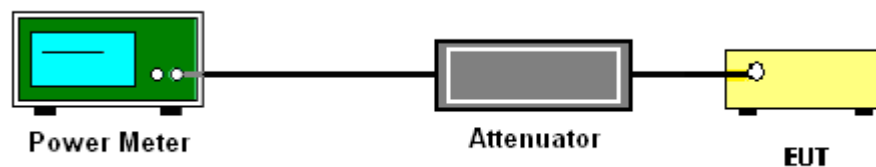



3.2.5 Test Result of Peak Output Power

Test Engineer :	Kathy Chen	Temperature :	23.6~24.5°C
		Relative Humidity :	53.6~54.3%

2.4GHz Band																
Mod.	Data Rate	NTX	CH.	Freq. (MHz)	Peak Conducted Power (dBm)			Conducted Power Limit (dBm)		DG (dBi)		EIRP Power (dBm)		EIRP Power Limit (dBm)		Pass /Fail
					Ant0	Ant1	SUM	Ant0	Ant1	Ant0	Ant1	Ant0	Ant1	Ant0	Ant1	
11b	1Mbps	1	1	2412	20.08	20.34		30.00	30.00	1.50	1.20	21.58	21.54	36.00	36.00	Pass
11b	1Mbps	1	6	2437	20.26	20.35		30.00	30.00	1.50	1.20	21.76	21.55	36.00	36.00	Pass
11b	1Mbps	1	11	2462	20.07	20.19		30.00	30.00	1.50	1.20	21.57	21.39	36.00	36.00	Pass
11g	6Mbps	1	1	2412	20.53	22.21		30.00	30.00	1.50	1.20	22.03	23.41	36.00	36.00	Pass
11g	6Mbps	1	6	2437	22.10	22.42		30.00	30.00	1.50	1.20	23.60	23.62	36.00	36.00	Pass
11g	6Mbps	1	11	2462	21.17	21.92		30.00	30.00	1.50	1.20	22.67	23.12	36.00	36.00	Pass
HT20	MCS0	1	1	2412	18.94	21.54		30.00	30.00	1.50	1.20	20.44	22.74	36.00	36.00	Pass
HT20	MCS0	1	6	2437	22.56	22.43		30.00	30.00	1.50	1.20	24.06	23.63	36.00	36.00	Pass
HT20	MCS0	1	11	2462	20.13	22.00		30.00	30.00	1.50	1.20	21.63	23.20	36.00	36.00	Pass
HT40	MCS0	1	3	2422	17.13	21.62		30.00	30.00	1.50	1.20	18.63	22.82	36.00	36.00	Pass
HT40	MCS0	1	6	2437	22.14	22.85		30.00	30.00	1.50	1.20	23.64	24.05	36.00	36.00	Pass
HT40	MCS0	1	9	2452	20.58	22.37		30.00	30.00	1.50	1.20	22.08	23.57	36.00	36.00	Pass



2.4GHz Band																
Mod.	Data Rate	N _{TX}	CH.	Freq. (MHz)	Peak Conducted Power (dBm)			Conducted Power Limit (dBm)		DG (dBi)		EIRP Power (dBm)		EIRP Power Limit (dBm)		Pass /Fail
					Ant0	Ant1	SUM	Ant0	Ant1	Ant0	Ant1	Ant0	Ant1	Ant0	Ant1	
11b	1Mbps	2	1	2412	19.93	20.29	23.12	30.00		1.50		24.62		36.00	Pass	
11b	1Mbps	2	6	2437	20.32	20.31	23.33	30.00		1.50		24.83		36.00	Pass	
11b	1Mbps	2	11	2462	20.07	20.48	23.29	30.00		1.50		24.79		36.00	Pass	
11g	6Mbps	2	1	2412	20.78	21.29	24.05	30.00		1.50		25.55		36.00	Pass	
11g	6Mbps	2	6	2437	21.94	22.33	25.15	30.00		1.50		26.65		36.00	Pass	
11g	6Mbps	2	11	2462	20.01	20.52	23.28	30.00		1.50		24.78		36.00	Pass	
HT20	MCS0	2	1	2412	18.47	18.44	21.47	30.00		1.50		22.97		36.00	Pass	
HT20	MCS0	2	6	2437	21.98	22.41	25.21	30.00		1.50		26.71		36.00	Pass	
HT20	MCS0	2	11	2462	19.12	19.69	22.42	30.00		1.50		23.92		36.00	Pass	
HT40	MCS0	2	3	2422	17.49	17.45	20.48	30.00		1.50		21.98		36.00	Pass	
HT40	MCS0	2	6	2437	21.74	21.98	24.87	30.00		1.50		26.37		36.00	Pass	
HT40	MCS0	2	9	2452	20.02	20.01	23.03	30.00		1.50		24.53		36.00	Pass	

Note: Measured power (dBm) has offset with cable loss.



3.2.6 Test Result of Average Output Power (Reporting Only)

Test Engineer :	Kathy Chen	Temperature :	23.6~24.5°C
		Relative Humidity :	53.6~54.3%

2.4GHz Band																
Mod.	Data Rate	NTX	CH.	Freq. (MHz)	Average Conducted Power with duty factor (dBm)			Conducted Power Limit (dBm)		DG (dBi)		EIRP Power (dBm)		EIRP Power Limit (dBm)		Pass /Fail
					Ant0	Ant1	SUM	Ant0	Ant1	Ant0	Ant1	Ant0	Ant1	Ant0	Ant1	
11b	1Mbps	1	1	2412	17.88	17.89		30.00	30.00	1.50	1.20	19.38	19.09	36.00	36.00	Pass
11b	1Mbps	1	6	2437	17.93	17.92		30.00	30.00	1.50	1.20	19.43	19.12	36.00	36.00	Pass
11b	1Mbps	1	11	2462	17.86	17.85		30.00	30.00	1.50	1.20	19.36	19.05	36.00	36.00	Pass
11g	6Mbps	1	1	2412	16.19	17.92		30.00	30.00	1.50	1.20	17.69	19.12	36.00	36.00	Pass
11g	6Mbps	1	6	2437	17.73	17.95		30.00	30.00	1.50	1.20	19.23	19.15	36.00	36.00	Pass
11g	6Mbps	1	11	2462	17.06	17.71		30.00	30.00	1.50	1.20	18.56	18.91	36.00	36.00	Pass
HT20	MCS0	1	1	2412	14.20	16.78		30.00	30.00	1.50	1.20	15.70	17.98	36.00	36.00	Pass
HT20	MCS0	1	6	2437	17.97	17.80		30.00	30.00	1.50	1.20	19.47	19.00	36.00	36.00	Pass
HT20	MCS0	1	11	2462	15.53	17.53		30.00	30.00	1.50	1.20	17.03	18.73	36.00	36.00	Pass
HT40	MCS0	1	3	2422	11.35	15.37		30.00	30.00	1.50	1.20	12.85	16.57	36.00	36.00	Pass
HT40	MCS0	1	6	2437	16.92	17.32		30.00	30.00	1.50	1.20	18.42	18.52	36.00	36.00	Pass
HT40	MCS0	1	9	2452	14.42	16.41		30.00	30.00	1.50	1.20	15.92	17.61	36.00	36.00	Pass



2.4GHz Band																
Mod.	Data Rate	NTX	CH.	Freq. (MHz)	Average Conducted Power with duty factor (dBm)			Conducted Power Limit (dBm)		DG (dBi)		EIRP Power (dBm)		EIRP Power Limit (dBm)		Pass /Fail
					Ant0	Ant1	SUM	Ant0	Ant1	Ant0	Ant1	Ant0	Ant1	Ant0	Ant1	
11b	1Mbps	2	1	2412	17.74	17.91	20.84	30.00		1.50		22.34		36.00	Pass	
11b	1Mbps	2	6	2437	17.98	17.96	20.98	30.00		1.50		22.48		36.00	Pass	
11b	1Mbps	2	11	2462	17.88	17.98	20.94	30.00		1.50		22.44		36.00	Pass	
11g	6Mbps	2	1	2412	16.68	16.83	19.77	30.00		1.50		21.27		36.00	Pass	
11g	6Mbps	2	6	2437	17.77	17.93	20.86	30.00		1.50		22.36		36.00	Pass	
11g	6Mbps	2	11	2462	15.62	15.76	18.70	30.00		1.50		20.20		36.00	Pass	
HT20	MCS0	2	1	2412	13.76	13.47	16.63	30.00		1.50		18.13		36.00	Pass	
HT20	MCS0	2	6	2437	17.69	17.84	20.78	30.00		1.50		22.28		36.00	Pass	
HT20	MCS0	2	11	2462	14.49	14.62	17.57	30.00		1.50		19.07		36.00	Pass	
HT40	MCS0	2	3	2422	11.79	11.79	14.80	30.00		1.50		16.30		36.00	Pass	
HT40	MCS0	2	6	2437	16.48	16.09	19.30	30.00		1.50		20.80		36.00	Pass	
HT40	MCS0	2	9	2452	13.88	13.61	16.76	30.00		1.50		18.26		36.00	Pass	

Note: Measured power (dBm) has offset with cable loss.



3.3 Power Spectral Density Measurement

3.3.1 Limit of Power Spectral Density

The peak power spectral density shall not be greater than 8dBm in any 3kHz band at any time interval of continuous transmission.

3.3.2 Measuring Instruments

See list of measuring equipment of this test report.

3.3.3 Test Procedures

1. The testing follows the ANSI C63.10 Section 11.10.2 Method PKPSD.
2. The RF output of EUT was connected to the spectrum analyzer by RF cable and attenuator. The path loss was compensated to the results for each measurement.
3. Set to the maximum power setting and enable the EUT transmit continuously.
4. Make the measurement with the spectrum analyzer's resolution bandwidth (RBW) = 3 kHz. Video bandwidth VBW = 10 kHz In order to make an accurate measurement, set the span to 1.5 times DTS Channel Bandwidth. (6dB BW)
5. Detector = peak, Sweep time = auto couple, Trace mode = max hold, Allow trace to fully stabilize. Use the peak marker function to determine the maximum power level.
6. Measure and record the results in the test report.
7. For MIMO mode, calculation method follows FCC KDB 662911 D01 Multiple Transmitter Output v02r01.

If measurements performed using method (2) plus $10 \log(N)$ exceeds the emission limit, the test should choose method (1) before declaring that the device fails the emission limit.

Method (1): Measure and sum the spectra across the outputs.

The total final Power Spectral Density is from a device with 2 transmitter outputs. The spectrum measurements of the individual outputs are all performed with the same span and number of points, the spectrum value in the first spectral bin of output 1 is summed with that in the first spectral bin of output 2 to obtain the value for the first frequency bin of the summed spectrum.

Method (2): Measure and add $10 \log(N)$ dB, where N is the number of outputs. (N=2)

3.3.4 Test Setup

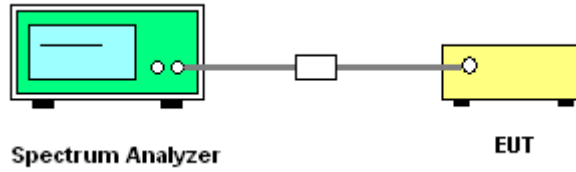

3.3.5 Test Result of Power Spectral Density

Test Engineer :	Kathy Chen	Temperature :	23.6~24.5°C
		Relative Humidity :	53.6~54.3%

2.4GHz Band												
Mod.	Data Rate	NTX	CH.	Freq. (MHz)	Peak PSD (dBm/3kHz)			DG (dBi)		Peak PSD Limit (dBm/3kHz)		Pass/Fail
					Ant0	Ant1	Worse + 3.01	Ant0	Ant1	Ant0	Ant1	
11b	1Mbps	1	1	2412	-4.14	-4.10		1.50	1.20	8.00	8.00	Pass
11b	1Mbps	1	6	2437	-4.02	-4.17		1.50	1.20	8.00	8.00	Pass
11b	1Mbps	1	11	2462	-4.10	-4.16		1.50	1.20	8.00	8.00	Pass
11g	6Mbps	1	1	2412	-11.53	-10.05		1.50	1.20	8.00	8.00	Pass
11g	6Mbps	1	6	2437	-10.19	-10.09		1.50	1.20	8.00	8.00	Pass
11g	6Mbps	1	11	2462	-10.89	-10.14		1.50	1.20	8.00	8.00	Pass
HT20	MCS0	1	1	2412	-13.53	-11.17		1.50	1.20	8.00	8.00	Pass
HT20	MCS0	1	6	2437	-10.06	-9.84		1.50	1.20	8.00	8.00	Pass
HT20	MCS0	1	11	2462	-12.43	-10.02		1.50	1.20	8.00	8.00	Pass
HT40	MCS0	1	3	2422	-17.72	-13.50		1.50	1.20	8.00	8.00	Pass
HT40	MCS0	1	6	2437	-12.18	-11.70		1.50	1.20	8.00	8.00	Pass
HT40	MCS0	1	9	2452	-14.73	-12.72		1.50	1.20	8.00	8.00	Pass



2.4GHz Band												
Mod.	Data Rate	NTX	CH.	Freq. (MHz)	Peak PSD (dBm/3kHz)			DG (dBi)		Peak PSD Limit (dBm/3kHz)		Pass/Fail
					Ant0	Ant1	Worse + 3.01	Ant0	Ant1	Ant0	Ant1	
11b	1Mbps	2	1	2412	-4.21	-3.92	-0.91	4.36		8.00		Pass
11b	1Mbps	2	6	2437	-4.10	-4.08	-1.07	4.36		8.00		Pass
11b	1Mbps	2	11	2462	-4.27	-4.07	-1.06	4.36		8.00		Pass
11g	6Mbps	2	1	2412	-7.93	-7.81	-4.80	4.36		8.00		Pass
11g	6Mbps	2	6	2437	-6.83	-6.91	-3.82	4.36		8.00		Pass
11g	6Mbps	2	11	2462	-9.00	-9.00	-5.99	4.36		8.00		Pass
HT20	MCS0	2	1	2412	-11.25	-11.42	-8.24	4.36		8.00		Pass
HT20	MCS0	2	6	2437	-7.25	-7.41	-4.24	4.36		8.00		Pass
HT20	MCS0	2	11	2462	-10.36	-10.05	-7.04	4.36		8.00		Pass
HT40	MCS0	2	3	2422	-15.88	-15.80	-12.79	4.36		8.00		Pass
HT40	MCS0	2	6	2437	-10.93	-11.43	-7.92	4.36		8.00		Pass
HT40	MCS0	2	9	2452	-13.87	-14.17	-10.86	4.36		8.00		Pass

Note: Measured power density (dBm) has offset with cable loss.



Worst Case Power Density (dBm/3kHz) for MIMO Ant. 0

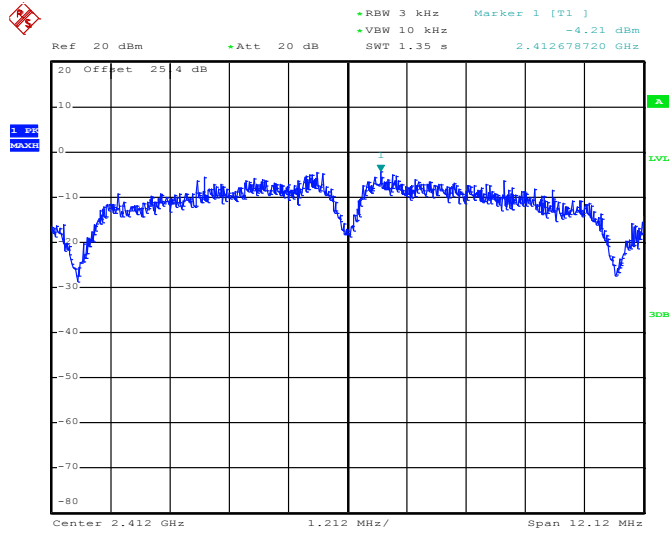

Date: 18.AUG.2020 14:53:41

Worst Case Power Density (dBm/3kHz) for MIMO Ant. 1

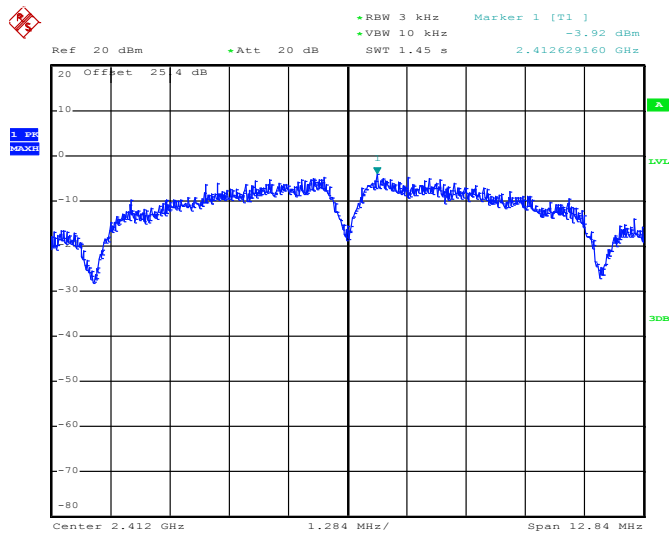

Date: 18.AUG.2020 15:11:03

3.4 Conducted Band Edges and Spurious Emission Measurement

3.4.1 Limit of Conducted Band Edges and Spurious Emission Measurement

In any 100 kHz bandwidth outside of the authorized frequency band, the emissions which fall in the non-restricted bands shall be attenuated at least 20 dB / 30dB relative to the maximum PSD level in 100 kHz by RF conducted measurement.

3.4.2 Measuring Instruments

See list of measuring equipment of this test report.

3.4.3 Test Procedures

1. The testing follows the ANSI C63.10 Section 11.11.3 Emission level measurement.
2. The RF output of EUT was connected to the spectrum analyzer by RF cable and attenuator. The path loss was compensated to the results for each measurement.
3. Set to the maximum power setting and enable the EUT transmit continuously.
4. Set RBW = 100 kHz, VBW=300 kHz, Peak Detector. Unwanted Emissions measured in any 100 kHz bandwidth outside of the authorized frequency band shall be attenuated by at least 20 dB relative to the maximum in-band peak PSD level in 100 kHz when maximum peak conducted output power procedure is used. If the transmitter complies with the conducted power limits based on the use of RMS averaging over a time interval, the attenuation required under this paragraph shall be 30 dB instead of 20 dB per 15.247(d).
5. Measure and record the results in the test report.
6. The RF fundamental frequency should be excluded against the limit line in the operating frequency band.

3.4.4 Test Setup

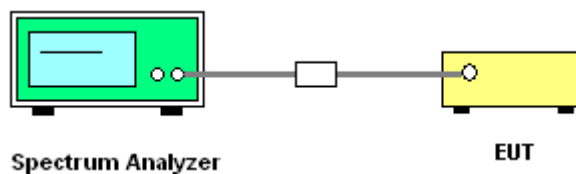



3.4.5 Test Result of Conducted Band Edges and Spurious Emission

Test Engineer :	Kathy Chen	Temperature :	23.6~24.5°C
		Relative Humidity :	53.6~54.3%

Number of TX = 1, Ant. 0 (Measured)

Test Mode :	802.11b	Test Channel :	01
-------------	---------	----------------	----

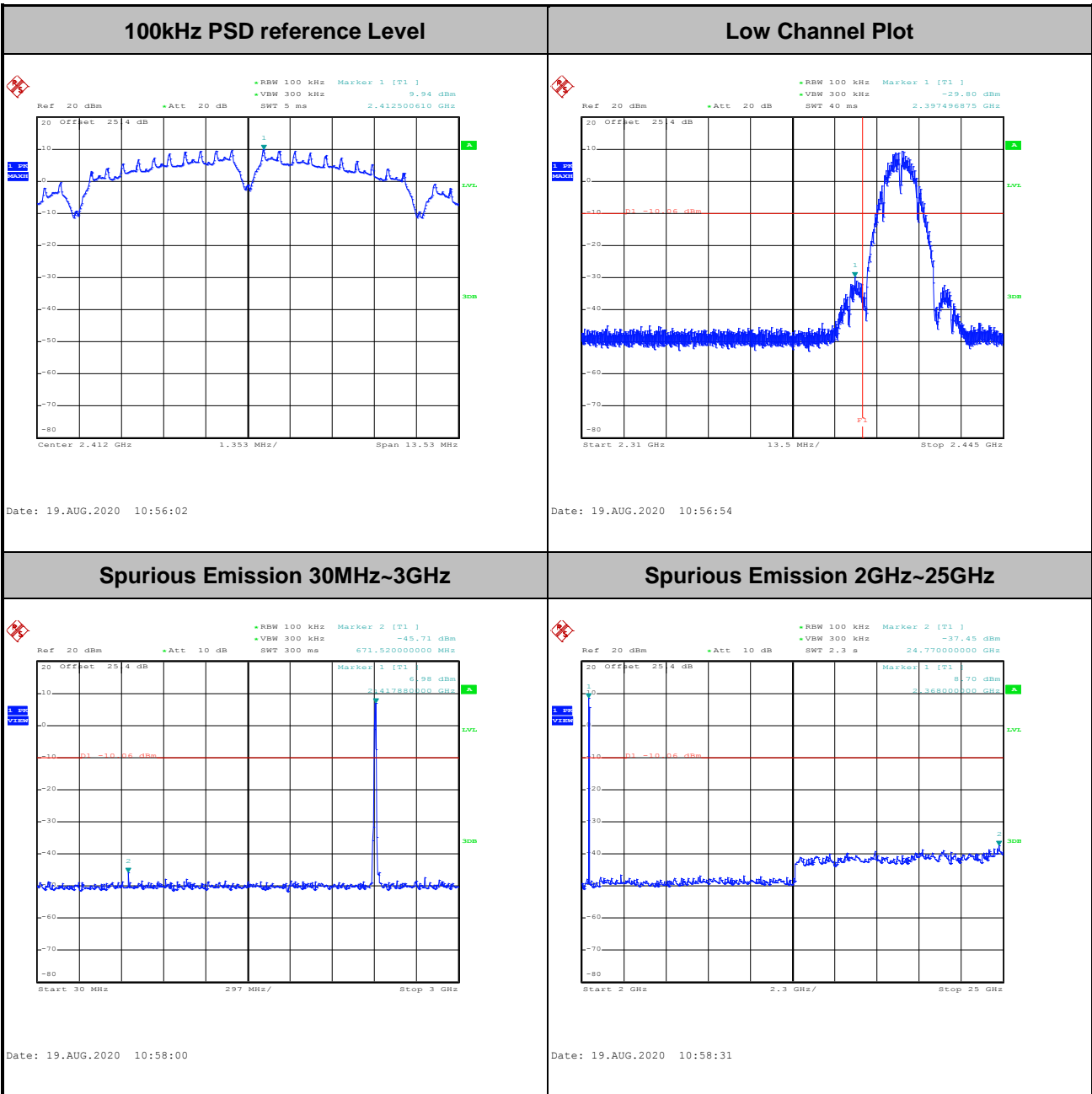



Test Mode :	802.11b	Test Channel :	06
-------------	---------	----------------	----

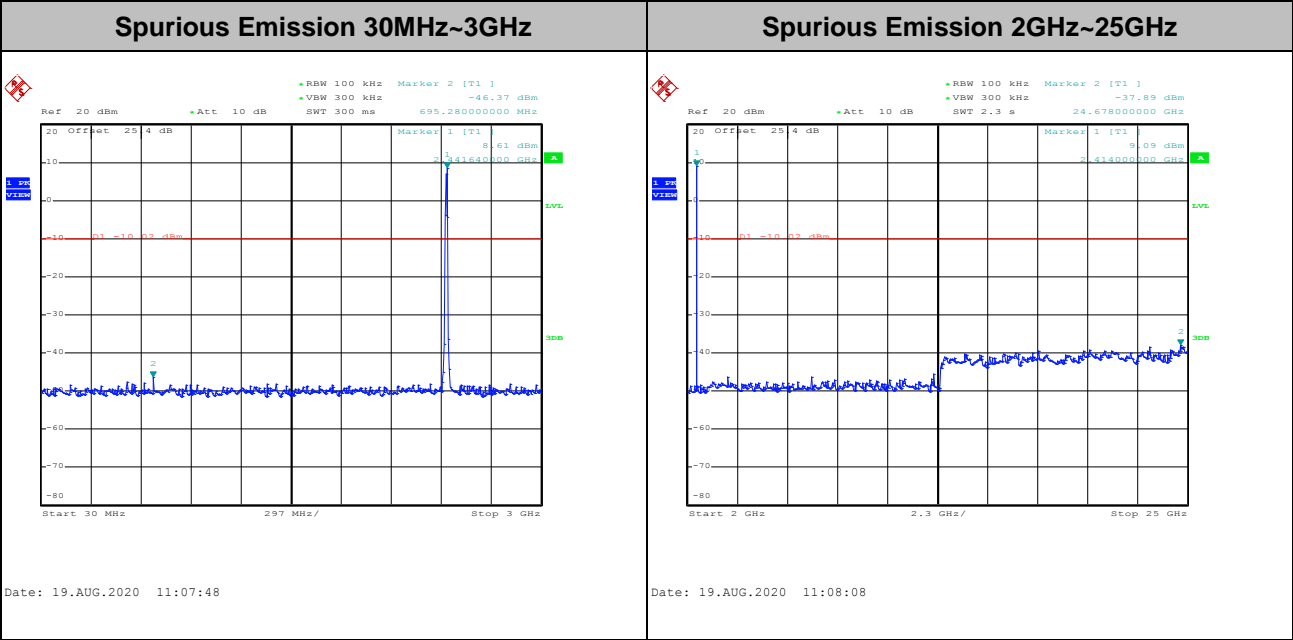
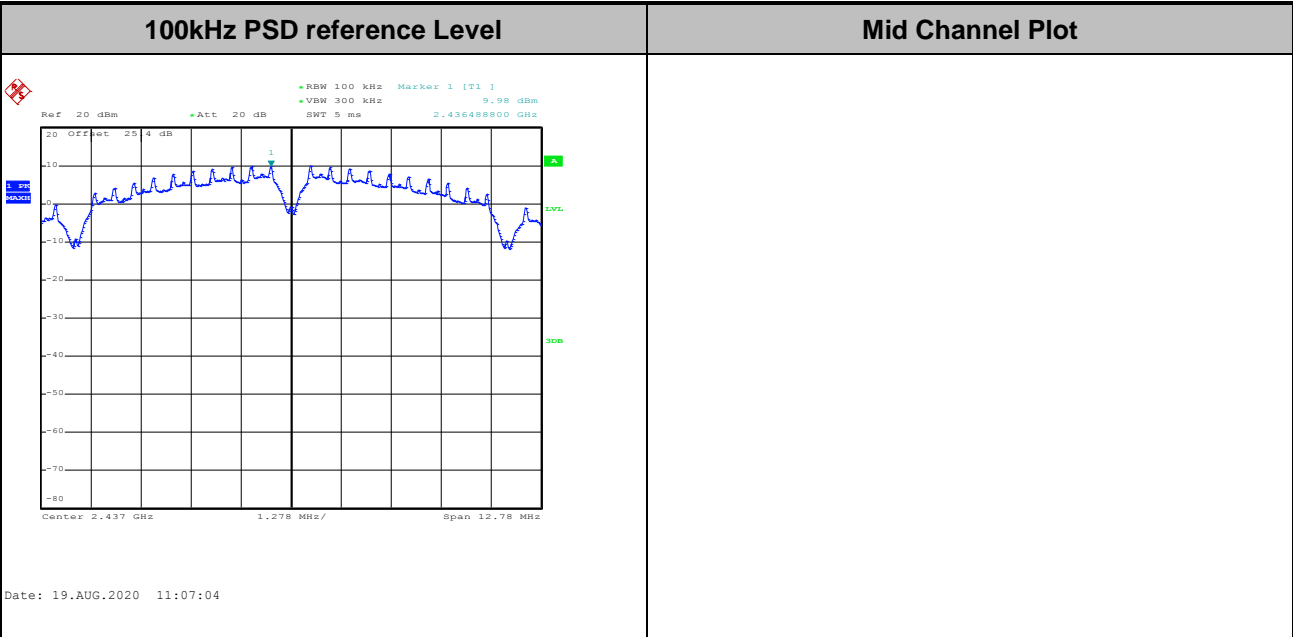



Test Mode :	802.11b	Test Channel :	11
-------------	---------	----------------	----

100kHz PSD reference Level	High Channel Plot
-----------------------------------	--------------------------

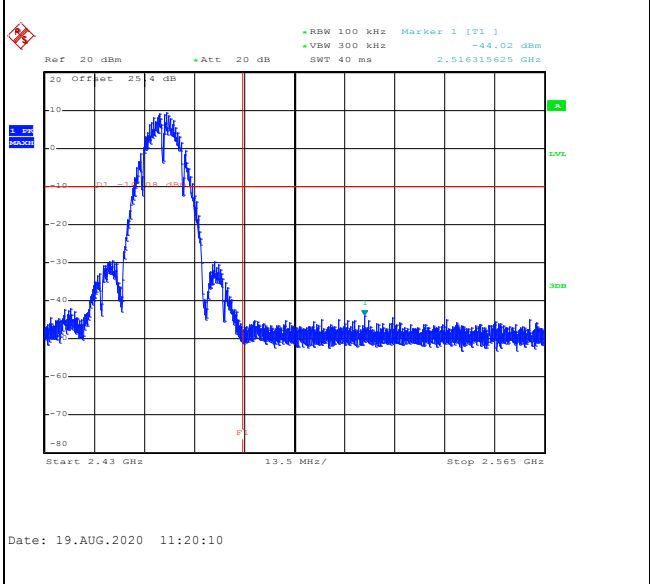
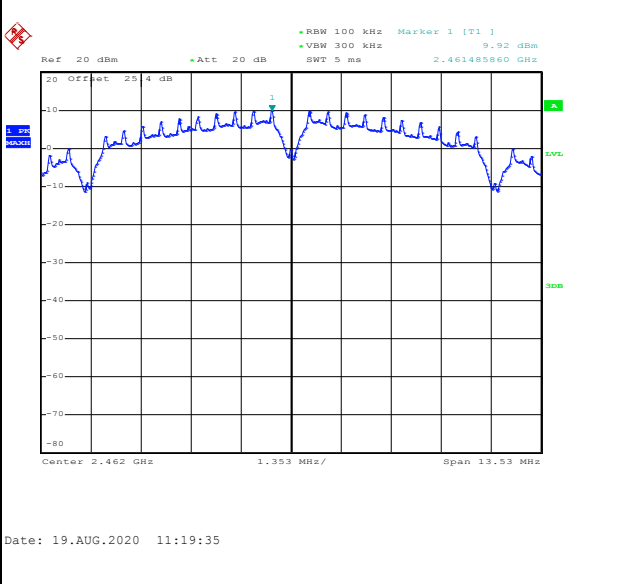

Spurious Emission 30MHz~3GHz	Spurious Emission 2GHz~25GHz
-------------------------------------	-------------------------------------

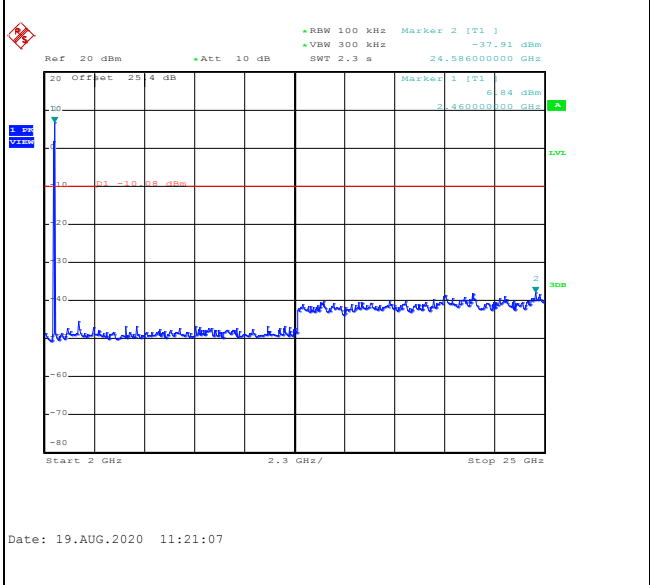
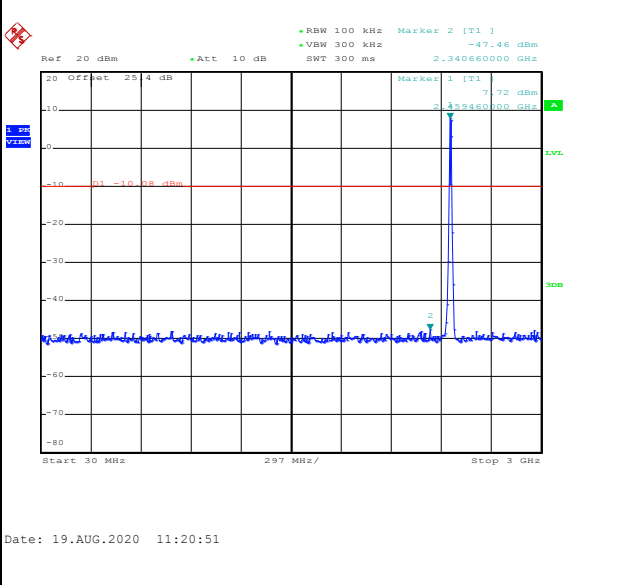



Test Mode :	802.11g	Test Channel :	01
-------------	---------	----------------	----

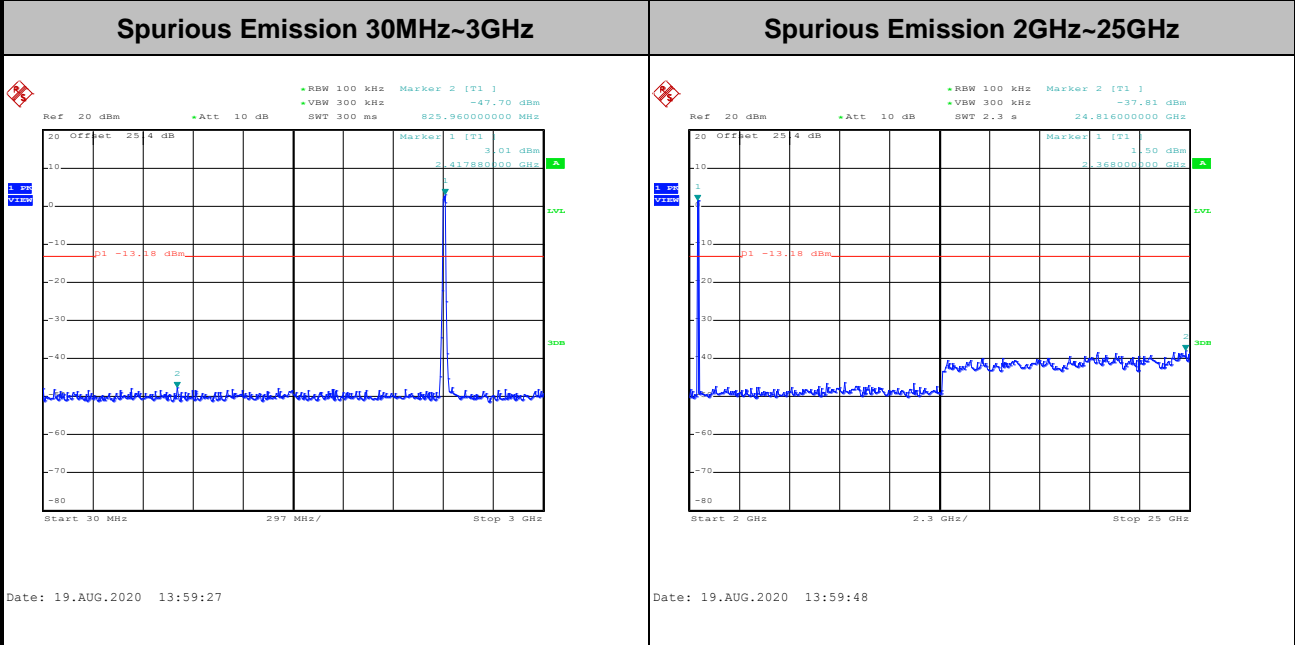
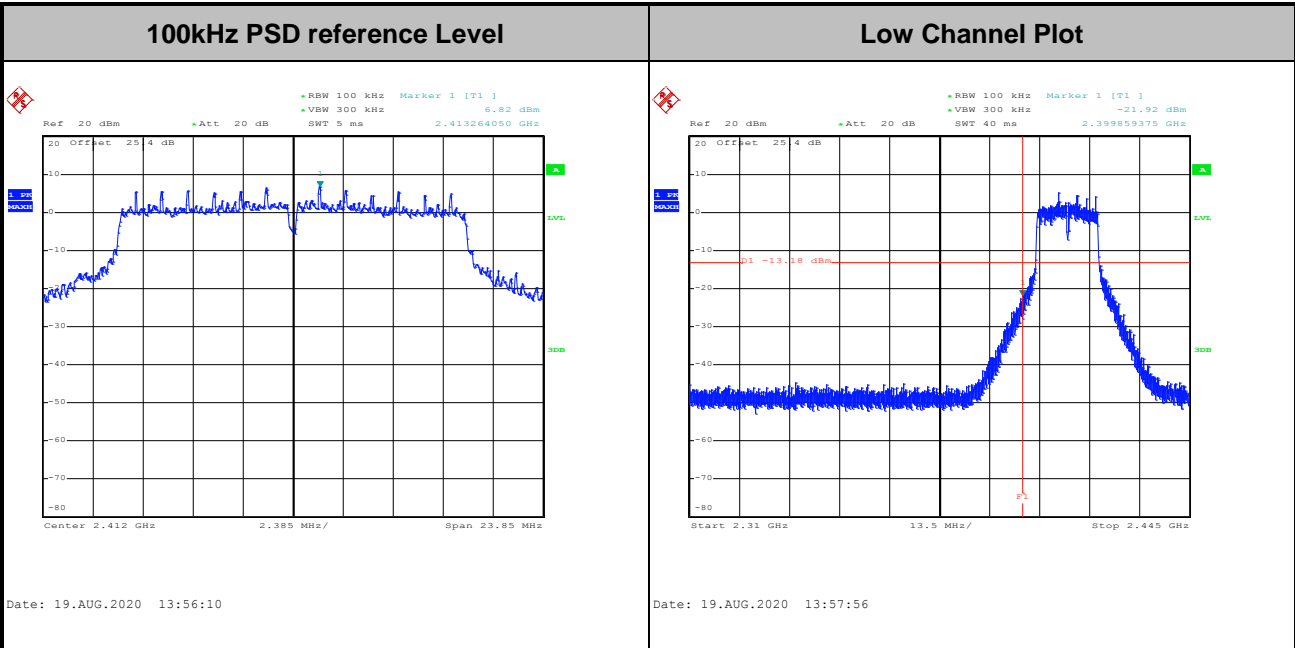



Test Mode :	802.11g	Test Channel :	06
-------------	---------	----------------	----

100kHz PSD reference Level	Mid Channel Plot
-----------------------------------	-------------------------

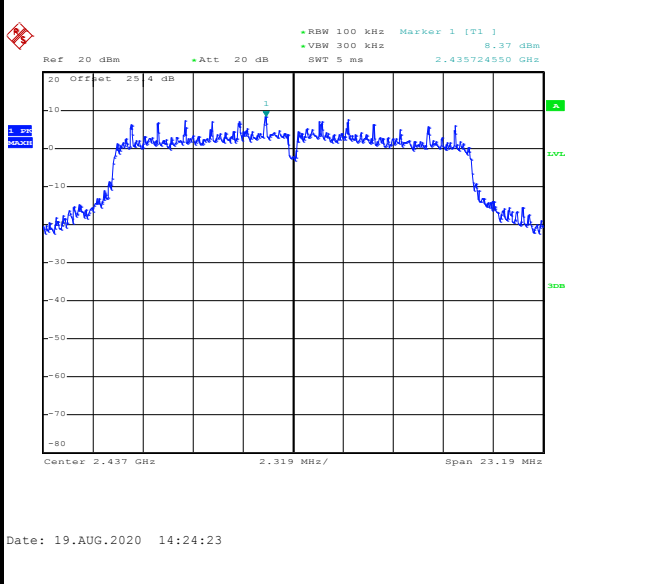

Spurious Emission 30MHz~3GHz	Spurious Emission 2GHz~25GHz
-------------------------------------	-------------------------------------

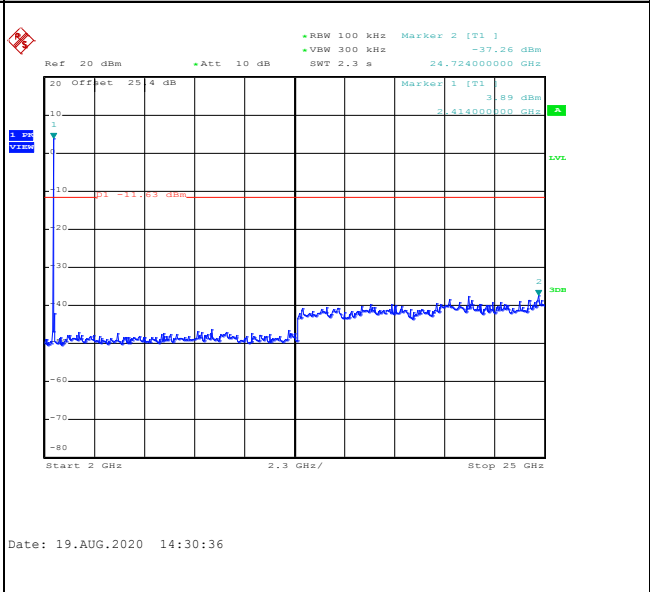
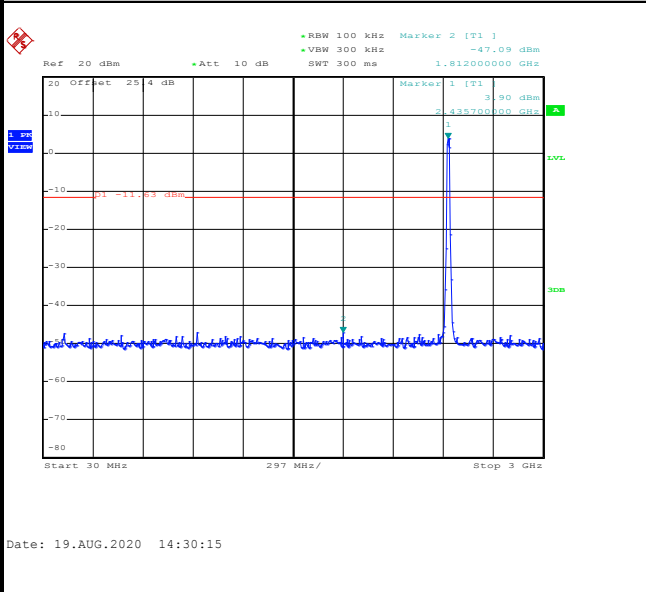



Test Mode :	802.11g	Test Channel :	11
-------------	---------	----------------	----

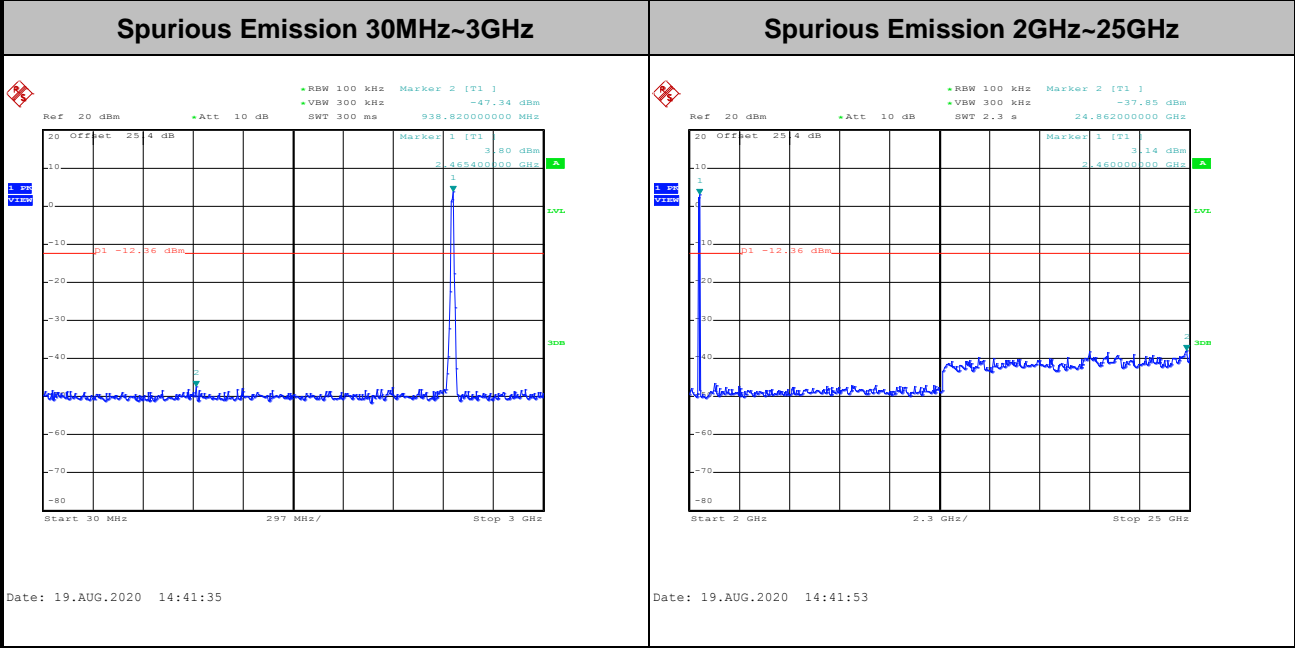
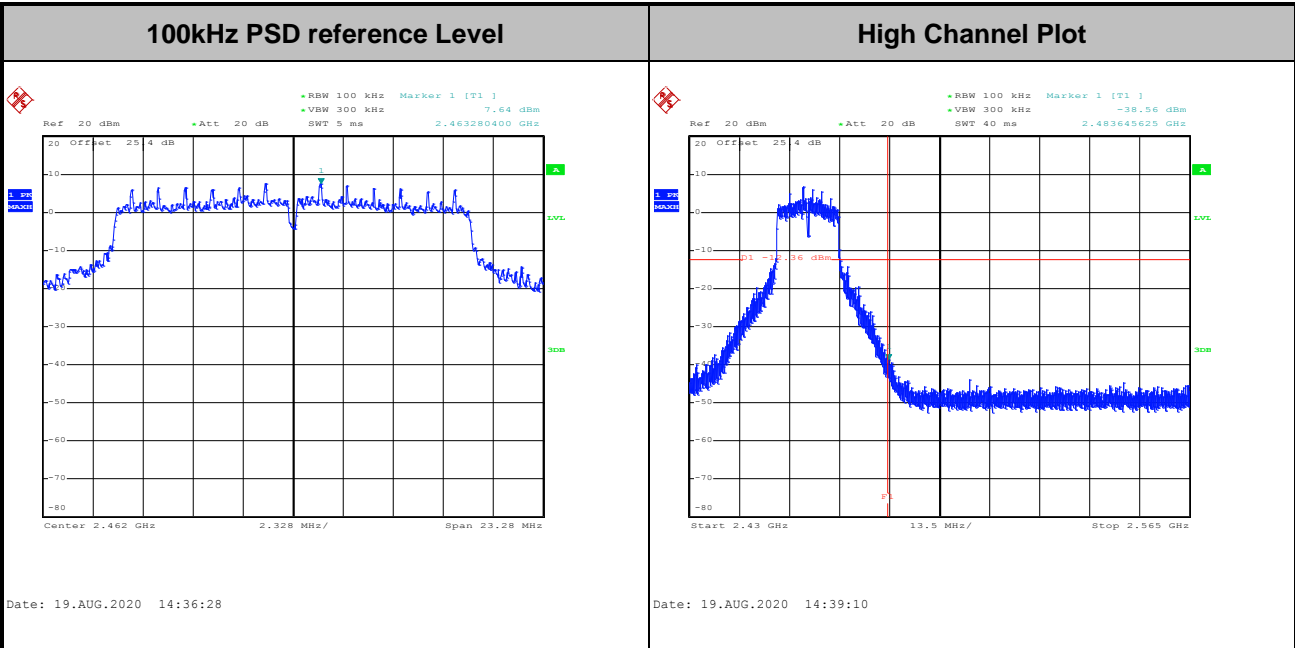



Test Mode :	802.11n HT20	Test Channel :	01
-------------	--------------	----------------	----

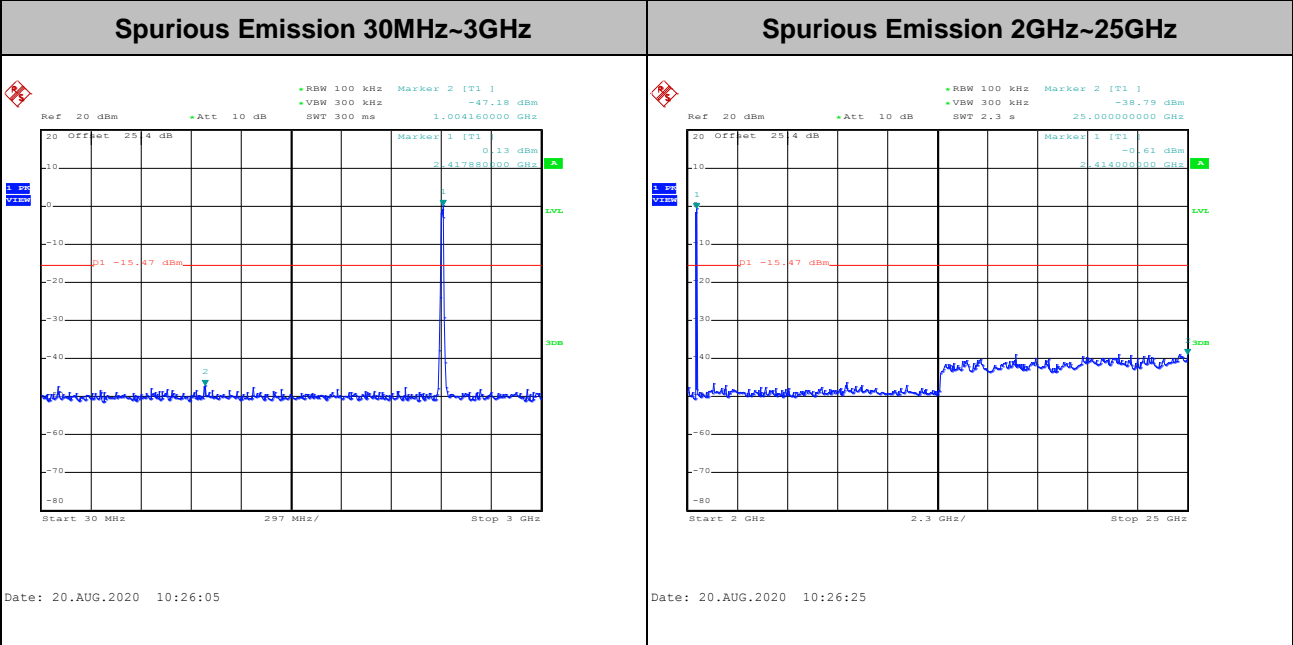
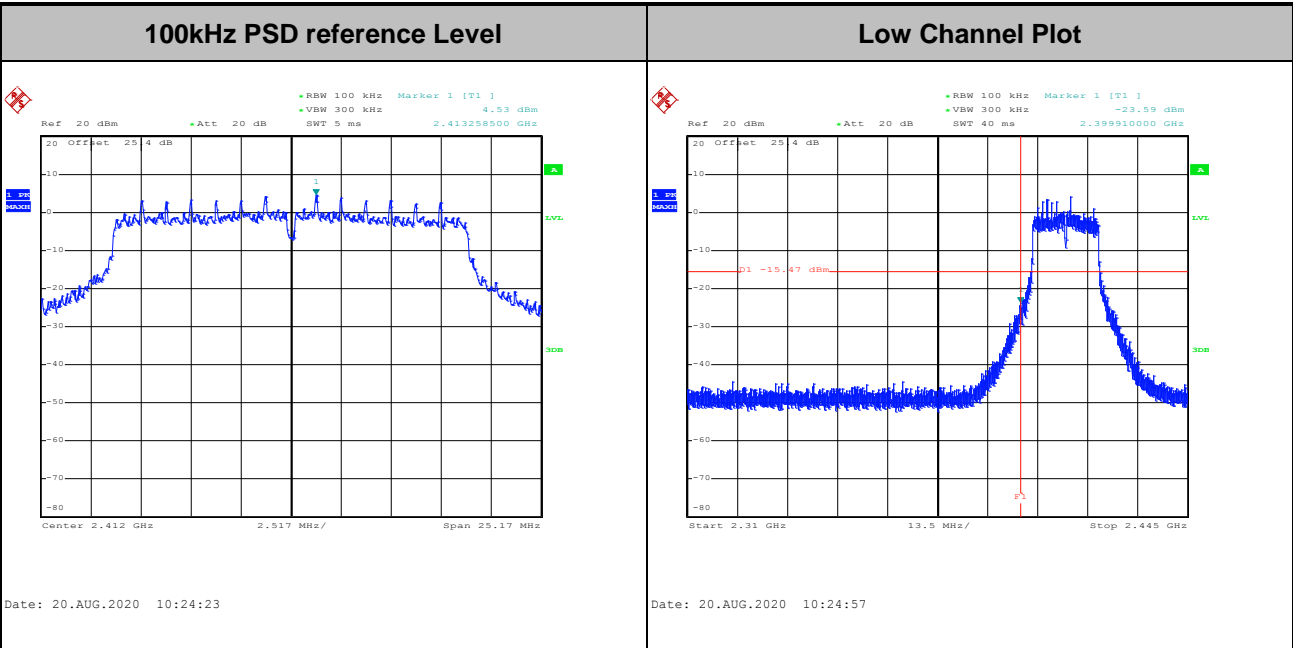



Test Mode :	802.11n HT20	Test Channel :	06
--------------------	--------------	-----------------------	----

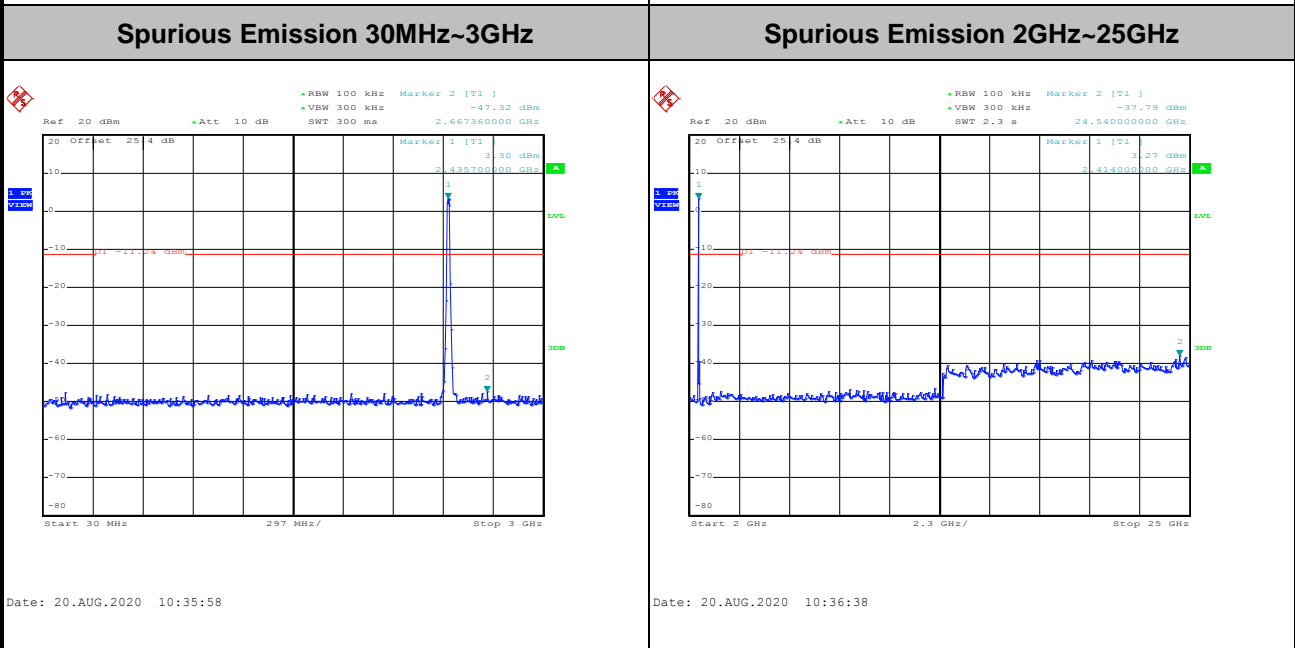
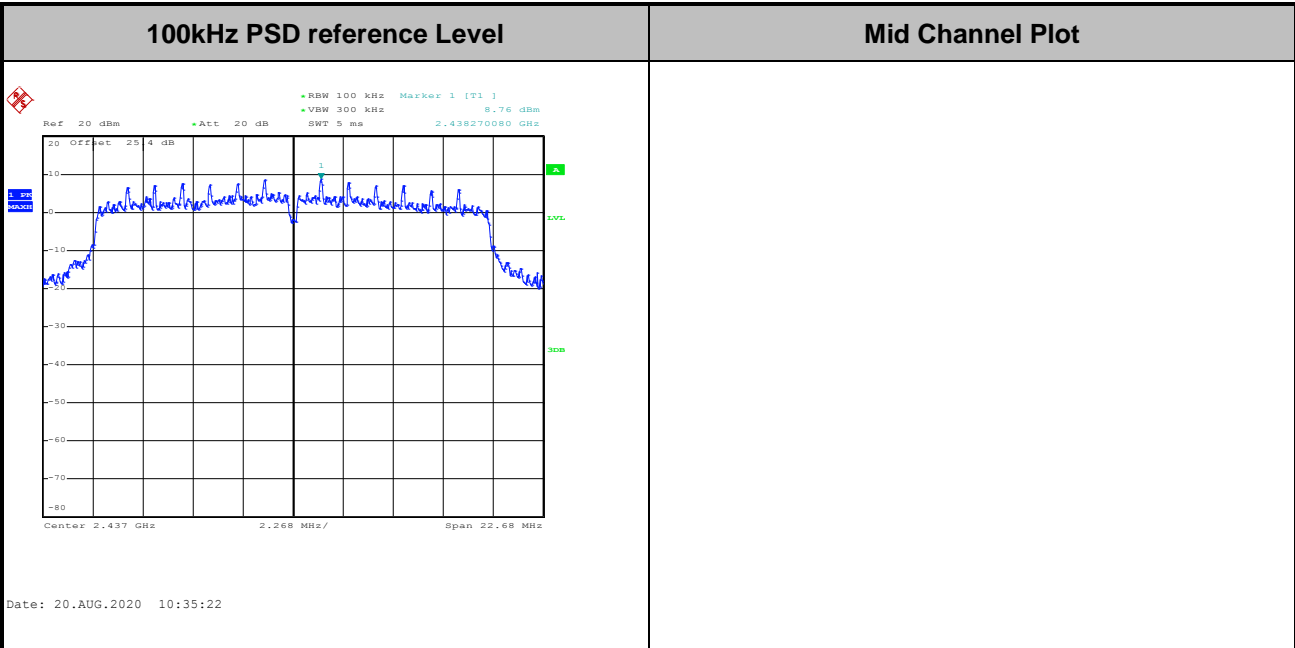



Test Mode :	802.11n HT20	Test Channel :	11
-------------	--------------	----------------	----

100kHz PSD reference Level	High Channel Plot
-----------------------------------	--------------------------

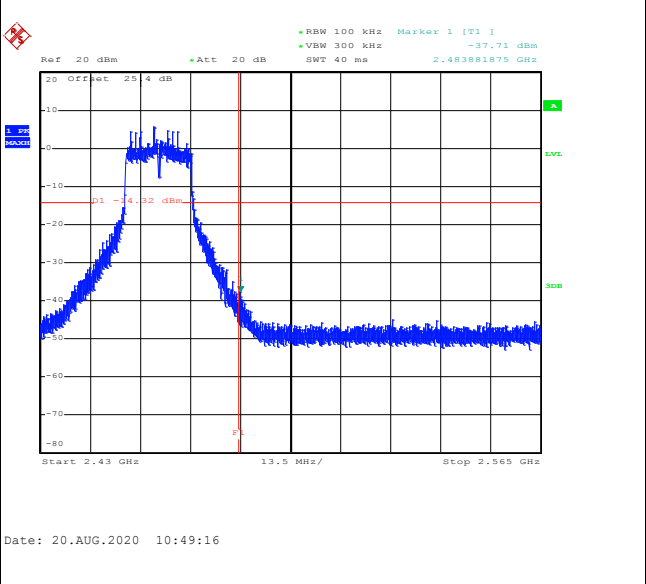
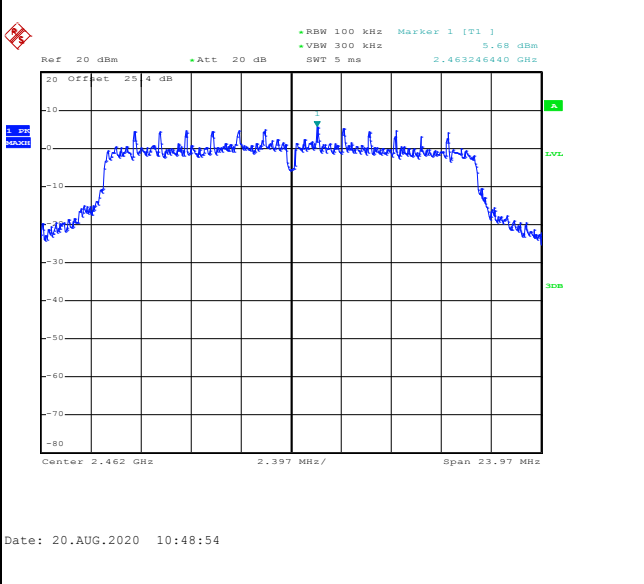

Spurious Emission 30MHz~3GHz	Spurious Emission 2GHz~25GHz
-------------------------------------	-------------------------------------

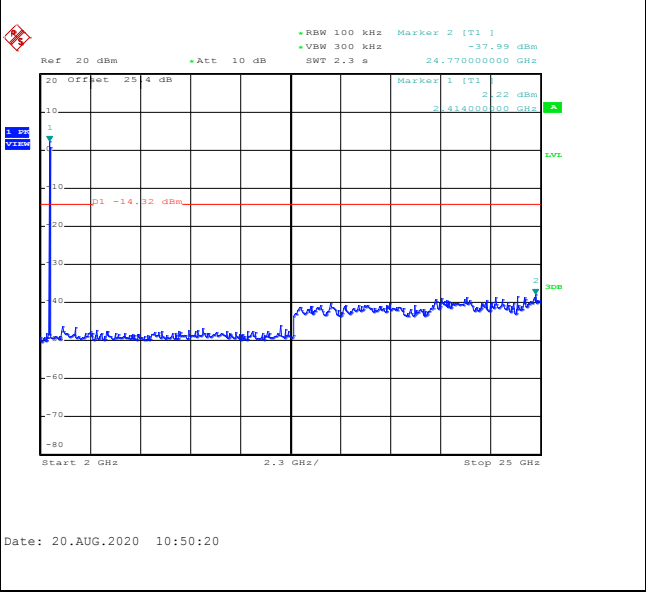
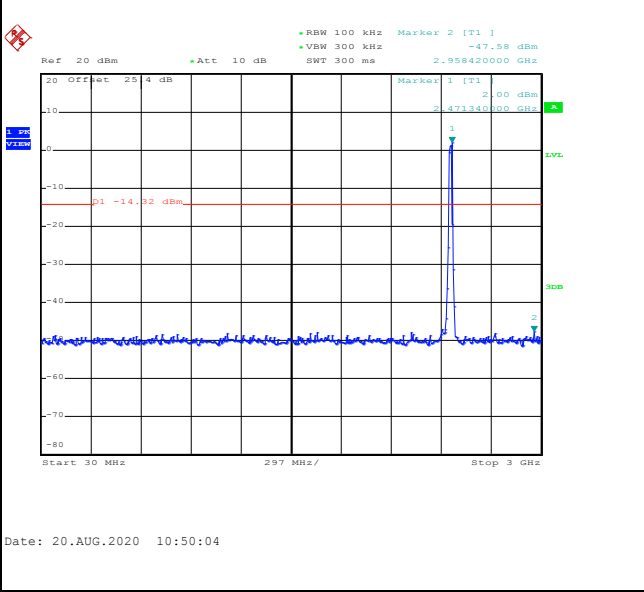



Test Mode :	802.11n HT40	Test Channel :	03
-------------	--------------	----------------	----

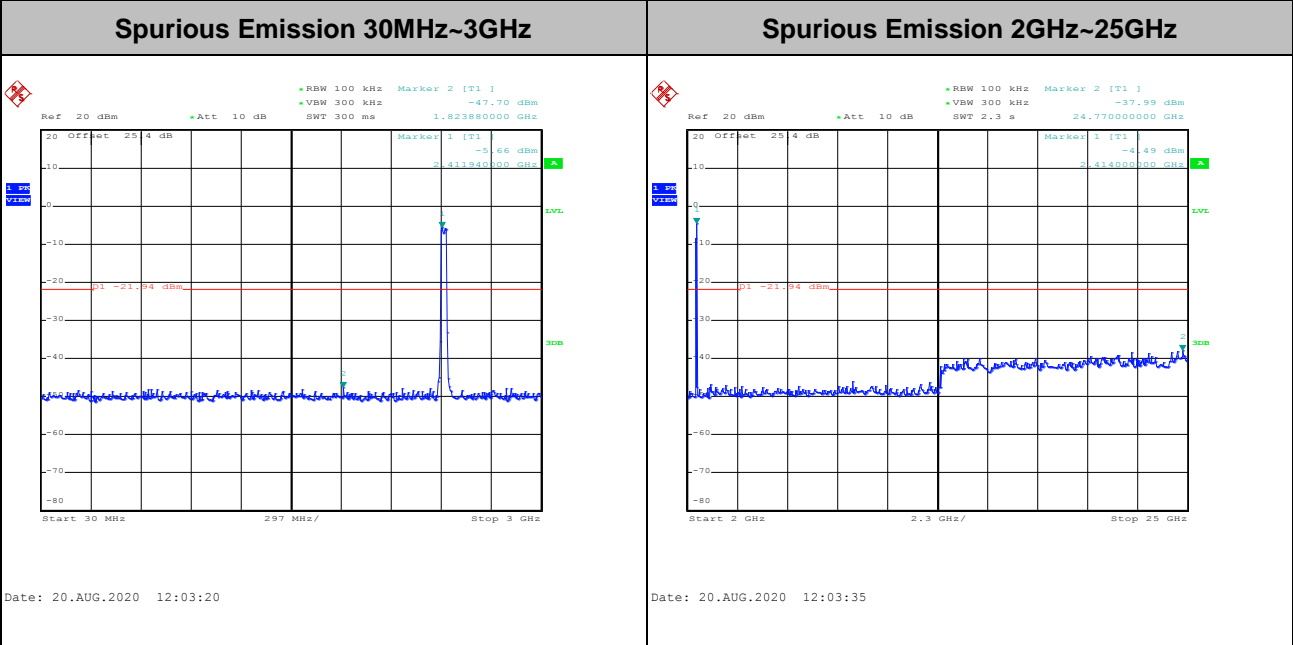
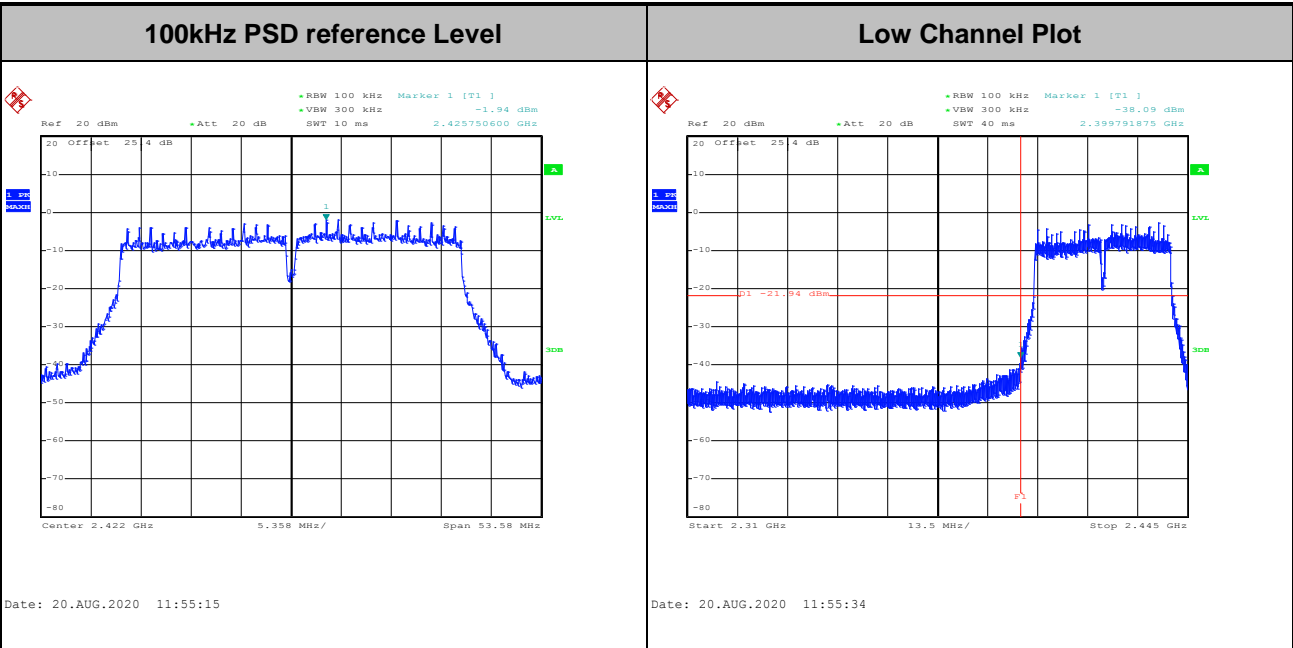



Test Mode :	802.11n HT40	Test Channel :	06
-------------	--------------	----------------	----

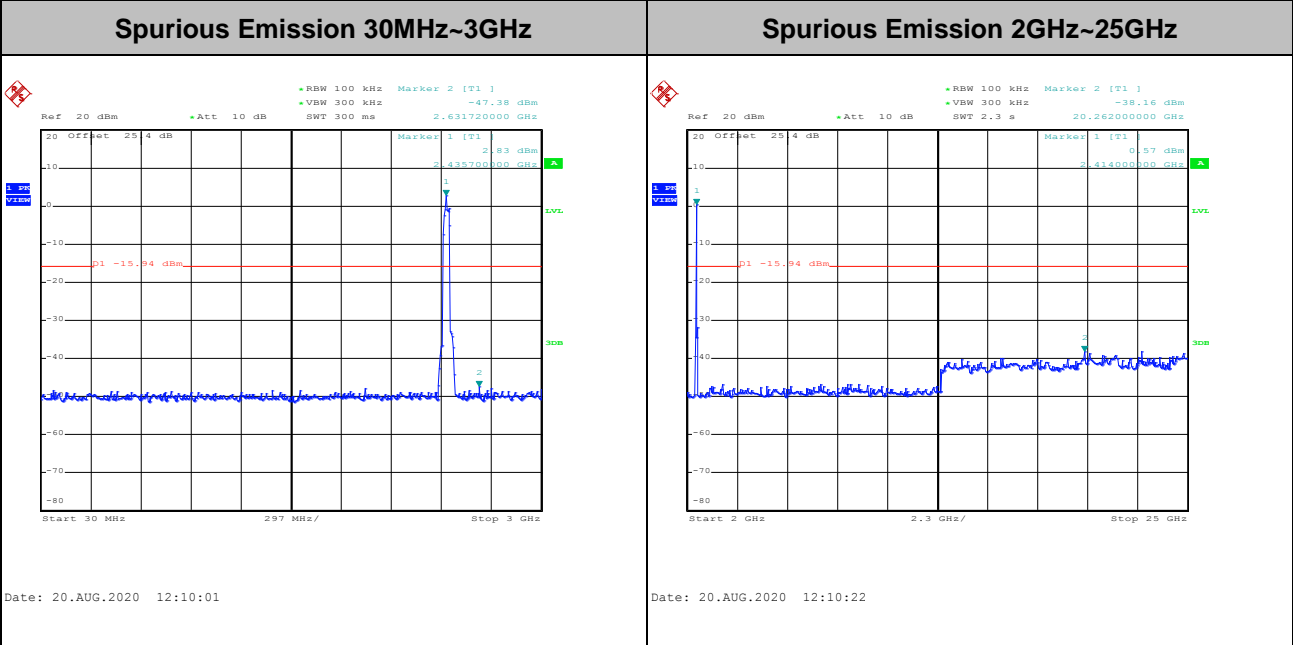
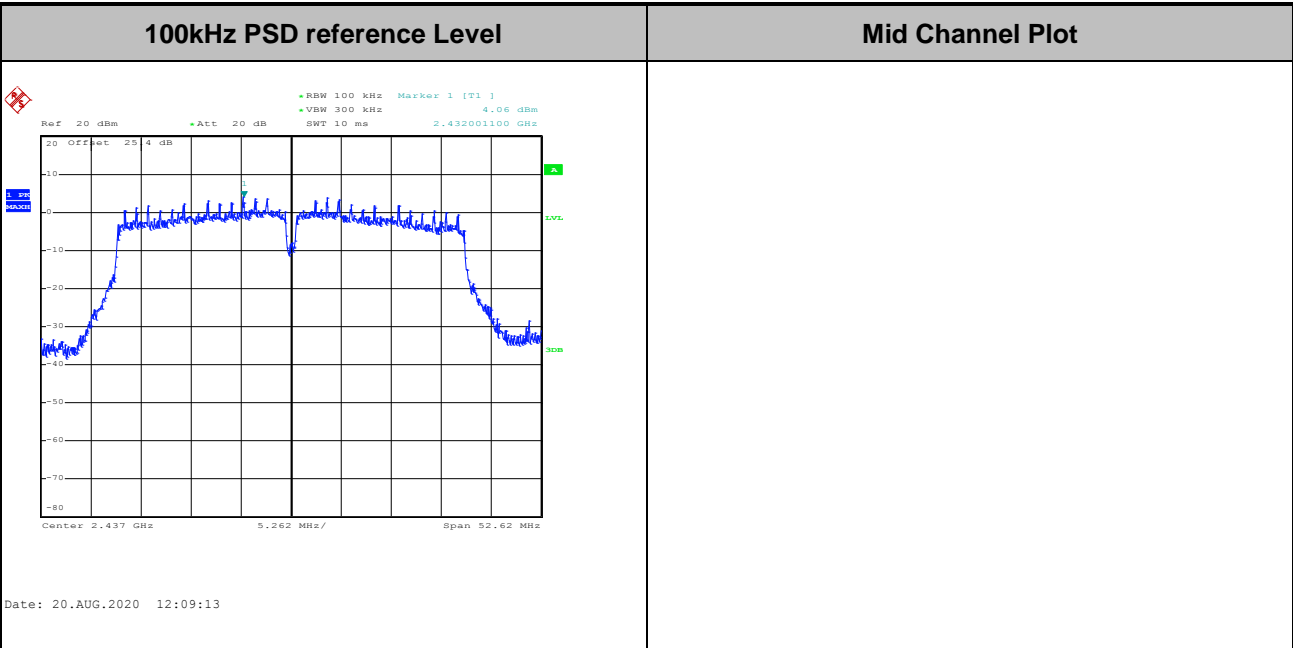



Test Mode :	802.11n HT40	Test Channel :	09
-------------	--------------	----------------	----

100kHz PSD reference Level	High Channel Plot
-----------------------------------	--------------------------

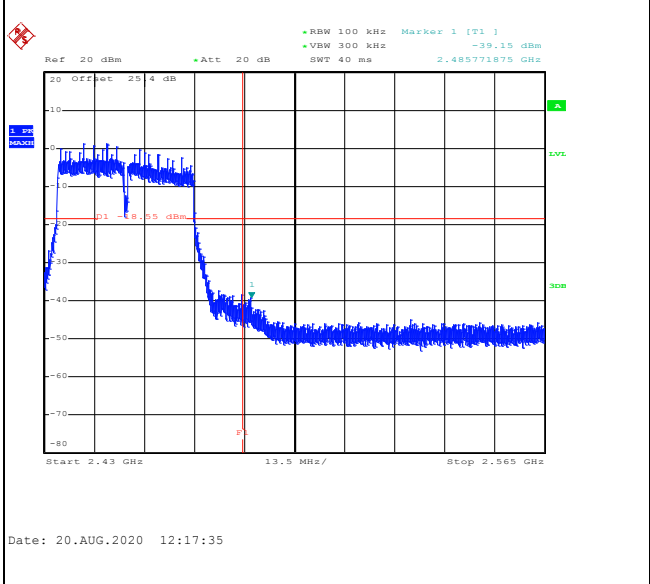
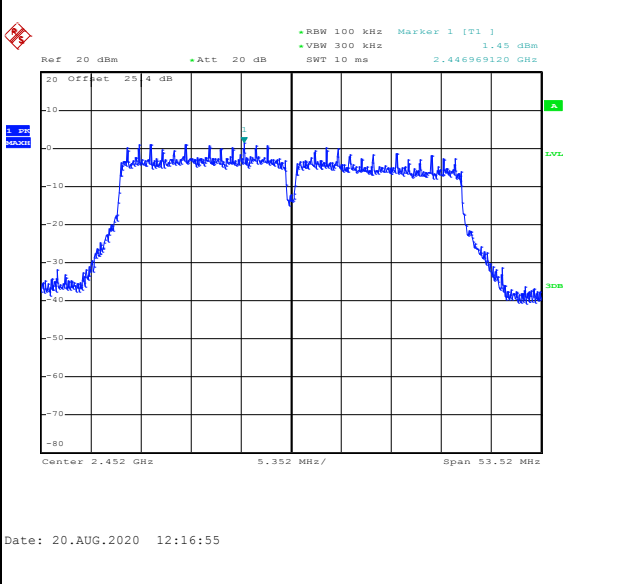

Spurious Emission 30MHz~3GHz	Spurious Emission 2GHz~25GHz
-------------------------------------	-------------------------------------

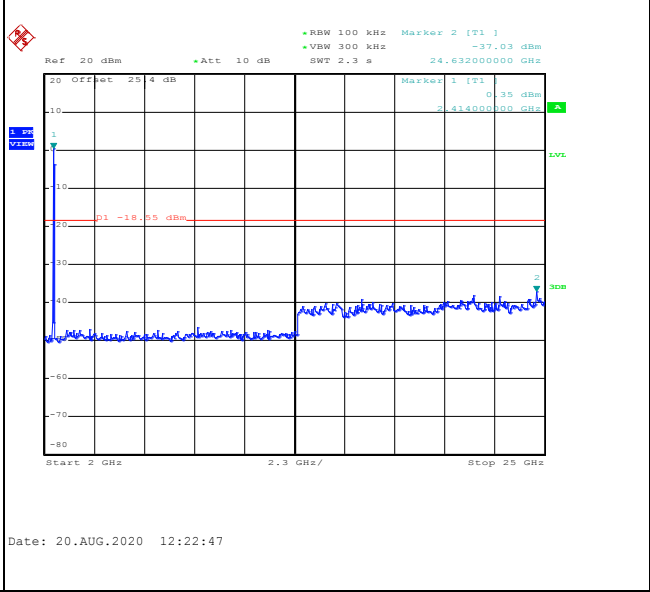
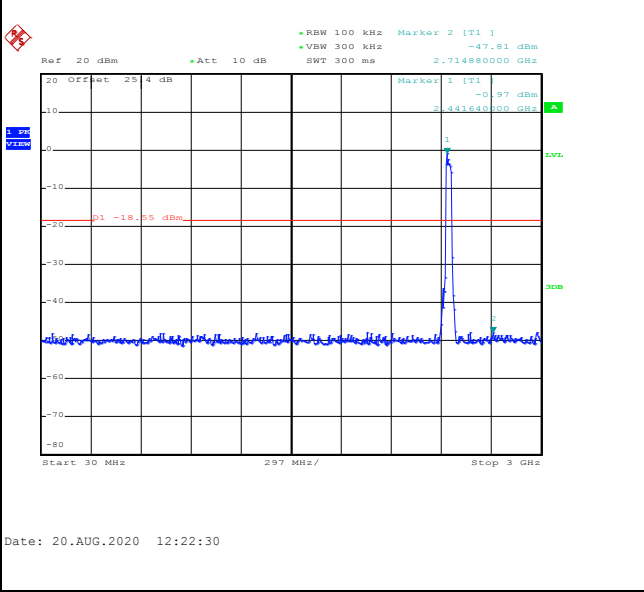



Number of TX = 1, Ant. 1 (Measured)

Test Mode :	802.11b	Test Channel :	01
-------------	---------	----------------	----

100kHz PSD reference Level	Low Channel Plot
-----------------------------------	-------------------------

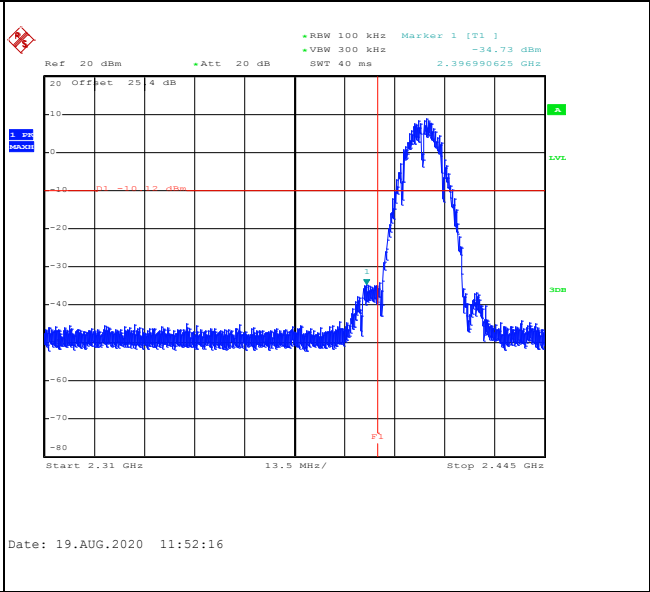
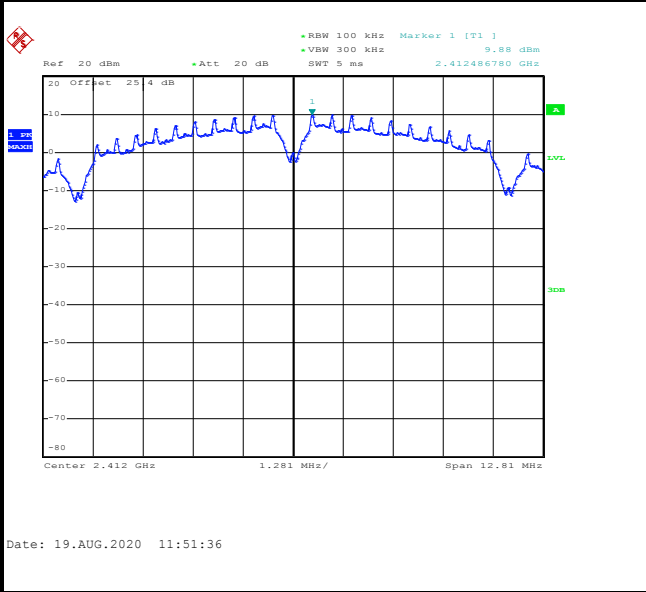

Spurious Emission 30MHz~3GHz	Spurious Emission 2GHz~25GHz
-------------------------------------	-------------------------------------

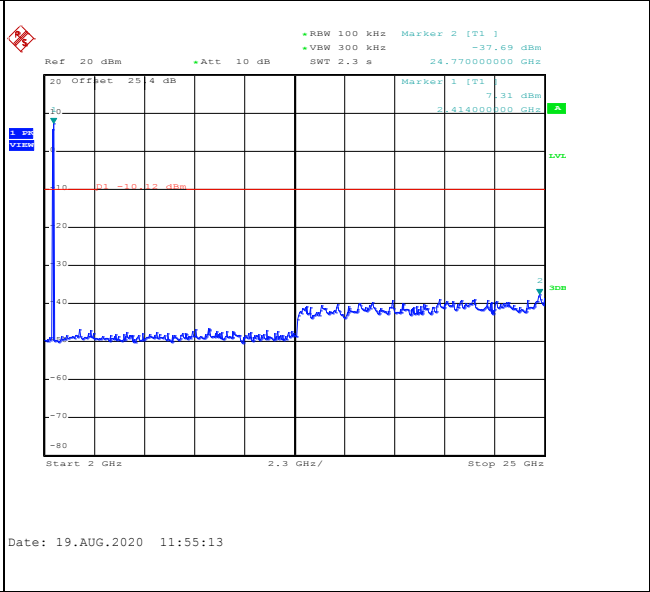
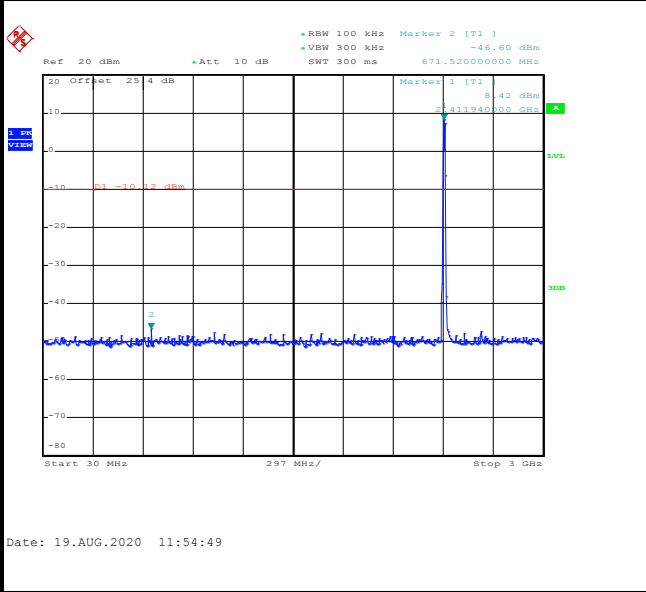



Test Mode :	802.11b	Test Channel :	06
-------------	---------	----------------	----

100kHz PSD reference Level	Mid Channel Plot
-----------------------------------	-------------------------

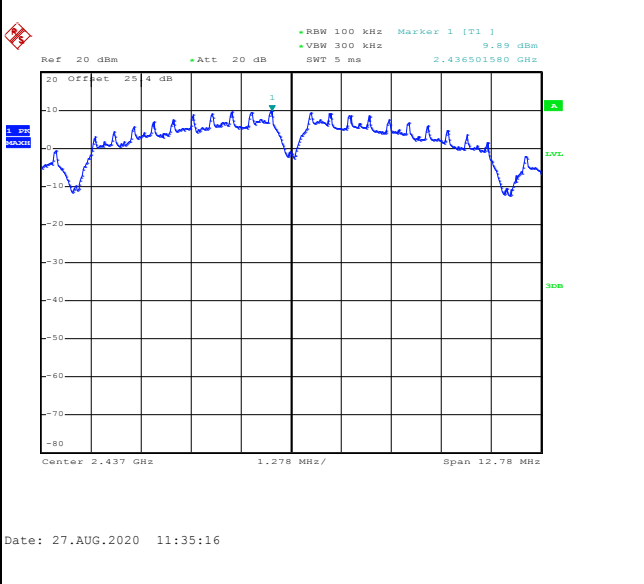

Spurious Emission 30MHz~3GHz	Spurious Emission 2GHz~25GHz
-------------------------------------	-------------------------------------

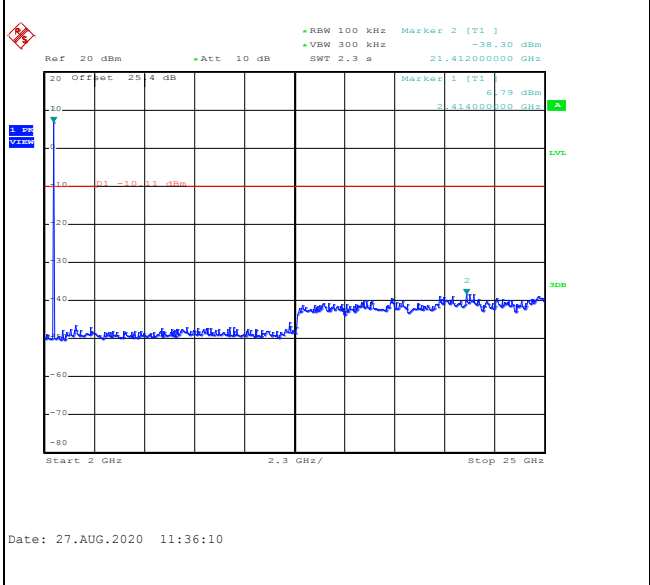
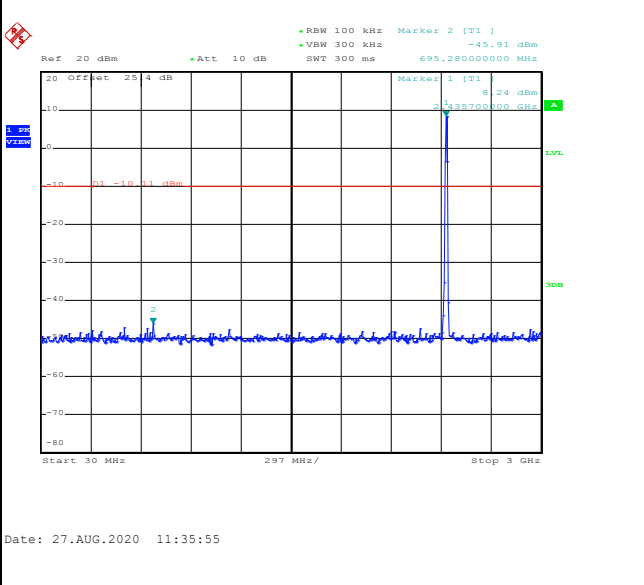



Test Mode :	802.11b	Test Channel :	11
-------------	---------	----------------	----

100kHz PSD reference Level	High Channel Plot
-----------------------------------	--------------------------

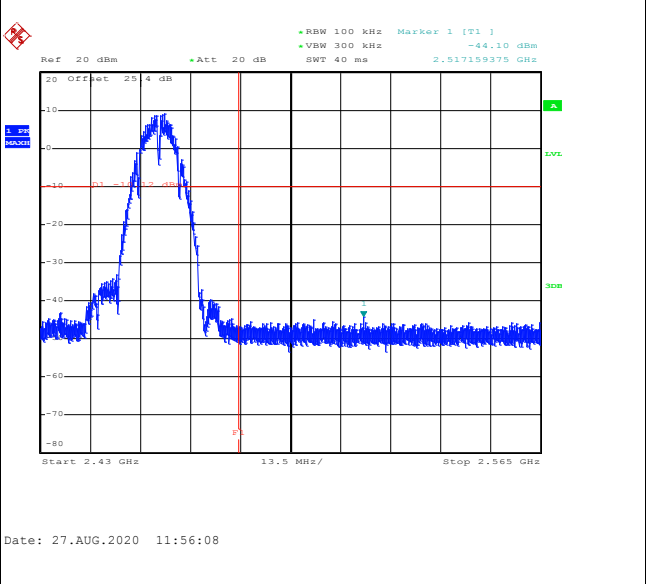
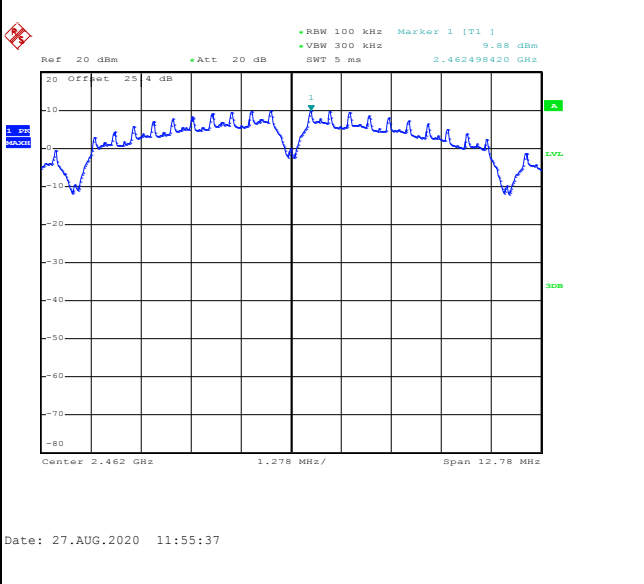

Spurious Emission 30MHz~3GHz	Spurious Emission 2GHz~25GHz
-------------------------------------	-------------------------------------

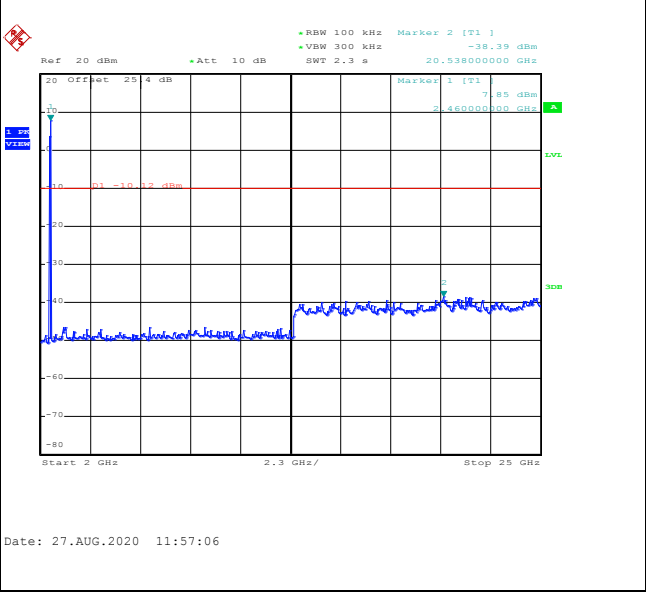
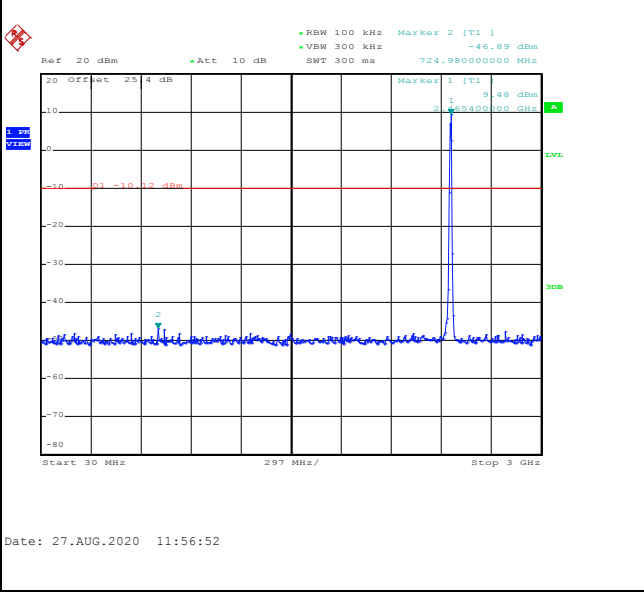



Test Mode :	802.11g	Test Channel :	01
-------------	---------	----------------	----

100kHz PSD reference Level	Low Channel Plot
-----------------------------------	-------------------------

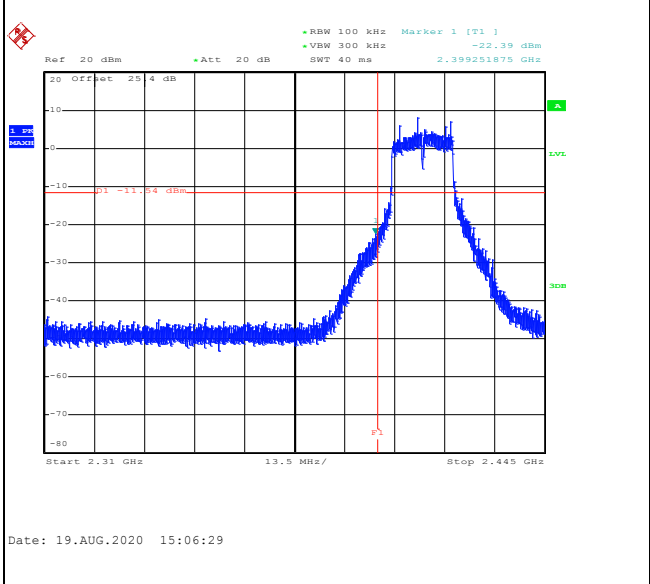
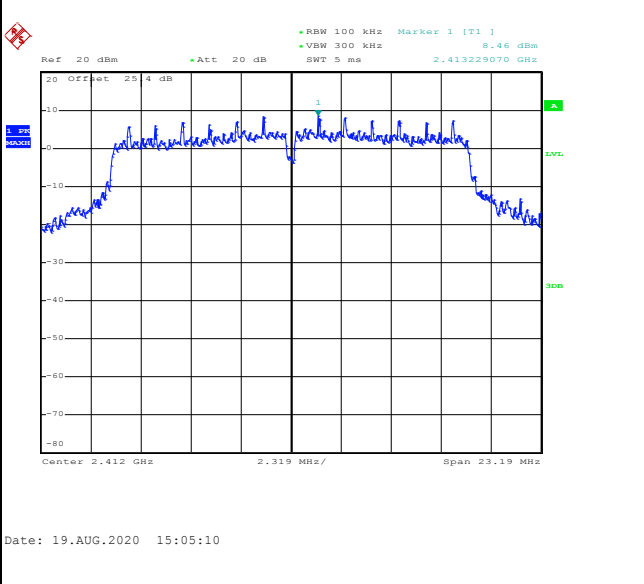

Spurious Emission 30MHz~3GHz	Spurious Emission 2GHz~25GHz
-------------------------------------	-------------------------------------

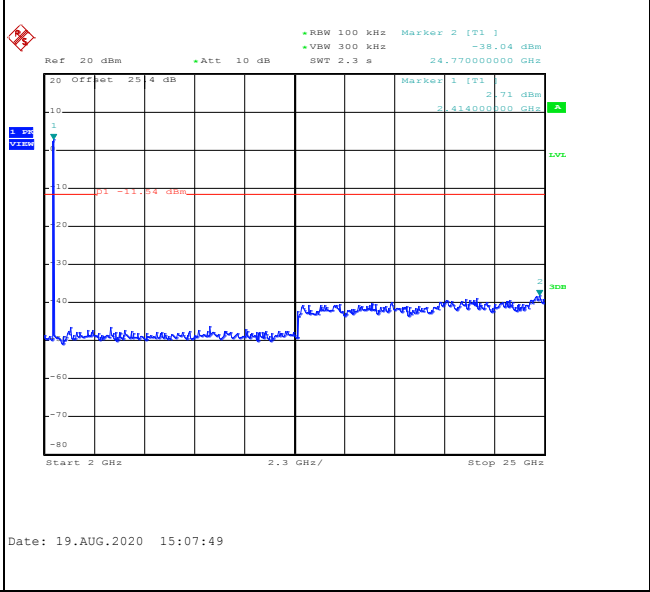
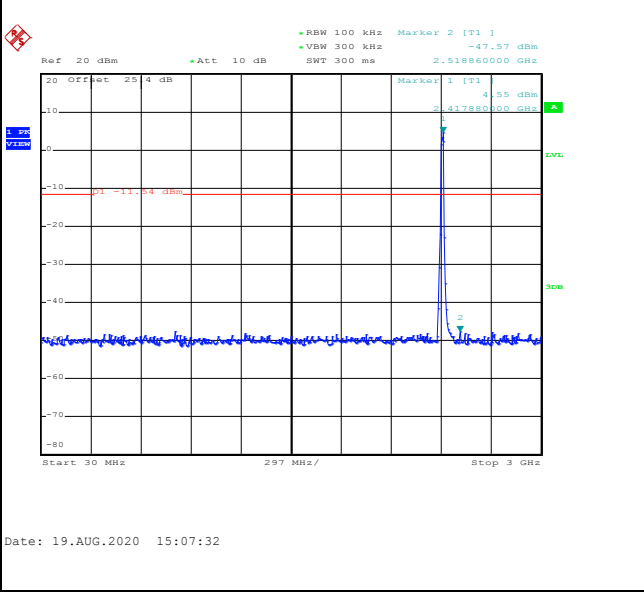



Test Mode :	802.11g	Test Channel :	06
-------------	---------	----------------	----

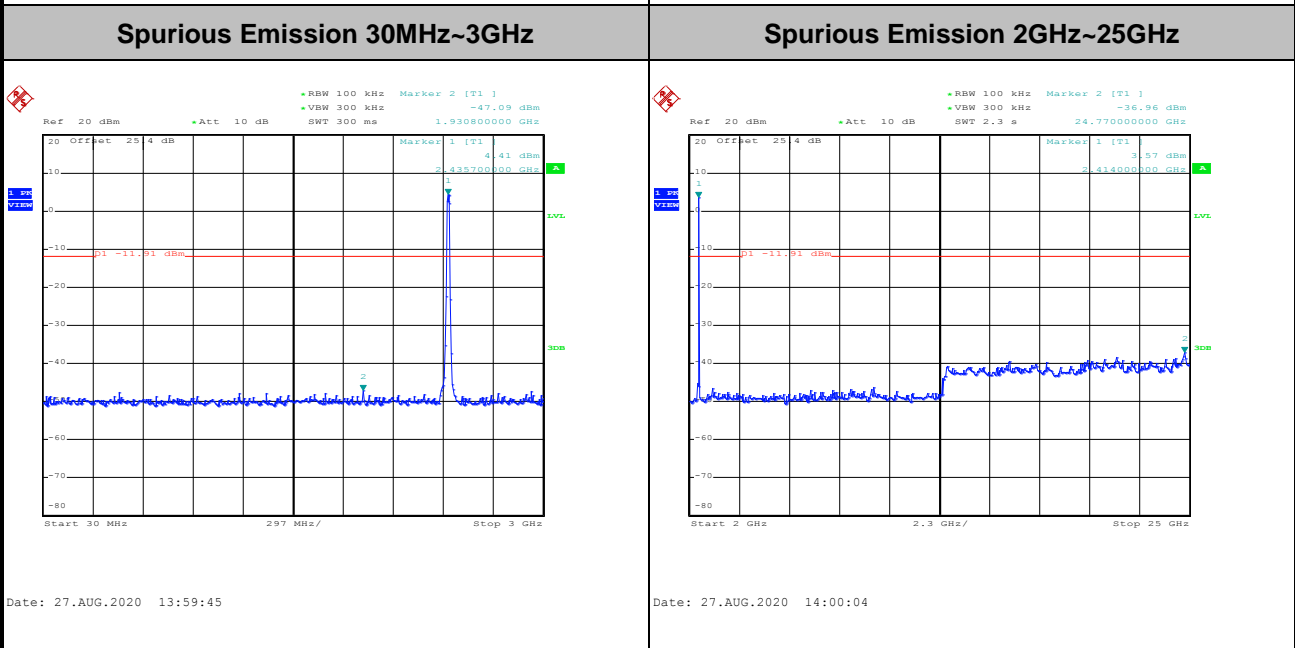
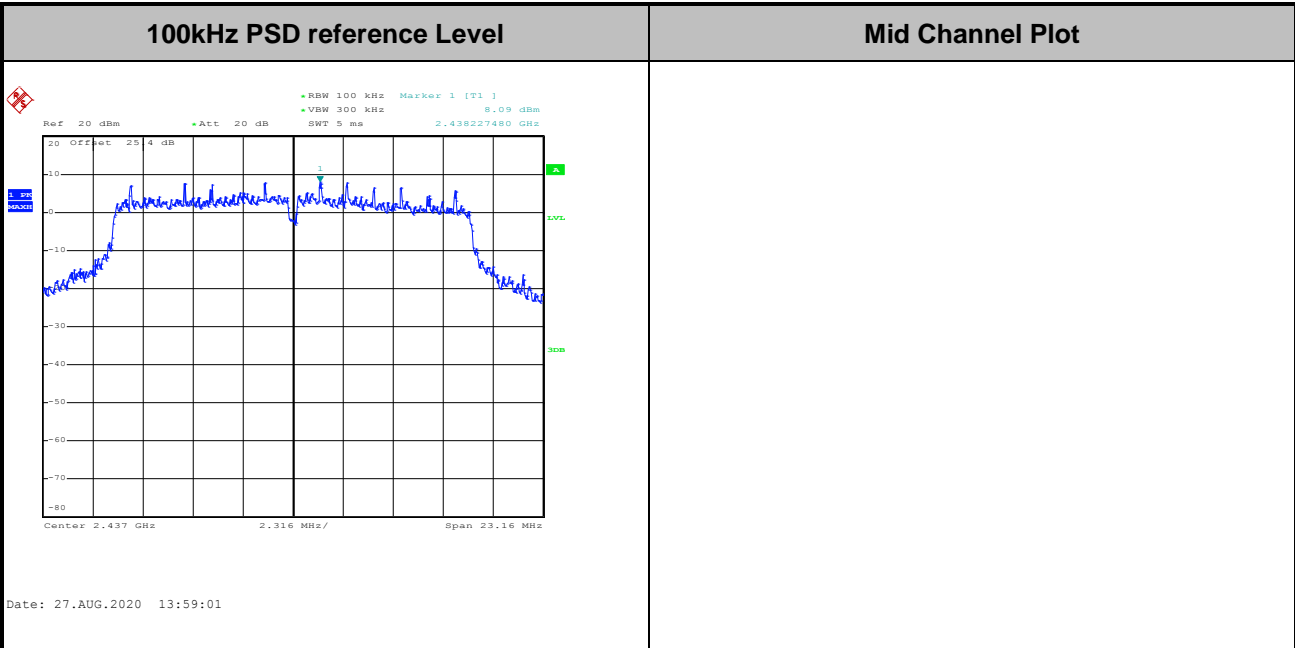



Test Mode :	802.11g	Test Channel :	11
-------------	---------	----------------	----

100kHz PSD reference Level	High Channel Plot
-----------------------------------	--------------------------

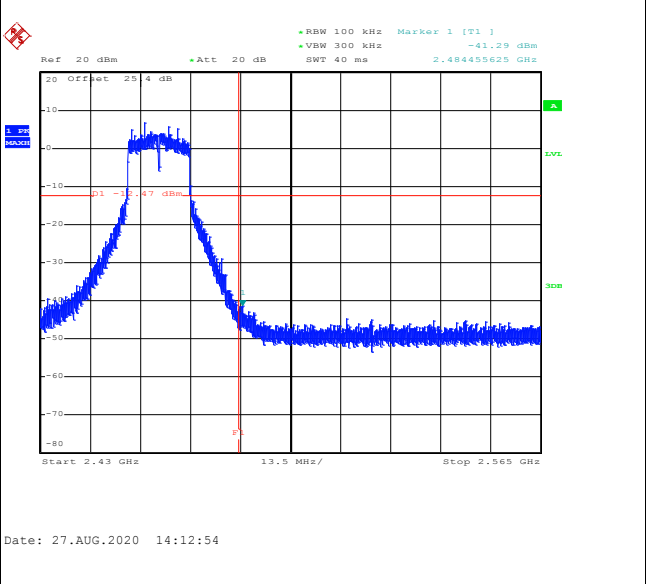
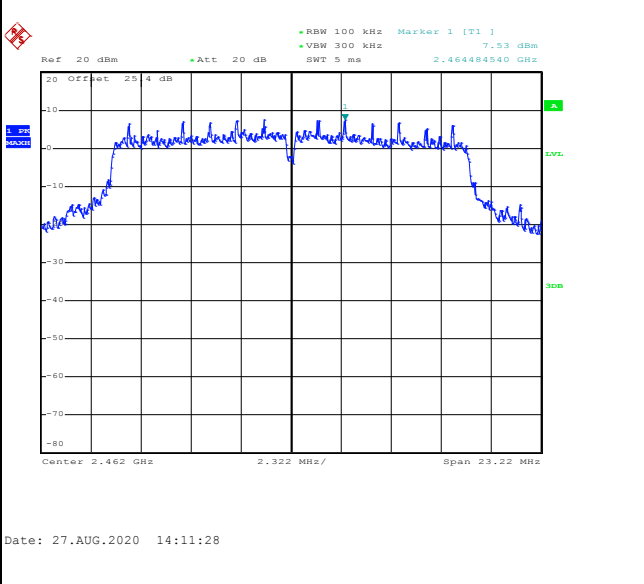

Spurious Emission 30MHz~3GHz	Spurious Emission 2GHz~25GHz
-------------------------------------	-------------------------------------

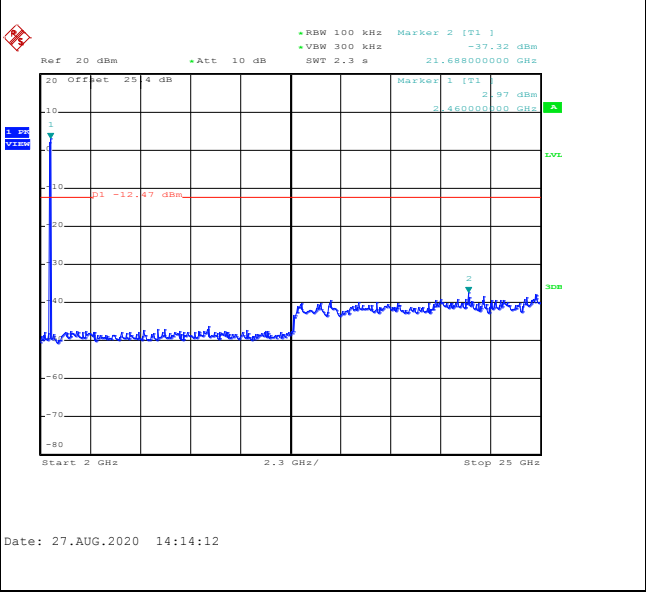
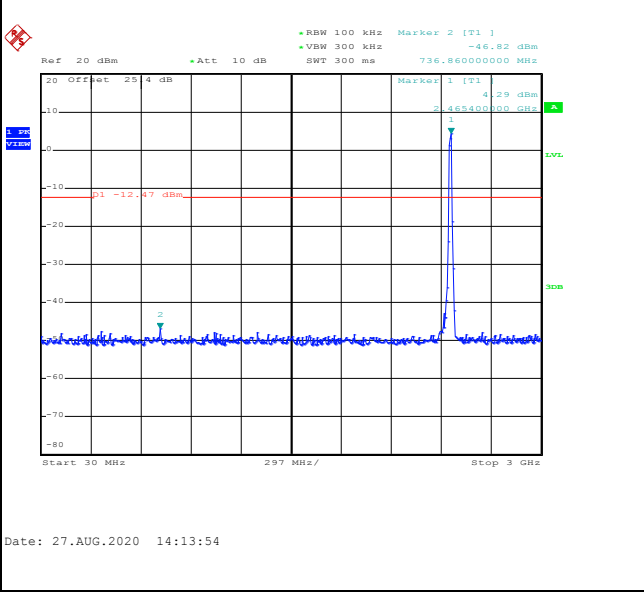



Test Mode :	802.11n HT20	Test Channel :	01
-------------	--------------	----------------	----

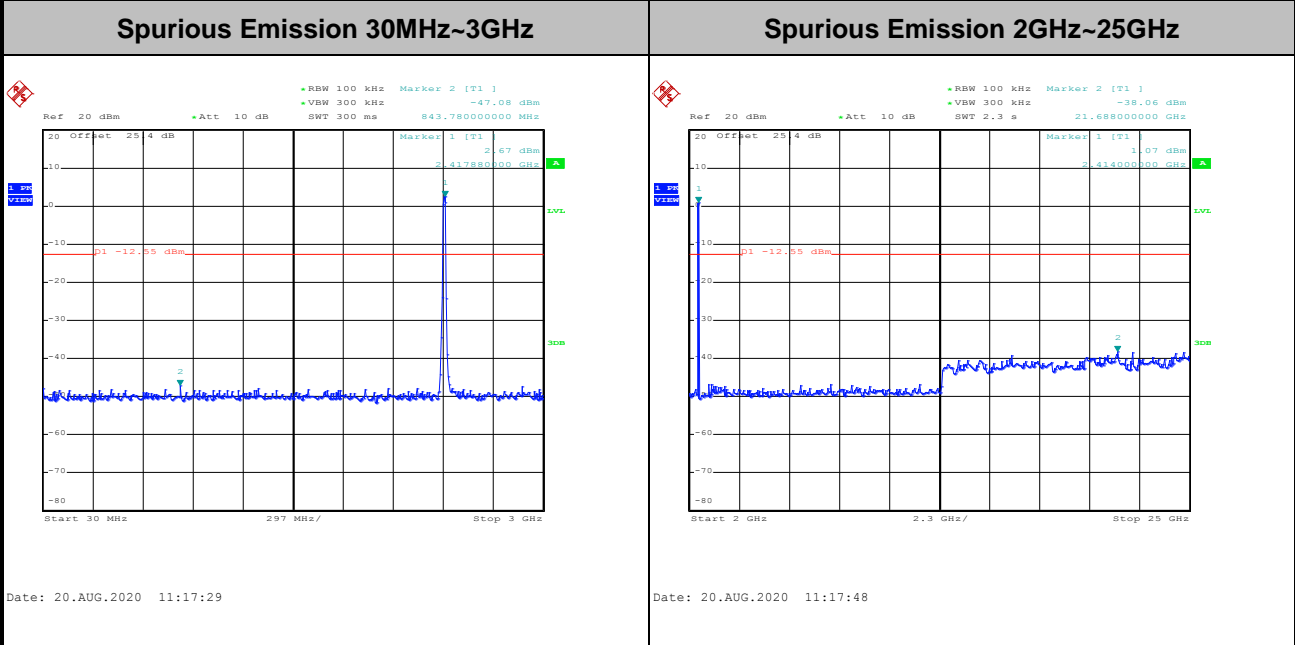
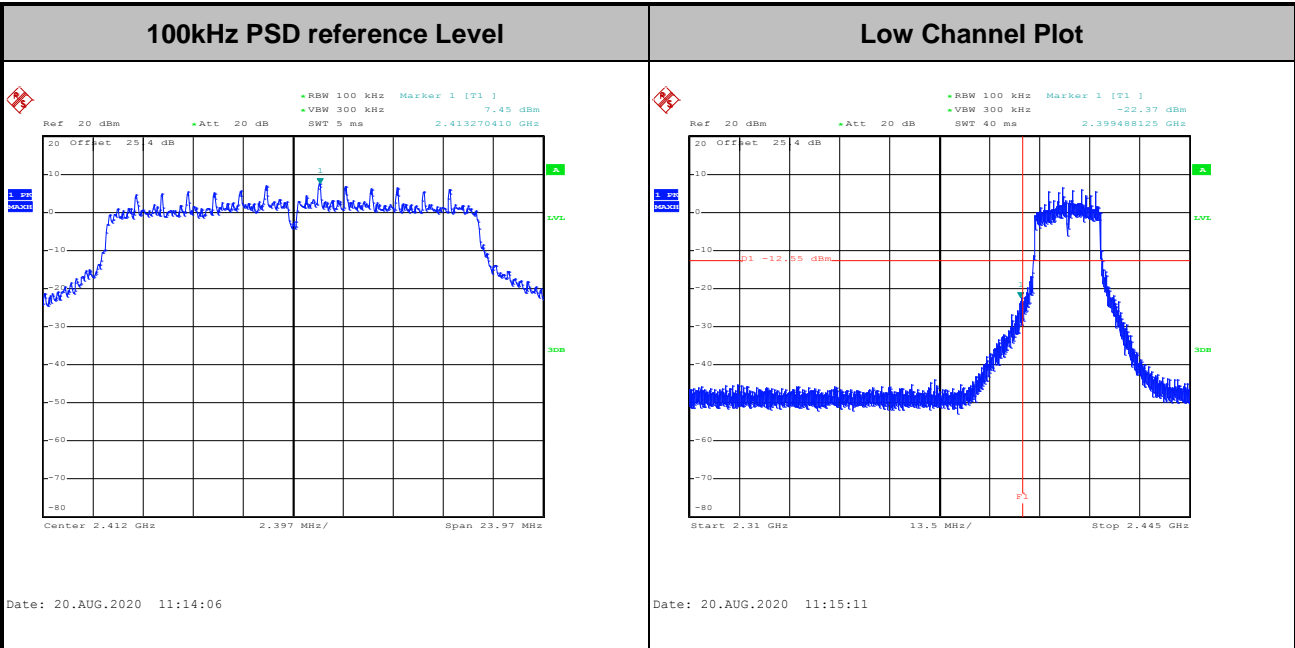



Test Mode :	802.11n HT20	Test Channel :	06
-------------	--------------	----------------	----

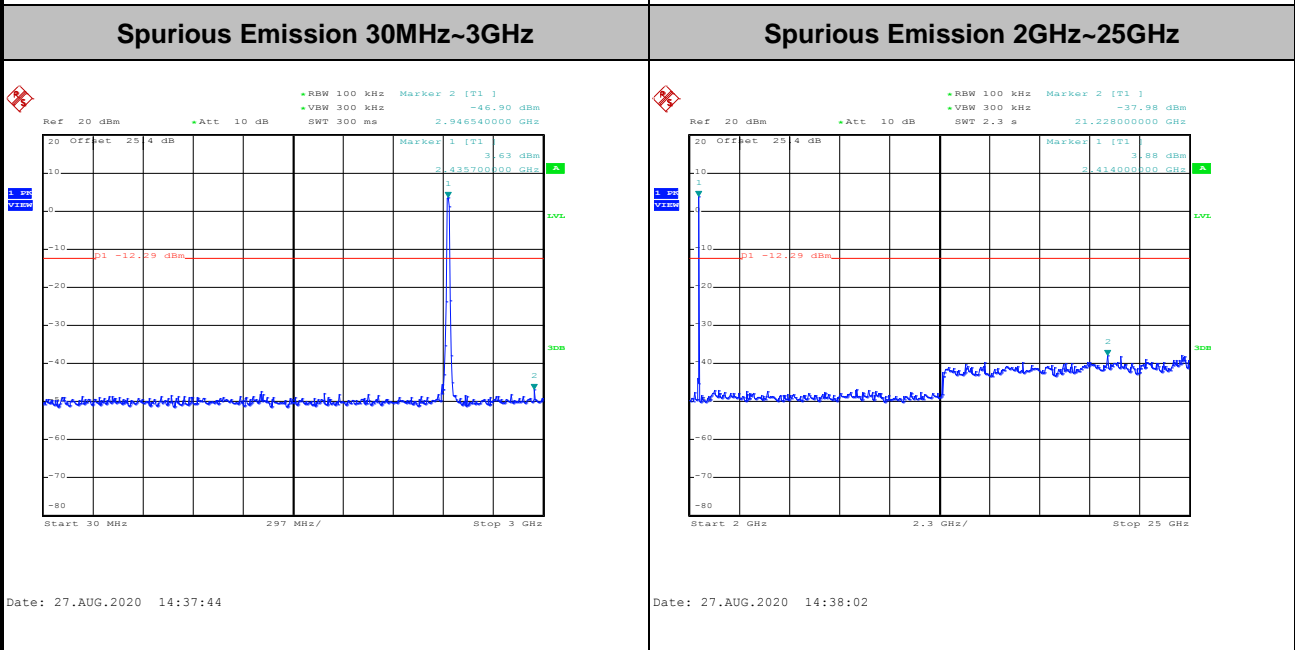
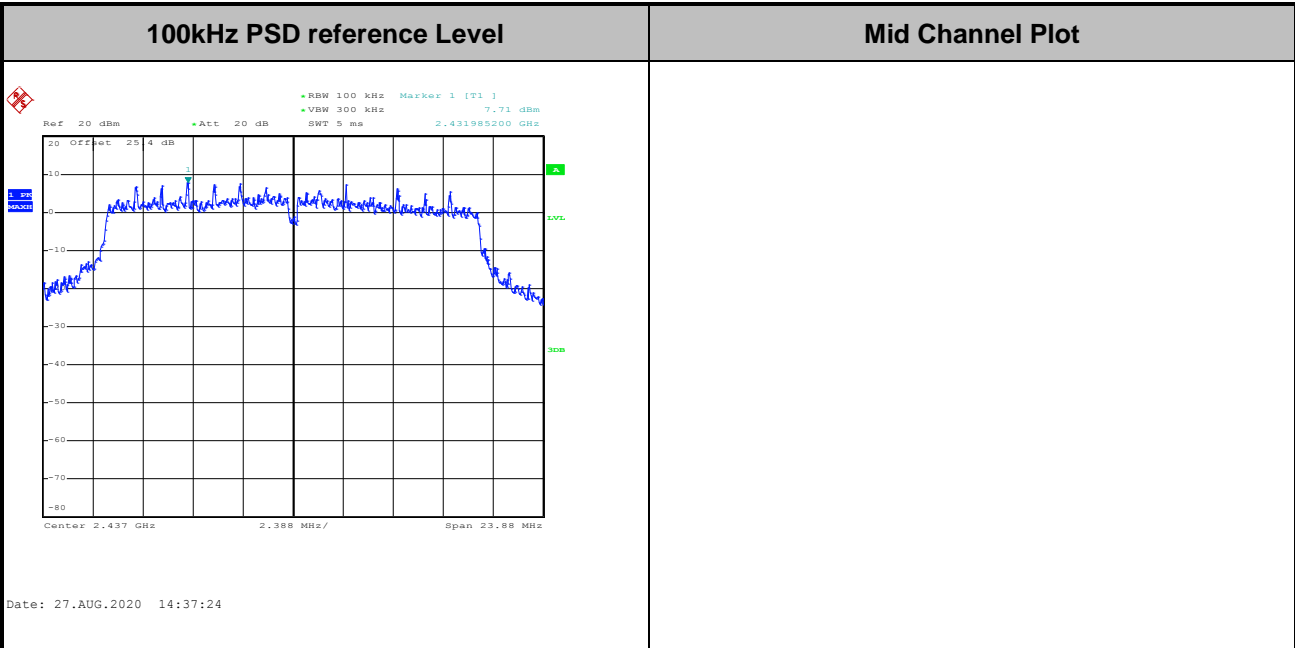



Test Mode :	802.11n HT20	Test Channel :	11
-------------	--------------	----------------	----

100kHz PSD reference Level	High Channel Plot
-----------------------------------	--------------------------

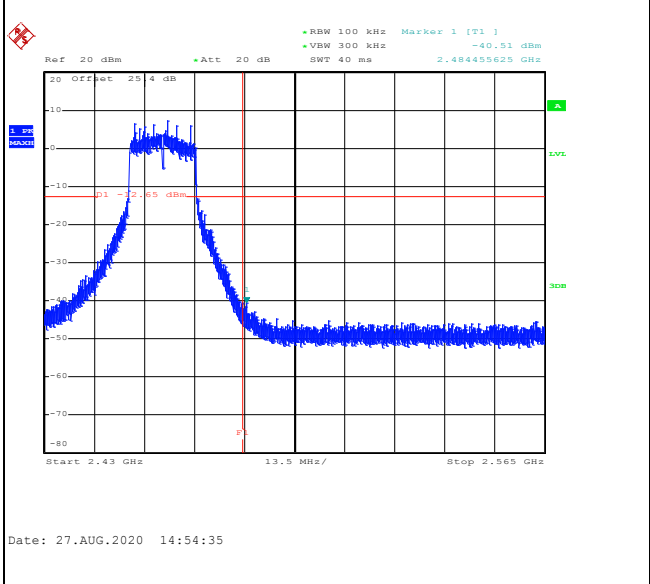
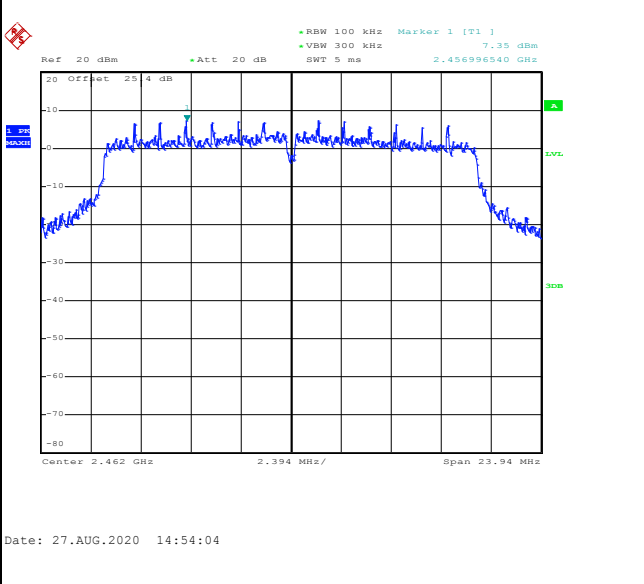

Spurious Emission 30MHz~3GHz	Spurious Emission 2GHz~25GHz
-------------------------------------	-------------------------------------

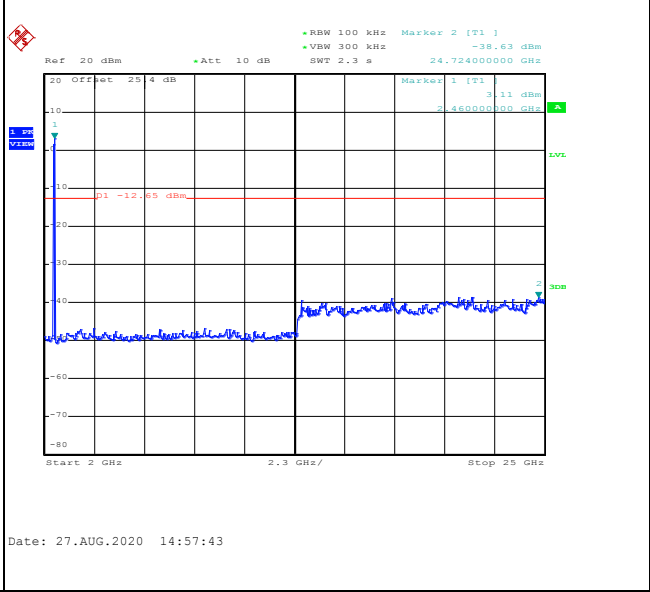
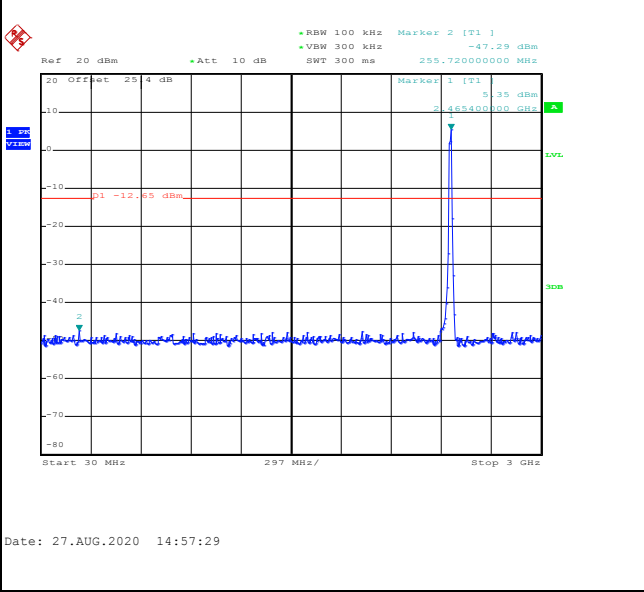



Test Mode :	802.11n HT40	Test Channel :	03
-------------	--------------	----------------	----

100kHz PSD reference Level	Low Channel Plot
-----------------------------------	-------------------------

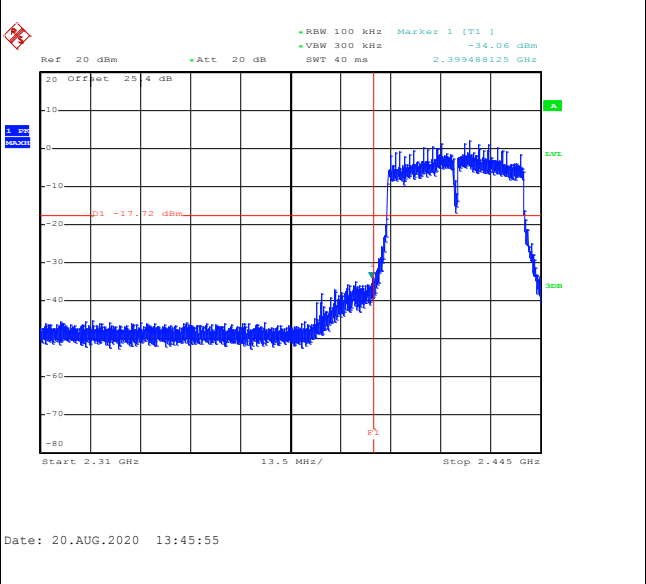
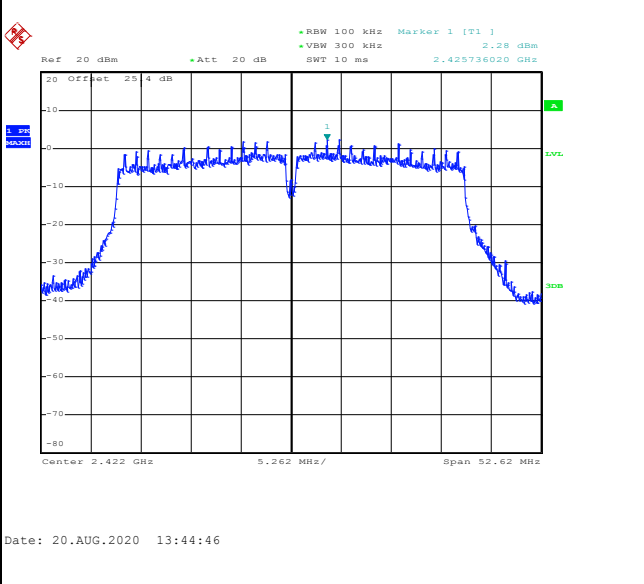

Spurious Emission 30MHz~3GHz	Spurious Emission 2GHz~25GHz
-------------------------------------	-------------------------------------

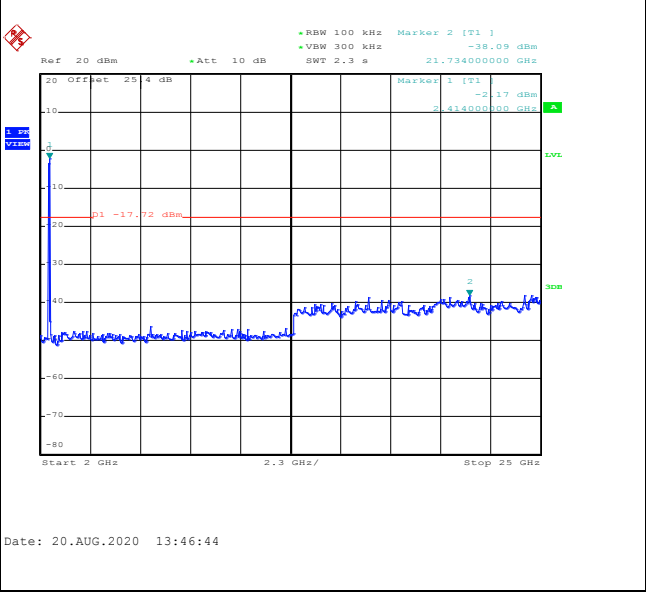
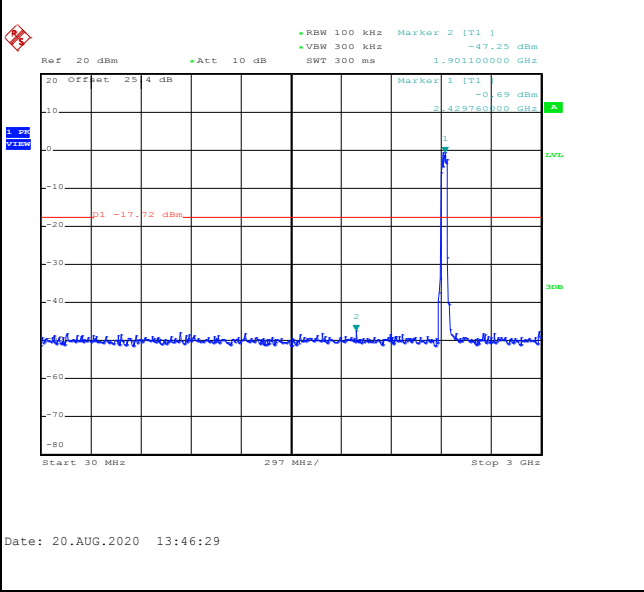



Test Mode :	802.11n HT40	Test Channel :	06
-------------	--------------	----------------	----

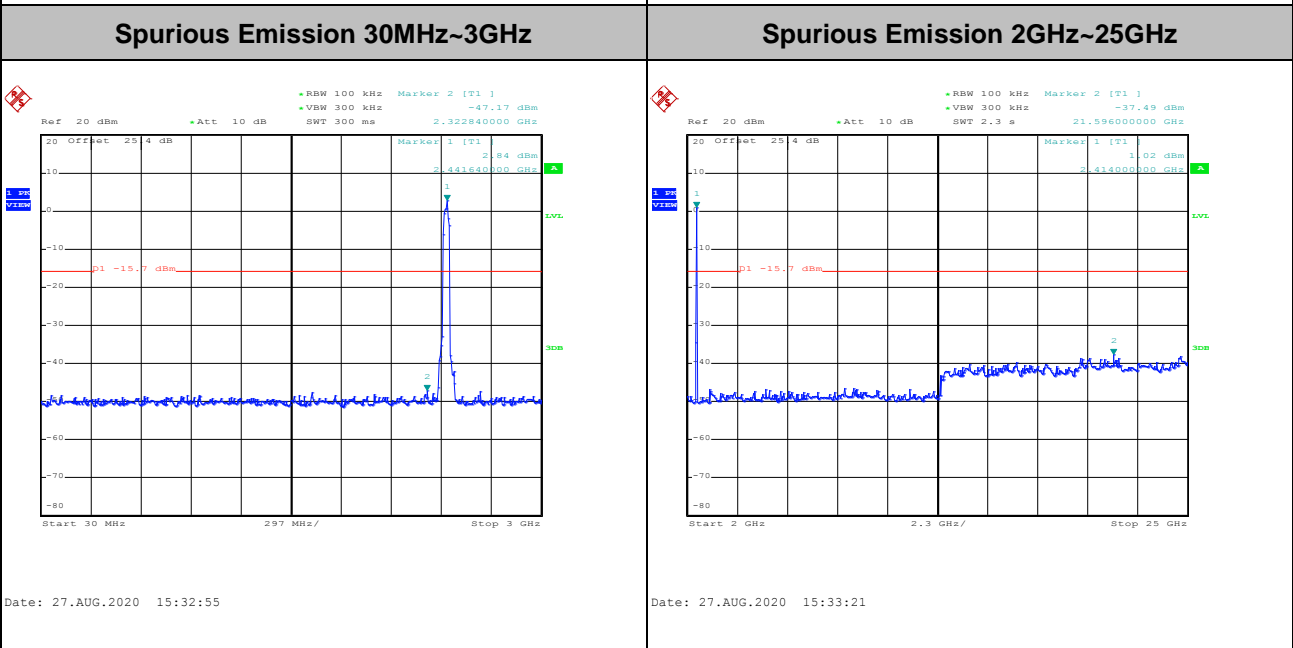
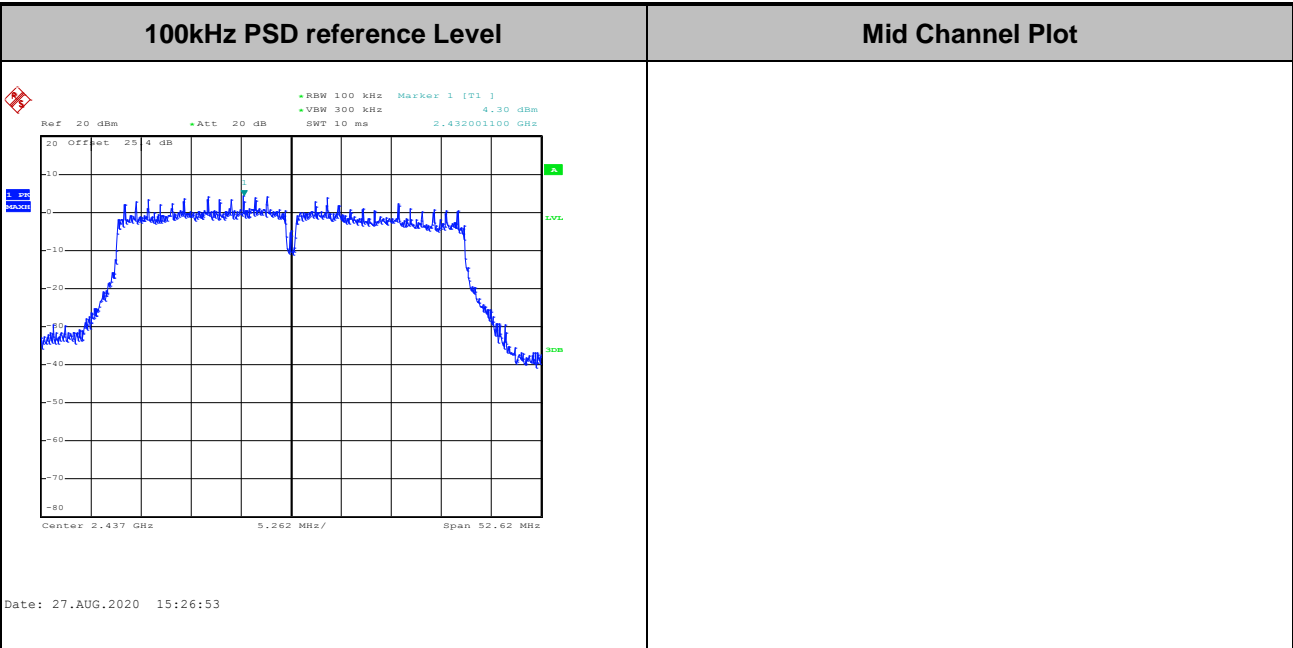



Test Mode :	802.11n HT40	Test Channel :	09
-------------	--------------	----------------	----

100kHz PSD reference Level	High Channel Plot
-----------------------------------	--------------------------

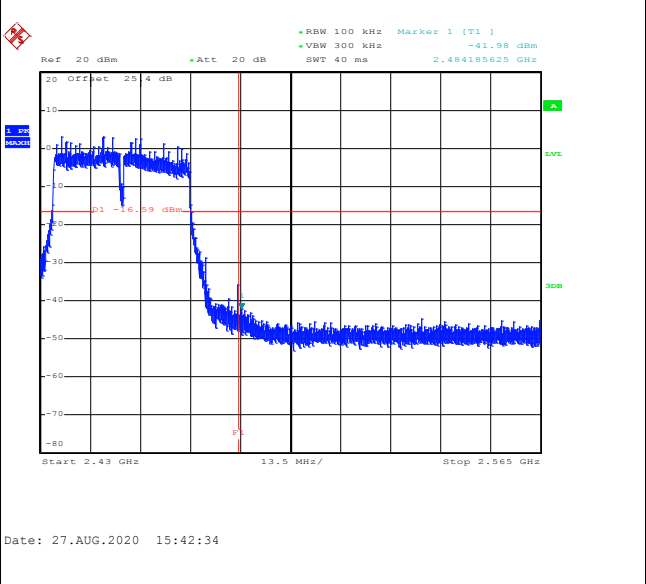
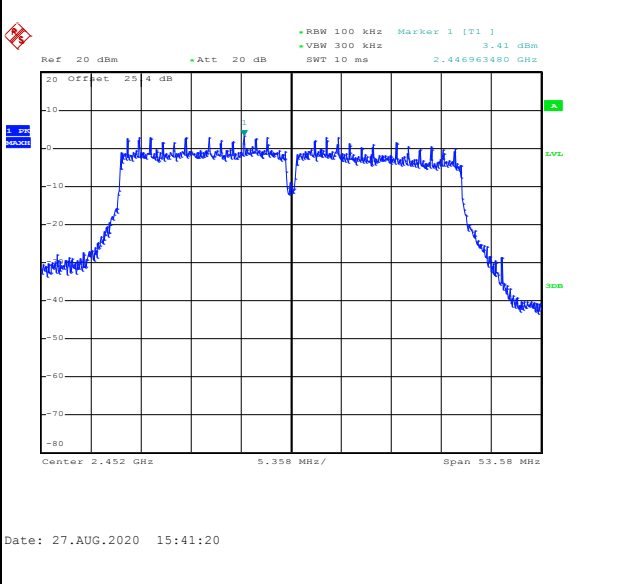

Spurious Emission 30MHz~3GHz	Spurious Emission 2GHz~25GHz
-------------------------------------	-------------------------------------

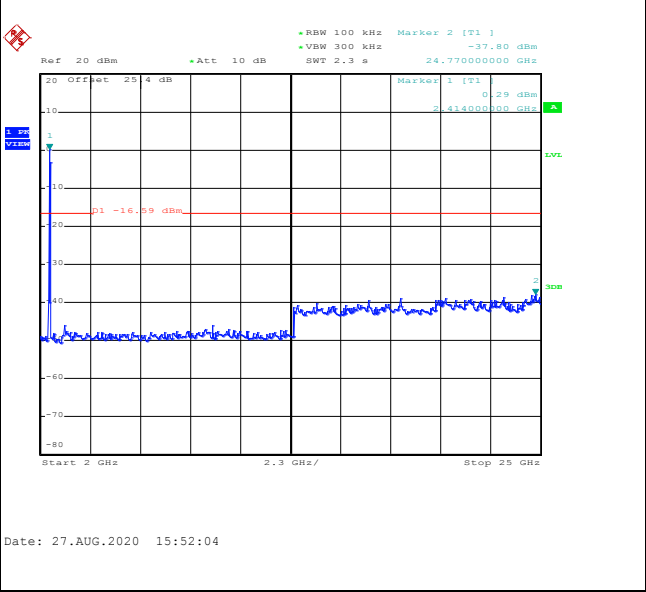
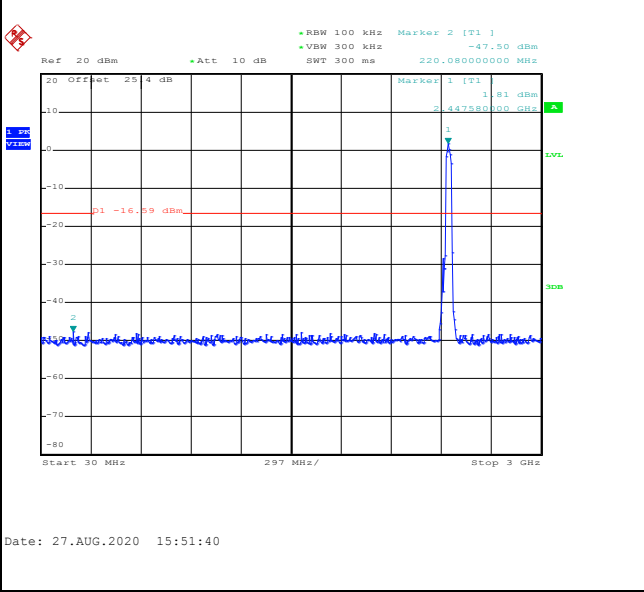



Number of TX = 2, Ant. 0 (Measured)

Test Mode :	802.11b	Test Channel :	01
-------------	---------	----------------	----

100kHz PSD reference Level	Low Channel Plot
-----------------------------------	-------------------------

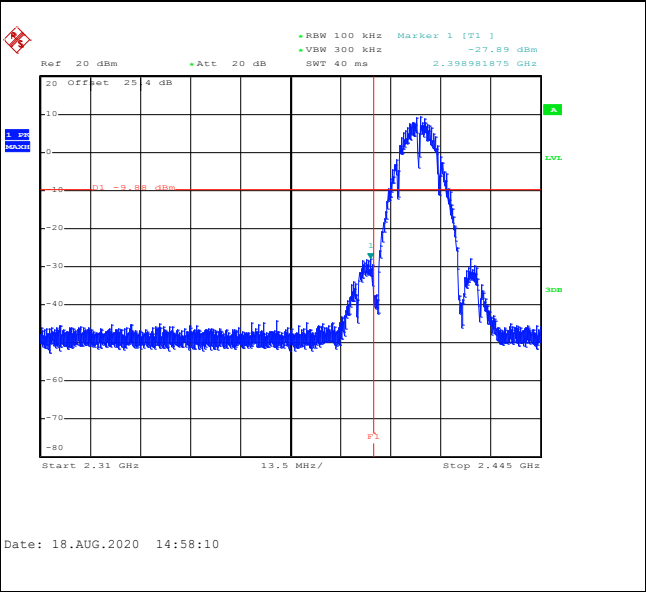
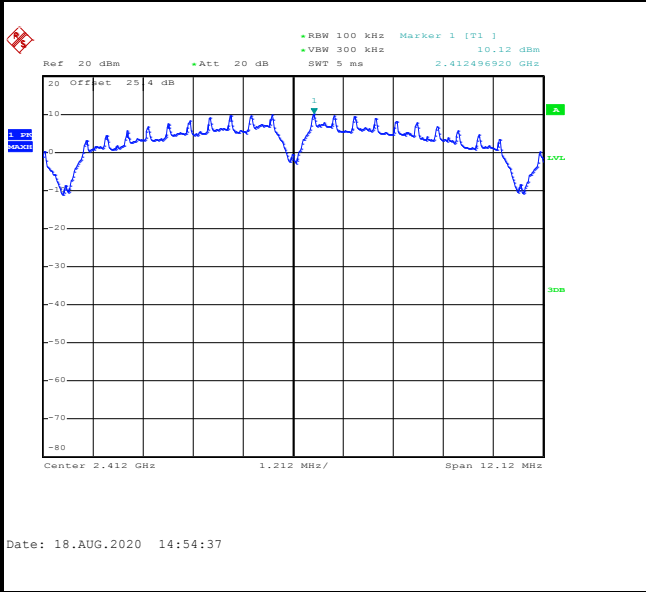

Spurious Emission 30MHz~3GHz

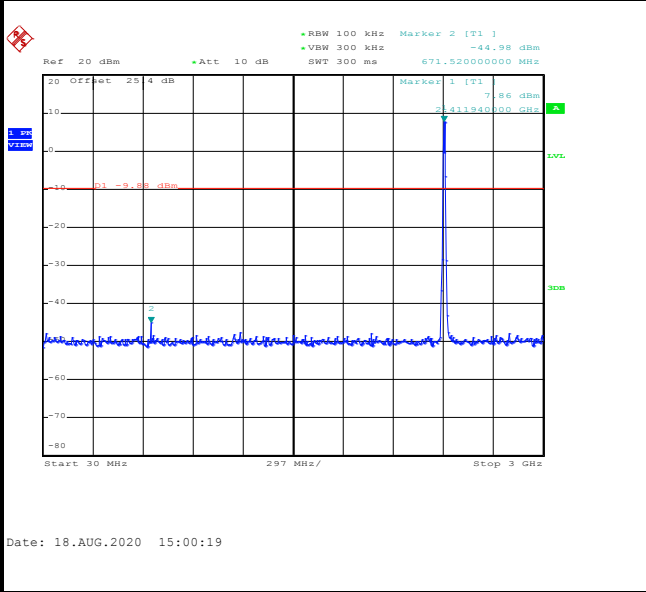

Spurious Emission 2GHz~25GHz

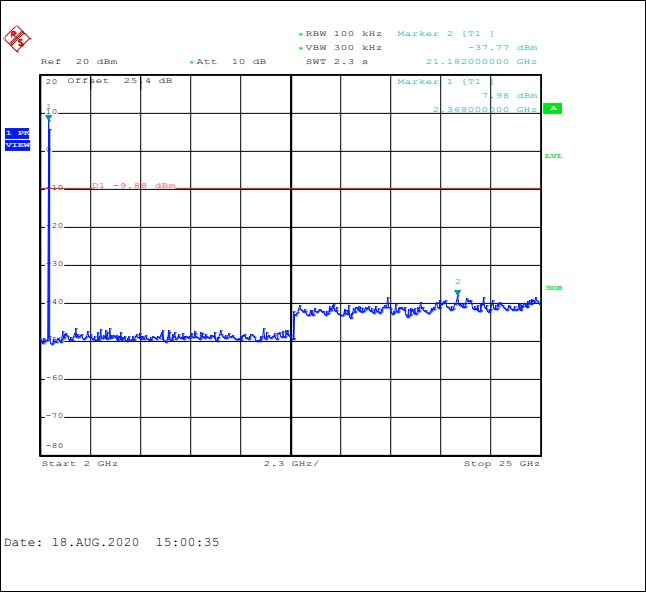



Test Mode :	802.11b	Test Channel :	06
-------------	---------	----------------	----

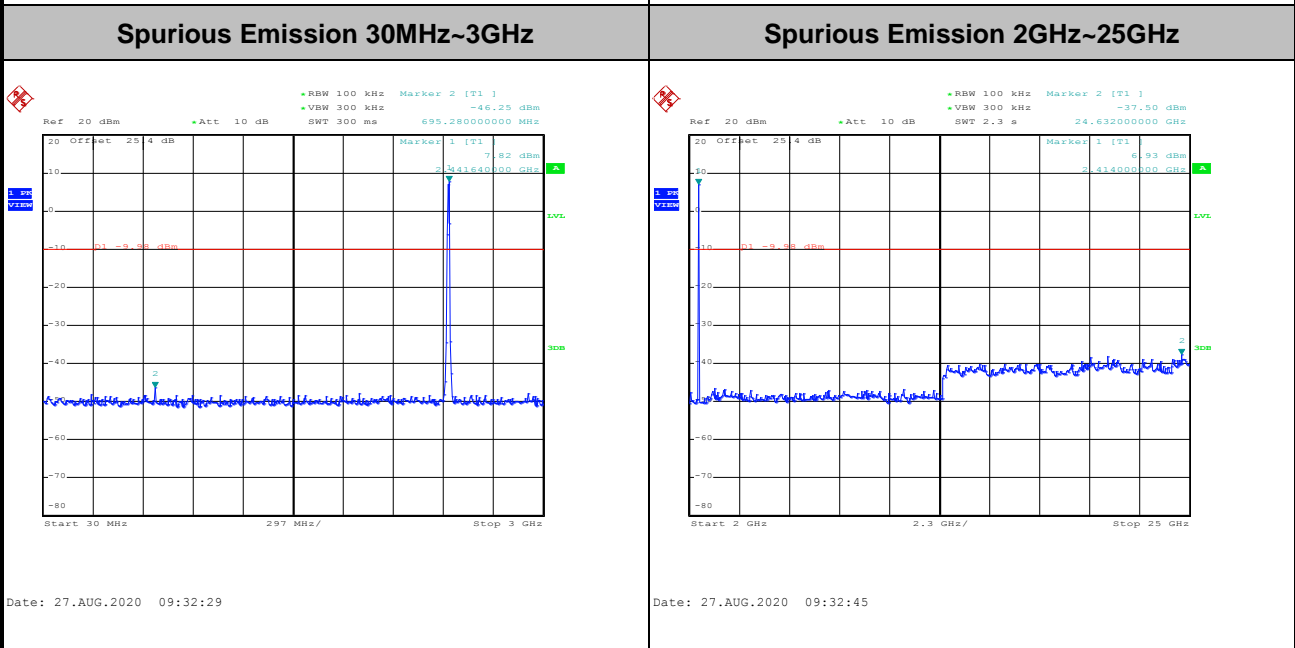
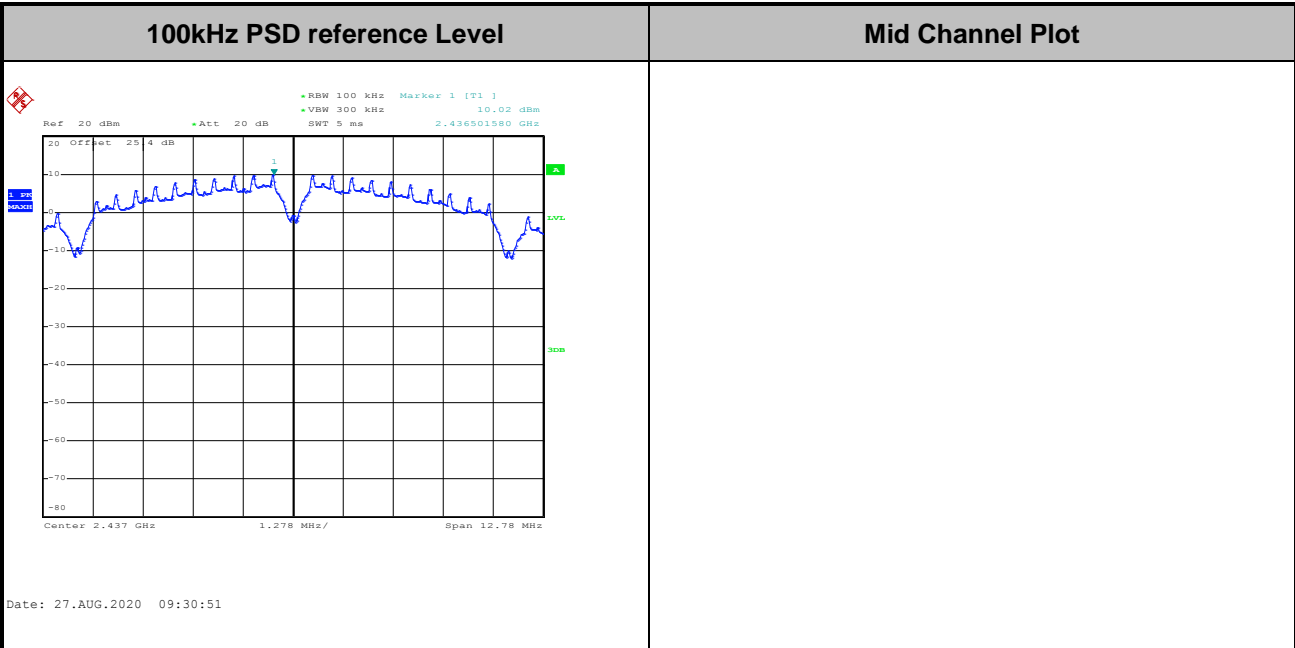



Test Mode :	802.11b	Test Channel :	11
-------------	---------	----------------	----

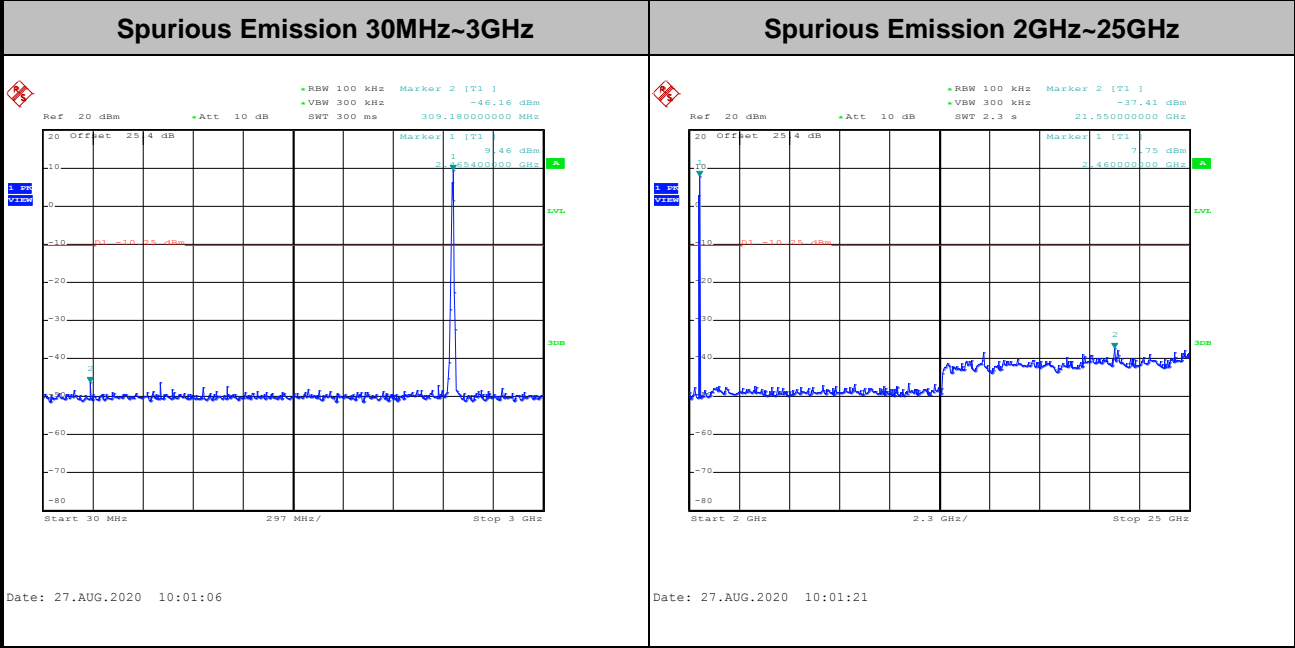
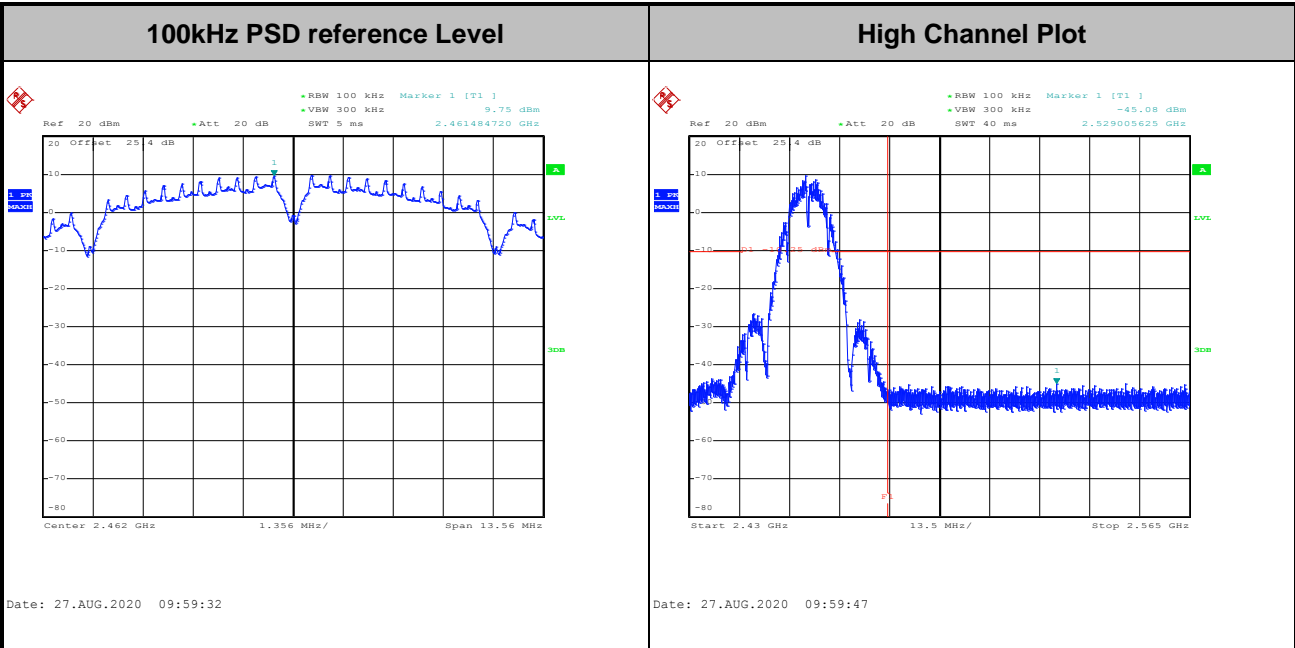



Test Mode :	802.11g	Test Channel :	01
-------------	---------	----------------	----

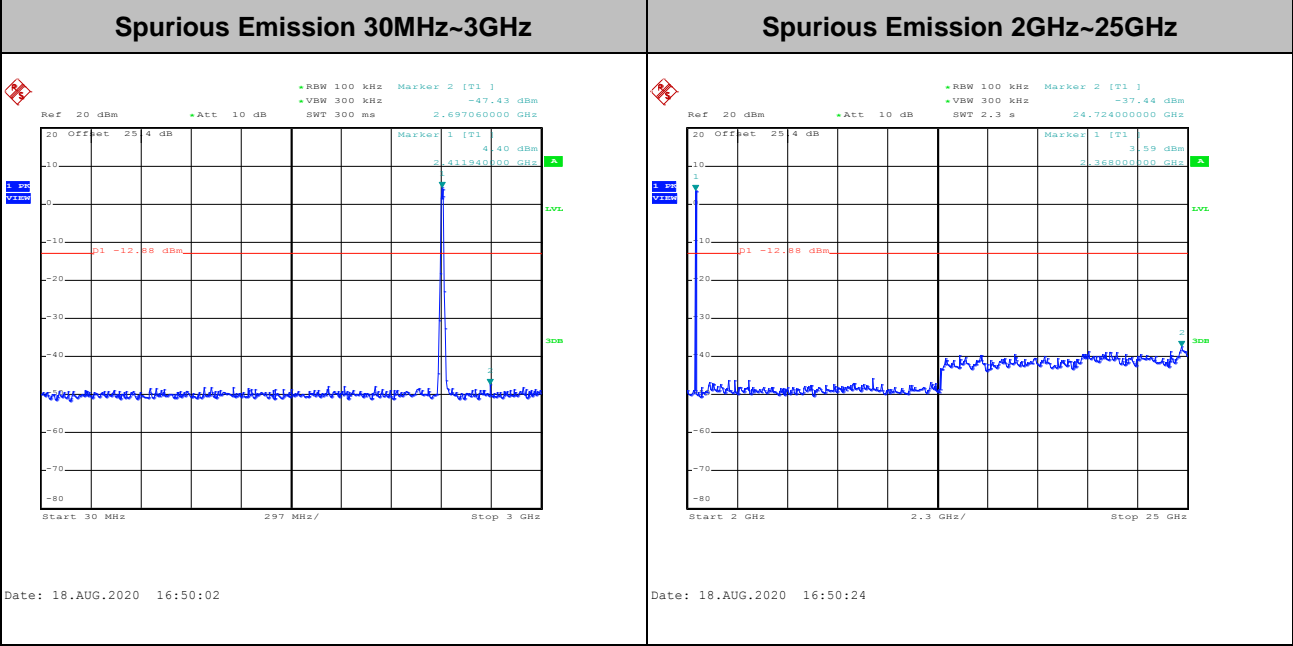
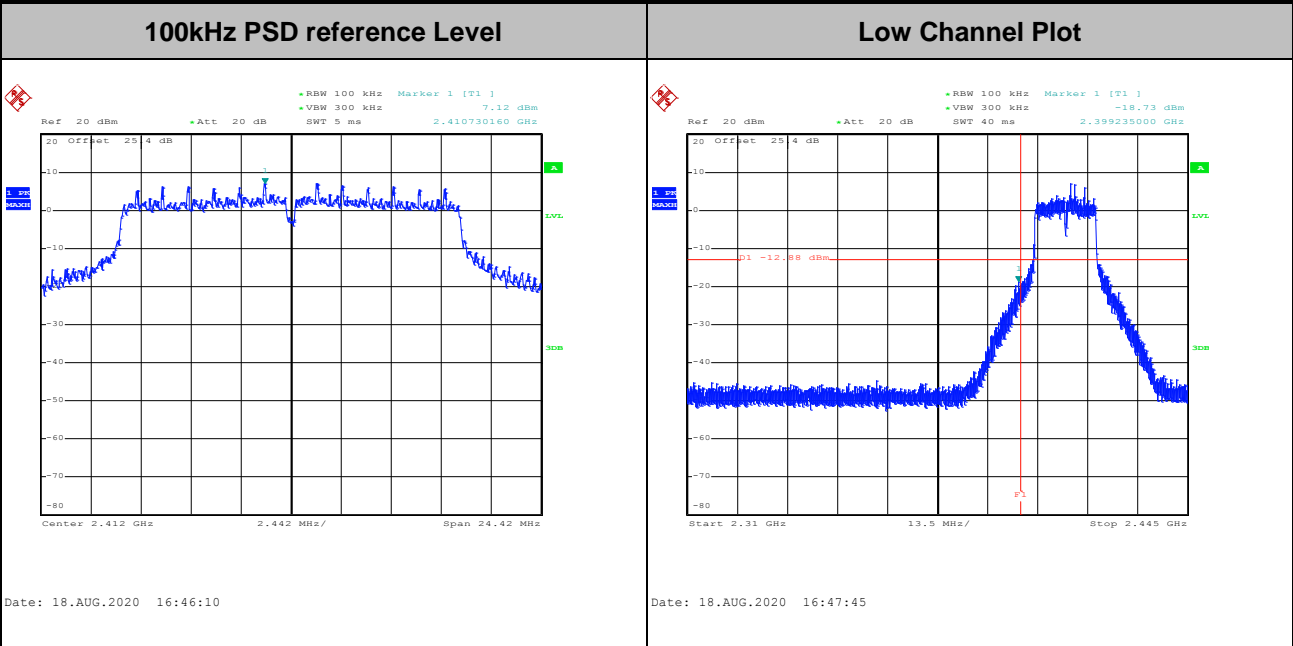



Test Mode :	802.11g	Test Channel :	06
-------------	---------	----------------	----

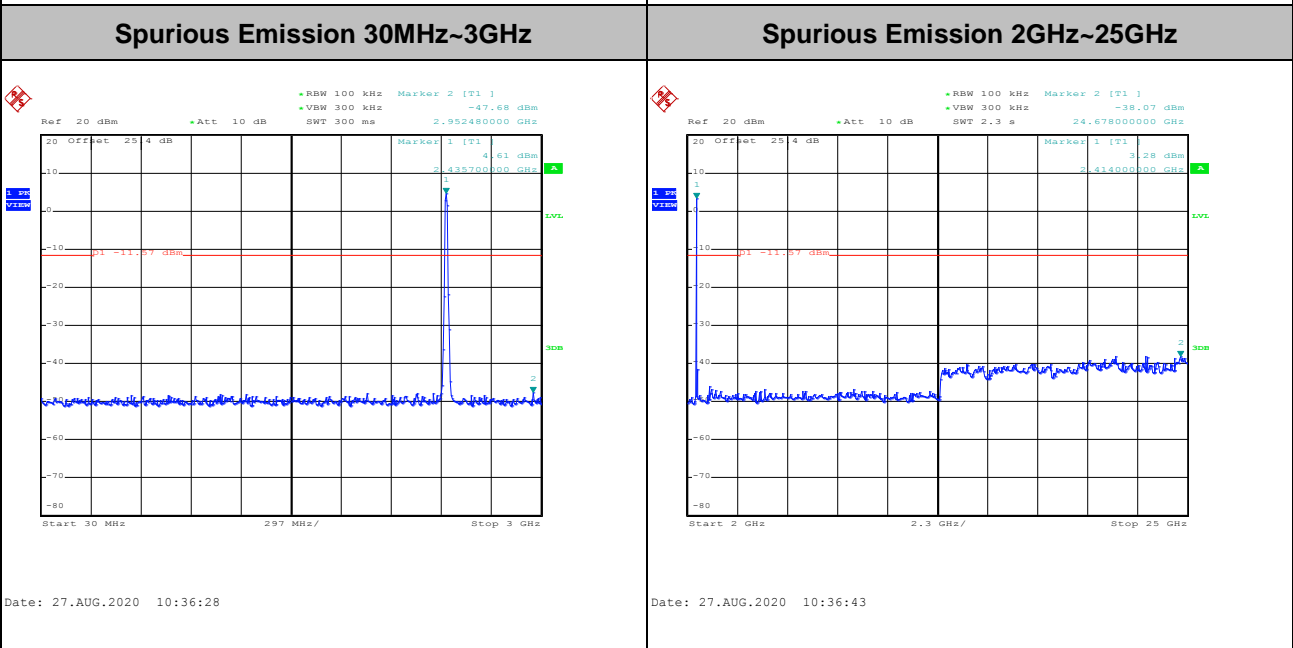
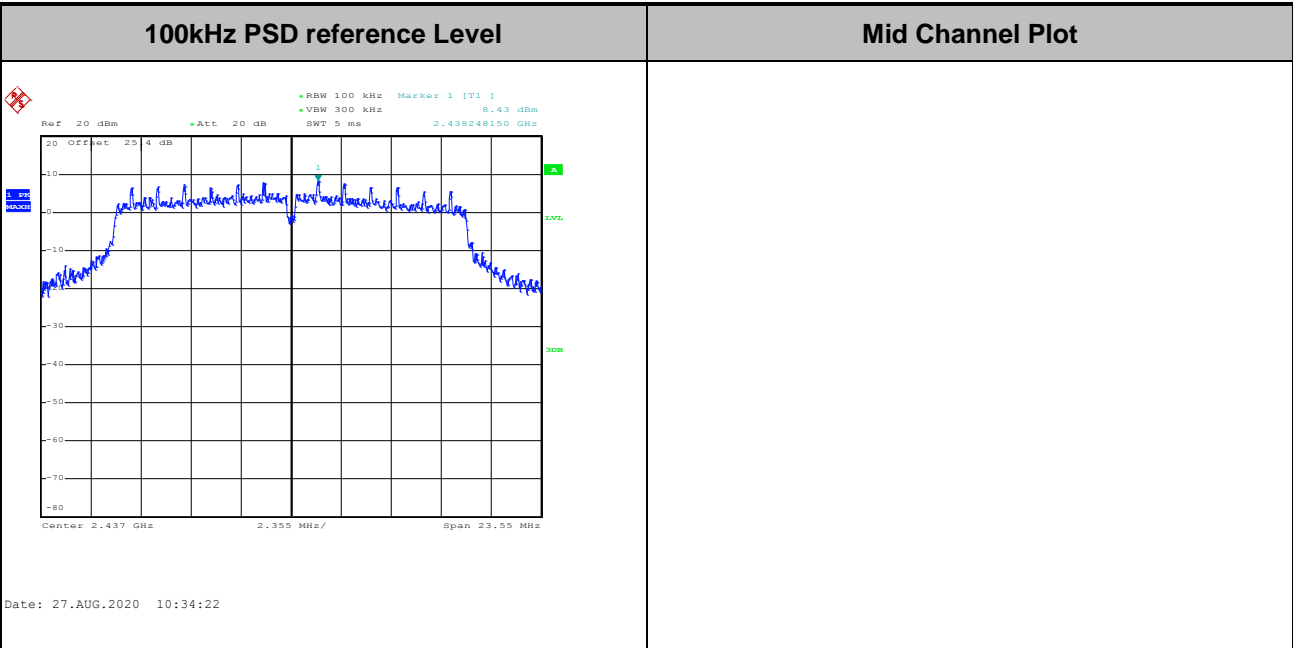



Test Mode :	802.11g	Test Channel :	11
-------------	---------	----------------	----

100kHz PSD reference Level	High Channel Plot
-----------------------------------	--------------------------

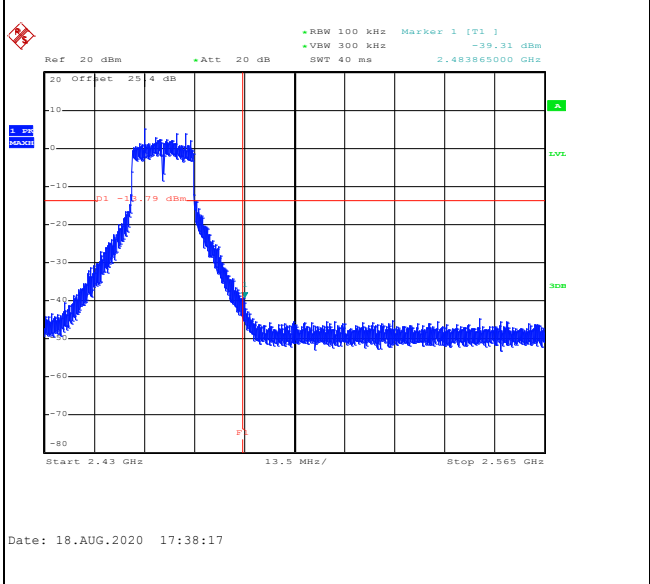
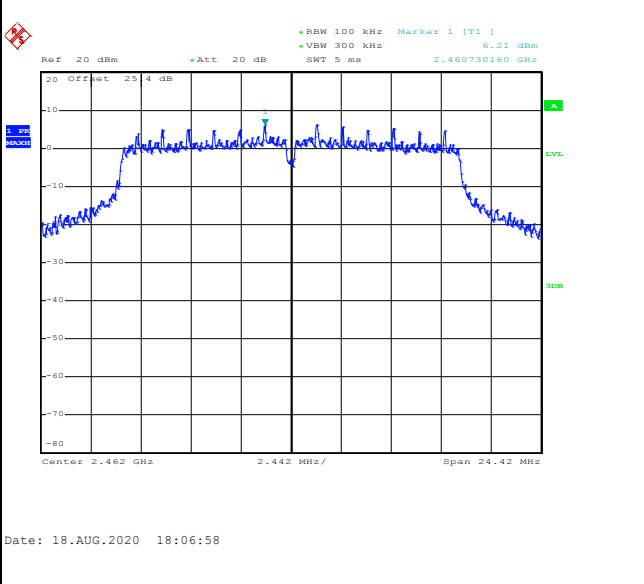

Spurious Emission 30MHz~3GHz	Spurious Emission 2GHz~25GHz
-------------------------------------	-------------------------------------

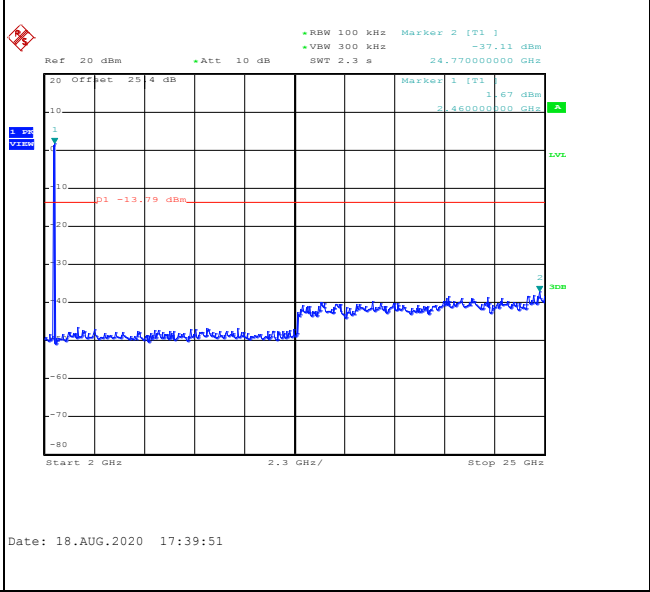
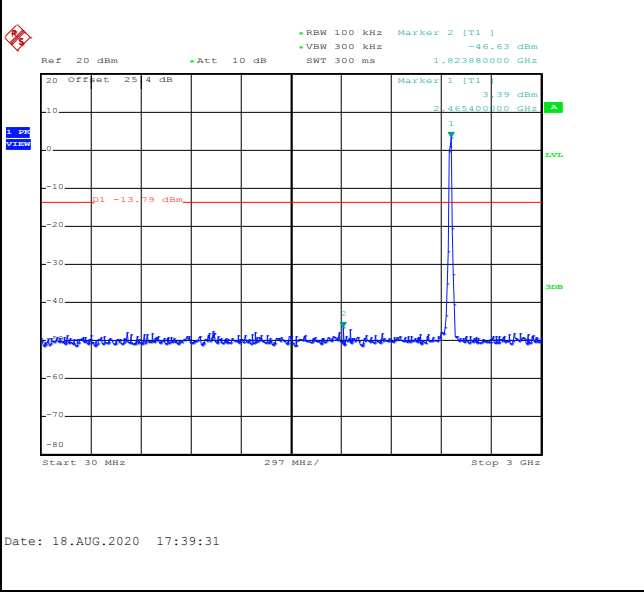



Test Mode :	802.11n HT20	Test Channel :	01
-------------	--------------	----------------	----

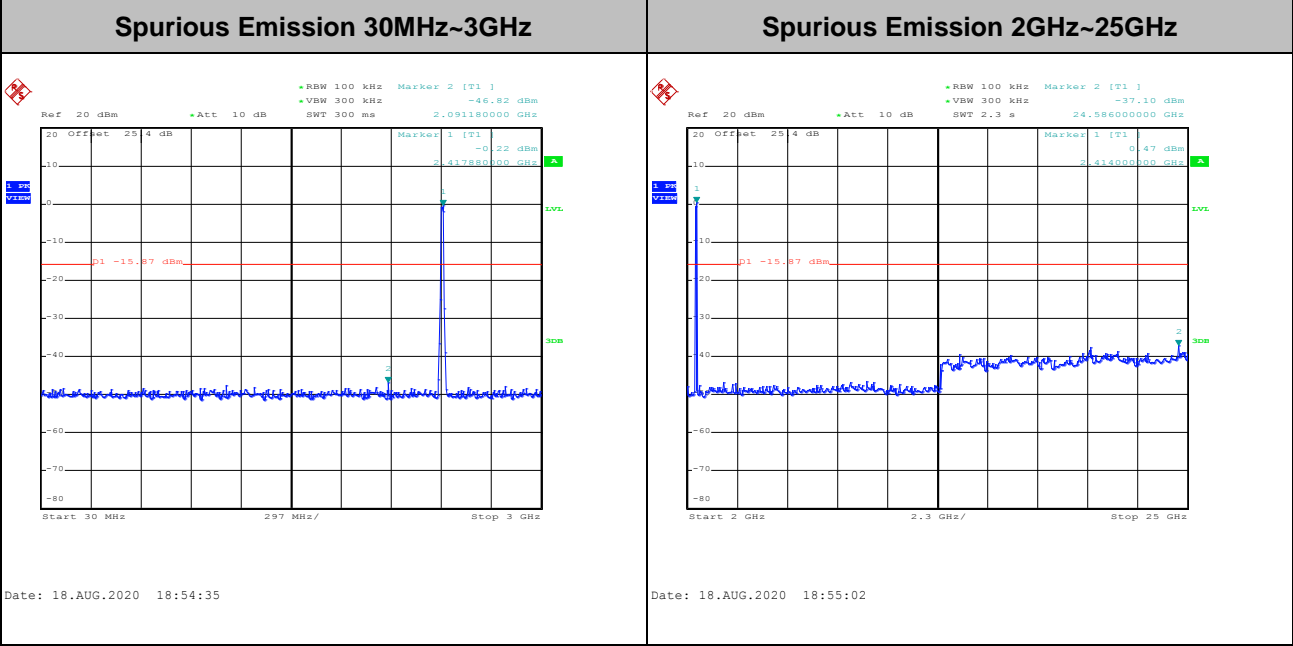
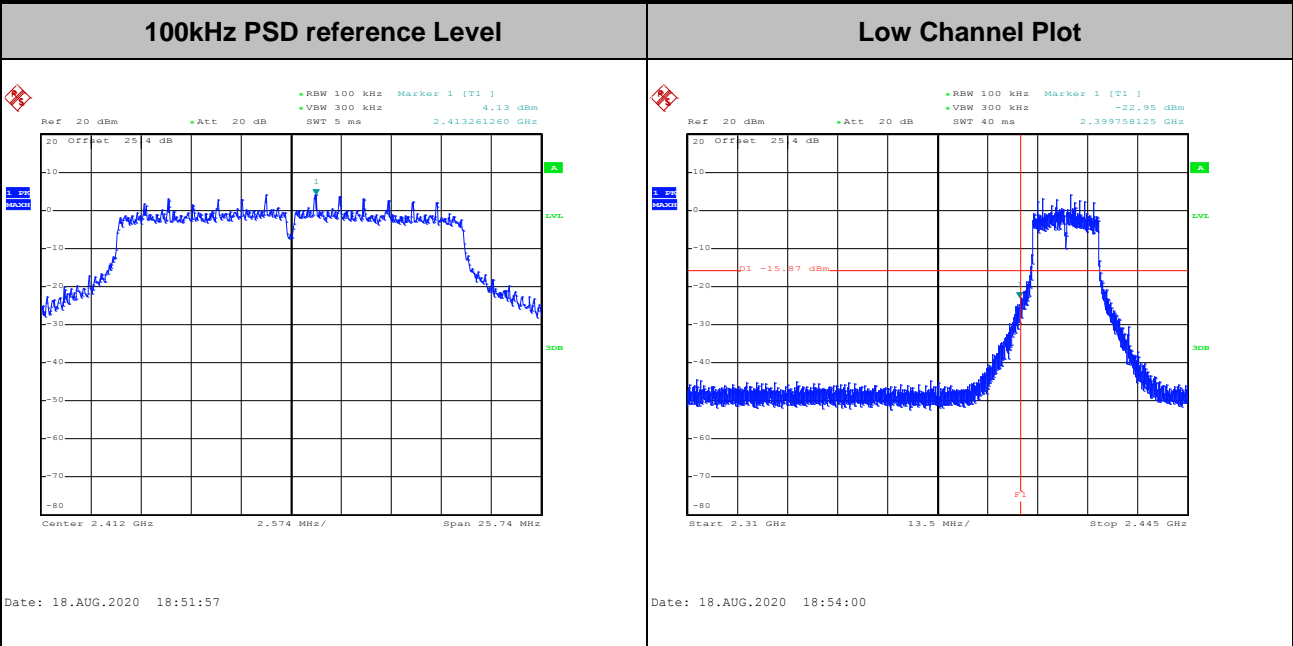



Test Mode :	802.11n HT20	Test Channel :	06
-------------	--------------	----------------	----

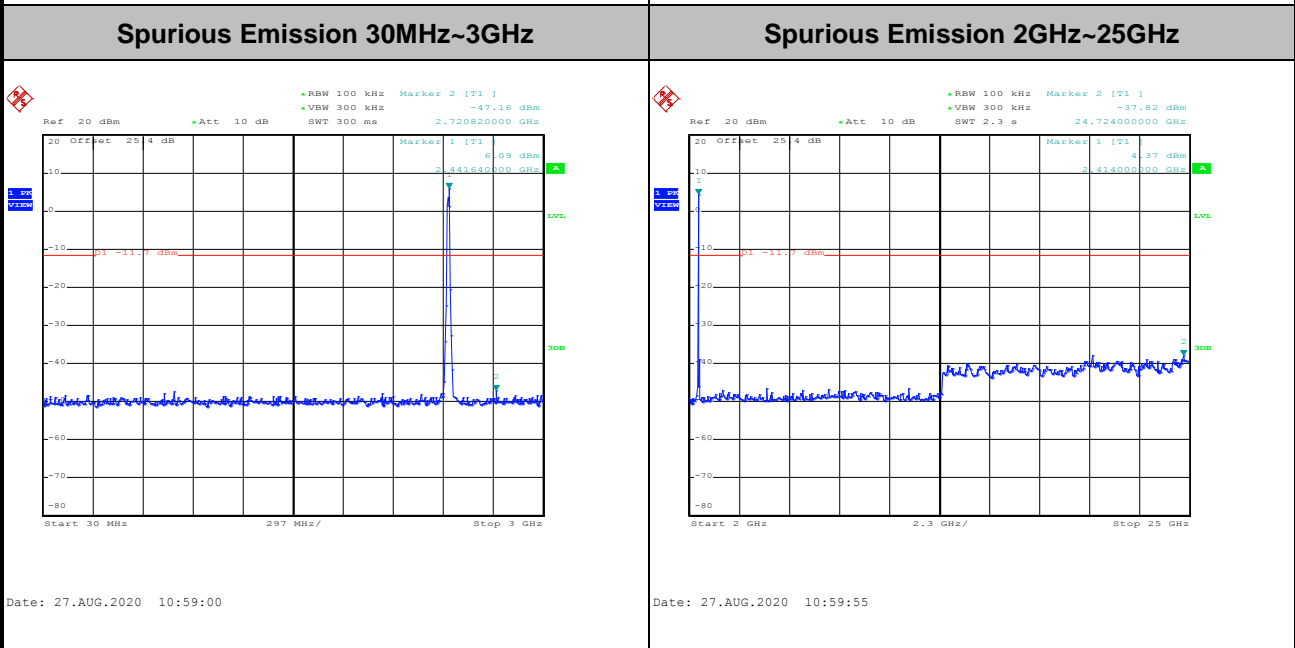
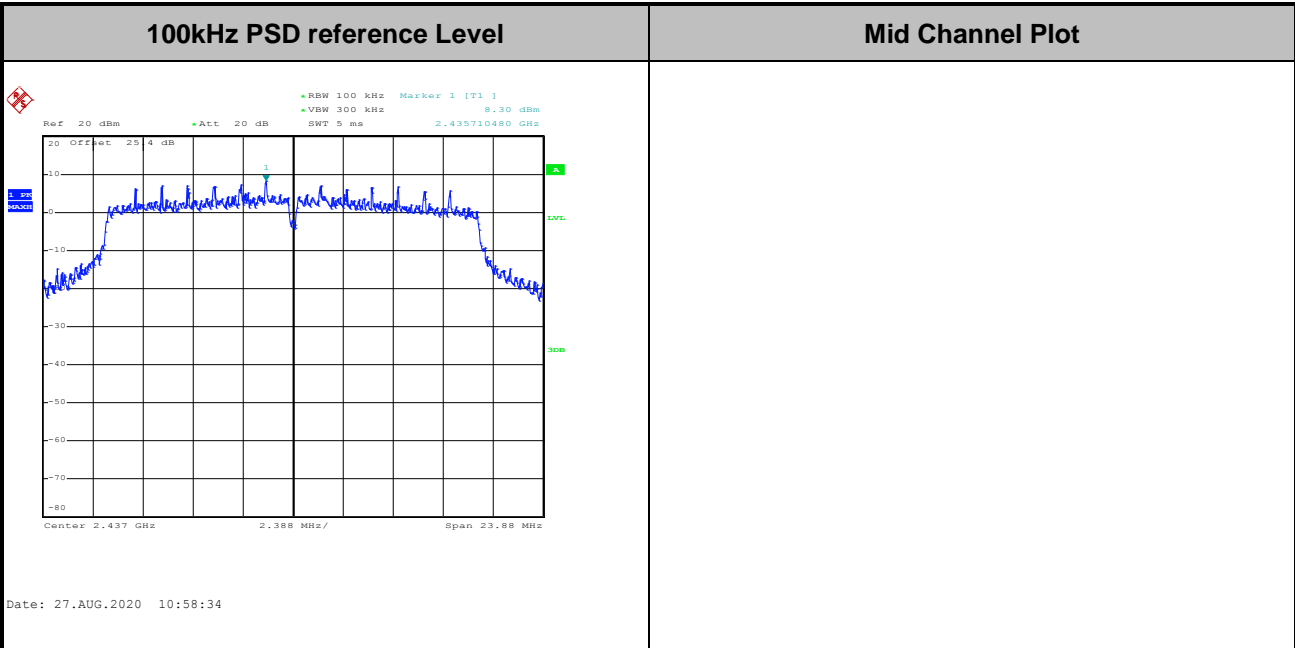



Test Mode :	802.11n HT20	Test Channel :	11
-------------	--------------	----------------	----

100kHz PSD reference Level	High Channel Plot
-----------------------------------	--------------------------

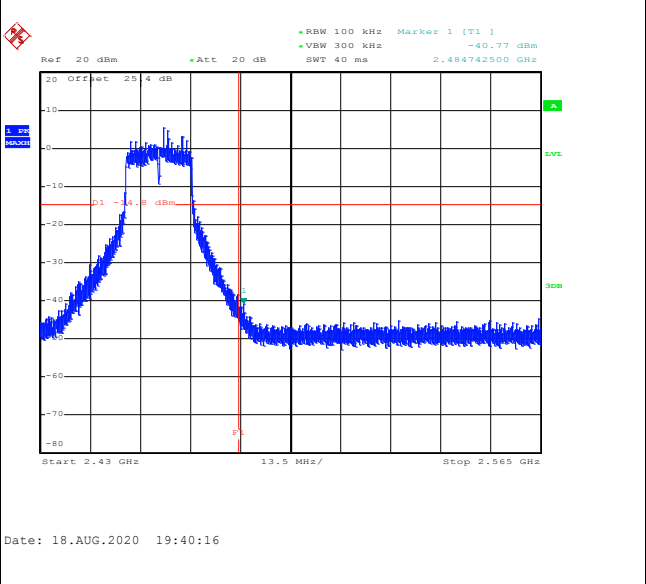
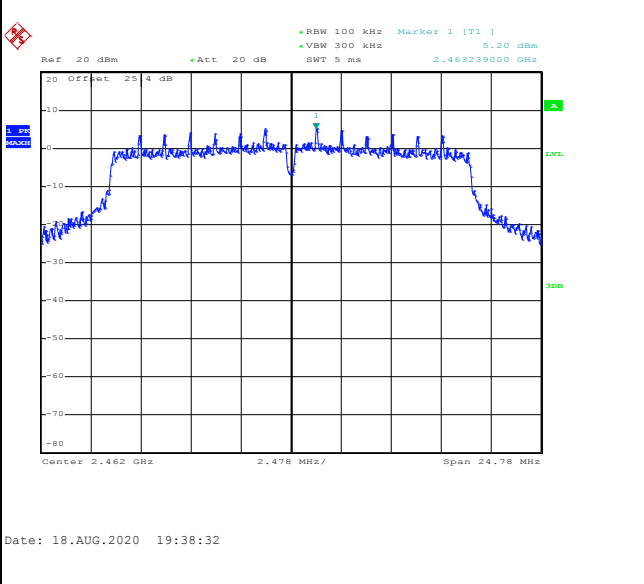

Spurious Emission 30MHz~3GHz	Spurious Emission 2GHz~25GHz
-------------------------------------	-------------------------------------

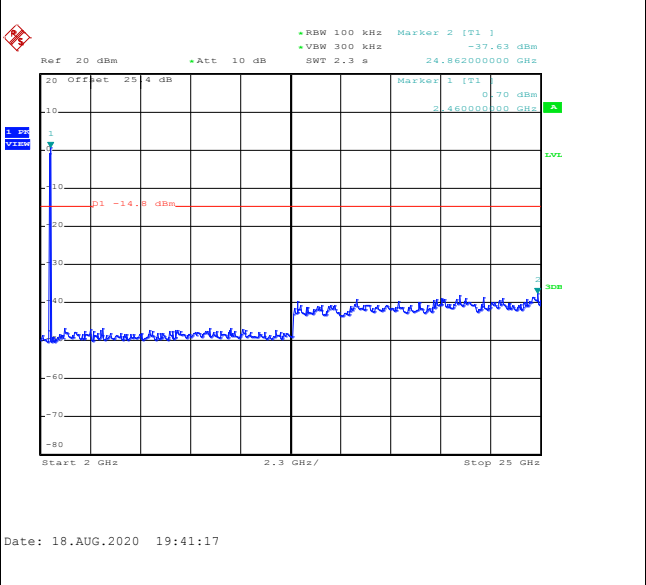
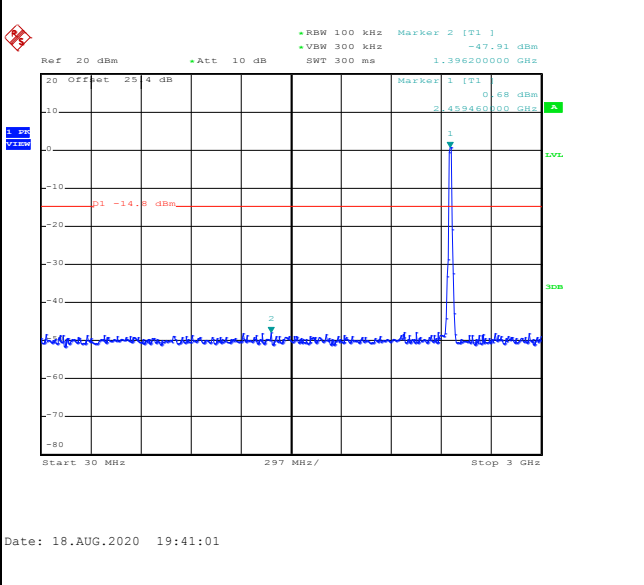



Test Mode :	802.11n HT40	Test Channel :	03
-------------	--------------	----------------	----

100kHz PSD reference Level	Low Channel Plot
-----------------------------------	-------------------------

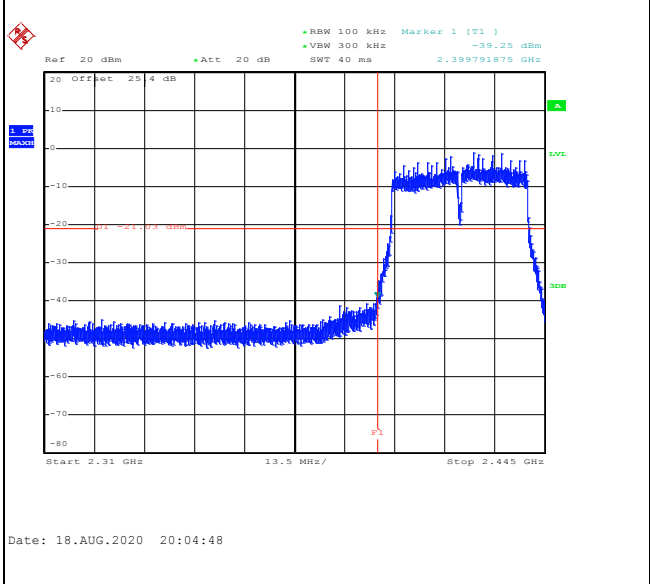
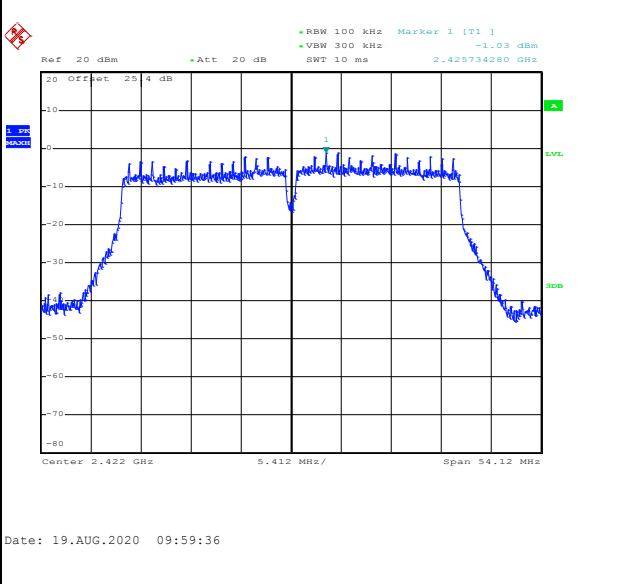

Spurious Emission 30MHz~3GHz	Spurious Emission 2GHz~25GHz
-------------------------------------	-------------------------------------

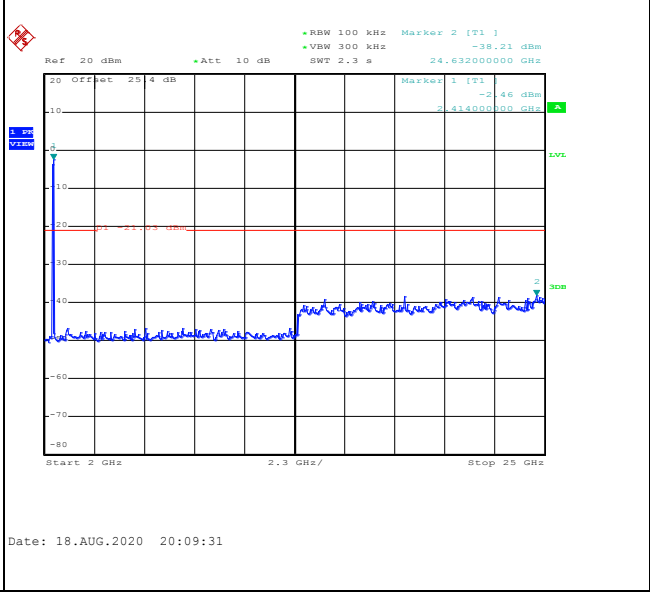
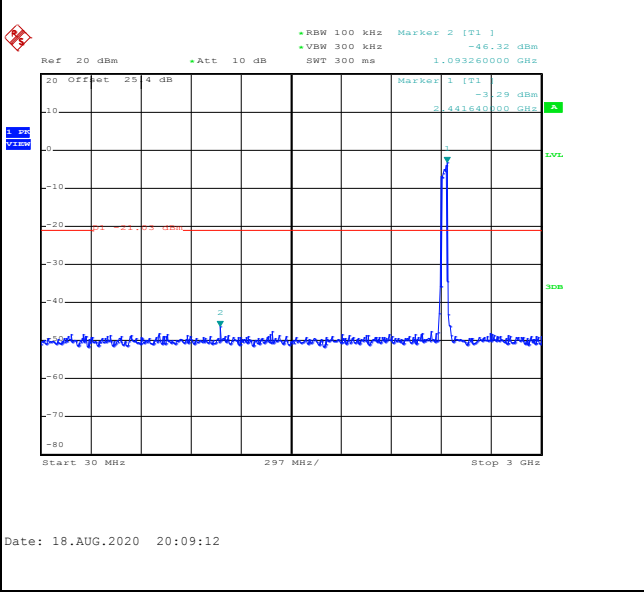



Test Mode :	802.11n HT40	Test Channel :	06
-------------	--------------	----------------	----

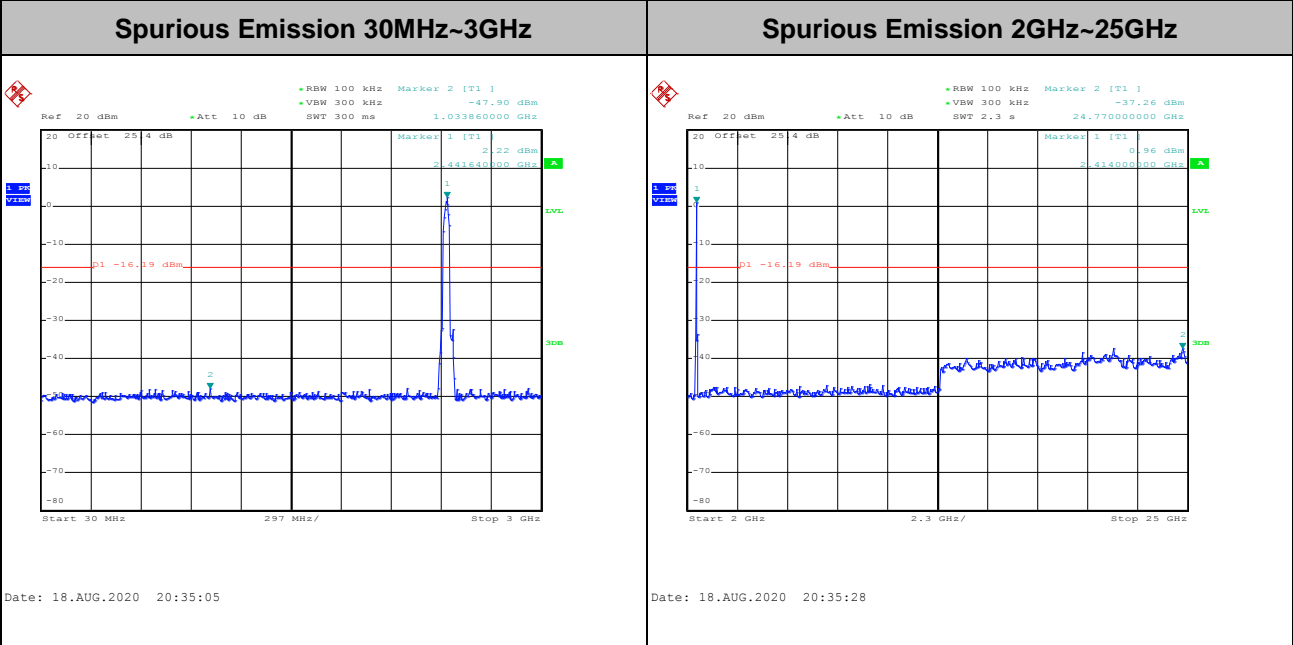
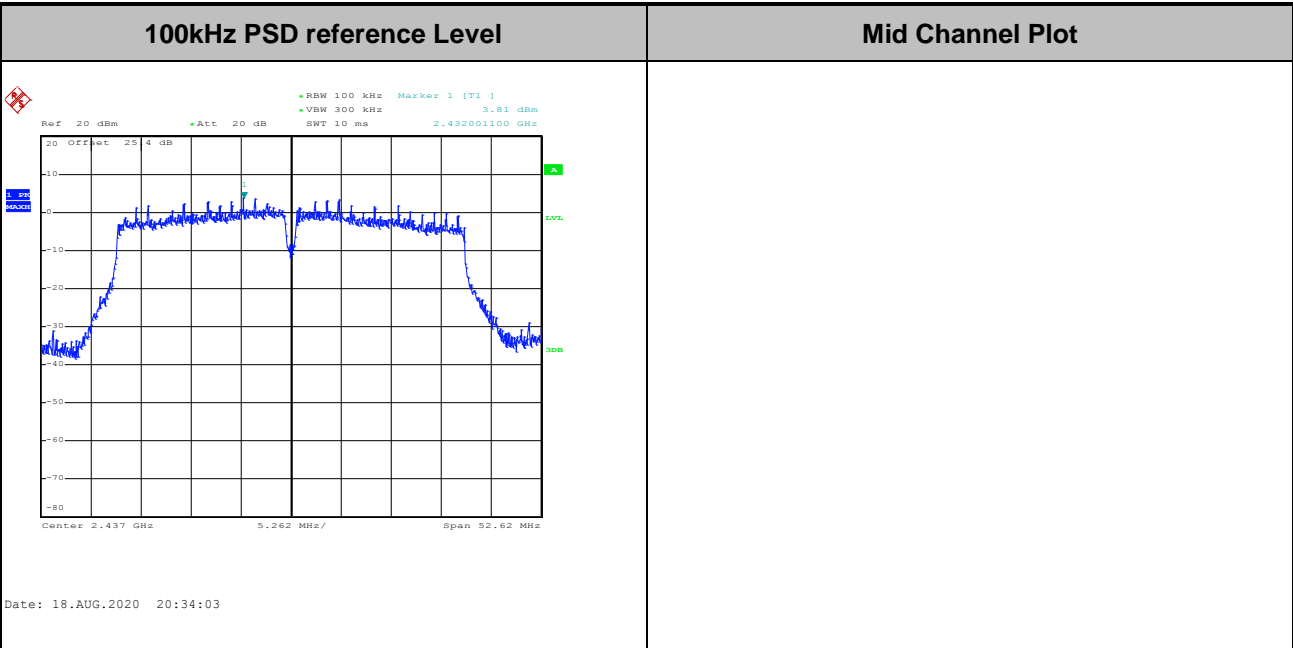



Test Mode :	802.11n HT40	Test Channel :	09
-------------	--------------	----------------	----

100kHz PSD reference Level	High Channel Plot
-----------------------------------	--------------------------

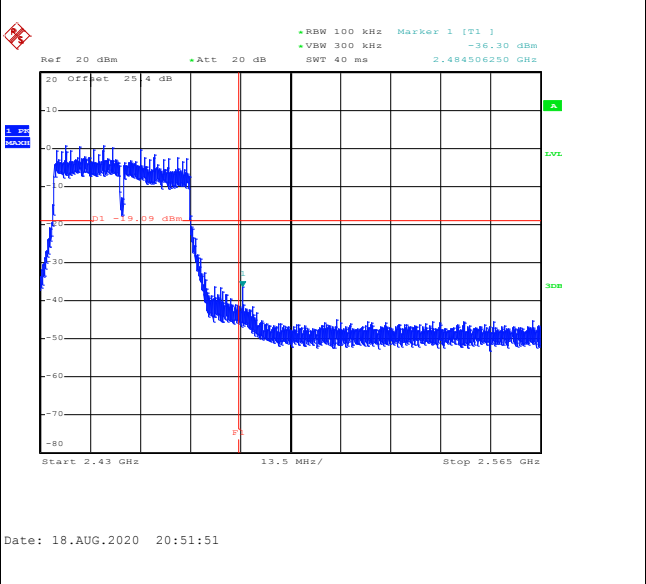
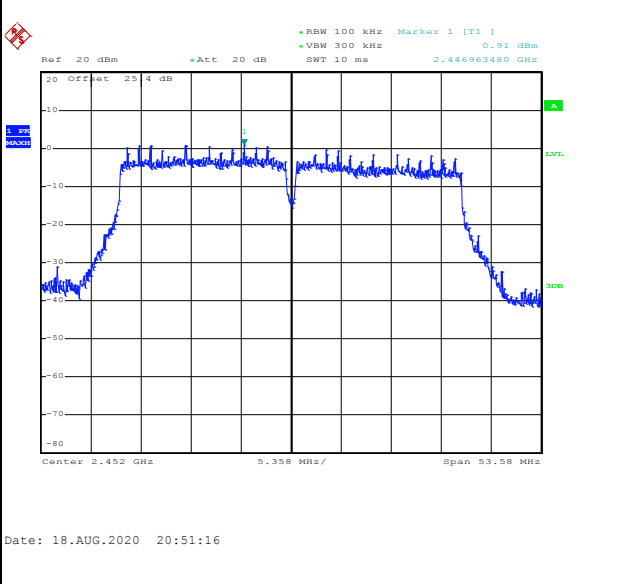

Spurious Emission 30MHz~3GHz	Spurious Emission 2GHz~25GHz
-------------------------------------	-------------------------------------

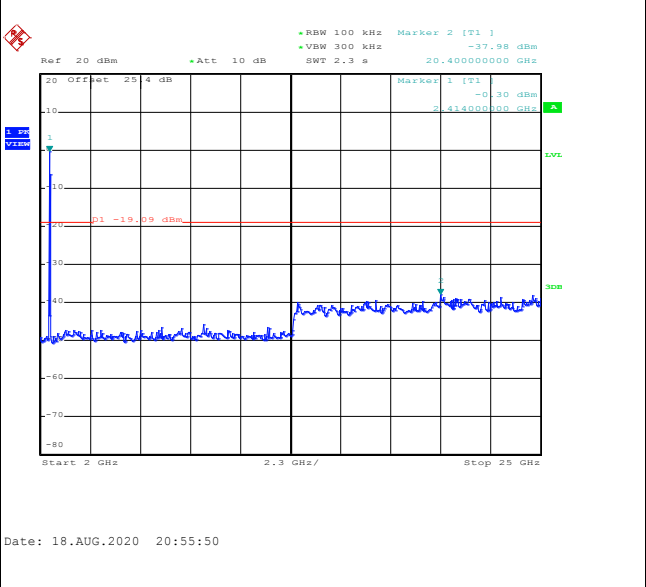
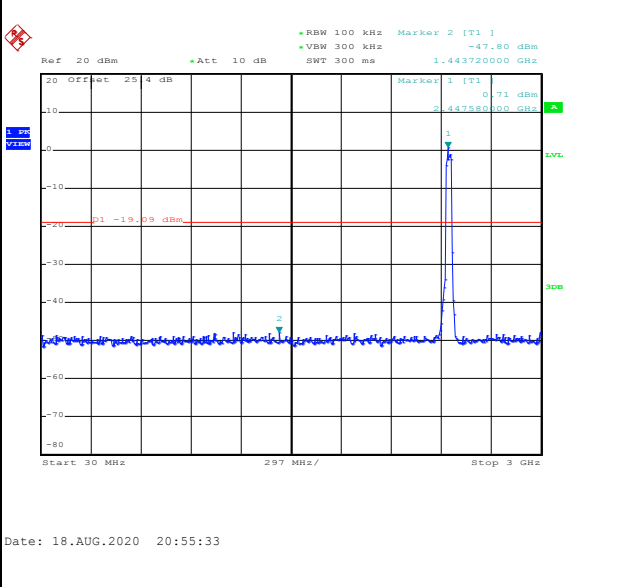



Number of TX = 2, Ant. 1 (Measured)

Test Mode :	802.11b	Test Channel :	01
-------------	---------	----------------	----

100kHz PSD reference Level	Low Channel Plot
-----------------------------------	-------------------------

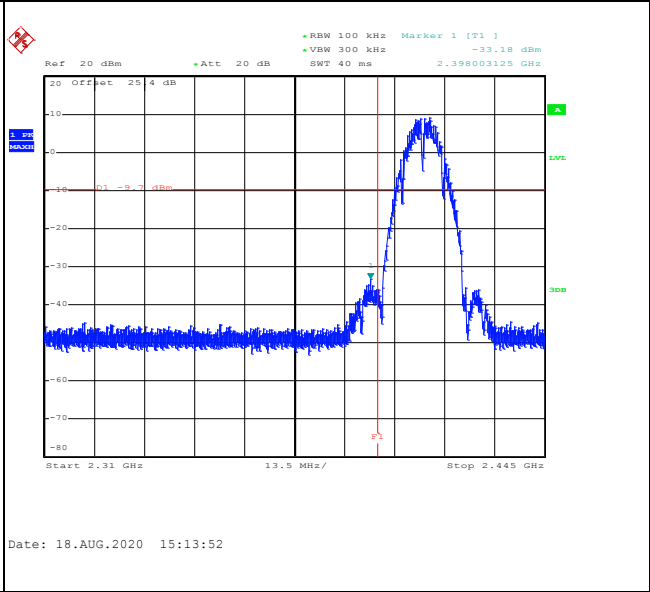
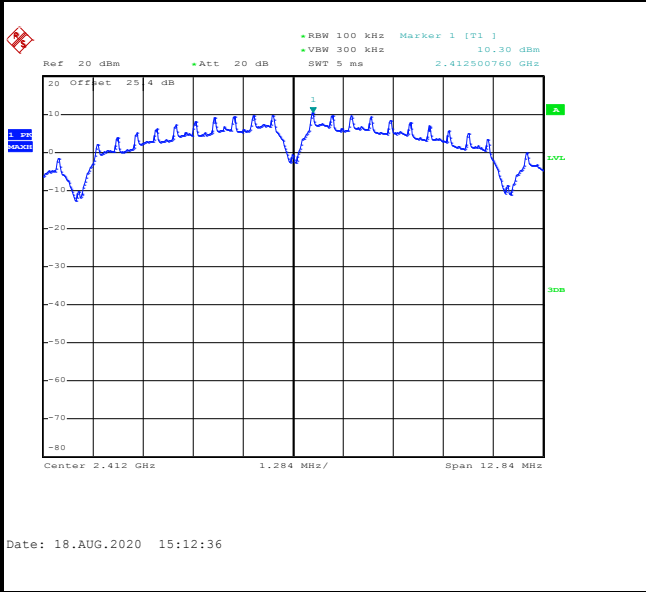

Spurious Emission 30MHz~3GHz

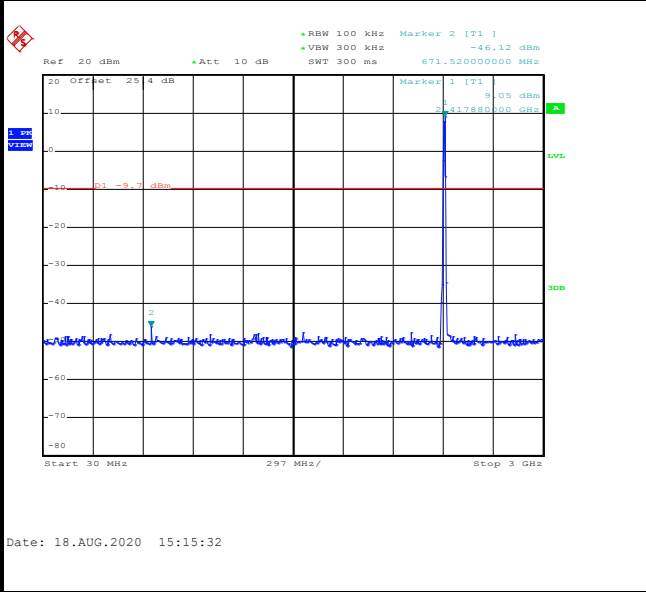

Spurious Emission 2GHz~25GHz

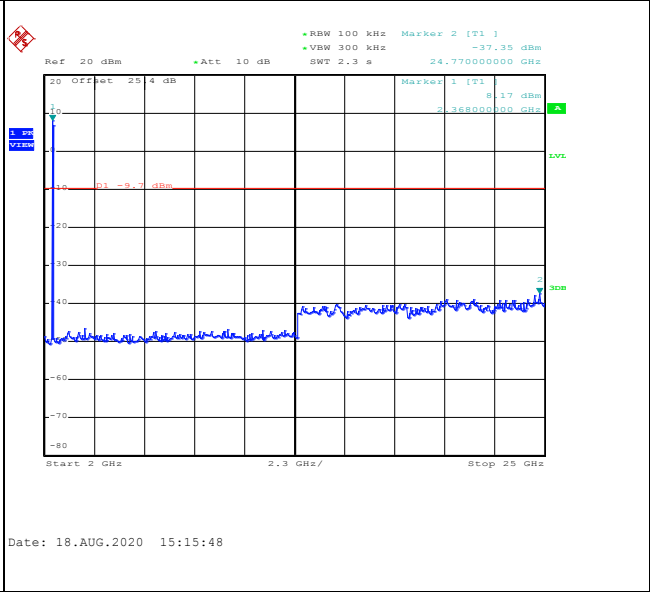



Test Mode :	802.11b	Test Channel :	06
-------------	---------	----------------	----

100kHz PSD reference Level	Mid Channel Plot
-----------------------------------	-------------------------

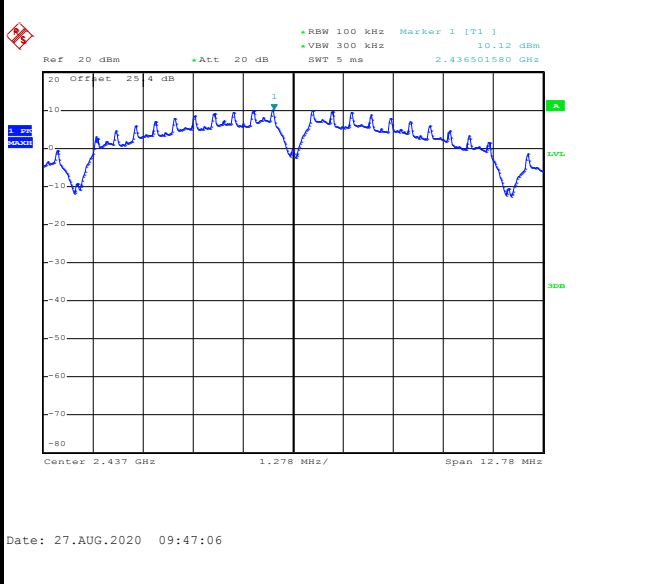

Spurious Emission 30MHz~3GHz	Spurious Emission 2GHz~25GHz
-------------------------------------	-------------------------------------

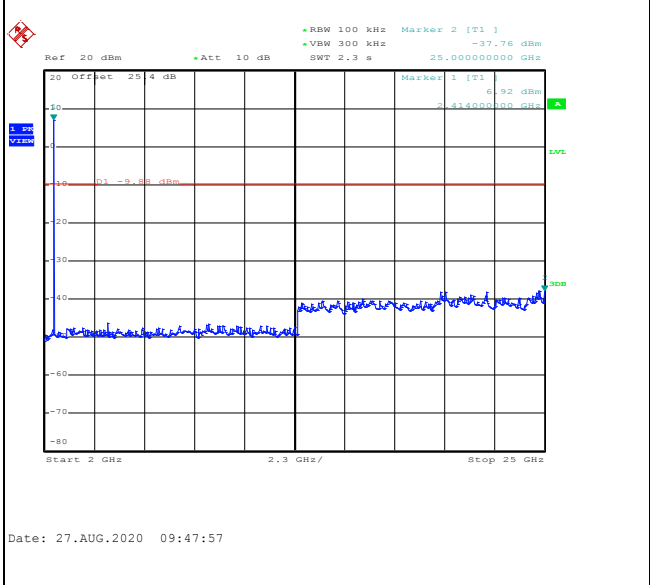
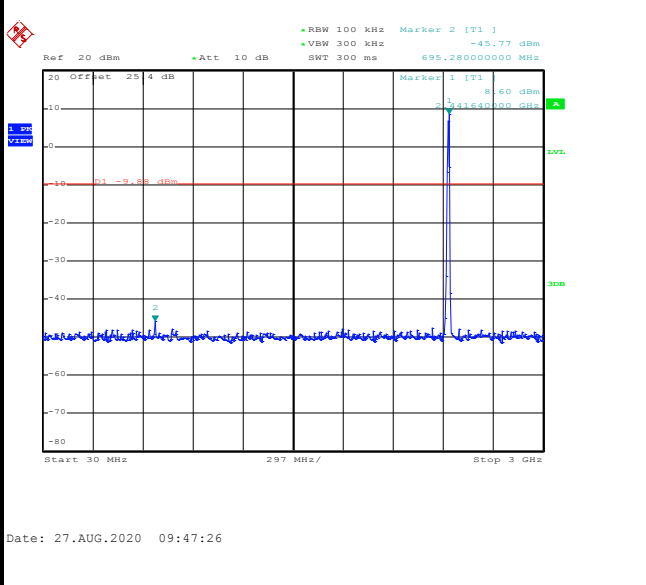



Test Mode :	802.11b	Test Channel :	11
-------------	---------	----------------	----

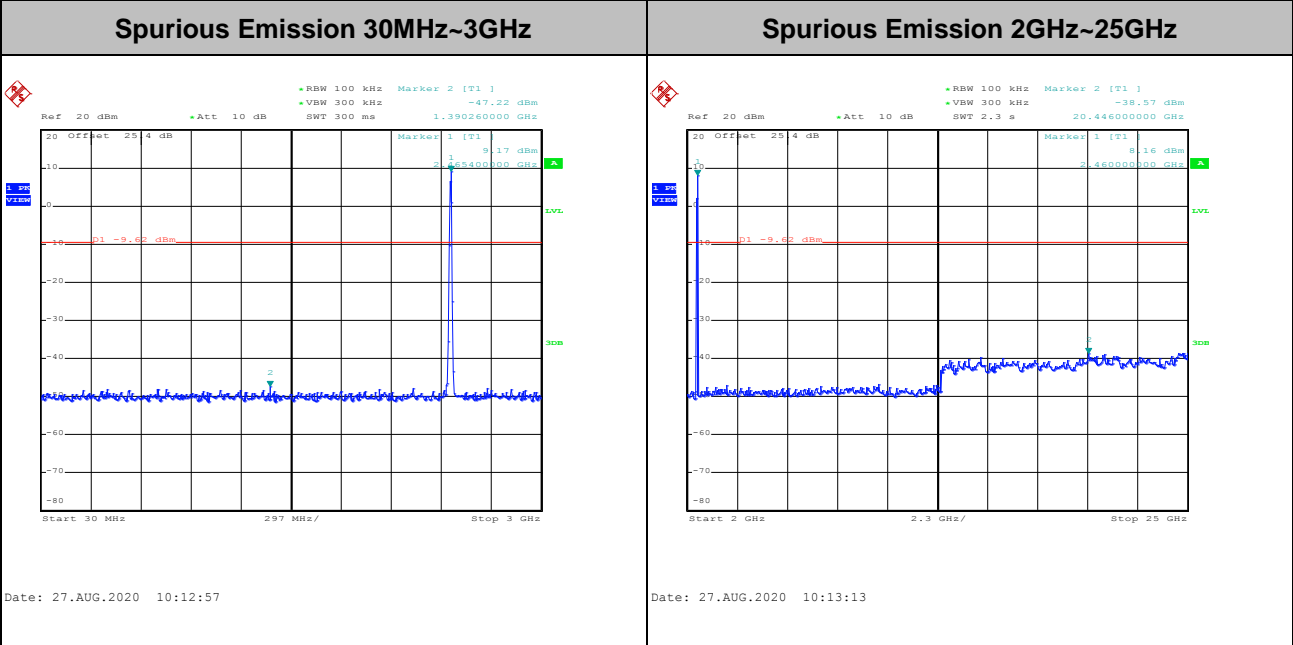
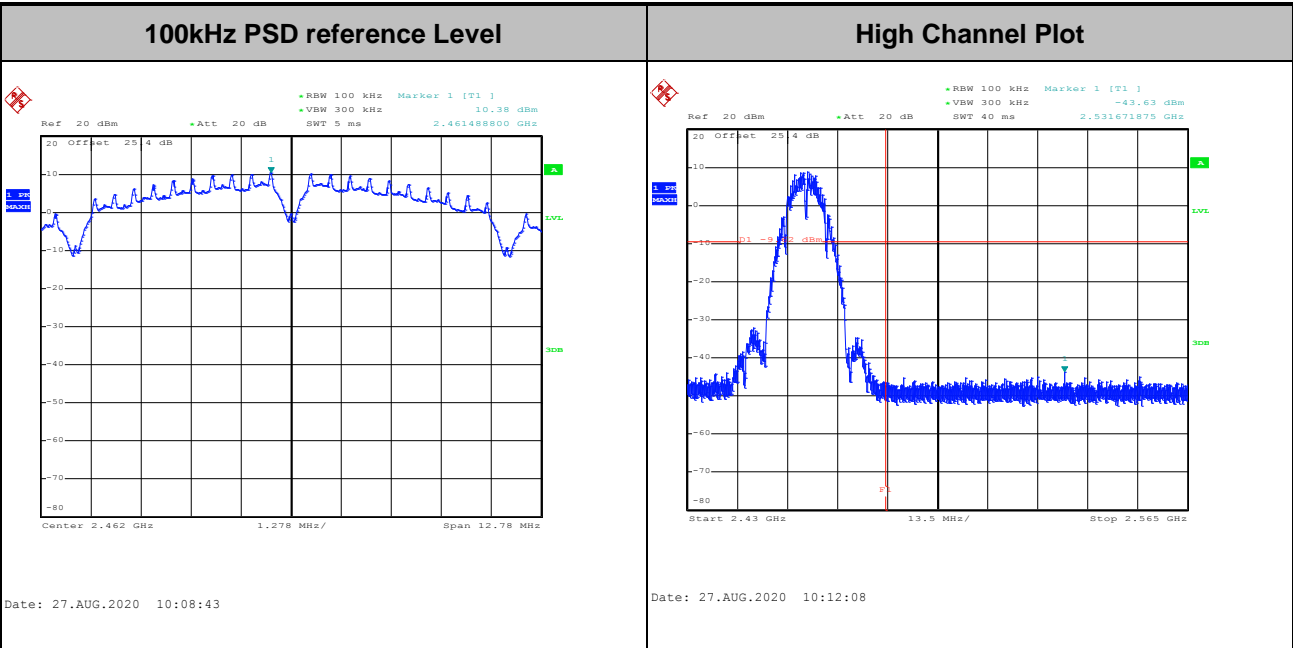



Test Mode :	802.11g	Test Channel :	01
-------------	---------	----------------	----

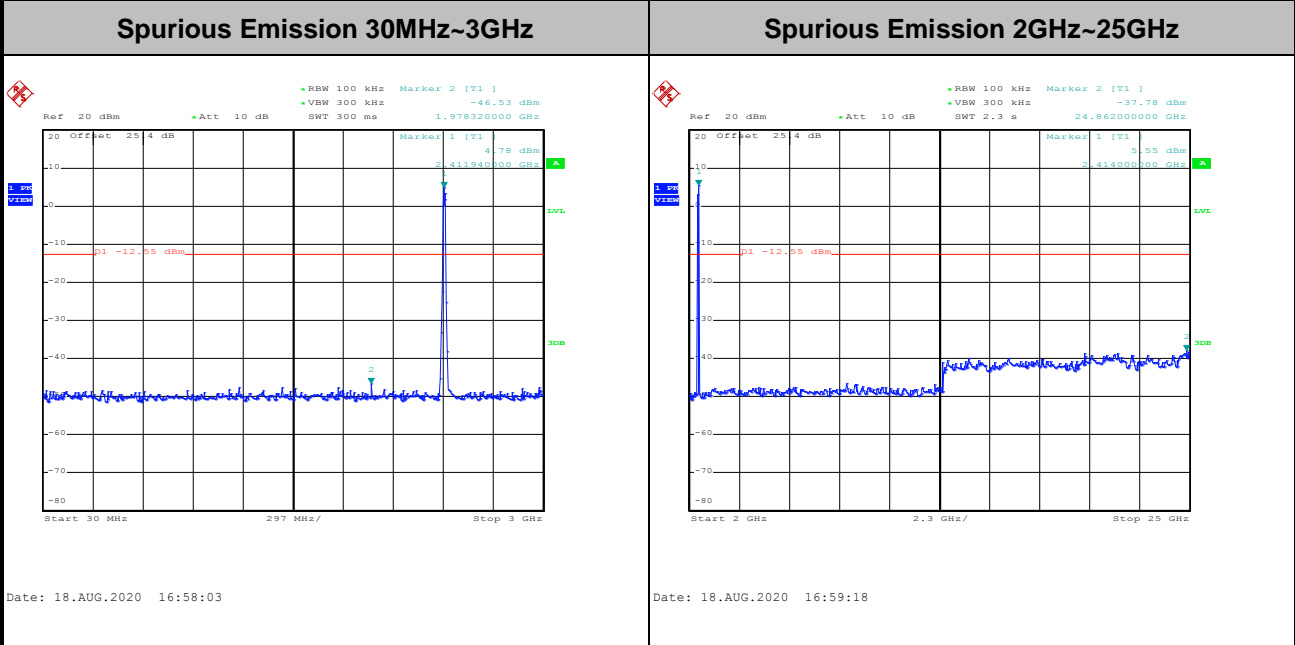
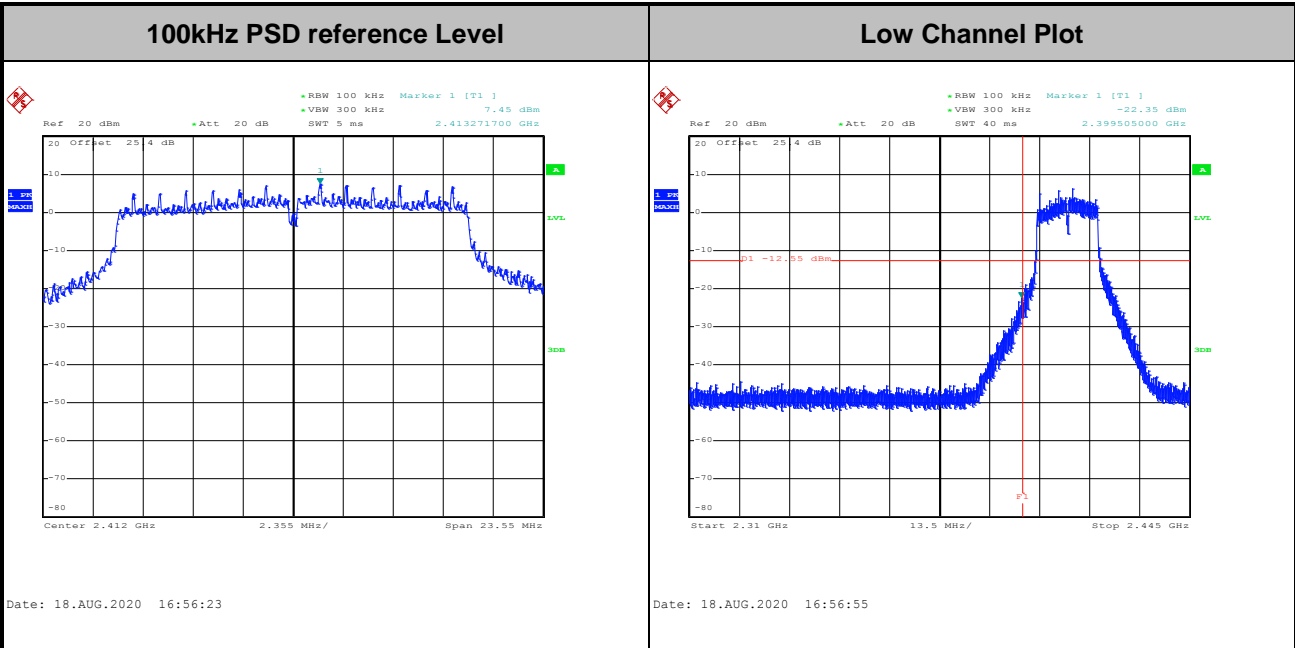



Test Mode :	802.11g	Test Channel :	06
-------------	---------	----------------	----

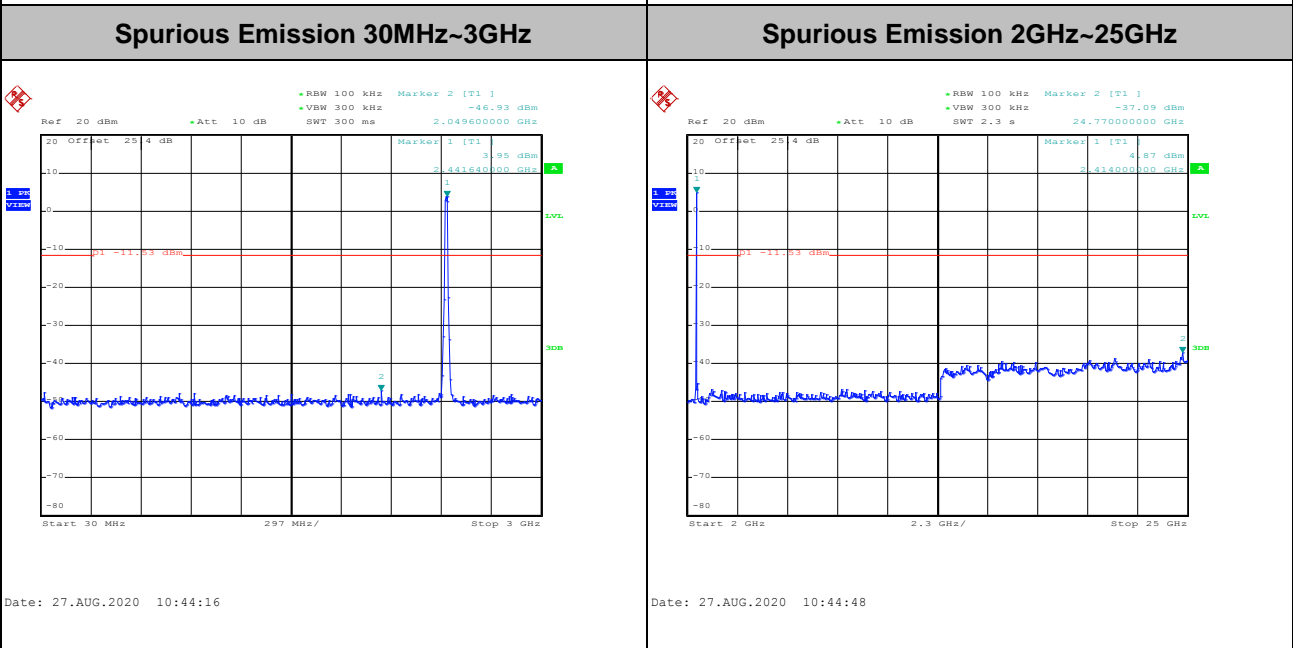
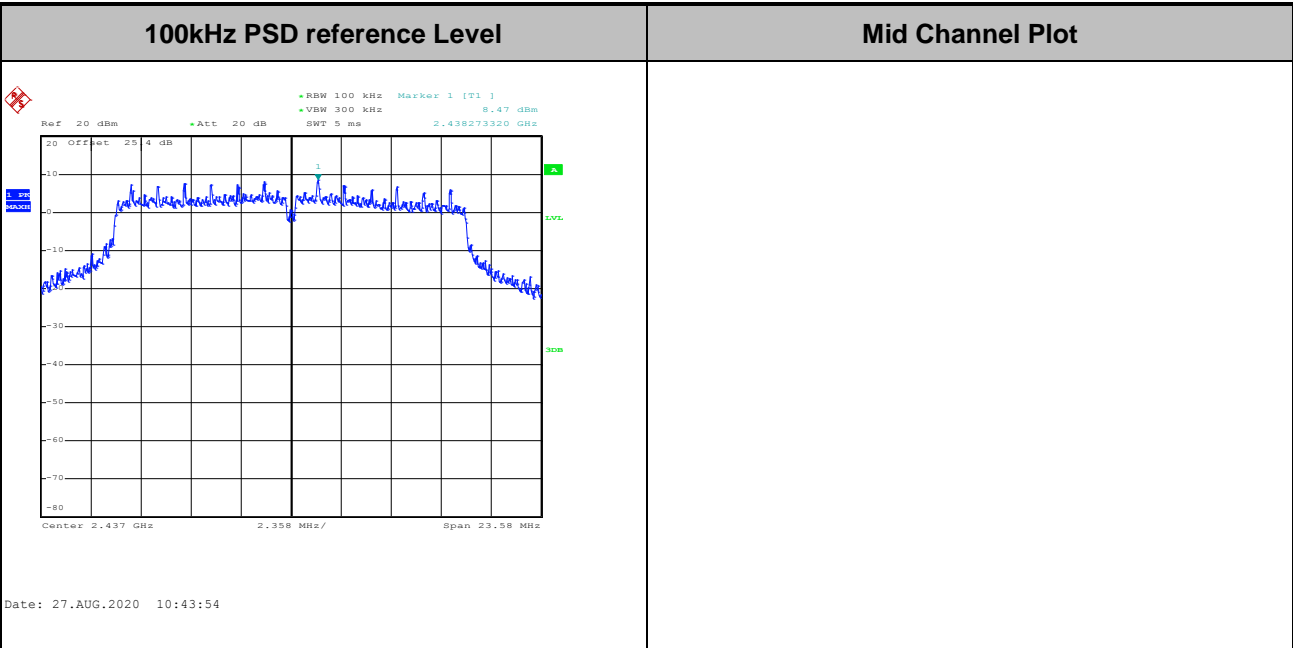



Test Mode :	802.11g	Test Channel :	11
-------------	---------	----------------	----

100kHz PSD reference Level	High Channel Plot
-----------------------------------	--------------------------

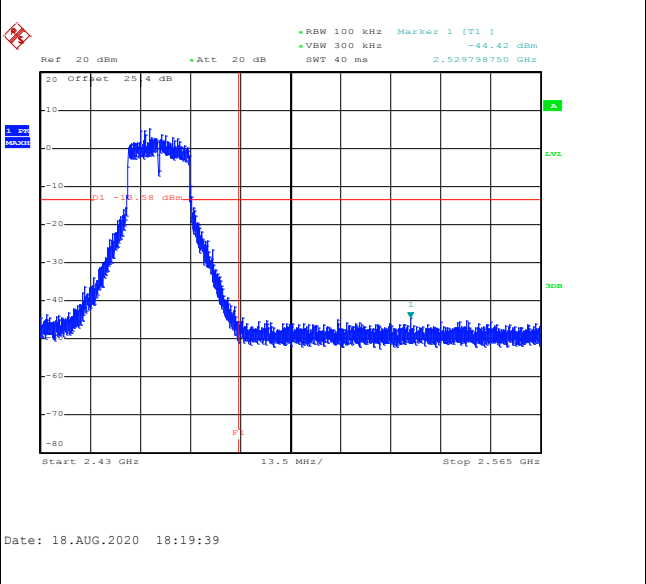
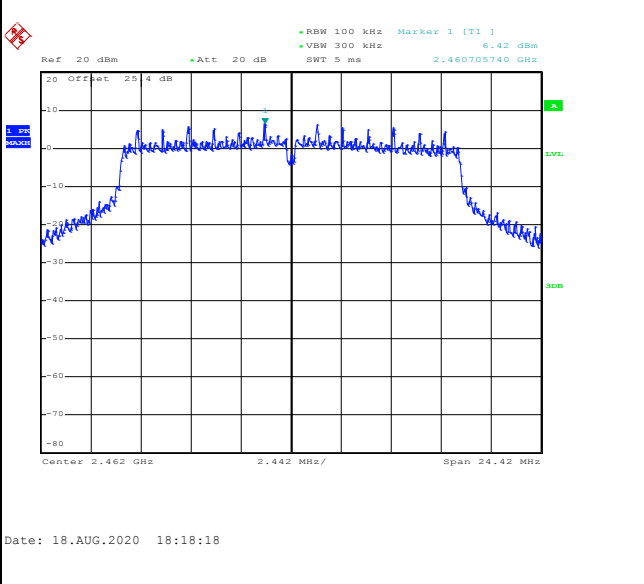

Spurious Emission 30MHz~3GHz	Spurious Emission 2GHz~25GHz
-------------------------------------	-------------------------------------

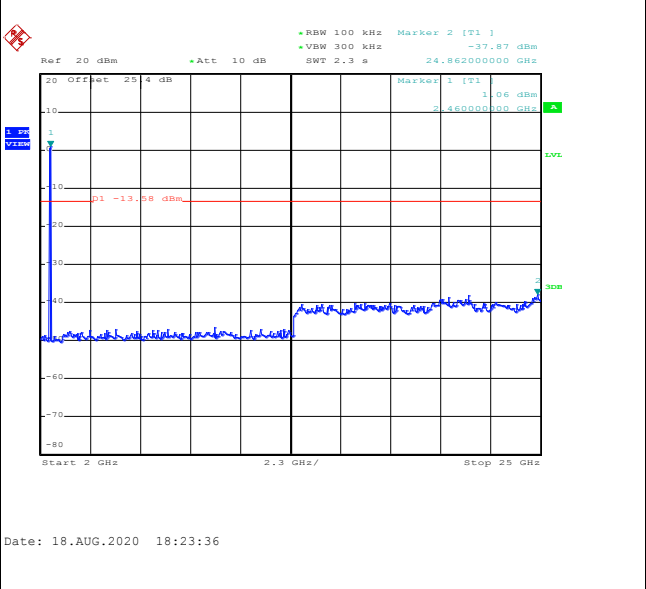
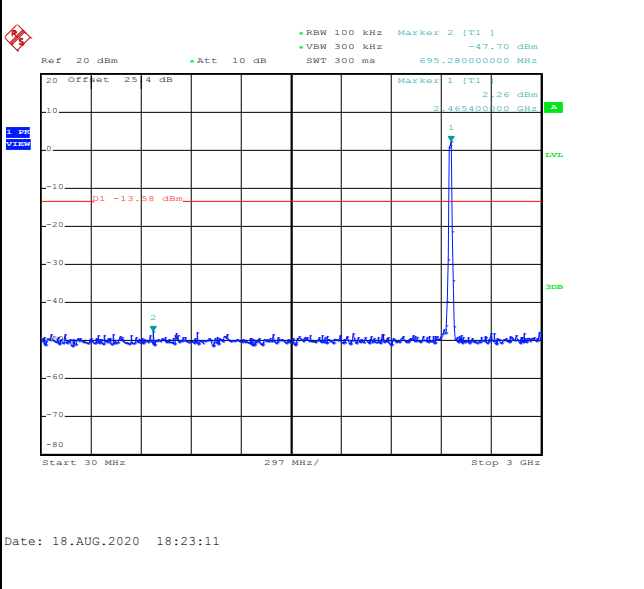



Test Mode :	802.11n HT20	Test Channel :	01
-------------	--------------	----------------	----

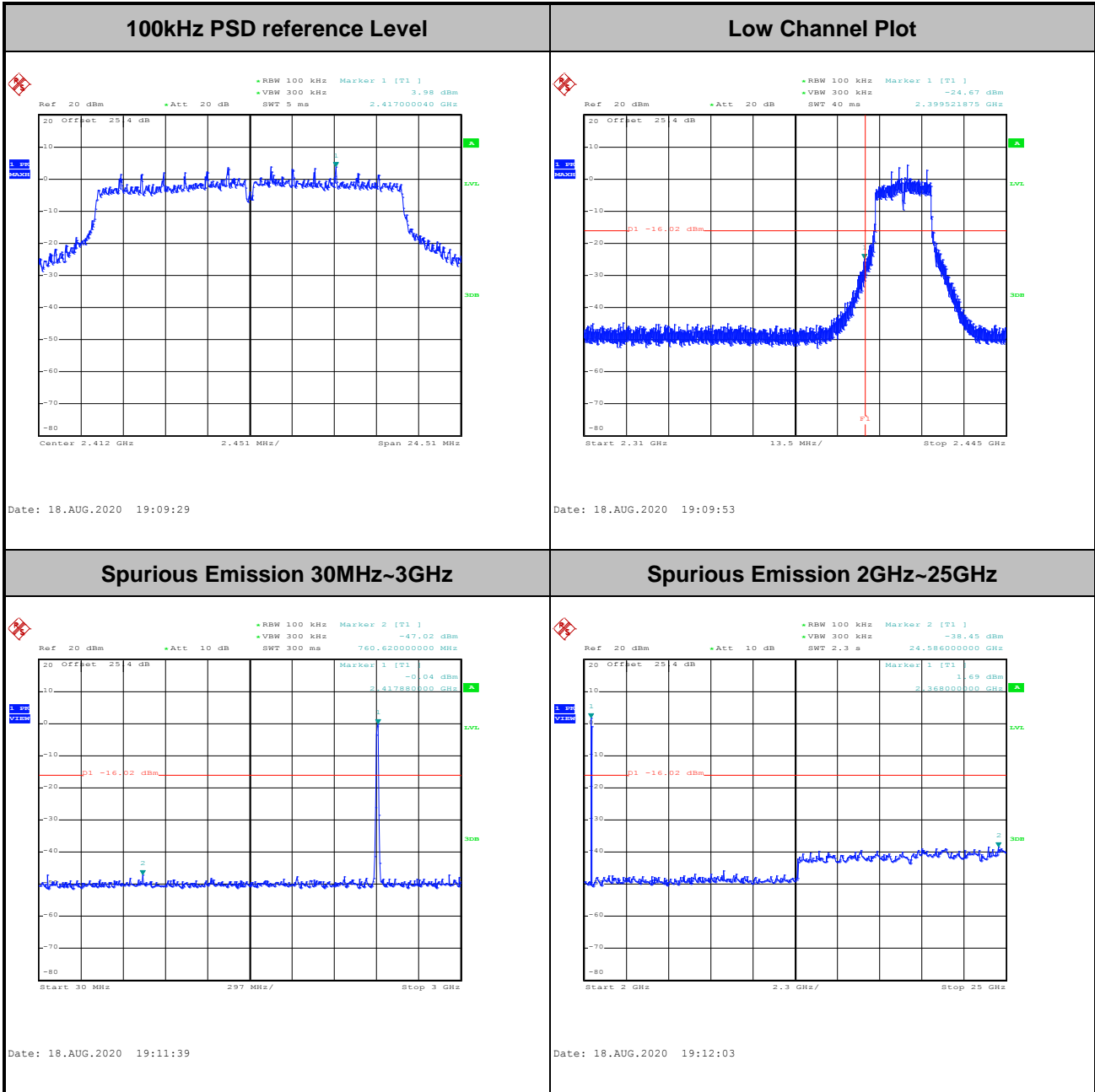



Test Mode :	802.11n HT20	Test Channel :	06
-------------	--------------	----------------	----

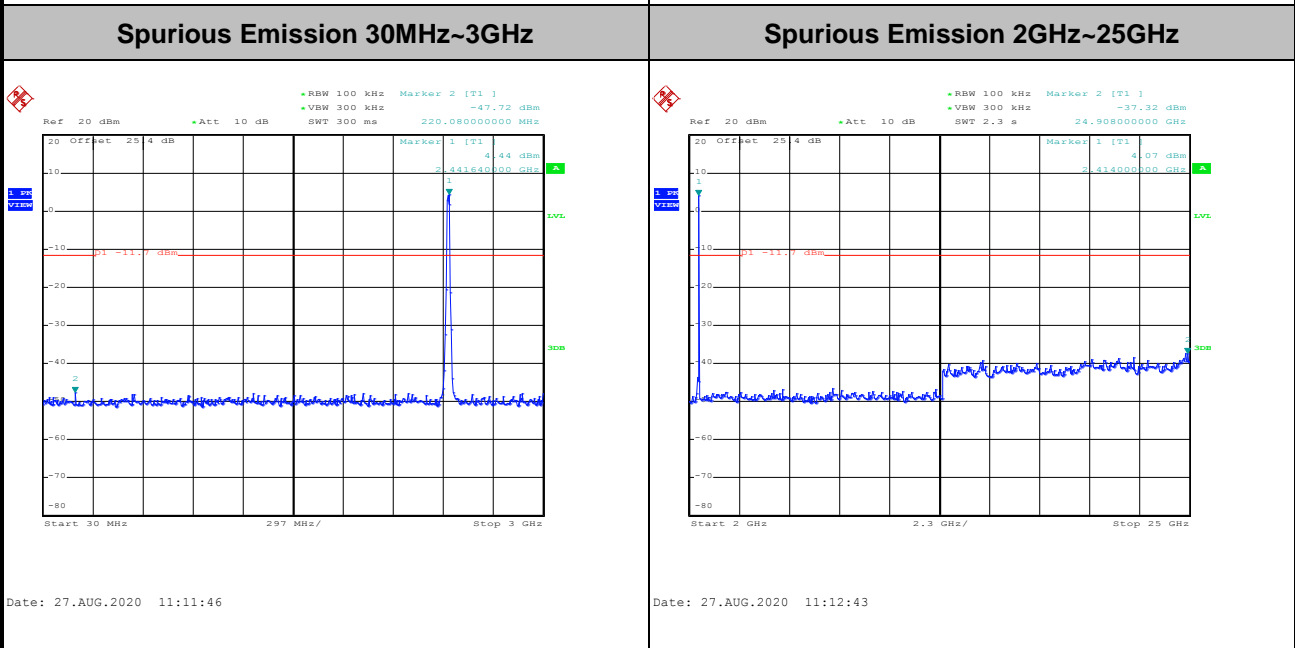
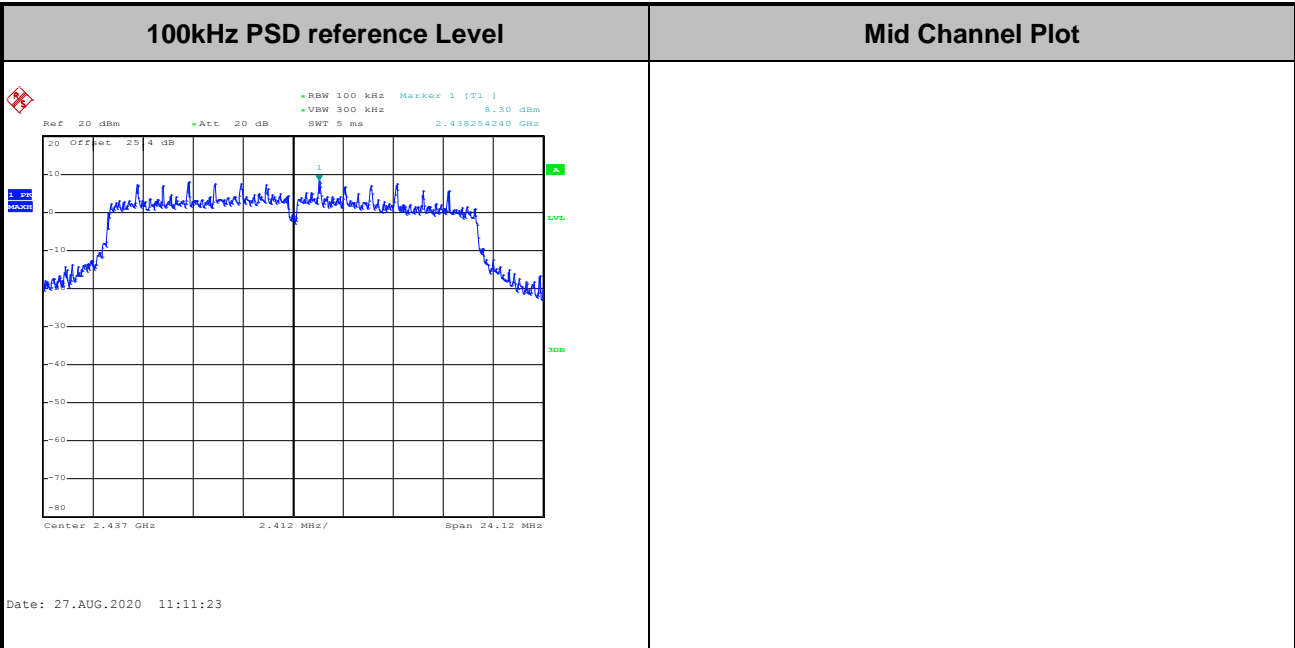



Test Mode :	802.11n HT20	Test Channel :	11
-------------	--------------	----------------	----

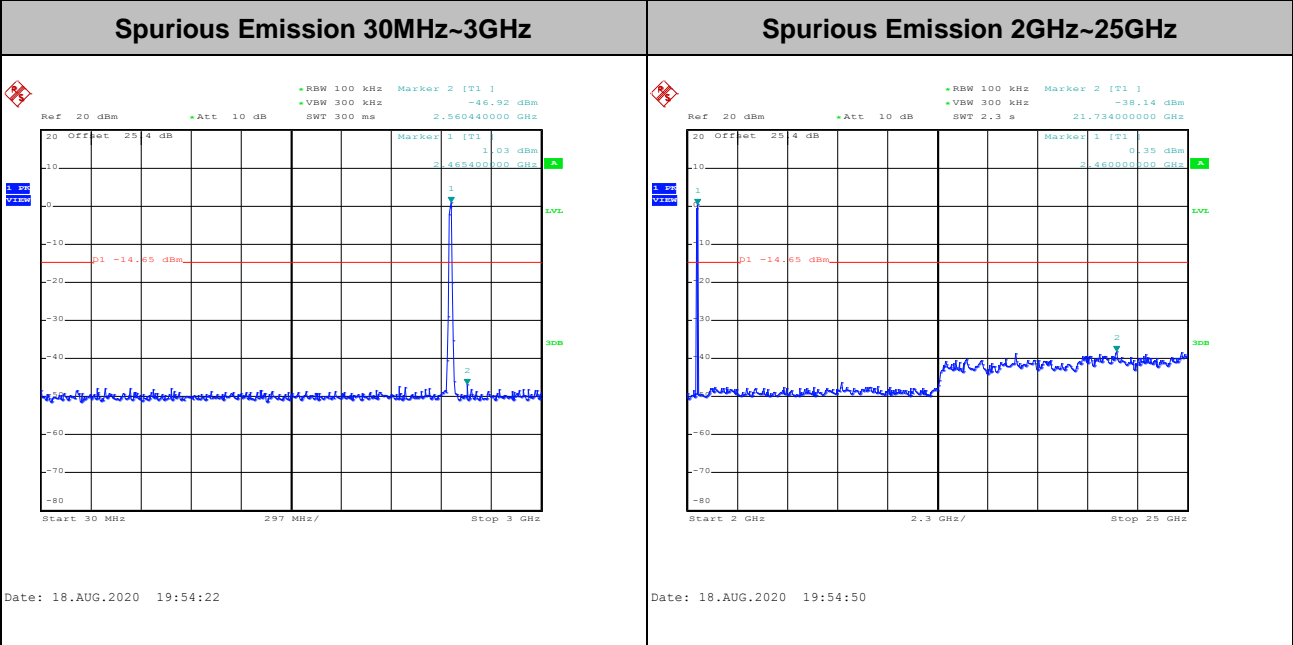
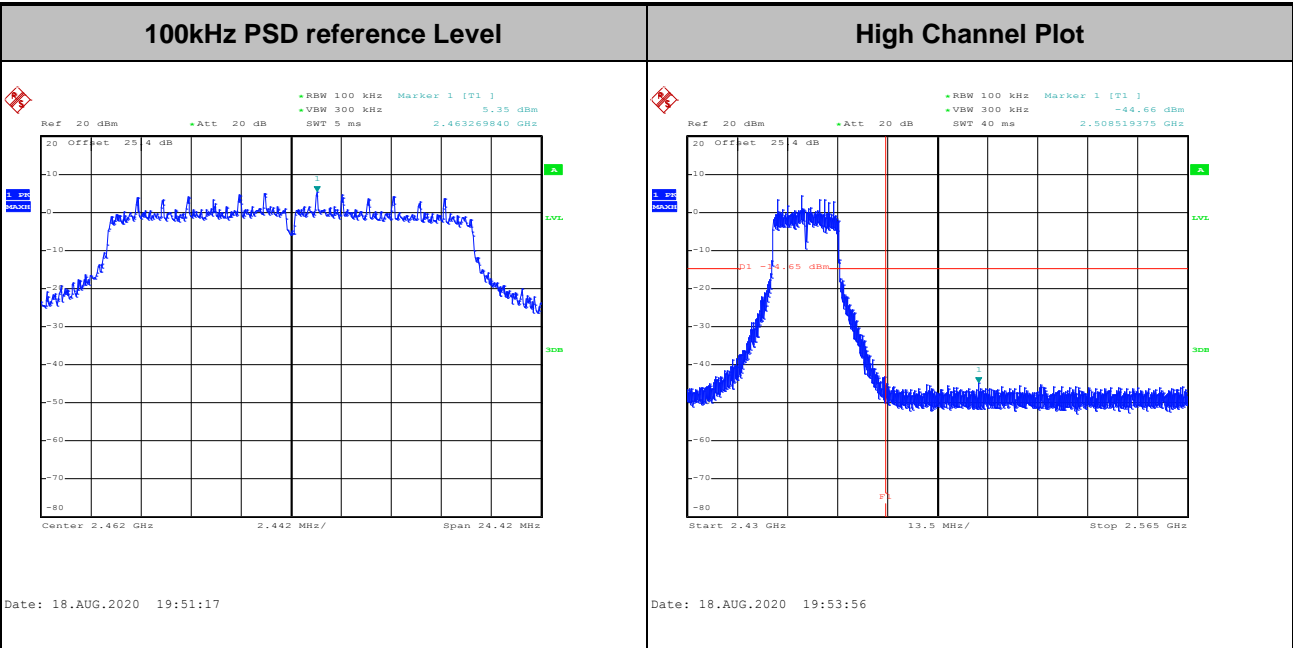



Test Mode :	802.11n HT40	Test Channel :	03
-------------	--------------	----------------	----

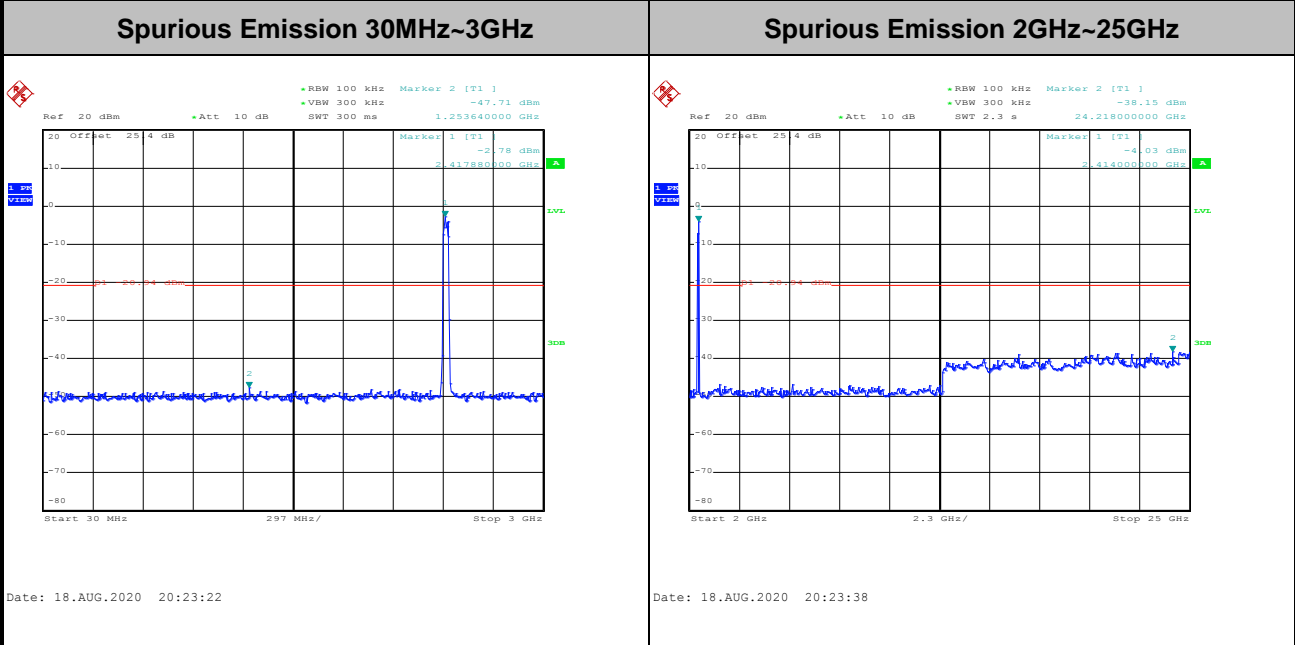
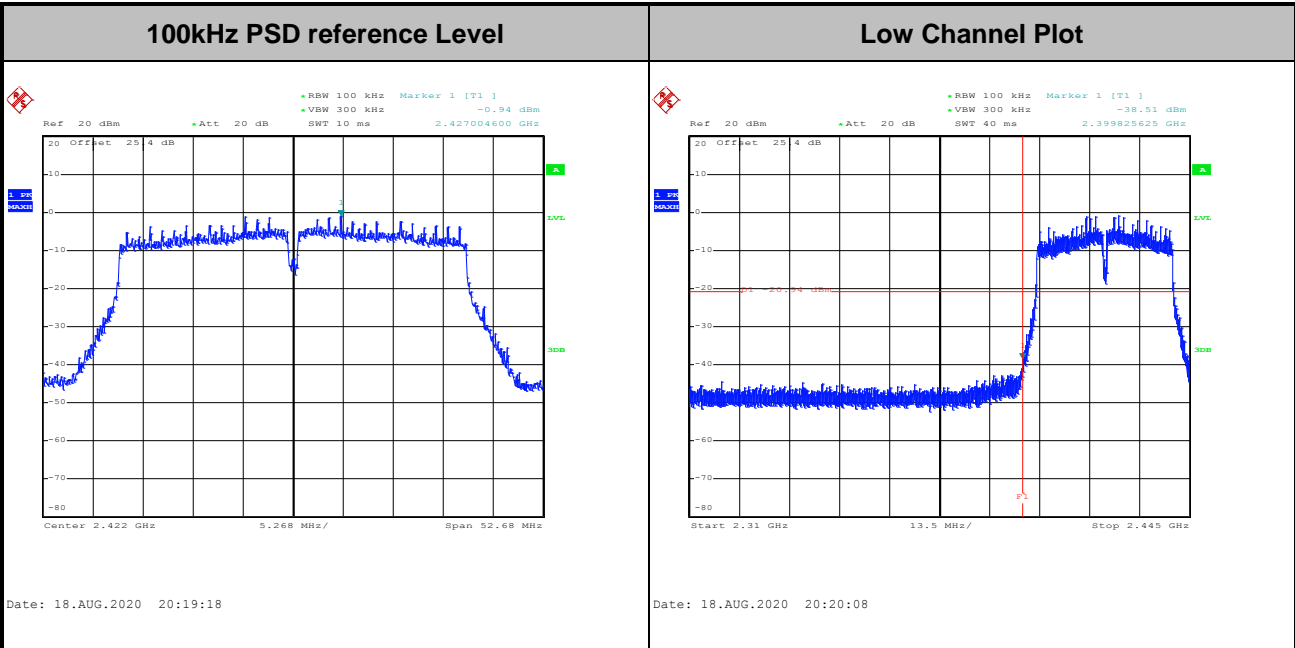



Test Mode :	802.11n HT40	Test Channel :	06
-------------	--------------	----------------	----

100kHz PSD reference Level	Mid Channel Plot
-----------------------------------	-------------------------

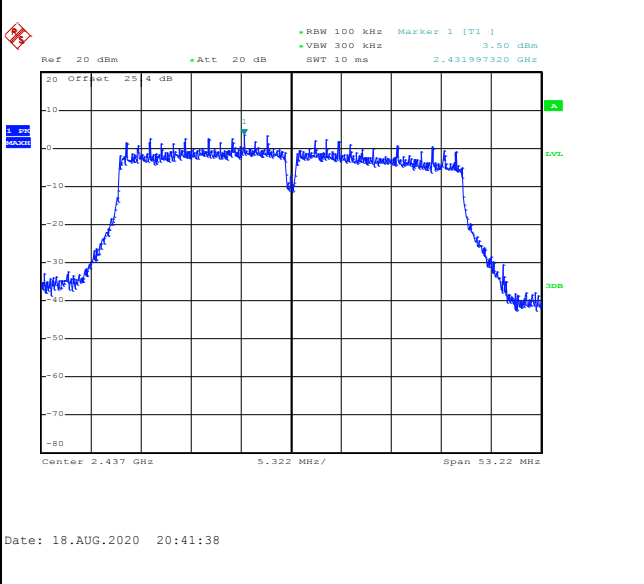

Spurious Emission 30MHz~3GHz	Spurious Emission 2GHz~25GHz
-------------------------------------	-------------------------------------

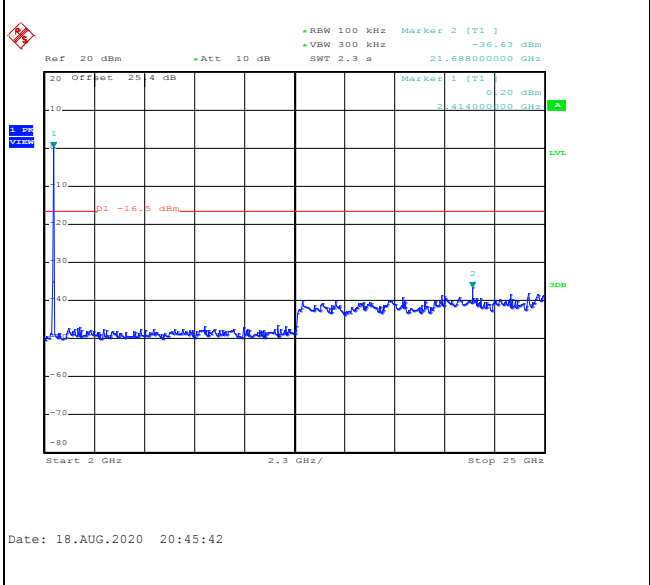
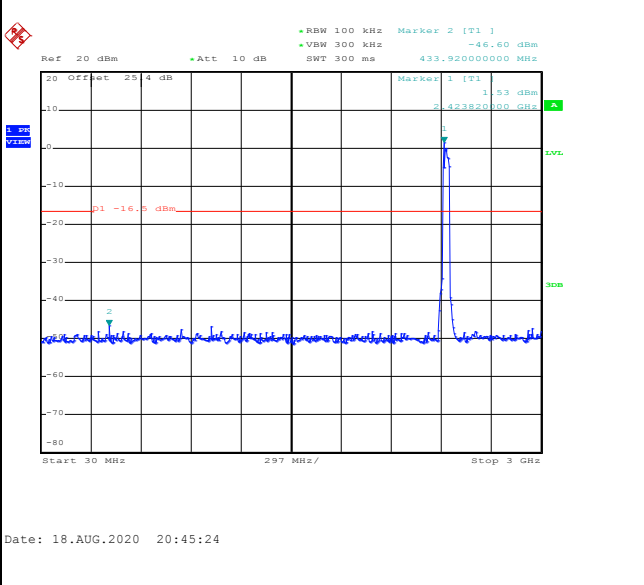



Test Mode :	802.11n HT40	Test Channel :	09
-------------	--------------	----------------	----

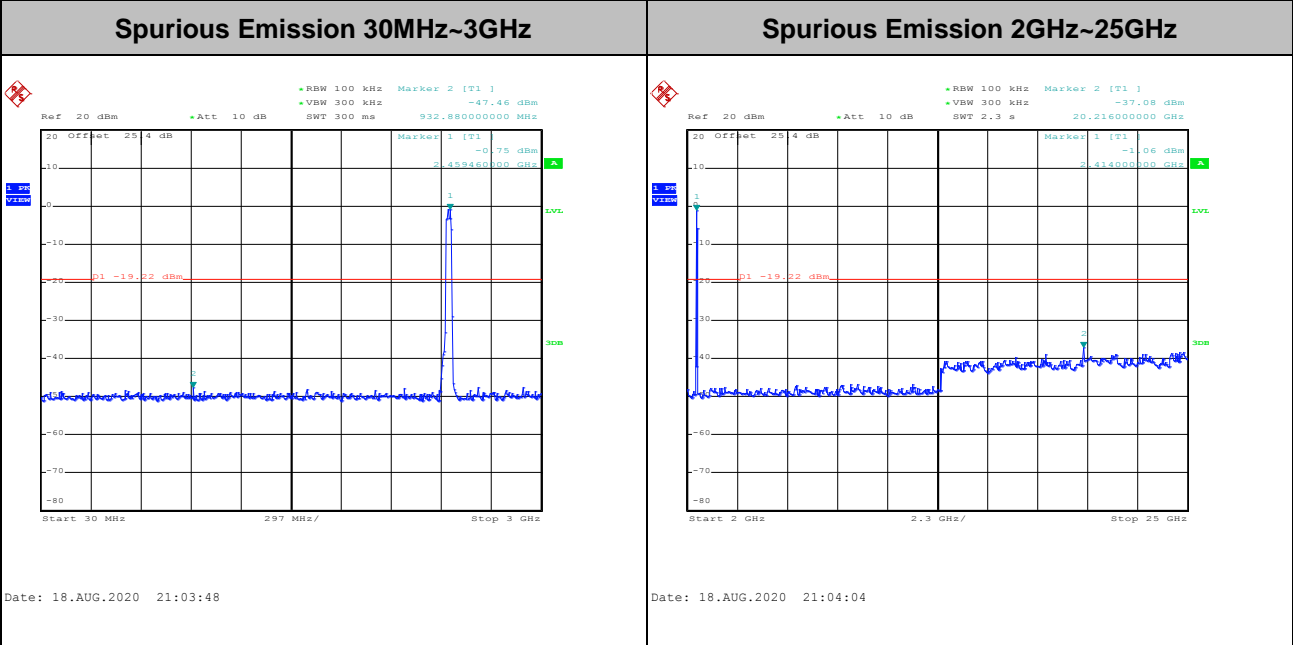
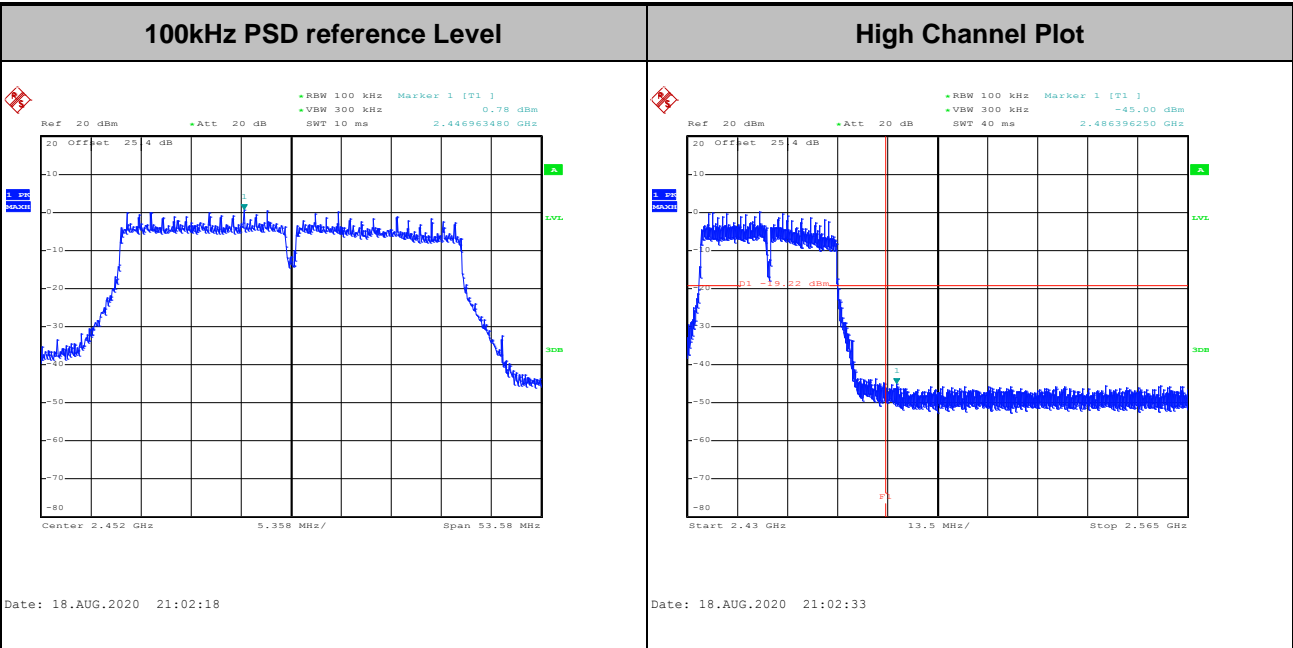



3.5 Radiated Band Edges and Spurious Emission Measurement

3.5.1 Limit of Radiated band edge and Spurious Emission Measurement

In any 100 kHz bandwidth outside the intentional radiator frequency band, all harmonics/spurious must be at least 20 dB below the highest emission level within the authorized band. If the output power of this device was measured by spectrum analyzer, the attenuation under this paragraph shall be 30 dB instead of 20 dB. In addition, radiated emissions which fall in the restricted bands must also comply with the limits as below.

Frequency (MHz)	Field Strength (microvolts/meter)	Measurement Distance (meters)
0.009 – 0.490	2400/F(kHz)	300
0.490 – 1.705	24000/F(kHz)	30
1.705 – 30.0	30	30
30 – 88	100	3
88 – 216	150	3
216 - 960	200	3
Above 960	500	3

3.5.2 Measuring Instruments

See list of measuring equipment of this test report.



3.5.3 Test Procedures

1. The testing follows the ANSI C63.10 Section 11.12.1 Radiated emission measurements.
2. The EUT was arranged to its worst case and then tune the antenna tower (from 1 m to 4 m) and turntable (from 0 degree to 360 degrees) to find the maximum reading. A pre-amp and a high pass filter are used for the test in order to get better signal level.
3. The EUT was placed on a turntable with 0.8 meter for frequency below 1GHz and 1.5 meter for frequency above 1GHz respectively above ground.
4. The EUT was set 3 meters from the interference receiving antenna, which was mounted on the top of a variable height antenna tower.
5. Corrected Reading: Antenna Factor + Cable Loss + Read Level - Preamp Factor = Level
6. For testing below 1GHz, if the emission level of the EUT in peak mode was 3 dB lower than the limit specified, then peak values of EUT will be reported, otherwise, the emissions will be repeated one by one using the CISPR quasi-peak method and reported.
7. For testing above 1GHz, the emission level of the EUT in peak mode was 20dB lower than average limit (that means the emission level in average mode also complies with the limit in average mode), then peak values of EUT will be reported, otherwise, the emissions will be measured in average mode again and reported.
8. Use the following spectrum analyzer settings:
 - (1) Span shall wide enough to fully capture the emission being measured;
 - (2) Set RBW=100 kHz for $f < 1$ GHz; $VBW \geq RBW$; Sweep = auto; Detector function = peak; Trace = max hold;
 - (3) Set RBW = 1 MHz, VBW= 3MHz for $f \geq 1$ GHz for peak measurement.
For average measurement:
 - $VBW = 10$ Hz, when duty cycle is no less than 98 percent.
 - $VBW \geq 1/T$, when duty cycle is less than 98 percent where T is the minimum transmission duration over which the transmitter is on and is transmitting at its maximum power control level for the tested mode of operation.

3.5.4 Test Setup

For radiated emissions below 30MHz

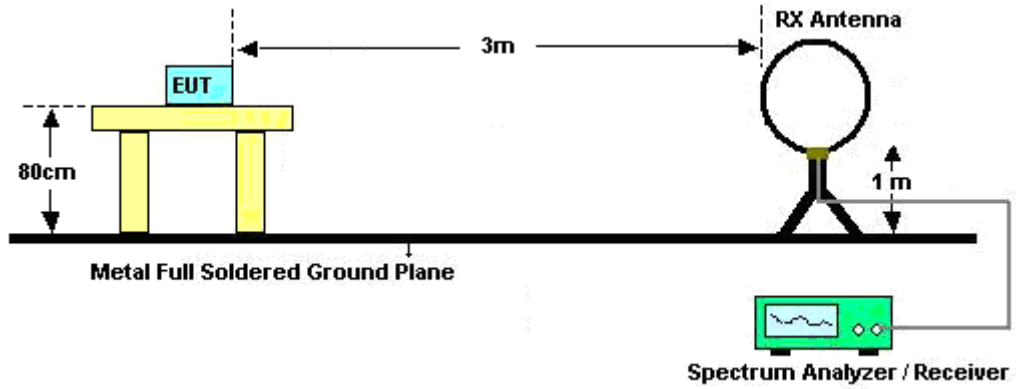

For radiated emissions from 30MHz to 1GHz

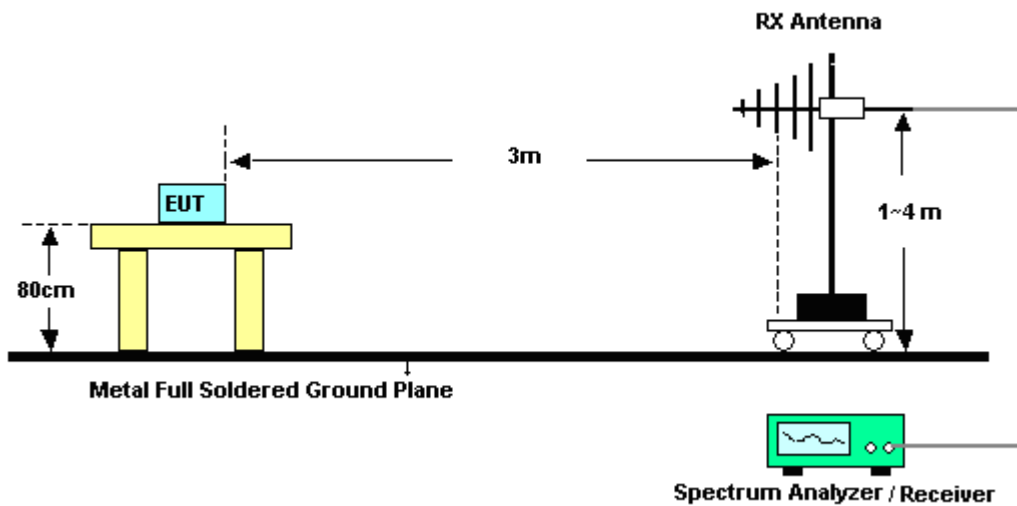

For radiated emissions from 1GHz to 18GHz

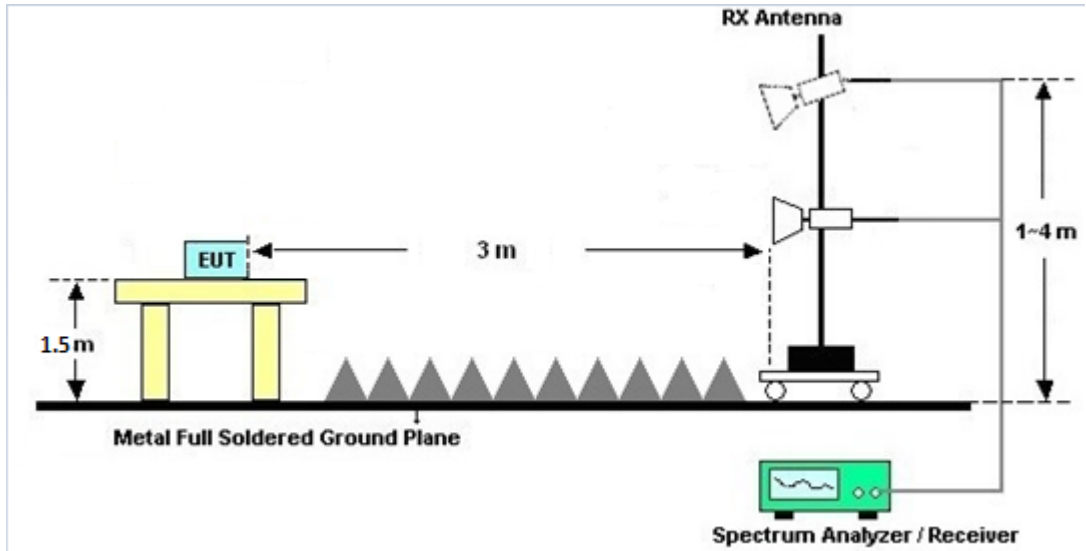

For radiated emissions above 18GHz

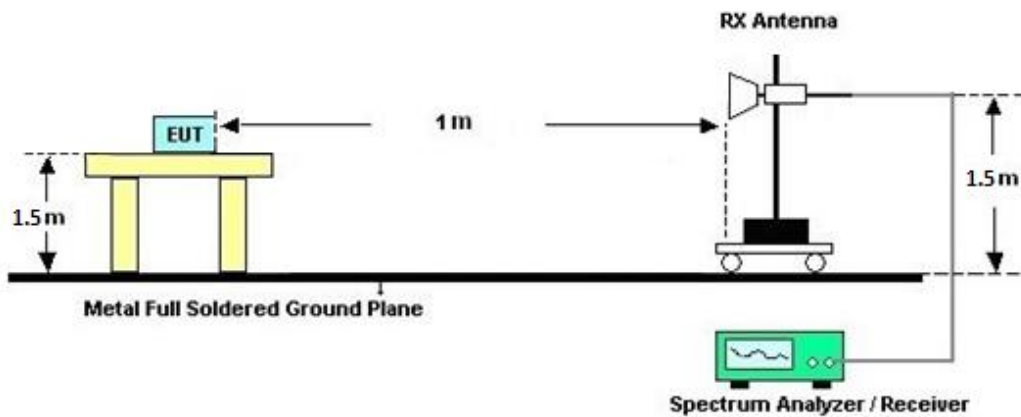



3.5.5 Test Results of Radiated Spurious Emissions (9kHz ~ 30MHz)

The low frequency, which started from 9 kHz to 30MHz, was pre-scanned and the result which was 20dB lower than the limit line was not reported.

There is a comparison data of both open-field test site and alternative test site - semi-Anechoic chamber according to 414788 D01 Radiated Test Site v01r01, and the result came out very similar.

3.5.6 Test Result of Radiated Spurious at Band Edges

Please refer to Appendix B and C.

3.5.7 Duty Cycle

Please refer to Appendix D.

3.5.8 Test Result of Radiated Spurious Emission (30MHz ~ 10th Harmonic)

Please refer to Appendix B and C.



3.6 AC Conducted Emission Measurement

3.6.1 Limit of AC Conducted Emission

For equipment that is designed to be connected to the public utility (AC) power line, the radio frequency voltage that is conducted back onto the AC power line on any frequency or frequencies within the band 150 kHz to 30 MHz shall not exceed the limits in the following table.

Frequency of Emission (MHz)	Conducted Limit (dB μ V)	
	Quasi-Peak	Average
0.15-0.5	66 to 56*	56 to 46*
0.5-5	56	46
5-30	60	50

*Decreases with the logarithm of the frequency.

3.6.2 Measuring Instruments

See list of measuring equipment of this test report.

3.6.3 Test Procedures

1. The EUT was placed 0.4 meter from the conducting wall of the shielding room, and it was kept at least 80 centimeters from any other grounded conducting surface.
2. Connect EUT to the power mains through a line impedance stabilization network (LISN).
3. All the support units are connecting to the other LISN.
4. The LISN provides 50 ohm coupling impedance for the measuring instrument.
5. The FCC states that a 50 ohm, 50 microhenry LISN should be used.
6. Both sides of AC line were checked for maximum conducted interference.
7. The frequency range from 150 kHz to 30 MHz was searched.
8. Set the test-receiver system to Peak Detect Function and specified bandwidth (IF bandwidth = 9kHz) with Maximum Hold Mode.

3.6.4 Test Setup

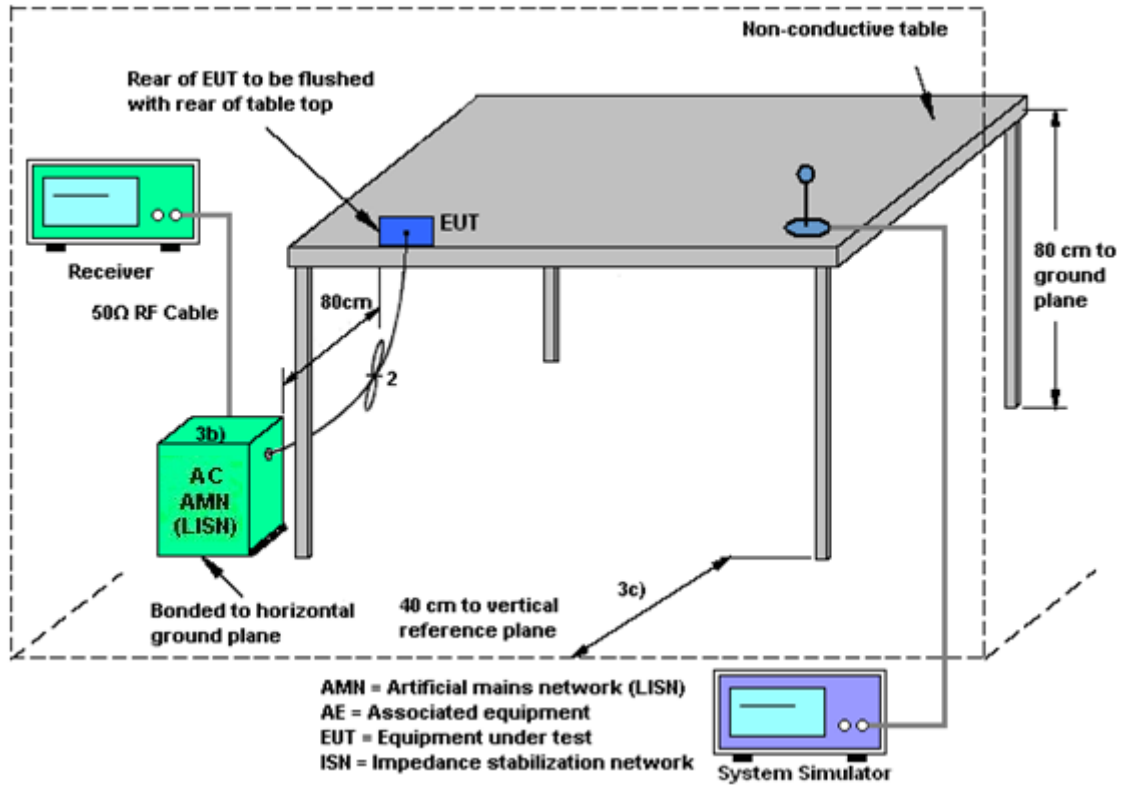

3.6.5 Test Result of AC Conducted Emission

Please refer to Appendix A.



3.7 Antenna Requirements

3.7.1 Standard Applicable

If directional gain of transmitting Antennas is greater than 6dBi, the power shall be reduced by the same level in dB comparing to gain minus 6dBi. The use of a permanently attached Antenna or of an Antenna that uses a unique coupling to the intentional radiator shall be considered sufficient to comply with the rule.

3.7.2 Antenna Anti-Replacement Construction

An embedded-in antenna design is used.

3.7.3 Antenna Gain

<CDD Modes >

FCC KDB 662911 D01 Multiple Transmitter Output v02r01

For CDD transmissions, directional gain is calculated as

Directional gain = G_{ANT} + Array Gain, where Array Gain is as follows.

For power spectral density (PSD) measurements on all devices,

Array Gain = $10 \log(N_{ANT}/N_{SS}=1)$ dB.

For power measurements on IEEE 802.11 devices,

Array Gain = 0 dB (i.e., no array gain) for $N_{ANT} \leq 4$.

Directional gain may be calculated by using the formulas applicable to equal gain antennas with G_{ANT} set equal to the gain of the antenna having the highest gain;

The EUT supports CDD mode.

For power, the directional gain G_{ANT} is set equal to the antenna having the highest gain, i.e., F)2)f)i).

For PSD, the directional gain calculation is following F)2)f)ii) of KDB 662911 D01 v02r01.

The power and PSD limit should be modified if the directional gain of EUT is over 6 dBi,

The directional gain "DG" is calculated as following table.

<CDD Modes>						
			DG	DG	Power	PSD
	Ant. 0	Ant. 1	for	for	Limit	Limit
	(dBi)	(dBi)	Power	PSD	Reduction	Reduction
			(dBi)	(dBi)	(dB)	(dB)
2.4 GHz	1.50	1.20	1.50	4.36	0.00	0.00

$Power\ Limit\ Reduction = DG(Power) - 6dBi, (min = 0)$

$PSD\ Limit\ Reduction = DG(PSD) - 6dBi, (min = 0)$



4 List of Measuring Equipment

Instrument	Brand Name	Model No.	Serial No.	Characteristics	Calibration Date	Test Date	Due Date	Remark
Loop Antenna	Rohde & Schwarz	HFH2-Z2	100488	9 kHz~30 MHz	Jan. 09, 2020	Aug. 08, 2020~ Sep. 01, 2020	Jan. 08, 2021	Radiation (03CH16-HY)
Bilog Antenna	TESEQ	CBL6111D&008 02N1D01N-06	47020&06	30MHz to 1GHz	Oct. 12, 2019	Aug. 08, 2020~ Sep. 01, 2020	Oct. 11, 2020	Radiation (03CH16-HY)
Horn Antenna	SCHWARZBE CK	BBHA 9120 D	9120D-15 22	1G~18GHz	Sep. 19, 2019	Aug. 08, 2020~ Sep. 01, 2020	Sep. 18, 2020	Radiation (03CH16-HY)
SHF-EHF Horn Antenna	SCHWARZBE CK	BBHA 9170	BBHA917 0980	18GHz~40GHz	Jan. 10, 2020	Aug. 08, 2020~ Sep. 01, 2020	Jan. 09, 2021	Radiation (03CH16-HY)
Amplifier	SONOMA	310N	371607	9kHz~1G	Oct. 01. 2019	Aug. 08, 2020~ Sep. 01, 2020	Sep. 30. 2020	Radiation (03CH16-HY)
Preamplifier	Jet-Power	JPA0118-55-30 3	17100018 00055006	1GHz~18GHz	May 07, 2020	Aug. 08, 2020~ Sep. 01, 2020	May 06, 2021	Radiation (03CH16-HY)
Preamplifier	EMEC	EM18G40G	060715	18GHz ~40GHz	Dec. 13, 2019	Aug. 08, 2020~ Sep. 01, 2020	Dec. 12, 2020	Radiation (03CH16-HY)
Preamplifier	Keysight	83017A	MY53270 264	1GHz~26.5GHz	Dec. 11, 2019	Aug. 08, 2020~ Sep. 01, 2020	Dec. 10, 2020	Radiation (03CH16-HY)
EMI Test Receiver	Keysight	N9038A(MXE)	MY57290 111	3Hz~26.5GHz	Dec. 05, 2019	Aug. 08, 2020~ Sep. 01, 2020	Dec. 04, 2020	Radiation (03CH16-HY)
RF Cable	HUBER + SUHNER	SUCOFLEX 104	MY11680/ 4PE	NA	Aug. 30, 2019	Aug. 08, 2020~ Aug. 28, 2020	Aug. 29, 2020	Radiation (03CH16-HY)
RF Cable	HUBER + SUHNER	SUCOFLEX 104	MY11680/ 4PE	NA	Aug. 29, 2020	Aug. 29, 2020~ Sep. 01, 2020	Aug. 28, 2021	Radiation (03CH16-HY)
RF Cable	HUBER + SUHNER	SUCOFLEX 104	MY11688/ 4PE	NA	Aug. 30, 2019	Aug. 08, 2020~ Aug. 28, 2020	Aug. 29, 2020	Radiation (03CH16-HY)
RF Cable	HUBER + SUHNER	SUCOFLEX 104	MY11688/ 4PE	NA	Aug. 29, 2020	Aug. 29, 2020~ Sep. 01, 2020	Aug. 28, 2021	Radiation (03CH16-HY)
RF Cable	HUBER + SUHNER	SUCOFLEX 102	EC-A5-30 0-5757	NA	Aug. 30, 2019	Aug. 08, 2020~ Aug. 28, 2020	Aug. 29, 2020	Radiation (03CH16-HY)
RF Cable	HUBER + SUHNER	SUCOFLEX 102	EC-A5-30 0-5757	NA	Aug. 29, 2020	Aug. 29, 2020~ Sep. 01, 2020	Aug. 28, 2021	Radiation (03CH16-HY)
Hygrometer	TECPEL	DTM-303B	TP16296 5	N/A	Oct. 25, 2019	Aug. 08, 2020~ Sep. 01, 2020	Oct. 24, 2020	Radiation (03CH16-HY)
Software	Audix	E3 6.2009-8-24	RK-00113 6	N/A	N/A	Aug. 08, 2020~ Sep. 01, 2020	N/A	Radiation (03CH16-HY)
Controller	ChainTek	3000-1	N/A	Control Turn table & Ant Mast	N/A	Aug. 08, 2020~ Sep. 01, 2020	N/A	Radiation (03CH16-HY)
Antenna Mast	ChainTek	MBS-520-1	N/A	1m~4m	N/A	Aug. 08, 2020~ Sep. 01, 2020	N/A	Radiation (03CH16-HY)
Turn Table	ChainTek	T-200-S-1	N/A	0~360 Degree	N/A	Aug. 08, 2020~ Sep. 01, 2020	N/A	Radiation (03CH16-HY)



Instrument	Brand Name	Model No.	Serial No.	Characteristics	Calibration Date	Test Date	Due Date	Remark
Hygrometer	Testo	608-H1	34893241	N/A	Mar. 02, 2020	Aug. 17, 2020~ Aug. 27, 2020	Mar. 01, 2021	Conducted (TH05-HY)
Power Sensor	DARE	RPR3006W	16I00054 SNO10	10MHz~6GHz	Dec. 23, 2019	Aug. 17, 2020~ Aug. 27, 2020	Dec. 22, 2020	Conducted (TH05-HY)
Signal Analyzer	Rohde & Schwarz	FSV40	101397	10Hz~40GHz	Nov. 15, 2019	Aug. 17, 2020~ Aug. 27, 2020	Nov. 14, 2020	Conducted (TH05-HY)
Spectrum Analyzer	Rohde & Schwarz	FSP40	100055	9kHz-40GHz	Dec. 30, 2019	Aug. 17, 2020~ Aug. 27, 2020	Dec. 29, 2020	Conducted (TH05-HY)
Switch Box & RF Cable	EM Electronics	EMSW18SE	SW20030 2	N/A	Mar. 17, 2020	Aug. 17, 2020~ Aug. 27, 2020	Mar. 16, 2021	Conducted (TH05-HY)
AC Power Source	ChainTek	APC-1000W	N/A	N/A	N/A	Sep. 23, 2020	N/A	Conduction (CO05-HY)
EMI Test Receiver	Rohde & Schwarz	ESR3	102388	9kHz~3.6GHz	Nov. 15, 2019	Sep. 23, 2020	Nov. 14, 2020	Conduction (CO05-HY)
Hygrometer	Testo	608-H1	34913912	N/A	Nov. 07, 2019	Sep. 23, 2020	Nov. 06, 2020	Conduction (CO05-HY)
LISN	Rohde & Schwarz	ENV216	100081	9kHz~30MHz	Nov. 15, 2019	Sep. 23, 2020	Nov. 14, 2020	Conduction (CO05-HY)
Software	Rohde & Schwarz	EMC32 V10.30	N/A	N/A	N/A	Sep. 23, 2020	N/A	Conduction (CO05-HY)
LF Cable	HUBER + SUHNER	RG-214/U	LF01	N/A	Jan. 02, 2020	Sep. 23, 2020	Jan. 01, 2021	Conduction (CO05-HY)
Pulse Limiter	Rohde & Schwarz	ESH3-Z2	100851	N/A	Jan. 02, 2020	Sep. 23, 2020	Jan. 01, 2021	Conduction (CO05-HY)



5 Uncertainty of Evaluation

Uncertainty of Conducted Emission Measurement (150kHz ~ 30MHz)

Measuring Uncertainty for a Level of Confidence of 95% ($U = 2Uc(y)$)	2.3
---	-----

Uncertainty of Radiated Emission Measurement (30 MHz ~ 1000 MHz)

Measuring Uncertainty for a Level of Confidence of 95% ($U = 2Uc(y)$)	4.5
---	-----

Uncertainty of Radiated Emission Measurement (1000 MHz ~ 18000 MHz)

Measuring Uncertainty for a Level of Confidence of 95% ($U = 2Uc(y)$)	6.3
---	-----

Uncertainty of Radiated Emission Measurement (18000 MHz ~ 40000 MHz)

Measuring Uncertainty for a Level of Confidence of 95% ($U = 2Uc(y)$)	4.7
---	-----



Appendix A. AC Conducted Emission Test Results

Test Engineer :	Tom Lee	Temperature :	24~26°C
		Relative Humidity :	42~50%

EUT Information

Report NO : 070401
 Test Mode : Mode 1
 Test Voltage : 120Vac/60Hz
 Phase : Line

Full Spectrum

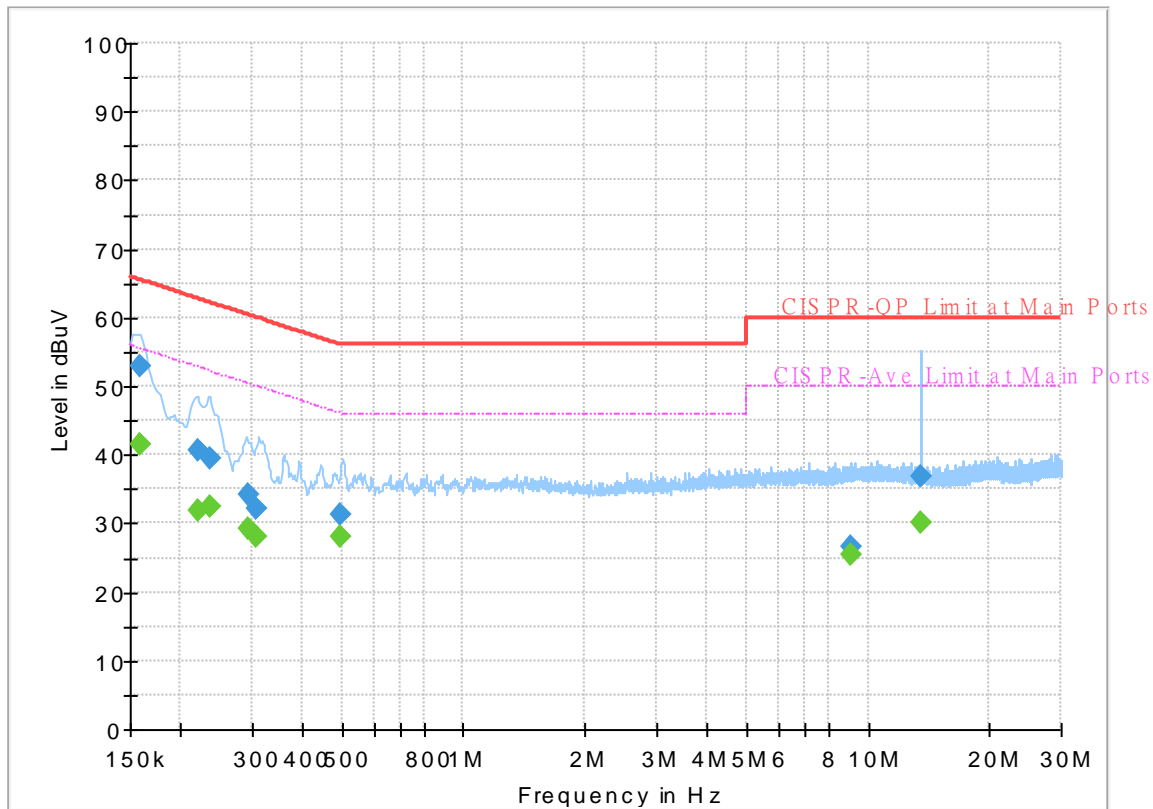

Final_Result

Frequency (MHz)	QuasiPeak (dBuV)	CAverage (dBuV)	Limit (dBuV)	Margin (dB)	Line	Filter	Corr. (dB)
0.159000	---	41.55	55.52	13.97	L1	OFF	19.6
0.159000	52.88	---	65.52	12.64	L1	OFF	19.6
0.219750	---	31.98	52.83	20.85	L1	OFF	19.6
0.219750	40.75	---	62.83	22.08	L1	OFF	19.6
0.235500	---	32.39	52.25	19.86	L1	OFF	19.6
0.235500	39.50	---	62.25	22.75	L1	OFF	19.6
0.294000	---	29.21	50.41	21.20	L1	OFF	19.6
0.294000	34.22	---	60.41	26.19	L1	OFF	19.6
0.307500	---	28.05	50.04	21.99	L1	OFF	19.6
0.307500	32.26	---	60.04	27.78	L1	OFF	19.6
0.498750	---	28.07	46.02	17.95	L1	OFF	19.6
0.498750	31.36	---	56.02	24.66	L1	OFF	19.6
9.035250	---	25.54	50.00	24.46	L1	OFF	20.0
9.035250	26.59	---	60.00	33.41	L1	OFF	20.0
13.560000	---	30.09	50.00	19.91	L1	OFF	20.2
13.560000	36.85	---	60.00	23.15	L1	OFF	20.2

EUT Information

Report NO : 070401
 Test Mode : Mode 1
 Test Voltage : 120Vac/60Hz
 Phase : Neutral

Full Spectrum

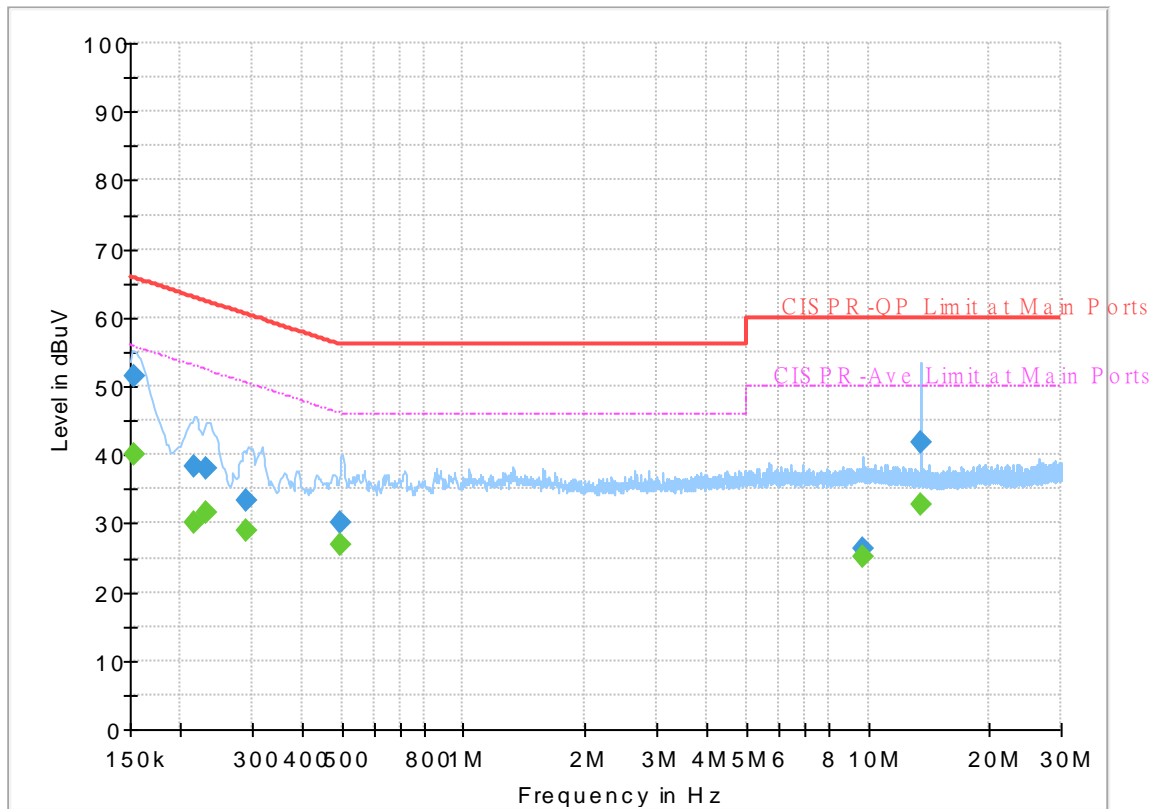

Final_Result

Frequency (MHz)	QuasiPeak (dBuV)	CAverage (dBuV)	Limit (dBuV)	Margin (dB)	Line	Filter	Corr. (dB)
0.153656	---	40.07	55.80	15.73	N	OFF	19.5
0.153656	51.42	---	65.80	14.38	N	OFF	19.5
0.216150	---	30.06	52.97	22.91	N	OFF	19.5
0.216150	38.35	---	62.97	24.62	N	OFF	19.5
0.232260	---	31.64	52.37	20.73	N	OFF	19.5
0.232260	37.93	---	62.37	24.44	N	OFF	19.5
0.289500	---	29.07	50.54	21.47	N	OFF	19.5
0.289500	33.20	---	60.54	27.34	N	OFF	19.5
0.498750	---	27.02	46.02	19.00	N	OFF	19.5
0.498750	30.13	---	56.02	25.89	N	OFF	19.5
9.709890	---	25.11	50.00	24.89	N	OFF	19.8
9.709890	26.27	---	60.00	33.73	N	OFF	19.8
13.560000	---	32.86	50.00	17.14	N	OFF	19.9
13.560000	41.76	---	60.00	18.24	N	OFF	19.9



Appendix B. Radiated Spurious Emission

Test Engineer :	Andy Yang, Karl Hou and CR Liao	Temperature :	20~25°C
		Relative Humidity :	50~65%

2.4GHz 2400~2483.5MHz

WIFI 802.11b (Band Edge @ 3m)

WIFI Ant.	Note	Frequency (MHz)	Level (dBμV/m)	Over Limit (dB)	Limit Line (dBμV/m)	Read Level (dBμV)	Antenna Factor (dB/m)	Path Loss (dB)	Preamp Factor (dB)	Ant Pos (cm)	Table Pos (deg)	Peak Avg. (P/A)	Pol. (H/V)	
802.11b CH 01 2412MHz		2386.335	59.83	-14.17	74	43.87	27.65	18.09	29.78	102	150	P	H	
		2386.44	52.55	-1.45	54	36.59	27.65	18.09	29.78	102	150	A	H	
	*	2412	112.31	-	-	96.37	27.6	18.13	29.79	102	150	P	H	
	*	2412	109.12	-	-	93.18	27.6	18.13	29.79	102	150	A	H	
													H	
			2387.49	57.95	-16.05	74	41.99	27.65	18.09	29.78	253	350	P	V
			2386.335	49.36	-4.64	54	33.4	27.65	18.09	29.78	253	350	A	V
	*		2412	108.63	-	-	92.69	27.6	18.13	29.79	253	350	P	V
	*		2412	105.49	-	-	89.55	27.6	18.13	29.79	253	350	A	V
														V
802.11b CH 06 2437MHz		2347.52	56.64	-17.36	74	40.58	27.81	18.02	29.77	108	204	P	H	
		2389.94	44.78	-9.22	54	28.83	27.64	18.09	29.78	108	204	A	H	
	*	2437	112.23	-	-	96.26	27.6	18.17	29.8	108	204	P	H	
	*	2437	109.09	-	-	93.12	27.6	18.17	29.8	108	204	A	H	
			2484.88	56.56	-17.44	74	40.6	27.53	18.25	29.82	108	204	P	H
			2484.6	44.55	-9.45	54	28.59	27.53	18.25	29.82	108	204	A	H
			2310.42	57.04	-16.96	74	40.87	27.96	17.96	29.75	359	348	P	V
			2389.66	44.25	-9.75	54	28.3	27.64	18.09	29.78	359	348	A	V
	*		2436	107.32	-	-	91.35	27.6	18.17	29.8	359	348	P	V
	*		2437	104.28	-	-	88.31	27.6	18.17	29.8	359	348	A	V
			2488.87	57.02	-16.98	74	41.08	27.52	18.25	29.83	359	348	P	V
			2498.46	44.34	-9.66	54	28.4	27.5	18.27	29.83	359	348	A	V



802.11b CH 11 2462MHz	*	2462	109.66	-	-	93.68	27.58	18.21	29.81	106	146	P	H
	*	2462	106.51	-	-	90.53	27.58	18.21	29.81	106	146	A	H
		2486.92	59.14	-14.86	74	43.18	27.53	18.25	29.82	106	146	P	H
		2486.72	51.15	-2.85	54	35.19	27.53	18.25	29.82	106	146	A	H
													H
													H
	*	2462	105.02	-	-	89.04	27.58	18.21	29.81	399	347	P	V
	*	2462	101.87	-	-	85.89	27.58	18.21	29.81	399	347	A	V
		2486.52	56.8	-17.2	74	40.84	27.53	18.25	29.82	399	347	P	V
		2486.64	47.01	-6.99	54	31.05	27.53	18.25	29.82	399	347	A	V
													V
													V
Remark	1. No other spurious found. 2. All results are PASS against Peak and Average limit line.												



2.4GHz 2400~2483.5MHz
WIFI 802.11b (Harmonic @ 3m)

WIFI Ant. 0	Note	Frequency (MHz)	Level (dBμV/m)	Over Limit (dB)	Limit Line (dBμV/m)	Read Level (dBμV)	Antenna Factor (dB/m)	Path Loss (dB)	Preamp Factor (dB)	Ant Pos (cm)	Table Pos (deg)	Peak Avg. (P/A)	Pol. (H/V)
802.11b CH 01 2412MHz		4824	40.69	-33.31	74	56.2	31.15	12.43	59.09	100	0	P	H
													H
													H
													H
		4824	41.6	-32.4	74	57.11	31.15	12.43	59.09	100	0	P	V
													V
													V
802.11b CH 06 2437MHz		4874	39.53	-34.47	74	55.05	31.1	12.5	59.12	100	0	P	H
		7311	46.08	-27.92	74	52.6	36.44	15.6	58.56	100	0	P	H
													H
													H
		4874	39.79	-34.21	74	55.31	31.1	12.5	59.12	100	0	P	V
		7311	45.64	-28.36	74	52.16	36.44	15.6	58.56	100	0	P	V
													V
802.11b CH 11 2462MHz		4924	40.94	-33.06	74	56.47	31.1	12.52	59.15	100	0	P	H
		7386	44.99	-29.01	74	51.26	36.53	15.66	58.46	100	0	P	H
													H
													H
		4924	40.96	-33.04	74	56.49	31.1	12.52	59.15	100	0	P	V
		7386	45.97	-28.03	74	52.24	36.53	15.66	58.46	100	0	P	V
													V
Remark	1. No other spurious found.												
	2. All results are PASS against Peak and Average limit line.												



**2.4GHz 2400~2483.5MHz
WIFI 802.11g (Band Edge @ 3m)**

WIFI Ant. 0	Note	Frequency (MHz)	Level (dBμV/m)	Over Limit (dB)	Limit Line (dBμV/m)	Read Level (dBμV)	Antenna Factor (dB/m)	Path Loss (dB)	Preamp Factor (dB)	Ant Pos (cm)	Table Pos (deg)	Peak Avg. (P/A)	Pol. (H/V)	
802.11g CH 01 2412MHz		2390	64.65	-9.35	74	48.7	27.64	18.09	29.78	101	201	P	H	
		2390	52.57	-1.43	54	36.62	27.64	18.09	29.78	101	201	A	H	
	*	2412	109.47	-	-	93.53	27.6	18.13	29.79	101	201	P	H	
	*	2412	101.76	-	-	85.82	27.6	18.13	29.79	101	201	A	H	
													H	
													H	
			2390	58.73	-15.27	74	42.78	27.64	18.09	29.78	366	346	P	V
			2390	48.8	-5.2	54	32.85	27.64	18.09	29.78	366	346	A	V
	*		2412	105.32	-	-	89.38	27.6	18.13	29.79	366	346	P	V
	*		2412	97.46	-	-	81.52	27.6	18.13	29.79	366	346	A	V
													V	
													V	
802.11g CH 06 2437MHz		2389.8	57.19	-16.81	74	41.24	27.64	18.09	29.78	106	204	P	H	
		2389.94	46.71	-7.29	54	30.76	27.64	18.09	29.78	106	204	A	H	
	*	2437	114.67	-	-	98.7	27.6	18.17	29.8	106	204	P	H	
	*	2437	107.21	-	-	91.24	27.6	18.17	29.8	106	204	A	H	
			2489.08	56.89	-17.11	74	40.95	27.52	18.25	29.83	106	204	P	H
			2485.86	45.27	-8.73	54	29.31	27.53	18.25	29.82	106	204	A	H
			2357.04	56.81	-17.19	74	40.77	27.77	18.04	29.77	359	348	P	V
			2389.94	44.77	-9.23	54	28.82	27.64	18.09	29.78	359	348	A	V
	*		2437	110.01	-	-	94.04	27.6	18.17	29.8	359	348	P	V
	*		2437	102.31	-	-	86.34	27.6	18.17	29.8	359	348	A	V
			2484.04	56.35	-17.65	74	40.4	27.53	18.24	29.82	359	348	P	V
			2486.28	44.48	-9.52	54	28.52	27.53	18.25	29.82	359	348	A	V



802.11g CH 11 2462MHz	*	2462	107.14	-	-	91.16	27.58	18.21	29.81	101	209	P	H
	*	2462	99.79	-	-	83.81	27.58	18.21	29.81	101	209	A	H
		2484.4	65.7	-8.3	74	49.74	27.53	18.25	29.82	101	209	P	H
		2483.52	52.6	-1.4	54	36.65	27.53	18.24	29.82	101	209	A	H
													H
													H
	*	2462	103	-	-	87.02	27.58	18.21	29.81	399	350	P	V
	*	2462	95.57	-	-	79.59	27.58	18.21	29.81	399	350	A	V
		2484.72	59.01	-14.99	74	43.05	27.53	18.25	29.82	399	350	P	V
		2483.52	48.12	-5.88	54	32.17	27.53	18.24	29.82	399	350	A	V
													V
													V
Remark	1. No other spurious found. 2. All results are PASS against Peak and Average limit line.												



**2.4GHz 2400~2483.5MHz
WIFI 802.11g (Harmonic @ 3m)**

WIFI Ant. 0	Note	Frequency (MHz)	Level (dBμV/m)	Over Limit (dB)	Limit Line (dBμV/m)	Read Level (dBμV)	Antenna Factor (dB/m)	Path Loss (dB)	Preamp Factor (dB)	Ant Pos (cm)	Table Pos (deg)	Peak Avg. (P/A)	Pol. (H/V)	
802.11g CH 01 2412MHz		4824	40.01	-33.99	74	55.52	31.15	12.43	59.09	100	0	P	H	
													H	
													H	
													H	
			4824	40.11	-33.89	74	55.62	31.15	12.43	59.09	100	0	P	V
														V
														V
802.11g CH 06 2437MHz		4874	39.92	-34.08	74	55.44	31.1	12.5	59.12	100	0	P	H	
		7311	45.56	-28.44	74	52.08	36.44	15.6	58.56	100	0	P	H	
													H	
													H	
			4874	39.72	-34.28	74	55.24	31.1	12.5	59.12	100	0	P	V
			7311	44.66	-29.34	74	51.18	36.44	15.6	58.56	100	0	P	V
														V
802.11g CH 11 2462MHz		4924	39.71	-34.29	74	55.24	31.1	12.52	59.15	100	0	P	H	
		7386	45.38	-28.62	74	51.65	36.53	15.66	58.46	100	0	P	H	
													H	
													H	
			4924	39.54	-34.46	74	55.07	31.1	12.52	59.15	100	0	P	V
			7386	45.95	-28.05	74	52.22	36.53	15.66	58.46	100	0	P	V
														V
Remark	1. No other spurious found.													
	2. All results are PASS against Peak and Average limit line.													



2.4GHz 2400~2483.5MHz
WIFI 802.11n HT20 (Band Edge @ 3m)

WIFI Ant. 0	Note	Frequency (MHz)	Level (dBμV/m)	Over Limit (dB)	Limit Line (dBμV/m)	Read Level (dBμV)	Antenna Factor (dB/m)	Path Loss (dB)	Preamp Factor (dB)	Ant Pos (cm)	Table Pos (deg)	Peak Avg. (P/A)	Pol. (H/V)	
802.11n HT20 CH 01 2412MHz		2389.8	63	-11	74	47.05	27.64	18.09	29.78	102	208	P	H	
		2390	52.11	-1.89	54	36.16	27.64	18.09	29.78	102	208	A	H	
	*	2412	107.67	-	-	91.73	27.6	18.13	29.79	102	208	P	H	
	*	2412	99.91	-	-	83.97	27.6	18.13	29.79	102	208	A	H	
													H	
													H	
			2388.645	58.03	-15.97	74	42.07	27.65	18.09	29.78	369	347	P	V
			2390	48.96	-5.04	54	33.01	27.64	18.09	29.78	369	347	A	V
		*	2412	102.88	-	-	86.94	27.6	18.13	29.79	369	347	P	V
		*	2412	95.17	-	-	79.23	27.6	18.13	29.79	369	347	A	V
													V	
													V	
802.11n HT20 CH 06 2437MHz		2389.38	57.87	-16.13	74	41.92	27.64	18.09	29.78	105	205	P	H	
		2389.8	47.56	-6.44	54	31.61	27.64	18.09	29.78	105	205	A	H	
	*	2437	114.49	-	-	98.52	27.6	18.17	29.8	105	205	P	H	
	*	2437	106.73	-	-	90.76	27.6	18.17	29.8	105	205	A	H	
			2483.62	57.04	-16.96	74	41.09	27.53	18.24	29.82	105	205	P	H
			2485.79	46.52	-7.48	54	30.56	27.53	18.25	29.82	105	205	A	H
			2314.9	57.14	-16.86	74	40.98	27.94	17.97	29.75	359	348	P	V
			2389.94	45.99	-8.01	54	30.04	27.64	18.09	29.78	359	348	A	V
		*	2437	110.04	-	-	94.07	27.6	18.17	29.8	359	348	P	V
		*	2437	101.79	-	-	85.82	27.6	18.17	29.8	359	348	A	V
		2491.46	56.26	-17.74	74	40.31	27.52	18.26	29.83	359	348	P	V	
		2485.02	45.74	-8.26	54	29.78	27.53	18.25	29.82	359	348	A	V	



802.11n HT20 CH 11 2462MHz	*	2462	105.74	-	-	89.76	27.58	18.21	29.81	100	205	P	H
	*	2462	98.15	-	-	82.17	27.58	18.21	29.81	100	205	A	H
		2484.16	62.92	-11.08	74	46.97	27.53	18.24	29.82	100	205	P	H
		2483.68	52.31	-1.69	54	36.36	27.53	18.24	29.82	100	205	A	H
													H
													H
	*	2462	102.13	-	-	86.15	27.58	18.21	29.81	398	347	P	V
	*	2462	93.96	-	-	77.98	27.58	18.21	29.81	398	347	A	V
		2484.6	58.35	-15.65	74	42.39	27.53	18.25	29.82	398	347	P	V
		2483.84	48.39	-5.61	54	32.44	27.53	18.24	29.82	398	347	A	V
													V
													V
Remark	1. No other spurious found. 2. All results are PASS against Peak and Average limit line.												



**2.4GHz 2400~2483.5MHz
WIFI 802.11n HT20 (Harmonic @ 3m)**

WIFI Ant. 0	Note	Frequency (MHz)	Level (dBμV/m)	Over Limit (dB)	Limit Line (dBμV/m)	Read Level (dBμV)	Antenna Factor (dB/m)	Path Loss (dB)	Preamp Factor (dB)	Ant Pos (cm)	Table Pos (deg)	Peak Avg. (P/A)	Pol. (H/V)	
802.11n HT20 CH 01 2412MHz		4824	39.78	-34.22	74	55.29	31.15	12.43	59.09	100	0	P	H	
													H	
													H	
													H	
			4824	40.67	-33.33	74	56.18	31.15	12.43	59.09	100	0	P	V
														V
														V
802.11n HT20 CH 06 2437MHz		4874	39.77	-34.23	74	55.29	31.1	12.5	59.12	100	0	P	H	
		7311	44.87	-29.13	74	51.39	36.44	15.6	58.56	100	0	P	H	
													H	
													H	
			4874	40.01	-33.99	74	55.53	31.1	12.5	59.12	100	0	P	V
			7311	45.51	-28.49	74	52.03	36.44	15.6	58.56	100	0	P	V
														V
802.11n HT20 CH 11 2462MHz		4924	39.34	-34.66	74	54.86	31.1	12.53	59.15	100	0	P	H	
		7386	43.84	-30.16	74	50.17	36.53	15.6	58.46	100	0	P	H	
													H	
													H	
			4924	39.54	-34.46	74	55.06	31.1	12.53	59.15	100	0	P	V
			7386	44.11	-29.89	74	50.44	36.53	15.6	58.46	100	0	P	V
														V
Remark	1. No other spurious found.													
	2. All results are PASS against Peak and Average limit line.													



**2.4GHz 2400~2483.5MHz
WIFI 802.11n HT40 (Band Edge @ 3m)**

WIFI Ant. 0	Note	Frequency (MHz)	Level (dBμV/m)	Over Limit (dB)	Limit Line (dBμV/m)	Read Level (dBμV)	Antenna Factor (dB/m)	Path Loss (dB)	Preamp Factor (dB)	Ant Pos (cm)	Table Pos (deg)	Peak Avg. (P/A)	Pol. (H/V)
802.11n HT40 CH 03 2422MHz		2388.82	60.44	-13.56	74	44.49	27.64	18.09	29.78	108	147	P	H
		2389.94	52.16	-1.84	54	36.21	27.64	18.09	29.78	108	147	A	H
	*	2422	102.61	-	-	86.66	27.6	18.15	29.8	108	147	P	H
	*	2422	94.49	-	-	78.54	27.6	18.15	29.8	108	147	A	H
		2492.79	56.49	-17.51	74	40.55	27.51	18.26	29.83	108	147	P	H
		2495.31	47.01	-6.99	54	31.07	27.51	18.26	29.83	108	147	A	H
		2335.34	57.28	-16.72	74	41.18	27.86	18	29.76	400	348	P	V
		2389.8	47.21	-6.79	54	31.26	27.64	18.09	29.78	400	348	A	V
	*	2422	96.46	-	-	80.51	27.6	18.15	29.8	400	348	P	V
	*	2422	88.57	-	-	72.62	27.6	18.15	29.8	400	348	A	V
		2484.04	56.69	-17.31	74	40.74	27.53	18.24	29.82	400	348	P	V
		2498.18	46.84	-7.16	54	30.9	27.5	18.27	29.83	400	348	A	V
802.11n HT40 CH 06 2437MHz		2389.38	61.2	-12.8	74	45.25	27.64	18.09	29.78	108	145	P	H
		2389.94	51.9	-2.1	54	35.95	27.64	18.09	29.78	108	145	A	H
	*	2437	109.59	-	-	93.62	27.6	18.17	29.8	108	145	P	H
	*	2437	101.43	-	-	85.46	27.6	18.17	29.8	108	145	A	H
		2486	60.89	-13.11	74	44.93	27.53	18.25	29.82	108	145	P	H
		2483.5	52.03	-1.97	54	36.08	27.53	18.24	29.82	108	145	A	H
		2376.64	57.58	-16.42	74	41.6	27.69	18.07	29.78	399	349	P	V
		2388.96	47.61	-6.39	54	31.66	27.64	18.09	29.78	399	349	A	V
	*	2437	103.26	-	-	87.29	27.6	18.17	29.8	399	349	P	V
	*	2437	95.56	-	-	79.59	27.6	18.17	29.8	399	349	A	V
	2486.91	57.51	-16.49	74	41.55	27.53	18.25	29.82	399	349	P	V	
	2484.25	48.52	-5.48	54	32.57	27.53	18.24	29.82	399	349	A	V	



802.11n HT40 CH 09 2452MHz		2360.96	56.95	-17.05	74	40.91	27.76	18.05	29.77	105	146	P	H
		2389.1	47.21	-6.79	54	31.26	27.64	18.09	29.78	105	146	A	H
	*	2452	105.73	-	-	89.75	27.6	18.19	29.81	105	146	P	H
	*	2452	98.49	-	-	82.51	27.6	18.19	29.81	105	146	A	H
		2486.98	61.09	-12.91	74	45.13	27.53	18.25	29.82	105	146	P	H
		2484.74	52.42	-1.58	54	36.46	27.53	18.25	29.82	105	146	A	H
		2331.98	56.69	-17.31	74	40.58	27.87	18	29.76	399	348	P	V
		2323.02	46.86	-7.14	54	30.73	27.91	17.98	29.76	399	348	A	V
	*	2452	100.65	-	-	84.67	27.6	18.19	29.81	399	348	P	V
	*	2452	92.84	-	-	76.86	27.6	18.19	29.81	399	348	A	V
		2485.72	57.94	-16.06	74	41.98	27.53	18.25	29.82	399	348	P	V
		2484.46	48.74	-5.26	54	32.78	27.53	18.25	29.82	399	348	A	V
Remark	1. No other spurious found. 2. All results are PASS against Peak and Average limit line.												



**2.4GHz 2400~2483.5MHz
WIFI 802.11n HT40 (Harmonic @ 3m)**

WIFI Ant. 0	Note	Frequency (MHz)	Level (dBμV/m)	Over Limit (dB)	Limit Line (dBμV/m)	Read Level (dBμV)	Antenna Factor (dB/m)	Path Loss (dB)	Preamp Factor (dB)	Ant Pos (cm)	Table Pos (deg)	Peak Avg. (P/A)	Pol. (H/V)
802.11n HT40 CH 03 2422MHz		4844	40.47	-33.53	74	55.92	31.19	12.47	59.11	100	0	P	H
		7266	45.65	-28.35	74	52.36	36.33	15.59	58.63	100	0	P	H
													H
													H
		4844	40.26	-33.74	74	55.71	31.19	12.47	59.11	100	0	P	V
		7266	44.38	-29.62	74	51.09	36.33	15.59	58.63	100	0	P	V
													V
													V
802.11n HT40 CH 06 2437MHz		4874	39.26	-34.74	74	54.78	31.1	12.5	59.12	100	0	P	H
		7311	45.5	-28.5	74	52.02	36.44	15.6	58.56	100	0	P	H
													H
													H
		4874	39.17	-34.83	74	54.69	31.1	12.5	59.12	100	0	P	V
		7311	45.54	-28.46	74	52.06	36.44	15.6	58.56	100	0	P	V
													V
													V
802.11n HT40 CH 09 2452MHz		4904	39.3	-34.7	74	54.9	31.02	12.52	59.14	100	0	P	H
		7356	46.14	-27.86	74	52.46	36.59	15.59	58.5	100	0	P	H
													H
													H
		4904	39.32	-34.68	74	54.92	31.02	12.52	59.14	100	0	P	V
		7356	45.36	-28.64	74	51.68	36.59	15.59	58.5	100	0	P	V
													V
													V
Remark	1. No other spurious found. 2. All results are PASS against Peak and Average limit line.												



Emission above 18GHz

2.4GHz WIFI 802.11g (SHF)

WIFI	Note	Frequency	Level	Over	Limit	Read	Antenna	Path	Preamp	Ant	Table	Peak	Pol.
Ant.				Limit	Line	Level	Factor	Loss	Factor	Pos	Pos	Avg.	
0		(MHz)	(dBμV/m)	(dB)	(dBμV/m)	(dBμV)	(dB/m)	(dB)	(dB)	(cm)	(deg)	(P/A)	(H/V)
2.4GHz 802.11g SHF		21773	39.27	-34.73	74	42.26	37.95	12.51	53.45	150	0	P	H
													H
													H
													H
													H
													H
													H
													H
													H
													H
													H
													H
													H
													H
													H
													H
													H
													H
													H
			21325	39.98	-34.02	74	43.05	38.14	12.26	53.47	150	0	P
													V
													V
													V
													V
													V
													V
													V
													V
													V
													V
													V
													V
													V
													V
Remark	1. No other spurious found. 2. All results are PASS against limit line.												



Emission below 1GHz
2.4GHz WIFI 802.11g (LF)

WIFI	Note	Frequency	Level	Over	Limit	Read	Antenna	Path	Preamp	Ant	Table	Peak	Pol.	
Ant.				Limit	Line	Level	Factor	Loss	Factor	Pos	Pos	Avg.		
0		(MHz)	(dBμV/m)	(dB)	(dBμV/m)	(dBμV)	(dB/m)	(dB)	(dB)	(cm)	(deg)	(P/A)	(H/V)	
2.4GHz 802.11g LF		88.2	30.75	-12.75	43.5	47.33	14.32	1.39	32.29	100	0	P	H	
		144.46	29.56	-13.94	43.5	42.74	17.21	1.89	32.28	-	-	P	H	
		186.17	24.73	-18.77	43.5	40.1	14.76	2.18	32.31	-	-	P	H	
		245.34	21.37	-24.63	46	33.1	18.03	2.58	32.34	-	-	P	H	
		461.65	27.02	-18.98	46	32.18	23.39	3.58	32.13	-	-	P	H	
		765.26	31.24	-14.76	46	30.65	28.12	4.76	32.29	-	-	P	H	
														H
														H
														H
														H
														H
														H
														H
			51.34	28.86	-11.14	40	46.78	13.55	0.96	32.43	-	-	P	V
			87.23	33.88	-6.12	40	50.52	14.28	1.38	32.3	100	0	P	V
			145.43	25.32	-18.18	43.5	38.54	17.16	1.9	32.28	-	-	P	V
			180.35	23.93	-19.57	43.5	39.21	14.89	2.14	32.31	-	-	P	V
			257.95	19.74	-26.26	46	29.67	19.76	2.65	32.34	-	-	P	V
			729.37	31.88	-14.12	46	31.91	27.54	4.64	32.21	-	-	P	V
														V
													V	
													V	
													V	
													V	
													V	
Remark	1. No other spurious found. 2. All results are PASS against limit line.													



2.4GHz 2400~2483.5MHz

WIFI 802.11b (Band Edge @ 3m)

WIFI	Note	Frequency	Level	Over	Limit	Read	Antenna	Path	Preamp	Ant	Table	Peak	Pol.	
Ant.				Limit	Line	Level	Factor	Loss	Factor	Pos	Pos	Avg.		
1		(MHz)	(dBμV/m)	(dB)	(dBμV/m)	(dBμV)	(dB/m)	(dB)	(dB)	(cm)	(deg)	(P/A)	(H/V)	
802.11b CH 01 2412MHz		2386.86	58.3	-15.7	74	42.34	27.65	18.09	29.78	100	283	P	H	
		2387.49	46.86	-7.14	54	30.9	27.65	18.09	29.78	100	283	A	H	
	*	2412	111.48	-	-	95.54	27.6	18.13	29.79	100	283	P	H	
	*	2412	108.25	-	-	92.31	27.6	18.13	29.79	100	283	A	H	
													H	
														H
			2329.845	57.24	-16.76	74	41.13	27.88	17.99	29.76	315	16	P	V
			2387.385	45.77	-8.23	54	29.81	27.65	18.09	29.78	315	16	A	V
	*		2412	105.92	-	-	89.98	27.6	18.13	29.79	315	16	P	V
	*		2412	102.69	-	-	86.75	27.6	18.13	29.79	315	16	A	V
														V
														V
802.11b CH 06 2437MHz		2343.74	56.44	-17.56	74	40.35	27.83	18.02	29.76	136	24	P	H	
		2389.52	45.49	-8.51	54	29.54	27.64	18.09	29.78	136	24	A	H	
	*	2437	112.21	-	-	96.24	27.6	18.17	29.8	136	24	P	H	
	*	2437	109.01	-	-	93.04	27.6	18.17	29.8	136	24	A	H	
			2484.81	56.8	-17.2	74	40.84	27.53	18.25	29.82	136	24	P	H
			2484.11	45.04	-8.96	54	29.09	27.53	18.24	29.82	136	24	A	H
			2361.24	57.28	-16.72	74	41.24	27.76	18.05	29.77	296	25	P	V
			2389.94	44.76	-9.24	54	28.81	27.64	18.09	29.78	296	25	A	V
	*		2437	108	-	-	92.03	27.6	18.17	29.8	296	25	P	V
	*		2437	104.88	-	-	88.91	27.6	18.17	29.8	296	25	A	V
			2499.44	56.34	-17.66	74	40.4	27.5	18.27	29.83	296	25	P	V
			2483.83	44.67	-9.33	54	28.72	27.53	18.24	29.82	296	25	A	V



802.11b CH 11 2462MHz	*	2462	111.51	-	-	95.53	27.58	18.21	29.81	104	24	P	H
	*	2462	108.35	-	-	92.37	27.58	18.21	29.81	104	24	A	H
		2486.56	59.19	-14.81	74	43.23	27.53	18.25	29.82	104	24	P	H
		2486.6	51.67	-2.33	54	35.71	27.53	18.25	29.82	104	24	A	H
													H
													H
	*	2462	107.56	-	-	91.58	27.58	18.21	29.81	264	25	P	V
	*	2462	104.44	-	-	88.46	27.58	18.21	29.81	264	25	A	V
		2485.32	58.53	-15.47	74	42.57	27.53	18.25	29.82	264	25	P	V
		2486.56	48.74	-5.26	54	32.78	27.53	18.25	29.82	264	25	A	V
													V
													V
Remark	<ol style="list-style-type: none"> 1. No other spurious found. 2. All results are PASS against Peak and Average limit line. 												



**2.4GHz 2400~2483.5MHz
WIFI 802.11b (Harmonic @ 3m)**

WIFI Ant. 1	Note	Frequency (MHz)	Level (dBμV/m)	Over Limit (dB)	Limit Line (dBμV/m)	Read Level (dBμV)	Antenna Factor (dB/m)	Path Loss (dB)	Preamp Factor (dB)	Ant Pos (cm)	Table Pos (deg)	Peak Avg. (P/A)	Pol. (H/V)	
802.11b CH 01 2412MHz		4824	40.1	-33.9	74	55.59	31.15	12.45	59.09	100	0	P	H	
													H	
													H	
													H	
			4824	40.57	-33.43	74	56.06	31.15	12.45	59.09	100	0	P	V
														V
														V
802.11b CH 06 2437MHz		4874	39.91	-34.09	74	55.45	31.1	12.48	59.12	100	0	P	H	
		7311	45.21	-28.79	74	51.65	36.44	15.68	58.56	100	0	P	H	
													H	
													H	
			4874	39.78	-34.22	74	55.32	31.1	12.48	59.12	100	0	P	V
			7311	44.89	-29.11	74	51.33	36.44	15.68	58.56	100	0	P	V
														V
802.11b CH 11 2462MHz		4924	40.59	-33.41	74	56.12	31.1	12.52	59.15	100	0	P	H	
		7386	44.5	-29.5	74	50.77	36.53	15.66	58.46	100	0	P	H	
													H	
													H	
			4924	40.79	-33.21	74	56.32	31.1	12.52	59.15	100	0	P	V
			7386	45.81	-28.19	74	52.08	36.53	15.66	58.46	100	0	P	V
														V
Remark	1. No other spurious found.													
	2. All results are PASS against Peak and Average limit line.													



**2.4GHz 2400~2483.5MHz
WIFI 802.11g (Band Edge @ 3m)**

WIFI Ant. 1	Note	Frequency (MHz)	Level (dBμV/m)	Over Limit (dB)	Limit Line (dBμV/m)	Read Level (dBμV)	Antenna Factor (dB/m)	Path Loss (dB)	Preamp Factor (dB)	Ant Pos (cm)	Table Pos (deg)	Peak Avg. (P/A)	Pol. (H/V)	
802.11g CH 01 2412MHz		2390	63.99	-10.01	74	48.04	27.64	18.09	29.78	100	282	P	H	
		2390	52.44	-1.56	54	36.49	27.64	18.09	29.78	100	282	A	H	
	*	2412	110.47	-	-	94.53	27.6	18.13	29.79	100	282	P	H	
	*	2412	102.74	-	-	86.8	27.6	18.13	29.79	100	282	A	H	
													H	
														H
			2389.695	59.42	-14.58	74	43.47	27.64	18.09	29.78	318	17	P	V
			2390	48.5	-5.5	54	32.55	27.64	18.09	29.78	318	17	A	V
	*		2412	105.84	-	-	89.9	27.6	18.13	29.79	318	17	P	V
	*		2412	97.42	-	-	81.48	27.6	18.13	29.79	318	17	A	V
														V
														V
802.11g CH 06 2437MHz		2389.38	57.7	-16.3	74	41.75	27.64	18.09	29.78	135	24	P	H	
		2389.94	48.05	-5.95	54	32.1	27.64	18.09	29.78	135	24	A	H	
	*	2437	113.91	-	-	97.94	27.6	18.17	29.8	135	24	P	H	
	*	2437	107	-	-	91.03	27.6	18.17	29.8	135	24	A	H	
			2483.5	59.37	-14.63	74	43.42	27.53	18.24	29.82	135	24	P	H
			2483.5	48.17	-5.83	54	32.22	27.53	18.24	29.82	135	24	A	H
			2341.36	56.58	-17.42	74	40.5	27.83	18.01	29.76	299	26	P	V
			2389.94	45.64	-8.36	54	29.69	27.64	18.09	29.78	299	26	A	V
	*		2437	110.26	-	-	94.29	27.6	18.17	29.8	299	26	P	V
	*		2437	102.54	-	-	86.57	27.6	18.17	29.8	299	26	A	V
			2495.17	57.16	-16.84	74	41.22	27.51	18.26	29.83	299	26	P	V
			2483.5	45.93	-8.07	54	29.98	27.53	18.24	29.82	299	26	A	V



802.11g CH 11 2462MHz	*	2462	111.33	-	-	95.35	27.58	18.21	29.81	100	274	P	H
	*	2462	103.33	-	-	87.35	27.58	18.21	29.81	100	274	A	H
		2483.52	63.57	-10.43	74	47.62	27.53	18.24	29.82	100	274	P	H
		2483.52	52.92	-1.08	54	36.97	27.53	18.24	29.82	100	274	A	H
													H
													H
	*	2462	106.13	-	-	90.15	27.58	18.21	29.81	400	125	P	V
	*	2462	98.3	-	-	82.32	27.58	18.21	29.81	400	125	A	V
		2483.84	59.5	-14.5	74	43.55	27.53	18.24	29.82	400	125	P	V
		2483.52	48.89	-5.11	54	32.94	27.53	18.24	29.82	400	125	A	V
													V
													V
Remark	1. No other spurious found. 2. All results are PASS against Peak and Average limit line.												



**2.4GHz 2400~2483.5MHz
WIFI 802.11g (Harmonic @ 3m)**

WIFI Ant. 1	Note	Frequency (MHz)	Level (dBμV/m)	Over Limit (dB)	Limit Line (dBμV/m)	Read Level (dBμV)	Antenna Factor (dB/m)	Path Loss (dB)	Preamp Factor (dB)	Ant Pos (cm)	Table Pos (deg)	Peak Avg. (P/A)	Pol. (H/V)
802.11g CH 01 2412MHz		4824	41.88	-32.12	74	57.39	31.15	12.43	59.09	100	0	P	H
													H
													H
													H
		4824	39.68	-34.32	74	55.19	31.15	12.43	59.09	100	0	P	V
													V
													V
802.11g CH 06 2437MHz		4874	40.04	-33.96	74	55.58	31.1	12.48	59.12	100	0	P	H
		7311	44.99	-29.01	74	51.43	36.44	15.68	58.56	100	0	P	H
													H
													H
		4874	39.86	-34.14	74	55.4	31.1	12.48	59.12	100	0	P	V
		7311	44.71	-29.29	74	51.15	36.44	15.68	58.56	100	0	P	V
													V
802.11g CH 11 2462MHz		4924	39.81	-34.19	74	55.34	31.1	12.52	59.15	100	0	P	H
		7386	44.7	-29.3	74	50.97	36.53	15.66	58.46	100	0	P	H
													H
													H
		4924	39.93	-34.07	74	55.46	31.1	12.52	59.15	100	0	P	V
		7386	45.15	-28.85	74	51.42	36.53	15.66	58.46	100	0	P	V
													V
Remark	1. No other spurious found.												
	2. All results are PASS against Peak and Average limit line.												



**2.4GHz 2400~2483.5MHz
WIFI 802.11n HT20 (Band Edge @ 3m)**

WIFI Ant. 1	Note	Frequency (MHz)	Level (dBµV/m)	Over Limit (dB)	Limit Line (dBµV/m)	Read Level (dBµV)	Antenna Factor (dB/m)	Path Loss (dB)	Preamp Factor (dB)	Ant Pos (cm)	Table Pos (deg)	Peak Avg. (P/A)	Pol. (H/V)	
802.11n HT20 CH 01 2412MHz		2389.905	63.36	-10.64	74	47.41	27.64	18.09	29.78	100	283	P	H	
		2390	52.41	-1.59	54	36.46	27.64	18.09	29.78	100	283	A	H	
	*	2412	109.04	-	-	93.1	27.6	18.13	29.79	100	283	P	H	
	*	2412	101.26	-	-	85.32	27.6	18.13	29.79	100	283	A	H	
													H	
													H	
			2390	58.89	-15.11	74	42.94	27.64	18.09	29.78	314	17	P	V
			2390	48.17	-5.83	54	32.22	27.64	18.09	29.78	314	17	A	V
		*	2412	103.66	-	-	87.72	27.6	18.13	29.79	314	17	P	V
		*	2412	95.74	-	-	79.8	27.6	18.13	29.79	314	17	A	V
													V	
													V	
802.11n HT20 CH 06 2437MHz		2389.1	58.08	-15.92	74	42.13	27.64	18.09	29.78	100	276	P	H	
		2389.94	48.63	-5.37	54	32.68	27.64	18.09	29.78	100	276	A	H	
	*	2437	113.74	-	-	97.77	27.6	18.17	29.8	100	276	P	H	
	*	2437	105.76	-	-	89.79	27.6	18.17	29.8	100	276	A	H	
			2483.62	59.42	-14.58	74	43.47	27.53	18.24	29.82	100	276	P	H
			2483.5	49.38	-4.62	54	33.43	27.53	18.24	29.82	100	276	A	H
			2389.94	57.8	-16.2	74	41.85	27.64	18.09	29.78	270	24	P	V
			2389.94	47.69	-6.31	54	31.74	27.64	18.09	29.78	270	24	A	V
		*	2437	109.48	-	-	93.51	27.6	18.17	29.8	270	24	P	V
		*	2437	101.98	-	-	86.01	27.6	18.17	29.8	270	24	A	V
		2484.6	57.43	-16.57	74	41.47	27.53	18.25	29.82	270	24	P	V	
		2483.55	47.42	-6.58	54	31.47	27.53	18.24	29.82	270	24	A	V	



802.11n HT20 CH 11 2462MHz	*	2462	109.51	-	-	93.53	27.58	18.21	29.81	100	262	P	H
	*	2462	102.13	-	-	86.15	27.58	18.21	29.81	100	262	A	H
		2483.92	60.83	-13.17	74	44.88	27.53	18.24	29.82	100	262	P	H
		2483.52	51.86	-2.14	54	35.91	27.53	18.24	29.82	100	262	A	H
													H
													H
	*	2462	104.38	-	-	88.4	27.58	18.21	29.81	400	131	P	V
	*	2462	96.61	-	-	80.63	27.58	18.21	29.81	400	131	A	V
		2496.44	57.66	-16.34	74	41.72	27.51	18.26	29.83	400	131	P	V
		2483.68	47.92	-6.08	54	31.97	27.53	18.24	29.82	400	131	A	V
													V
													V
Remark	1. No other spurious found. 2. All results are PASS against Peak and Average limit line.												



**2.4GHz 2400~2483.5MHz
WIFI 802.11n HT20 (Harmonic @ 3m)**

WIFI Ant. 1	Note	Frequency (MHz)	Level (dBμV/m)	Over Limit (dB)	Limit Line (dBμV/m)	Read Level (dBμV)	Antenna Factor (dB/m)	Path Loss (dB)	Preamp Factor (dB)	Ant Pos (cm)	Table Pos (deg)	Peak Avg. (P/A)	Pol. (H/V)	
802.11n HT20 CH 01 2412MHz		4824	40.18	-33.82	74	55.69	31.15	12.43	59.09	100	0	P	H	
													H	
													H	
													H	
			4824	39.23	-34.77	74	54.74	31.15	12.43	59.09	100	0	P	V
														V
														V
802.11n HT20 CH 06 2437MHz		4874	39.95	-34.05	74	55.49	31.1	12.48	59.12	100	0	P	H	
		7311	46.16	-27.84	74	52.6	36.44	15.68	58.56	100	0	P	H	
													H	
													H	
			4874	40.22	-33.78	74	55.76	31.1	12.48	59.12	100	0	P	V
			7311	44.59	-29.41	74	51.03	36.44	15.68	58.56	100	0	P	V
														V
802.11n HT20 CH 11 2462MHz		4924	40.47	-33.53	74	56	31.1	12.52	59.15	100	0	P	H	
		7386	45.97	-28.03	74	52.24	36.53	15.66	58.46	100	0	P	H	
													H	
													H	
			4924	39.27	-34.73	74	54.8	31.1	12.52	59.15	100	0	P	V
			7386	45.34	-28.66	74	51.61	36.53	15.66	58.46	100	0	P	V
														V
Remark	1. No other spurious found.													
	2. All results are PASS against Peak and Average limit line.													



**2.4GHz 2400~2483.5MHz
WIFI 802.11n HT40 (Band Edge @ 3m)**

WIFI Ant. 1	Note	Frequency (MHz)	Level (dBμV/m)	Over Limit (dB)	Limit Line (dBμV/m)	Read Level (dBμV)	Antenna Factor (dB/m)	Path Loss (dB)	Preamp Factor (dB)	Ant Pos (cm)	Table Pos (deg)	Peak Avg. (P/A)	Pol. (H/V)
802.11n HT40 CH 03 2422MHz		2389.38	61.86	-12.14	74	45.91	27.64	18.09	29.78	114	56	P	H
		2389.38	52.54	-1.46	54	36.59	27.64	18.09	29.78	114	56	A	H
	*	2422	104.48	-	-	88.53	27.6	18.15	29.8	114	56	P	H
	*	2422	96.38	-	-	80.43	27.6	18.15	29.8	114	56	A	H
		2496.78	56.51	-17.49	74	40.57	27.51	18.26	29.83	114	56	P	H
		2485.72	47.29	-6.71	54	31.33	27.53	18.25	29.82	114	56	A	H
		2388.96	57.88	-16.12	74	41.93	27.64	18.09	29.78	281	21	P	V
		2389.52	49.46	-4.54	54	33.51	27.64	18.09	29.78	281	21	A	V
	*	2422	100.04	-	-	84.09	27.6	18.15	29.8	281	21	P	V
	*	2422	91.84	-	-	75.89	27.6	18.15	29.8	281	21	A	V
		2492.09	56.46	-17.54	74	40.51	27.52	18.26	29.83	281	21	P	V
		2488.24	46.89	-7.11	54	30.95	27.52	18.25	29.83	281	21	A	V
802.11n HT40 CH 06 2437MHz		2389.52	59.12	-14.88	74	43.17	27.64	18.09	29.78	103	276	P	H
		2389.66	50.55	-3.45	54	34.6	27.64	18.09	29.78	103	276	A	H
	*	2437	108.01	-	-	92.04	27.6	18.17	29.8	103	276	P	H
	*	2437	99.59	-	-	83.62	27.6	18.17	29.8	103	276	A	H
		2483.62	59.94	-14.06	74	43.99	27.53	18.24	29.82	103	276	P	H
		2483.69	51.2	-2.8	54	35.25	27.53	18.24	29.82	103	276	A	H
		2380.14	56.58	-17.42	74	40.6	27.68	18.08	29.78	364	133	P	V
		2389.94	48.03	-5.97	54	32.08	27.64	18.09	29.78	364	133	A	V
	*	2437	101.78	-	-	85.81	27.6	18.17	29.8	364	133	P	V
	*	2437	94.47	-	-	78.5	27.6	18.17	29.8	364	133	A	V
	2485.72	57	-17	74	41.04	27.53	18.25	29.82	364	133	P	V	
	2485.23	47.05	-6.95	54	31.09	27.53	18.25	29.82	364	133	A	V	



802.11n HT40 CH 09 2452MHz		2361.8	56.49	-17.51	74	40.46	27.75	18.05	29.77	105	276	P	H
		2389.1	47.23	-6.77	54	31.28	27.64	18.09	29.78	105	276	A	H
	*	2452	106.55	-	-	90.57	27.6	18.19	29.81	105	276	P	H
	*	2452	98.61	-	-	82.63	27.6	18.19	29.81	105	276	A	H
		2484.11	59.87	-14.13	74	43.92	27.53	18.24	29.82	105	276	P	H
		2483.5	52.25	-1.75	54	36.3	27.53	18.24	29.82	105	276	A	H
		2323.72	56.82	-17.18	74	40.69	27.91	17.98	29.76	400	133	P	V
		2388.68	46.95	-7.05	54	30.99	27.65	18.09	29.78	400	133	A	V
	*	2452	101.58	-	-	85.6	27.6	18.19	29.81	400	133	P	V
	*	2452	93.24	-	-	77.26	27.6	18.19	29.81	400	133	A	V
		2487.26	57.56	-16.44	74	41.6	27.53	18.25	29.82	400	133	P	V
		2484.25	48.67	-5.33	54	32.72	27.53	18.24	29.82	400	133	A	V
Remark	1. No other spurious found. 2. All results are PASS against Peak and Average limit line.												



**2.4GHz 2400~2483.5MHz
WIFI 802.11n HT40 (Harmonic @ 3m)**

WIFI Ant. 1	Note	Frequency (MHz)	Level (dBμV/m)	Over Limit (dB)	Limit Line (dBμV/m)	Read Level (dBμV)	Antenna Factor (dB/m)	Path Loss (dB)	Preamp Factor (dB)	Ant Pos (cm)	Table Pos (deg)	Peak Avg. (P/A)	Pol. (H/V)	
802.11n HT40 CH 03 2422MHz		4844	40.33	-33.67	74	55.78	31.19	12.47	59.11	100	0	P	H	
		7266	56.4	-17.6	74	63.11	36.33	15.59	58.63	100	236	P	H	
		7266	48.12	-5.88	54	54.83	36.33	15.59	58.63	100	236	A	H	
													H	
			4844	40.12	-33.88	74	55.57	31.19	12.47	59.11	100	0	P	V
			7266	54.01	-19.99	74	60.72	36.33	15.59	58.63	100	178	P	V
			7266	45.55	-8.45	54	52.26	36.33	15.59	58.63	100	178	A	V
802.11n HT40 CH 06 2437MHz													V	
			4874	39.11	-34.89	74	54.65	31.1	12.48	59.12	100	0	P	H
			7311	44.82	-29.18	74	51.26	36.44	15.68	58.56	100	0	P	H
													H	
													H	
			4874	39.1	-34.9	74	54.64	31.1	12.48	59.12	100	0	P	V
			7311	44.8	-29.2	74	51.24	36.44	15.68	58.56	100	0	P	V
802.11n HT40 CH 09 2452MHz													V	
			4904	40.43	-33.57	74	56.05	31.02	12.5	59.14	100	0	P	H
			7356	45.85	-28.15	74	52.1	36.59	15.66	58.5	100	0	P	H
													H	
													H	
			4904	39.42	-34.58	74	55.04	31.02	12.5	59.14	100	0	P	V
			7356	46.07	-27.93	74	52.32	36.59	15.66	58.5	100	0	P	V
Remark													V	
													V	
1. No other spurious found. 2. All results are PASS against Peak and Average limit line.														



Emission above 18GHz

2.4GHz WIFI 802.11g (SHF)

WIFI	Note	Frequency	Level	Over	Limit	Read	Antenna	Path	Preamp	Ant	Table	Peak	Pol.
Ant.				Limit	Line	Level	Factor	Loss	Factor	Pos	Pos	Avg.	
1		(MHz)	(dBμV/m)	(dB)	(dBμV/m)	(dBμV)	(dB/m)	(dB)	(dB)	(cm)	(deg)	(P/A)	(H/V)
2.4GHz 802.11g SHF		19085	38.54	-35.46	74	43.85	38.03	11.01	54.35	150	0	P	H
													H
													H
													H
													H
													H
													H
													H
													H
													H
													H
													H
													H
													H
													H
													H
													H
													H
													H
			19645	38.69	-35.31	74	43.73	37.73	11.24	54.01	150	0	P
													V
													V
													V
													V
													V
													V
													V
													V
													V
													V
													V
													V
													V
													V
Remark	1. No other spurious found. 2. All results are PASS against limit line.												



Emission below 1GHz
2.4GHz WIFI 802.11g (LF)

WIFI	Note	Frequency	Level	Over	Limit	Read	Antenna	Path	Preamp	Ant	Table	Peak	Pol.	
Ant.				Limit	Line	Level	Factor	Loss	Factor	Pos	Pos	Avg.		
1		(MHz)	(dBμV/m)	(dB)	(dBμV/m)	(dBμV)	(dB/m)	(dB)	(dB)	(cm)	(deg)	(P/A)	(H/V)	
2.4GHz 802.11g LF		88.2	30.54	-12.96	43.5	47.12	14.32	1.39	32.29	100	0	P	H	
		144.46	29.61	-13.89	43.5	42.79	17.21	1.89	32.28	-	-	P	H	
		181.32	24.38	-19.12	43.5	39.7	14.84	2.15	32.31	-	-	P	H	
		461.65	26.87	-19.13	46	32.03	23.39	3.58	32.13	-	-	P	H	
		557.68	28.48	-17.52	46	30.42	26.05	4	31.99	-	-	P	H	
		826.37	32.36	-13.64	46	31.32	28.3	4.99	32.25	-	-	P	H	
														H
														H
														H
														H
														H
														H
			50.37	29.42	-10.58	40	46.84	14.07	0.94	32.43	-	-	P	V
			86.26	33.62	-6.38	40	50.37	14.18	1.37	32.3	100	0	P	V
			148.34	25.14	-18.36	43.5	38.45	17.04	1.93	32.28	-	-	P	V
			184.23	24.02	-19.48	43.5	39.4	14.77	2.16	32.31	-	-	P	V
			264.74	20.28	-25.72	46	29.89	20.04	2.7	32.35	-	-	P	V
			893.3	35.32	-10.68	46	33.07	28.98	5.22	31.95	-	-	P	V
														V
														V
													V	
													V	
													V	
													V	
Remark	1. No other spurious found. 2. All results are PASS against limit line.													



2.4GHz 2400~2483.5MHz

WIFI 802.11b (Band Edge @ 3m)

WIFI	Note	Frequency	Level	Over	Limit	Read	Antenna	Path	Preamp	Ant	Table	Peak	Pol.	
Ant.				Limit	Line	Level	Factor	Loss	Factor	Pos	Pos	Avg.		
0+1		(MHz)	(dBμV/m)	(dB)	(dBμV/m)	(dBμV)	(dB/m)	(dB)	(dB)	(cm)	(deg)	(P/A)	(H/V)	
802.11b CH 01 2412MHz		2386.23	58.92	-15.08	74	42.95	27.66	18.09	29.78	131	205	P	H	
		2386.44	51.3	-2.7	54	35.34	27.65	18.09	29.78	131	205	A	H	
	*	2412	114.25	-	-	98.31	27.6	18.13	29.79	131	205	P	H	
	*	2412	111.08	-	-	95.14	27.6	18.13	29.79	131	205	A	H	
													H	
														H
			2386.65	56.78	-17.22	74	40.82	27.65	18.09	29.78	369	127	P	V
			2388.12	46.06	-7.94	54	30.1	27.65	18.09	29.78	369	127	A	V
	*		2412	109.9	-	-	93.96	27.6	18.13	29.79	369	127	P	V
	*		2412	106.78	-	-	90.84	27.6	18.13	29.79	369	127	A	V
														V
														V
802.11b CH 06 2437MHz		2388.82	56.66	-17.34	74	40.71	27.64	18.09	29.78	100	276	P	H	
		2389.94	45.14	-8.86	54	29.19	27.64	18.09	29.78	100	276	A	H	
	*	2437	114.42	-	-	98.45	27.6	18.17	29.8	100	276	P	H	
	*	2437	111.29	-	-	95.32	27.6	18.17	29.8	100	276	A	H	
			2483.55	57.54	-16.46	74	41.59	27.53	18.24	29.82	100	276	P	H
			2484.04	45.1	-8.9	54	29.15	27.53	18.24	29.82	100	276	A	H
			2355.92	56.81	-17.19	74	40.76	27.78	18.04	29.77	362	106	P	V
			2389.94	44.66	-9.34	54	28.71	27.64	18.09	29.78	362	106	A	V
	*		2437	109.78	-	-	93.81	27.6	18.17	29.8	362	106	P	V
	*		2437	106.74	-	-	90.77	27.6	18.17	29.8	362	106	A	V
			2487.75	56.99	-17.01	74	41.04	27.52	18.25	29.82	362	106	P	V
			2494.19	44.72	-9.28	54	28.78	27.51	18.26	29.83	362	106	A	V



802.11b CH 11 2462MHz	*	2462	113.58	-	-	97.6	27.58	18.21	29.81	100	276	P	H
	*	2462	110.63	-	-	94.65	27.58	18.21	29.81	100	276	A	H
		2483.52	60.12	-13.88	74	44.17	27.53	18.24	29.82	100	276	P	H
		2483.52	52.33	-1.67	54	36.38	27.53	18.24	29.82	100	276	A	H
													H
													H
	*	2462	108.9	-	-	92.92	27.58	18.21	29.81	356	103	P	V
	*	2462	105.84	-	-	89.86	27.58	18.21	29.81	356	103	A	V
		2488.12	58.48	-15.52	74	42.54	27.52	18.25	29.83	356	103	P	V
		2483.52	48.39	-5.61	54	32.44	27.53	18.24	29.82	356	103	A	V
													V
													V
Remark	1. No other spurious found. 2. All results are PASS against Peak and Average limit line.												



**2.4GHz 2400~2483.5MHz
WIFI 802.11b (Harmonic @ 3m)**

WIFI Ant. 0+1	Note	Frequency (MHz)	Level (dBµV/m)	Over Limit (dB)	Limit Line (dBµV/m)	Read Level (dBµV)	Antenna Factor (dB/m)	Path Loss (dB)	Preamp Factor (dB)	Ant Pos (cm)	Table Pos (deg)	Peak Avg. (P/A)	Pol. (H/V)
802.11b CH 01 2412MHz		4824	40.62	-33.38	74	55.2	31.15	13.36	59.09	100	0	P	H
													H
													H
													H
		4824	42.48	-31.52	74	57.06	31.15	13.36	59.09	100	0	P	V
													V
													V
802.11b CH 06 2437MHz		4874	40.86	-33.14	74	56.4	31.1	12.48	59.12	100	0	P	H
		7311	45.31	-28.69	74	51.75	36.44	15.68	58.56	100	0	P	H
													H
													H
		4874	40.48	-33.52	74	56.02	31.1	12.48	59.12	100	0	P	V
		7311	45.29	-28.71	74	51.73	36.44	15.68	58.56	100	0	P	V
													V
802.11b CH 11 2462MHz		4924	40.51	-33.49	74	56.04	31.1	12.52	59.15	100	0	P	H
		7386	44.93	-29.07	74	51.2	36.53	15.66	58.46	100	0	P	H
													H
													H
		4924	42.07	-31.93	74	57.6	31.1	12.52	59.15	100	0	P	V
		7386	46.5	-27.5	74	52.77	36.53	15.66	58.46	100	0	P	V
													V
Remark	1. No other spurious found.												
	2. All results are PASS against Peak and Average limit line.												



**2.4GHz 2400~2483.5MHz
WIFI 802.11g (Band Edge @ 3m)**

WIFI Ant. 0+1	Note	Frequency (MHz)	Level (dBμV/m)	Over Limit (dB)	Limit Line (dBμV/m)	Read Level (dBμV)	Antenna Factor (dB/m)	Path Loss (dB)	Preamp Factor (dB)	Ant Pos (cm)	Table Pos (deg)	Peak Avg. (P/A)	Pol. (H/V)	
802.11g CH 01 2412MHz		2388.855	63.14	-10.86	74	47.19	27.64	18.09	29.78	103	108	P	H	
		2389.275	52.15	-1.85	54	36.2	27.64	18.09	29.78	103	108	A	H	
	*	2412	110.95	-	-	95.01	27.6	18.13	29.79	103	108	P	H	
	*	2412	103.79	-	-	87.85	27.6	18.13	29.79	103	108	A	H	
													H	
														H
			2389.8	58.9	-15.1	74	42.95	27.64	18.09	29.78	396	346	P	V
			2389.485	49.16	-4.84	54	33.21	27.64	18.09	29.78	396	346	A	V
	*		2412	107.8	-	-	91.86	27.6	18.13	29.79	396	346	P	V
	*		2412	100.59	-	-	84.65	27.6	18.13	29.79	396	346	A	V
														V
														V
802.11g CH 06 2437MHz		2388.4	58.95	-15.05	74	42.99	27.65	18.09	29.78	100	298	P	H	
		2388.96	48.28	-5.72	54	32.33	27.64	18.09	29.78	100	298	A	H	
	*	2437	115.42	-	-	99.45	27.6	18.17	29.8	100	298	P	H	
	*	2437	108.83	-	-	92.86	27.6	18.17	29.8	100	298	A	H	
			2485.51	59.44	-14.56	74	43.48	27.53	18.25	29.82	100	298	P	H
			2483.5	48.17	-5.83	54	32.22	27.53	18.24	29.82	100	298	A	H
			2388.82	57.88	-16.12	74	41.93	27.64	18.09	29.78	363	2	P	V
			2388.96	47.01	-6.99	54	31.06	27.64	18.09	29.78	363	2	A	V
	*		2437	112.64	-	-	96.67	27.6	18.17	29.8	363	2	P	V
	*		2437	105.82	-	-	89.85	27.6	18.17	29.8	363	2	A	V
			2483.83	56.95	-17.05	74	41	27.53	18.24	29.82	363	2	P	V
			2484.18	46.87	-7.13	54	30.92	27.53	18.24	29.82	363	2	A	V



802.11g CH 11 2462MHz	*	2462	110.38	-	-	94.4	27.58	18.21	29.81	100	209	P	H
	*	2462	102.19	-	-	86.21	27.58	18.21	29.81	100	209	A	H
		2484.48	65.63	-8.37	74	49.67	27.53	18.25	29.82	100	209	P	H
		2483.6	52.35	-1.65	54	36.4	27.53	18.24	29.82	100	209	A	H
													H
													H
	*	2462	105.8	-	-	89.82	27.58	18.21	29.81	242	348	P	V
	*	2462	98.43	-	-	82.45	27.58	18.21	29.81	242	348	A	V
		2484.92	59.18	-14.82	74	43.22	27.53	18.25	29.82	242	348	P	V
		2485.2	47.59	-6.41	54	31.63	27.53	18.25	29.82	242	348	A	V
													V
													V
Remark	1. No other spurious found. 2. All results are PASS against Peak and Average limit line.												



**2.4GHz 2400~2483.5MHz
WIFI 802.11g (Harmonic @ 3m)**

WIFI Ant. 0+1	Note	Frequency (MHz)	Level (dBμV/m)	Over Limit (dB)	Limit Line (dBμV/m)	Read Level (dBμV)	Antenna Factor (dB/m)	Path Loss (dB)	Preamp Factor (dB)	Ant Pos (cm)	Table Pos (deg)	Peak Avg. (P/A)	Pol. (H/V)	
802.11g CH 01 2412MHz		4824	39.78	-34.22	74	55.29	31.15	12.43	59.09	100	0	P	H	
													H	
													H	
													H	
			4824	39.81	-34.19	74	55.32	31.15	12.43	59.09	100	0	P	V
														V
														V
802.11g CH 06 2437MHz		4874	39.58	-34.42	74	55.12	31.1	12.48	59.12	100	0	P	H	
		7311	45.5	-28.5	74	51.94	36.44	15.68	58.56	100	0	P	H	
													H	
													H	
			4874	40.64	-33.36	74	56.18	31.1	12.48	59.12	100	0	P	V
			7311	44.83	-29.17	74	51.27	36.44	15.68	58.56	100	0	P	V
														V
802.11g CH 11 2462MHz		4924	39.49	-34.51	74	55.01	31.1	12.53	59.15	100	0	P	H	
		7386	61.68	-12.32	74	68.01	36.53	15.6	58.46	100	236	P	H	
		7386	49.77	-4.23	54	56.1	36.53	15.6	58.46	100	236	A	H	
													H	
			4924	39.81	-34.19	74	55.33	31.1	12.53	59.15	100	0	P	V
			7386	57.99	-16.01	74	64.32	36.53	15.6	58.46	100	181	P	V
			7386	46.03	-7.97	54	52.36	36.53	15.6	58.46	100	181	A	V
													V	
Remark	1. No other spurious found. 2. All results are PASS against Peak and Average limit line.													



**2.4GHz 2400~2483.5MHz
WIFI 802.11n HT20 (Band Edge @ 3m)**

WIFI Ant. 0+1	Note	Frequency (MHz)	Level (dBµV/m)	Over Limit (dB)	Limit Line (dBµV/m)	Read Level (dBµV)	Antenna Factor (dB/m)	Path Loss (dB)	Preamp Factor (dB)	Ant Pos (cm)	Table Pos (deg)	Peak Avg. (P/A)	Pol. (H/V)	
802.11n HT20 CH 01 2412MHz		2389.905	62.92	-11.08	74	46.97	27.64	18.09	29.78	137	216	P	H	
		2390	52.01	-1.99	54	36.06	27.64	18.09	29.78	137	216	A	H	
	*	2412	109.06	-	-	93.12	27.6	18.13	29.79	137	216	P	H	
	*	2412	101.48	-	-	85.54	27.6	18.13	29.79	137	216	A	H	
													H	
														H
			2389.905	59.82	-14.18	74	43.87	27.64	18.09	29.78	368	127	P	V
			2390	48.18	-5.82	54	32.23	27.64	18.09	29.78	368	127	A	V
		*	2412	105.3	-	-	89.36	27.6	18.13	29.79	368	127	P	V
		*	2412	97.43	-	-	81.49	27.6	18.13	29.79	368	127	A	V
													V	
													V	
802.11n HT20 CH 06 2437MHz		2389.94	60.43	-13.57	74	44.48	27.64	18.09	29.78	104	271	P	H	
		2389.24	48.92	-5.08	54	32.97	27.64	18.09	29.78	104	271	A	H	
	*	2437	117.3	-	-	101.33	27.6	18.17	29.8	104	271	P	H	
	*	2437	108.91	-	-	92.94	27.6	18.17	29.8	104	271	A	H	
			2483.76	59.76	-14.24	74	43.81	27.53	18.24	29.82	104	271	P	H
			2483.5	49.14	-4.86	54	33.19	27.53	18.24	29.82	104	271	A	H
			2341.22	57.37	-16.63	74	41.28	27.84	18.01	29.76	216	15	P	V
			2389.94	47.4	-6.6	54	31.45	27.64	18.09	29.78	216	15	A	V
		*	2437	113.4	-	-	97.43	27.6	18.17	29.8	216	15	P	V
		*	2437	105.7	-	-	89.73	27.6	18.17	29.8	216	15	A	V
		2483.76	57.77	-16.23	74	41.82	27.53	18.24	29.82	216	15	P	V	
		2483.5	47.97	-6.03	54	32.02	27.53	18.24	29.82	216	15	A	V	



802.11n HT20 CH 11 2462MHz	*	2462	108.88	-	-	92.9	27.58	18.21	29.81	109	207	P	H
	*	2462	101.01	-	-	85.03	27.58	18.21	29.81	109	207	A	H
		2484.32	61.56	-12.44	74	45.61	27.53	18.24	29.82	109	207	P	H
		2483.52	52.1	-1.9	54	36.15	27.53	18.24	29.82	109	207	A	H
													H
													H
	*	2462	104.43	-	-	88.45	27.58	18.21	29.81	400	125	P	V
	*	2462	96.37	-	-	80.39	27.58	18.21	29.81	400	125	A	V
		2484.04	57.99	-16.01	74	42.04	27.53	18.24	29.82	400	125	P	V
		2483.68	47.6	-6.4	54	31.65	27.53	18.24	29.82	400	125	A	V
													V
													V
Remark	1. No other spurious found. 2. All results are PASS against Peak and Average limit line.												



**2.4GHz 2400~2483.5MHz
WIFI 802.11n HT20 (Harmonic @ 3m)**

WIFI Ant. 0+1	Note	Frequency (MHz)	Level (dBμV/m)	Over Limit (dB)	Limit Line (dBμV/m)	Read Level (dBμV)	Antenna Factor (dB/m)	Path Loss (dB)	Preamp Factor (dB)	Ant Pos (cm)	Table Pos (deg)	Peak Avg. (P/A)	Pol. (H/V)	
802.11n HT20 CH 01 2412MHz		4824	39.48	-34.52	74	54.97	31.15	12.45	59.09	100	0	P	H	
													H	
													H	
													H	
			4824	39.71	-34.29	74	55.2	31.15	12.45	59.09	100	0	P	V
														V
														V
802.11n HT20 CH 06 2437MHz		4874	40.68	-33.32	74	56.22	31.1	12.48	59.12	100	0	P	H	
													H	
			7311	45.69	-28.31	74	52.13	36.44	15.68	58.56	100	0	P	H
														H
			4874	39.89	-34.11	74	55.43	31.1	12.48	59.12	100	0	P	V
			7311	45.36	-28.64	74	51.8	36.44	15.68	58.56	100	0	P	V
														V
802.11n HT20 CH 11 2462MHz		4924	39.95	-34.05	74	55.48	31.1	12.52	59.15	100	0	P	H	
			7386	58.74	-15.26	74	65.01	36.53	15.66	58.46	100	233	P	H
			7386	46.57	-7.43	54	52.84	36.53	15.66	58.46	100	233	A	H
														H
			4924	39.9	-34.1	74	55.43	31.1	12.52	59.15	100	0	P	V
			7386	57.68	-16.32	74	63.95	36.53	15.66	58.46	100	179	P	V
			7386	45.5	-8.5	54	51.77	36.53	15.66	58.46	100	179	A	V
													V	
Remark	1. No other spurious found. 2. All results are PASS against Peak and Average limit line.													



**2.4GHz 2400~2483.5MHz
WIFI 802.11n HT40 (Band Edge @ 3m)**

WIFI Ant. 0+1	Note	Frequency (MHz)	Level (dBμV/m)	Over Limit (dB)	Limit Line (dBμV/m)	Read Level (dBμV)	Antenna Factor (dB/m)	Path Loss (dB)	Preamp Factor (dB)	Ant Pos (cm)	Table Pos (deg)	Peak Avg. (P/A)	Pol. (H/V)
802.11n HT40 CH 03 2422MHz		2385.88	60.09	-13.91	74	44.12	27.66	18.09	29.78	133	206	P	H
		2389.52	52.51	-1.49	54	36.56	27.64	18.09	29.78	133	206	A	H
	*	2422	104.48	-	-	88.53	27.6	18.15	29.8	133	206	P	H
	*	2422	96.34	-	-	80.39	27.6	18.15	29.8	133	206	A	H
		2491.53	56.63	-17.37	74	40.68	27.52	18.26	29.83	133	206	P	H
		2483.83	46.98	-7.02	54	31.03	27.53	18.24	29.82	133	206	A	H
		2386.72	58.1	-15.9	74	42.14	27.65	18.09	29.78	370	88	P	V
		2389.38	49.41	-4.59	54	33.46	27.64	18.09	29.78	370	88	A	V
	*	2422	100.49	-	-	84.54	27.6	18.15	29.8	370	88	P	V
	*	2422	92.6	-	-	76.65	27.6	18.15	29.8	370	88	A	V
		2487.68	56.77	-17.23	74	40.82	27.52	18.25	29.82	370	88	P	V
		2489.43	46.87	-7.13	54	30.93	27.52	18.25	29.83	370	88	A	V
802.11n HT40 CH 06 2437MHz		2388.68	63.44	-10.56	74	47.48	27.65	18.09	29.78	141	209	P	H
		2389.52	52.81	-1.19	54	36.86	27.64	18.09	29.78	141	209	A	H
	*	2437	108.08	-	-	92.11	27.6	18.17	29.8	141	209	P	H
	*	2437	100.72	-	-	84.75	27.6	18.17	29.8	141	209	A	H
		2485.72	60.58	-13.42	74	44.62	27.53	18.25	29.82	141	209	P	H
		2484.32	50.95	-3.05	54	35	27.53	18.24	29.82	141	209	A	H
		2361.52	56.64	-17.36	74	40.61	27.75	18.05	29.77	363	110	P	V
		2385.18	46.98	-7.02	54	31.01	27.66	18.09	29.78	363	110	A	V
	*	2437	106.43	-	-	90.46	27.6	18.17	29.8	363	110	P	V
	*	2437	98.34	-	-	82.37	27.6	18.17	29.8	363	110	A	V
		2493.7	56.33	-17.67	74	40.39	27.51	18.26	29.83	363	110	P	V
		2483.55	47.59	-6.41	54	31.64	27.53	18.24	29.82	363	110	A	V



802.11n HT40 CH 09 2452MHz		2359.84	56.77	-17.23	74	40.74	27.76	18.04	29.77	141	211	P	H
		2312.94	47.13	-6.87	54	30.96	27.95	17.97	29.75	141	211	A	H
	*	2452	106.68	-	-	90.7	27.6	18.19	29.81	141	211	P	H
	*	2452	99.36	-	-	83.38	27.6	18.19	29.81	141	211	A	H
		2484.39	61.59	-12.41	74	45.63	27.53	18.25	29.82	141	211	P	H
		2484.18	52.43	-1.57	54	36.48	27.53	18.24	29.82	141	211	A	H
		2353.4	57.08	-16.92	74	41.03	27.79	18.03	29.77	400	114	P	V
		2334.64	46.73	-7.27	54	30.63	27.86	18	29.76	400	114	A	V
	*	2452	101.69	-	-	85.71	27.6	18.19	29.81	400	114	P	V
	*	2452	94.2	-	-	78.22	27.6	18.19	29.81	400	114	A	V
		2489.15	56.73	-17.27	74	40.79	27.52	18.25	29.83	400	114	P	V
		2489.15	47.56	-6.44	54	31.62	27.52	18.25	29.83	400	114	A	V
Remark	1. No other spurious found. 2. All results are PASS against Peak and Average limit line.												



**2.4GHz 2400~2483.5MHz
WIFI 802.11n HT40 (Harmonic @ 3m)**

WIFI Ant. 0+1	Note	Frequency (MHz)	Level (dBµV/m)	Over Limit (dB)	Limit Line (dBµV/m)	Read Level (dBµV)	Antenna Factor (dB/m)	Path Loss (dB)	Preamp Factor (dB)	Ant Pos (cm)	Table Pos (deg)	Peak Avg. (P/A)	Pol. (H/V)
802.11n HT40 CH 03 2422MHz		4844	39.9	-34.1	74	55.38	31.19	12.44	59.11	100	0	P	H
		7266	47.49	-26.51	74	54.11	36.33	15.68	58.63	100	0	P	H
													H
													H
		4844	39.9	-34.1	74	55.38	31.19	12.44	59.11	100	0	P	V
		7266	46.52	-27.48	74	53.14	36.33	15.68	58.63	100	0	P	V
802.11n HT40 CH 06 2437MHz		4874	39.31	-34.69	74	54.85	31.1	12.48	59.12	100	0	P	H
		7311	59.73	-14.27	74	66.17	36.44	15.68	58.56	100	236	P	H
		7311	50.17	-3.83	54	56.61	36.44	15.68	58.56	100	236	A	H
													H
		4874	39.51	-34.49	74	55.05	31.1	12.48	59.12	100	0	P	V
		7311	56.47	-17.53	74	62.91	36.44	15.68	58.56	100	178	P	V
		7311	47.03	-6.97	54	53.47	36.44	15.68	58.56	100	178	A	V
802.11n HT40 CH 09 2452MHz		4904	38.96	-35.04	74	54.58	31.02	12.5	59.14	100	0	P	H
		7356	53.42	-20.58	74	59.67	36.59	15.66	58.5	100	235	P	H
		7356	44.82	-9.18	54	51.07	36.59	15.66	58.5	100	235	A	H
													H
		4904	39.65	-34.35	74	55.27	31.02	12.5	59.14	100	0	P	V
		7356	51.57	-22.43	74	57.82	36.59	15.66	58.5	100	173	P	V
		7356	42.75	-11.25	54	49	36.59	15.66	58.5	100	173	A	V
													V
Remark	1. No other spurious found. 2. All results are PASS against Peak and Average limit line.												



**Emission above 18GHz
2.4GHz WIFI 802.11n HT40 (SHF)**

WIFI	Note	Frequency	Level	Over	Limit	Read	Antenna	Path	Preamp	Ant	Table	Peak	Pol.
Ant.				Limit	Line	Level	Factor	Loss	Factor	Pos	Pos	Avg.	
0+1		(MHz)	(dBμV/m)	(dB)	(dBμV/m)	(dBμV)	(dB/m)	(dB)	(dB)	(cm)	(deg)	(P/A)	(H/V)
2.4GHz 802.11n HT40 SHF		21199	39.47	-34.53	74	42.48	38.24	12.19	53.44	150	0	P	H
													H
													H
													H
													H
													H
													H
													H
													H
													H
													H
													H
													H
													H
													H
													H
													H
													H
													H
			19442	38.94	-35.06	74	44.16	37.75	11.16	54.13	150	0	P
													V
													V
													V
													V
													V
													V
													V
													V
													V
													V
													V
													V
													V
													V
Remark	1. No other spurious found. 2. All results are PASS against limit line.												



Note symbol

*	Fundamental Frequency which can be ignored. However, the level of any unwanted emissions shall not exceed the level of the fundamental frequency.
!	Test result is over limit line.
P/A	Peak or Average
H/V	Horizontal or Vertical



A calculation example for radiated spurious emission is shown as below:

WIFI	Note	Frequency	Level	Over	Limit	Read	Antenna	Path	Preamp	Ant	Table	Peak	Pol.
Ant.				Limit	Line	Level	Factor	Loss	Factor	Pos	Pos	Avg.	
0+1		(MHz)	(dBμV/m)	(dB)	(dBμV/m)	(dBμV)	(dB/m)	(dB)	(dB)	(cm)	(deg)	(P/A)	(H/V)
802.11b		2390	55.45	-18.55	74	54.51	32.22	4.58	35.86	103	308	P	H
CH 01													
2412MHz		2390	43.54	-10.46	54	42.6	32.22	4.58	35.86	103	308	A	H

1. Path Loss(dB) = Cable loss(dB) + Filter loss(dB) + Attenuator loss(dB)
2. Level(dBμV/m) =
Antenna Factor(dB/m) + Path Loss(dB) + Read Level(dBμV) - Preamp Factor(dB)
3. Over Limit(dB) = Level(dBμV/m) – Limit Line(dBμV/m)

For Peak Limit @ 2390MHz:

1. Level(dBμV/m)
= Antenna Factor(dB/m) + Path Loss(dB) + Read Level(dBμV) - Preamp Factor(dB)
= 32.22(dB/m) + 4.58(dB) + 54.51(dBμV) – 35.86 (dB)
= 55.45 (dBμV/m)
2. Over Limit(dB)
= Level(dBμV/m) – Limit Line(dBμV/m)
= 55.45(dBμV/m) – 74(dBμV/m)
= -18.55(dB)

For Average Limit @ 2390MHz:

1. Level(dBμV/m)
= Antenna Factor(dB/m) + Path Loss(dB) + Read Level(dBμV) - Preamp Factor(dB)
= 32.22(dB/m) + 4.58(dB) + 42.6(dBμV) – 35.86 (dB)
= 43.54 (dBμV/m)
2. Over Limit(dB)
= Level(dBμV/m) – Limit Line(dBμV/m)
= 43.54(dBμV/m) – 54(dBμV/m)
= -10.46(dB)

Both peak and average measured complies with the limit line, so test result is “PASS”.



Appendix C. Radiated Spurious Emission Plots

Test Engineer :	Andy Yang, Karl Hou and CR Liao	Temperature :	20~25°C
		Relative Humidity :	50~65%

Note symbol

-L	Low channel location
-R	High channel location

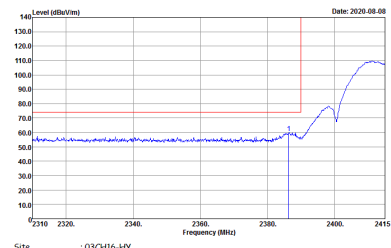
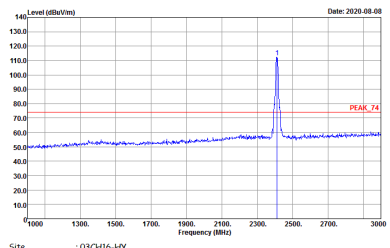
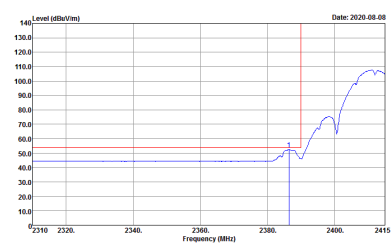
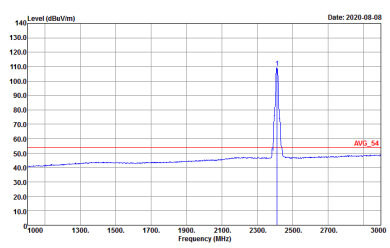

2.4GHz 2400~2483.5MHz
WIFI 802.11b (Band Edge @ 3m)

WIFI	2.4GHz 2400~2483.5MHz Band Edge @ 3m	
ANT	802.11b CH01 2412MHz	
0	Horizontal	Fundamental
Peak	 <p>Site : 03CH16-HY Condition : PEAK_BE_74 3m 91200_1522 HORIZONTAL RBW:1000.000KHz VBW:3000.000KHz SWT:Auto Detector : Peak Project : 070401</p>	 <p>Site : 03CH16-HY Condition : PEAK_74 3m 91200_1522 HORIZONTAL RBW:1000.000KHz VBW:3000.000KHz SWT:Auto Detector : Peak Project : 070401</p>
Avg.	 <p>Site : 03CH16-HY Condition : AV6_BE_54 3m 91200_1522 HORIZONTAL RBW:1000.000KHz VBW:0.010KHz SWT:Auto Detector : Peak Project : 070401</p>	 <p>Site : 03CH16-HY Condition : AV6_54 3m 91200_1522 HORIZONTAL RBW:1000.000KHz VBW:0.010KHz SWT:Auto Detector : Peak Project : 070401</p>