



FCC RADIO TEST REPORT

FCC ID : UZ7EC55AK
Equipment : Enterprise Computer
Brand Name : Zebra
Model Name : EC55AK
Applicant : Zebra Technologies Corporation
1 Zebra Plaza, Holtsville, NY 11742
Manufacturer : Zebra Technologies Corporation
1 Zebra Plaza, Holtsville, NY 11742
Standard : FCC Part 15 Subpart C §15.247

The product was received on Jul. 22, 2020 and testing was started from Aug. 08, 2020 and completed on Sep. 23, 2020. We, SPORTON INTERNATIONAL INC., EMC & Wireless Communications Laboratory, would like to declare that the tested sample has been evaluated in accordance with the test procedures and has been in compliance with the applicable technical standards.

The test results in this report apply exclusively to the tested model / sample. Without written approval of SPORTON INTERNATIONAL INC. EMC & Wireless Communications Laboratory, the test report shall not be reproduced except in full.

Louis Wu

Approved by: Louis Wu

SPORTON INTERNATIONAL INC. EMC & Wireless Communications Laboratory

No. 52, Huaya 1st Rd., Guishan Dist., Taoyuan City, Taiwan (R.O.C.)



Table of Contents

History of this test report.....	3
Summary of Test Result.....	4
1 General Description.....	5
1.1 Product Feature of Equipment Under Test.....	5
1.2 Product Specification of Equipment Under Test.....	6
1.3 Modification of EUT	6
1.4 Testing Location	7
1.5 Applicable Standards.....	7
2 Test Configuration of Equipment Under Test.....	8
2.1 Carrier Frequency Channel	8
2.2 Test Mode.....	9
2.3 Connection Diagram of Test System.....	11
2.4 Support Unit used in test configuration and system	12
2.5 EUT Operation Test Setup	12
2.6 Measurement Results Explanation Example.....	12
3 Test Result.....	13
3.1 6dB and 99% Bandwidth Measurement	13
3.2 Output Power Measurement.....	30
3.3 Power Spectral Density Measurement	32
3.4 Conducted Band Edges and Spurious Emission Measurement	50
3.5 Radiated Band Edges and Spurious Emission Measurement	67
3.6 AC Conducted Emission Measurement.....	72
3.7 Antenna Requirements.....	74
4 List of Measuring Equipment	75
5 Uncertainty of Evaluation.....	77
Appendix A. AC Conducted Emission Test Result	
Appendix B. Radiated Spurious Emission	
Appendix C. Radiated Spurious Emission Plots	
Appendix D. Duty Cycle Plots	
Appendix E. Setup Photographs	



History of this test report

Report No.	Version	Description	Issued Date
FR070401B	01	Initial issue of report	Oct. 27, 2020



Summary of Test Result

Report Clause	Ref Std. Clause	Test Items	Result (PASS/FAIL)	Remark
3.1	15.247(a)(2)	6dB Bandwidth	Pass	-
3.1	2.1049	99% Occupied Bandwidth	Reporting only	-
3.2	15.247(b)(3)	Output Power	Pass	-
3.3	15.247(e)	Power Spectral Density	Pass	-
3.4	15.247(d)	Conducted Band Edges and Spurious Emission	Pass	-
3.5	15.247(d)	Radiated Band Edges and Spurious Emission	Pass	Under limit 4.68 dB at 2490.240 MHz for WCN3990 Under limit 4.82 dB at 2488.360 MHz for NRF52810
3.6	15.207	AC Conducted Emission	Pass	Under limit 12.64 dB at 0.159 MHz
3.7	15.203 & 15.247(b)	Antenna Requirement	Pass	-

Declaration of Conformity:

The test results with all measurement uncertainty excluded are presented in accordance with the regulation limits or requirements declared by manufacturers.

Comments and Explanations:

The declared of product specification for EUT presented in the report are provided by the manufacturer, and the manufacturer takes all the responsibilities for the accuracy of product specification.

Reviewed by: Wii Chang

Report Producer: Ruby Zou



1 General Description

1.1 Product Feature of Equipment Under Test

Product Feature	
Equipment	Enterprise Computer
Brand Name	Zebra
Model Name	EC55AK
FCC ID	UZ7EC55AK
EUT supports Radios application	WCDMA/HSPA/LTE/NFC/GNSS WLAN 11a/b/g/n HT20/HT40 WLAN 11ac VHT20/VHT40/VHT80 Bluetooth BR/EDR/LE
HW Version	EV2
SW Version	Android version 10
FW Version	10-13-12.00-QG-U00-PRD-HEL-04
MFD	22JUN20 17JUN20
EUT Stage	Engineering Sample

Remark: The above EUT's information was declared by manufacturer.

Specification of Accessories				
AC Adapter	Brand Name	Zebra	Part Number	PWR-WUA5V15W0US
USB TYPE-C to TYPE-C cable	Brand Name	Zebra	Part Number	CBL-EC5X-USBC3A-01
Battery 1	Brand Name	Zebra	Part Number	BT-000424-00
Battery 2	Brand Name	Zebra	Part Number	BT-000424-08
Earphone 1	Brand Name	Zebra	Part Number	HDST-35MM-PTVP-01
Earphone 2	Brand Name	Zebra	Part Number	HS2100-OTH
USB TYPE C to 3.5mm audio connector	Brand Name	Symbol	Part Number	ADP-USBC-35MM1-01
3.5mm Jack 43"(1.1m) Standard Cable	Brand Name	Zebra	Part Number	CBL-HS2100-3MS1-01
Trigger Handle	Brand Name	Zebra	Part Number	TRG-EC5X-SNP1-01
Soft Holster	Brand Name	Zebra	Part Number	SG-EC5X-HLSTR1-01
Protective Boot	Brand Name	Zebra	Part Number	SG-EC5X-BOOT1-01

Sample list				
	Sample 1	Sample 2	Sample 3	Sample 4
Operating System	ANDROID	ANDROID	ANDROID	ANDROID
RAM	3GB	3GB	4GB	4GB
FLASH	32GB	32GB	64GB	64GB
Scanner	NO	SE4100	SE4100	SE4100
Front Camera	5MP	NO	5MP	5MP
Rear Camera	13MP	13MP	13MP	13MP
	MICRO SD	MICRO SD	MICRO SD	MICRO SD
	GMS	GMS	GMS	GMS
Back connector	NO I/O CONNECTOR	2-PIN	2-PIN	8-PIN
	US	US	US	US

1.2 Product Specification of Equipment Under Test

Product Specification subjective to this standard	
Tx/Rx Frequency Range	2402 MHz ~ 2480 MHz
Number of Channels	40
Carrier Frequency of Each Channel	40 Channel (37 hopping + 3 advertising channel)
Maximum Output Power to Antenna	<WCN3990> 5.80 dBm (0.0038 W) for 1Mbps 5.80 dBm (0.0038 W) for 2Mbps <NRF52810> 2.60 dBm (0.0018 W) for 1Mbps 2.50 dBm (0.0018 W) for 2Mbps
99% Occupied Bandwidth	<WCN3990> 1.028 MHz for 1Mbps 2.040 MHz for 2Mbps <NRF52810> 1.044 MHz for 1Mbps 2.052 MHz for 2Mbps
Antenna Type / Gain	PIFA Antenna type with gain 1.5 dBi
Type of Modulation	Bluetooth LE : GFSK

1.3 Modification of EUT

No modifications are made to the EUT during all test items.



1.4 Testing Location

Test Site	SPORTON INTERNATIONAL INC. EMC & Wireless Communications Laboratory	
Test Site Location	No.52, Huaya 1st Rd., Guishan Dist., Taoyuan City, Taiwan (R.O.C.) TEL: +886-3-327-3456 FAX: +886-3-328-4978	
Test Site No.	Sporton Site No.	
	TH05-HY	CO05-HY

Note: The test site complies with ANSI C63.4 2014 requirement.

Test Site	SPORTON INTERNATIONAL INC. EMC & Wireless Communications Laboratory	
Test Site Location	No.58, Aly. 75, Ln. 564, Wenhua 3rd, Rd., Guishan Dist., Taoyuan City, Taiwan (R.O.C.) TEL: +886-3-327-0868 FAX: +886-3-327-0855	
Test Site No.	Sporton Site No.	
	03CH16-HY	

Note: The test site complies with ANSI C63.4 2014 requirement.

FCC designation No.: TW1190 and TW0007

1.5 Applicable Standards

According to the specifications of the manufacturer, the EUT must comply with the requirements of the following standards:

- ♦ FCC Part 15 Subpart C §15.247
- ♦ FCC KDB Publication No. 558074 D01 DTS Meas. Guidance v05r02
- ♦ FCC KDB 414788 D01 Radiated Test Site v01r01
- ♦ ANSI C63.10-2013

Remark:

1. All test items were verified and recorded according to the standards and without any deviation during the test.
2. The TAF code is not including all the FCC KDB listed without accreditation.
3. This EUT has also been tested and complied with the requirements of FCC Part 15, Subpart B, recorded in a separate test report.



2 Test Configuration of Equipment Under Test

2.1 Carrier Frequency Channel

Frequency Band	Channel	Freq. (MHz)	Channel	Freq. (MHz)
2400-2483.5 MHz	0	2402	21	2444
	1	2404	22	2446
	2	2406	23	2448
	3	2408	24	2450
	4	2410	25	2452
	5	2412	26	2454
	6	2414	27	2456
	7	2416	28	2458
	8	2418	29	2460
	9	2420	30	2462
	10	2422	31	2464
	11	2424	32	2466
	12	2426	33	2468
	13	2428	34	2470
	14	2430	35	2472
	15	2432	36	2474
	16	2434	37	2476
	17	2436	38	2478
	18	2438	39	2480
	19	2440	-	-
20	2442	-	-	



2.2 Test Mode

<WCN3990>

Channel	Frequency	Bluetooth – LE RF Average Output Power	
		Data Rate / Modulation	
		GFSK	
		1Mbps	
Ch00	2402MHz	5.10 dBm	
Ch19	2440MHz	5.80 dBm	
Ch39	2480MHz	5.50 dBm	

Channel	Frequency	Bluetooth – LE RF Average Output Power	
		Data Rate / Modulation	
		GFSK	
		2Mbps	
Ch00	2402MHz	5.00 dBm	
Ch19	2440MHz	5.80 dBm	
Ch39	2480MHz	5.50 dBm	

<NRF52810>

Channel	Frequency	Bluetooth – LE RF Average Output Power	
		Data Rate / Modulation	
		GFSK	
		1Mbps	
Ch00	2402MHz	2.60 dBm	
Ch19	2440MHz	2.40 dBm	
Ch39	2480MHz	2.50 dBm	

Channel	Frequency	Bluetooth – LE RF Average Output Power	
		Data Rate / Modulation	
		GFSK	
		2Mbps	
Ch00	2402MHz	2.40 dBm	
Ch19	2440MHz	2.40 dBm	
Ch39	2480MHz	2.50 dBm	



- a. The EUT has been associated with peripherals and configuration operated in a manner tended to maximize its emission characteristics in a typical application. Frequency range investigated: conduction emission (150 kHz to 30 MHz), radiation emission (9 kHz to the 10th harmonic of the highest fundamental frequency or to 40 GHz, whichever is lower). For radiated measurement, pre-scanned in three orthogonal panels, X, Y, Z and Accessory. The worst cases (X plane) were recorded in this report.
- b. AC power line Conducted Emission was tested under maximum output power.

The following summary table is showing all test modes to demonstrate in compliance with the standard.

Summary table of Test Cases	
Test Item	Data Rate / Modulation
	Bluetooth – LE / GFSK
Conducted Test Cases	Mode 1: Bluetooth Tx CH00_2402 MHz_1Mbps Mode 2: Bluetooth Tx CH19_2440 MHz_1Mbps Mode 3: Bluetooth Tx CH39_2480 MHz_1Mbps Mode 4: Bluetooth Tx CH00_2402 MHz_2Mbps Mode 5: Bluetooth Tx CH19_2440 MHz_2Mbps Mode 6: Bluetooth Tx CH39_2480 MHz_2Mbps
Radiated Test Cases	Mode 1: Bluetooth Tx CH00_2402 MHz_1Mbps Mode 2: Bluetooth Tx CH19_2440 MHz_1Mbps Mode 3: Bluetooth Tx CH39_2480 MHz_1Mbps Mode 4: Bluetooth Tx CH00_2402 MHz_2Mbps Mode 5: Bluetooth Tx CH19_2440 MHz_2Mbps Mode 6: Bluetooth Tx CH39_2480 MHz_2Mbps
AC Conducted Emission	Mode 1: WCDMA Band V Idle + WLAN (2.4GHz) Link + Bluetooth Link + NFC On + Battery 2 + GPS Rx + USB Cable (Charging from AC Adaptor) + SIM 1 for Sample 2
Remark: For Radiated Test Cases, the tests were performed with Battery 1 and Sample 1	

2.3 Connection Diagram of Test System

<AC Conducted Emission Mode>

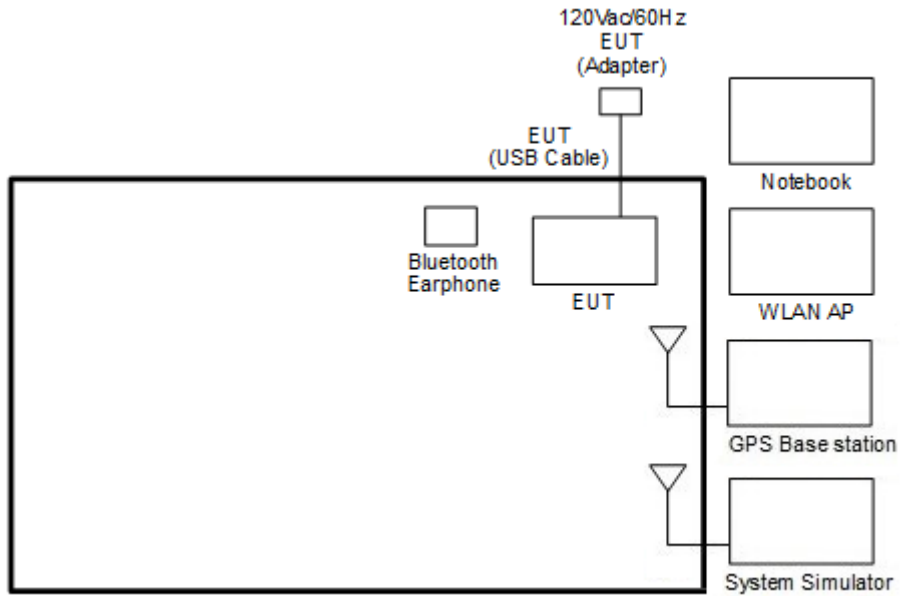

<Bluetooth-LE Tx Mode>

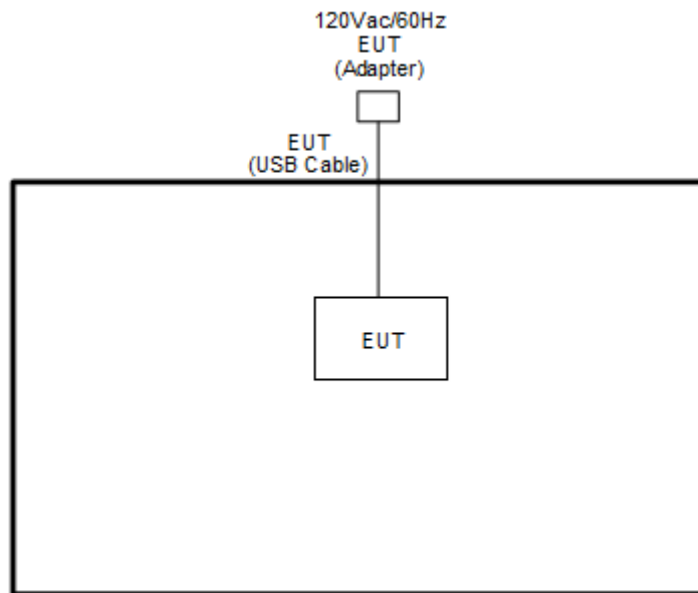



2.4 Support Unit used in test configuration and system

Item	Equipment	Brand Name	Model Name	FCC ID	Data Cable	Power Cord
1.	System Simulator	Anritsu	MT8820C	N/A	N/A	Unshielded, 1.8 m
2.	GPS Station	Pendulum	GSG-54	N/A	N/A	Unshielded, 1.8m
3.	Bluetooth Earphone	Sony Ericsson	MW600	PY7DDA-2029	N/A	N/A
4.	WLAN AP	ASUS	RT-AC66U	MSQ-RTAC66U	N/A	Unshielded, 1.8 m
5.	Notebook	Dell	Latitude 3400	FCC DoC	N/A	AC I/P : Unshielded, 1.2m DC O/P : Shielded, 1.8m
6.	SD Card	SanDisk	MicroSD HC	FCC DoC	N/A	N/A

2.5 EUT Operation Test Setup

The RF test items, utility "QRCT4.0" was installed in Notebook which was programmed in order to make the EUT get into the engineering modes to provide channel selection, power level, data rate and the application type and for continuous transmitting signals.

2.6 Measurement Results Explanation Example

For all conducted test items:

The offset level is set in the spectrum analyzer to compensate the RF cable loss and attenuator factor between EUT conducted output port and spectrum analyzer. With the offset compensation, the spectrum analyzer reading level is exactly the EUT RF output level.

Example :

The spectrum analyzer offset is derived from RF cable loss and attenuator factor.

Offset = RF cable loss + attenuator factor.

Following shows an offset computation example with cable loss 4.2 dB and 10dB attenuator.

$$\begin{aligned} \text{Offset(dB)} &= \text{RF cable loss(dB)} + \text{attenuator factor(dB)}. \\ &= 4.2 + 10 = 14.2 \text{ (dB)} \end{aligned}$$

3 Test Result

3.1 6dB and 99% Bandwidth Measurement

3.1.1 Limit of 6dB and 99% Bandwidth

The minimum 6 dB bandwidth shall be at least 500 kHz.

3.1.2 Measuring Instruments

See list of measuring equipment of this test report.

3.1.3 Test Procedures

1. The testing follows the ANSI C63.10 Section 6.9.3 (OBW) and 11.8.1 (6dB BW).
2. The RF output of EUT was connected to the spectrum analyzer by RF cable and attenuator. The path loss was compensated to the results for each measurement.
3. Set to the maximum power setting and enable the EUT transmit continuously.
4. Make the measurement with the spectrum analyzer's resolution bandwidth (RBW) = 100 kHz. Set the Video bandwidth (VBW) = 300 kHz. In order to make an accurate measurement. The 6 dB bandwidth must be greater than 500 kHz.
5. For 99% Bandwidth Measurement, the spectrum analyzer's resolution bandwidth (RBW) is set 1-5% of the emission bandwidth and set the Video bandwidth (VBW) $\geq 3 * RBW$.
6. Measure and record the results in the test report.

3.1.4 Test Setup

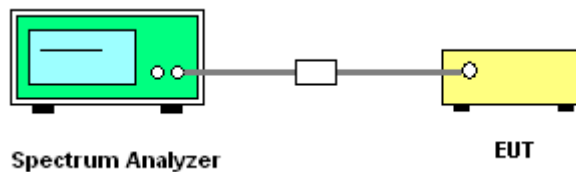



3.1.5 Test Result of 6dB Bandwidth

<WCN3990>

Test Engineer :	Kathy Chen	Temperature :	23.6~24.1°C
		Relative Humidity :	53.8~54.3%

Mod.	Data Rate	NTX	CH.	Freq. (MHz)	6dB BW (MHz)	6dB BW Limit (MHz)	Pass/Fail
BLE	1Mbps	1	0	2402	0.660	0.50	Pass
BLE	1Mbps	1	19	2440	0.660	0.50	Pass
BLE	1Mbps	1	39	2480	0.664	0.50	Pass
BLE	2Mbps	1	0	2402	1.136	0.50	Pass
BLE	2Mbps	1	19	2440	1.136	0.50	Pass
BLE	2Mbps	1	39	2480	1.136	0.50	Pass

<1Mbps>

6 dB Bandwidth Plot on Channel 00

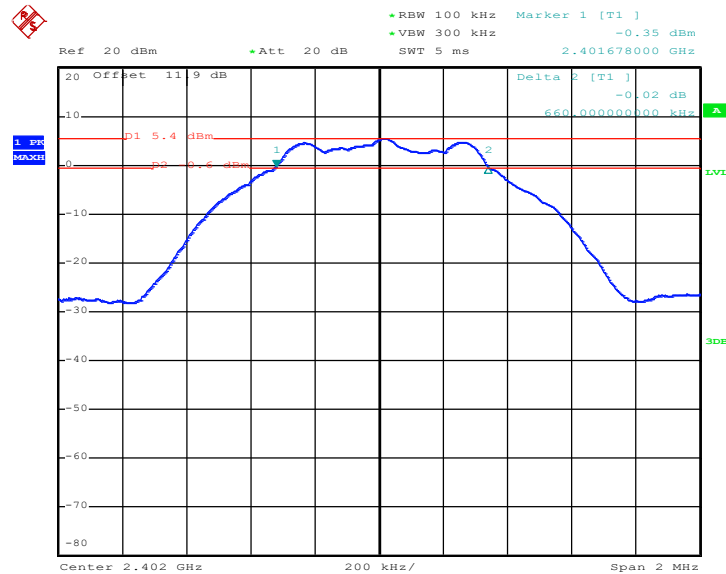

Date: 21.AUG.2020 09:11:33



6 dB Bandwidth Plot on Channel 19

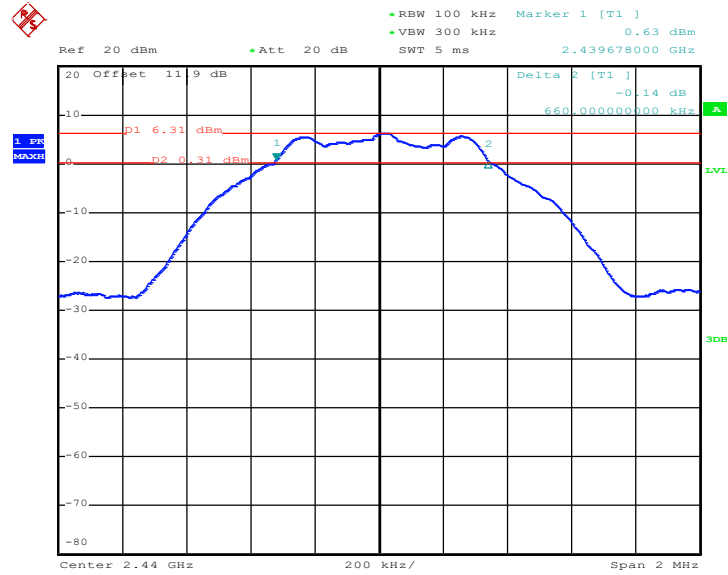

Date: 21.AUG.2020 09:20:23

6 dB Bandwidth Plot on Channel 39

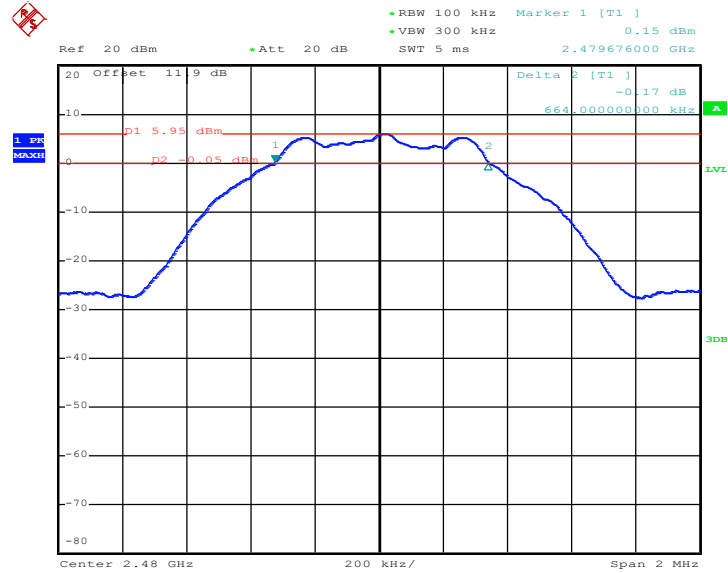

Date: 21.AUG.2020 09:36:58



<2Mbps>

6 dB Bandwidth Plot on Channel 00

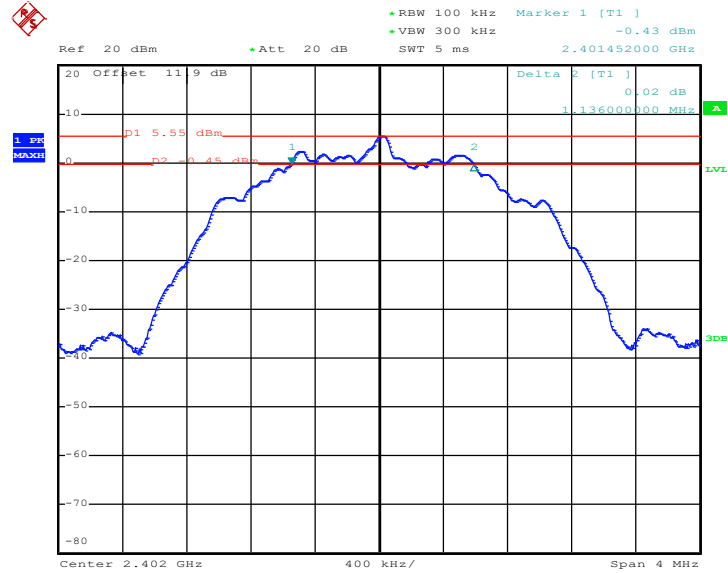

Date: 21.AUG.2020 09:56:51

6 dB Bandwidth Plot on Channel 19

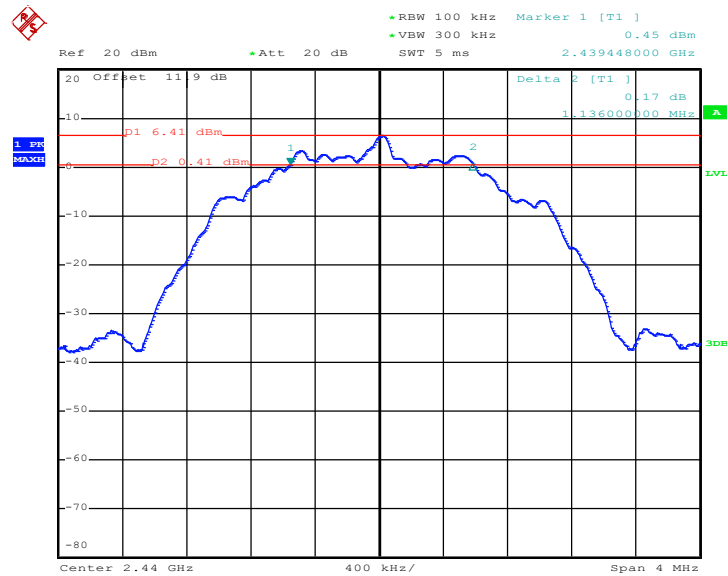

Date: 21.AUG.2020 10:11:08



6 dB Bandwidth Plot on Channel 39

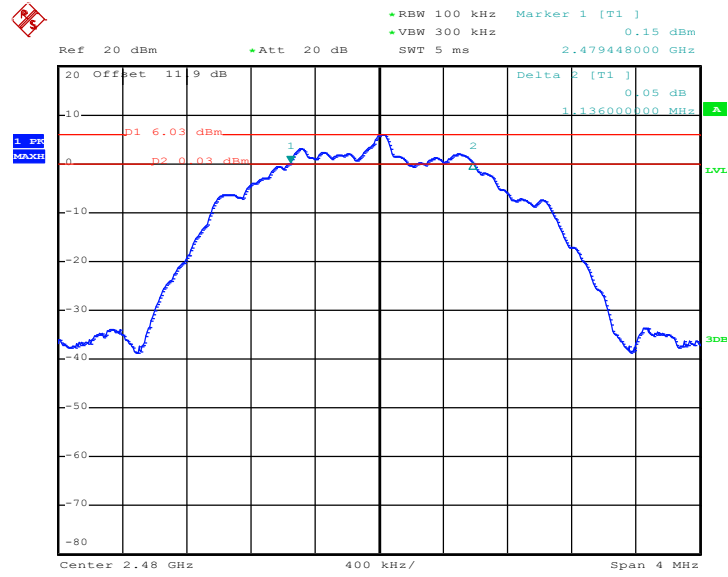

Date: 21.AUG.2020 10:27:15



<NRF52810>

Test Engineer :	Kathy Chen	Temperature :	23.9~24.3°C
		Relative Humidity :	53.8~54.3%

Mod.	Data Rate	NTX	CH.	Freq. (MHz)	6dB BW (MHz)	6dB BW Limit (MHz)	Pass/Fail
BLE	1Mbps	1	0	2402	0.712	0.50	Pass
BLE	1Mbps	1	19	2440	0.700	0.50	Pass
BLE	1Mbps	1	39	2480	0.716	0.50	Pass
BLE	2Mbps	1	0	2402	1.136	0.50	Pass
BLE	2Mbps	1	19	2440	1.136	0.50	Pass
BLE	2Mbps	1	39	2480	1.136	0.50	Pass

<1Mbps>

6 dB Bandwidth Plot on Channel 00

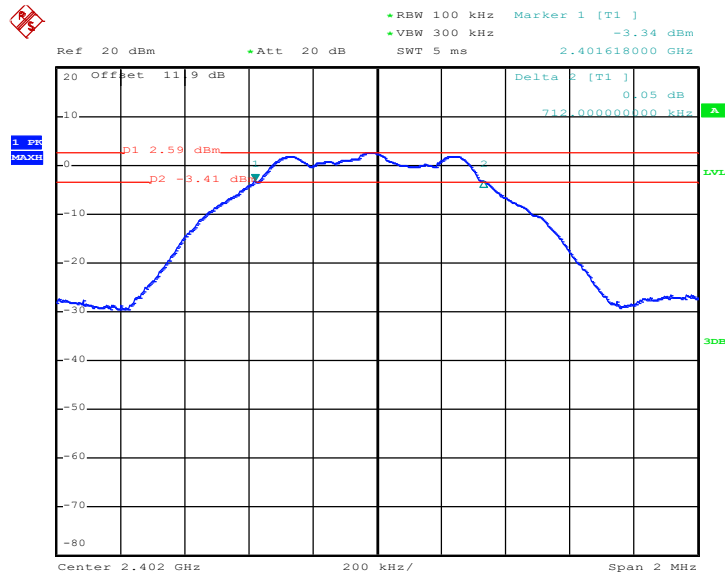

Date: 25.AUG.2020 09:01:54



6 dB Bandwidth Plot on Channel 19

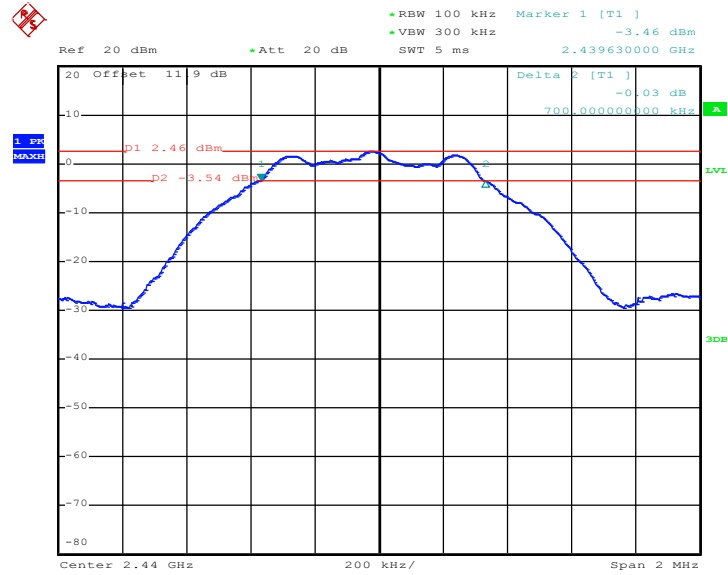

Date: 25.AUG.2020 09:19:07

6 dB Bandwidth Plot on Channel 39

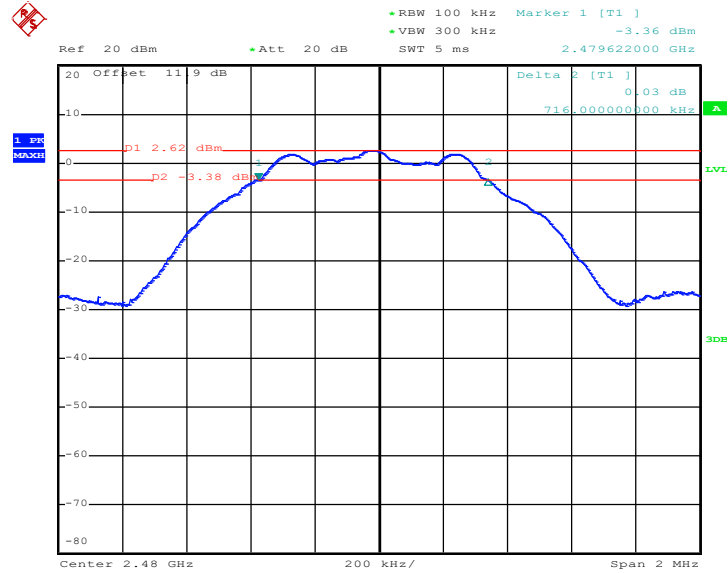

Date: 25.AUG.2020 09:33:25



<2Mbps>

6 dB Bandwidth Plot on Channel 00

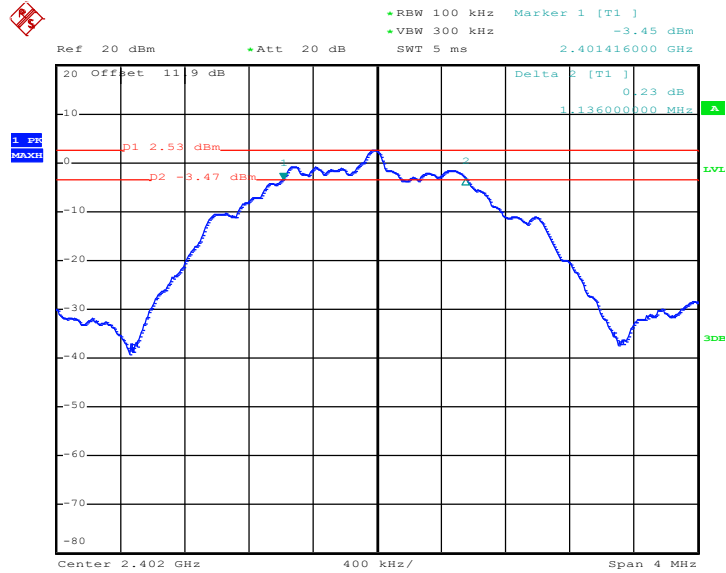

Date: 25.AUG.2020 09:51:50

6 dB Bandwidth Plot on Channel 19

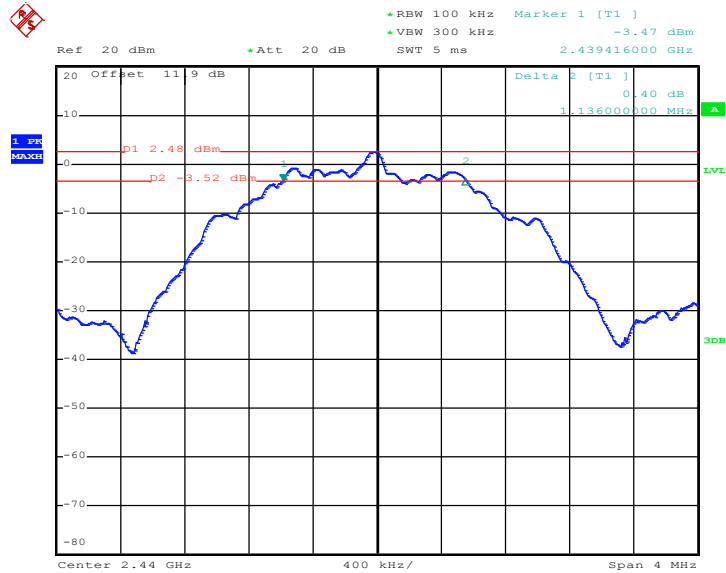

Date: 25.AUG.2020 10:03:22



6 dB Bandwidth Plot on Channel 39

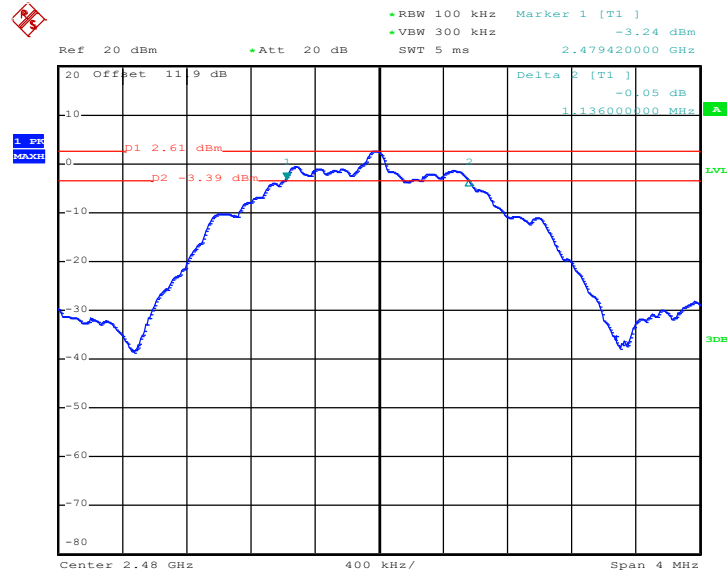

Date: 25.AUG.2020 10:24:57



3.1.6 Test Result of 99% Occupied Bandwidth

<WCN3990>

Test Engineer :	Kathy Chen	Temperature :	23.6~24.1°C
		Relative Humidity :	53.8~54.3%

Mod.	Data Rate	NTX	CH.	Freq. (MHz)	99% Occupied BW (MHz)	Pass/Fail
BLE	1Mbps	1	0	2402	1.028	Pass
BLE	1Mbps	1	19	2440	1.028	Pass
BLE	1Mbps	1	39	2480	1.028	Pass
BLE	2Mbps	1	0	2402	2.040	Pass
BLE	2Mbps	1	19	2440	2.040	Pass
BLE	2Mbps	1	39	2480	2.040	Pass

<1Mbps>

99% Bandwidth Plot on Channel 00

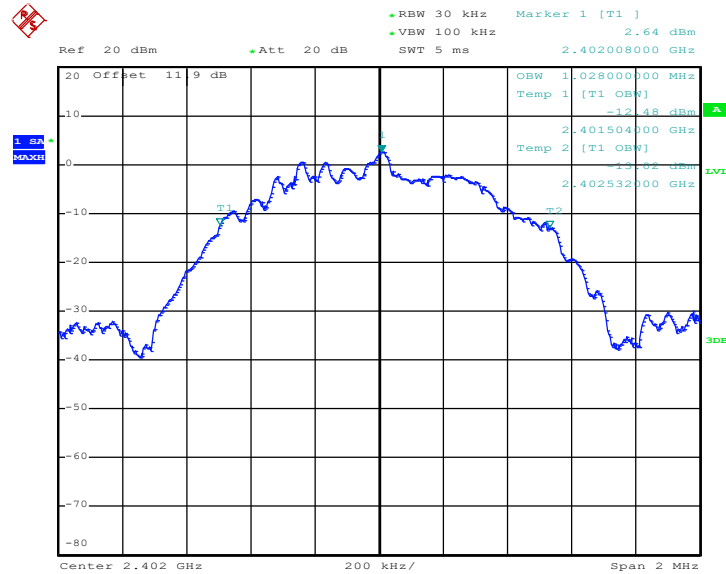

Date: 21.AUG.2020 09:15:50



99% Occupied Bandwidth Plot on Channel 19

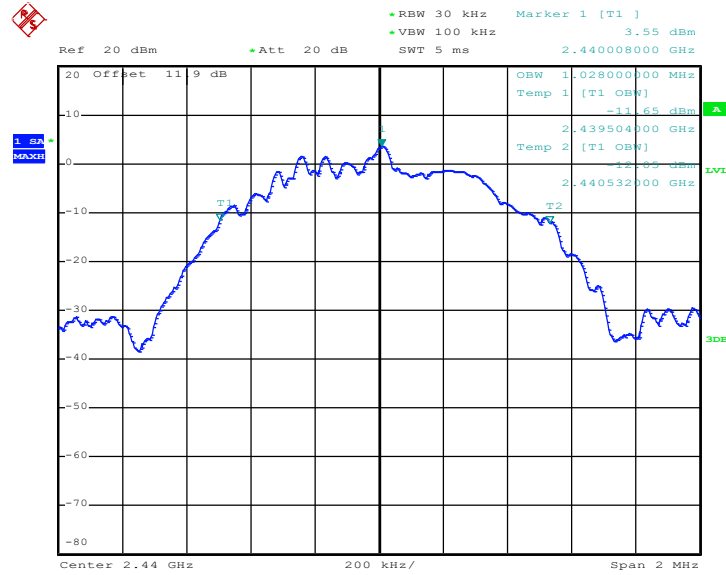

Date: 21.AUG.2020 09:29:45

99% Occupied Bandwidth Plot on Channel 39

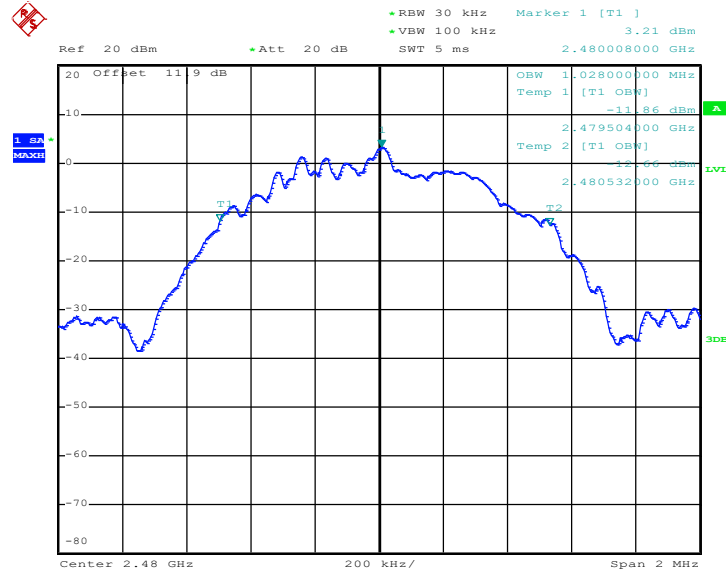

Date: 21.AUG.2020 09:46:42

Note: The occupied channel bandwidth is maintained within the band of operation for all of the modulations.



<2Mbps>

99% Bandwidth Plot on Channel 00

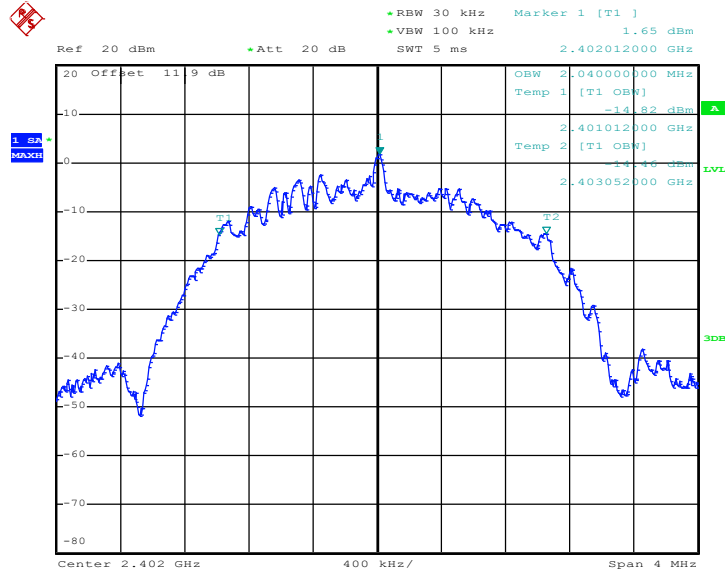

Date: 21.AUG.2020 10:04:07

99% Occupied Bandwidth Plot on Channel 19

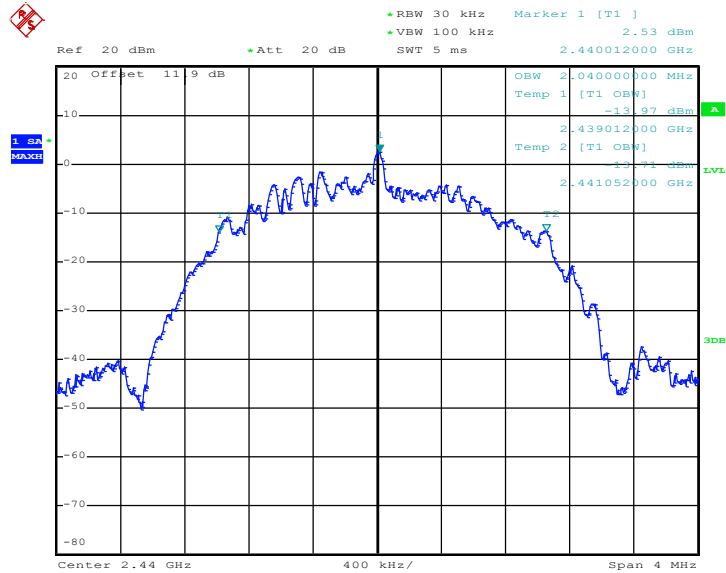

Date: 21.AUG.2020 10:23:50



99% Occupied Bandwidth Plot on Channel 39

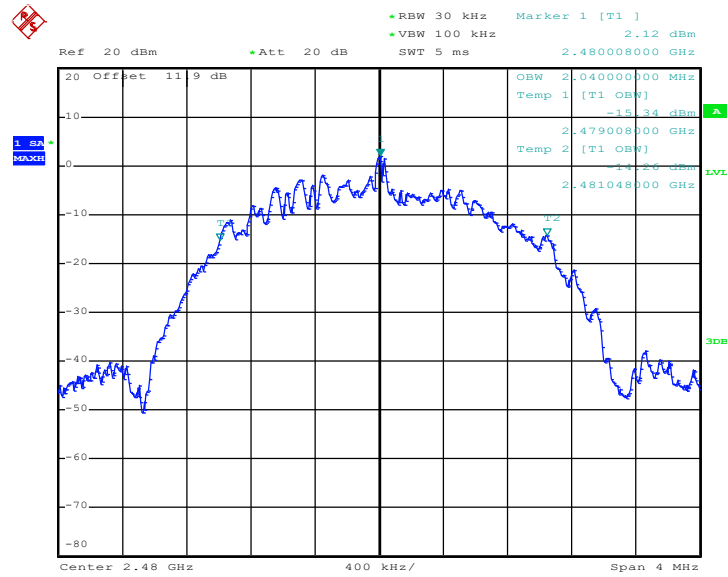

Date: 21.AUG.2020 10:31:45

Note: The occupied channel bandwidth is maintained within the band of operation for all of the modulations.



<NRF52810>

Test Engineer :	Kathy Chen	Temperature :	23.9~24.3°C
		Relative Humidity :	53.8~54.3%

Mod.	Data Rate	NTX	CH.	Freq. (MHz)	99% Occupied BW (MHz)	Pass/Fail
BLE	1Mbps	1	0	2402	1.042	Pass
BLE	1Mbps	1	19	2440	1.044	Pass
BLE	1Mbps	1	39	2480	1.042	Pass
BLE	2Mbps	1	0	2402	2.048	Pass
BLE	2Mbps	1	19	2440	2.048	Pass
BLE	2Mbps	1	39	2480	2.052	Pass

<1Mbps>

99% Bandwidth Plot on Channel 00

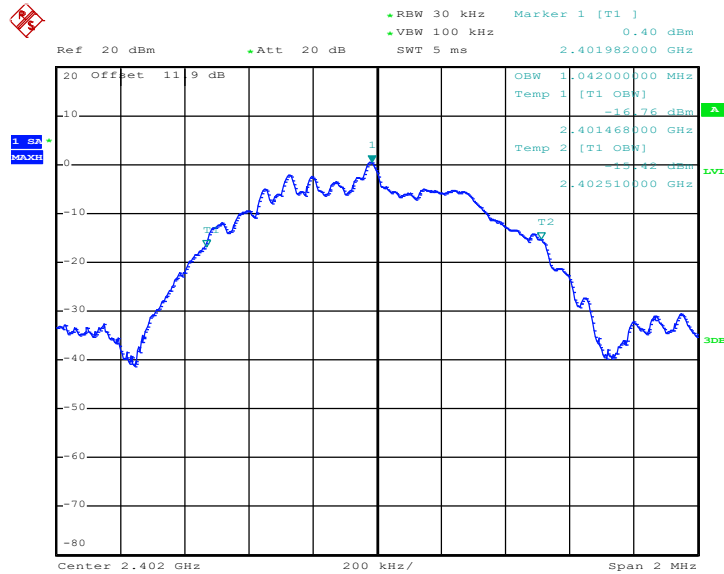

Date: 25.AUG.2020 09:10:16



99% Occupied Bandwidth Plot on Channel 19

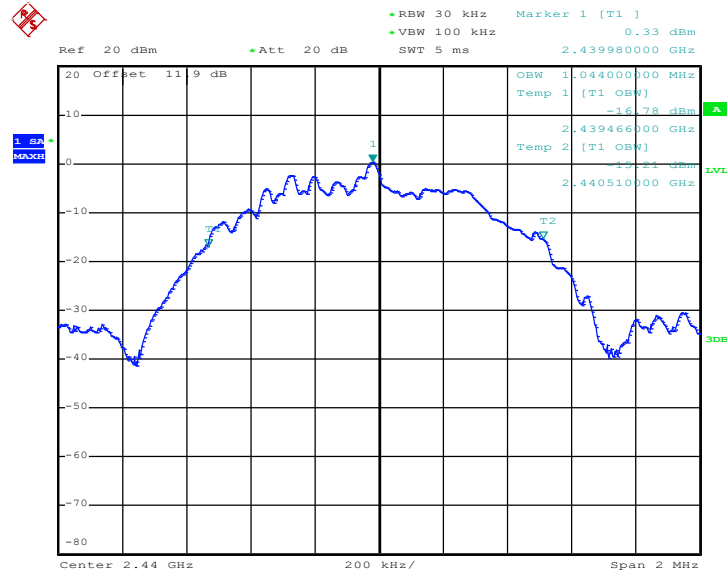

Date: 25.AUG.2020 09:24:22

99% Occupied Bandwidth Plot on Channel 39

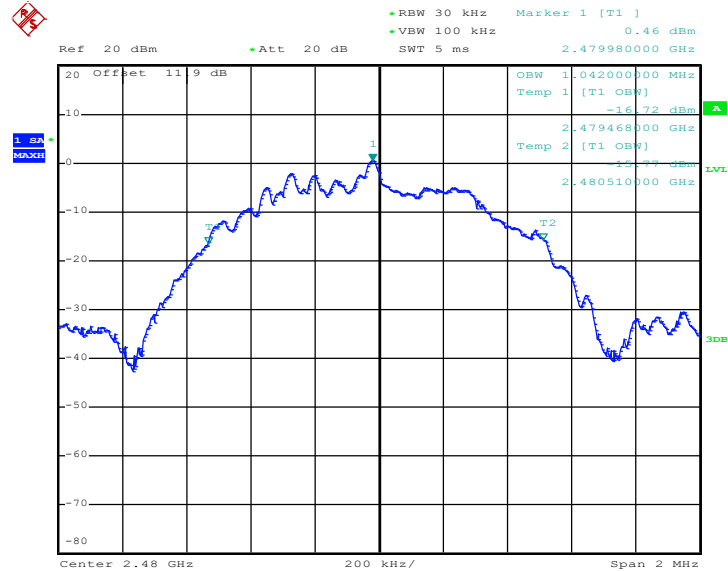

Date: 25.AUG.2020 09:43:45

Note: The occupied channel bandwidth is maintained within the band of operation for all of the modulations.



<2Mbps>

99% Bandwidth Plot on Channel 00

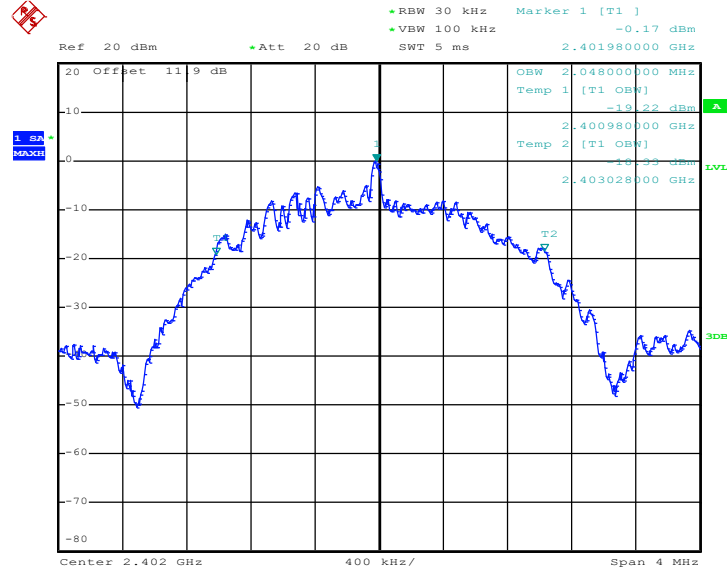

Date: 25.AUG.2020 09:55:09

99% Occupied Bandwidth Plot on Channel 19

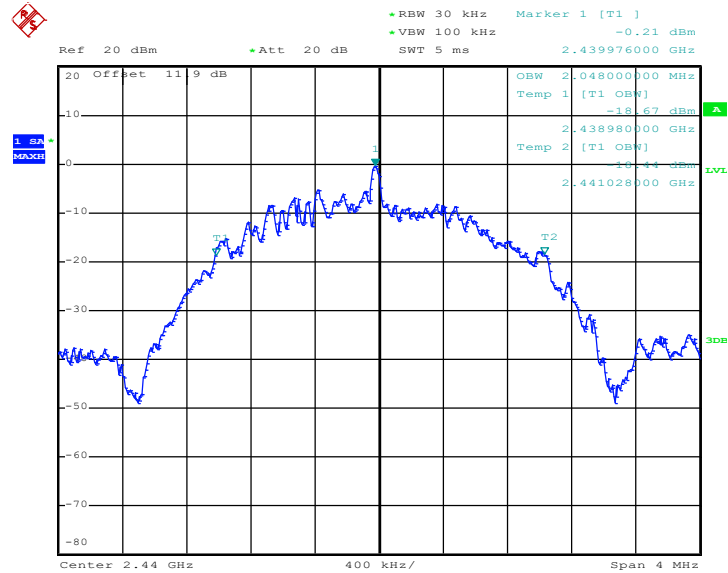

Date: 25.AUG.2020 10:07:23



99% Occupied Bandwidth Plot on Channel 39

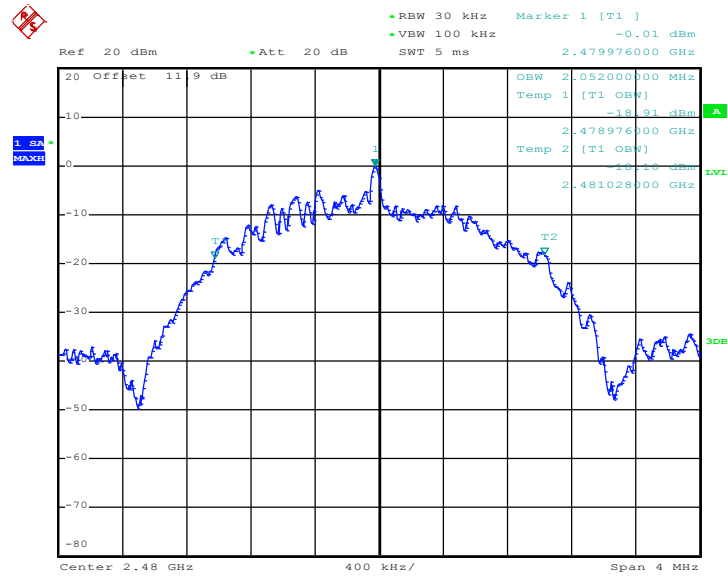

Date: 25.AUG.2020 10:32:57

Note: The occupied channel bandwidth is maintained within the band of operation for all of the modulations.

3.2 Output Power Measurement

3.2.1 Limit of Output Power

For systems using digital modulation in the 2400-2483.5MHz, the limit for output power is 30dBm. If transmitting antenna of directional gain greater than 6dBi is used, the peak output power from the intentional radiator shall be reduced below the above stated value by the amount in dB that the directional gain of the antenna exceeds 6 dBi. In case of point-to-point operation, the limit has to be reduced by 1dB for every 3dB that the directional gain of the antenna exceeds 6dBi.

3.2.2 Measuring Instruments

See list of measuring equipment of this test report.

3.2.3 Test Procedures

1. For Average Power, the testing follows ANSI C63.10 Section 11.9.2.3.2 Method AVGPM-G
2. The RF output of EUT was connected to the power meter by RF cable and attenuator.
3. The path loss was compensated to the results for each measurement.
4. Set to the maximum power setting and enable the EUT transmit continuously.
5. Measure the conducted output power and record the results in the test report.

3.2.4 Test Setup

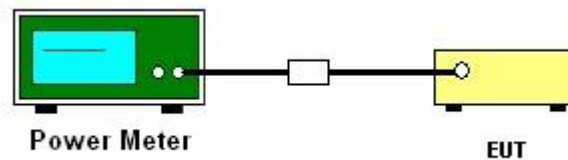



3.2.5 Test Result of Average Output Power

<WCN3990>

Test Engineer :	Kathy Chen	Temperature :	23.6~24.1°C
		Relative Humidity :	53.8~54.3%

Mod.	Data Rate	NTX	CH.	Freq. (MHz)	Average Conducted Power (dBm)	Conducted Power Limit (dBm)	DG (dBi)	EIRP Power (dBm)	EIRP Power Limit (dBm)	Pass /Fail
BLE	1Mbps	1	0	2402	5.10	30.00	1.50	6.60	36.00	Pass
BLE	1Mbps	1	19	2440	5.80	30.00	1.50	7.30	36.00	Pass
BLE	1Mbps	1	39	2480	5.50	30.00	1.50	7.00	36.00	Pass
BLE	2Mbps	1	0	2402	5.00	30.00	1.50	6.50	36.00	Pass
BLE	2Mbps	1	19	2440	5.80	30.00	1.50	7.30	36.00	Pass
BLE	2Mbps	1	39	2480	5.50	30.00	1.50	7.00	36.00	Pass

<NRF52810>

Test Engineer :	Kathy Chen	Temperature :	23.9~24.3°C
		Relative Humidity :	53.8~54.3%

Mod.	Data Rate	NTX	CH.	Freq. (MHz)	Average Conducted Power (dBm)	Conducted Power Limit (dBm)	DG (dBi)	EIRP Power (dBm)	EIRP Power Limit (dBm)	Pass /Fail
BLE	1Mbps	1	0	2402	2.60	30.00	1.50	4.10	36.00	Pass
BLE	1Mbps	1	19	2440	2.40	30.00	1.50	3.90	36.00	Pass
BLE	1Mbps	1	39	2480	2.50	30.00	1.50	4.00	36.00	Pass
BLE	2Mbps	1	0	2402	2.40	30.00	1.50	3.90	36.00	Pass
BLE	2Mbps	1	19	2440	2.40	30.00	1.50	3.90	36.00	Pass
BLE	2Mbps	1	39	2480	2.50	30.00	1.50	4.00	36.00	Pass

3.3 Power Spectral Density Measurement

3.3.1 Limit of Power Spectral Density

The peak power spectral density shall not be greater than 8dBm in any 3kHz band at any time interval of continuous transmission.

3.3.2 Measuring Instruments

See list of measuring equipment of this test report.

3.3.3 Test Procedures

1. The testing follows the ANSI C63.10 Section 11.10.2 Method PKPSD.
2. The RF output of EUT was connected to the spectrum analyzer by RF cable and attenuator. The path loss was compensated to the results for each measurement.
3. Set to the maximum power setting and enable the EUT transmit continuously.
4. Make the measurement with the spectrum analyzer's resolution bandwidth (RBW) = 3 kHz. Video bandwidth VBW = 10 kHz In order to make an accurate measurement, set the span to 1.5 times DTS Channel Bandwidth. (6dB BW)
5. Detector = peak, Sweep time = auto couple, Trace mode = max hold, Allow trace to fully stabilize. Use the peak marker function to determine the maximum power level.
6. Measure and record the results in the test report.
7. The Measured power density (dBm)/ 100kHz is a reference level and used as 20dBc down limit line for Conducted Band Edges and Conducted Spurious Emission.

3.3.4 Test Setup

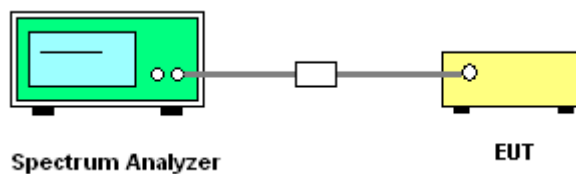



3.3.5 Test Result of Power Spectral Density

<WCN3990>

Test Engineer :	Kathy Chen	Temperature :	23.6~24.1°C
		Relative Humidity :	53.8~54.3%

Mod.	Data Rate	NTX	CH.	Freq. (MHz)	Peak PSD (dBm /100kHz)	Peak PSD (dBm /3kHz)	DG (dBi)	Peak PSD Limit (dBm /3kHz)	Pass/Fail
BLE	1Mbps	1	0	2402	5.41	-9.38	1.50	8.00	Pass
BLE	1Mbps	1	19	2440	6.32	-8.51	1.50	8.00	Pass
BLE	1Mbps	1	39	2480	5.95	-8.90	1.50	8.00	Pass
BLE	2Mbps	1	0	2402	5.48	-12.81	1.50	8.00	Pass
BLE	2Mbps	1	19	2440	6.40	-11.96	1.50	8.00	Pass
BLE	2Mbps	1	39	2480	6.02	-12.22	1.50	8.00	Pass

<NRF52810>

Test Engineer :	Kathy Chen	Temperature :	23.9~24.3°C
		Relative Humidity :	53.8~54.3%

Mod.	Data Rate	NTX	CH.	Freq. (MHz)	Peak PSD (dBm /100kHz)	Peak PSD (dBm /3kHz)	DG (dBi)	Peak PSD Limit (dBm /3kHz)	Pass/Fail
BLE	1Mbps	1	0	2402	2.58	-12.91	1.50	8.00	Pass
BLE	1Mbps	1	19	2440	2.49	-12.90	1.50	8.00	Pass
BLE	1Mbps	1	39	2480	2.64	-12.85	1.50	8.00	Pass
BLE	2Mbps	1	0	2402	2.55	-15.29	1.50	8.00	Pass
BLE	2Mbps	1	19	2440	2.50	-15.21	1.50	8.00	Pass
BLE	2Mbps	1	39	2480	2.66	-15.05	1.50	8.00	Pass



3.3.6 Test Result of Power Spectral Density Plots (100kHz)

<WCN3990>

Test Engineer :	Kathy Chen	Temperature :	23.6~24.1°C
		Relative Humidity :	53.8~54.3%

<1Mbps>

PSD 100kHz Plot on Channel 00

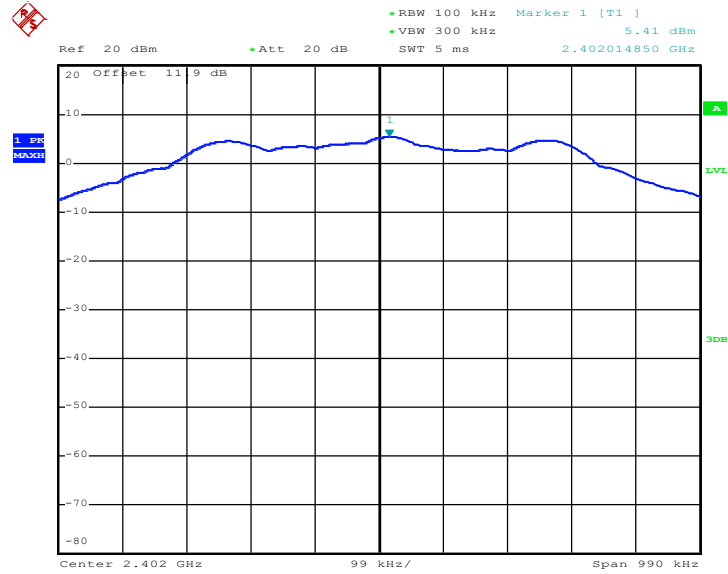

Date: 21.AUG.2020 09:13:26



PSD 100kHz Plot on Channel 19

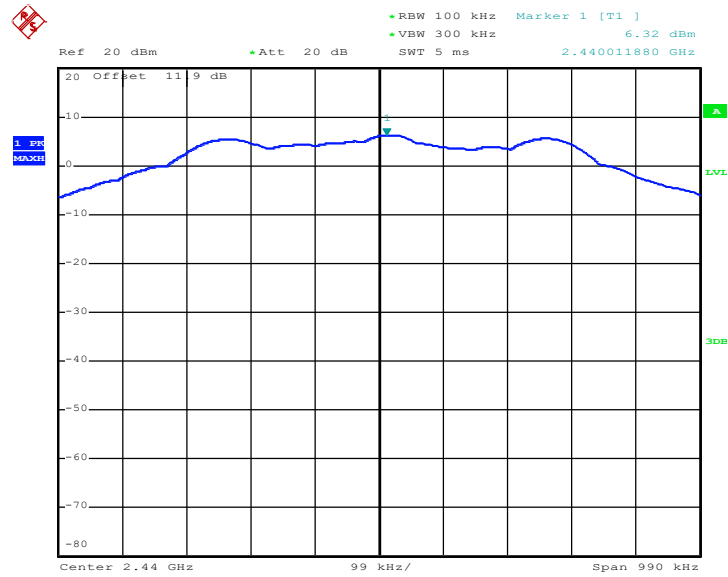

Date: 21.AUG.2020 09:26:45

PSD 100kHz Plot on Channel 39

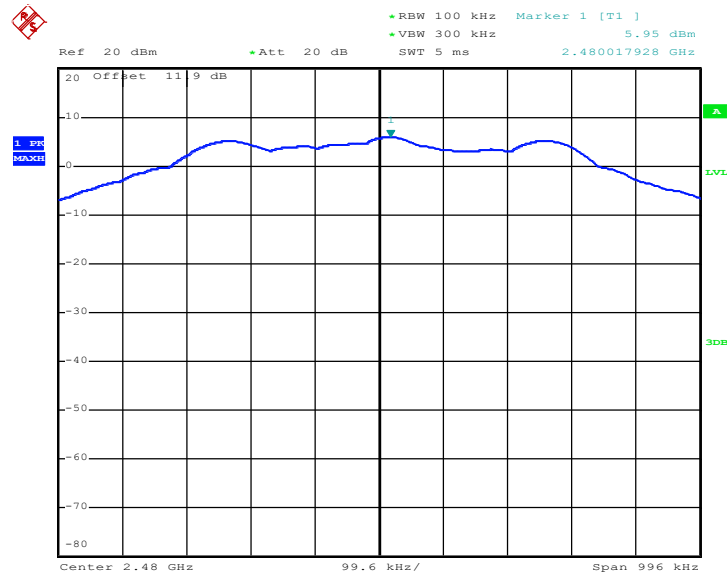

Date: 21.AUG.2020 09:39:42



<2Mbps>

PSD 100kHz Plot on Channel 00

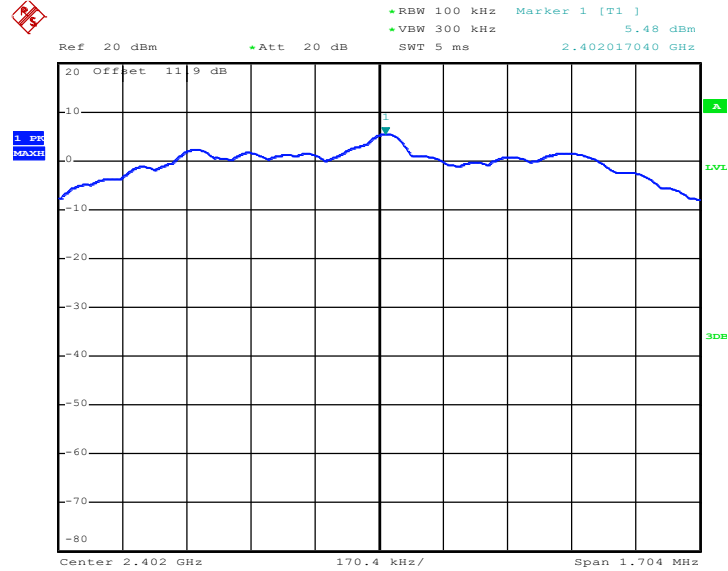

Date: 21.AUG.2020 09:59:18

PSD 100kHz Plot on Channel 19

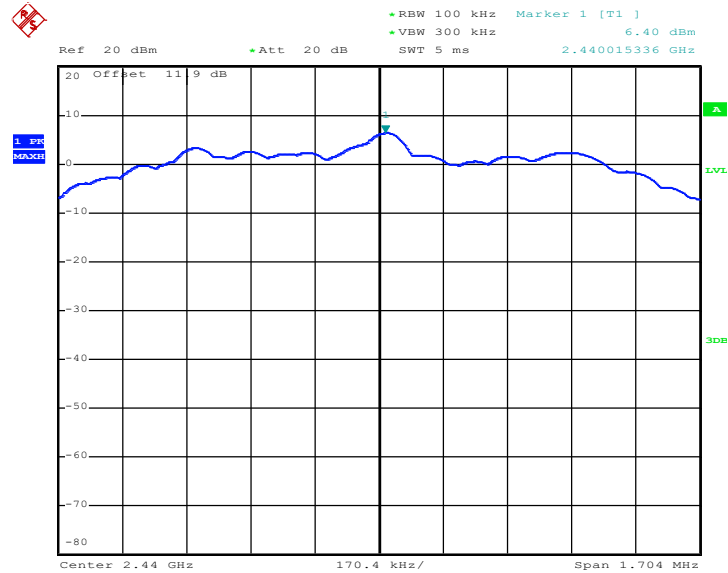

Date: 21.AUG.2020 10:14:58



PSD 100kHz Plot on Channel 39

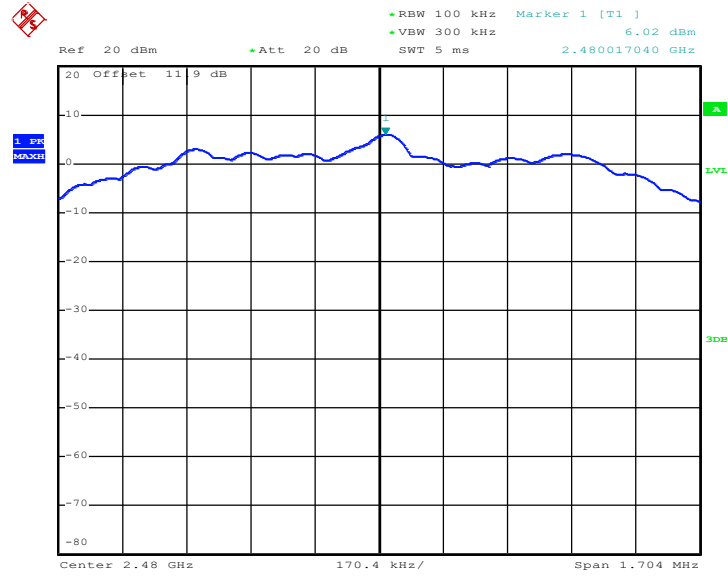

Date: 21.AUG.2020 10:28:47



<NRF52810>

Test Engineer :	Kathy Chen	Temperature :	23.9~24.3°C
		Relative Humidity :	53.8~54.3%

<1Mbps>

PSD 100kHz Plot on Channel 00

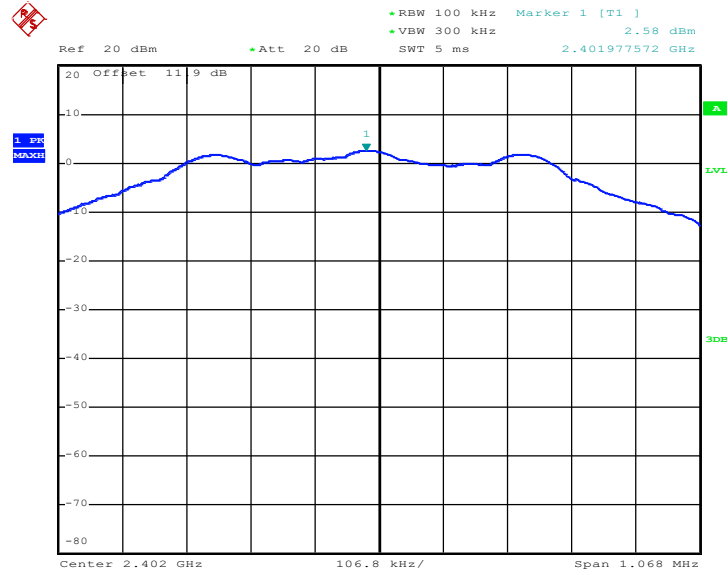

Date: 25.AUG.2020 09:04:06



PSD 100kHz Plot on Channel 19

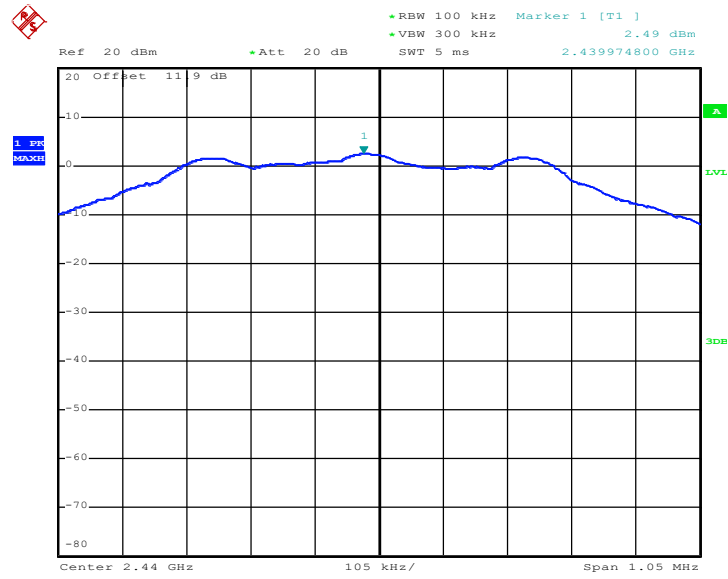

Date: 25.AUG.2020 09:21:53

PSD 100kHz Plot on Channel 39

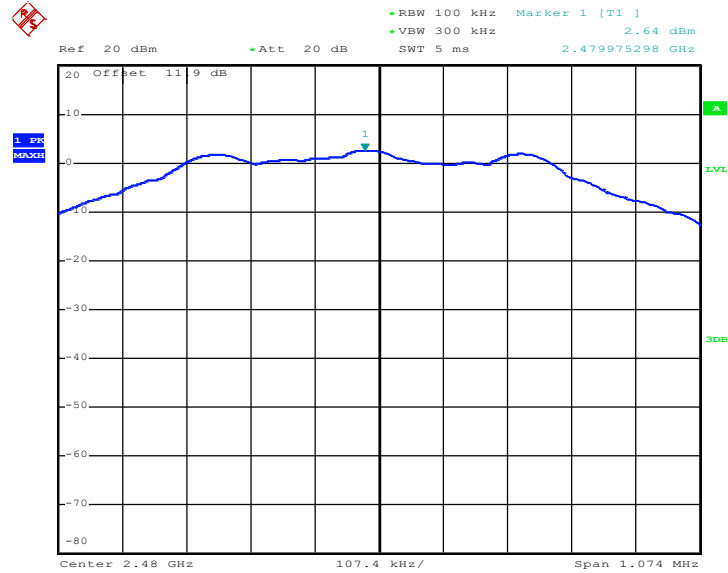

Date: 25.AUG.2020 09:38:12



<2Mbps>

PSD 100kHz Plot on Channel 00

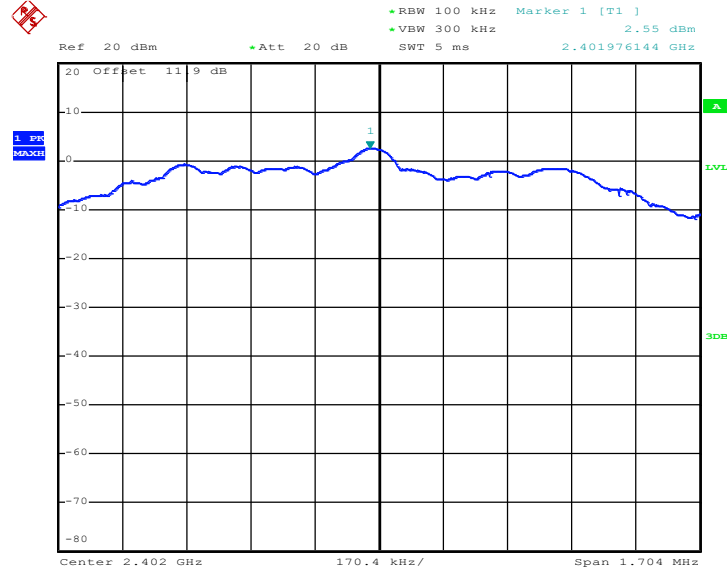

Date: 25.AUG.2020 09:53:19

PSD 100kHz Plot on Channel 19

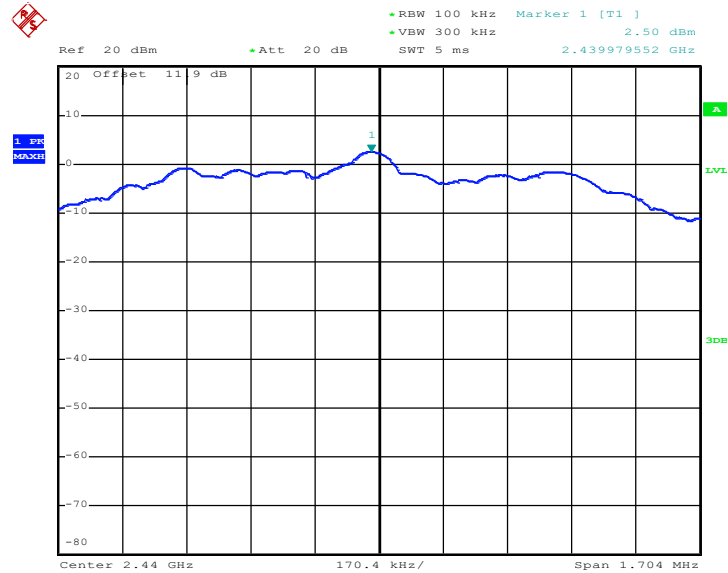

Date: 25.AUG.2020 10:04:34



PSD 100kHz Plot on Channel 39

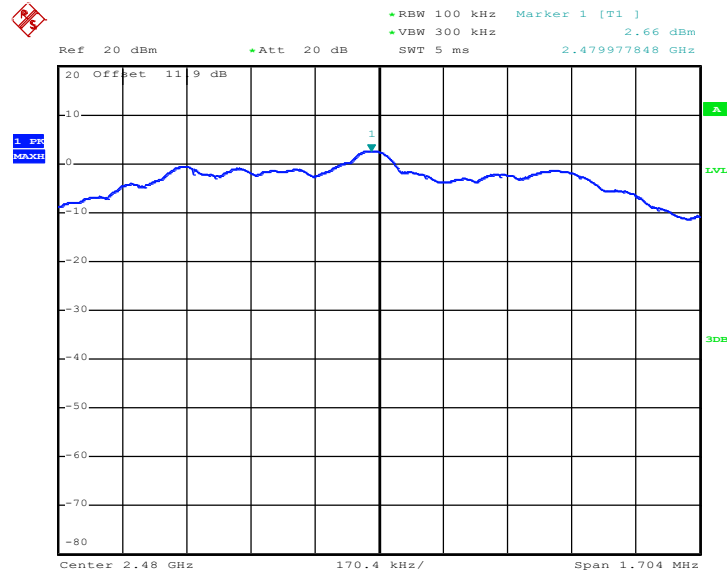

Date: 25.AUG.2020 10:26:34



3.3.7 Test Result of Power Spectral Density Plots (3kHz)

<WCN3990>

Test Engineer :	Kathy Chen	Temperature :	23.6~24.1°C
		Relative Humidity :	53.8~54.3%

<1Mbps>

PSD 3kHz Plot on Channel 00

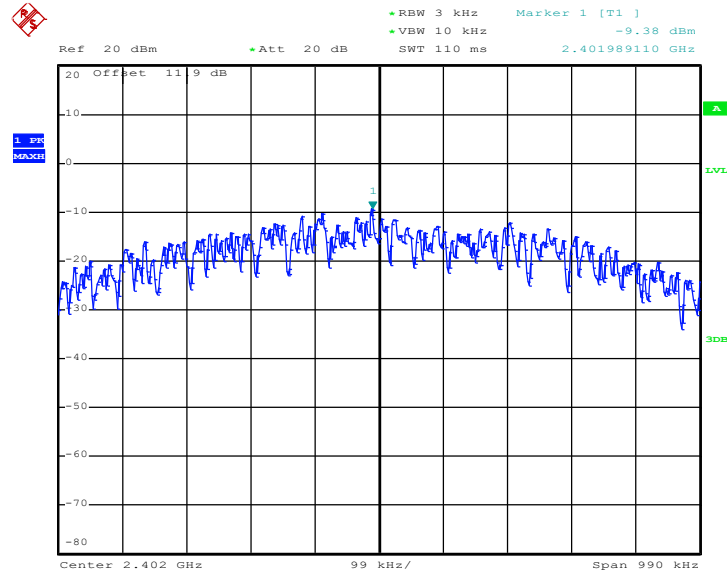

Date: 21.AUG.2020 09:12:51



PSD 3kHz Plot on Channel 19

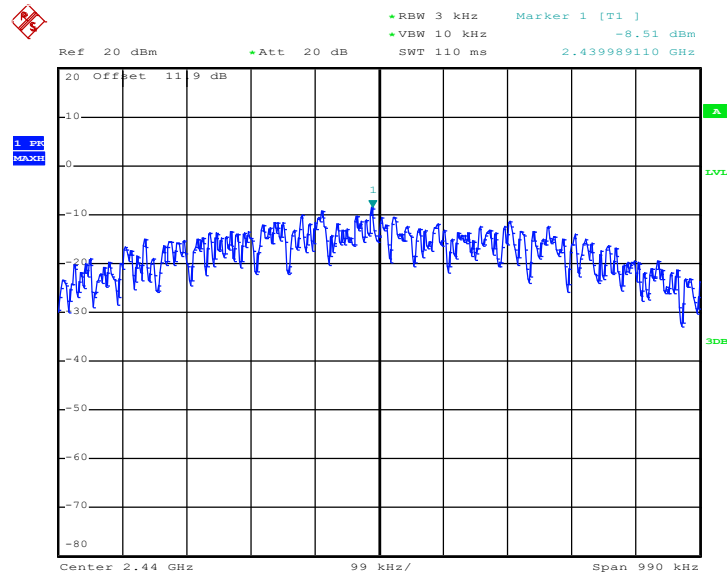

Date: 21.AUG.2020 09:25:23

PSD 3kHz Plot on Channel 39

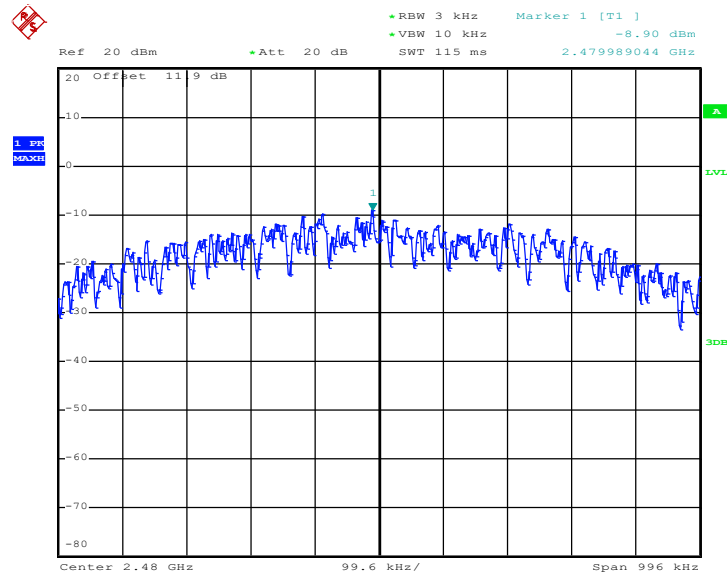

Date: 21.AUG.2020 09:39:07



<2Mbps>

PSD 3kHz Plot on Channel 00

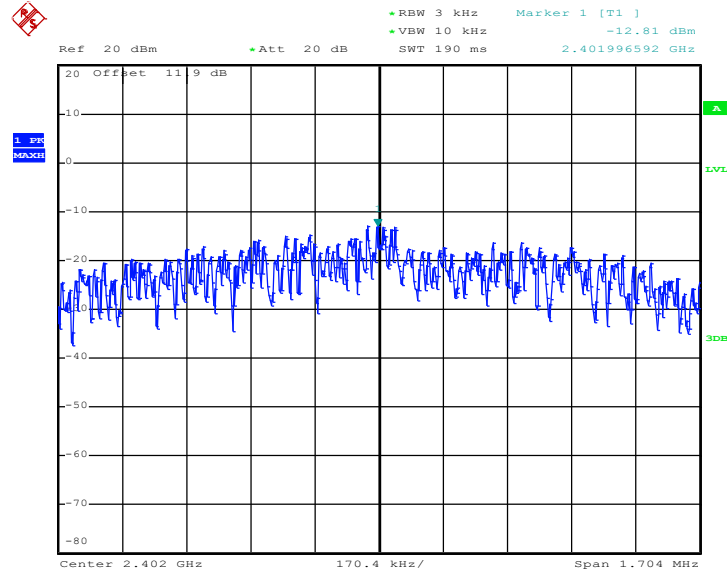

Date: 21.AUG.2020 09:57:49

PSD 3kHz Plot on Channel 19

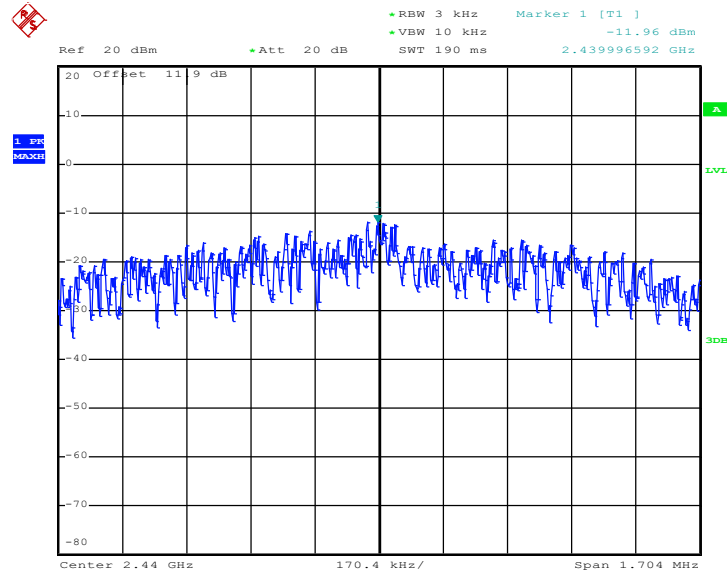

Date: 21.AUG.2020 10:12:35



PSD 3kHz Plot on Channel 39

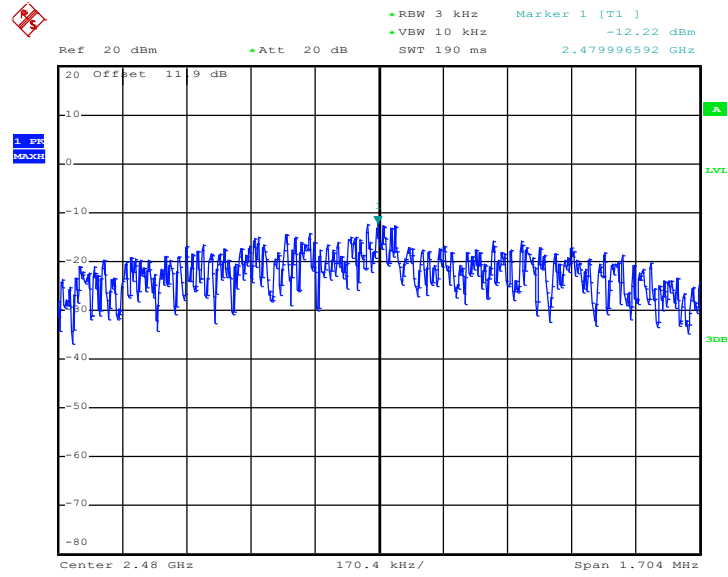

Date: 21.AUG.2020 10:28:06



<NRF52810>

Test Engineer :	Kathy Chen	Temperature :	23.9~24.3°C
		Relative Humidity :	53.8~54.3%

<1Mbps>

PSD 3kHz Plot on Channel 00

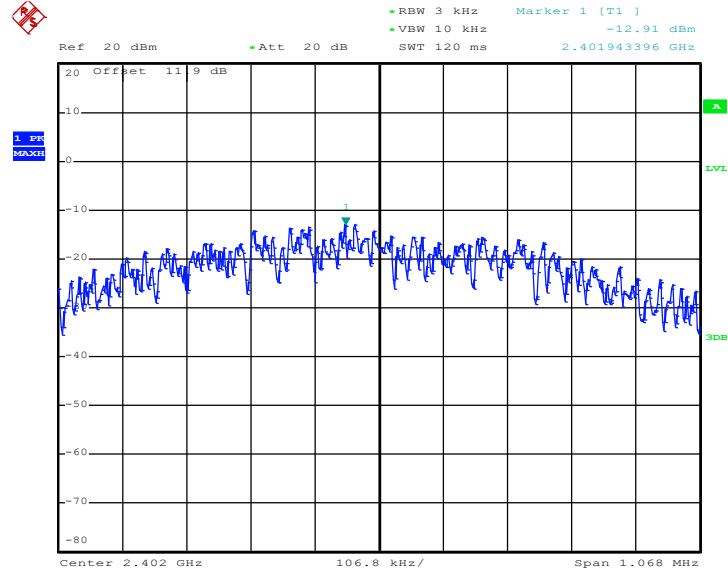

Date: 25.AUG.2020 09:03:34



PSD 3kHz Plot on Channel 19

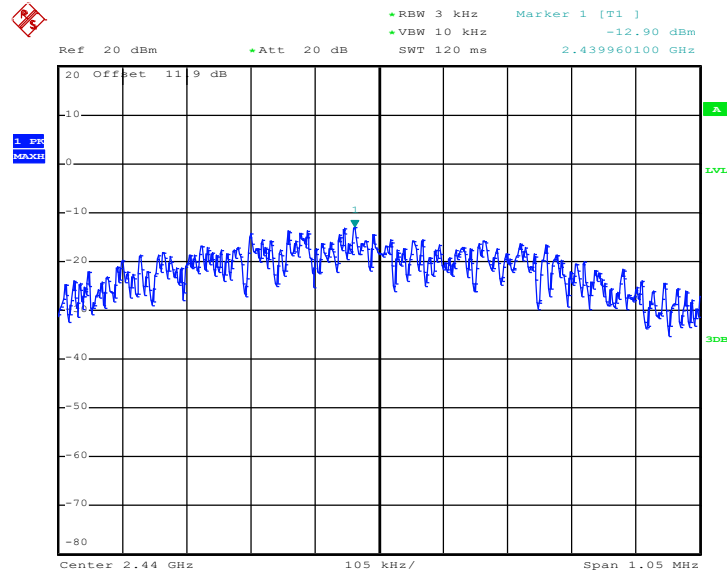

Date: 25.AUG.2020 09:21:30

PSD 3kHz Plot on Channel 39

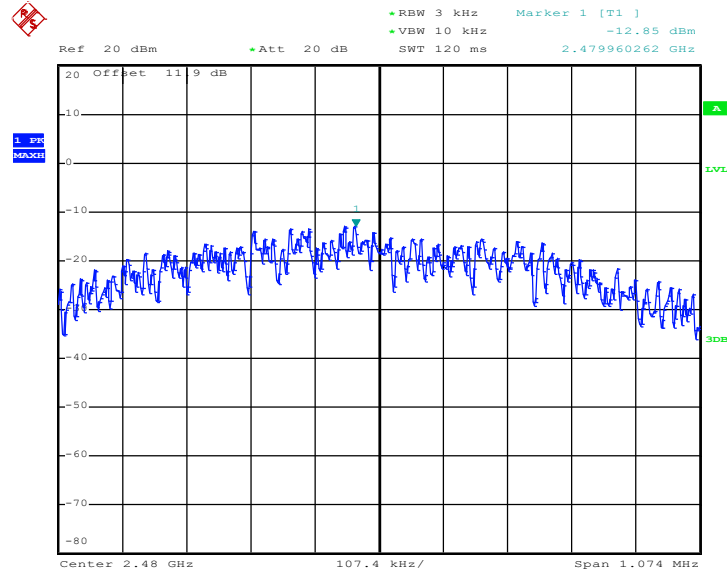

Date: 25.AUG.2020 09:34:43



<2Mbps>

PSD 3kHz Plot on Channel 00

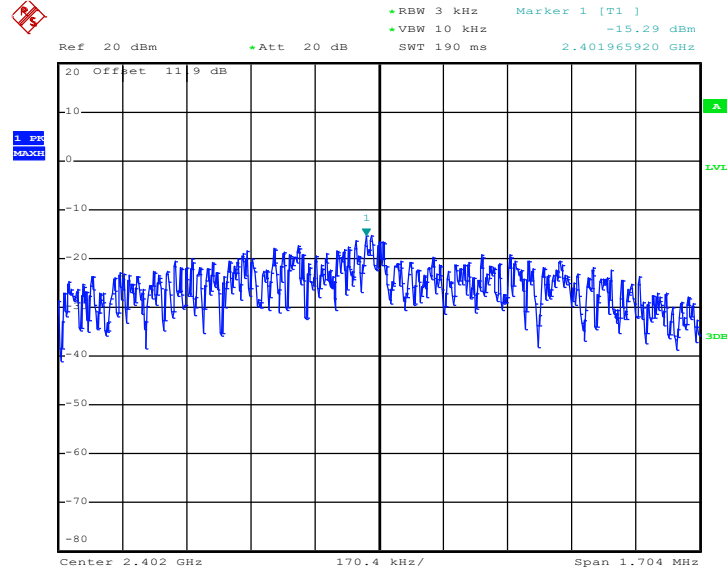

Date: 25.AUG.2020 09:52:50

PSD 3kHz Plot on Channel 19

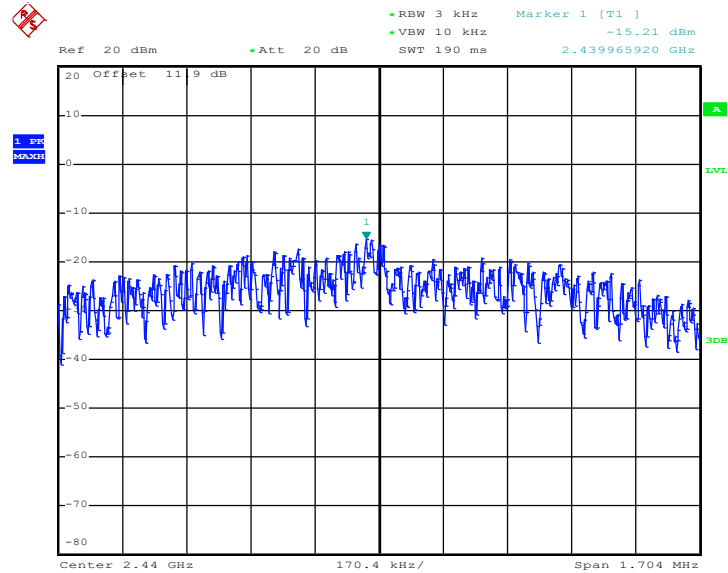

Date: 25.AUG.2020 10:04:09



PSD 3kHz Plot on Channel 39

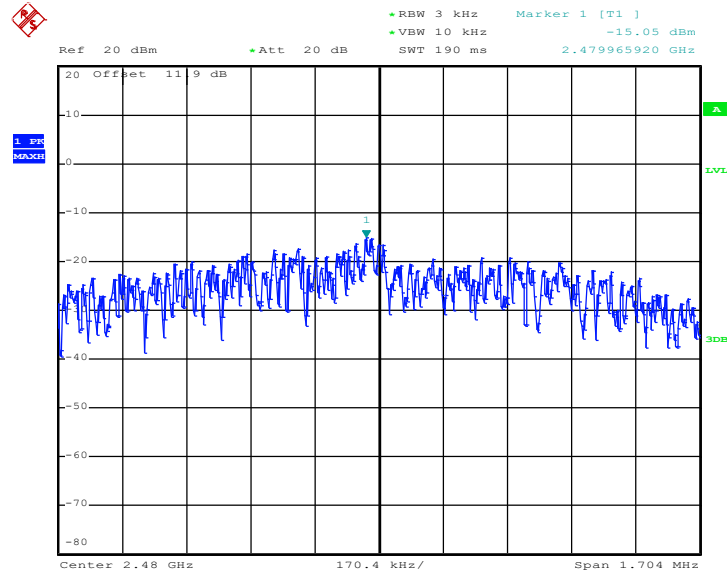

Date: 25.AUG.2020 10:26:09

3.4 Conducted Band Edges and Spurious Emission Measurement

3.4.1 Limit of Conducted Band Edges and Spurious Emission

All harmonics/spurious must be at least 20 dB down from the highest emission level within the authorized band.

3.4.2 Measuring Instruments

See list of measuring equipment of this test report.

3.4.3 Test Procedure

1. The testing follows the ANSI C63.10 Section 11.11.3 Emission level measurement.
2. The RF output of EUT was connected to the spectrum analyzer by RF cable and attenuator. The path loss was compensated to the results for each measurement.
3. Set to the maximum power setting and enable the EUT transmit continuously.
4. Set RBW = 100 kHz, VBW=300 kHz, Peak Detector. Unwanted Emissions measured in any 100 kHz bandwidth outside of the authorized frequency band shall be attenuated by at least 20 dB relative to the maximum in-band peak PSD level in 100 kHz when maximum peak conducted output power procedure is used. If the transmitter complies with the conducted power limits based on the use of RMS averaging over a time interval, the attenuation required under this paragraph shall be 30 dB instead of 20 dB.
5. Measure and record the results in the test report.
6. The RF fundamental frequency should be excluded against the limit line in the operating frequency band.

3.4.4 Test Setup





3.4.5 Test Result of Conducted Band Edges Plots

<WCN3990>

Test Engineer :	Kathy Chen	Temperature :	23.6~24.1°C
		Relative Humidity :	53.8~54.3%

<1Mbps>

Low Band Edge Plot on Channel 00

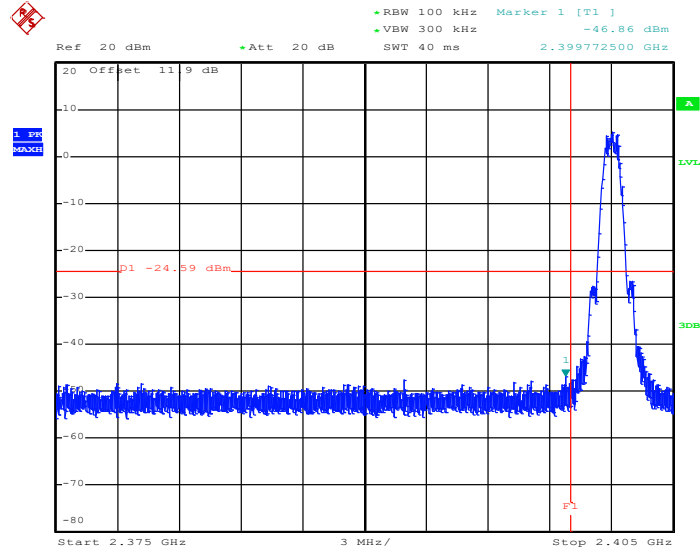

Date: 21.AUG.2020 09:13:53

High Band Edge Plot on Channel 39

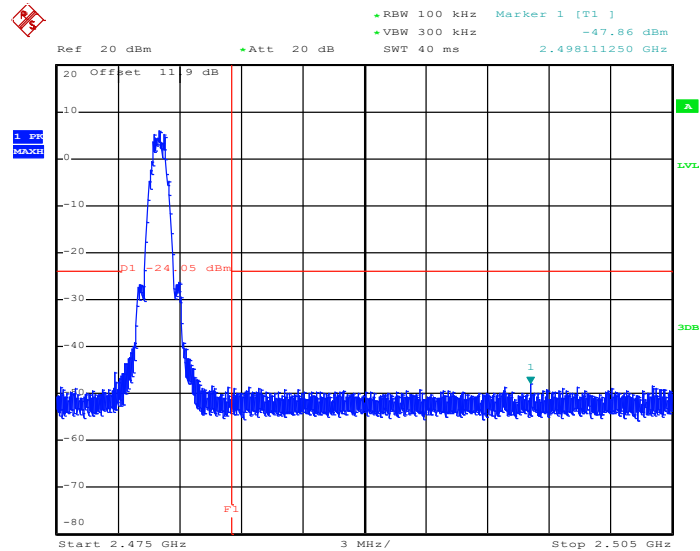

Date: 21.AUG.2020 09:41:47



<2Mbps>

Low Band Edge Plot on Channel 00

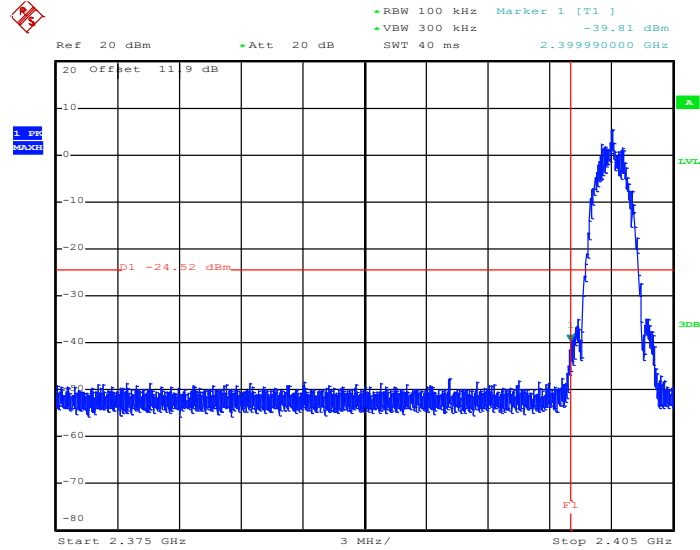

Date: 21.AUG.2020 10:00:54

High Band Edge Plot on Channel 39

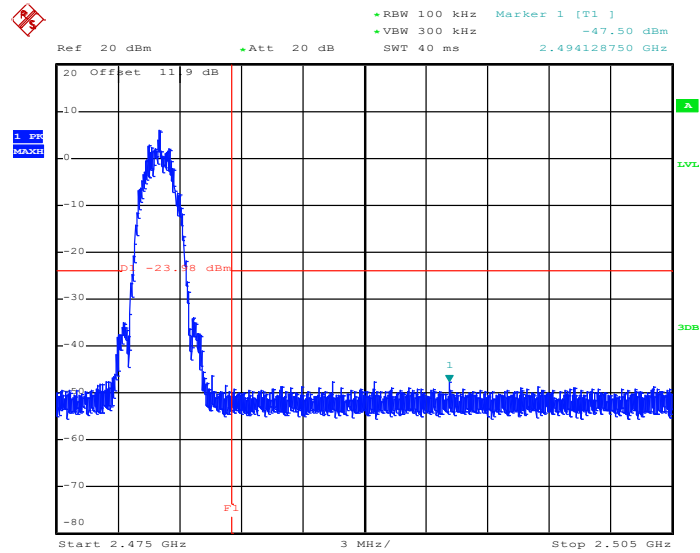

Date: 21.AUG.2020 10:29:33



<NRF52810>

Test Engineer :	Kathy Chen	Temperature :	23.9~24.3°C
		Relative Humidity :	53.8~54.3%

<1Mbps>

Low Band Edge Plot on Channel 00

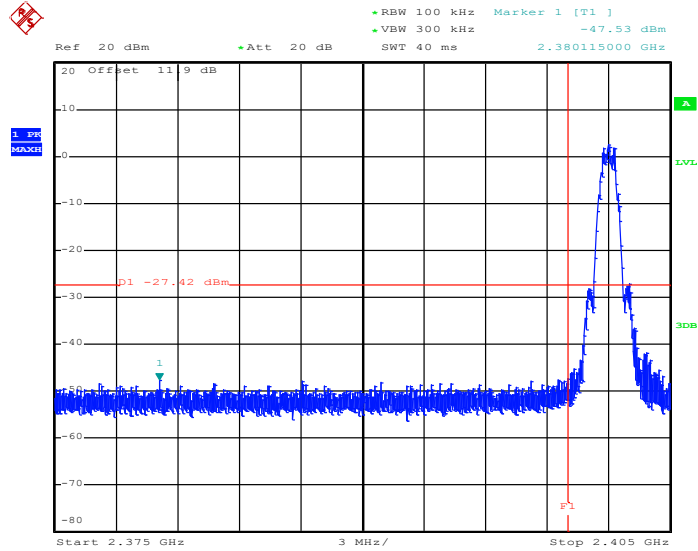

Date: 25.AUG.2020 09:04:57

High Band Edge Plot on Channel 39

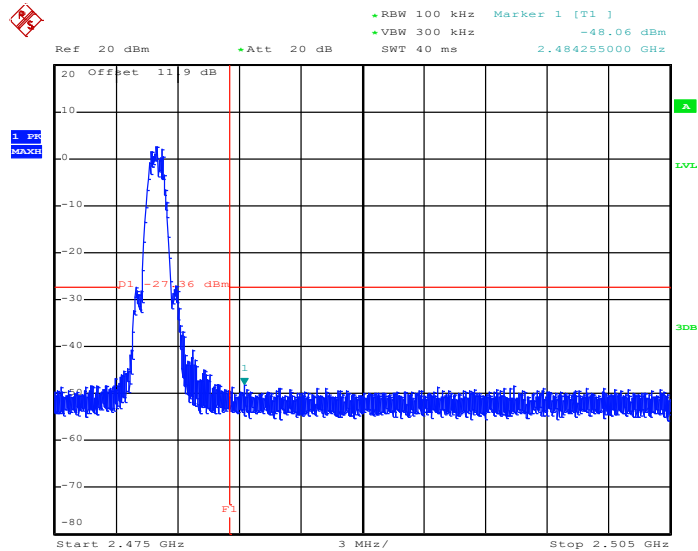

Date: 25.AUG.2020 09:39:29



<2Mbps>

Low Band Edge Plot on Channel 00

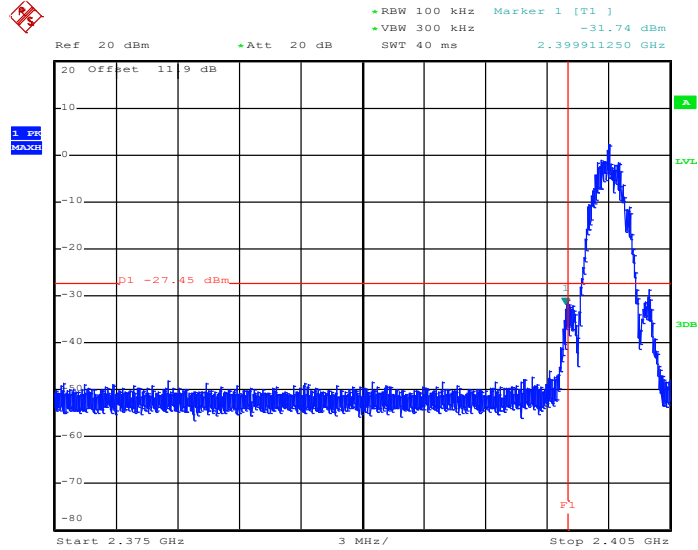

Date: 25.AUG.2020 09:53:54

High Band Edge Plot on Channel 39

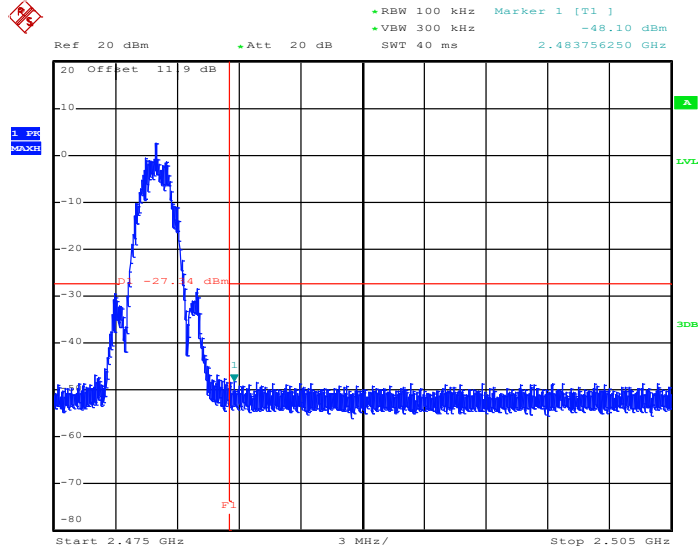

Date: 25.AUG.2020 10:28:38



3.4.6 Test Result of Conducted Spurious Emission Plots

<WCN3990>

Test Engineer :	Kathy Chen	Temperature :	23.9~24.3°C
		Relative Humidity :	53.8~54.3%

Conducted Spurious Emission Plot on Bluetooth LE 1Mbps GFSK Channel 00

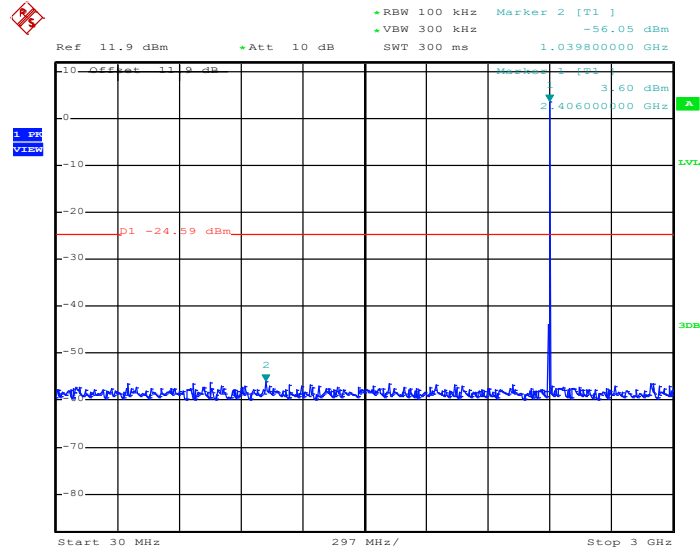

Date: 21.AUG.2020 09:14:34

Conducted Spurious Emission Plot on Bluetooth LE 1Mbps GFSK Channel 00

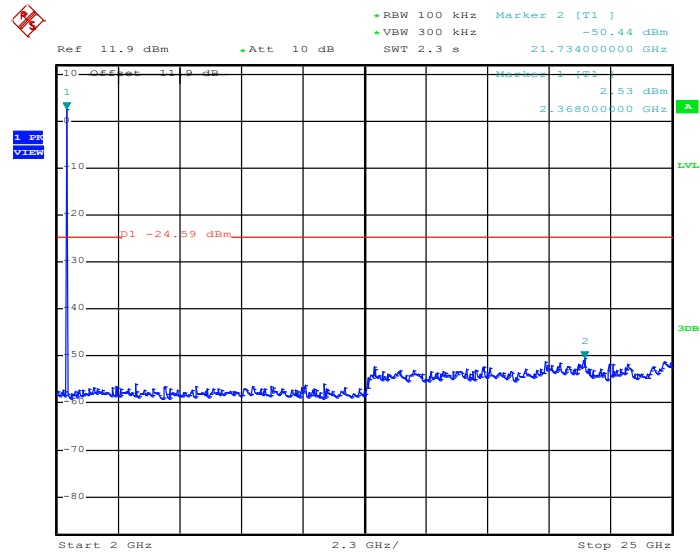

Date: 21.AUG.2020 09:14:53



Conducted Spurious Emission Plot on Bluetooth LE 1Mbps GFSK Channel 19

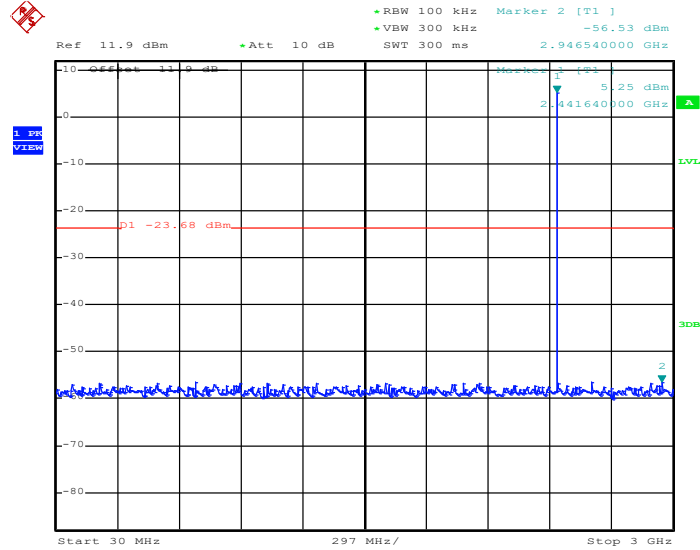

Date: 21.AUG.2020 09:27:48

Conducted Spurious Emission Plot on Bluetooth LE 1Mbps GFSK Channel 19

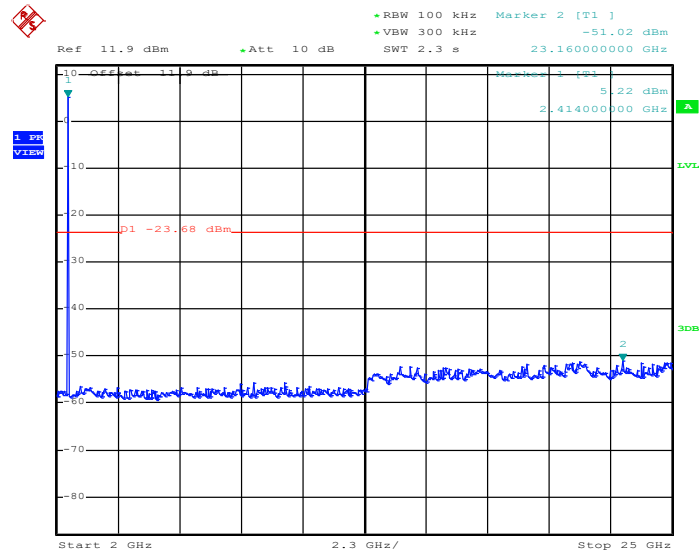

Date: 21.AUG.2020 09:28:06



Conducted Spurious Emission Plot on Bluetooth LE 1Mbps GFSK Channel 39

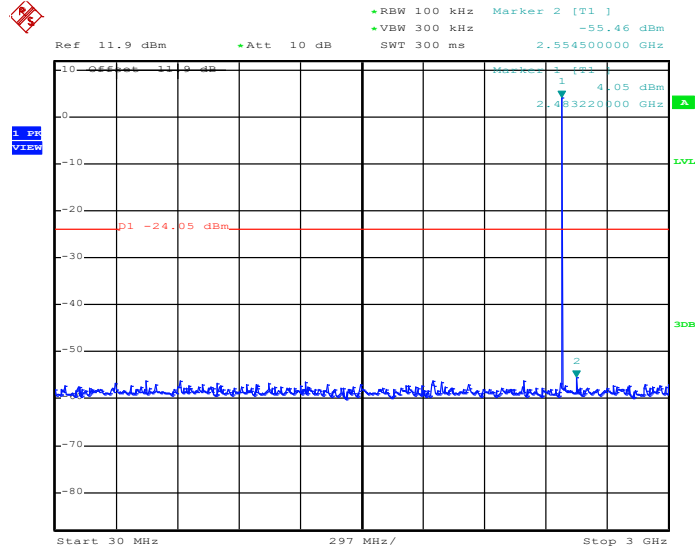

Date: 21.AUG.2020 09:43:15

Conducted Spurious Emission Plot on Bluetooth LE 1Mbps GFSK Channel 39

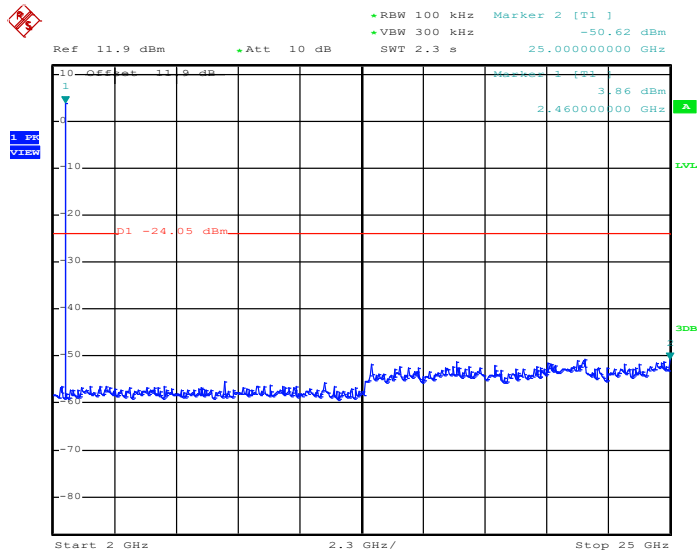

Date: 21.AUG.2020 09:43:55



Conducted Spurious Emission Plot on Bluetooth LE 2Mbps GFSK Channel 00

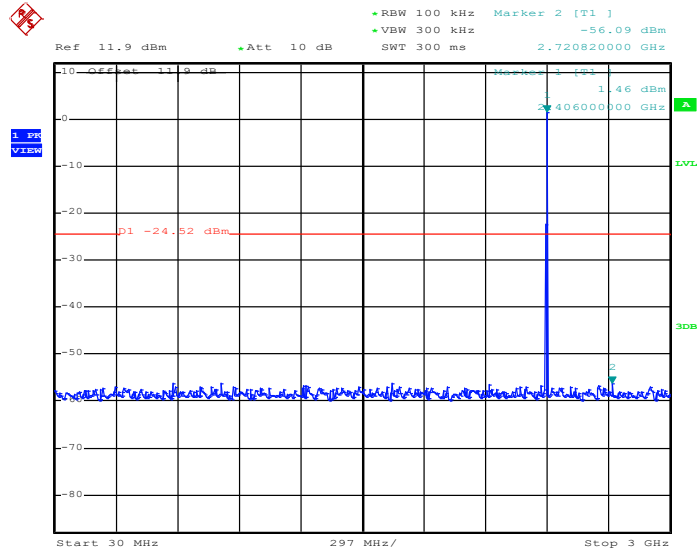

Date: 21.AUG.2020 10:03:20

Conducted Spurious Emission Plot on Bluetooth LE 2Mbps GFSK Channel 00

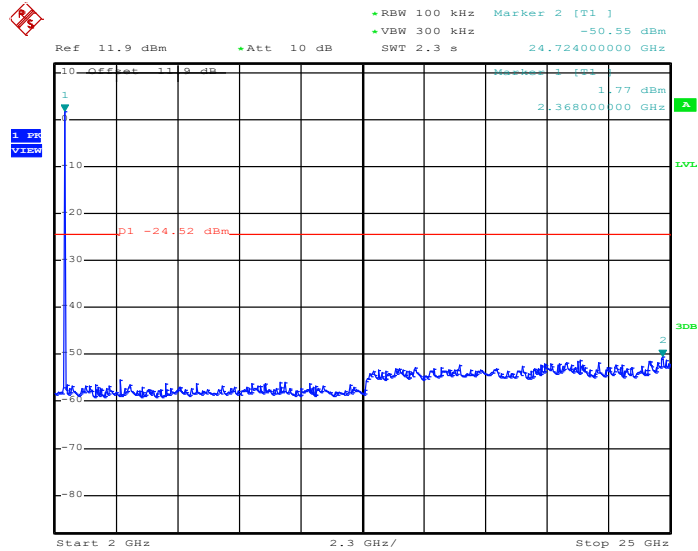

Date: 21.AUG.2020 10:03:37



Conducted Spurious Emission Plot on Bluetooth LE 2Mbps GFSK Channel 19

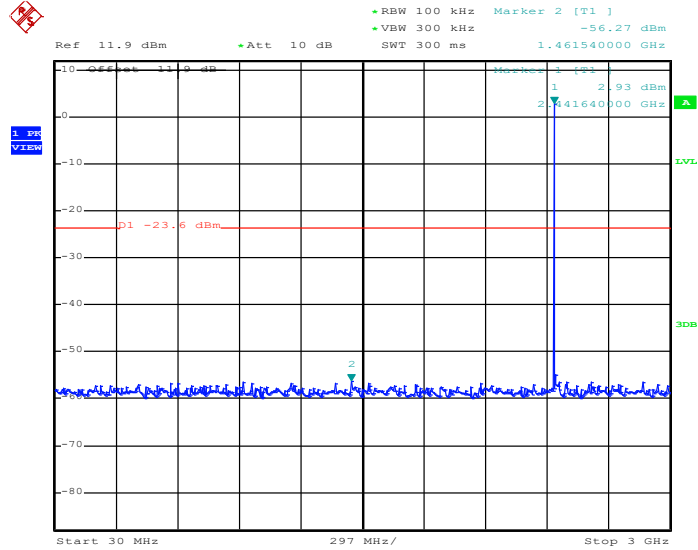

Date: 21.AUG.2020 10:19:44

Conducted Spurious Emission Plot on Bluetooth LE 2Mbps GFSK Channel 19

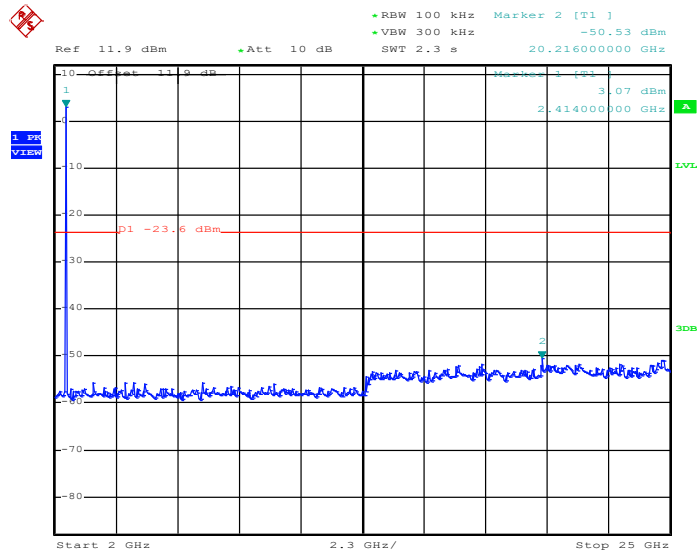

Date: 21.AUG.2020 10:19:59



Conducted Spurious Emission Plot on Bluetooth LE 2Mbps GFSK Channel 39

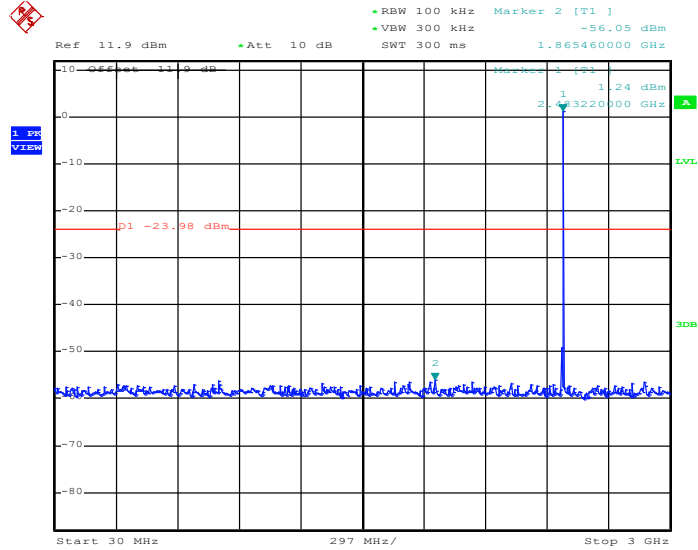

Date: 21.AUG.2020 10:31:06

Conducted Spurious Emission Plot on Bluetooth LE 2Mbps GFSK Channel 39

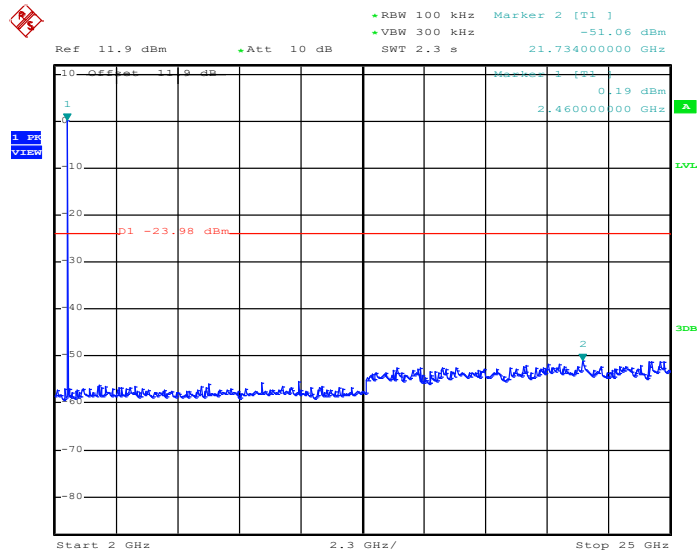

Date: 21.AUG.2020 10:31:22



<NRF52810>

Test Engineer :	Kathy Chen	Temperature :	23.9~24.3°C
		Relative Humidity :	53.8~54.3%

Conducted Spurious Emission Plot on Bluetooth LE 1Mbps GFSK Channel 00

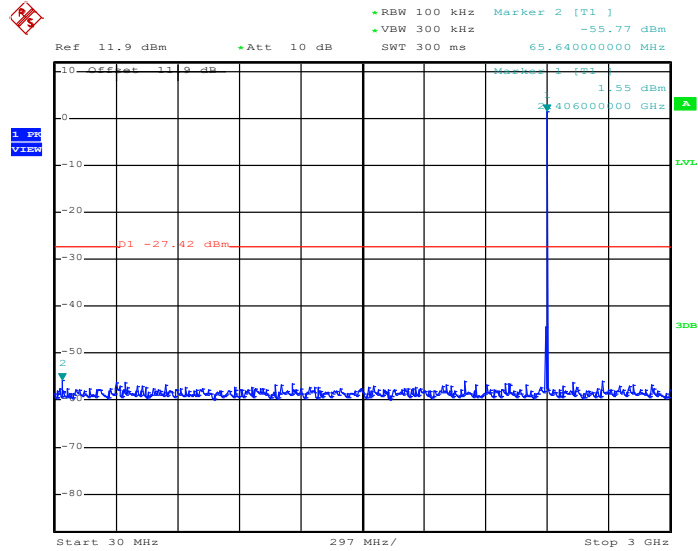

Date: 25.AUG.2020 09:07:24

Conducted Spurious Emission Plot on Bluetooth LE 1Mbps GFSK Channel 00

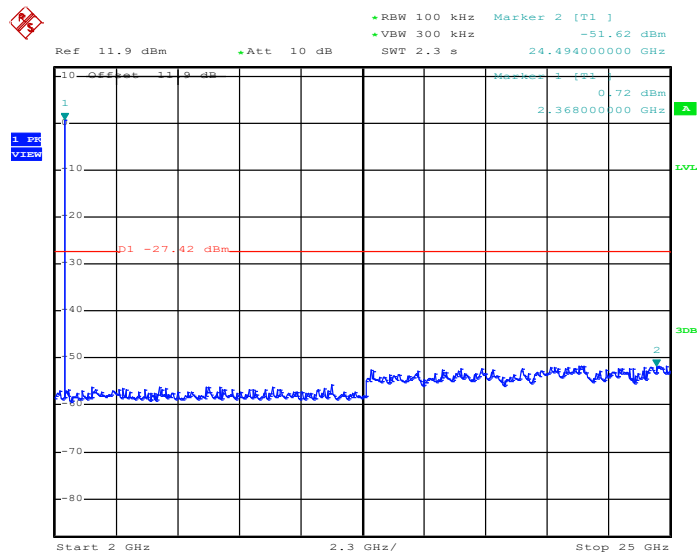

Date: 25.AUG.2020 09:08:58



Conducted Spurious Emission Plot on Bluetooth LE 1Mbps GFSK Channel 19

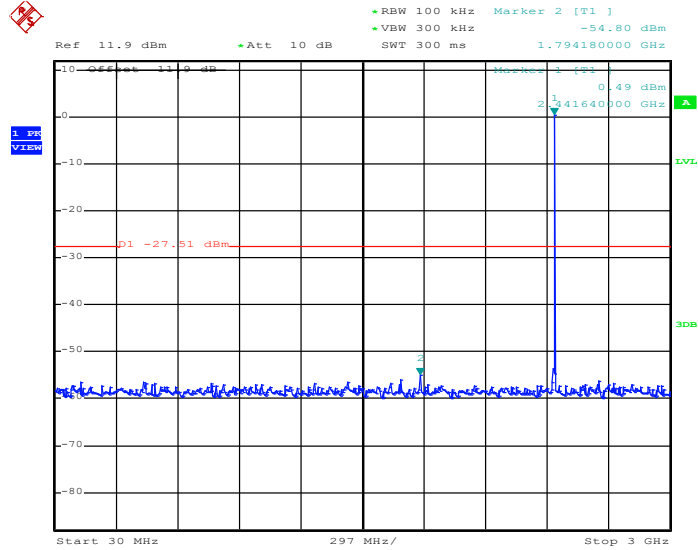

Date: 25.AUG.2020 09:22:59

Conducted Spurious Emission Plot on Bluetooth LE 1Mbps GFSK Channel 19

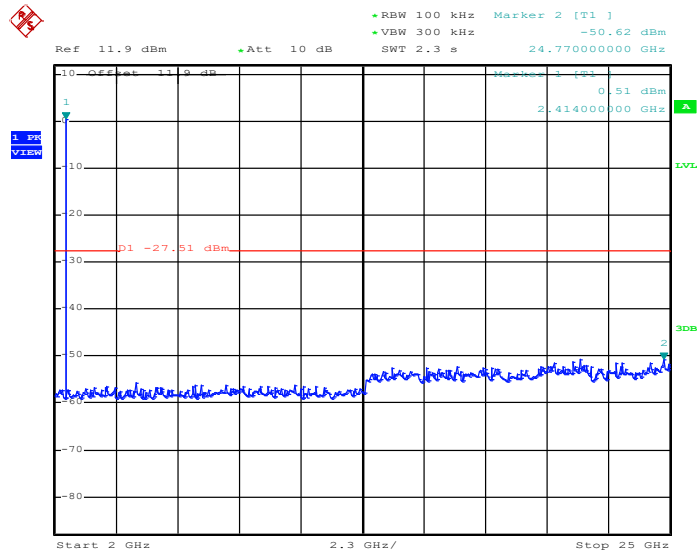

Date: 25.AUG.2020 09:23:16



Conducted Spurious Emission Plot on Bluetooth LE 1Mbps GFSK Channel 39

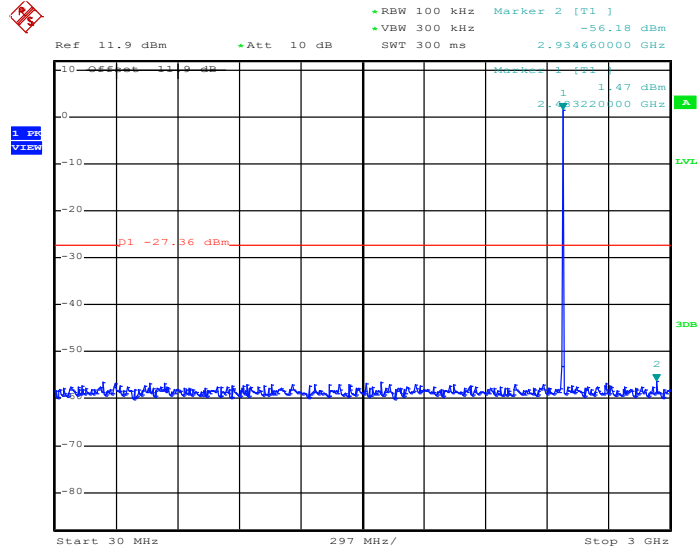

Date: 25.AUG.2020 09:43:14

Conducted Spurious Emission Plot on Bluetooth LE 1Mbps GFSK Channel 39

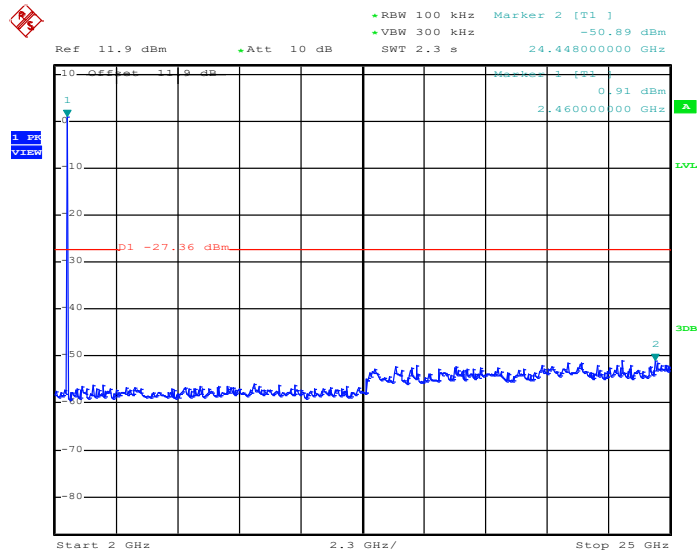

Date: 25.AUG.2020 09:43:30



Conducted Spurious Emission Plot on Bluetooth LE 2Mbps GFSK Channel 00

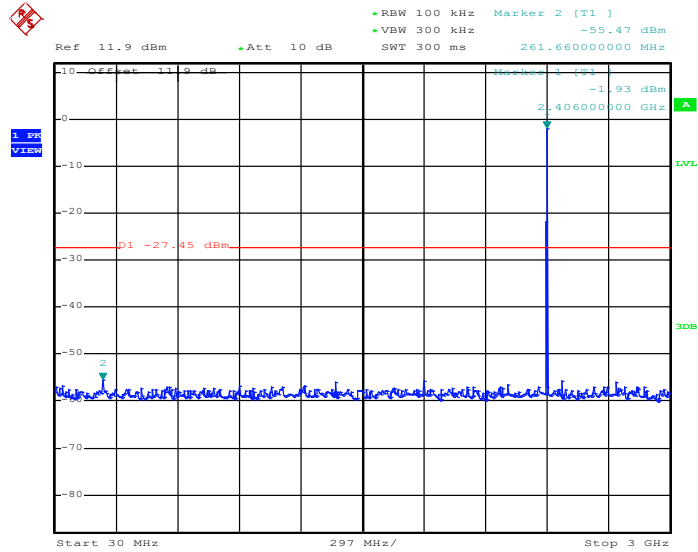

Date: 25.AUG.2020 09:54:34

Conducted Spurious Emission Plot on Bluetooth LE 2Mbps GFSK Channel 00

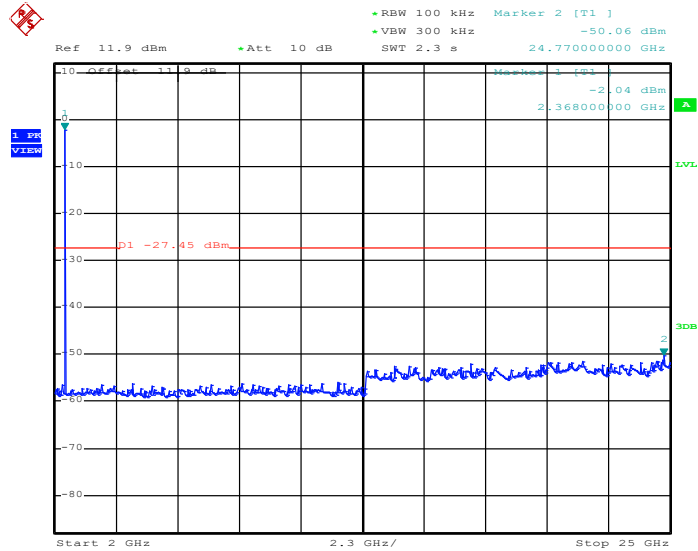

Date: 25.AUG.2020 09:54:50



Conducted Spurious Emission Plot on Bluetooth LE 2Mbps GFSK Channel 19

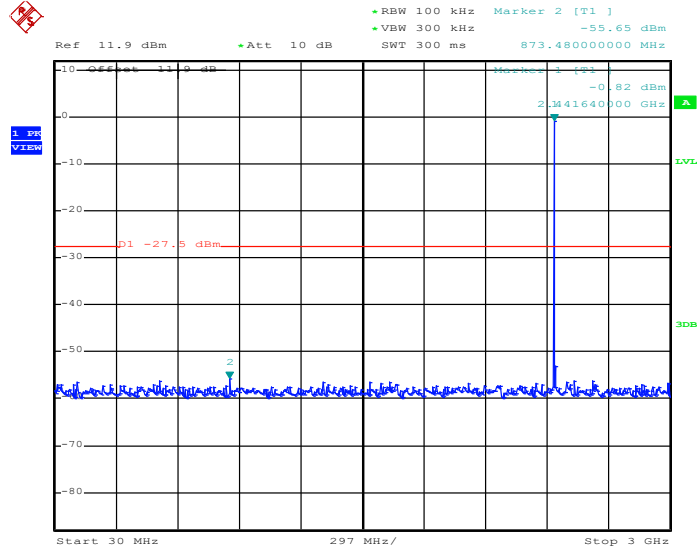

Date: 25.AUG.2020 10:06:52

Conducted Spurious Emission Plot on Bluetooth LE 2Mbps GFSK Channel 19

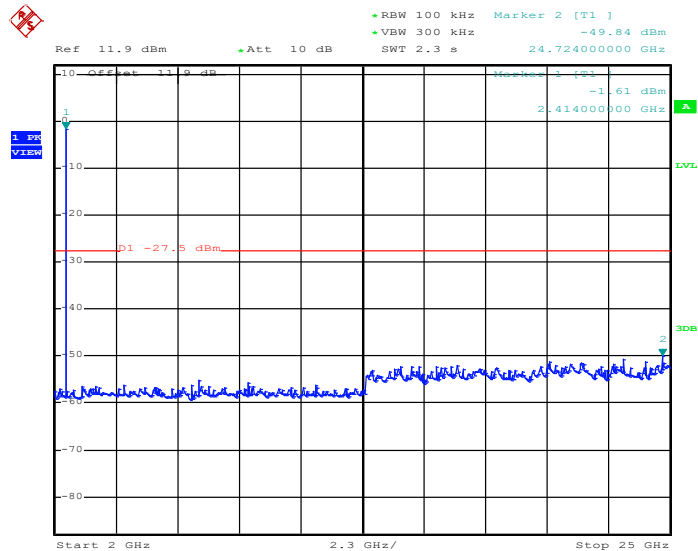

Date: 25.AUG.2020 10:07:08



Conducted Spurious Emission Plot on Bluetooth LE 2Mbps GFSK Channel 39

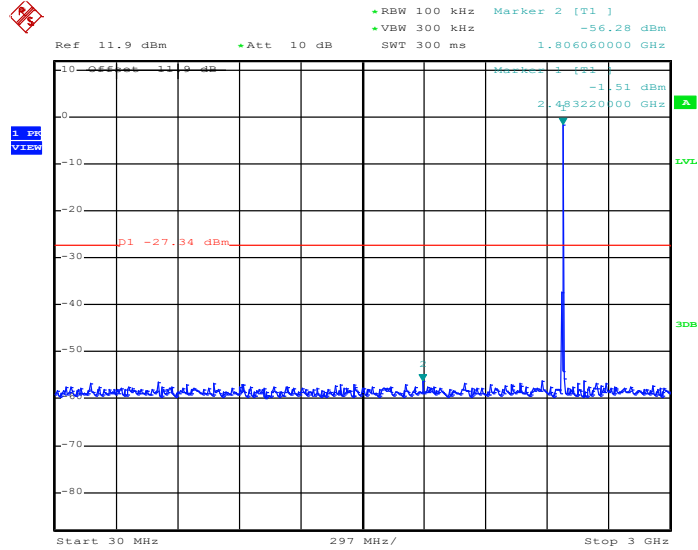

Date: 25.AUG.2020 10:32:25

Conducted Spurious Emission Plot on Bluetooth LE 2Mbps GFSK Channel 39

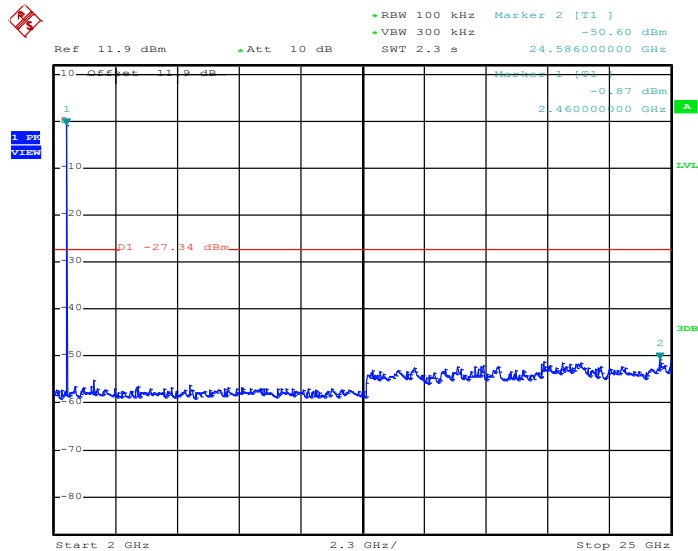

Date: 25.AUG.2020 10:32:39



3.5 Radiated Band Edges and Spurious Emission Measurement

3.5.1 Limit of Radiated Band Edges and Spurious Emission

In any 100 kHz bandwidth outside the intentional radiator frequency band, all harmonics/spurious must be at least 20 dB below the highest emission level within the authorized band. If the output power of this device was measured by spectrum analyzer, the attenuation under this paragraph shall be 30 dB instead of 20 dB. In addition, radiated emissions which fall in the restricted bands must also comply with the limits as below.

Frequency (MHz)	Field Strength (microvolts/meter)	Measurement Distance (meters)
0.009 – 0.490	2400/F(kHz)	300
0.490 – 1.705	24000/F(kHz)	30
1.705 – 30.0	30	30
30 – 88	100	3
88 – 216	150	3
216 - 960	200	3
Above 960	500	3

3.5.2 Measuring Instruments

See list of measuring equipment of this test report.



3.5.3 Test Procedures

1. The testing follows the ANSI C63.10 Section 11.12.1 Radiated emission measurements.
2. The EUT was arranged to its worst case and then tune the antenna tower (from 1 m to 4 m) and turntable (from 0 degree to 360 degrees) to find the maximum reading. A pre-amp and a high pass filter are used for the test in order to get better signal level.
3. The EUT was placed on a turntable with 0.8 meter for frequency below 1GHz and 1.5 meter for frequency above 1GHz respectively above ground.
4. The EUT was set 3 meters from the interference receiving antenna, which was mounted on the top of a variable height antenna tower.
5. Corrected Reading: Antenna Factor + Cable Loss + Read Level - Preamp Factor = Level
6. For testing below 1GHz, if the emission level of the EUT in peak mode was 3 dB lower than the limit specified, then peak values of EUT will be reported, otherwise, the emissions will be repeated one by one using the CISPR quasi-peak method and reported.
7. For testing above 1GHz, the emission level of the EUT in peak mode was 20dB lower than average limit (that means the emission level in average mode also complies with the limit in average mode), then peak values of EUT will be reported, otherwise, the emissions will be measured in average mode again and reported.
8. Use the following spectrum analyzer settings:
 - (1) Span shall wide enough to fully capture the emission being measured;
 - (2) Set RBW=100 kHz for $f < 1$ GHz; $VBW \geq RBW$; Sweep = auto; Detector function = peak; Trace = max hold;
 - (3) Set RBW = 1 MHz, VBW= 3MHz for $f \geq 1$ GHz for peak measurement.
For average measurement:
 - $VBW = 10$ Hz, when duty cycle is no less than 98 percent.
 - $VBW \geq 1/T$, when duty cycle is less than 98 percent where T is the minimum transmission duration over which the transmitter is on and is transmitting at its maximum power control level for the tested mode of operation.

3.5.4 Test Setup

For radiated emissions below 30MHz

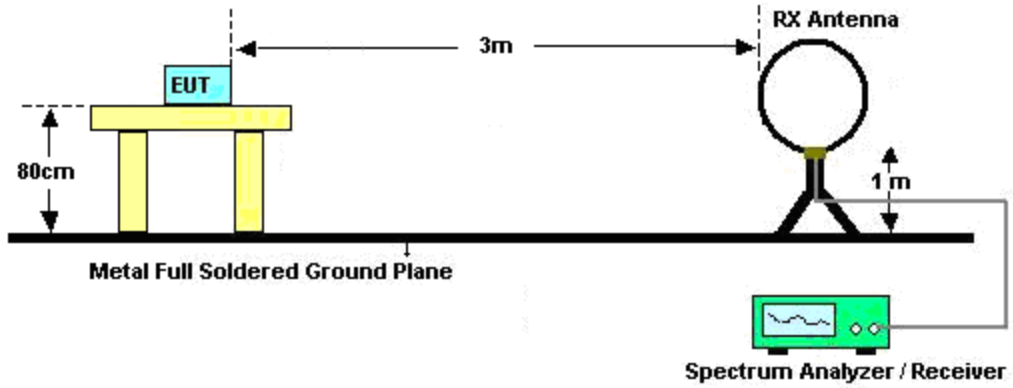

For radiated emissions from 30MHz to 1GHz

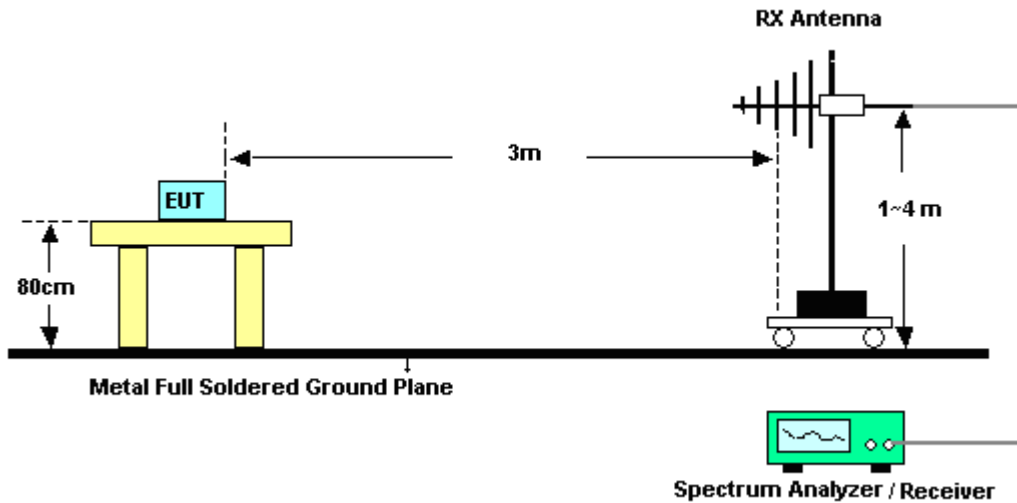

For radiated emissions from 1GHz to 18GHz

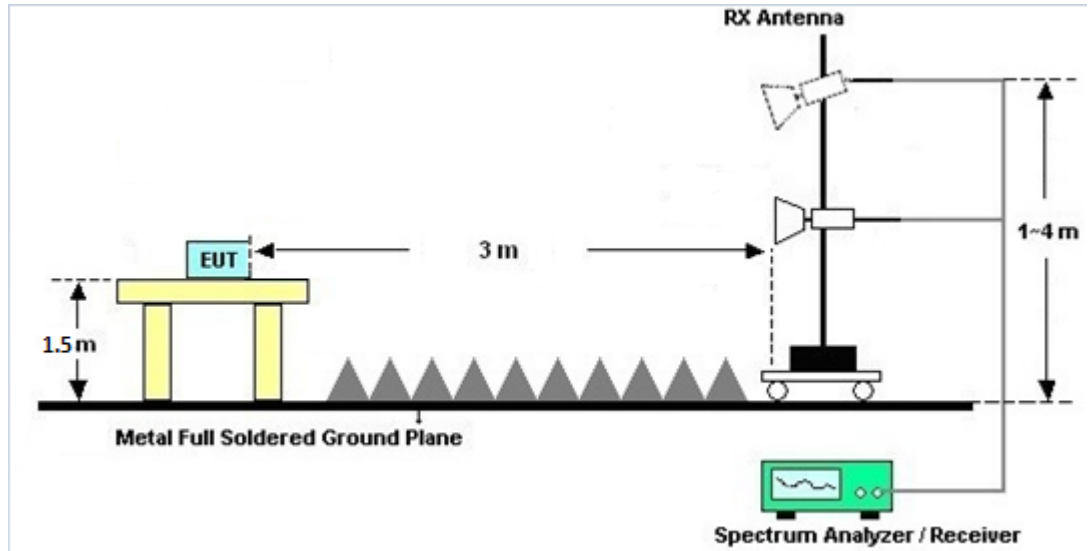

For radiated emissions above 18GHz

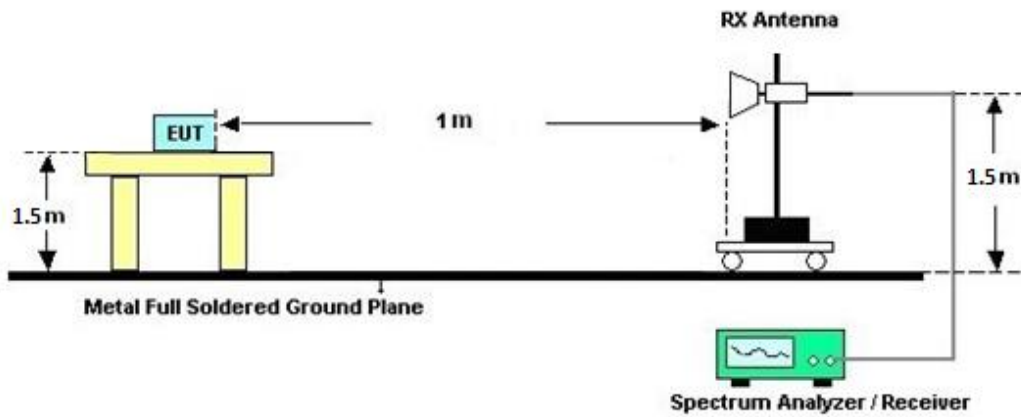



3.5.5 Test Results of Radiated Spurious Emissions (9 kHz ~ 30 MHz)

The low frequency, which started from 9 kHz to 30MHz, was pre-scanned and the result which was 20dB lower than the limit line was not reported.

There is a comparison data of both open-field test site and alternative test site - semi-Anechoic chamber according to 414788 D01 Radiated Test Site v01r01, and the result came out very similar.

3.5.6 Test Result of Radiated Spurious at Band Edges

Please refer to Appendix B and C.

3.5.7 Duty Cycle

Please refer to Appendix D.

3.5.8 Test Result of Radiated Spurious Emission (30MHz ~ 10th Harmonic)

Please refer to Appendix B and C.



3.6 AC Conducted Emission Measurement

3.6.1 Limit of AC Conducted Emission

For equipment that is designed to be connected to the public utility (AC) power line, the radio frequency voltage that is conducted back onto the AC power line on any frequency or frequencies within the band 150 kHz to 30 MHz shall not exceed the limits in the following table.

Frequency of emission (MHz)	Conducted limit (dB μ V)	
	Quasi-peak	Average
0.15-0.5	66 to 56*	56 to 46*
0.5-5	56	46
5-30	60	50

*Decreases with the logarithm of the frequency.

3.6.2 Measuring Instruments

See list of measuring equipment of this test report.

3.6.3 Test Procedures

1. The EUT was placed 0.4 meter from the conducting wall of the shielding room was kept at least 80 centimeters from any other grounded conducting surface.
2. Connect EUT to the power mains through a line impedance stabilization network (LISN).
3. All the support units are connecting to the other LISN.
4. The LISN provides 50 ohm coupling impedance for the measuring instrument.
5. The FCC states that a 50 ohm, 50 microhenry LISN should be used.
6. Both sides of AC line were checked for maximum conducted interference.
7. The frequency range from 150 kHz to 30 MHz was searched.
8. Set the test-receiver system to Peak Detect Function and specified bandwidth (IF Bandwidth = 9kHz) with Maximum Hold Mode. Then measurement is also conducted by Average Detector and Quasi-Peak Detector Function respectively.

3.6.4 Test Setup

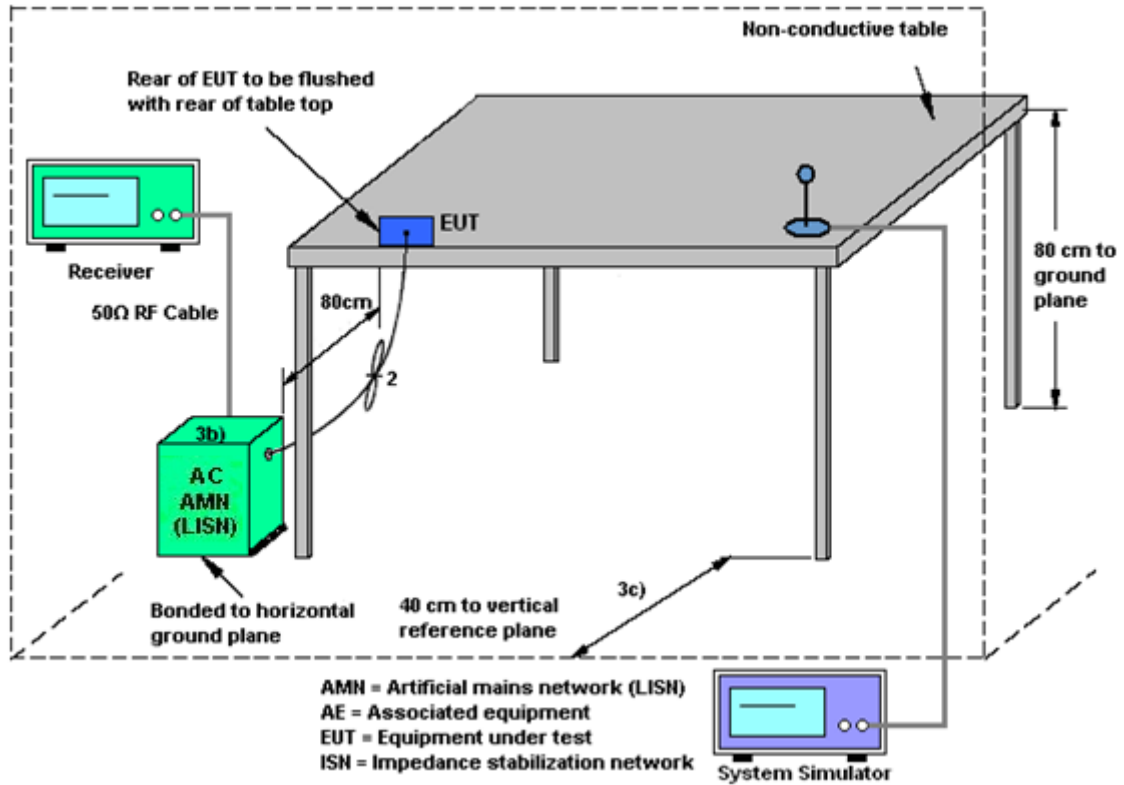

3.6.5 Test Result of AC Conducted Emission

Please refer to Appendix A.



3.7 Antenna Requirements

3.7.1 Standard Applicable

If directional gain of transmitting antennas is greater than 6dBi, the power shall be reduced by the same level in dB comparing to gain minus 6dBi. The use of a permanently attached antenna or of an antenna that uses a unique coupling to the intentional radiator shall be considered sufficient to comply with the rule.

3.7.2 Antenna Anti-Replacement Construction

An embedded-in antenna design is used.

3.7.3 Antenna Gain

The antenna peak gain of EUT is less than 6 dBi. Therefore, it is not necessary to reduce maximum peak output power limit.



4 List of Measuring Equipment

Instrument	Brand Name	Model No.	Serial No.	Characteristics	Calibration Date	Test Date	Due Date	Remark
Loop Antenna	Rohde & Schwarz	HFH2-Z2	100488	9 kHz~30 MHz	Jan. 09, 2020	Aug. 08, 2020~ Sep. 01, 2020	Jan. 08, 2021	Radiation (03CH16-HY)
Bilog Antenna	TESEQ	CBL6111D&008 02N1D01N-06	47020&06	30MHz to 1GHz	Oct. 12, 2019	Aug. 08, 2020~ Sep. 01, 2020	Oct. 11, 2020	Radiation (03CH16-HY)
Horn Antenna	SCHWARZBE CK	BBHA 9120 D	9120D-15 22	1G~18GHz	Sep. 19, 2019	Aug. 08, 2020~ Sep. 01, 2020	Sep. 18, 2020	Radiation (03CH16-HY)
SHF-EHF Horn Antenna	SCHWARZBE CK	BBHA 9170	BBHA917 0980	18GHz~40GHz	Jan. 10, 2020	Aug. 08, 2020~ Sep. 01, 2020	Jan. 09, 2021	Radiation (03CH16-HY)
Amplifier	SONOMA	310N	371607	9kHz~1G	Oct. 01, 2019	Aug. 08, 2020~ Sep. 01, 2020	Sep. 30, 2020	Radiation (03CH16-HY)
Preamplifier	Jet-Power	JPA0118-55-30 3	17100018 00055006	1GHz~18GHz	May 07, 2020	Aug. 08, 2020~ Sep. 01, 2020	May 06, 2021	Radiation (03CH16-HY)
Preamplifier	EMEC	EM18G40G	060715	18GHz ~40GHz	Dec. 13, 2019	Aug. 08, 2020~ Sep. 01, 2020	Dec. 12, 2020	Radiation (03CH16-HY)
Preamplifier	Keysight	83017A	MY53270 264	1GHz~26.5GHz	Dec. 11, 2019	Aug. 08, 2020~ Sep. 01, 2020	Dec. 10, 2020	Radiation (03CH16-HY)
EMI Test Receiver	Keysight	N9038A(MXE)	MY57290 111	3Hz~26.5GHz	Dec. 05, 2019	Aug. 08, 2020~ Sep. 01, 2020	Dec. 04, 2020	Radiation (03CH16-HY)
RF Cable	HUBER + SUHNER	SUCOFLEX 104	MY11680/ 4PE	NA	Aug. 30, 2019	Aug. 08, 2020~ Aug. 28, 2020	Aug. 29, 2020	Radiation (03CH16-HY)
RF Cable	HUBER + SUHNER	SUCOFLEX 104	MY11680/ 4PE	NA	Aug. 29, 2020	Aug. 29, 2020~ Sep. 01, 2020	Aug. 28, 2021	Radiation (03CH16-HY)
RF Cable	HUBER + SUHNER	SUCOFLEX 104	MY11688/ 4PE	NA	Aug. 30, 2019	Aug. 08, 2020~ Aug. 28, 2020	Aug. 29, 2020	Radiation (03CH16-HY)
RF Cable	HUBER + SUHNER	SUCOFLEX 104	MY11688/ 4PE	NA	Aug. 29, 2020	Aug. 29, 2020~ Sep. 01, 2020	Aug. 28, 2021	Radiation (03CH16-HY)
RF Cable	HUBER + SUHNER	SUCOFLEX 102	EC-A5-30 0-5757	NA	Aug. 30, 2019	Aug. 08, 2020~ Aug. 28, 2020	Aug. 29, 2020	Radiation (03CH16-HY)
RF Cable	HUBER + SUHNER	SUCOFLEX 102	EC-A5-30 0-5757	NA	Aug. 29, 2020	Aug. 29, 2020~ Sep. 01, 2020	Aug. 28, 2021	Radiation (03CH16-HY)
Hygrometer	TECPEL	DTM-303B	TP16296 5	N/A	Oct. 25, 2019	Aug. 08, 2020~ Sep. 01, 2020	Oct. 24, 2020	Radiation (03CH16-HY)
Software	Audix	E3 6.2009-8-24	RK-00113 6	N/A	N/A	Aug. 08, 2020~ Sep. 01, 2020	N/A	Radiation (03CH16-HY)
Controller	ChainTek	3000-1	N/A	Control Turn table & Ant Mast	N/A	Aug. 08, 2020~ Sep. 01, 2020	N/A	Radiation (03CH16-HY)
Antenna Mast	ChainTek	MBS-520-1	N/A	1m~4m	N/A	Aug. 08, 2020~ Sep. 01, 2020	N/A	Radiation (03CH16-HY)
Turn Table	ChainTek	T-200-S-1	N/A	0~360 Degree	N/A	Aug. 08, 2020~ Sep. 01, 2020	N/A	Radiation (03CH16-HY)



Instrument	Brand Name	Model No.	Serial No.	Characteristics	Calibration Date	Test Date	Due Date	Remark
Hygrometer	Testo	608-H1	34893241	N/A	Mar. 02, 2020	Aug. 17, 2020~ Aug. 25, 2020	Mar. 01, 2021	Conducted (TH05-HY)
Power Sensor	DARE	RPR3006W	16I00054S NO10	10MHz~6GHz	Dec. 23, 2019	Aug. 17, 2020~ Aug. 25, 2020	Dec. 22, 2020	Conducted (TH05-HY)
Spectrum Analyzer	Rohde & Schwarz	FSP40	100055	9kHz-40GHz	Dec. 30, 2019	Aug. 17, 2020~ Aug. 25, 2020	Dec. 29, 2020	Conducted (TH05-HY)
Switch Box & RF Cable	EM Electronics	EMSW18SE	SW200302	N/A	Mar. 17, 2020	Aug. 17, 2020~ Aug. 25, 2020	Mar. 16, 2021	Conducted (TH05-HY)
AC Power Source	ChainTek	APC-1000W	N/A	N/A	N/A	Sep. 23, 2020	N/A	Conduction (CO05-HY)
EMI Test Receiver	Rohde & Schwarz	ESR3	102388	9kHz~3.6GHz	Nov. 15, 2019	Sep. 23, 2020	Nov. 14, 2020	Conduction (CO05-HY)
Hygrometer	Testo	608-H1	34913912	N/A	Nov. 07, 2019	Sep. 23, 2020	Nov. 06, 2020	Conduction (CO05-HY)
LISN	Rohde & Schwarz	ENV216	100081	9kHz~30MHz	Nov. 15, 2019	Sep. 23, 2020	Nov. 14, 2020	Conduction (CO05-HY)
Software	Rohde & Schwarz	EMC32 V10.30	N/A	N/A	N/A	Sep. 23, 2020	N/A	Conduction (CO05-HY)
LF Cable	HUBER + SUHNER	RG-214/U	LF01	N/A	Jan. 02, 2020	Sep. 23, 2020	Jan. 01, 2021	Conduction (CO05-HY)
Pulse Limiter	Rohde & Schwarz	ESH3-Z2	100851	N/A	Jan. 02, 2020	Sep. 23, 2020	Jan. 01, 2021	Conduction (CO05-HY)



5 Uncertainty of Evaluation

Uncertainty of Conducted Emission Measurement (150 kHz ~ 30 MHz)

Measuring Uncertainty for a Level of Confidence of 95% ($U = 2Uc(y)$)	2.3
---	-----

Uncertainty of Radiated Emission Measurement (30 MHz ~ 1000 MHz)

Measuring Uncertainty for a Level of Confidence of 95% ($U = 2Uc(y)$)	4.5
---	-----

Uncertainty of Radiated Emission Measurement (1000 MHz ~ 18000 MHz)

Measuring Uncertainty for a Level of Confidence of 95% ($U = 2Uc(y)$)	6.3
---	-----

Uncertainty of Radiated Emission Measurement (18000 MHz ~ 40000 MHz)

Measuring Uncertainty for a Level of Confidence of 95% ($U = 2Uc(y)$)	4.7
---	-----



Appendix A. AC Conducted Emission Test Results

Test Engineer :	Tom Lee	Temperature :	24~26°C
		Relative Humidity :	42~50%

EUT Information

Report NO : 070401
 Test Mode : Mode 1
 Test Voltage : 120Vac/60Hz
 Phase : Line

Full Spectrum

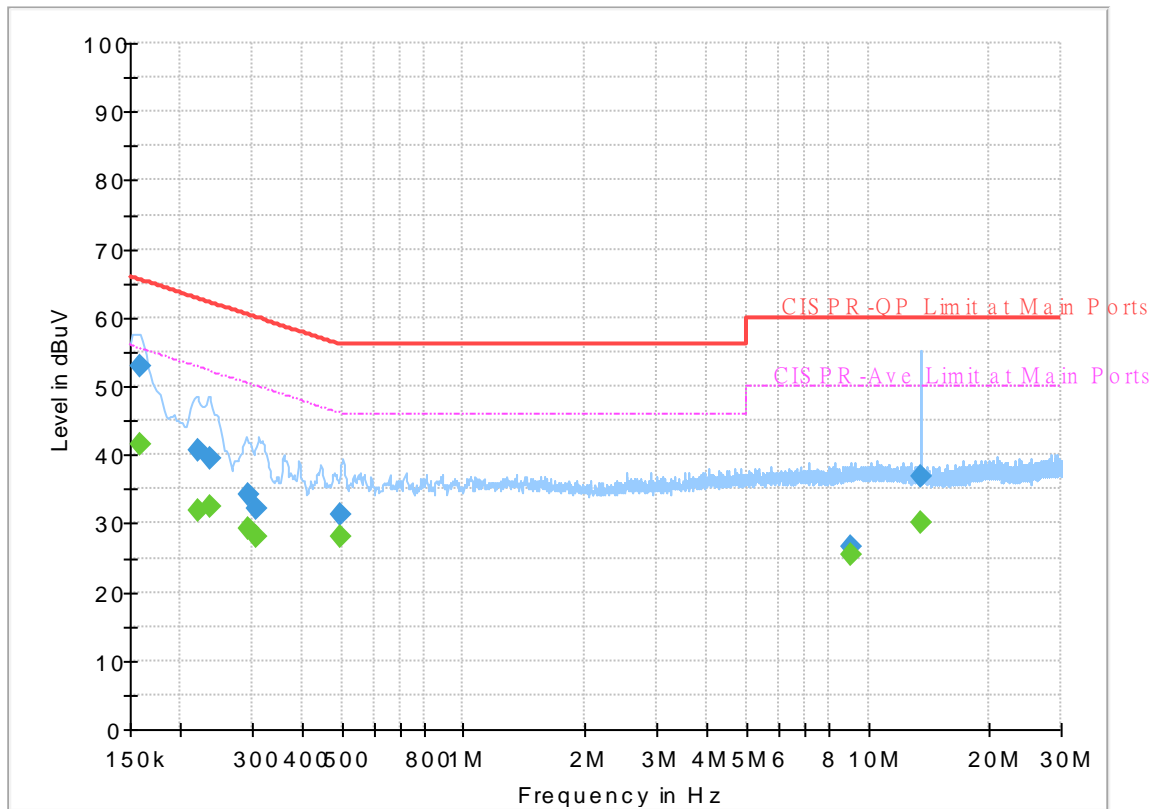

Final_Result

Frequency (MHz)	QuasiPeak (dBuV)	CAverage (dBuV)	Limit (dBuV)	Margin (dB)	Line	Filter	Corr. (dB)
0.159000	---	41.55	55.52	13.97	L1	OFF	19.6
0.159000	52.88	---	65.52	12.64	L1	OFF	19.6
0.219750	---	31.98	52.83	20.85	L1	OFF	19.6
0.219750	40.75	---	62.83	22.08	L1	OFF	19.6
0.235500	---	32.39	52.25	19.86	L1	OFF	19.6
0.235500	39.50	---	62.25	22.75	L1	OFF	19.6
0.294000	---	29.21	50.41	21.20	L1	OFF	19.6
0.294000	34.22	---	60.41	26.19	L1	OFF	19.6
0.307500	---	28.05	50.04	21.99	L1	OFF	19.6
0.307500	32.26	---	60.04	27.78	L1	OFF	19.6
0.498750	---	28.07	46.02	17.95	L1	OFF	19.6
0.498750	31.36	---	56.02	24.66	L1	OFF	19.6
9.035250	---	25.54	50.00	24.46	L1	OFF	20.0
9.035250	26.59	---	60.00	33.41	L1	OFF	20.0
13.560000	---	30.09	50.00	19.91	L1	OFF	20.2
13.560000	36.85	---	60.00	23.15	L1	OFF	20.2

EUT Information

Report NO : 070401
 Test Mode : Mode 1
 Test Voltage : 120Vac/60Hz
 Phase : Neutral

Full Spectrum

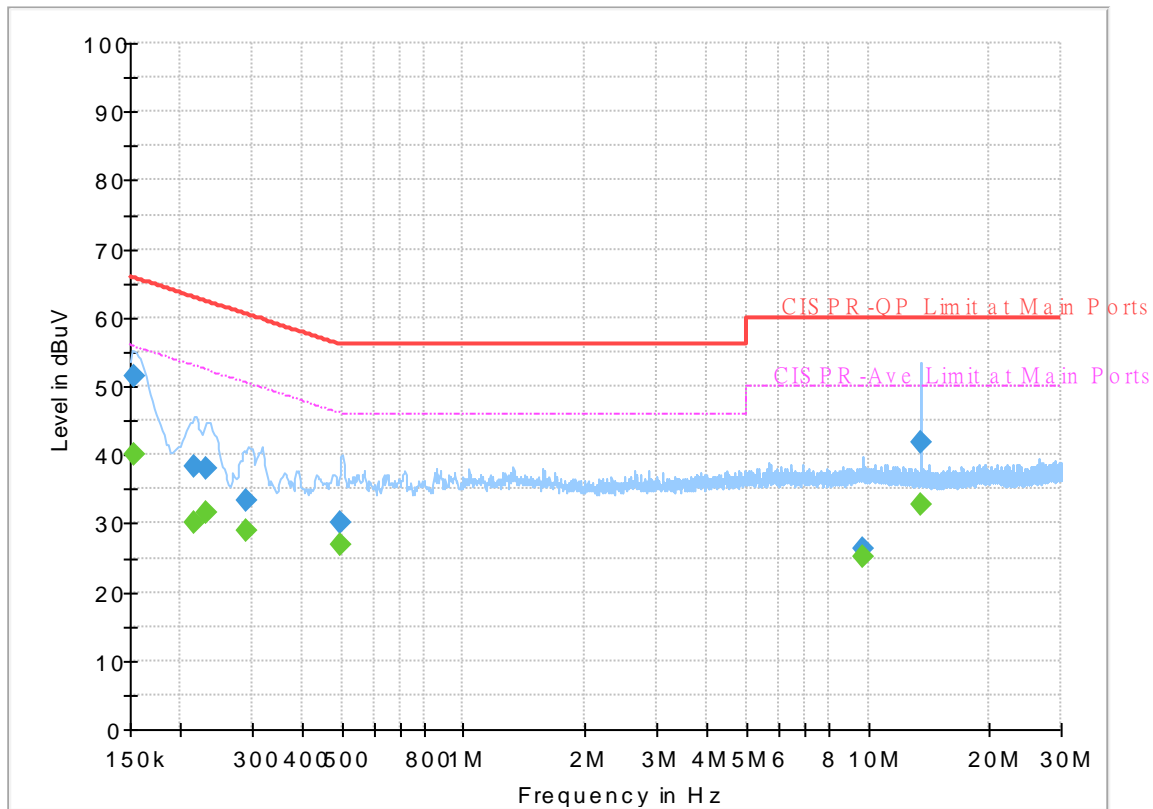

Final Result

Frequency (MHz)	QuasiPeak (dBuV)	CAverage (dBuV)	Limit (dBuV)	Margin (dB)	Line	Filter	Corr. (dB)
0.153656	---	40.07	55.80	15.73	N	OFF	19.5
0.153656	51.42	---	65.80	14.38	N	OFF	19.5
0.216150	---	30.06	52.97	22.91	N	OFF	19.5
0.216150	38.35	---	62.97	24.62	N	OFF	19.5
0.232260	---	31.64	52.37	20.73	N	OFF	19.5
0.232260	37.93	---	62.37	24.44	N	OFF	19.5
0.289500	---	29.07	50.54	21.47	N	OFF	19.5
0.289500	33.20	---	60.54	27.34	N	OFF	19.5
0.498750	---	27.02	46.02	19.00	N	OFF	19.5
0.498750	30.13	---	56.02	25.89	N	OFF	19.5
9.709890	---	25.11	50.00	24.89	N	OFF	19.8
9.709890	26.27	---	60.00	33.73	N	OFF	19.8
13.560000	---	32.86	50.00	17.14	N	OFF	19.9
13.560000	41.76	---	60.00	18.24	N	OFF	19.9



Appendix B. Radiated Spurious Emission

Test Engineer :	Andy Yang, Karl Hou and CR Liao	Temperature :	20~25°C
		Relative Humidity :	50~65%

<WCN3990>

<1Mbps>

2.4GHz 2400~2483.5MHz

BLE (Band Edge @ 3m)

BLE	Note	Frequency	Level	Over	Limit	Read	Antenna	Path	Preamp	Ant	Table	Peak	Pol.	
		(MHz)	(dBμV/m)	(dB)	(dBμV/m)	(dBμV)	(dB/m)	(dB)	(dB)	(cm)	(deg)	(P/A)	(H/V)	
BLE CH 00 2402MHz		2348.955	57.39	-16.61	74	41.33	27.8	18.03	29.77	142	148	P	H	
		2373.105	46.73	-7.27	54	30.73	27.71	18.07	29.78	142	148	A	H	
	*	2402	101.35	-	-	85.43	27.6	18.11	29.79	142	148	P	H	
	*	2402	100.72	-	-	84.8	27.6	18.11	29.79	142	148	A	H	
			2329.74	56.71	-17.29	74	40.6	27.88	17.99	29.76	328	15	P	V
			2364.285	46.75	-7.25	54	30.73	27.74	18.05	29.77	328	15	A	V
	*		2402	95.71	-	-	79.79	27.6	18.11	29.79	328	15	P	V
	*		2402	95.06	-	-	79.14	27.6	18.11	29.79	328	15	A	V
BLE CH 19 2440MHz		2372.02	56.99	-17.01	74	41	27.71	18.06	29.78	100	148	P	H	
		2372.58	46.55	-7.45	54	30.56	27.71	18.06	29.78	100	148	A	H	
	*	2440	101.31	-	-	85.34	27.6	18.17	29.8	100	148	P	H	
	*	2440	100.39	-	-	84.42	27.6	18.17	29.8	100	148	A	H	
			2490.9	57.15	-16.85	74	41.2	27.52	18.26	29.83	100	148	P	H
			2493.56	46.69	-7.31	54	30.75	27.51	18.26	29.83	100	148	A	H
			2330.58	57.11	-16.89	74	40.99	27.88	18	29.76	320	15	P	V
			2374.4	46.6	-7.4	54	30.61	27.7	18.07	29.78	320	15	A	V
	*		2440	96.19	-	-	80.22	27.6	18.17	29.8	320	15	P	V
	*		2440	95.62	-	-	79.65	27.6	18.17	29.8	320	15	A	V
		2496.57	56.16	-17.84	74	40.22	27.51	18.26	29.83	320	15	P	V	
		2487.19	46.65	-7.35	54	30.69	27.53	18.25	29.82	320	15	A	V	



BLE CH 39 2480MHz	*	2480	101.81	-	-	85.85	27.54	18.24	29.82	100	147	P	H
	*	2480	101.06	-	-	85.1	27.54	18.24	29.82	100	147	A	H
		2487.56	56.63	-17.37	74	40.68	27.52	18.25	29.82	100	147	P	H
		2493.48	46.79	-7.21	54	30.85	27.51	18.26	29.83	100	147	A	H
													H
	*	2480	96.32	-	-	80.36	27.54	18.24	29.82	400	88	P	V
	*	2480	95.78	-	-	79.82	27.54	18.24	29.82	400	88	A	V
		2485.36	56.2	-17.8	74	40.24	27.53	18.25	29.82	400	88	P	V
		2497.48	46.7	-7.3	54	30.75	27.51	18.27	29.83	400	88	A	V
													V
Remark	<ol style="list-style-type: none"> 1. No other spurious found. 2. All results are PASS against Peak and Average limit line. 												



2.4GHz 2400~2483.5MHz
BLE (Harmonic @ 3m)

BLE	Note	Frequency (MHz)	Level (dBµV/m)	Over Limit (dB)	Limit Line (dBµV/m)	Read Level (dBµV)	Antenna Factor (dB/m)	Path Loss (dB)	Preamp Factor (dB)	Ant Pos (cm)	Table Pos (deg)	Peak Avg. (P/A)	Pol. (H/V)
BLE CH 00 2402MHz		4804	39.56	-34.44	74	55.13	31.11	12.4	59.08	100	0	P	H
													H
													H
													H
		4804	39.92	-34.08	74	55.49	31.11	12.4	59.08	100	0	P	V
													V
													V
BLE CH 19 2440MHz		4880	39.43	-34.57	74	55	31.08	12.48	59.13	100	0	P	H
		7320	46.04	-27.96	74	52.43	36.48	15.68	58.55	100	0	P	H
													H
													H
		4880	39.39	-34.61	74	54.96	31.08	12.48	59.13	100	0	P	V
		7320	46.43	-27.57	74	52.82	36.48	15.68	58.55	100	0	P	V
													V
BLE CH 39 2480MHz		4960	40.18	-33.82	74	55.54	31.26	12.56	59.18	100	0	P	H
		7440	46.35	-27.65	74	52.37	36.58	15.78	58.38	100	0	P	H
													H
													H
		4960	40.11	-33.89	74	55.47	31.26	12.56	59.18	100	0	P	V
		7440	46.66	-27.34	74	52.68	36.58	15.78	58.38	100	0	P	V
													V
Remark	1. No other spurious found. 2. All results are PASS against Peak and Average limit line.												



<2Mbps>

2.4GHz 2400~2483.5MHz

BLE (Band Edge @ 3m)

BLE	Note	Frequency	Level	Over Limit	Limit Line	Read Level	Antenna Factor	Path Loss	Preamp Factor	Ant Pos	Table Pos	Peak Avg.	Pol.	
		(MHz)	(dBμV/m)	(dB)	(dBμV/m)	(dBμV)	(dB/m)	(dB)	(dB)	(cm)	(deg)	(P/A)	(H/V)	
BLE CH 00 2402MHz		2315.565	56.9	-17.1	74	40.74	27.94	17.97	29.75	142	151	P	H	
		2386.965	48.84	-5.16	54	32.88	27.65	18.09	29.78	142	151	A	H	
	*	2402	101.7	-	-	85.78	27.6	18.11	29.79	142	151	P	H	
	*	2402	100.36	-	-	84.44	27.6	18.11	29.79	142	151	A	H	
													H	
			2387.28	56.34	-17.66	74	40.38	27.65	18.09	29.78	362	344	P	V
			2343.81	48.54	-5.46	54	32.46	27.82	18.02	29.76	362	344	A	V
	*		2402	94.69	-	-	78.77	27.6	18.11	29.79	362	344	P	V
*		2402	93.36	-	-	77.44	27.6	18.11	29.79	362	344	A	V	
BLE CH 19 2440MHz		2341.08	56.56	-17.44	74	40.47	27.84	18.01	29.76	109	149	P	H	
		2317.28	48.42	-5.58	54	32.27	27.93	17.97	29.75	109	149	A	H	
	*	2440	101.64	-	-	85.67	27.6	18.17	29.8	109	149	P	H	
	*	2440	100.34	-	-	84.37	27.6	18.17	29.8	109	149	A	H	
			2498.11	56.73	-17.27	74	40.79	27.5	18.27	29.83	109	149	P	H
			2484.11	48.47	-5.53	54	32.52	27.53	18.24	29.82	109	149	A	H
			2316.16	56.08	-17.92	74	39.92	27.94	17.97	29.75	398	347	P	V
			2371.46	48.47	-5.53	54	32.48	27.71	18.06	29.78	398	347	A	V
	*		2440	94.87	-	-	78.9	27.6	18.17	29.8	398	347	P	V
	*		2440	93.62	-	-	77.65	27.6	18.17	29.8	398	347	A	V
		2487.68	56.27	-17.73	74	40.32	27.52	18.25	29.82	398	347	P	V	
		2498.46	48.43	-5.57	54	32.49	27.5	18.27	29.83	398	347	A	V	



BLE CH 39 2480MHz	*	2480	101.82	-	-	85.86	27.54	18.24	29.82	100	149	P	H
	*	2480	100.33	-	-	84.37	27.54	18.24	29.82	100	149	A	H
		2485.96	56.92	-17.08	74	40.96	27.53	18.25	29.82	100	149	P	H
		2490.24	49.32	-4.68	54	33.38	27.52	18.25	29.83	100	149	A	H
													H
													H
	*	2480	96.82	-	-	80.86	27.54	18.24	29.82	400	89	P	V
	*	2480	95.33	-	-	79.37	27.54	18.24	29.82	400	89	A	V
		2493.52	57.61	-16.39	74	41.67	27.51	18.26	29.83	400	89	P	V
		2498.08	48.67	-5.33	54	32.73	27.5	18.27	29.83	400	89	A	V
													V
													V
Remark	1. No other spurious found. 2. All results are PASS against Peak and Average limit line.												



2.4GHz 2400~2483.5MHz
BLE (Harmonic @ 3m)

BLE	Note	Frequency (MHz)	Level (dBµV/m)	Over Limit (dB)	Limit Line (dBµV/m)	Read Level (dBµV)	Antenna Factor (dB/m)	Path Loss (dB)	Preamp Factor (dB)	Ant Pos (cm)	Table Pos (deg)	Peak Avg. (P/A)	Pol. (H/V)	
BLE CH 00 2402MHz		4804	40.11	-33.89	74	55.68	31.11	12.4	59.08	100	0	P	H	
													H	
													H	
													H	
			4804	40.45	-33.55	74	56.02	31.11	12.4	59.08	100	0	P	V
														V
														V
BLE CH 19 2440MHz		4880	39.77	-34.23	74	55.34	31.08	12.48	59.13	100	0	P	H	
		7320	46.87	-27.13	74	53.26	36.48	15.68	58.55	100	0	P	H	
													H	
													H	
			4880	39.52	-34.48	74	55.09	31.08	12.48	59.13	100	0	P	V
			7320	46.56	-27.44	74	52.95	36.48	15.68	58.55	100	0	P	V
														V
BLE CH 39 2480MHz		4960	38.97	-35.03	74	54.33	31.26	12.56	59.18	100	0	P	H	
		7440	45.78	-28.22	74	51.8	36.58	15.78	58.38	100	0	P	H	
													H	
													H	
			4960	39.56	-34.44	74	54.92	31.26	12.56	59.18	100	0	P	V
			7440	46.3	-27.7	74	52.32	36.58	15.78	58.38	100	0	P	V
														V
Remark	1. No other spurious found.													
	2. All results are PASS against Peak and Average limit line.													



Emission above 18GHz

2.4GHz BLE (SHF)

BLE	Note	Frequency	Level	Over	Limit	Read	Antenna	Path	Preamp	Ant	Table	Peak	Pol.
		(MHz)	(dBμV/m)	(dB)	(dBμV/m)	(dBμV)	(dB/m)	(dB)	(dB)	(cm)	(deg)	(P/A)	(H/V)
2.4GHz BLE SHF		23467	41.75	-32.25	74	42.41	39.62	13.04	53.32	150	0	P	H
													H
													H
													H
													H
													H
													H
													H
													H
													H
													H
													H
													H
													H
													H
													H
													H
													H
													H
			23859	41.03	-32.97	74	41.13	40.2	13	53.3	150	0	P
													V
													V
													V
													V
													V
													V
													V
													V
													V
													V
													V
													V
													V
Remark	1. No other spurious found. 2. All results are PASS against limit line.												



Emission below 1GHz

2.4GHz BLE (LF)

BLE	Note	Frequency	Level	Over	Limit	Read	Antenna	Path	Preamp	Ant	Table	Peak	Pol.	
		(MHz)	(dBμV/m)	(dB)	(dBμV/m)	(dBμV)	(dB/m)	(dB)	(dB)	(cm)	(deg)	(P/A)	(H/V)	
2.4GHz BLE LF		78.5	26.35	-13.65	40	44.12	13.08	1.48	32.33	-	-	P	H	
		92.08	32.75	-10.75	43.5	48.54	14.86	1.63	32.28	100	0	P	H	
		151.25	32.08	-11.42	43.5	45.22	16.98	2.17	32.29	-	-	P	H	
		191.02	26.33	-17.17	43.5	41.55	14.7	2.39	32.31	-	-	P	H	
		557.68	27.61	-18.39	46	29.51	26.05	4.04	31.99	-	-	P	H	
		946.65	33.8	-12.2	46	29.28	30.59	5.3	31.37	-	-	P	H	
														H
														H
														H
														H
														H
														H
			52.31	31.64	-8.36	40	49.71	13.13	1.22	32.42	100	0	P	V
			89.17	33.8	-9.7	43.5	50.07	14.42	1.6	32.29	-	-	P	V
			149.31	28.34	-15.16	43.5	41.41	17.05	2.16	32.28	-	-	P	V
			178.41	27.7	-15.8	43.5	42.7	14.97	2.33	32.3	-	-	P	V
			733.25	31.69	-14.31	46	31.51	27.75	4.65	32.22	-	-	P	V
			949.56	34.69	-11.31	46	30.02	30.7	5.31	31.34	-	-	P	V
														V
														V
													V	
													V	
													V	
													V	
Remark	1. No other spurious found. 2. All results are PASS against limit line.													



<NRF52810>

<1Mbps>

2.4GHz 2400~2483.5MHz

BLE (Band Edge @ 3m)

BLE	Note	Frequency	Level	Over	Limit	Read	Antenna	Path	Preamp	Ant	Table	Peak	Pol.	
		(MHz)	(dBµV/m)	(dB)	Line (dBµV/m)	Level (dBµV)	Factor (dB/m)	Loss (dB)	Factor (dB)	Pos (cm)	Pos (deg)	Avg. (P/A)	(H/V)	
BLE CH 00 2402MHz		2331.315	56.89	-17.11	74	40.78	27.87	18	29.76	140	148	P	H	
		2323.86	47.03	-6.97	54	30.91	27.9	17.98	29.76	140	148	A	H	
	*	2402	98.83	-	-	82.91	27.6	18.11	29.79	140	148	P	H	
	*	2402	98.2	-	-	82.28	27.6	18.11	29.79	140	148	A	H	
													H	
														H
			2314.2	56.86	-17.14	74	40.7	27.94	17.97	29.75	378	78	P	V
			2315.355	47.08	-6.92	54	30.92	27.94	17.97	29.75	378	78	A	V
	*		2402	92.02	-	-	76.1	27.6	18.11	29.79	378	78	P	V
	*		2402	91.37	-	-	75.45	27.6	18.11	29.79	378	78	A	V
														V
													V	
BLE CH 19 2440MHz		2342.48	56.91	-17.09	74	40.82	27.83	18.02	29.76	103	148	P	H	
		2382.94	47.11	-6.89	54	31.14	27.67	18.08	29.78	103	148	A	H	
	*	2440	99.64	-	-	83.67	27.6	18.17	29.8	103	148	P	H	
	*	2440	99.13	-	-	83.16	27.6	18.17	29.8	103	148	A	H	
			2497.2	56.64	-17.36	74	40.69	27.51	18.27	29.83	103	148	P	H
			2490.41	47.29	-6.71	54	31.35	27.52	18.25	29.83	103	148	A	H
			2311.26	57.62	-16.38	74	41.46	27.95	17.96	29.75	364	112	P	V
			2324.28	46.97	-7.03	54	30.84	27.9	17.99	29.76	364	112	A	V
	*		2440	93	-	-	77.03	27.6	18.17	29.8	364	112	P	V
	*		2440	92.47	-	-	76.5	27.6	18.17	29.8	364	112	A	V
		2497.2	56.62	-17.38	74	40.67	27.51	18.27	29.83	364	112	P	V	
		2495.87	46.92	-7.08	54	30.98	27.51	18.26	29.83	364	112	A	V	



BLE CH 39 2480MHz	*	2480	99.6	-	-	83.64	27.54	18.24	29.82	100	145	P	H
	*	2480	99.1	-	-	83.14	27.54	18.24	29.82	100	145	A	H
		2490.64	57.35	-16.65	74	41.4	27.52	18.26	29.83	100	145	P	H
		2490.72	47.28	-6.72	54	31.33	27.52	18.26	29.83	100	145	A	H
													H
													H
	*	2480	93.35	-	-	77.39	27.54	18.24	29.82	399	95	P	V
	*	2480	92.77	-	-	76.81	27.54	18.24	29.82	399	95	A	V
		2485.2	56.51	-17.49	74	40.55	27.53	18.25	29.82	399	95	P	V
		2499.88	47.05	-6.95	54	31.11	27.5	18.27	29.83	399	95	A	V
													V
													V
Remark	1. No other spurious found. 2. All results are PASS against Peak and Average limit line.												



2.4GHz 2400~2483.5MHz
BLE (Harmonic @ 3m)

BLE	Note	Frequency (MHz)	Level (dBμV/m)	Over Limit (dB)	Limit Line (dBμV/m)	Read Level (dBμV)	Antenna Factor (dB/m)	Path Loss (dB)	Preamp Factor (dB)	Ant Pos (cm)	Table Pos (deg)	Peak Avg. (P/A)	Pol. (H/V)	
BLE CH 00 2402MHz		4804	38.92	-35.08	74	54.46	31.11	12.43	59.08	100	0	P	H	
													H	
													H	
													H	
		4804	39.03	-34.97	74	54.57	31.11	12.43	59.08	100	0	P	V	
														V
														V
BLE CH 19 2440MHz		4880	40.23	-33.77	74	55.78	31.08	12.5	59.13	100	0	P	H	
		7320	45.18	-28.82	74	51.65	36.48	15.6	58.55	100	0	P	H	
													H	
													H	
		4880	39.36	-34.64	74	54.91	31.08	12.5	59.13	100	0	P	V	
		7320	45.79	-28.21	74	52.26	36.48	15.6	58.55	100	0	P	V	
														V
BLE CH 39 2480MHz		4960	39.86	-34.14	74	55.22	31.26	12.56	59.18	100	0	P	H	
		7440	46.44	-27.56	74	52.52	36.58	15.72	58.38	100	0	P	H	
													H	
													H	
		4960	39.97	-34.03	74	55.33	31.26	12.56	59.18	100	0	P	V	
		7440	46.69	-27.31	74	52.77	36.58	15.72	58.38	100	0	P	V	
														V
Remark	1. No other spurious found.													
	2. All results are PASS against Peak and Average limit line.													



<2Mbps>

2.4GHz 2400~2483.5MHz

BLE (Band Edge @ 3m)

BLE	Note	Frequency	Level	Over Limit	Limit Line	Read Level	Antenna Factor	Path Loss	Preamp Factor	Ant Pos	Table Pos	Peak Avg.	Pol.	
		(MHz)	(dBµV/m)	(dB)	(dBµV/m)	(dBµV)	(dB/m)	(dB)	(dB)	(cm)	(deg)	(P/A)	(H/V)	
BLE CH 00 2402MHz		2328.375	56.87	-17.13	74	40.75	27.89	17.99	29.76	146	154	P	H	
		2355.15	48.77	-5.23	54	32.72	27.78	18.04	29.77	146	154	A	H	
	*	2402	98.34	-	-	82.42	27.6	18.11	29.79	146	154	P	H	
	*	2402	96.89	-	-	80.97	27.6	18.11	29.79	146	154	A	H	
													H	
														H
			2355.15	56.97	-17.03	74	40.92	27.78	18.04	29.77	377	89	P	V
			2321.34	48.75	-5.25	54	32.61	27.91	17.98	29.75	377	89	A	V
	*		2402	92.45	-	-	76.53	27.6	18.11	29.79	377	89	P	V
	*		2402	91.1	-	-	75.18	27.6	18.11	29.79	377	89	A	V
														V
														V
BLE CH 19 2440MHz		2371.74	57.09	-16.91	74	41.1	27.71	18.06	29.78	134	152	P	H	
		2318.68	49.06	-4.94	54	32.9	27.93	17.98	29.75	134	152	A	H	
	*	2440	99.25	-	-	83.28	27.6	18.17	29.8	134	152	P	H	
	*	2440	97.89	-	-	81.92	27.6	18.17	29.8	134	152	A	H	
			2498.32	56.7	-17.3	74	40.76	27.5	18.27	29.83	134	152	P	H
			2495.38	48.66	-5.34	54	32.72	27.51	18.26	29.83	134	152	A	H
			2360.68	56.81	-17.19	74	40.77	27.76	18.05	29.77	359	123	P	V
			2366.28	49.11	-4.89	54	33.1	27.73	18.05	29.77	359	123	A	V
	*		2440	93.03	-	-	77.06	27.6	18.17	29.8	359	123	P	V
	*		2440	91.77	-	-	75.8	27.6	18.17	29.8	359	123	A	V
			2492.44	57.8	-16.2	74	41.85	27.52	18.26	29.83	359	123	P	V
			2486.42	49.16	-4.84	54	33.2	27.53	18.25	29.82	359	123	A	V



BLE CH 39 2480MHz	*	2480	100.24	-	-	84.28	27.54	18.24	29.82	101	148	P	H
	*	2480	98.89	-	-	82.93	27.54	18.24	29.82	101	148	A	H
		2490.28	56.37	-17.63	74	40.43	27.52	18.25	29.83	101	148	P	H
		2487.6	48.84	-5.16	54	32.89	27.52	18.25	29.82	101	148	A	H
													H
													H
	*	2480	94.03	-	-	78.07	27.54	18.24	29.82	393	88	P	V
	*	2480	92.47	-	-	76.51	27.54	18.24	29.82	393	88	A	V
		2497.16	57.45	-16.55	74	41.5	27.51	18.27	29.83	393	88	P	V
		2488.36	49.18	-4.82	54	33.24	27.52	18.25	29.83	393	88	A	V
													V
													V
Remark	1. No other spurious found. 2. All results are PASS against Peak and Average limit line.												



2.4GHz 2400~2483.5MHz
BLE (Harmonic @ 3m)

BLE	Note	Frequency (MHz)	Level (dBµV/m)	Over Limit (dB)	Limit Line (dBµV/m)	Read Level (dBµV)	Antenna Factor (dB/m)	Path Loss (dB)	Preamp Factor (dB)	Ant Pos (cm)	Table Pos (deg)	Peak Avg. (P/A)	Pol. (H/V)
BLE CH 00 2402MHz		4804	39.08	-34.92	74	54.62	31.11	12.43	59.08	100	0	P	H
													H
													H
													H
		4804	39.13	-34.87	74	54.67	31.11	12.43	59.08	100	0	P	V
													V
													V
BLE CH 19 2440MHz		4880	39.03	-34.97	74	54.58	31.08	12.5	59.13	100	0	P	H
		7320	45.4	-28.6	74	51.87	36.48	15.6	58.55	100	0	P	H
													H
													H
		4880	39.18	-34.82	74	54.73	31.08	12.5	59.13	100	0	P	V
		7320	45.14	-28.86	74	51.61	36.48	15.6	58.55	100	0	P	V
													V
BLE CH 39 2480MHz		4960	39.81	-34.19	74	55.17	31.26	12.56	59.18	100	0	P	H
		7440	46.27	-27.73	74	52.35	36.58	15.72	58.38	100	0	P	H
													H
													H
		4960	40.05	-33.95	74	55.41	31.26	12.56	59.18	100	0	P	V
		7440	46.82	-27.18	74	52.9	36.58	15.72	58.38	100	0	P	V
													V
Remark	1. No other spurious found. 2. All results are PASS against Peak and Average limit line.												



Emission above 18GHz

2.4GHz BLE (SHF)

BLE	Note	Frequency	Level	Over	Limit	Read	Antenna	Path	Preamp	Ant	Table	Peak	Pol.
		(MHz)	(dBμV/m)	(dB)	(dBμV/m)	(dBμV)	(dB/m)	(dB)	(dB)	(cm)	(deg)	(P/A)	(H/V)
2.4GHz BLE SHF		24237	40.83	-33.17	74	40.81	40.26	13.15	53.39	150	0	P	H
													H
													H
													H
													H
													H
													H
													H
													H
													H
													H
													H
													H
													H
													H
													H
													H
													H
													H
			22732	40.44	-33.56	74	42.41	38.61	12.97	53.55	150	0	P
													V
													V
													V
													V
													V
													V
													V
													V
													V
													V
													V
													V
													V
													V
Remark	1. No other spurious found. 2. All results are PASS against limit line.												



Emission below 1GHz

2.4GHz BLE (LF)

BLE	Note	Frequency	Level	Over	Limit	Read	Antenna	Path	Preamp	Ant	Table	Peak	Pol.	
		(MHz)	(dBμV/m)	(dB)	(dBμV/m)	(dBμV)	(dB/m)	(dB)	(dB)	(cm)	(deg)	(P/A)	(H/V)	
2.4GHz BLE LF		77.53	25.58	-14.42	40	43.53	12.91	1.47	32.33	-	-	P	H	
		91.11	31.85	-11.65	43.5	47.79	14.72	1.62	32.28	100	0	P	H	
		148.34	31.25	-12.25	43.5	44.34	17.04	2.15	32.28	-	-	P	H	
		744.89	31.16	-14.84	46	30.62	28.1	4.69	32.25	-	-	P	H	
		863.23	32.09	-13.91	46	30.1	29.03	5.05	32.09	-	-	P	H	
		942.77	33.85	-12.15	46	29.54	30.44	5.29	31.42	-	-	P	H	
														H
														H
														H
														H
														H
														H
			51.34	30.32	-9.68	40	48	13.55	1.2	32.43	100	0	P	V
			90.14	32.39	-11.11	43.5	48.46	14.61	1.61	32.29	-	-	P	V
			151.25	27.78	-15.72	43.5	40.92	16.98	2.17	32.29	-	-	P	V
			178.41	27.01	-16.49	43.5	42.01	14.97	2.33	32.3	-	-	P	V
			729.37	31.69	-14.31	46	31.72	27.54	4.64	32.21	-	-	P	V
			943.74	33.65	-12.35	46	29.28	30.48	5.29	31.4	-	-	P	V
														V
														V
													V	
													V	
													V	
													V	
Remark	1. No other spurious found. 2. All results are PASS against limit line.													



Note symbol

*	Fundamental Frequency which can be ignored. However, the level of any unwanted emissions shall not exceed the level of the fundamental frequency.
!	Test result is over limit line.
P/A	Peak or Average
H/V	Horizontal or Vertical



A calculation example for radiated spurious emission is shown as below:

BLE	Note	Frequency	Level	Over	Limit	Read	Antenna	Path	Preamp	Ant	Table	Peak	Pol.
		(MHz)	(dBμV/m)	(dB)	(dBμV/m)	(dBμV)	(dB/m)	(dB)	(dB)	(cm)	(deg)	(P/A)	(H/V)
BLE CH 00 2402MHz		2390	55.45	-18.55	74	54.51	32.22	4.58	35.86	103	308	P	H
		2390	43.54	-10.46	54	42.6	32.22	4.58	35.86	103	308	A	H

1. Path Loss(dB) = Cable loss(dB) + Filter loss(dB) + Attenuator loss(dB)
2. Level(dBμV/m) =
Antenna Factor(dB/m) + Path Loss(dB) + Read Level(dBμV) - Preamp Factor(dB)
3. Over Limit(dB) = Level(dBμV/m) – Limit Line(dBμV/m)

For Peak Limit @ 2390MHz:

1. Level(dBμV/m)
= Antenna Factor(dB/m) + Path Loss(dB) + Read Level(dBμV) - Preamp Factor(dB)
= 32.22(dB/m) + 4.58(dB) + 54.51(dBμV) – 35.86 (dB)
= 55.45 (dBμV/m)
2. Over Limit(dB)
= Level(dBμV/m) – Limit Line(dBμV/m)
= 55.45(dBμV/m) – 74(dBμV/m)
= -18.55(dB)

For Average Limit @ 2390MHz:

1. Level(dBμV/m)
= Antenna Factor(dB/m) + Path Loss(dB) + Read Level(dBμV) - Preamp Factor(dB)
= 32.22(dB/m) + 4.58(dB) + 42.6(dBμV) – 35.86 (dB)
= 43.54 (dBμV/m)
2. Over Limit(dB)
= Level(dBμV/m) – Limit Line(dBμV/m)
= 43.54(dBμV/m) – 54(dBμV/m)
= -10.46(dB)

Both peak and average measured complies with the limit line, so test result is “PASS”.



Appendix C. Radiated Spurious Emission Plots

Test Engineer :	Andy Yang, Karl Hou and CR Liao	Temperature :	20~25°C
		Relative Humidity :	50~65%

Note symbol

-L	Low channel location
-R	High channel location



<WCN3990>
<1Mbps>

2.4GHz 2400~2483.5MHz
BLE (Band Edge @ 3m)

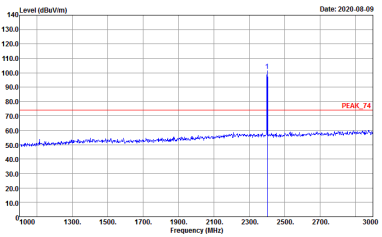
BLE	2.4GHz 2400~2483.5MHz Band Edge @ 3m	
	BLE CH00 2402MHz	
	Horizontal	Fundamental
Peak	 <p>Site : 03CH16-HY Condition : PEAK_BE_74 3m 91200_1522 HORIZONTAL Detector : Peak Project : 070401</p>	 <p>Site : 03CH16-HY Condition : PEAK_74 3m 91200_1522 HORIZONTAL Detector : Peak Project : 070401</p>
Avg.	 <p>Site : 03CH16-HY Condition : AVG_BE_54 3m 91200_1522 HORIZONTAL Detector : Peak Project : 070401</p>	 <p>Site : 03CH16-HY Condition : AVG_54 3m 91200_1522 HORIZONTAL Detector : Peak Project : 070401</p>

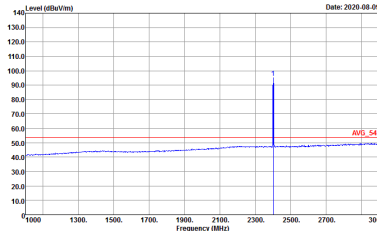

BLE	2.4GHz 2400~2483.5MHz Band Edge @ 3m	
BLE CH00 2402MHz		
	Vertical	Fundamental
Peak	 <p>Site : 03CH16-HY Condition : PEAK_BE_74 3m 91200_1522 VERTICAL Detector : Peak Project : 070401</p>	 <p>Site : 03CH16-HY Condition : PEAK_74 3m 91200_1522 VERTICAL Detector : Peak Project : 070401</p>
Avg	 <p>Site : 03CH16-HY Condition : AVG_BE_54 3m 91200_1522 VERTICAL Detector : Peak Project : 070401</p>	 <p>Site : 03CH16-HY Condition : AVG_54 3m 91200_1522 VERTICAL Detector : Peak Project : 070401</p>

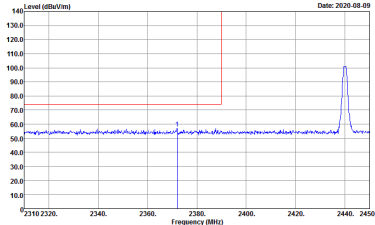
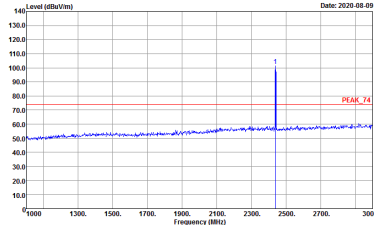
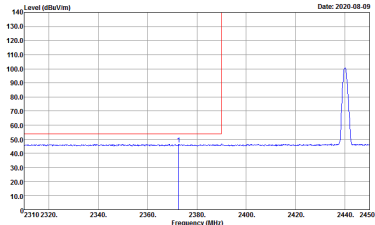
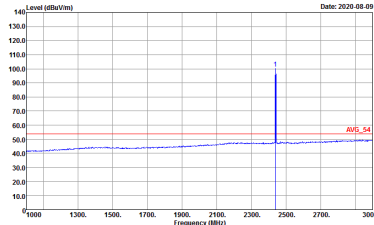

BLE	2.4GHz 2400~2483.5MHz Band Edge @ 3m	
BLE CH19 2440MHz - L		
Horizontal		Fundamental
Peak	 <p>Date: 2020-08-09</p> <p>Site : 03CH16-HY Condition : PEAK_BE_74 3m 91200_1522 HORIZONTAL RBW:1000.000KHz VBW:3000.000KHz SWT:Auto Detector : Peak Project : 070401</p>	 <p>Date: 2020-08-09</p> <p>Site : 03CH16-HY Condition : PEAK_74 3m 91200_1522 HORIZONTAL RBW:1000.000KHz VBW:3000.000KHz SWT:Auto Detector : Peak Project : 070401</p>
Avg.	 <p>Date: 2020-08-09</p> <p>Site : 03CH16-HY Condition : AVG_BE_54 3m 91200_1522 HORIZONTAL RBW:1000.000KHz VBW:3000.000KHz SWT:Auto Detector : Peak Project : 070401</p>	 <p>Date: 2020-08-09</p> <p>Site : 03CH16-HY Condition : AVG_54 3m 91200_1522 HORIZONTAL RBW:1000.000KHz VBW:3000.000KHz SWT:Auto Detector : Peak Project : 070401</p>



BLE	2.4GHz 2400~2483.5MHz Band Edge @ 3m	
	BLE CH19 2440MHz - R	
	Horizontal	Fundamental
Peak	<p>Site : 03CH16-HY Condition : PEAK_BE_74 3m 91200_1522 HORIZONTAL RBW:1000.000KHz VBW:3000.000KHz SWF:Auto Detector : Peak Project : 070401</p>	Left blank
Avg.	<p>Site : 03CH16-HY Condition : AVG_BE_54 3m 91200_1522 HORIZONTAL RBW:1000.000KHz VBW:3.000KHz SWF:Auto Detector : Peak Project : 070401</p>	Left blank



BLE	2.4GHz 2400~2483.5MHz Band Edge @ 3m	
BLE CH19 2440MHz - L		
	Vertical	Fundamental
Peak	 <p>Date: 2020-08-09</p> <p>Site : 03CH16-HY Condition : PEAK_BE_74 3m 91200_1522 VERTICAL RBW:1000.000KHz VBW:3000.000KHz SWT:Auto Detector : Peak Project : 070401</p>	 <p>Date: 2020-08-09</p> <p>Site : 03CH16-HY Condition : PEAK_74 3m 91200_1522 VERTICAL RBW:1000.000KHz VBW:3000.000KHz SWT:Auto Detector : Peak Project : 070401</p>
Avg.	 <p>Date: 2020-08-09</p> <p>Site : 03CH16-HY Condition : AVG_BE_54 3m 91200_1522 VERTICAL RBW:1000.000KHz VBW:3.000KHz SWT:Auto Detector : Peak Project : 070401</p>	 <p>Date: 2020-08-09</p> <p>Site : 03CH16-HY Condition : AVG_54 3m 91200_1522 VERTICAL RBW:1000.000KHz VBW:3.000KHz SWT:Auto Detector : Peak Project : 070401</p>



BLE	2.4GHz 2400~2483.5MHz Band Edge @ 3m	
BLE CH19 2440MHz - R		
	Vertical	Fundamental
<p>Peak</p>	 <p>Site : 03CH16-HY Condition : PEAK_BE_74 3m 91200_1522 VERTICAL : RBW:1000.000KHz VBW:3000.000KHz SWF:Auto Detector : Peak Project : 070401</p>	<p>Left blank</p>
<p>Avg.</p>	 <p>Site : 03CH16-HY Condition : AVG_BE_54 3m 91200_1522 VERTICAL : RBW:1000.000KHz VBW:3.000KHz SWF:Auto Detector : Peak Project : 070401</p>	<p>Left blank</p>



BLE	2.4GHz 2400~2483.5MHz Band Edge @ 3m	
BLE CH39 2480MHz		
	Horizontal	Fundamental
Peak	<p>Date: 2020-08-09</p> <p>Site : 03CH16-HY Condition : PEAK_BE_74 3m 91200_1522 HORIZONTAL RBW:1000.0000kHz VBW:3000.0000kHz SWT:Auto Detector : Peak Project : 070401</p>	<p>Date: 2020-08-09</p> <p>Site : 03CH16-HY Condition : PEAK_74 3m 91200_1522 HORIZONTAL RBW:1000.0000kHz VBW:3000.0000kHz SWT:Auto Detector : Peak Project : 070401</p>
Avg.	<p>Date: 2020-08-09</p> <p>Site : 03CH16-HY Condition : AVG_BE_54 3m 91200_1522 HORIZONTAL RBW:1000.0000kHz VBW:3.0000kHz SWT:Auto Detector : Peak Project : 070401</p>	<p>Date: 2020-08-09</p> <p>Site : 03CH16-HY Condition : AVG_54 3m 91200_1522 HORIZONTAL RBW:1000.0000kHz VBW:3.0000kHz SWT:Auto Detector : Peak Project : 070401</p>



BLE	2.4GHz 2400~2483.5MHz Band Edge @ 3m	
BLE CH39 2480MHz		
	Vertical	Fundamental
Peak	<p>Date: 2020-08-09</p> <p>Site : 03CH16-HY Condition : PEAK_BE_74 3m 91200_1522 VERTICAL RBW:1000.000KHz VBW:3000.000KHz SWT:Auto Detector : Peak Project : 070401</p>	<p>Date: 2020-08-09</p> <p>Site : 03CH16-HY Condition : PEAK_74 3m 91200_1522 VERTICAL RBW:1000.000KHz VBW:3000.000KHz SWT:Auto Detector : Peak Project : 070401</p>
Avg.	<p>Date: 2020-08-09</p> <p>Site : 03CH16-HY Condition : AVG_BE_54 3m 91200_1522 VERTICAL RBW:1000.000KHz VBW:3.000KHz SWT:Auto Detector : Peak Project : 070401</p>	<p>Date: 2020-08-09</p> <p>Site : 03CH16-HY Condition : AVG_54 3m 91200_1522 VERTICAL RBW:1000.000KHz VBW:3.000KHz SWT:Auto Detector : Peak Project : 070401</p>



2.4GHz 2400~2483.5MHz

BLE (Harmonic @ 3m)

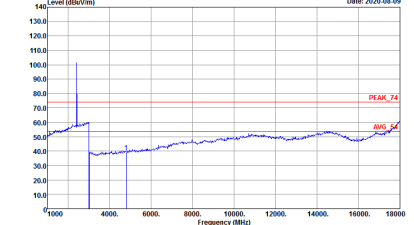
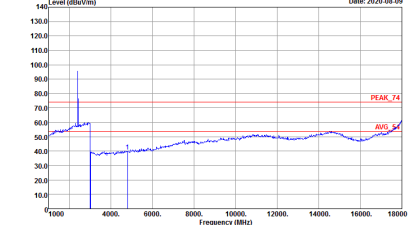
BLE	2.4GHz 2400~2483.5MHz Harmonic @ 3m	
	BLE CH00 2402MHz	
	Horizontal	Vertical
Peak Avg.	 <p>Site : 03CH16-HY Condition : PEAK_74 3m 91200_1522 HORIZONTAL Detector : Peak Project : 070401</p>	 <p>Site : 03CH16-HY Condition : PEAK_74 3m 91200_1522 VERTICAL Detector : Peak Project : 070401</p>



BLE	2.4GHz 2400~2483.5MHz Harmonic @ 3m	
	BLE CH19 2440MHz	
	Horizontal	Vertical
Peak Avg.	<p>Site : 03CH16-HY Condition : PEAK_74 3m 9120D_1522 HORIZONTAL Detector : Peak Project : 070401</p>	<p>Site : 03CH16-HY Condition : PEAK_74 3m 9120D_1522 VERTICAL Detector : Peak Project : 070401</p>



BLE	2.4GHz 2400~2483.5MHz Harmonic @ 3m	
	BLE CH39 2480MHz	
	Horizontal	Vertical
Peak	<p>Site : 03CH16-HY Condition : PEAK_74 3m 9120D_1522 HORIZONTAL Detector : Peak Project : 070401</p>	<p>Site : 03CH16-HY Condition : PEAK_74 3m 9120D_1522 VERTICAL Detector : Peak Project : 070401</p>



<2Mbps>

2.4GHz 2400~2483.5MHz
BLE (Band Edge @ 3m)

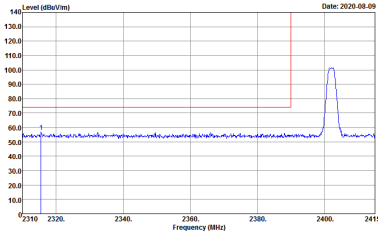
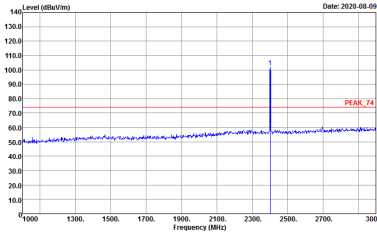
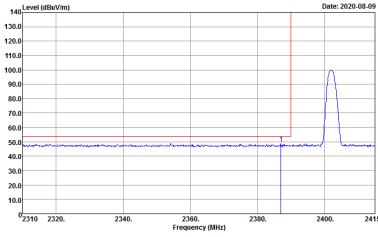
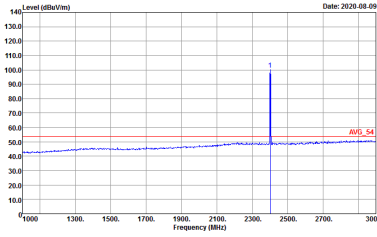
BLE	2.4GHz 2400~2483.5MHz Band Edge @ 3m	
BLE CH00 2402MHz		
Horizontal		Fundamental
Peak	 <p>Site : 03CH16-HY Condition : PEAK_BE_74 3m 91200_1522 HORIZONTAL Detector : Peak Project : 070401</p>	 <p>Site : 03CH16-HY Condition : PEAK_74 3m 91200_1522 HORIZONTAL Detector : Peak Project : 070401</p>
Avg.	 <p>Site : 03CH16-HY Condition : AVG_BE_54 3m 91200_1522 HORIZONTAL Detector : Peak Project : 070401</p>	 <p>Site : 03CH16-HY Condition : AVG_54 3m 91200_1522 HORIZONTAL Detector : Peak Project : 070401</p>

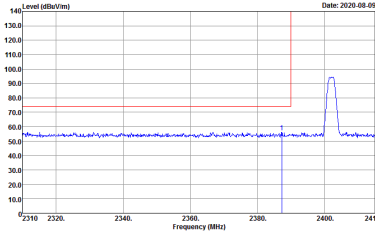
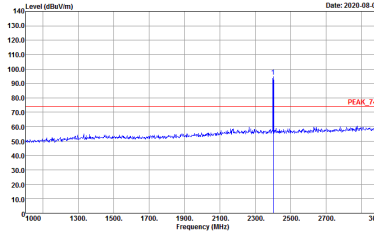
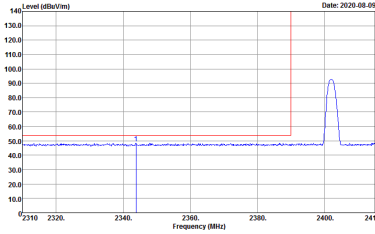
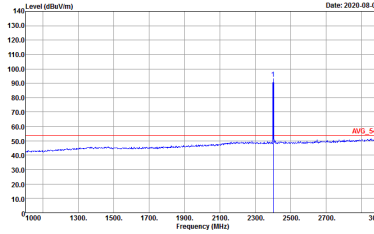

BLE	2.4GHz 2400~2483.5MHz Band Edge @ 3m	
BLE CH00 2402MHz		
	Vertical	Fundamental
Peak	 <p>Site : 03CH16-HY Condition : PEAK_BE_74 3m 91200_1522 VERTICAL RBW:1000.000KHz VBW:3000.000KHz SWT:Auto Detector : Peak Project : 070401</p>	 <p>Site : 03CH16-HY Condition : PEAK_74 3m 91200_1522 VERTICAL RBW:1000.000KHz VBW:3000.000KHz SWT:Auto Detector : Peak Project : 070401</p>
Avg	 <p>Site : 03CH16-HY Condition : AVG_BE_54 3m 91200_1522 VERTICAL RBW:1000.000KHz VBW:10.000KHz SWT:Auto Detector : Peak Project : 070401</p>	 <p>Site : 03CH16-HY Condition : AVG_54 3m 91200_1522 VERTICAL RBW:1000.000KHz VBW:10.000KHz SWT:Auto Detector : Peak Project : 070401</p>

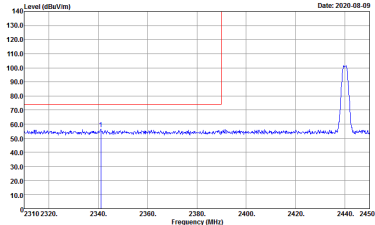
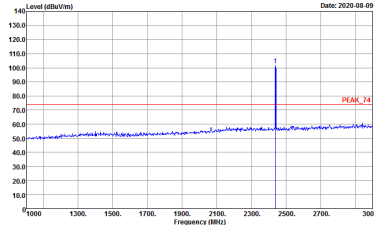
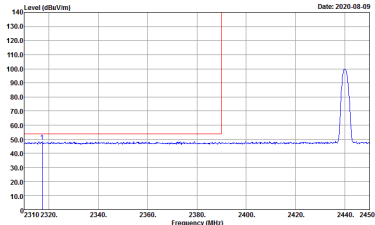
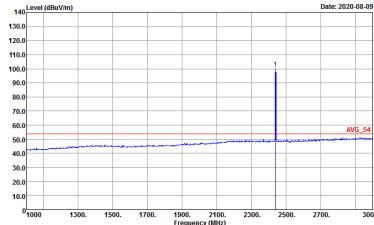

BLE	2.4GHz 2400~2483.5MHz Band Edge @ 3m	
BLE CH19 2440MHz - L		
Horizontal		Fundamental
Peak	 <p>Date: 2020-08-09</p> <p>Site : 03CH16-HV Condition : PEAK_BE_74 3m 91200_1522 HORIZONTAL RBW:1000.000KHz VBW:3000.000KHz SWT:Auto Detector : Peak Project : 070401</p>	 <p>Date: 2020-08-09</p> <p>Site : 03CH16-HV Condition : PEAK_74 3m 91200_1522 HORIZONTAL RBW:1000.000KHz VBW:3000.000KHz SWT:Auto Detector : Peak Project : 070401</p>
Avg.	 <p>Date: 2020-08-09</p> <p>Site : 03CH16-HV Condition : AVG_BE_54 3m 91200_1522 HORIZONTAL RBW:1000.000KHz VBW:10.000KHz SWT:Auto Detector : Peak Project : 070401</p>	 <p>Date: 2020-08-09</p> <p>Site : 03CH16-HV Condition : AVG_54 3m 91200_1522 HORIZONTAL RBW:1000.000KHz VBW:10.000KHz SWT:Auto Detector : Peak Project : 070401</p>

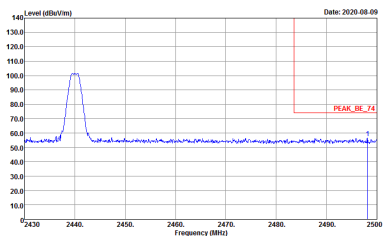
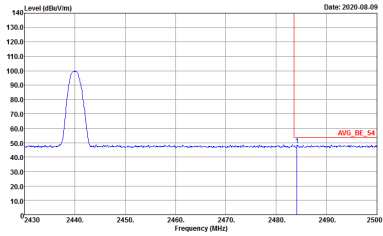

BLE	2.4GHz 2400~2483.5MHz Band Edge @ 3m	
BLE CH19 2440MHz - R		
	Horizontal	Fundamental
<p>Peak</p>	 <p>Site : 03CH16-HY Condition : PEAK_BE_74 3m 91200_1522 HORIZONTAL : RBW:1000.0000kHz VBW:3000.0000kHz SWT:Auto Detector : Peak Project : 070401</p>	<p>Left blank</p>
<p>Avg.</p>	 <p>Site : 03CH16-HY Condition : AVG_BE_54 3m 91200_1522 HORIZONTAL : RBW:1000.0000kHz VBW:10.0000kHz SWT:Auto Detector : Peak Project : 070401</p>	<p>Left blank</p>



BLE	2.4GHz 2400~2483.5MHz Band Edge @ 3m	
BLE CH19 2440MHz - L		
	Vertical	Fundamental
Peak	 <p>Level (dBu/m) vs Frequency (MHz) plot showing a peak at 2440 MHz. The y-axis ranges from 10.0 to 140.0 dBu/m, and the x-axis ranges from 2310 to 2450 MHz. A red line indicates the peak level at approximately 95 dBu/m.</p> <p>Date: 2020-08-09</p> <p>Site : 03CH16-HY Condition : PEAK_BE_74 3m 91200_1522 VERTICAL RBW:1000.000KHz VBW:3000.000KHz SWT:Auto Detector : Peak Project : 070401</p>	 <p>Level (dBu/m) vs Frequency (MHz) plot showing a peak at 2440 MHz. The y-axis ranges from 10.0 to 140.0 dBu/m, and the x-axis ranges from 1000 to 3000 MHz. A red line indicates the peak level at approximately 75 dBu/m.</p> <p>Date: 2020-08-09</p> <p>Site : 03CH16-HY Condition : PEAK_74 3m 91200_1522 VERTICAL RBW:1000.000KHz VBW:3000.000KHz SWT:Auto Detector : Peak Project : 070401</p>
Avg.	 <p>Level (dBu/m) vs Frequency (MHz) plot showing an average level at 2440 MHz. The y-axis ranges from 10.0 to 140.0 dBu/m, and the x-axis ranges from 2310 to 2450 MHz. A red line indicates the average level at approximately 50 dBu/m.</p> <p>Date: 2020-08-09</p> <p>Site : 03CH16-HY Condition : AVG_BE_54 3m 91200_1522 VERTICAL RBW:1000.000KHz VBW:10.000KHz SWT:Auto Detector : Peak Project : 070401</p>	 <p>Level (dBu/m) vs Frequency (MHz) plot showing an average level at 2440 MHz. The y-axis ranges from 10.0 to 140.0 dBu/m, and the x-axis ranges from 1000 to 3000 MHz. A red line indicates the average level at approximately 50 dBu/m.</p> <p>Date: 2020-08-09</p> <p>Site : 03CH16-HY Condition : AVG_54 3m 91200_1522 VERTICAL RBW:1000.000KHz VBW:10.000KHz SWT:Auto Detector : Peak Project : 070401</p>

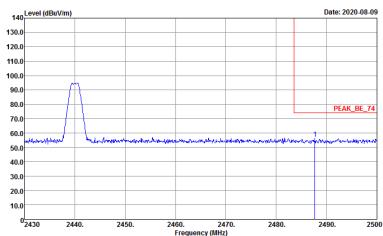
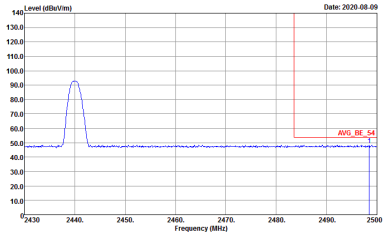

BLE	2.4GHz 2400~2483.5MHz Band Edge @ 3m	
BLE CH19 2440MHz - R		
	Vertical	Fundamental
<p>Peak</p>	 <p>Site : 03CH16-HY Condition : PEAK_BE_74 3m 91200_1522 VERTICAL : RBW:1000.0000kHz VBW:3000.0000kHz SWT:Auto Detector : Peak Project : 070401</p>	<p>Left blank</p>
<p>Avg.</p>	 <p>Site : 03CH16-HY Condition : AVG_BE_54 3m 91200_1522 VERTICAL : RBW:1000.0000kHz VBW:10.0000kHz SWT:Auto Detector : Peak Project : 070401</p>	<p>Left blank</p>



BLE	2.4GHz 2400~2483.5MHz Band Edge @ 3m	
BLE CH39 2480MHz		
	Horizontal	Fundamental
Peak	<p>Date: 2020-08-09</p> <p>Site : 03CH16-HY Condition : PEAK_BE_74 3m 91200_1522 HORIZONTAL RBW:1000.0000kHz VBW:3000.0000kHz SWT:Auto Detector : Peak Project : 070401</p>	<p>Date: 2020-08-09</p> <p>Site : 03CH16-HY Condition : PEAK_74 3m 91200_1522 HORIZONTAL RBW:1000.0000kHz VBW:3000.0000kHz SWT:Auto Detector : Peak Project : 070401</p>
Avg.	<p>Date: 2020-08-09</p> <p>Site : 03CH16-HY Condition : AVG_BE_54 3m 91200_1522 HORIZONTAL RBW:1000.0000kHz VBW:10.0000kHz SWT:Auto Detector : Peak Project : 070401</p>	<p>Date: 2020-08-09</p> <p>Site : 03CH16-HY Condition : AVG_54 3m 91200_1522 HORIZONTAL RBW:1000.0000kHz VBW:10.0000kHz SWT:Auto Detector : Peak Project : 070401</p>



BLE	2.4GHz 2400~2483.5MHz Band Edge @ 3m	
BLE CH39 2480MHz		
	Vertical	Fundamental
Peak	<p>Date: 2020-08-09</p> <p>Site : 03CH16-HY Condition : PEAK_BE_74 3m 91200_1522 VERTICAL RBW:1000.0000kHz VBW:3000.0000kHz SWT:Auto Detector : Peak Project : 070401</p>	<p>Date: 2020-08-09</p> <p>Site : 03CH16-HY Condition : PEAK_74 3m 91200_1522 VERTICAL RBW:1000.0000kHz VBW:3000.0000kHz SWT:Auto Detector : Peak Project : 070401</p>
Avg.	<p>Date: 2020-08-09</p> <p>Site : 03CH16-HY Condition : AVG_BE_54 3m 91200_1522 VERTICAL RBW:1000.0000kHz VBW:10.0000kHz SWT:Auto Detector : Peak Project : 070401</p>	<p>Date: 2020-08-09</p> <p>Site : 03CH16-HY Condition : AVG_54 3m 91200_1522 VERTICAL RBW:1000.0000kHz VBW:10.0000kHz SWT:Auto Detector : Peak Project : 070401</p>



2.4GHz 2400~2483.5MHz

BLE (Harmonic @ 3m)

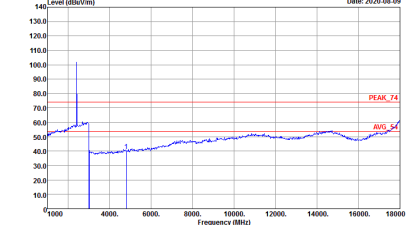
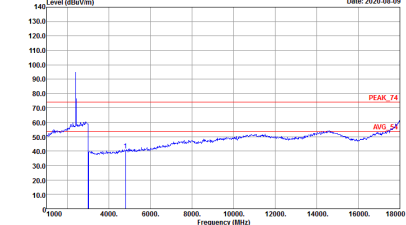
BLE	2.4GHz 2400~2483.5MHz Harmonic @ 3m	
	BLE CH00 2402MHz	
	Horizontal	Vertical
Peak Avg.	 <p>Site : 03CH16-HY Condition : PEAK_74 3m 91200_1522 HORIZONTAL Detector : Peak Project : 070401</p>	 <p>Site : 03CH16-HY Condition : PEAK_74 3m 91200_1522 VERTICAL Detector : Peak Project : 070401</p>



BLE	2.4GHz 2400~2483.5MHz Harmonic @ 3m	
	BLE CH19 2440MHz	
	Horizontal	Vertical
Peak Avg.	<p>Site : 03CH16-HY Condition : PEAK_74 3m 9120D_1522 HORIZONTAL Detector : Peak Project : 070401</p>	<p>Site : 03CH16-HY Condition : PEAK_74 3m 9120D_1522 VERTICAL Detector : Peak Project : 070401</p>



BLE	2.4GHz 2400~2483.5MHz Harmonic @ 3m	
	BLE CH39 2480MHz	
	Horizontal	Vertical
Peak	<p>Site : 03CH16-HY Condition : PEAK_74 3m 9120D_1522 HORIZONTAL Detector : Peak Project : 070401</p>	<p>Site : 03CH16-HY Condition : PEAK_74 3m 9120D_1522 VERTICAL Detector : Peak Project : 070401</p>



Emission above 18GHz

2.4GHz BLE (SHF)

BLE	2.4GHz 2400~2483.5MHz	
	BLE SHF	
	Horizontal	Vertical
QP / Peak	<p>Site : 03C115-1Y Condition : PEAK_74 1m SHF HORN BBH49170584 VERTICAL Detector : Peak Project : 070401</p>	<p>Site : 03C115-1Y Condition : PEAK_74 1m SHF HORN BBH49170584 VERTICAL Detector : Peak Project : 070401</p>



Emission below 1GHz
2.4GHz BLE (LF)

Table with 2 columns: Horizontal and Vertical. Each column contains a graph of Level (dBuV/m) vs Frequency (MHz) and associated test parameters like Site, Condition, Detector, and Project.

QP / Peak



<NRF52810>
<1Mbps>

2.4GHz 2400~2483.5MHz
BLE (Band Edge @ 3m)

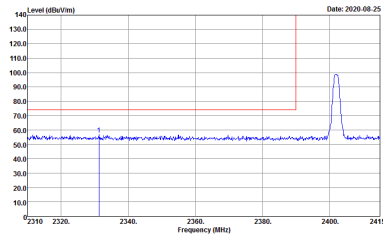
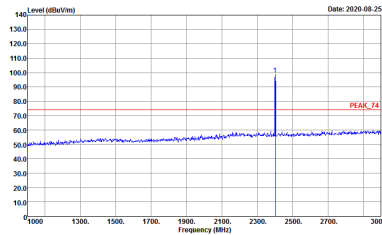
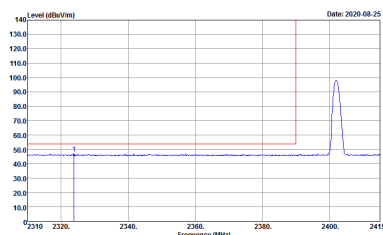
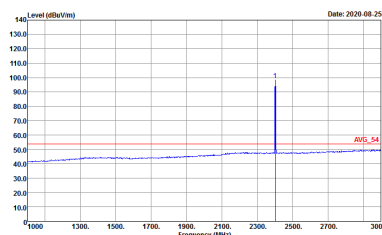
BLE	2.4GHz 2400~2483.5MHz Band Edge @ 3m	
	BLE CH00 2402MHz	
	Horizontal	Fundamental
Peak	 <p>Site : 03CH16-HY Condition : PEAK_BE_74 3m 91200_1522 HORIZONTAL Detector : Peak Project : 070401</p>	 <p>Site : 03CH16-HY Condition : PEAK_74 3m 91200_1522 HORIZONTAL Detector : Peak Project : 070401</p>
Avg.	 <p>Site : 03CH16-HY Condition : AVG_BE_54 3m 91200_1522 HORIZONTAL Detector : Peak Project : 070401</p>	 <p>Site : 03CH16-HY Condition : AVG_54 3m 91200_1522 HORIZONTAL Detector : Peak Project : 070401</p>



BLE	2.4GHz 2400~2483.5MHz Band Edge @ 3m	
BLE CH00 2402MHz		
	Vertical	Fundamental
Peak	 <p>Date: 2020-08-25</p> <p>Site : 03CH16-HY Condition : PEAK_BE_74 3m 91200_1522 VERTICAL RBW:1000.000KHz VBW:3000.000KHz SWT:Auto Detector : Peak Project : 070401</p>	 <p>Date: 2020-08-25</p> <p>Site : 03CH16-HY Condition : PEAK_74 3m 91200_1522 VERTICAL RBW:1000.000KHz VBW:3000.000KHz SWT:Auto Detector : Peak Project : 070401</p>
Avg	 <p>Date: 2020-08-25</p> <p>Site : 03CH16-HY Condition : AVG_BE_54 3m 91200_1522 VERTICAL RBW:1000.000KHz VBW:3.000KHz SWT:Auto Detector : Peak Project : 070401</p>	 <p>Date: 2020-08-25</p> <p>Site : 03CH16-HY Condition : AVG_54 3m 91200_1522 VERTICAL RBW:1000.000KHz VBW:3.000KHz SWT:Auto Detector : Peak Project : 070401</p>

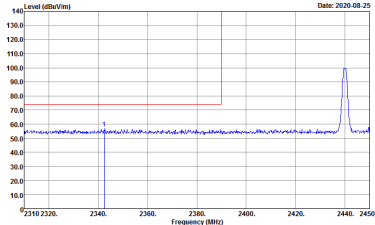
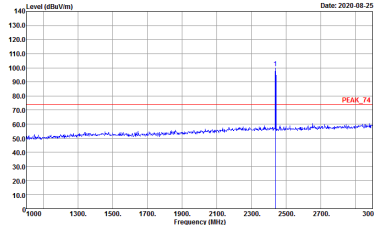
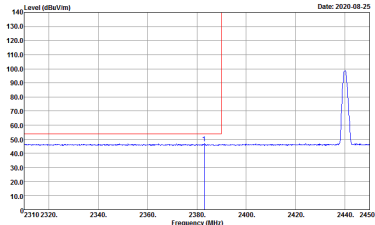
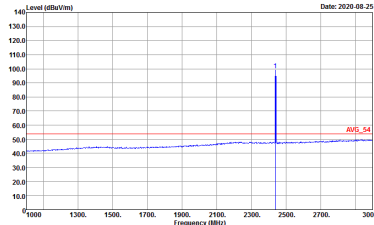

BLE	2.4GHz 2400~2483.5MHz Band Edge @ 3m	
BLE CH19 2440MHz - L		
Horizontal		Fundamental
Peak	 <p>Date: 2020-08-25</p> <p>Site : 03CH16-HY Condition : PEAK_BE_74 3m 91200_1522 HORIZONTAL RBW:1000.000KHz VBW:3000.000KHz SWT:Auto Detector : Peak Project : 070401</p>	 <p>Date: 2020-08-25</p> <p>Site : 03CH16-HY Condition : PEAK_BE_74 3m 91200_1522 HORIZONTAL RBW:1000.000KHz VBW:3000.000KHz SWT:Auto Detector : Peak Project : 070401</p>
Avg.	 <p>Date: 2020-08-25</p> <p>Site : 03CH16-HY Condition : AVG_BE_54 3m 91200_1522 HORIZONTAL RBW:1000.000KHz VBW:3000.000KHz SWT:Auto Detector : Peak Project : 070401</p>	 <p>Date: 2020-08-25</p> <p>Site : 03CH16-HY Condition : AVG_BE_54 3m 91200_1522 HORIZONTAL RBW:1000.000KHz VBW:3000.000KHz SWT:Auto Detector : Peak Project : 070401</p>

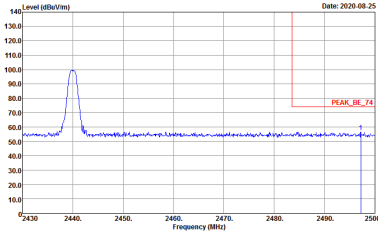
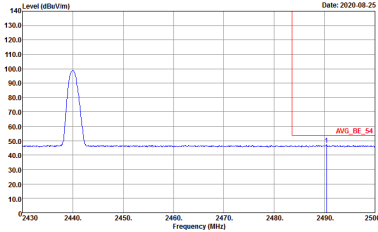

BLE	2.4GHz 2400~2483.5MHz Band Edge @ 3m	
BLE CH19 2440MHz - R		
	Horizontal	Fundamental
<p>Peak</p>	 <p>Site : 03CH16-HY Condition : PEAK_BE_74 3m 91200_1522 HORIZONTAL RBW:1000.000KHz VBW:3000.000KHz SWF:Auto Detector : Peak Project : 070401</p>	<p>Left blank</p>
<p>Avg.</p>	 <p>Site : 03CH16-HY Condition : AVG_BE_54 3m 91200_1522 HORIZONTAL RBW:1000.000KHz VBW:3.000KHz SWF:Auto Detector : Peak Project : 070401</p>	<p>Left blank</p>



BLE	2.4GHz 2400~2483.5MHz Band Edge @ 3m	
BLE CH19 2440MHz - L		
	Vertical	Fundamental
Peak	<p>Date: 2020-08-25</p> <p>Site : 03CH16-HY Condition : PEAK_BE_74 3m 91200_1522 VERTICAL RBW:1000.000KHz VBW:3000.000KHz SWT:Auto Detector : Peak Project : 070401</p>	<p>Date: 2020-08-25</p> <p>Site : 03CH16-HY Condition : PEAK_74 3m 91200_1522 VERTICAL RBW:1000.000KHz VBW:3000.000KHz SWT:Auto Detector : Peak Project : 070401</p>
Avg.	<p>Date: 2020-08-25</p> <p>Site : 03CH16-HY Condition : AVG_BE_54 3m 91200_1522 VERTICAL RBW:1000.000KHz VBW:3.000KHz SWT:Auto Detector : Peak Project : 070401</p>	<p>Date: 2020-08-25</p> <p>Site : 03CH16-HY Condition : AVG_54 3m 91200_1522 VERTICAL RBW:1000.000KHz VBW:3.000KHz SWT:Auto Detector : Peak Project : 070401</p>

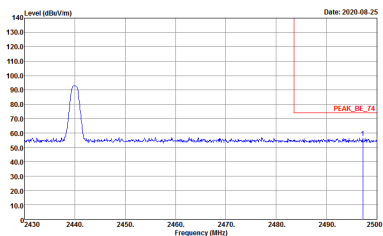
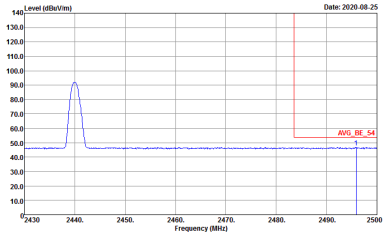

BLE	2.4GHz 2400~2483.5MHz Band Edge @ 3m	
BLE CH19 2440MHz - R		
	Vertical	Fundamental
<p>Peak</p>	 <p>Site : 03CH16-HY Condition : PEAK_BE_74 3m 91200_1522 VERTICAL : RBW:1000.000KHz VBW:3000.000KHz SWF:Auto Detector : Peak Project : 070401</p>	<p>Left blank</p>
<p>Avg.</p>	 <p>Site : 03CH16-HY Condition : AVG_BE_54 3m 91200_1522 VERTICAL : RBW:1000.000KHz VBW:3.000KHz SWF:Auto Detector : Peak Project : 070401</p>	<p>Left blank</p>



BLE	2.4GHz 2400~2483.5MHz Band Edge @ 3m	
BLE CH39 2480MHz		
	Horizontal	Fundamental
Peak	<p>Date: 2020-08-25</p> <p>Site : 03CH16-HY Condition : PEAK_BE_74 3m 91200_1522 HORIZONTAL RBW:1000.0000kHz VBW:3000.0000kHz SWT:Auto Detector : Peak Project : 070401</p>	<p>Date: 2020-08-25</p> <p>Site : 03CH16-HY Condition : PEAK_74 3m 91200_1522 HORIZONTAL RBW:1000.0000kHz VBW:3000.0000kHz SWT:Auto Detector : Peak Project : 070401</p>
Avg.	<p>Date: 2020-08-25</p> <p>Site : 03CH16-HY Condition : AVG_BE_54 3m 91200_1522 HORIZONTAL RBW:1000.0000kHz VBW:3.0000kHz SWT:Auto Detector : Peak Project : 070401</p>	<p>Date: 2020-08-25</p> <p>Site : 03CH16-HY Condition : AVG_54 3m 91200_1522 HORIZONTAL RBW:1000.0000kHz VBW:3.0000kHz SWT:Auto Detector : Peak Project : 070401</p>



BLE	2.4GHz 2400~2483.5MHz Band Edge @ 3m	
BLE CH39 2480MHz		
	Vertical	Fundamental
Peak	 <p>Site : 03CH16-HY Condition : PEAK_BE_74 3m 91200_1522 VERTICAL Detector : Peak Project : 070401</p>	 <p>Site : 03CH16-HY Condition : PEAK_74 3m 91200_1522 VERTICAL Detector : Peak Project : 070401</p>
Avg.	 <p>Site : 03CH16-HY Condition : AVG_BE_54 3m 91200_1522 VERTICAL Detector : Peak Project : 070401</p>	 <p>Site : 03CH16-HY Condition : AVG_54 3m 91200_1522 VERTICAL Detector : Peak Project : 070401</p>



2.4GHz 2400~2483.5MHz

BLE (Harmonic @ 3m)

BLE	2.4GHz 2400~2483.5MHz Harmonic @ 3m	
	BLE CH00 2402MHz	
	Horizontal	Vertical
Peak Avg.	<p>Site : 03CH16-HY Condition : PEAK_74 3m 91200_1522 HORIZONTAL Detector : Peak Project : 070401</p>	<p>Site : 03CH16-HY Condition : PEAK_74 3m 91200_1522 VERTICAL Detector : Peak Project : 070401</p>



BLE	2.4GHz 2400~2483.5MHz Harmonic @ 3m	
	BLE CH19 2440MHz	
	Horizontal	Vertical
Peak Avg.	<p>Site : 03CH16-HY Condition : PEAK_74 3m 9120D_1522 HORIZONTAL Detector : Peak Project : 070401</p>	<p>Site : 03CH16-HY Condition : PEAK_74 3m 9120D_1522 VERTICAL Detector : Peak Project : 070401</p>

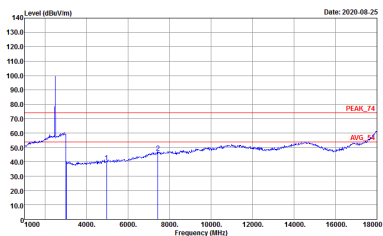
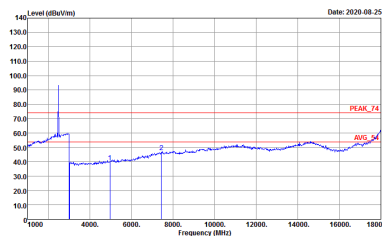

BLE	2.4GHz 2400~2483.5MHz Harmonic @ 3m	
BLE CH39 2480MHz		
	Horizontal	Vertical
Peak	 <p>Site : 03CH16-HY Condition : PEAK_74 3m 9120D_1522 HORIZONTAL Detector : Peak Project : 070401</p>	 <p>Site : 03CH16-HY Condition : PEAK_74 3m 9120D_1522 VERTICAL Detector : Peak Project : 070401</p>



<2Mbps>

2.4GHz 2400~2483.5MHz
BLE (Band Edge @ 3m)

BLE	2.4GHz 2400~2483.5MHz Band Edge @ 3m	
BLE CH00 2402MHz		
Horizontal		Fundamental
Peak	 <p>Site : 03CH16-IY Condition : PEAK_BE_74 3m 91200_1522 HORIZONTAL Detector : Peak Project : 070401</p>	 <p>Site : 03CH16-IY Condition : PEAK_74 3m 91200_1522 HORIZONTAL Detector : Peak Project : 070401</p>
Avg.	 <p>Site : 03CH16-IY Condition : AVG_BE_54 3m 91200_1522 HORIZONTAL Detector : Peak Project : 070401</p>	 <p>Site : 03CH16-IY Condition : AVG_54 3m 91200_1522 HORIZONTAL Detector : Peak Project : 070401</p>



BLE	2.4GHz 2400~2483.5MHz Band Edge @ 3m	
BLE CH00 2402MHz		
	Vertical	Fundamental
Peak	<p>Site : 03CH16-HY Condition : PEAK_BE_74 3m 91200_1522 VERTICAL Detector : Peak Project : 070401</p>	<p>Site : 03CH16-HY Condition : PEAK_74 3m 91200_1522 VERTICAL Detector : Peak Project : 070401</p>
Avg	<p>Site : 03CH16-HY Condition : AVG_BE_54 3m 91200_1522 VERTICAL Detector : Peak Project : 070401</p>	<p>Site : 03CH16-HY Condition : AVG_54 3m 91200_1522 VERTICAL Detector : Peak Project : 070401</p>

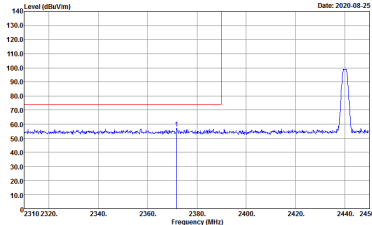
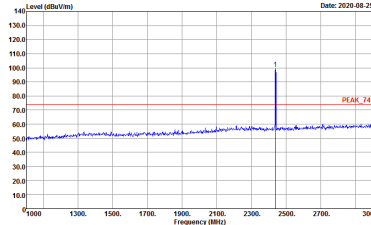
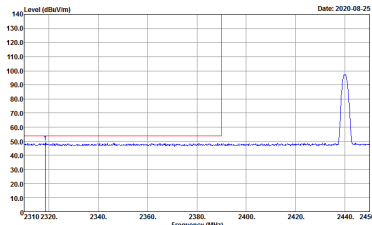
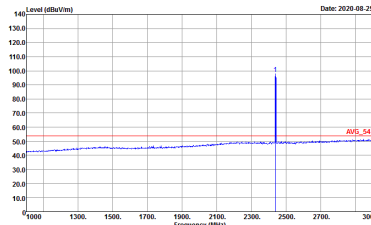

BLE	2.4GHz 2400~2483.5MHz Band Edge @ 3m	
BLE CH19 2440MHz - L		
Horizontal		Fundamental
Peak	 <p>Date: 2020-08-25</p> <p>Site : 03CH16-HY Condition : PEAK_BE_74 3m 91200_1522 HORIZONTAL RBW:1000.000KHz VBW:3000.000KHz SWT:Auto Detector : Peak Project : 070401</p>	 <p>Date: 2020-08-25</p> <p>Site : 03CH16-HY Condition : PEAK_BE_74 3m 91200_1522 HORIZONTAL RBW:1000.000KHz VBW:3000.000KHz SWT:Auto Detector : Peak Project : 070401</p>
Avg.	 <p>Date: 2020-08-25</p> <p>Site : 03CH16-HY Condition : AVG_BE_54 3m 91200_1522 HORIZONTAL RBW:1000.000KHz VBW:10.000KHz SWT:Auto Detector : Peak Project : 070401</p>	 <p>Date: 2020-08-25</p> <p>Site : 03CH16-HY Condition : AVG_BE_54 3m 91200_1522 HORIZONTAL RBW:1000.000KHz VBW:10.000KHz SWT:Auto Detector : Peak Project : 070401</p>

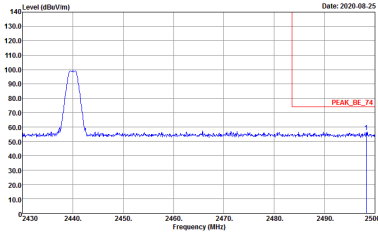
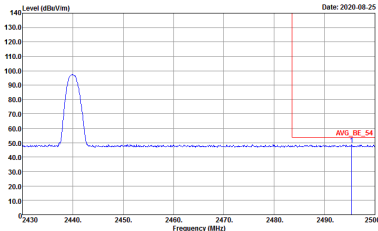

BLE	2.4GHz 2400~2483.5MHz Band Edge @ 3m	
BLE CH19 2440MHz - R		
	Horizontal	Fundamental
<p>Peak</p>	 <p>Date: 2020-08-25</p> <p>Site : 03CH16-HY Condition : PEAK_BE_74 3m 91200_1522 HORIZONTAL : RBW:1000.0000kHz VBW:3000.0000kHz SWT:Auto Detector : Peak Project : 070401</p>	<p>Left blank</p>
<p>Avg.</p>	 <p>Date: 2020-08-25</p> <p>Site : 03CH16-HY Condition : AVG_BE_54 3m 91200_1522 HORIZONTAL : RBW:1000.0000kHz VBW:10.0000kHz SWT:Auto Detector : Peak Project : 070401</p>	<p>Left blank</p>

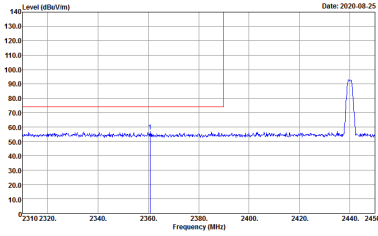
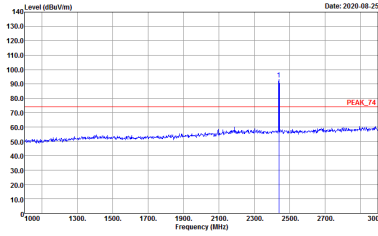
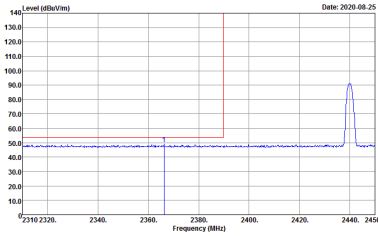
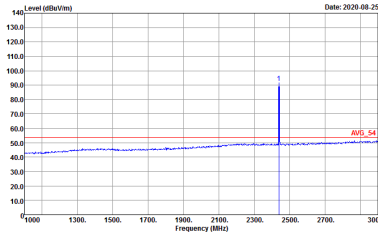

BLE	2.4GHz 2400~2483.5MHz Band Edge @ 3m	
BLE CH19 2440MHz - L		
	Vertical	Fundamental
Peak	 <p>Date: 2020-08-25</p> <p>Site : 03CH16-HY Condition : PEAK_BE_74 3m 91200_1522 VERTICAL RBW:1000.000KHz VBW:3000.000KHz SWT:Auto Detector : Peak Project : 070401</p>	 <p>Date: 2020-08-25</p> <p>Site : 03CH16-HY Condition : PEAK_74 3m 91200_1522 VERTICAL RBW:1000.000KHz VBW:3000.000KHz SWT:Auto Detector : Peak Project : 070401</p>
Avg.	 <p>Date: 2020-08-25</p> <p>Site : 03CH16-HY Condition : AVG_BE_54 3m 91200_1522 VERTICAL RBW:1000.000KHz VBW:10.000KHz SWT:Auto Detector : Peak Project : 070401</p>	 <p>Date: 2020-08-25</p> <p>Site : 03CH16-HY Condition : AVG_54 3m 91200_1522 VERTICAL RBW:1000.000KHz VBW:10.000KHz SWT:Auto Detector : Peak Project : 070401</p>

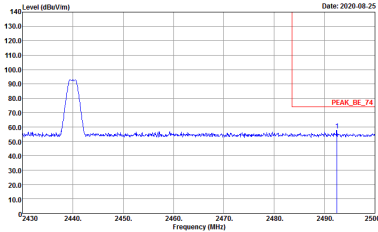
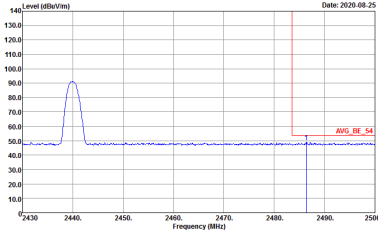

BLE	2.4GHz 2400~2483.5MHz Band Edge @ 3m	
BLE CH19 2440MHz - R		
	Vertical	Fundamental
Peak	 <p>Site : 03CH16-HY Condition : PEAK_BE_74 3m 91200_1522 VERTICAL : RBW:1000.0000kHz VBW:3000.0000kHz SWT:Auto Detector : Peak Project : 070401</p>	Left blank
Avg.	 <p>Site : 03CH16-HY Condition : AVG_BE_54 3m 91200_1522 VERTICAL : RBW:1000.0000kHz VBW:10.0000kHz SWT:Auto Detector : Peak Project : 070401</p>	Left blank



BLE	2.4GHz 2400~2483.5MHz Band Edge @ 3m	
BLE CH39 2480MHz		
	Horizontal	Fundamental
Peak	<p>Date: 2020-08-25</p> <p>Site : 03CH16-HY Condition : PEAK_BE_74 3m 91200_1522 HORIZONTAL RBW:1000.0000kHz VBW:3000.0000kHz SWT:Auto Detector : Peak Project : 070401</p>	<p>Date: 2020-08-25</p> <p>Site : 03CH16-HY Condition : PEAK_F1 3m 91200_1522 HORIZONTAL RBW:1000.0000kHz VBW:3000.0000kHz SWT:Auto Detector : Peak Project : 070401</p>
Avg.	<p>Date: 2020-08-25</p> <p>Site : 03CH16-HY Condition : AVG_BE_54 3m 91200_1522 HORIZONTAL RBW:1000.0000kHz VBW:10.0000kHz SWT:Auto Detector : Peak Project : 070401</p>	<p>Date: 2020-08-25</p> <p>Site : 03CH16-HY Condition : AVG_F1 3m 91200_1522 HORIZONTAL RBW:1000.0000kHz VBW:10.0000kHz SWT:Auto Detector : Peak Project : 070401</p>



BLE	2.4GHz 2400~2483.5MHz Band Edge @ 3m	
BLE CH39 2480MHz		
	Vertical	Fundamental
Peak	<p>Date: 2020-08-25</p> <p>Site : 03CH16-HY Condition : PEAK_BE_74 3m 91200_1522 VERTICAL RBW:1000.0000kHz VBW:3000.0000kHz SWT:Auto Detector : Peak Project : 070401</p>	<p>Date: 2020-08-25</p> <p>Site : 03CH16-HY Condition : PEAK_74 3m 91200_1522 VERTICAL RBW:1000.0000kHz VBW:3000.0000kHz SWT:Auto Detector : Peak Project : 070401</p>
Avg.	<p>Date: 2020-08-25</p> <p>Site : 03CH16-HY Condition : AVG_BE_54 3m 91200_1522 VERTICAL RBW:1000.0000kHz VBW:10.0000kHz SWT:Auto Detector : Peak Project : 070401</p>	<p>Date: 2020-08-25</p> <p>Site : 03CH16-HY Condition : AVG_54 3m 91200_1522 VERTICAL RBW:1000.0000kHz VBW:10.0000kHz SWT:Auto Detector : Peak Project : 070401</p>



2.4GHz 2400~2483.5MHz

BLE (Harmonic @ 3m)

BLE	2.4GHz 2400~2483.5MHz Harmonic @ 3m	
	BLE CH00 2402MHz	
	Horizontal	Vertical
Peak Avg.	<p>Site : 03CH16-HY Condition : PEAK_74 3m 91200_1522 HORIZONTAL Detector : Peak Project : 070401</p>	<p>Site : 03CH16-HY Condition : PEAK_74 3m 91200_1522 VERTICAL Detector : Peak Project : 070401</p>



BLE	2.4GHz 2400~2483.5MHz Harmonic @ 3m	
	BLE CH19 2440MHz	
	Horizontal	Vertical
Peak Avg.	<p>Site : 03CH16-HY Condition : PEAK_74 3m 9120D_1522 HORIZONTAL Detector : Peak Project : 070401</p>	<p>Site : 03CH16-HY Condition : PEAK_74 3m 9120D_1522 VERTICAL Detector : Peak Project : 070401</p>



BLE	2.4GHz 2400~2483.5MHz Harmonic @ 3m	
	BLE CH39 2480MHz	
	Horizontal	Vertical
Peak	<p>Site : 03CH16-HY Condition : PEAK_74 3m 9120D_1522 HORIZONTAL Detector : Peak Project : 070401</p>	<p>Site : 03CH16-HY Condition : PEAK_74 3m 9120D_1522 VERTICAL Detector : Peak Project : 070401</p>

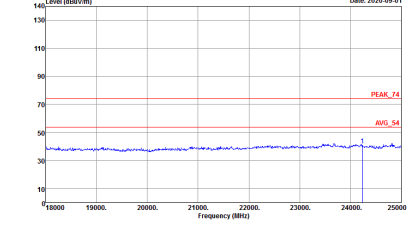
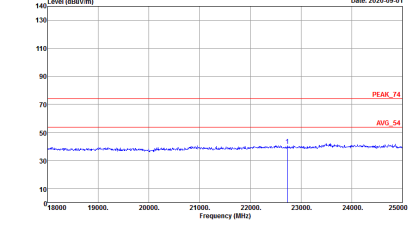

Emission above 18GHz
2.4GHz BLE (SHF)

BLE	2.4GHz 2400~2483.5MHz	
	BLE SHF	
	Horizontal	Vertical
QP / Peak	 <p>Site : 03CH16-1FY Condition : PEAK_74 1m SHF HORN BBH49170584 HORIZONTAL Detector : Peak Project : 070401</p>	 <p>Site : 03CH16-1FY Condition : PEAK_74 1m SHF HORN BBH49170584 VERTICAL Detector : Peak Project : 070401</p>



Emission below 1GHz
2.4GHz BLE (LF)

BLE	2.4GHz 2400~2483.5MHz	
	BLE LF	
	Horizontal	Vertical
QP / Peak	<p>Site : 03CH16-HY Condition : QP 3m BTEL06_47020606 HORIZONTAL Detector : Peak Project : 070401</p>	<p>Site : 03CH16-HY Condition : QP 3m BTEL06_47020606 VERTICAL Detector : Peak Project : 070401</p>



Appendix D. Duty Cycle Plots

Band	Duty Cycle(%)	T(us)	1/T(kHz)	VBW Setting	Duty Factor(dB)
<WCN3990>					
Bluetooth –LE for 1Mbps	62.30	390	2.56	3kHz	2.06
Bluetooth –LE for 2Mbps	32.59	204	4.90	10kHz	4.87
<NRF52810>					
Bluetooth –LE for 1Mbps	62.62	392	2.55	3kHz	2.03
Bluetooth –LE for 2Mbps	32.69	204	4.90	10kHz	4.86



<WCN3990>

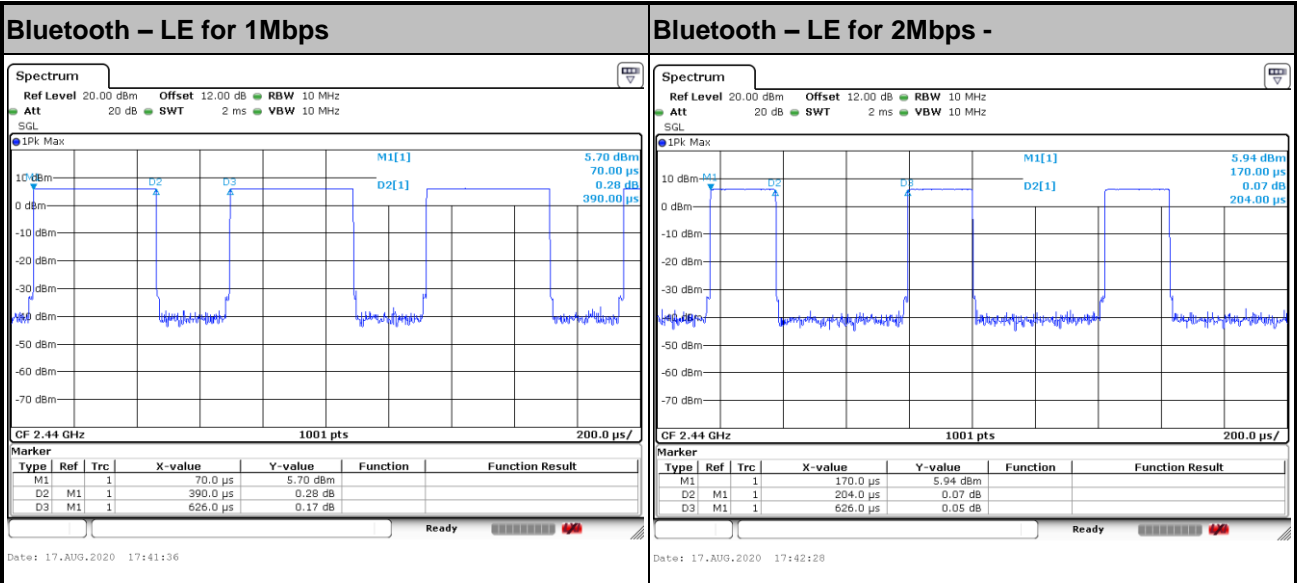

<NRF52810>

