



# FCC RADIO TEST REPORT

**FCC ID** : UZ7EC55AK  
**Equipment** : Enterprise Computer  
**Brand Name** : Zebra  
**Model Name** : EC55AK  
**Applicant** : Zebra Technologies Corporation  
1 Zebra Plaza, Holtsville, NY 11742  
**Manufacturer** : Zebra Technologies Corporation  
1 Zebra Plaza, Holtsville, NY 11742  
**Standard** : FCC 47 CFR Part 2, 22(H), 24(E), 27(L)

The product was received on Sep. 14, 2020 and testing was started from Sep. 26, 2020 and completed on Oct. 08, 2020. We, SPORTON INTERNATIONAL INC. EMC & Wireless Communications Laboratory, would like to declare that the tested sample has been evaluated in accordance with the test procedures given in ANSI / TIA-603-E and has been in compliance with the applicable technical standards.

The test results in this report apply exclusively to the tested model / sample. Without written approval of SPORTON INTERNATIONAL INC. EMC & Wireless Communications Laboratory, the test report shall not be reproduced except in full.

*Louis Wu*

Approved by: Louis Wu

**SPORTON INTERNATIONAL INC. EMC & Wireless Communications Laboratory**  
No. 52, Huaya 1st Rd., Guishan Dist., Taoyuan City, Taiwan (R.O.C.)



# Table of Contents

**History of this test report.....3**

**Summary of Test Result.....4**

**1 General Description .....5**

    1.1 Product Feature of Equipment Under Test .....5

    1.2 Product Specification of Equipment Under Test .....6

    1.3 Modification of EUT .....6

    1.4 Maximum ERP/EIRP Power, Frequency Tolerance, and Emission Designator .....7

    1.5 Testing Location .....7

    1.6 Applicable Standards .....8

**2 Test Configuration of Equipment Under Test .....9**

    2.1 Test Mode.....9

    2.2 Connection Diagram of Test System .....9

    2.3 Support Unit used in test configuration .....10

    2.4 Measurement Results Explanation Example .....10

    2.5 Frequency List of Low/Middle/High Channels.....11

**3 Conducted Test Result .....12**

    3.1 Measuring Instruments.....12

    3.2 Conducted Output Power and ERP/EIRP .....13

    3.3 Peak-to-Average Ratio .....14

    3.4 99% Occupied Bandwidth and 26dB Bandwidth Measurement.....15

    3.5 Conducted Band Edge .....16

    3.6 Conducted Spurious Emission .....17

    3.7 Frequency Stability.....18

**4 Radiated Test Items .....19**

    4.1 Measuring Instruments.....19

    4.2 Test Setup .....19

    4.3 Test Result of Radiated Test.....20

    4.4 Field Strength of Spurious Radiation Measurement .....21

**5 List of Measuring Equipment.....22**

**6 Uncertainty of Evaluation .....24**

**Appendix A. Test Results of Conducted Test**

**Appendix B. Test Results of ERP/EIRP and Radiated Test**

**Appendix C. Test Setup Photographs**





## Summary of Test Result

Report Clause	Ref Std. Clause	Test Items	Result (PASS/FAIL)	Remark
3.2	§2.1046	Conducted Output Power	Pass	-
	§22.913 (a)(2)	Effective Radiated Power (WCDMA Band V)		
	§24.232 (c)	Equivalent Isotropic Radiated Power (WCDMA Band II)		
	§27.50 (d)(4)	Equivalent Isotropic Radiated Power (WCDMA Band IV)		
3.3	§24.232 (d)	Peak-to-Average Ratio	Pass	
3.4	§2.1049 §22.917 (b) §24.238 (b) §27.53 (g)	Occupied Bandwidth (WCDMA Band V) (WCDMA Band II) (WCDMA Band IV)	Pass	-
3.5	§2.1051 §22.917 (a) §24.238 (a) §27.53 (g)	Band Edge Measurement (WCDMA Band V) (WCDMA Band II) (WCDMA Band IV)	Pass	-
3.6	§2.1051 §22.917 (a) §24.238 (a) §27.53 (g)	Conducted Emission (WCDMA Band V) (WCDMA Band II) (WCDMA Band IV)	Pass	-
3.7	§2.1055 §22.355 §24.235 §27.54	Frequency Stability Temperature & Voltage	Pass	-
4.4	§2.1053 §22.917 (a) §24.238 (a) §27.53 (h)	Field Strength of Spurious Radiation (WCDMA Band V) (WCDMA Band II) (WCDMA Band IV)	Pass	Under limit 19.95 dB at 5256.000 MHz

**Declaration of Conformity:**

The test results with all measurement uncertainty excluded are presented in accordance with the regulation limits or requirements declared by manufacturers.

**Comments and Explanations:**

The declared of product specification for EUT presented in the report are provided by the manufacturer, and the manufacturer takes all the responsibilities for the accuracy of product specification.

**Reviewed by: Wii Chang**

**Report Producer: Vivian Hsu**



# 1 General Description

## 1.1 Product Feature of Equipment Under Test

Product Feature	
Equipment	Enterprise Computer
Brand Name	Zebra
Model Name	EC55AK
FCC ID	UZ7EC55AK
EUT supports Radios application	WCDMA/HSPA/LTE/NFC/GNSS WLAN 11a/b/g/n HT20/HT40 WLAN 11ac VHT20/VHT40/VHT80 Bluetooth BR/EDR/LE
HW Version	EV2
SW Version	Android version 10
FW Version	10-13-12.00-QG-U00-PRD-HEL-04
MFD	22JUN20 17JUN20
EUT Stage	Engineering Sample

Remark: The above EUT's information was declared by manufacturer.

Specification of Accessories				
AC Adapter	Brand Name	Zebra	Part Number	PWR-WUA5V15W0US
USB TYPE-C to TYPE-C cable	Brand Name	Zebra	Part Number	CBL-EC5X-USBC3A-01
Battery 1	Brand Name	Zebra	Part Number	BT-000424-00
Battery 2	Brand Name	Zebra	Part Number	BT-000424-08
Earphone 1	Brand Name	Zebra	Part Number	HDST-35MM-PTVP-01
Earphone 2	Brand Name	Zebra	Part Number	HS2100-OTH
USB TYPE C to 3.5mm audio connector	Brand Name	Symbol	Part Number	ADP-USBC-35MM1-01
3.5mm Jack 43"(1.1m) Standard Cable	Brand Name	Zebra	Part Number	CBL-HS2100-3MS1-01
Trigger Handle	Brand Name	Zebra	Part Number	TRG-EC5X-SNP1-01
Soft Holster	Brand Name	Zebra	Part Number	SG-EC5X-HLSTR1-01
Protective Boot	Brand Name	Zebra	Part Number	SG-EC5X-BOOT1-01



Sample List				
	Sample 1	Sample 2	Sample 3	Sample 4
Operating System	ANDROID	ANDROID	ANDROID	ANDROID
RAM	3GB	3GB	4GB	4GB
FLASH	32GB	32GB	64GB	64GB
Scanner	NO	SE4100	SE4100	SE4100
Front Camera	5MP	NO	5MP	5MP
Rear Camera	13MP	13MP	13MP	13MP
	MICRO SD	MICRO SD	MICRO SD	MICRO SD
	GMS	GMS	GMS	GMS
Back connector	NO I/O CONNECTOR	2-PIN	2-PIN	8-PIN
	US	US	US	US

## 1.2 Product Specification of Equipment Under Test

Product Specification subjective to this standard	
Tx Frequency	<b>WCDMA:</b> Band V: 826.4 MHz ~ 846.6 MHz Band II: 1852.4 MHz ~ 1907.6 MHz Band IV: 1712.4 MHz ~ 1752.6 MHz
Rx Frequency	<b>WCDMA:</b> Band V: 871.4 MHz ~ 891.6 MHz Band II: 1932.4 MHz ~ 1987.6 MHz Band IV: 2112.4 MHz ~ 2152.6 MHz
Maximum Output Power to Antenna	<b>WCDMA:</b> Band V: 24.45 dBm Band II: 23.72 dBm Band IV: 23.75 dBm
Antenna Type	PIFA Antenna
Antenna Gain	Cellular Band: 0.12 dBi PCS Band: 4.06 dBi AWS Band: 3.56 dBi
Type of Modulation	WCDMA: QPSK HSDPA: 64QAM HSUPA: QPSK

## 1.3 Modification of EUT

No modifications are made to the EUT during all test items.



### 1.4 Maximum ERP/EIRP Power, Frequency Tolerance, and Emission Designator

FCC Rule	Frequency Range (MHz)	System	Type of Modulation	Maximum ERP/EIRP (W)	Frequency Tolerance (ppm)	Emission Designator
Part 22	826.4 ~846.6	WCDMA Band V RMC 12.2Kbps	QPSK	0.1746	0.0227 ppm	4M14F9W
Part 24	1852.4 ~1907.6	WCDMA Band II RMC 12.2Kbps	QPSK	0.5998	0.0080 ppm	4M14F9W
Part 27	1712.4 ~ 1752.6	WCDMA Band IV RMC 12.2Kbps	QPSK	0.5383	0.0231 ppm	4M13F9W

### 1.5 Testing Location

<b>Test Site</b>	SPORTON INTERNATIONAL INC. EMC & Wireless Communications Laboratory
<b>Test Site Location</b>	No.52, Huaya 1st Rd., Guishan Dist., Taoyuan City, Taiwan (R.O.C.) TEL: +886-3-327-3456 FAX: +886-3-328-4978
<b>Test Site No.</b>	<b>Sporton Site No.</b> TH03-HY
<b>Test Engineer</b>	Oscar Chi
<b>Temperature</b>	21~24°C
<b>Relative Humidity</b>	51~55%

<b>Test Site</b>	SPORTON INTERNATIONAL INC. EMC & Wireless Communications Laboratory
<b>Test Site Location</b>	No.58, Aly. 75, Ln. 564, Wenhua 3rd, Rd., Guishan Dist., Taoyuan City, Taiwan (R.O.C.) TEL: +886-3-327-0868 FAX: +886-3-327-0855
<b>Test Site No.</b>	<b>Sporton Site No.</b> 03CH11-HY
<b>Test Engineer</b>	JC Liang, Fu Chen and Troye Hsieh
<b>Temperature</b>	20.1~21.3°C
<b>Relative Humidity</b>	65.9~69.8%

**Note:** The test site complies with ANSI C63.4 2014 requirement.

FCC Designation No.: TW1190 and TW0007



## **1.6 Applicable Standards**

According to the specifications of the manufacturer, the EUT must comply with the requirements of the following standards:

- ♦ ANSI C63.26-2015
- ♦ ANSI / TIA-603-E
- ♦ FCC 47 CFR Part 2, 22(H), 24(E), 27(L)
- ♦ FCC KDB 971168 D01 Power Meas. License Digital Systems v03r01
- ♦ FCC KDB 412172 D01 Determining ERP and EIRP v01r01
- ♦ FCC KDB 414788 D01 Radiated Test Site v01r01

**Remark:**

1. All test items were verified and recorded according to the standards and without any deviation during the test.
2. This EUT has also been tested and complied with the requirements of FCC Part 15, Subpart B, recorded in a separate test report.
3. The TAF code is not including all the FCC KDB listed without accreditation.



## 2 Test Configuration of Equipment Under Test

### 2.1 Test Mode

Antenna port conducted and radiated test items were performed according to KDB 971168 D01 Power Meas. License Digital Systems v03r01 with maximum output power.

For radiated measurement, pre-scanned in three orthogonal panels, X, Y, Z and SIM slot (SIM1 and eSIM). The worst cases (Z Plane for Cellular Band, Y Plane for PCS Band and X Plane for AWS Band) were recorded in this report.

Radiated emissions were investigated as following frequency range:

1. 30 MHz to 9000 MHz for WCDMA Band V
2. 30 MHz to 18000 MHz for WCDMA Band IV
3. 30 MHz to 19100 MHz for WCDMA Band II

All modes and data rates and positions were investigated.

Test modes are chosen to be reported as the worst case configuration below:

Test Modes		
Band	Radiated TCs	Conducted TCs
WCDMA Band V	■ RMC 12.2Kbps Link	■ RMC 12.2Kbps Link
WCDMA Band II	■ RMC 12.2Kbps Link	■ RMC 12.2Kbps Link
WCDMA Band IV	■ RMC 12.2Kbps Link	■ RMC 12.2Kbps Link

**Remark:** All the radiated test cases were performed with Battery 1, Earphone 1, and Sample 1.

### 2.2 Connection Diagram of Test System

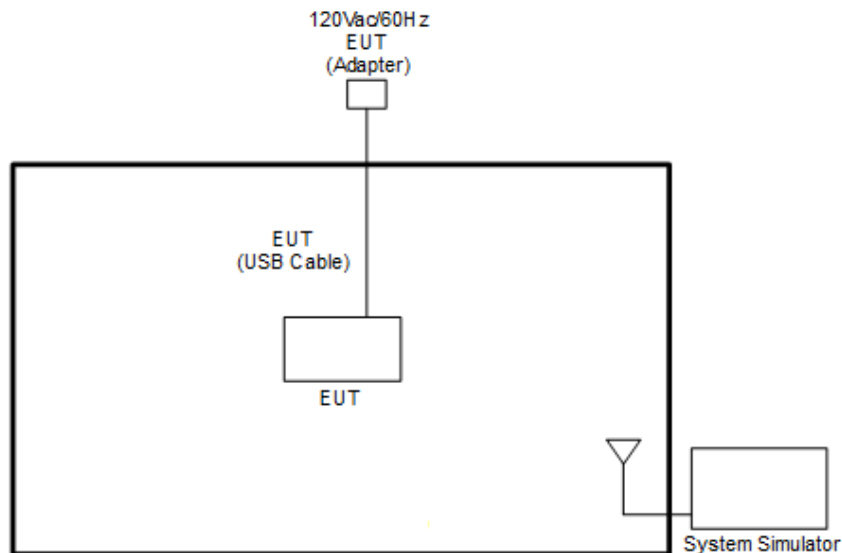



### 2.3 Support Unit used in test configuration

Item	Equipment	Brand Name	Model No.	FCC ID	Data Cable	Power Cord
1.	System Simulator	R&S	CMU 200	N/A	N/A	Unshielded, 1.8 m

### 2.4 Measurement Results Explanation Example

**For all conducted test items:**

The offset level is set in the spectrum analyzer to compensate the RF cable loss and attenuator factor between RF conducted output port and spectrum analyzer. With the offset compensation, the spectrum analyzer reading level will be exactly the RF output level.

The spectrum analyzer offset is derived from RF cable loss and attenuator factor.

$$\text{Offset} = \text{RF cable loss} + \text{attenuator factor}.$$

The following shows an offset computation example with RF cable loss 4.2 dB and a 10dB attenuator.

Example:

$$\begin{aligned} \text{Offset(dB)} &= \text{RF cable loss(dB)} + \text{attenuator factor(dB)}. \\ &= 4.2 + 10 = 14.2 \text{ (dB)} \end{aligned}$$



## 2.5 Frequency List of Low/Middle/High Channels

Frequency List				
Band	Channel/Frequency(MHz)	Lowest	Middle	Highest
WCDMA Band V	Channel	4132	4182	4233
	Frequency	826.4	836.4	846.6
WCDMA Band II	Channel	9262	9400	9538
	Frequency	1852.4	1880.0	1907.6
WCDMA Band IV	Channel	1312	1413	1513
	Frequency	1712.4	1732.6	1752.6

### 3 Conducted Test Result

#### 3.1 Measuring Instruments

See list of measuring instruments of this test report.

##### 3.1.1 Test Setup

##### 3.1.2 Conducted Output Power



##### 3.1.3 Peak-to-Average Ratio, Occupied Bandwidth, Conducted Band-Edge and Conducted Spurious Emission

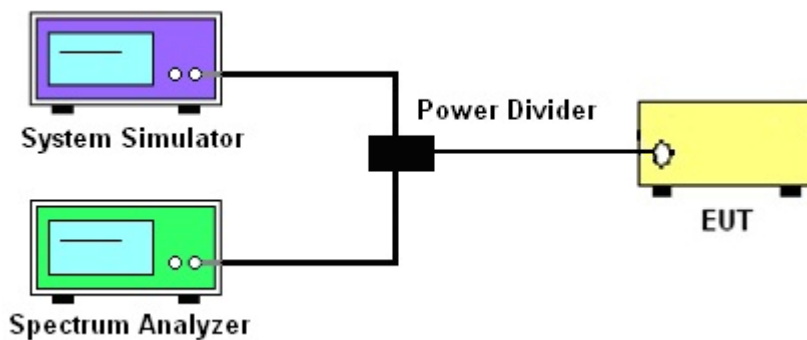

##### 3.1.4 Frequency Stability

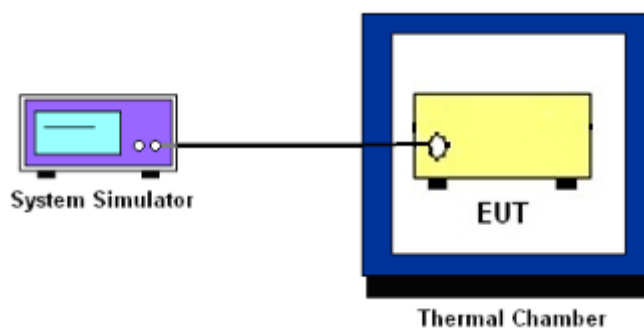

##### 3.1.5 Test Result of Conducted Test

Please refer to Appendix A.



## 3.2 Conducted Output Power and ERP/EIRP

### 3.2.1 Description of the Conducted Output Power and ERP/EIRP

A system simulator was used to establish communication with the EUT. Its parameters were set to enforce EUT transmitting at the maximum power. The measured power in the radio frequency on the transmitter output terminals shall be reported.

The ERP of mobile transmitters must not exceed 7 Watts for WCDMA Band V

The EIRP of mobile transmitters must not exceed 2 Watts for WCDMA Band II

The EIRP of mobile transmitters must not exceed 1 Watts for WCDMA Band IV

According to KDB 412172 D01 Power Approach,

$EIRP = P_T + G_T - L_C$ ,  $ERP = EIRP - 2.15$ , where

$P_T$  = transmitter output power in dBm

$G_T$  = gain of the transmitting antenna in dBi

$L_C$  = signal attenuation in the connecting cable between the transmitter and antenna in dB

### 3.2.2 Test Procedures

1. The transmitter output port was connected to the system simulator.
2. Set EUT at maximum power through system simulator.
3. Select lowest, middle, and highest channels for each band and different modulation.
4. Measure the maximum burst average power for GSM and maximum average power for other modulation signal.



### **3.3 Peak-to-Average Ratio**

#### **3.3.1 Description of the PAR Measurement**

The peak-to-average ratio (PAR) of the transmission may not exceed 13 dB.

#### **3.3.2 Test Procedures**

The testing follows ANSI C63.26-2015 Section 5.2.6

1. The EUT was connected to spectrum analyzer and system simulator via a power divider.
2. Set EUT to transmit at maximum output power.
3. When the duty cycle is less than 98%, then signal gating will be implemented on the spectrum analyzer by triggering from the system simulator.
4. Set the CCDF (Complementary Cumulative Distribution Function) option of the spectrum analyzer.
5. Record the maximum PAPR level associated with a probability of 0.1%.



### 3.4 99% Occupied Bandwidth and 26dB Bandwidth Measurement

#### 3.4.1 Description of 99% Occupied Bandwidth and 26dB Bandwidth Measurement

The occupied bandwidth is the width of a frequency band such that, below the lower and above the upper frequency limits, the mean powers emitted are each equal to a specified percentage 0.5% of the total mean transmitted power.

The 26 dB emission bandwidth is defined as the frequency range between two points, one above and one below the carrier frequency, at which the spectral density of the emission is attenuated 26 dB below the maximum in-band spectral density of the modulated signal. Spectral density (power per unit bandwidth) is to be measured with a detector of resolution bandwidth equal to approximately 1.0% of the emission bandwidth.

#### 3.4.2 Test Procedures

The testing follows ANSI C63.26-2015 Section 5.4.3 (26dB) and Section 5.4.4 (99OB)

1. The EUT was connected to spectrum analyzer and system simulator via a power divider.
2. The spectrum analyzer center frequency is set to the nominal EUT channel center frequency. The span range for the spectrum analyzer shall be between two and five times the anticipated OBW.
3. The nominal resolution bandwidth (RBW) shall be in the range of 1 to 5 % of the anticipated OBW, and the VBW shall be at least 3 times the RBW.
4. Set the detection mode to peak, and the trace mode to max hold.
5. Determine the reference value: Set the EUT to transmit a modulated signal. Allow the trace to stabilize. Set the spectrum analyzer marker to the highest level of the displayed trace.  
(this is the reference value)
6. Determine the “-26 dB down amplitude” as equal to (Reference Value – X).
7. Place two markers, one at the lowest and the other at the highest frequency of the envelope of the spectral display such that each marker is at or slightly below the “-X dB down amplitude” determined in step 6. If a marker is below this “-X dB down amplitude” value it shall be placed as close as possible to this value. The OBW is the positive frequency difference between the two markers.
8. Use the 99 % power bandwidth function of the spectrum analyzer and report the measured bandwidth.



## **3.5 Conducted Band Edge**

### **3.5.1 Description of Conducted Band Edge Measurement**

The power of any emission outside of the authorized operating frequency ranges must be lower than the transmitter power (P) by a factor of at least  $43 + 10 \log (P)$  dB.

### **3.5.2 Test Procedures**

The testing follows FCC KDB 971168 D01 v03r01 Section 6.1.

1. The EUT was connected to the spectrum analyzer and system simulator via a power divider.
2. The RF output of EUT was connected to the spectrum analyzer by an RF cable and attenuator. The path loss was compensated to the results for each measurement.
3. The band edges of low and high channels for the highest RF powers were measured.
4. The RF fundamental frequency should be excluded against the limit line in the operating frequency band.
5. The limit line is derived from  $43 + 10\log(P)$  dB below the transmitter power P(Watts)





## **3.6 Conducted Spurious Emission**

### **3.6.1 Description of Conducted Spurious Emission Measurement**

The power of any emission outside of the authorized operating frequency ranges must be lower than the transmitter power (P) by a factor of at least  $43 + 10 \log (P)$  dB.

It is measured by means of a calibrated spectrum analyzer and scanned from 30 MHz up to a frequency including its 10<sup>th</sup> harmonic.

### **3.6.2 Test Procedures**

The testing follows FCC KDB 971168 D01 v03r01 Section 6.1.

1. The EUT was connected to the spectrum analyzer and system simulator via a power divider.
2. The RF output of EUT was connected to the spectrum analyzer by an RF cable and attenuator.  
The path loss was compensated to the results for each measurement.
3. The middle channel for the highest RF power within the transmitting frequency was measured.
4. The conducted spurious emission for the whole frequency range was taken.
5. The RF fundamental frequency should be excluded against the limit line in the operating frequency band.
6. The limit line is derived from  $43 + 10\log(P)$  dB below the transmitter power P(Watts)



### 3.7 Frequency Stability

#### 3.7.1 Description of Frequency Stability Measurement

22.355

The frequency stability shall be measured by variation of ambient temperature and variation of primary supply voltage to ensure that the fundamental emission stays within the authorized frequency block. The frequency stability of the transmitter shall be maintained within  $\pm 0.00025\%$  ( $\pm 2.5\text{ppm}$ ) of the center frequency.

24.235 & 27.54

The frequency stability shall be sufficient to ensure that the fundamental emission stays within the authorized frequency block.

#### 3.7.2 Test Procedures for Temperature Variation

The testing follows FCC KDB 971168 D01 v03r01 Section 9.0.

1. The EUT was set up in the thermal chamber and connected with the system simulator.
2. With power OFF, the temperature was decreased to  $-30^{\circ}\text{C}$  and the EUT was stabilized before testing. Power was applied and the maximum change in frequency was recorded within one minute.
3. With power OFF, the temperature was raised in  $10^{\circ}\text{C}$  steps up to  $50^{\circ}\text{C}$ . The EUT was stabilized at each step for at least half an hour. Power was applied and the maximum frequency change was recorded within one minute.

#### 3.7.3 Test Procedures for Voltage Variation

The testing follows FCC KDB 971168 D01 v03r01 Section 9.0.

1. The EUT was placed in a temperature chamber at  $20\pm 5^{\circ}\text{C}$  and connected with the system simulator.
2. The power supply voltage to the EUT was varied from 85% to 115% of the nominal value measured at the input to the EUT.
3. The variation in frequency was measured for the worst case.

## 4 Radiated Test Items

### 4.1 Measuring Instruments

See list of measuring instruments of this test report.

### 4.2 Test Setup

For radiated test below 30MHz



For radiated test from 30MHz to 1GHz

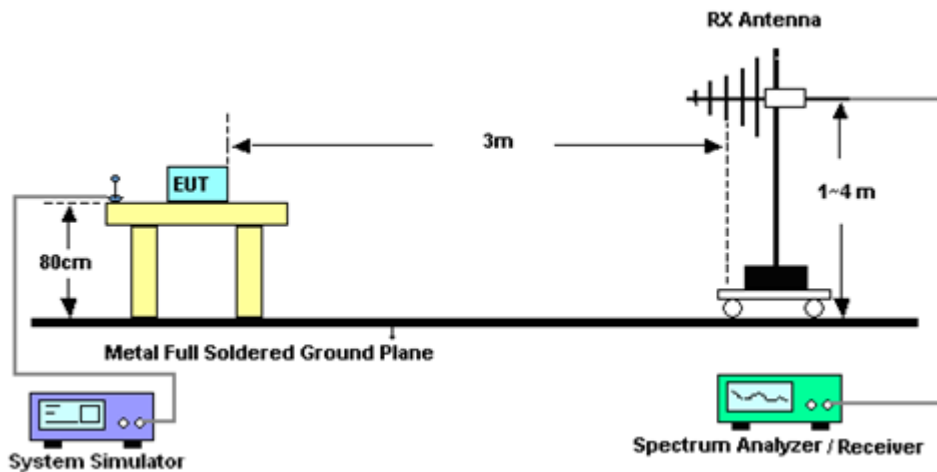

For radiated test above 1GHz

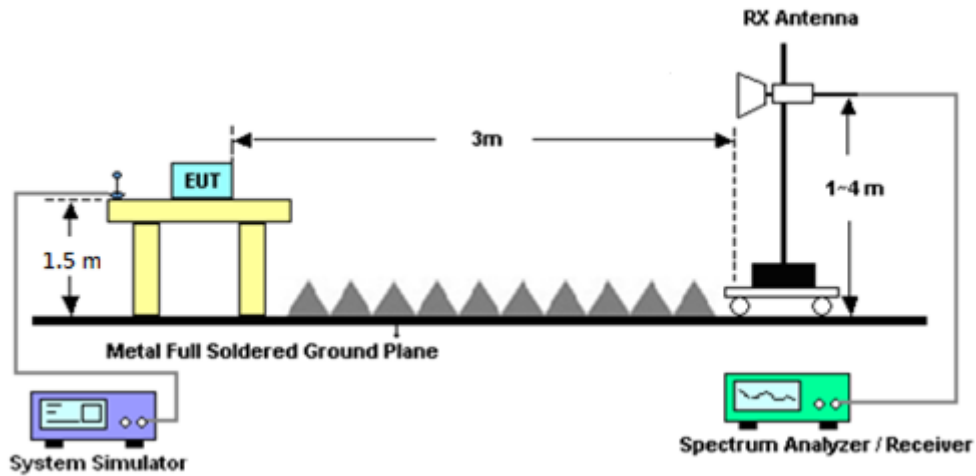

### 4.3 Test Result of Radiated Test

Please refer to Appendix B.

**Note:**

The low frequency, which started from 9 kHz to 30MHz, was pre-scanned and the result which was 20dB lower than the limit line was not reported.

There is a comparison data of both open-field test site and alternative test site - semi-Anechoic chamber according to 414788 D01 Radiated Test Site v01r01, and the result came out very similar.



## 4.4 Field Strength of Spurious Radiation Measurement

### 4.4.1 Description of Field Strength of Spurious Radiated Measurement

The power of any emission outside of the authorized operating frequency ranges must be attenuated below the transmitter power (P) by a factor of at least  $43 + 10 \log (P)$  dB. The spectrum is scanned from 30 MHz up to a frequency including its 10th harmonic.

### 4.4.2 Test Procedures

The testing follows FCC KDB 971168 D01 v03r01 Section 7 and ANSI / TIA-603-E Section 2.2.12.

1. The EUT was placed on a rotatable wooden table 0.8 meters for frequency below 1GHz and 1.5 meter for frequency above 1GHz above the ground.
2. The EUT was set 3 meters from the receiving antenna, which was mounted on the antenna tower.
3. The table was rotated 360 degrees to determine the position of the highest spurious emission.
4. The height of the receiving antenna is varied between one meter and four meters to search for the maximum spurious emission for both horizontal and vertical polarizations.
5. Make the measurement with the spectrum analyzer's RBW = 1MHz, VBW = 3MHz, taking record of maximum spurious emission.
6. A horn antenna was substituted in place of the EUT and was driven by a signal generator.
7. Tune the output power of signal generator to the same emission level with EUT maximum spurious emission.
8. Taking the record of output power at antenna port.
9. Repeat step 7 to step 8 for another polarization.
10.  $EIRP (dBm) = S.G. Power - Tx Cable Loss + Tx Antenna Gain$
11.  $ERP (dBm) = EIRP - 2.15$
12. The RF fundamental frequency should be excluded against the limit line in the operating frequency band.
13. The limit line is derived from  $43 + 10\log(P)$  dB below the transmitter power P(Watts)



## 5 List of Measuring Equipment

Instrument	Brand Name	Model No.	Serial No.	Characteristics	Calibration Date	Test Date	Due Date	Remark
Amplifier	SONOMA	310N	187312	9kHz~1GHz	Dec. 03, 2019	Sep. 26, 2020~ Sep. 29, 2020	Dec. 02, 2020	Radiation (03CH11-HY)
Bilog Antenna	TESEQ	CBL 6111D & N-6-06	35414 & AT-N0602	30MHz~1GHz	Oct. 12, 2019	Sep. 26, 2020~ Sep. 29, 2020	Oct. 11, 2020	Radiation (03CH11-HY)
Horn Antenna	SCHWARZBE CK	BBHA 9120 D	9120D-1326	1GHz ~ 18GHz	Nov. 04, 2019	Sep. 26, 2020~ Sep. 29, 2020	Nov. 03, 2020	Radiation (03CH11-HY)
Loop Antenna	Rohde & Schwarz	HFH2-Z2	100488	9 kHz~30 MHz	Jan. 09, 2020	Sep. 26, 2020~ Sep. 29, 2020	Jan. 08, 2021	Radiation (03CH11-HY)
Preamplifier	Keysight	83017A	MY53270080	1GHz~26.5GHz	Nov. 13, 2019	Sep. 26, 2020~ Sep. 29, 2020	Nov. 12, 2020	Radiation (03CH11-HY)
Spectrum Analyzer	Keysight	N9010A	MY54200486	10Hz ~ 44GHz	Oct. 28, 2019	Sep. 26, 2020~ Sep. 29, 2020	Oct. 27, 2020	Radiation (03CH11-HY)
Filter	Wainwright	WLK4-1000-15 30-8000-40SS	SN11	1.53G Low Pass	Sep. 14, 2020	Sep. 26, 2020~ Sep. 29, 2020	Sep. 13, 2021	Radiation (03CH11-HY)
Filter	Wainwright	WLK4-1000-15 30-8000-40SS	SN11	1.53G Low Pass	Sep. 14, 2020	Sep. 26, 2020~ Sep. 29, 2020	Sep. 13, 2021	Radiation (03CH11-HY)
Filter	Wainwright	WHKX12-2700 -3000-18000-6 0SS	SN3	3GHz High Pass	Sep. 14, 2020	Sep. 26, 2020~ Sep. 29, 2020	Sep. 13, 2021	Radiation (03CH11-HY)
Filter	Wainwright	WHKX12-2700 -3000-18000-6 0SS	SN3	3GHz High Pass	Sep. 14, 2020	Sep. 26, 2020~ Sep. 29, 2020	Sep. 13, 2021	Radiation (03CH11-HY)
Controller	EMEC	EM 1000	N/A	Control Turn table & Ant Mast	N/A	Sep. 26, 2020~ Sep. 29, 2020	N/A	Radiation (03CH11-HY)
Antenna Mast	EMEC	AM-BS-4500-B	N/A	1~4m	N/A	Sep. 26, 2020~ Sep. 29, 2020	N/A	Radiation (03CH11-HY)
Turn Table	EMEC	TT 2000	N/A	0~360 Degree	N/A	Sep. 26, 2020~ Sep. 29, 2020	N/A	Radiation (03CH11-HY)
EMI Test Receiver	Keysight	N9038A(MXE)	MY53290045	20MHz~8.4GHz	Jan. 18, 2020	Sep. 26, 2020~ Sep. 29, 2020	Jan. 17, 2021	Radiation (03CH11-HY)
Software	Audix	E3 6.2009-8-24	RK-001042	N/A	N/A	Sep. 26, 2020~ Sep. 29, 2020	N/A	Radiation (03CH11-HY)
RF Cable	HUBER + SUHNER	SUCOFLEX 104	MY9837/4PE	9kHz-30MHz	Mar. 12, 2020	Sep. 26, 2020~ Sep. 29, 2020	Mar. 11, 2021	Radiation (03CH11-HY)
RF Cable	HUBER + SUHNER	SUCOFLEX 102	MY2859/2	30MHz-40GHz	Mar. 12, 2020	Sep. 26, 2020~ Sep. 29, 2020	Mar. 11, 2021	Radiation (03CH11-HY)
RF Cable	HUBER + SUHNER	SUCOFLEX 104	MY9837/4PE	30M-18G	Mar. 12, 2020	Sep. 26, 2020~ Sep. 29, 2020	Mar. 11, 2021	Radiation (03CH11-HY)
RF Cable	HUBER + SUHNER	SUCOFLEX 102	MY4274/2	30MHz-40GHz	Mar. 12, 2020	Sep. 26, 2020~ Sep. 29, 2020	Mar. 11, 2021	Radiation (03CH11-HY)
SMB100A Signal Generator	Anritsu	MG3694C	163401	0.1Hz~40GHz	Feb. 15 ,2020	Sep. 26, 2020~ Sep. 29, 2020	Feb. 14, 2021	Radiation (03CH11-HY)



Instrument	Brand Name	Model No.	Serial No.	Characteristics	Calibration Date	Test Date	Due Date	Remark
Hygrometer	Testo	608-H1	34893241	N/A	Mar. 02, 2020	Oct. 08, 2020	Mar. 01, 2021	Conducted (TH03-HY)
Spectrum Analyzer	Rohde & Schwarz	FSP30	101329	9kHz~30GHz	Sep. 03, 2020	Oct. 08, 2020	Sep. 02, 2021	Conducted (TH03-HY)
Temperature Chamber	ESPEC	SU-641	92013721	-30°C ~70°C	Nov. 26, 2019	Oct. 08, 2020	Nov. 25, 2020	Conducted (TH03-HY)
Programmable Power Supply	GW Instek	PSS-2005	GEO821763	1V~20V 0.5A~4A	Sep. 16, 2020	Oct. 08, 2020	Sep. 15, 2021	Conducted (TH03-HY)
Base Station (Measure)	Rohde & Schwarz	CMU200	117995	GSM / GPRS / WCDMA / CDMA	Sep. 07, 2020	Oct. 08, 2020	Sep. 06, 2021	Conducted (TH03-HY)
Power Divider	Warison	WCOU-0.4-26. 5S-20	#A	N/A	Nov. 06, 2019	Oct. 08, 2020	Nov. 05, 2020	Conducted (TH03-HY)



## 6 Uncertainty of Evaluation

### Uncertainty of Radiated Emission Measurement (30 MHz ~ 1000 MHz)

Measuring Uncertainty for a Level of Confidence of 95% ( $U = 2Uc(y)$ )	3.29
---	------

### Uncertainty of Radiated Emission Measurement (1 GHz ~ 18 GHz)

Measuring Uncertainty for a Level of Confidence of 95% ( $U = 2Uc(y)$ )	3.32
---	------

### Uncertainty of Radiated Emission Measurement (18 GHz ~ 40 GHz)

Measuring Uncertainty for a Level of Confidence of 95% ( $U = 2Uc(y)$ )	4.08
---	------





## Appendix A. Test Results of Conducted Test

### Conducted Output Power(Average power)

Conducted Power (*Unit: dBm)						
Band	WCDMA Band V			WCDMA Band II		
Channel	4132	4182	4233	9262	9400	9538
Frequency	826.4	836.4	846.6	1852.4	1880	1907.6
RMC 12.2K	24.36	24.45	24.44	23.45	23.72	23.56
HSDPA Subtest-1	23.37	23.47	23.45	22.45	22.72	22.56
HSDPA Subtest-2	23.38	23.48	23.46	22.47	22.74	22.58
HSDPA Subtest-3	22.90	23.00	22.98	21.99	22.26	22.10
HSDPA Subtest-4	22.89	22.99	22.97	22.00	22.27	22.11
HSUPA Subtest-1	23.35	23.45	23.43	22.44	22.71	22.55
HSUPA Subtest-2	21.38	21.48	21.46	20.45	20.72	20.56
HSUPA Subtest-3	22.37	22.47	22.45	21.46	21.73	21.57
HSUPA Subtest-4	21.35	21.45	21.43	20.46	20.73	20.57
HSUPA Subtest-5	23.36	23.46	23.44	22.45	22.72	22.56

Conducted Power (*Unit: dBm)			
Band	WCDMA Band IV		
Channel	1312	1413	1513
Frequency	1712.4	1732.6	1752.6
RMC 12.2K	23.64	23.75	23.66
HSDPA Subtest-1	22.63	22.74	22.65
HSDPA Subtest-2	22.64	22.75	22.66
HSDPA Subtest-3	22.14	22.25	22.16
HSDPA Subtest-4	22.16	22.27	22.18
HSUPA Subtest-1	22.61	22.72	22.63
HSUPA Subtest-2	20.62	20.73	20.64
HSUPA Subtest-3	21.64	21.75	21.66
HSUPA Subtest-4	20.63	20.74	20.65
HSUPA Subtest-5	22.64	22.75	22.66





## A2. WCDMA

### Peak-to-Average Ratio

Mode	WCDMA Band V	WCDMA Band II	WCDMA Band IV	Limit: 13dB
Mod.	RMC 12.2Kbps	RMC 12.2Kbps	RMC 12.2Kbps	Result
Lowest CH	3.12	2.88	3.00	<b>PASS</b>
Middle CH	3.20	2.96	2.76	
Highest CH	3.16	2.68	3.24	

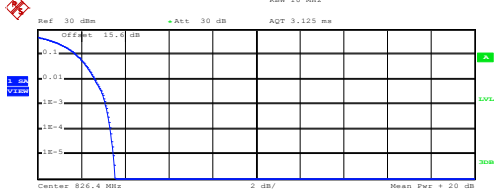

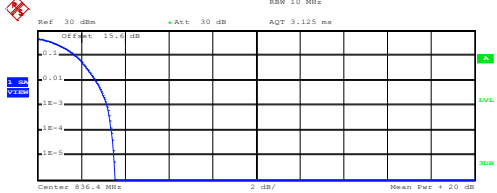
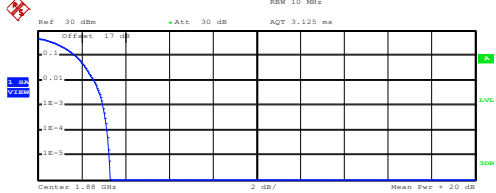
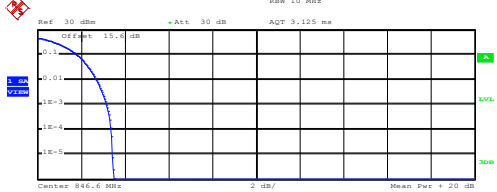
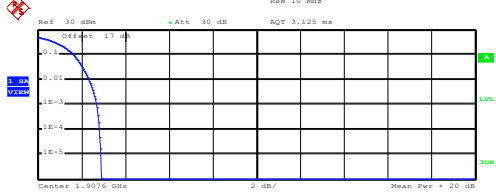
WCDMA Band V (RMC 12.2Kbps)	WCDMA Band II (RMC 12.2Kbps)
<p align="center"><b>Lowest Channel</b></p>  <p>Center 826.4 MHz      2 dB/      Mean Pwr + 20 dB</p> <p>Complementary Cumulative Distribution Function (100000 samples)</p> <p>Trace 1</p> <p>Mean 21.91 dBm Peak 25.45 dBm Crest 3.54 dB</p> <p>10 % 1.76 dB 1 % 2.64 dB .1 % 3.12 dB .01 % 3.32 dB</p> <p>Date: 8.OCT.2020 15:31:05</p>	<p align="center"><b>Lowest Channel</b></p>  <p>Center 1.8524 GHz      2 dB/      Mean Pwr + 20 dB</p> <p>Complementary Cumulative Distribution Function (100000 samples)</p> <p>Trace 1</p> <p>Mean 22.77 dBm Peak 25.95 dBm Crest 3.18 dB</p> <p>10 % 1.72 dB 1 % 2.52 dB .1 % 2.88 dB .01 % 3.08 dB</p> <p>Date: 8.OCT.2020 14:57:41</p>
<p align="center"><b>Middle Channel</b></p>  <p>Center 846.6 MHz      2 dB/      Mean Pwr + 20 dB</p> <p>Complementary Cumulative Distribution Function (100000 samples)</p> <p>Trace 1</p> <p>Mean 21.97 dBm Peak 25.52 dBm Crest 3.55 dB</p> <p>10 % 1.76 dB 1 % 2.68 dB .1 % 3.20 dB .01 % 3.40 dB</p> <p>Date: 8.OCT.2020 15:31:24</p>	<p align="center"><b>Middle Channel</b></p>  <p>Center 1.88 GHz      2 dB/      Mean Pwr + 20 dB</p> <p>Complementary Cumulative Distribution Function (100000 samples)</p> <p>Trace 1</p> <p>Mean 22.86 dBm Peak 26.16 dBm Crest 3.30 dB</p> <p>10 % 1.72 dB 1 % 2.56 dB .1 % 2.96 dB .01 % 3.16 dB</p> <p>Date: 8.OCT.2020 14:58:03</p>
<p align="center"><b>Highest Channel</b></p>  <p>Center 846.6 MHz      2 dB/      Mean Pwr + 20 dB</p> <p>Complementary Cumulative Distribution Function (100000 samples)</p> <p>Trace 1</p> <p>Mean 22.03 dBm Peak 25.52 dBm Crest 3.49 dB</p> <p>10 % 1.80 dB 1 % 2.72 dB .1 % 3.16 dB .01 % 3.36 dB</p> <p>Date: 8.OCT.2020 15:31:43</p>	<p align="center"><b>Highest Channel</b></p>  <p>Center 1.9076 GHz      2 dB/      Mean Pwr + 20 dB</p> <p>Complementary Cumulative Distribution Function (100000 samples)</p> <p>Trace 1</p> <p>Mean 22.70 dBm Peak 25.59 dBm Crest 2.89 dB</p> <p>10 % 1.64 dB 1 % 2.32 dB .1 % 2.68 dB .01 % 2.84 dB</p> <p>Date: 8.OCT.2020 14:58:22</p>

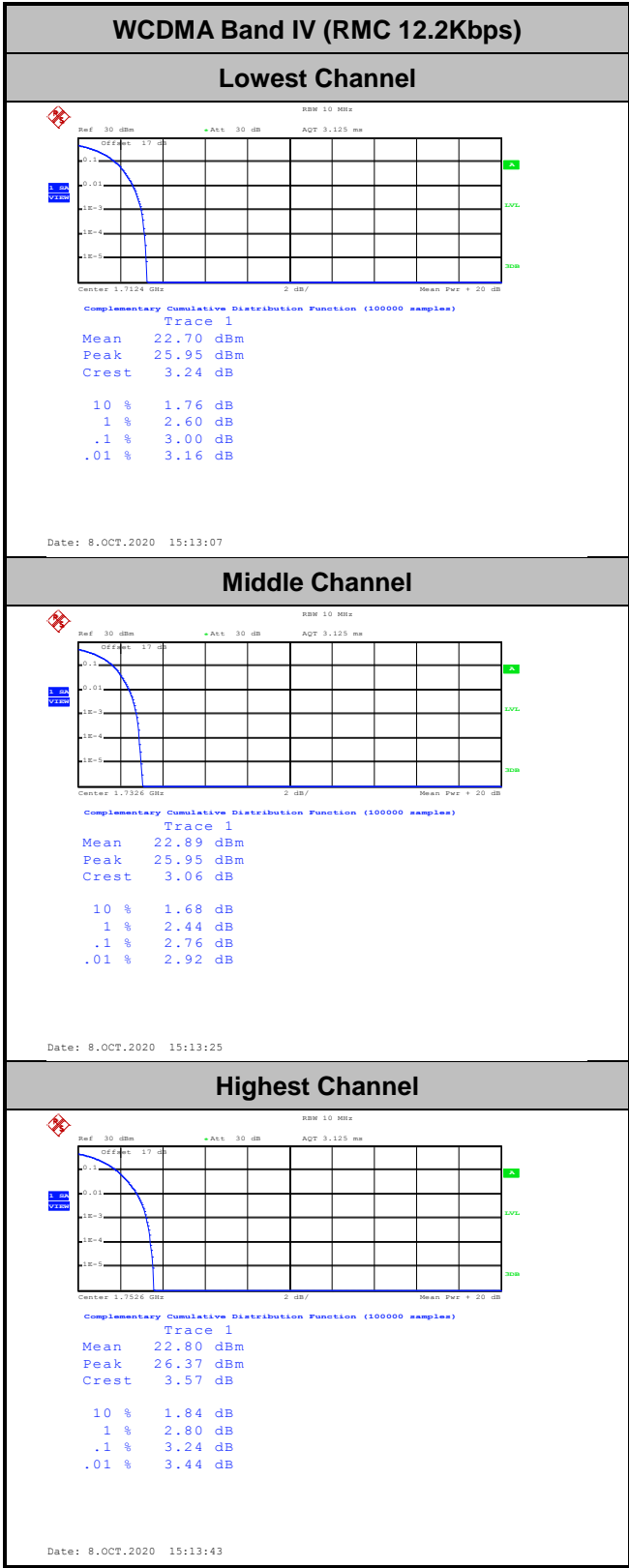



**26dB Bandwidth**

Mode	WCDMA Band V 26dB BW(MHz)	WCDMA Band II 26dB BW(MHz)	WCDMA Band IV 26dB BW(MHz)
Mod.	RMC 12.2Kbps	RMC 12.2Kbps	RMC 12.2Kbps
Lowest CH	4.72	4.72	4.72
Middle CH	4.70	4.71	4.73
Highest CH	4.71	4.74	4.69

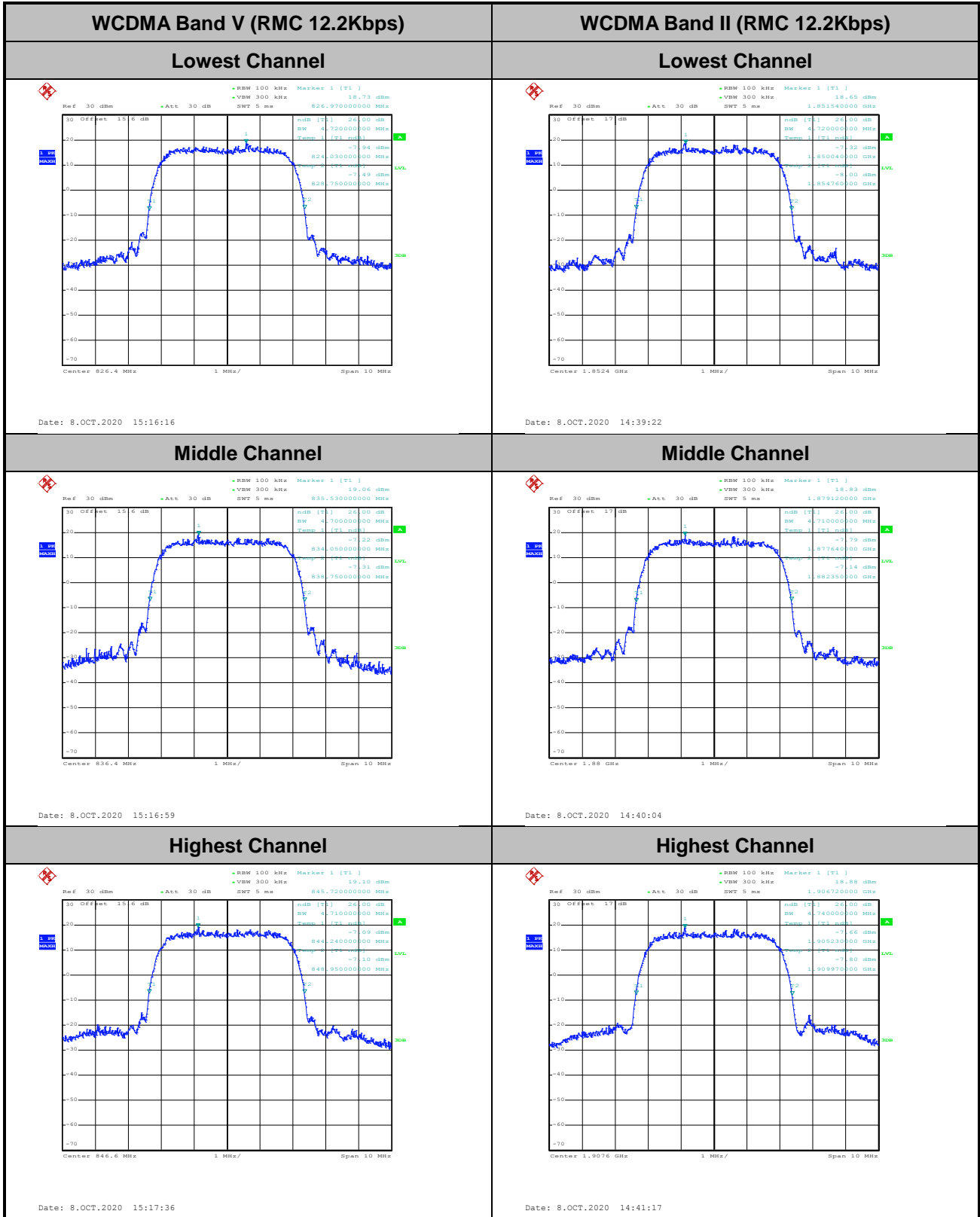



### WCDMA Band IV (RMC 12.2Kbps)

#### Lowest Channel

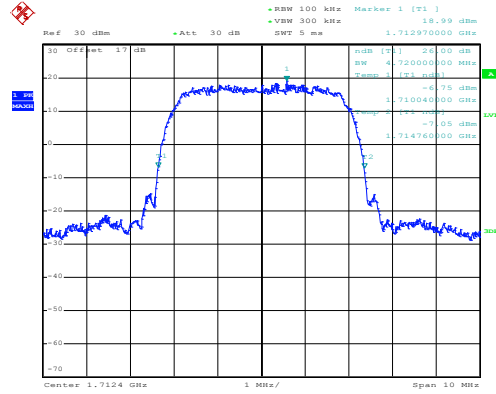

Date: 8.OCT.2020 15:00:04

#### Middle Channel

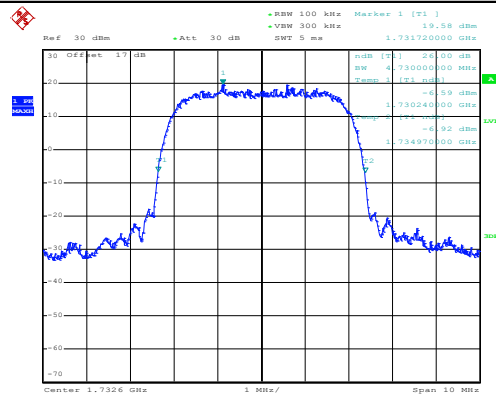

Date: 8.OCT.2020 15:00:44

#### Highest Channel

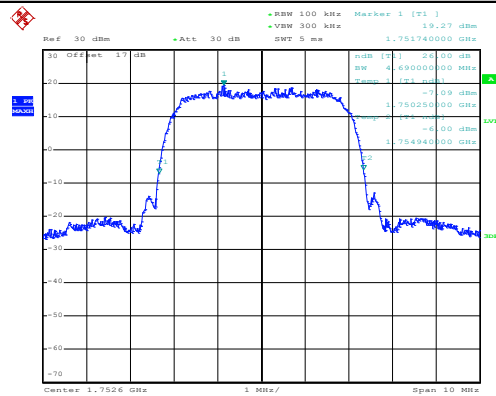

Date: 8.OCT.2020 15:01:24



**Occupied Bandwidth**

Mode	WCDMA Band V 99% OBW(MHz)	WCDMA Band II 99% OBW(MHz)	WCDMA Band IV 99% OBW(MHz)
Mod.	RMC 12.2Kbps	RMC 12.2Kbps	RMC 12.2Kbps
Lowest CH	4.14	4.14	4.12
Middle CH	4.14	4.14	4.13
Highest CH	4.14	4.14	4.13



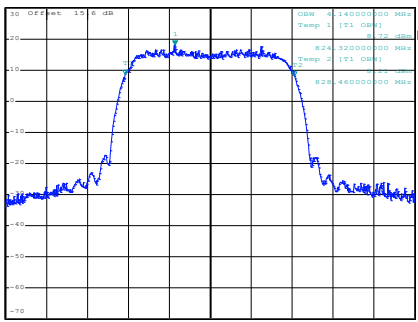
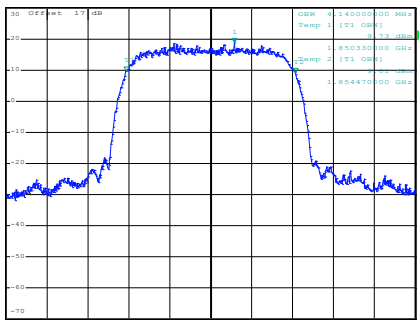
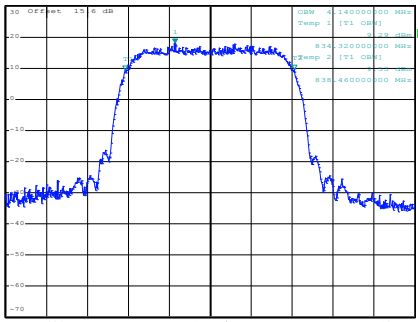
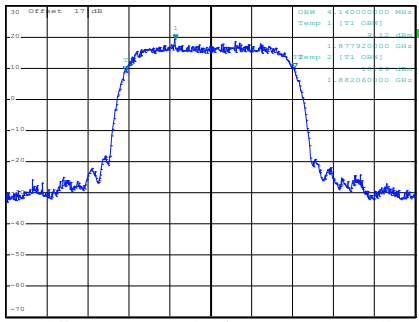
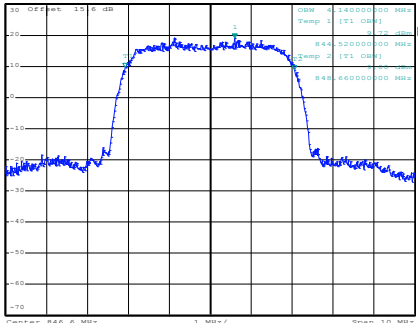
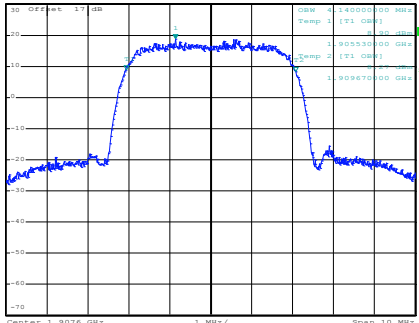

WCDMA Band V (RMC 12.2Kbps)	WCDMA Band II (RMC 12.2Kbps)
<p style="text-align: center;"><b>Lowest Channel</b></p>  <p style="text-align: right;">Date: 8.OCT.2020 15:23:28</p>	<p style="text-align: center;"><b>Lowest Channel</b></p>  <p style="text-align: right;">Date: 8.OCT.2020 14:49:44</p>
<p style="text-align: center;"><b>Middle Channel</b></p>  <p style="text-align: right;">Date: 8.OCT.2020 15:24:06</p>	<p style="text-align: center;"><b>Middle Channel</b></p>  <p style="text-align: right;">Date: 8.OCT.2020 14:50:44</p>
<p style="text-align: center;"><b>Highest Channel</b></p>  <p style="text-align: right;">Date: 8.OCT.2020 15:24:44</p>	<p style="text-align: center;"><b>Highest Channel</b></p>  <p style="text-align: right;">Date: 8.OCT.2020 14:51:23</p>



### WCDMA Band IV (RMC 12.2Kbps)

#### Lowest Channel

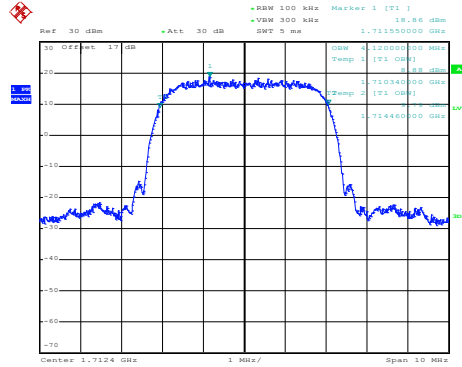

Date: 8.OCT.2020 15:05:36

#### Middle Channel

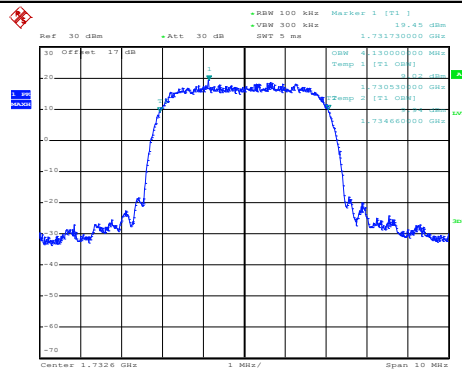

Date: 8.OCT.2020 15:06:14

#### Highest Channel

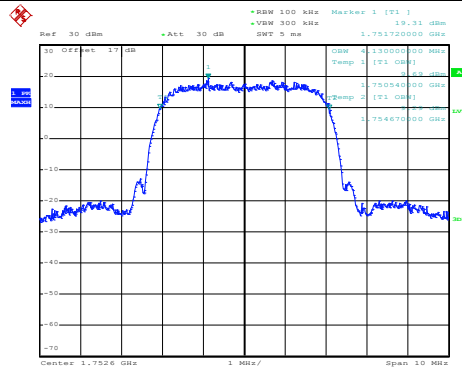

Date: 8.OCT.2020 15:06:53



**Conducted Band Edge**

**WCDMA Band V (RMC 12.2Kbps)**

**Lowest Band Edge**

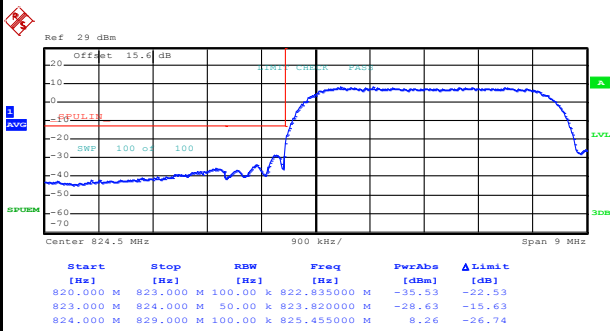

Date: 8.OCT.2020 15:27:40

**Highest Band Edge**

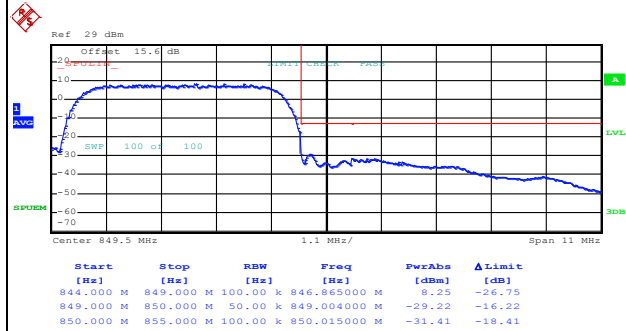

Date: 8.OCT.2020 15:30:33

**WCDMA Band II (RMC 12.2Kbps)**

**Lowest Band Edge**

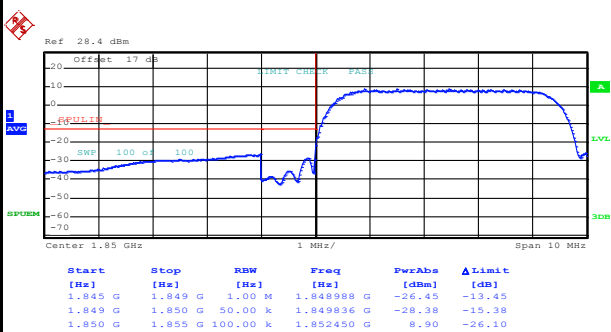

Date: 8.OCT.2020 14:54:22

**Highest Band Edge**

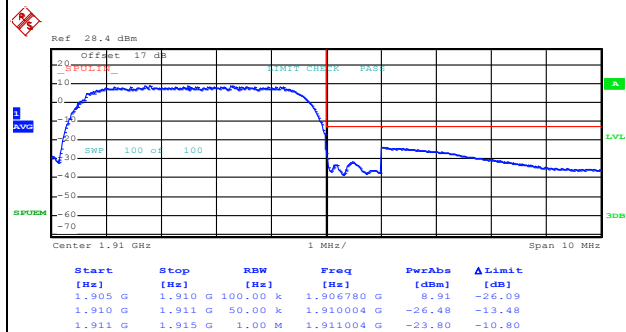

Date: 8.OCT.2020 14:57:17



WCDMA Band IV (RMC 12.2Kbps)

Lowest Band Edge

Highest Band Edge

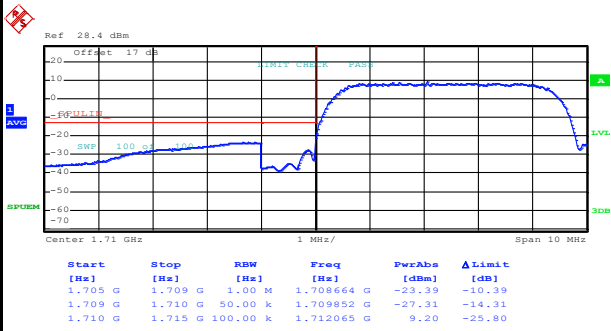

Date: 8.OCT.2020 15:09:50

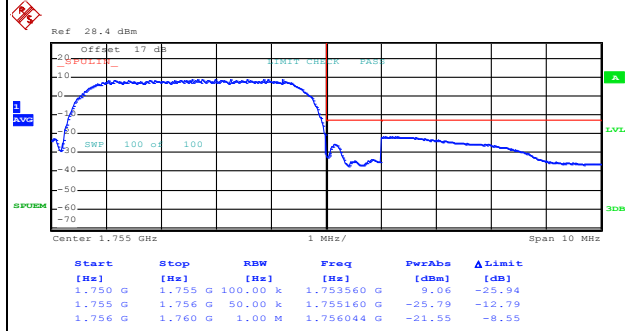

Date: 8.OCT.2020 15:12:43

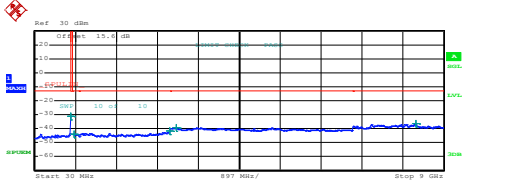
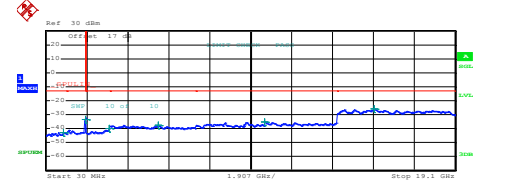
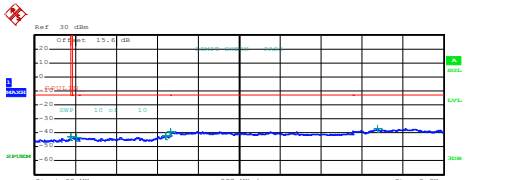
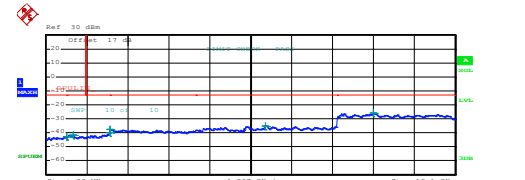
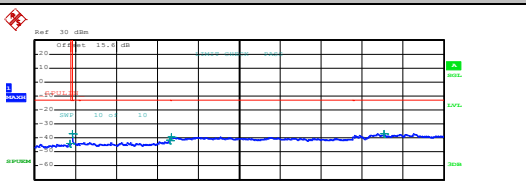
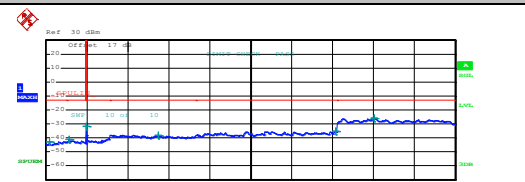

# Conducted Spurious Emission

WCDMA Band V (RMC 12.2Kbps)	WCDMA Band II (RMC 12.2Kbps)																																																																														
Lowest Channel	Lowest Channel																																																																														
 <table border="1" data-bbox="239 660 702 739"> <thead> <tr> <th>Start [Hz]</th> <th>Stop [Hz]</th> <th>RBW [Hz]</th> <th>Freq [Hz]</th> <th>PwrAbs [dBm]</th> <th>ΔLimit [dB]</th> </tr> </thead> <tbody> <tr> <td>30,000 M</td> <td>820,000 M</td> <td>1,000 M</td> <td>816,210000 M</td> <td>-33.19</td> <td>-29.19</td> </tr> <tr> <td>855,000 M</td> <td>1,000 G</td> <td>1,000 G</td> <td>896,542500 M</td> <td>-43.84</td> <td>-30.84</td> </tr> <tr> <td>1,000 G</td> <td>3,000 G</td> <td>1,000 M</td> <td>2,984500 G</td> <td>-42.88</td> <td>-28.88</td> </tr> <tr> <td>3,000 G</td> <td>7,000 G</td> <td>1,000 M</td> <td>3,127000 G</td> <td>-39.34</td> <td>-26.34</td> </tr> <tr> <td>7,000 G</td> <td>9,000 G</td> <td>1,000 M</td> <td>8,392000 G</td> <td>-36.42</td> <td>-23.42</td> </tr> </tbody> </table> <p>Date: 8.OCT.2020 15:18:39</p>	Start [Hz]	Stop [Hz]	RBW [Hz]	Freq [Hz]	PwrAbs [dBm]	ΔLimit [dB]	30,000 M	820,000 M	1,000 M	816,210000 M	-33.19	-29.19	855,000 M	1,000 G	1,000 G	896,542500 M	-43.84	-30.84	1,000 G	3,000 G	1,000 M	2,984500 G	-42.88	-28.88	3,000 G	7,000 G	1,000 M	3,127000 G	-39.34	-26.34	7,000 G	9,000 G	1,000 M	8,392000 G	-36.42	-23.42	 <table border="1" data-bbox="877 660 1340 739"> <thead> <tr> <th>Start [Hz]</th> <th>Stop [Hz]</th> <th>RBW [Hz]</th> <th>Freq [Hz]</th> <th>PwrAbs [dBm]</th> <th>ΔLimit [dB]</th> </tr> </thead> <tbody> <tr> <td>30,000 M</td> <td>1,000 G</td> <td>1,000 M</td> <td>835,350000 M</td> <td>-42.02</td> <td>-29.02</td> </tr> <tr> <td>1,000 G</td> <td>3,000 G</td> <td>1,000 M</td> <td>3,844789 G</td> <td>-33.27</td> <td>-20.27</td> </tr> <tr> <td>3,000 G</td> <td>7,000 G</td> <td>1,000 M</td> <td>2,983454 G</td> <td>-40.17</td> <td>-27.17</td> </tr> <tr> <td>7,000 G</td> <td>13,600 G</td> <td>1,000 M</td> <td>5,238000 G</td> <td>-37.58</td> <td>-24.58</td> </tr> <tr> <td>13,600 G</td> <td>19,100 G</td> <td>1,000 M</td> <td>10,227400 G</td> <td>-35.29</td> <td>-22.29</td> </tr> <tr> <td>19,100 G</td> <td>19,100 G</td> <td>1,000 M</td> <td>15,331125 G</td> <td>-26.12</td> <td>-13.12</td> </tr> </tbody> </table> <p>Date: 8.OCT.2020 14:46:42</p>	Start [Hz]	Stop [Hz]	RBW [Hz]	Freq [Hz]	PwrAbs [dBm]	ΔLimit [dB]	30,000 M	1,000 G	1,000 M	835,350000 M	-42.02	-29.02	1,000 G	3,000 G	1,000 M	3,844789 G	-33.27	-20.27	3,000 G	7,000 G	1,000 M	2,983454 G	-40.17	-27.17	7,000 G	13,600 G	1,000 M	5,238000 G	-37.58	-24.58	13,600 G	19,100 G	1,000 M	10,227400 G	-35.29	-22.29	19,100 G	19,100 G	1,000 M	15,331125 G	-26.12	-13.12
Start [Hz]	Stop [Hz]	RBW [Hz]	Freq [Hz]	PwrAbs [dBm]	ΔLimit [dB]																																																																										
30,000 M	820,000 M	1,000 M	816,210000 M	-33.19	-29.19																																																																										
855,000 M	1,000 G	1,000 G	896,542500 M	-43.84	-30.84																																																																										
1,000 G	3,000 G	1,000 M	2,984500 G	-42.88	-28.88																																																																										
3,000 G	7,000 G	1,000 M	3,127000 G	-39.34	-26.34																																																																										
7,000 G	9,000 G	1,000 M	8,392000 G	-36.42	-23.42																																																																										
Start [Hz]	Stop [Hz]	RBW [Hz]	Freq [Hz]	PwrAbs [dBm]	ΔLimit [dB]																																																																										
30,000 M	1,000 G	1,000 M	835,350000 M	-42.02	-29.02																																																																										
1,000 G	3,000 G	1,000 M	3,844789 G	-33.27	-20.27																																																																										
3,000 G	7,000 G	1,000 M	2,983454 G	-40.17	-27.17																																																																										
7,000 G	13,600 G	1,000 M	5,238000 G	-37.58	-24.58																																																																										
13,600 G	19,100 G	1,000 M	10,227400 G	-35.29	-22.29																																																																										
19,100 G	19,100 G	1,000 M	15,331125 G	-26.12	-13.12																																																																										
Middle Channel	Middle Channel																																																																														
 <table border="1" data-bbox="239 1176 702 1254"> <thead> <tr> <th>Start [Hz]</th> <th>Stop [Hz]</th> <th>RBW [Hz]</th> <th>Freq [Hz]</th> <th>PwrAbs [dBm]</th> <th>ΔLimit [dB]</th> </tr> </thead> <tbody> <tr> <td>30,000 M</td> <td>820,000 M</td> <td>1,000 M</td> <td>817,432500 M</td> <td>-42.53</td> <td>-29.53</td> </tr> <tr> <td>855,000 M</td> <td>1,000 G</td> <td>1,000 M</td> <td>937,277000 M</td> <td>-43.47</td> <td>-30.47</td> </tr> <tr> <td>1,000 G</td> <td>3,000 G</td> <td>1,000 M</td> <td>2,907500 G</td> <td>-42.05</td> <td>-29.05</td> </tr> <tr> <td>3,000 G</td> <td>7,000 G</td> <td>1,000 M</td> <td>3,004000 G</td> <td>-39.09</td> <td>-26.09</td> </tr> <tr> <td>7,000 G</td> <td>9,000 G</td> <td>1,000 M</td> <td>7,947000 G</td> <td>-37.07</td> <td>-24.07</td> </tr> </tbody> </table> <p>Date: 8.OCT.2020 15:19:35</p>	Start [Hz]	Stop [Hz]	RBW [Hz]	Freq [Hz]	PwrAbs [dBm]	ΔLimit [dB]	30,000 M	820,000 M	1,000 M	817,432500 M	-42.53	-29.53	855,000 M	1,000 G	1,000 M	937,277000 M	-43.47	-30.47	1,000 G	3,000 G	1,000 M	2,907500 G	-42.05	-29.05	3,000 G	7,000 G	1,000 M	3,004000 G	-39.09	-26.09	7,000 G	9,000 G	1,000 M	7,947000 G	-37.07	-24.07	 <table border="1" data-bbox="877 1176 1340 1254"> <thead> <tr> <th>Start [Hz]</th> <th>Stop [Hz]</th> <th>RBW [Hz]</th> <th>Freq [Hz]</th> <th>PwrAbs [dBm]</th> <th>ΔLimit [dB]</th> </tr> </thead> <tbody> <tr> <td>30,000 M</td> <td>1,000 G</td> <td>1,000 M</td> <td>998,787000 M</td> <td>-42.71</td> <td>-29.71</td> </tr> <tr> <td>1,000 G</td> <td>3,000 G</td> <td>1,000 M</td> <td>3,300186 G</td> <td>-41.86</td> <td>-28.86</td> </tr> <tr> <td>3,000 G</td> <td>7,000 G</td> <td>1,000 M</td> <td>2,990778 G</td> <td>-40.09</td> <td>-27.09</td> </tr> <tr> <td>7,000 G</td> <td>13,600 G</td> <td>1,000 M</td> <td>3,023000 G</td> <td>-37.82</td> <td>-24.82</td> </tr> <tr> <td>13,600 G</td> <td>19,100 G</td> <td>1,000 M</td> <td>10,249600 G</td> <td>-35.07</td> <td>-22.07</td> </tr> <tr> <td>19,100 G</td> <td>19,100 G</td> <td>1,000 M</td> <td>15,295375 G</td> <td>-25.94</td> <td>-12.94</td> </tr> </tbody> </table> <p>Date: 8.OCT.2020 14:47:42</p>	Start [Hz]	Stop [Hz]	RBW [Hz]	Freq [Hz]	PwrAbs [dBm]	ΔLimit [dB]	30,000 M	1,000 G	1,000 M	998,787000 M	-42.71	-29.71	1,000 G	3,000 G	1,000 M	3,300186 G	-41.86	-28.86	3,000 G	7,000 G	1,000 M	2,990778 G	-40.09	-27.09	7,000 G	13,600 G	1,000 M	3,023000 G	-37.82	-24.82	13,600 G	19,100 G	1,000 M	10,249600 G	-35.07	-22.07	19,100 G	19,100 G	1,000 M	15,295375 G	-25.94	-12.94
Start [Hz]	Stop [Hz]	RBW [Hz]	Freq [Hz]	PwrAbs [dBm]	ΔLimit [dB]																																																																										
30,000 M	820,000 M	1,000 M	817,432500 M	-42.53	-29.53																																																																										
855,000 M	1,000 G	1,000 M	937,277000 M	-43.47	-30.47																																																																										
1,000 G	3,000 G	1,000 M	2,907500 G	-42.05	-29.05																																																																										
3,000 G	7,000 G	1,000 M	3,004000 G	-39.09	-26.09																																																																										
7,000 G	9,000 G	1,000 M	7,947000 G	-37.07	-24.07																																																																										
Start [Hz]	Stop [Hz]	RBW [Hz]	Freq [Hz]	PwrAbs [dBm]	ΔLimit [dB]																																																																										
30,000 M	1,000 G	1,000 M	998,787000 M	-42.71	-29.71																																																																										
1,000 G	3,000 G	1,000 M	3,300186 G	-41.86	-28.86																																																																										
3,000 G	7,000 G	1,000 M	2,990778 G	-40.09	-27.09																																																																										
7,000 G	13,600 G	1,000 M	3,023000 G	-37.82	-24.82																																																																										
13,600 G	19,100 G	1,000 M	10,249600 G	-35.07	-22.07																																																																										
19,100 G	19,100 G	1,000 M	15,295375 G	-25.94	-12.94																																																																										
Highest Channel	Highest Channel																																																																														
 <table border="1" data-bbox="239 1691 702 1769"> <thead> <tr> <th>Start [Hz]</th> <th>Stop [Hz]</th> <th>RBW [Hz]</th> <th>Freq [Hz]</th> <th>PwrAbs [dBm]</th> <th>ΔLimit [dB]</th> </tr> </thead> <tbody> <tr> <td>30,000 M</td> <td>820,000 M</td> <td>1,000 M</td> <td>804,732500 M</td> <td>-43.68</td> <td>-30.68</td> </tr> <tr> <td>855,000 M</td> <td>1,000 G</td> <td>1,000 M</td> <td>855,072500 M</td> <td>-37.14</td> <td>-24.14</td> </tr> <tr> <td>1,000 G</td> <td>3,000 G</td> <td>1,000 M</td> <td>2,990000 G</td> <td>-42.49</td> <td>-28.49</td> </tr> <tr> <td>3,000 G</td> <td>7,000 G</td> <td>1,000 M</td> <td>3,029000 G</td> <td>-39.39</td> <td>-26.39</td> </tr> <tr> <td>7,000 G</td> <td>9,000 G</td> <td>1,000 M</td> <td>7,683000 G</td> <td>-36.88</td> <td>-23.88</td> </tr> </tbody> </table> <p>Date: 8.OCT.2020 15:20:31</p>	Start [Hz]	Stop [Hz]	RBW [Hz]	Freq [Hz]	PwrAbs [dBm]	ΔLimit [dB]	30,000 M	820,000 M	1,000 M	804,732500 M	-43.68	-30.68	855,000 M	1,000 G	1,000 M	855,072500 M	-37.14	-24.14	1,000 G	3,000 G	1,000 M	2,990000 G	-42.49	-28.49	3,000 G	7,000 G	1,000 M	3,029000 G	-39.39	-26.39	7,000 G	9,000 G	1,000 M	7,683000 G	-36.88	-23.88	 <table border="1" data-bbox="877 1691 1340 1769"> <thead> <tr> <th>Start [Hz]</th> <th>Stop [Hz]</th> <th>RBW [Hz]</th> <th>Freq [Hz]</th> <th>PwrAbs [dBm]</th> <th>ΔLimit [dB]</th> </tr> </thead> <tbody> <tr> <td>30,000 M</td> <td>1,000 G</td> <td>1,000 M</td> <td>168,405000 M</td> <td>-40.53</td> <td>-27.53</td> </tr> <tr> <td>1,000 G</td> <td>3,000 G</td> <td>1,000 M</td> <td>3,103301 G</td> <td>-41.11</td> <td>-28.11</td> </tr> <tr> <td>3,000 G</td> <td>7,000 G</td> <td>1,000 M</td> <td>2,933542 G</td> <td>-31.07</td> <td>-18.07</td> </tr> <tr> <td>7,000 G</td> <td>13,600 G</td> <td>1,000 M</td> <td>5,237000 G</td> <td>-37.90</td> <td>-24.90</td> </tr> <tr> <td>13,600 G</td> <td>19,100 G</td> <td>1,000 M</td> <td>13,515850 G</td> <td>-35.34</td> <td>-22.34</td> </tr> <tr> <td>19,100 G</td> <td>19,100 G</td> <td>1,000 M</td> <td>15,337375 G</td> <td>-25.99</td> <td>-12.99</td> </tr> </tbody> </table> <p>Date: 8.OCT.2020 14:48:41</p>	Start [Hz]	Stop [Hz]	RBW [Hz]	Freq [Hz]	PwrAbs [dBm]	ΔLimit [dB]	30,000 M	1,000 G	1,000 M	168,405000 M	-40.53	-27.53	1,000 G	3,000 G	1,000 M	3,103301 G	-41.11	-28.11	3,000 G	7,000 G	1,000 M	2,933542 G	-31.07	-18.07	7,000 G	13,600 G	1,000 M	5,237000 G	-37.90	-24.90	13,600 G	19,100 G	1,000 M	13,515850 G	-35.34	-22.34	19,100 G	19,100 G	1,000 M	15,337375 G	-25.99	-12.99
Start [Hz]	Stop [Hz]	RBW [Hz]	Freq [Hz]	PwrAbs [dBm]	ΔLimit [dB]																																																																										
30,000 M	820,000 M	1,000 M	804,732500 M	-43.68	-30.68																																																																										
855,000 M	1,000 G	1,000 M	855,072500 M	-37.14	-24.14																																																																										
1,000 G	3,000 G	1,000 M	2,990000 G	-42.49	-28.49																																																																										
3,000 G	7,000 G	1,000 M	3,029000 G	-39.39	-26.39																																																																										
7,000 G	9,000 G	1,000 M	7,683000 G	-36.88	-23.88																																																																										
Start [Hz]	Stop [Hz]	RBW [Hz]	Freq [Hz]	PwrAbs [dBm]	ΔLimit [dB]																																																																										
30,000 M	1,000 G	1,000 M	168,405000 M	-40.53	-27.53																																																																										
1,000 G	3,000 G	1,000 M	3,103301 G	-41.11	-28.11																																																																										
3,000 G	7,000 G	1,000 M	2,933542 G	-31.07	-18.07																																																																										
7,000 G	13,600 G	1,000 M	5,237000 G	-37.90	-24.90																																																																										
13,600 G	19,100 G	1,000 M	13,515850 G	-35.34	-22.34																																																																										
19,100 G	19,100 G	1,000 M	15,337375 G	-25.99	-12.99																																																																										



WCDMA Band IV (RMC 12.2Kbps)

Lowest Channel

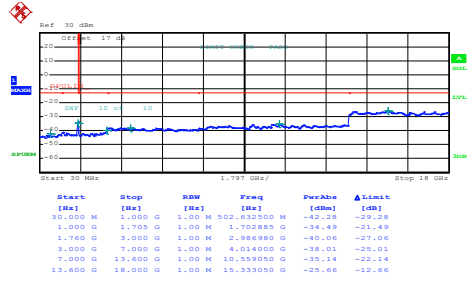

Date: 8.OCT.2020 15:02:32

Middle Channel

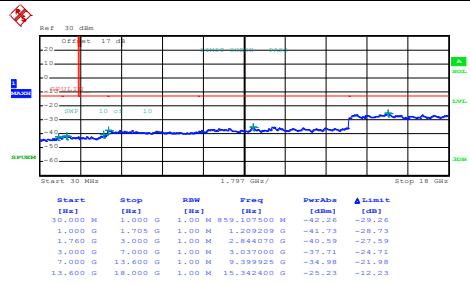

Date: 8.OCT.2020 15:03:27

Highest Channel

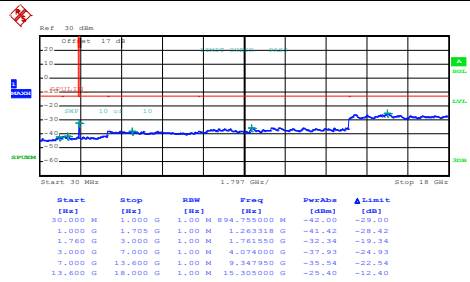

Date: 8.OCT.2020 15:04:24



**Frequency Stability**

Test Conditions	Middle Channel	WCDMA Band V (RMC 12.2Kbps)	Limit 2.5ppm
Temperature (°C)	Voltage (Volt)	Deviation (ppm)	Result
50	Normal Voltage	0.0227	PASS
40	Normal Voltage	0.0179	
30	Normal Voltage	0.0155	
20(Ref.)	Normal Voltage	0.0000	
10	Normal Voltage	0.0000	
0	Normal Voltage	0.0024	
-10	Normal Voltage	0.0036	
-20	Normal Voltage	0.0060	
-30	Normal Voltage	0.0084	
20	Maximum Voltage	0.0155	
20	Normal Voltage	0.0000	
20	Battery End Point	0.0143	

Test Conditions	Middle Channel	WCDMA Band II (RMC 12.2Kbps)	Limit Note 2.
Temperature (°C)	Voltage (Volt)	Deviation (ppm)	Result
50	Normal Voltage	0.0021	PASS
40	Normal Voltage	0.0011	
30	Normal Voltage	0.0005	
20(Ref.)	Normal Voltage	0.0000	
10	Normal Voltage	0.0005	
0	Normal Voltage	0.0016	
-10	Normal Voltage	0.0048	
-20	Normal Voltage	0.0069	
-30	Normal Voltage	0.0080	
20	Maximum Voltage	0.0005	
20	Normal Voltage	0.0000	
20	Battery End Point	0.0011	



Test Conditions	Middle Channel	WCDMA Band IV (RMC 12.2Kbps)	Limit Note 2.
Temperature (°C)	Voltage (Volt)	Deviation (ppm)	Result
50	Normal Voltage	0.0075	PASS
40	Normal Voltage	0.0029	
30	Normal Voltage	0.0017	
20(Ref.)	Normal Voltage	0.0000	
10	Normal Voltage	0.0104	
0	Normal Voltage	0.0127	
-10	Normal Voltage	0.0179	
-20	Normal Voltage	0.0214	
-30	Normal Voltage	0.0231	
20	Maximum Voltage	0.0069	
20	Normal Voltage	0.0000	
20	Battery End Point	0.0040	

**Note:**

1. Normal Voltage = 3.85V. ; Battery End Point (BEP) = 3.6 V. ; Maximum Voltage =4.389 V
2. The frequency fundamental emissions stay within the authorized frequency block.





## Appendix B. Test Results of ERP/EIRP and Radiated Test

### ERP/EIRP

Channel	Mode	Conducted		ERP	
		Power (dBm)	Power (Watts)	ERP(dBm)	ERP(W)
Lowest	WCDMA Band V	24.36	0.2729	22.33	0.1710
Middle	RMC 12.2Kbps	24.45	0.2786	22.42	0.1746
Highest	(GT - LC = 0.12 dB)	24.44	0.2780	22.41	0.1742
Limit	ERP < 7W	Result		PASS	

Channel	Mode	Conducted		EIRP	
		Power (dBm)	Power (Watts)	EIRP(dBm)	EIRP(W)
Lowest	WCDMA Band II	23.45	0.2213	27.51	0.5636
Middle	RMC 12.2Kbps	23.72	0.2355	27.78	0.5998
Highest	(GT - LC = 4.06 dB)	23.56	0.2270	27.62	0.5781
Limit	EIRP < 2W	Result		PASS	

Channel	Mode	Conducted		EIRP	
		Power (dBm)	Power (Watts)	EIRP(dBm)	EIRP(W)
Lowest	WCDMA Band IV	23.64	0.2312	27.20	0.5248
Middle	RMC 12.2Kbps	23.75	0.2371	27.31	0.5383
Highest	(GT - LC = 3.56 dB)	23.66	0.2323	27.22	0.5272
Limit	EIRP < 1W	Result		PASS	



**Radiated Spurious Emission**

<For SIM 1>

**WCDMA 850**

WCDMA 850									
Channel	Frequency ( MHz )	ERP ( dBm )	Limit ( dBm )	Over Limit ( dB )	SPA Reading (dBm)	S.G. Power ( dBm )	TX Cable loss ( dB )	TX Antenna Gain (dBi)	Polarization (H/V)
Lowest	1652	-52.94	-13	-39.94	-63.31	-59.9	0.53	9.63	H
	2479	-44.83	-13	-31.83	-58.72	-52.81	0.65	10.78	H
	3305	-57.27	-13	-44.27	-73.86	-66.38	0.76	12.02	H
	4132	-54.98	-13	-41.98	-72.85	-64.32	0.86	12.35	H
	4958	-54.03	-13	-41.03	-74.72	-63.35	0.73	12.20	H
	1652	-55.30	-13	-42.30	-65.38	-62.26	0.53	9.63	V
	2479	-45.90	-13	-32.90	-60.28	-53.88	0.65	10.78	V
	3305	-55.35	-13	-42.35	-71.89	-64.46	0.76	12.02	V
	4132	-49.49	-13	-36.49	-68.54	-58.83	0.86	12.35	V
	4958	-51.14	-13	-38.14	-71.94	-60.46	0.73	12.20	V
Middle	1672	-53.80	-13	-40.80	-64.32	-60.8	0.53	9.68	H
	2509	-48.34	-13	-35.34	-62.2	-56.34	0.66	10.81	H
	3345	-57.37	-13	-44.37	-74.03	-66.59	0.76	12.14	H
	4182	-53.70	-13	-40.70	-71.64	-63.04	0.84	12.33	H
	5018	-53.95	-13	-40.95	-74.38	-63.09	0.94	12.24	H
	1672	-58.12	-13	-45.12	-68.24	-65.12	0.53	9.68	V
	2509	-51.65	-13	-38.65	-65.92	-59.65	0.66	10.81	V
	3345	-53.75	-13	-40.75	-70.18	-62.97	0.76	12.14	V
	4182	-47.11	-13	-34.11	-66.28	-56.45	0.84	12.33	V
	5018	-50.31	-13	-37.31	-70.92	-59.45	0.94	12.24	V



Highest	1693	-49.66	-13	-36.66	-60.46	-56.7	0.53	9.72	H
	2539	-44.61	-13	-31.61	-58.53	-52.62	0.67	10.82	H
	3386	-56.45	-13	-43.45	-73.19	-65.79	0.77	12.26	H
	4233	-53.46	-13	-40.46	-71.55	-62.78	0.84	12.31	H
	5079	-54.09	-13	-41.09	-74.68	-63.34	0.96	12.36	H
	1693	-56.49	-13	-43.49	-66.65	-63.53	0.53	9.72	V
	2539	-47.97	-13	-34.97	-62.26	-55.98	0.67	10.82	V
	3386	-51.39	-13	-38.39	-67.71	-60.73	0.77	12.26	V
	4233	-45.26	-13	-32.26	-64.6	-54.58	0.84	12.31	V
	5079	-50.92	-13	-37.92	-71.69	-60.17	0.96	12.36	V

Remark: Spurious emissions within 30-1000MHz were found more than 20dB below limit line.



**WCDMA 1700**

WCDMA 1700									
Channel	Frequency ( MHz )	EIRP ( dBm )	Limit ( dBm )	Over Limit ( dB )	SPA Reading (dBm)	S.G. Power ( dBm )	TX Cable loss ( dB )	TX Antenna Gain (dBi)	Polarization (H/V)
Lowest	3426	-51.73	-13	-38.73	-69.27	-63.33	0.77	12.38	H
	5142	-40.26	-13	-27.26	-61.25	-51.77	0.97	12.48	H
	6846	-51.01	-13	-38.01	-75.02	-61.83	0.82	11.64	H
	3426	-54.89	-13	-41.89	-72.33	-66.49	0.77	12.38	V
	5142	-36.61	-13	-23.61	-57.79	-48.12	0.97	12.48	V
	6846	-45.74	-13	-32.74	-70.23	-56.56	0.82	11.64	V
Middle	3468	-53.80	-13	-40.80	-71.37	-65.53	0.78	12.50	H
	5196	-47.37	-13	-34.37	-68.5	-58.97	0.99	12.59	H
	6930	-50.17	-13	-37.17	-74.36	-60.62	1.01	11.45	H
	3468	-55.11	-13	-42.11	-73.2	-66.84	0.78	12.50	V
	5196	-38.92	-13	-25.92	-60.23	-50.52	0.99	12.59	V
	6930	-48.13	-13	-35.13	-72.7	-58.58	1.01	11.45	V
Highest	3504	-46.62	-13	-33.62	-64.22	-58.44	0.78	12.60	H
	5256	-36.91	-13	-23.91	-58.25	-48.61	1.01	12.71	H
	7008	-49.25	-13	-36.25	-73.58	-59.37	1.17	11.29	H
	3504	-49.71	-13	-36.71	-68.27	-61.53	0.78	12.60	V
	5256	-32.95	-13	-19.95	-54.43	-44.65	1.01	12.71	V
	7008	-44.11	-13	-31.11	-68.77	-54.23	1.17	11.29	V

Remark: Spurious emissions within 30-1000MHz were found more than 20dB below limit line.



**WCDMA 1900**

WCDMA 1900									
Channel	Frequency ( MHz )	EIRP ( dBm )	Limit ( dBm )	Over Limit ( dB )	SPA Reading (dBm)	S.G. Power ( dBm )	TX Cable loss ( dB )	TX Antenna Gain (dBi)	Polarization (H/V)
Lowest	3702	-52.70	-13	-39.70	-70.08	-64.49	0.72	12.52	H
	5556	-33.65	-13	-20.65	-56	-45.82	1.00	13.17	H
	7416	-48.38	-13	-35.38	-73.95	-57.75	1.18	10.55	H
	9262.5	-38.95	-13	-25.95	-68.98	-49.43	1.39	11.87	H
	3702	-52.42	-13	-39.42	-71.02	-64.21	0.72	12.52	V
	5556	-38.46	-13	-25.46	-60.94	-50.63	1.00	13.17	V
	7416	-49.92	-13	-36.92	-75.34	-59.29	1.18	10.55	V
	9262.5	-40.44	-13	-27.44	-72.24	-50.92	1.39	11.87	V
Middle	3762	-54.01	-13	-41.01	-71.54	-65.82	0.69	12.50	H
	5640	-36.50	-13	-23.50	-58.82	-48.63	0.98	13.12	H
	7520	-47.01	-13	-34.01	-72.46	-56.29	1.18	10.46	H
	9399	-40.88	-13	-27.88	-70.92	-50.91	1.45	11.48	H
	3762	-55.31	-13	-42.31	-74.04	-67.12	0.69	12.50	V
	5640	-41.05	-13	-28.05	-63.55	-53.18	0.98	13.12	V
	7520	-47.18	-13	-34.18	-72.68	-56.46	1.18	10.46	V
	9399	-38.52	-13	-25.52	-70.35	-48.55	1.45	11.48	V
Highest	3816	-54.92	-13	-41.92	-72.57	-66.71	0.69	12.47	H
	5718	-36.25	-13	-23.25	-58.65	-48.33	0.99	13.07	H
	7632	-48.08	-13	-35.08	-73.79	-57.67	1.18	10.77	H
	9535.5	-39.35	-13	-26.35	-69.62	-48.96	1.65	11.26	H
	3816	-55.31	-13	-42.31	-74.17	-67.1	0.69	12.47	V
	5718	-37.41	-13	-24.41	-60.01	-49.49	0.99	13.07	V
	7632	-50.05	-13	-37.05	-75.49	-59.64	1.18	10.77	V
	9535.5	-38.74	-13	-25.74	-70.37	-48.35	1.65	11.26	V

Remark: Spurious emissions within 30-1000MHz were found more than 20dB below limit line.