



FCC RADIO TEST REPORT

FCC ID : UZ7DS2278A
Equipment : Cordless 1D/2D Handheld Imager
Brand Name : Zebra
Model Name : DS2278A
Applicant : Zebra Technologies Corporation
1 Zebra Plaza, Holtsville, NY 11742
Manufacturer : Zebra Technologies Corporation
1 Zebra Plaza, Holtsville, NY 11742
Standard : FCC Part 15 Subpart C §15.247

The product was received on Mar. 02, 2023 and testing was performed from Mar. 17, 2023 to Mar. 30, 2023. We, Sporton International Inc. Wensan Laboratory, would like to declare that the tested sample has been evaluated in accordance with the test procedures and has been in compliance with the applicable technical standards.

The test results in this report apply exclusively to the tested model / sample. Without written approval from Sporton International Inc. Wensan Laboratory, the test report shall not be reproduced except in full.

Approved by: Louis Wu

Sporton International Inc. Wensan Laboratory

No.58, Aly. 75, Ln. 564, Wenhua 3rd, Rd., Guishan Dist., Taoyuan City 333010, Taiwan (R.O.C.)



Table of Contents

History of this test report.....	3
Summary of Test Result.....	4
1 General Description.....	5
1.1 Product Feature of Equipment Under Test.....	5
1.2 Product Specification of Equipment Under Test.....	5
1.3 Modification of EUT	6
1.4 Testing Location	6
1.5 Applicable Standards.....	6
2 Test Configuration of Equipment Under Test.....	7
2.1 Carrier Frequency Channel	7
2.2 Test Mode.....	8
2.3 Connection Diagram of Test System.....	9
2.4 Support Unit used in test configuration and system	10
2.5 EUT Operation Test Setup	10
2.6 Measurement Results Explanation Example.....	10
3 Test Result.....	11
3.1 6dB and 99% Bandwidth Measurement	11
3.2 Output Power Measurement.....	12
3.3 Power Spectral Density Measurement	13
3.4 Conducted Band Edges and Spurious Emission Measurement	14
3.5 Radiated Band Edges and Spurious Emission Measurement	15
3.6 AC Conducted Emission Measurement.....	19
3.7 Antenna Requirements.....	21
4 List of Measuring Equipment	22
5 Uncertainty of Evaluation.....	23
Appendix A. Conducted Test Results	
Appendix B. AC Conducted Emission Test Result	
Appendix C. Radiated Spurious Emission	
Appendix D. Radiated Spurious Emission Plots	
Appendix E. Duty Cycle Plots	
Appendix F. Setup Photographs	



History of this test report

Report No.	Version	Description	Issue Date
FR720928-02	01	Initial issue of report	Apr. 14, 2023
FR720928-02	02	<ol style="list-style-type: none">Revise Output Power MeasurementThis report is an updated version, replacing the report issued on Apr. 14, 2023.	Apr. 17, 2023



Summary of Test Result

Report Clause	Ref Std. Clause	Test Items	Result (PASS/FAIL)	Remark
3.1	15.247(a)(2)	6dB Bandwidth	Pass	-
3.1	2.1049	99% Occupied Bandwidth	Reporting only	-
3.2	15.247(b)(3) 15.247(b)(4)	Output Power	Pass	-
3.3	15.247(e)	Power Spectral Density	Pass	-
3.4	15.247(d)	Conducted Band Edges and Spurious Emission	Pass	-
3.5	15.247(d)	Radiated Band Edges and Spurious Emission	Pass	3.41 dB under the limit at 666.320 MHz
3.6	15.207	AC Conducted Emission	Pass	7.97 dB under the limit at 12.968 MHz
3.7	15.203	Antenna Requirement	Pass	-

Conformity Assessment Condition:

1. The test results (PASS/FAIL) with all measurement uncertainty excluded are presented against the regulation limits or in accordance with the requirements stipulated by the applicant/manufacture who shall bear all the risks of non-compliance that may potentially occur if measurement uncertainty is taken into account.
2. Please refer to the section " Uncertainty of Evaluation " for measurement uncertainty.

Disclaimer:

The product specifications of the EUT presented in the test report that may affect the test assessments are declared by the manufacturer who shall take full responsibility for the authenticity.

Reviewed by: Wei Chen

Report Producer: Ming Chen



1 General Description

1.1 Product Feature of Equipment Under Test

Product Feature	
Equipment	Cordless 1D/2D Handheld Imager
Brand Name	Zebra
Model Name	DS2278A
FCC ID	UZ7CR2278A
EUT supports Radios application	Bluetooth-LE
HW Version	DV
MFD	02DEC22
EUT Stage	Identical Prototype

Remark: The EUT's information above is declared by manufacturer.

Specification of Accessories				
5V Adapter	Brand Name	Zebra	Part Number	PWR-WUA5V4W0US
RJ-50-RS232 Cable	Brand Name	Zebra	Model Name	CBA-R01-S07PBR
RJ-50 to USB Cable	Brand Name	Zebra	Model Name	CBA-U21-S07ZBR
Battery	Brand Name	Zebra	Model Name	BT-000317-01

Support Unit used in test configuration and system				
Presentation Cradle	Brand Name	Zebra	Part Number	CR2278A

1.2 Product Specification of Equipment Under Test

Product Specification is subject to this standard	
Tx/Rx Frequency Range	2402 MHz ~ 2480 MHz
Number of Channels	40
Carrier Frequency of Each Channel	40 Channel (37 hopping + 3 advertising channel)
Maximum Output Power to Antenna	Bluetooth – LE: 2.38 dBm / 0.0017 W
99% Occupied Bandwidth	1.051 MHz
Antenna Type / Gain	Printed Circuit Antenna type with gain 2.96 dBi
Type of Modulation	Bluetooth LE : GFSK

Remark: The above EUT's information was declared by manufacturer. Please refer to Disclaimer in report summary.



1.3 Modification of EUT

No modifications made to the EUT during the testing.

1.4 Testing Location

Test Site	Sporton International Inc. Wensan Laboratory
Test Site Location	No.58, Aly. 75, Ln. 564, Wenhua 3rd, Rd., Guishan Dist., Taoyuan City 333010, Taiwan (R.O.C.) TEL: +886-3-327-0868 FAX: +886-3-327-0855
Test Site No.	Sporton Site No. TH05-HY, CO07-HY, 03CH22-HY

Note: The test site complies with ANSI C63.4 2014 requirement.

FCC designation No.: TW3786

1.5 Applicable Standards

According to the specifications declared by the manufacturer, the EUT must comply with the requirements of the following standards:

- ♦ FCC Part 15 Subpart C §15.247
- ♦ FCC KDB Publication No. 558074 D01 15.247 Meas Guidance v05r02
- ♦ FCC KDB 414788 D01 Radiated Test Site v01r01
- ♦ ANSI C63.10-2013

Remark:

1. All the test items were validated and recorded in accordance with the standards without any modification during the testing.
2. The TAF code is not including all the FCC KDB listed without accreditation.
3. This EUT has also been tested and complied with the requirements of FCC Part 15, Subpart B, recorded in a separate test report.



2 Test Configuration of Equipment Under Test

2.1 Carrier Frequency Channel

Frequency Band	Channel	Freq. (MHz)	Channel	Freq. (MHz)
2400-2483.5 MHz	0	2402	21	2444
	1	2404	22	2446
	2	2406	23	2448
	3	2408	24	2450
	4	2410	25	2452
	5	2412	26	2454
	6	2414	27	2456
	7	2416	28	2458
	8	2418	29	2460
	9	2420	30	2462
	10	2422	31	2464
	11	2424	32	2466
	12	2426	33	2468
	13	2428	34	2470
	14	2430	35	2472
	15	2432	36	2474
	16	2434	37	2476
	17	2436	38	2478
	18	2438	39	2480
	19	2440	-	-
20	2442	-	-	



2.2 Test Mode

- a. The EUT has been associated with peripherals and configuration operated in a manner tended to maximize its emission characteristics in a typical application. Frequency range investigated: conduction emission (150 kHz to 30 MHz), radiation emission (9 kHz to the 10th harmonic of the highest fundamental frequency or to 40 GHz, whichever is lower). For radiated measurement, the measured emission level of the EUT was maximized by rotating the EUT on a turntable, adjusting the orientation of the EUT and EUT antenna in three orthogonal axis (X: flat, Y: portrait, Z: landscape), and adjusting the measurement antenna orientation, following C63.10 exploratory test procedures and only the worst case emissions were reported in this report.
- b. AC power line Conducted Emission was tested under maximum output power.

The following summary table is showing all test modes to demonstrate in compliance with the standard.

Summary table of Test Cases	
Test Item	Data Rate / Modulation
Conducted Test Cases	Bluetooth – LE / GFSK
	Mode 1: Bluetooth Tx CH00_2402 MHz_1Mbps
	Mode 2: Bluetooth Tx CH19_2440 MHz_1Mbps
	Mode 3: Bluetooth Tx CH39_2480 MHz_1Mbps
Radiated Test Cases	Mode 1: Bluetooth Tx CH00_2402 MHz_1Mbps
	Mode 2: Bluetooth Tx CH19_2440 MHz_1Mbps
	Mode 3: Bluetooth Tx CH39_2480 MHz_1Mbps
AC Conducted Emission	Mode 1: Bluetooth Link between Cradle and EUT + Scanner Scan Bar Code + RJ-50-RS232 cable + 5V Adapter + RS232 Data Link with Notebook
Remark:	
1. For radiation spurious emission, the modulation and the data rate picked for testing are determined by the Max. RF conducted power.	
2. Data Link with Notebook means data application transferred mode between EUT and Notebook.	

2.3 Connection Diagram of Test System

<AC Conducted Emission Mode>

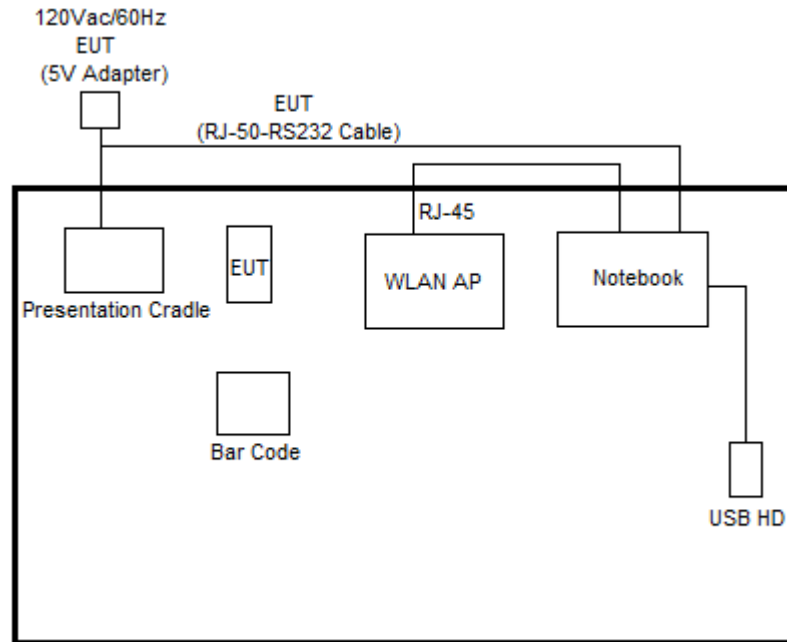

<Bluetooth – LE Tx Mode>





2.4 Support Unit used in test configuration and system

Item	Equipment	Brand Name	Model Name	FCC ID	Data Cable	Power Cord
1.	WLAN AP	ASUS	RT-AC52	N/A	N/A	Unshielded, 1.8 m
2.	Notebook	DELL	Latitude 3400	FCC DoC	N/A	AC I/P: Unshielded, 1.2 m DC O/P: Shielded, 1.8 m
3.	USB HD	WD	WDBAGPU0010 BBK	FCC DoC	Shielded, 0.5 m	N/A
4.	Bar Code	N/A	N/A	N/A	N/A	N/A

2.5 EUT Operation Test Setup

The RF test items, utility “BT Regulatory test App 1.3.8.1” was installed in Notebook which was programmed in order to make the EUT get into the engineering modes to provide channel selection, power level, data rate and the application type and for continuous transmitting signals.

2.6 Measurement Results Explanation Example

For all conducted test items:

The offset level is set in the spectrum analyzer to compensate the RF cable loss and attenuator factor between EUT conducted output port and spectrum analyzer. With the offset compensation, the spectrum analyzer reading level is exactly the EUT RF output level.

Example :

The spectrum analyzer offset is derived from RF cable loss and attenuator factor.

Offset = RF cable loss + attenuator factor.

Following shows an offset computation example with cable loss 4.2 dB and 10 dB attenuator.

$$\begin{aligned} \text{Offset(dB)} &= \text{RF cable loss(dB)} + \text{attenuator factor(dB)}. \\ &= 4.2 + 10 = 14.2 \text{ (dB)} \end{aligned}$$

3 Test Result

3.1 6dB and 99% Bandwidth Measurement

3.1.1 Limit of 6dB and 99% Bandwidth

The minimum 6 dB bandwidth shall be at least 500 kHz.

3.1.2 Measuring Instruments

Please refer to the measuring equipment list in this test report.

3.1.3 Test Procedures

1. The testing follows the ANSI C63.10 Section 6.9.3 (OBW) and 11.8.1 (6dB BW).
2. The RF output of EUT is connected to the spectrum analyzer by RF cable and attenuator. The path loss is compensated to the results for each measurement.
3. Set the maximum power setting and enable the EUT to transmit continuously.
4. Make the measurement with the spectrum analyzer's resolution bandwidth (RBW) = 100 kHz. Set the Video bandwidth (VBW) = 300 kHz. In order to make an accurate measurement. The 6dB bandwidth must be greater than 500 kHz.
5. For 99% Bandwidth Measurement, the spectrum analyzer's resolution bandwidth (RBW) is set 1-5% of the emission bandwidth and set the Video bandwidth (VBW) $\geq 3 * RBW$.
6. Measure and record the results in the test report.

3.1.4 Test Setup



3.1.5 Test Result of 6dB Bandwidth

Please refer to Appendix A.

3.1.6 Test Result of 99% Occupied Bandwidth

Please refer to Appendix A.

3.2 Output Power Measurement

3.2.1 Limit of Output Power

For systems using digital modulation in the 2400-2483.5 MHz, the limit for output power is 30 dBm. If transmitting antenna of directional gain greater than 6 dBi is used, the peak output power from the intentional radiator shall be reduced below the above stated value by the amount in dB that the directional gain of the antenna exceeds 6 dBi. In case of point-to-point operation, the limit has to be reduced by 1 dB for every 3 dB that the directional gain of the antenna exceeds 6 dBi.

3.2.2 Measuring Instruments

Please refer to the measuring equipment list in this test report.

3.2.3 Test Procedures

1. For Average Power, the testing follows ANSI C63.10 Section 11.9.2.3.2 Method AVGP-M-G
2. The RF output of EUT is connected to the power meter by RF cable and attenuator.
3. The path loss is compensated to the results for each measurement.
4. Set the maximum power setting and enable the EUT to transmit continuously.
5. Measure the conducted output power and record the results in the test report.

3.2.4 Test Setup

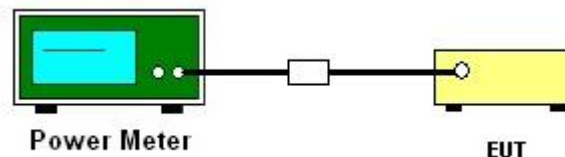

3.2.5 Test Result of Average Output Power

Please refer to Appendix A.

3.3 Power Spectral Density Measurement

3.3.1 Limit of Power Spectral Density

The peak power spectral density shall not be greater than 8 dBm in any 3 kHz band at any time interval of continuous transmission.

3.3.2 Measuring Instruments

Please refer to the measuring equipment list in this test report.

3.3.3 Test Procedures

1. The testing follows the ANSI C63.10 Section 11.10.2 Method PKPSD.
2. The RF output of EUT is connected to the spectrum analyzer by RF cable and attenuator. The path loss is compensated to the results for each measurement.
3. Set the maximum power setting and enable the EUT to transmit continuously.
4. Make the measurement with the spectrum analyzer's resolution bandwidth (RBW) = 3 kHz. Video bandwidth (VBW) = 10 kHz. In order to make an accurate measurement, set the span to 1.5 times DTS Channel Bandwidth. (6 dB BW)
5. Detector = peak, Sweep time = auto couple, Trace mode = max hold, Allow trace to fully stabilize. Use the peak marker function to determine the maximum power level.
6. Measure and record the results in the test report.
7. The Measured power density (dBm)/ 100 kHz is a reference level and is used as 20 dBc down limit line for Conducted Band Edges and Conducted Spurious Emission.

3.3.4 Test Setup

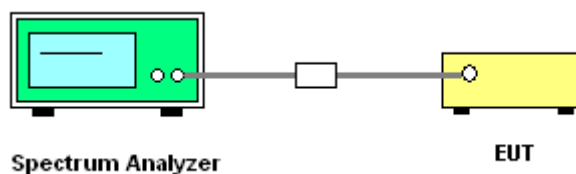

3.3.5 Test Result of Power Spectral Density

Please refer to Appendix A.

3.3.6 Test Result of Power Spectral Density Plots (100kHz)

Please refer to Appendix A.

3.3.7 Test Result of Power Spectral Density Plots (3kHz)

Please refer to Appendix A.

3.4 Conducted Band Edges and Spurious Emission Measurement

3.4.1 Limit of Conducted Band Edges and Spurious Emission

All harmonics/spurious must be at least 30 dB down from the highest emission level within the authorized band.

3.4.2 Measuring Instruments

Please refer to the measuring equipment list in this test report.

3.4.3 Test Procedure

1. The testing follows the ANSI C63.10 Section 11.11.3 Emission level measurement.
2. The RF output of EUT is connected to the spectrum analyzer by RF cable and attenuator. The path loss is compensated to the results for each measurement.
3. Set the maximum power setting and enable the EUT to transmit continuously.
4. Set RBW = 100 kHz, VBW = 300 kHz, Peak Detector. Unwanted Emissions measured in any 100 kHz bandwidth outside of the authorized frequency band shall be attenuated by at least 20 dB relative to the maximum in-band peak PSD level in 100 kHz when maximum peak conducted output power procedure is used. If the transmitter complies with the conducted power limits based on the use of RMS averaging over a time interval, the attenuation required under this paragraph shall be 30 dB instead of 20 dB.
5. Measure and record the results in the test report.
6. The RF fundamental frequency should be excluded against the limit line in the operating frequency band.

3.4.4 Test Setup

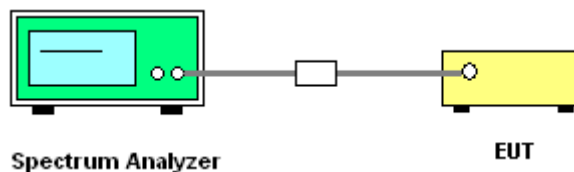

3.4.5 Test Result of Conducted Band Edges Plots

Please refer to Appendix A.

3.4.6 Test Result of Conducted Spurious Emission Plots

Please refer to Appendix A.



3.5 Radiated Band Edges and Spurious Emission Measurement

3.5.1 Limit of Radiated Band Edges and Spurious Emission

In any 100 kHz bandwidth outside the intentional radiator frequency band, all harmonics/spurious must be at least 20 dB below the highest emission level within the authorized band. If the output power of this device is measured by spectrum analyzer, the attenuation under this paragraph shall be 30 dB instead of 20 dB. In addition, radiated emissions which fall in the restricted bands must also comply with the limits as below.

Frequency (MHz)	Field Strength (microvolts/meter)	Measurement Distance (meters)
0.009 – 0.490	2400/F(kHz)	300
0.490 – 1.705	24000/F(kHz)	30
1.705 – 30.0	30	30
30 – 88	100	3
88 – 216	150	3
216 - 960	200	3
Above 960	500	3

3.5.2 Measuring Instruments

Please refer to the measuring equipment list in this test report.



3.5.3 Test Procedures

1. The testing follows the ANSI C63.10 Section 11.12.1 Radiated emission measurements.
2. The EUT is arranged to its worst case and then tune the antenna tower (from 1 m to 4 m) and turntable (from 0 degree to 360 degrees) to find the maximum reading. A pre-amp and a high pass filter are used for the test in order to get better signal level.
3. The EUT is placed on a turntable with 0.8 meter for frequency below 1 GHz and 1.5 meter for frequency above 1 GHz respectively above ground.
4. The EUT is set 3 meters away from the receiving antenna, which is mounted on the top of a variable height antenna tower.
5. Corrected Reading: Antenna Factor + Cable Loss + Read Level - Preamp Factor = Level
6. Radiated testing below 1 GHz is performed by adjusting the antenna tower from 1 m to 4 m and by rotating the turn table from 0 degree to 360 degrees to find the peak maximum hold reading. When there is no suspected emission found and the emission level is with at least 6 dB margin against QP limit line, the position is marked as “-“.
7. Radiated testing above 1 GHz is performed by adjusting the antenna tower from 1 m to 4 m and by rotating the turn table from 0 degree to 360 degrees to find the peak maximum hold reading for scanning all frequencies. When there is no suspected emission found and the harmonic emission level is with at least 6 dB margin against average limit line, the position is marked as “-“.
8. Use the following spectrum analyzer settings:
 - (1) Span shall wide enough to fully capture the emission being measured;
 - (2) Set RBW = 100 kHz for $f < 1$ GHz; VBW \geq RBW; Sweep = auto; Detector function = peak; Trace = max hold;
 - (3) Set RBW = 1 MHz, VBW = 3 MHz for $f \geq 1$ GHz for peak measurement.
For average measurement:
 - VBW = 10 Hz, when duty cycle is no less than 98 percent.
 - VBW $\geq 1/T$, when duty cycle is less than 98 percent where T is the minimum transmission duration over which the transmitter is on and is transmitting at its maximum power control level for the tested mode of operation.

3.5.4 Test Setup

For radiated test below 30MHz

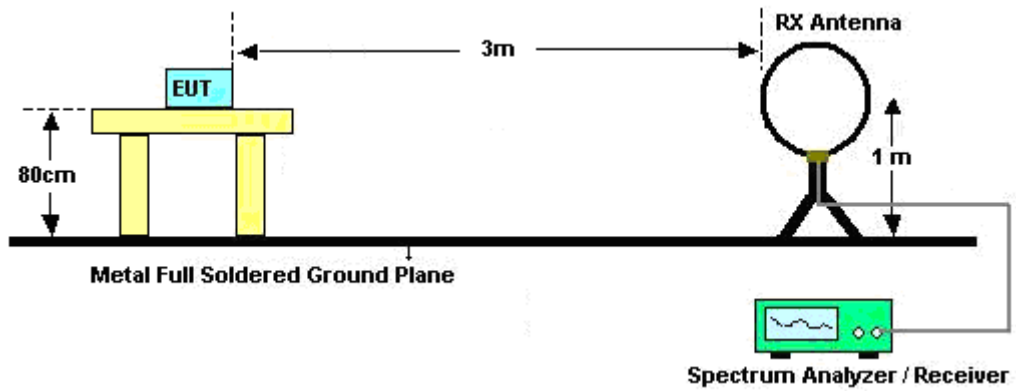

For radiated test from 30MHz to 1GHz

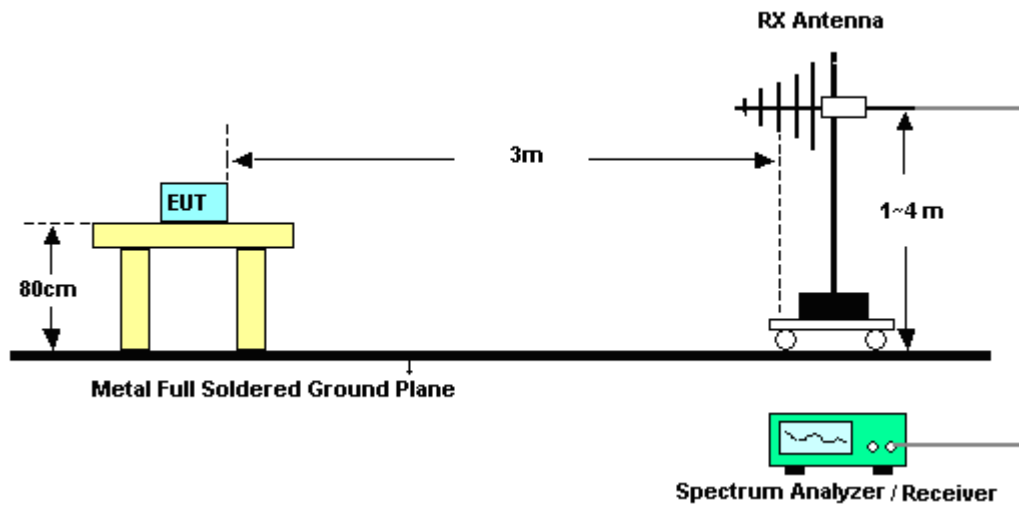

For radiated test from 1GHz to 18GHz

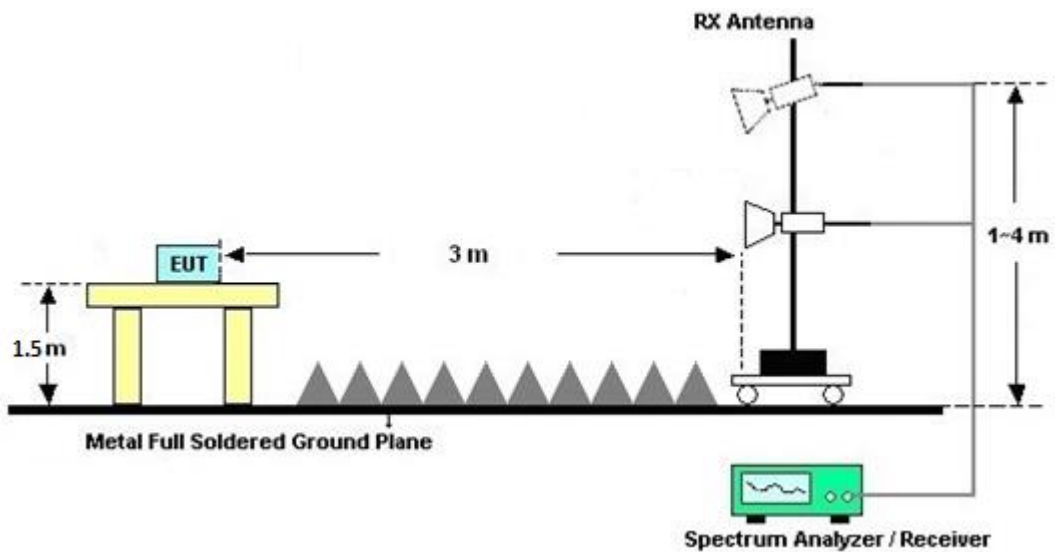

For radiated test above 18GHz

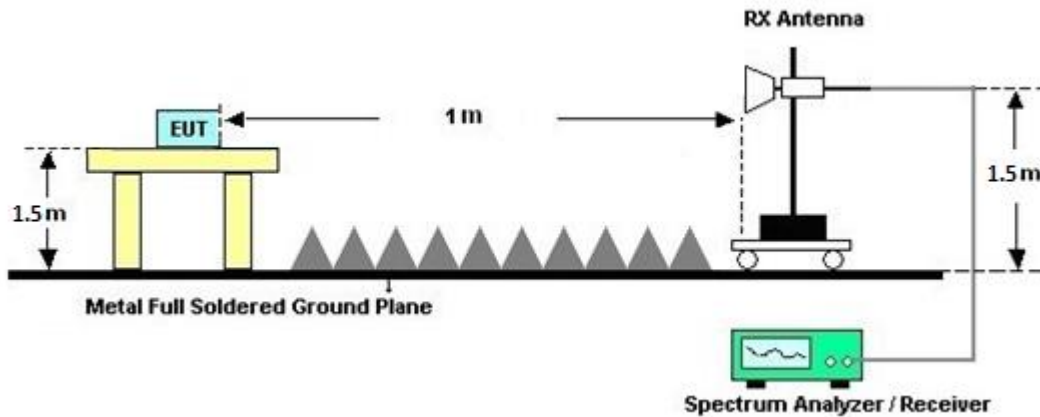

3.5.5 Test Results of Radiated Spurious Emissions (9 kHz ~ 30 MHz)

The low frequency, which starts from 9 kHz to 30 MHz, is pre-scanned and the result which is 20 dB lower than the limit line is not reported.

There is adequate comparison measurement of both open-field test site and alternative test site - semi-Anechoic chamber according to 414788 D01 Radiated Test Site v01r01, and the result comes out very similar.

3.5.6 Test Result of Radiated Spurious at Band Edges

Please refer to Appendix C and D.

3.5.7 Duty Cycle

Please refer to Appendix E.

3.5.8 Test Result of Radiated Spurious Emission (30 MHz ~ 10th Harmonic)

Please refer to Appendix C and D.



3.6 AC Conducted Emission Measurement

3.6.1 Limit of AC Conducted Emission

For equipment that is designed to be connected to the public utility (AC) power line, the radio frequency voltage that is conducted back onto the AC power line on any frequency or frequencies within the band 150 kHz to 30 MHz shall not exceed the limits in the following table.

Frequency of emission (MHz)	Conducted limit (dB μ V)	
	Quasi-peak	Average
0.15-0.5	66 to 56*	56 to 46*
0.5-5	56	46
5-30	60	50

*Decreases with the logarithm of the frequency.

3.6.2 Measuring Instruments

Please refer to the measuring equipment list in this test report.

3.6.3 Test Procedures

1. The EUT is placed 0.4 meter away from the conducting wall of the shielding room, and is kept at least 80 centimeters from any other grounded conducting surface.
2. Connect EUT to the power mains through a line impedance stabilization network (LISN).
3. All the support units are connecting to the other LISN.
4. The LISN provides 50 ohm coupling impedance for the measuring instrument.
5. The FCC states that a 50 ohm, 50 microhenry LISN shall be used.
6. Both Line and Neutral shall be tested in order to find out the maximum conducted emission.
7. The frequency range from 150 kHz to 30 MHz is scanned.
8. Set the test-receiver system to Peak Detect Function and specified bandwidth (IF Bandwidth = 9 kHz) with Maximum Hold Mode. Then measurement is also conducted by Average Detector and Quasi-Peak Detector Function respectively.

3.6.4 Test Setup

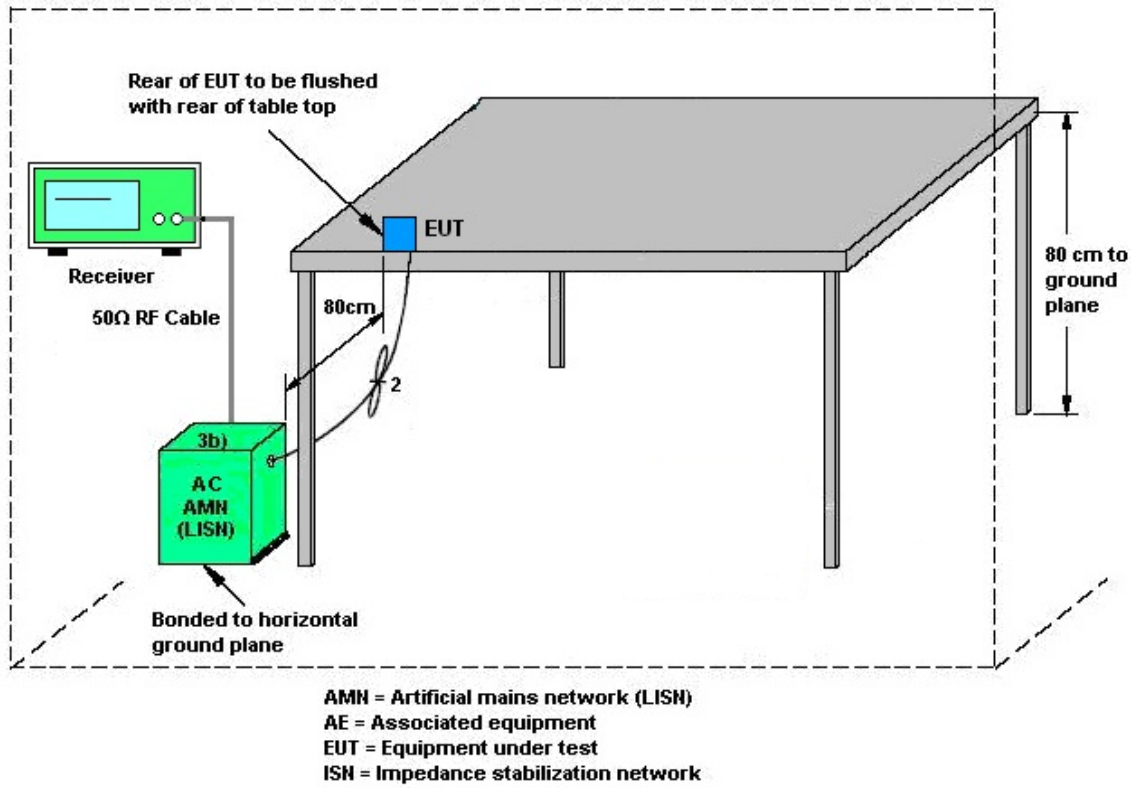

3.6.5 Test Result of AC Conducted Emission

Please refer to Appendix B.



3.7 Antenna Requirements

3.7.1 Standard Applicable

The use of a permanently attached antenna or of an antenna that uses a unique coupling to the intentional radiator shall be considered sufficient to comply with the rule.

3.7.2 Antenna Anti-Replacement Construction

An embedded-in antenna design is used.



4 List of Measuring Equipment

Instrument	Brand Name	Model No.	Serial No.	Characteristics	Calibration Date	Test Date	Due Date	Remark
Loop Antenna	Rohde & Schwarz	HFH2-Z2	100488	9 kHz~30 MHz	Sep. 20, 2022	Mar.28, 2023~ Mar. 30, 2023	Sep. 19, 2023	Radiation (03CH22-HY)
Bilog Antenna with 6dB pad	TESEQ & WOKEN	CBL 6111D & 00802N1D-06	63304 & 002	N/A	Oct. 04, 2022	Mar. 28, 2023~ Mar. 30, 2023	Oct. 03, 2023	Radiation (03CH22-HY)
Amplifier	SONOMA	310N	421581	N/A	Jul. 16, 2022	Mar. 28, 2023~ Mar. 30, 2023	Jul. 15, 2023	Radiation (03CH22-HY)
Double Ridged Guide Horn Antenna	RFSPIN	DRH18-E	LE2C05A18E N	1GHz~18GHz	Jul. 06, 2022	Mar. 28, 2023~ Mar. 30, 2023	Jul. 05, 2023	Radiation (03CH22-HY)
SHF-EHF Horn Antenna	SCHWARZBECK	BBHA9170	00991	18GHz~40GHz	May 14, 2022	Mar. 28, 2023~ Mar. 30, 2023	May 13, 2023	Radiation (03CH22-HY)
Amplifier	EMEC	EM01G18GA	060877	N/A	Sep. 29, 2022	Mar. 28, 2023~ Mar. 30, 2023	Sep. 28, 2023	Radiation (03CH22-HY)
Preamplifier	EMEC	EM18G40G	060872	18-40GHz	Sep. 28, 2022	Mar. 28, 2023~ Mar. 30, 2023	Sep. 27, 2023	Radiation (03CH22-HY)
Signal Analyzer	Keysight	N9010B	MY60241058	N/A	Jul. 07, 2022	Mar. 28, 2023~ Mar. 30, 2023	Jul. 06, 2023	Radiation (03CH22-HY)
Hygrometer	TECPEL	DTM-303B	TP140325	N/A	Nov. 07, 2022	Mar. 28, 2023~ Mar. 30, 2023	Nov. 06, 2023	Radiation (03CH22-HY)
Controller	EMEC	EM1000	N/A	Control Turn table & Ant Mast	N/A	Mar. 28, 2023~ Mar. 30, 2023	N/A	Radiation (03CH22-HY)
Antenna Mast	ChainTek	MBS-520-1	N/A	1m~4m	N/A	Mar. 28, 2023~ Mar. 30, 2023	N/A	Radiation (03CH22-HY)
Turn Table	ChainTek	T-200-S-1	N/A	0~360 Degree	N/A	Mar. 28, 2023~ Mar. 30, 2023	N/A	Radiation (03CH22-HY)
Software	Audix	E3 6.09824_2019 122	RK-002347	N/A	N/A	Mar. 28, 2023~ Mar. 30, 2023	N/A	Radiation (03CH22-HY)
RF Cable	HUBER + SUHNER	SUCOFLEX 102	803951/2	9kHz~30MHz	Mar. 07, 2023	Mar. 28, 2023~ Mar. 30, 2023	Mar. 06, 2024	Radiation (03CH22-HY)
RF Cable	HUBER + SUHNER	SUCOFLEX 102	804390/2,804 611/2,804615/ 2	N/A	Oct. 25, 2022	Mar.28, 2023~ Mar. 30, 2023	Oct. 24, 2023	Radiation (03CH22-HY)
AC Power Source	ACPOWER	AFC-11003G	F317040033	N/A	N/A	Mar. 23, 2023	N/A	Conduction (CO07-HY)
Software	Rohde & Schwarz	EMC32 V10.30	N/A	N/A	N/A	Mar. 23, 2023	N/A	Conduction (CO07-HY)
Pulse Limiter	SCHWARZBECK	VTSD 9561-F N	9561-F N00373	9kHz~200MHz	Nov. 01, 2022	Mar. 23, 2023	Oct. 31, 2023	Conduction (CO07-HY)
RF Cable	HUBER + SUHNER	RG 214/U	1358175	9kHz~30MHz	Mar. 15, 2023	Mar. 23, 2023	Mar. 14, 2024	Conduction (CO07-HY)
Two-Line V-Network	TESEQ	NNB 51	45051	N/A	Mar. 05, 2023	Mar. 23, 2023	Mar. 04, 2024	Conduction (CO07-HY)
Four-Line V-Network	TESEQ	NNB 52	36122	N/A	Mar. 13, 2023	Mar. 23, 2023	Mar. 12, 2024	Conduction (CO07-HY)
EMI Test Receiver	Rohde & Schwarz	ESR3	102317	9kHz~3.6GHz	Oct. 06, 2022	Mar. 23, 2023	Oct. 05, 2023	Conduction (CO07-HY)
Hygrometer	TECPEL	DTM-303A	TP201996	N/A	Nov. 17, 2022	Mar. 17, 2023~ Mar. 27, 2023	Nov. 16, 2023	Conducted (TH05-HY)
Power Sensor	DARE	RPR3006W	16I00054SNO 12 (NO:113)	10MHz~6GHz	Dec. 13, 2022	Mar. 17, 2023~ Mar. 27, 2023	Dec. 12, 2023	Conducted (TH05-HY)
Signal Analyzer	Rohde & Schwarz	FSV40	101905	10Hz - 40GHz(amp)	Aug. 03, 2022	Mar. 17, 2023~ Mar. 27, 2023	Aug. 02, 2023	Conducted (TH05-HY)



5 Uncertainty of Evaluation

Uncertainty of Conducted Emission Measurement (150 kHz ~ 30 MHz)

Measuring Uncertainty for a Level of Confidence of 95% ($U = 2Uc(y)$)	3.46 dB
---	---------

Uncertainty of Radiated Emission Measurement (30 MHz ~ 1000 MHz)

Measuring Uncertainty for a Level of Confidence of 95% ($U = 2Uc(y)$)	5.92 dB
---	---------

Uncertainty of Radiated Emission Measurement (1000 MHz ~ 6000 MHz)

Measuring Uncertainty for a Level of Confidence of 95% ($U = 2Uc(y)$)	4.42 dB
---	---------

Uncertainty of Radiated Emission Measurement (6000 MHz ~ 18000 MHz)

Measuring Uncertainty for a Level of Confidence of 95% ($U = 2Uc(y)$)	4.40 dB
---	---------

Uncertainty of Radiated Emission Measurement (18000 MHz ~ 40000 MHz)

Measuring Uncertainty for a Level of Confidence of 95% ($U = 2Uc(y)$)	5.38 dB
---	---------

Appendix A. Test Result of Conducted Test Items

Test Engineer:	Hank Hsu	Temperature:	21~25	°C
Test Date:	2023/3/17~3/27	Relative Humidity:	51~54	%

TEST RESULTS DATA								
<u>6dB and 99% Occupied Bandwidth</u>								
Mod.	Data Rate	NTX	CH.	Freq. (MHz)	99% Occupied BW (MHz)	6dB BW (MHz)	6dB BW Limit (MHz)	Pass/Fail
BLE	1Mbps	1	0	2402	1.051	0.716	0.50	Pass
BLE	1Mbps	1	19	2440	1.049	0.714	0.50	Pass
BLE	1Mbps	1	39	2480	1.051	0.716	0.50	Pass

TEST RESULTS DATA										
<u>Average Power Table</u>										
Mod.	Data Rate	NTX	CH.	Freq. (MHz)	Average Conducted Power (dBm)	Conducted Power Limit (dBm)	DG (dBi)	EIRP Power (dBm)	EIRP Power Limit (dBm)	Pass /Fail
BLE	1Mbps	1	0	2402	2.18	30.00	2.96	5.14	36.00	Pass
BLE	1Mbps	1	19	2440	2.38	30.00	2.96	5.34	36.00	Pass
BLE	1Mbps	1	39	2480	2.38	30.00	2.96	5.34	36.00	Pass

TEST RESULTS DATA									
<u>Peak Power Density</u>									
Mod.	Data Rate	NTX	CH.	Freq. (MHz)	Peak PSD (dBm /100kHz)	Peak PSD (dBm /3kHz)	DG (dBi)	Peak PSD Limit (dBm /3kHz)	Pass/Fail
BLE	1Mbps	1	0	2402	1.42	-11.80	2.96	8.00	Pass
BLE	1Mbps	1	19	2440	1.32	-11.94	2.96	8.00	Pass
BLE	1Mbps	1	39	2480	1.89	-11.39	2.96	8.00	Pass

Note: PSD (dBm/ 100kHz) is a reference level used for Conducted Band Edges and Conducted Spurious Emission 30dBc limit.



6dB Bandwidth

<1Mbps>

6 dB Bandwidth Plot on Channel 00

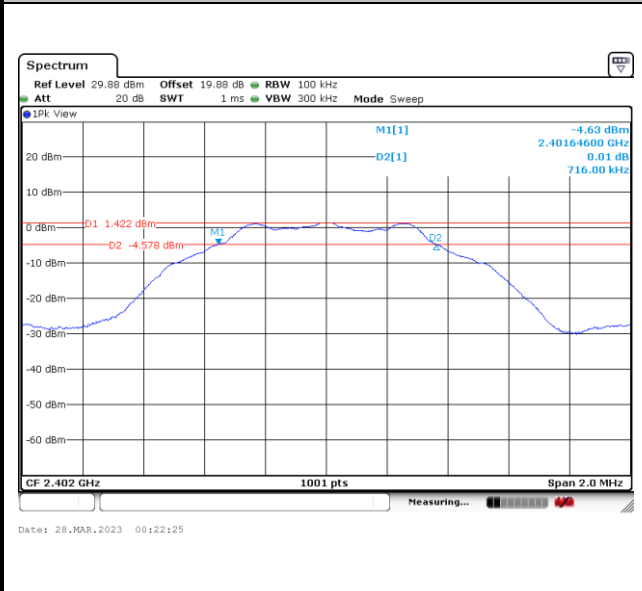

6 dB Bandwidth Plot on Channel 19

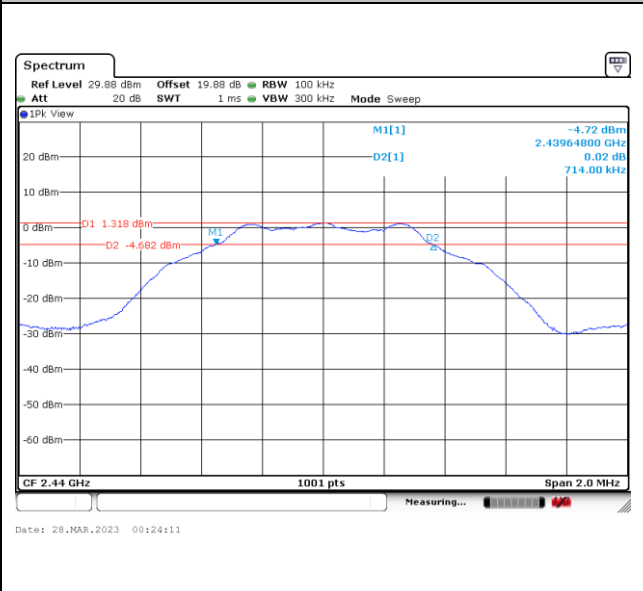

6 dB Bandwidth Plot on Channel 39

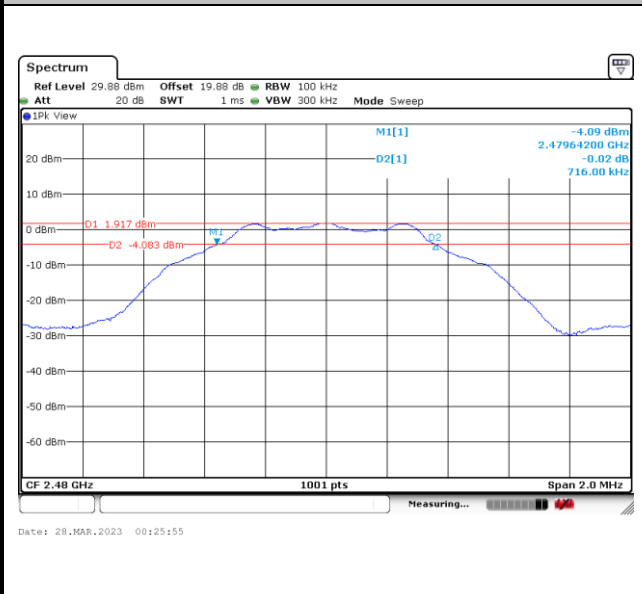



99% Occupied Bandwidth

<1Mbps>

99% Occupied Bandwidth Plot on Channel 00

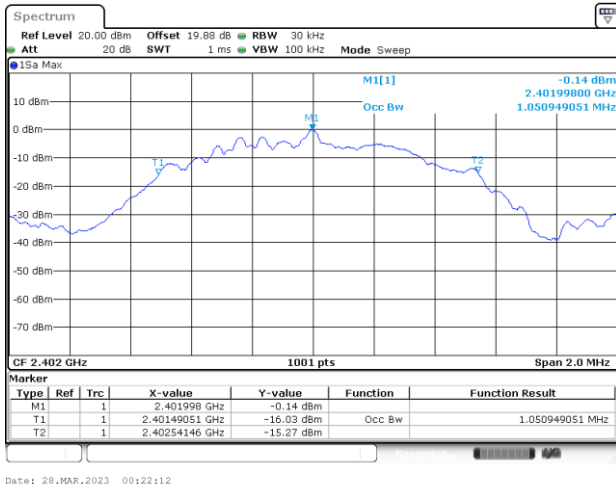

99% Occupied Plot Bandwidth on Channel 19

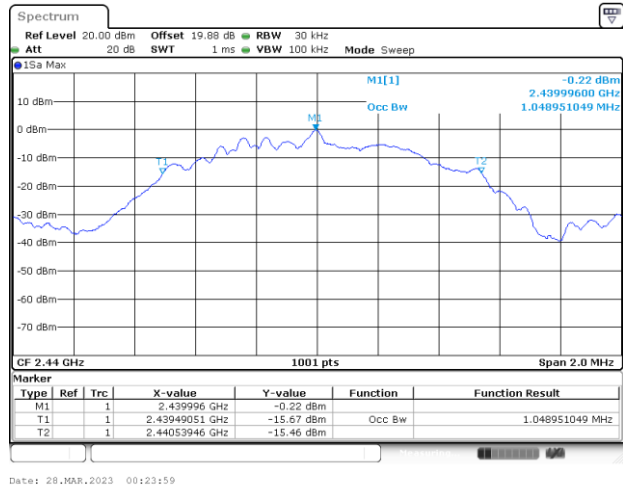

99% Occupied Bandwidth Plot on Channel 39

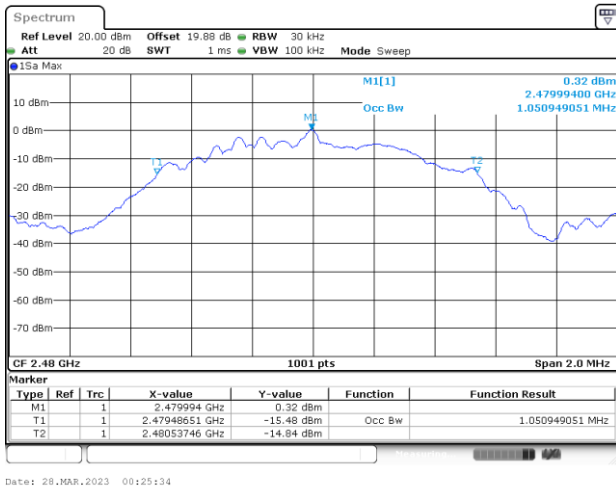

Note: The occupied channel bandwidth is maintained within the band of operation for all of the modulations.



Power Spectral Density (dBm/3kHz)

<1Mbps>

Power Density (dBm/3kHz) Plot Channel 00

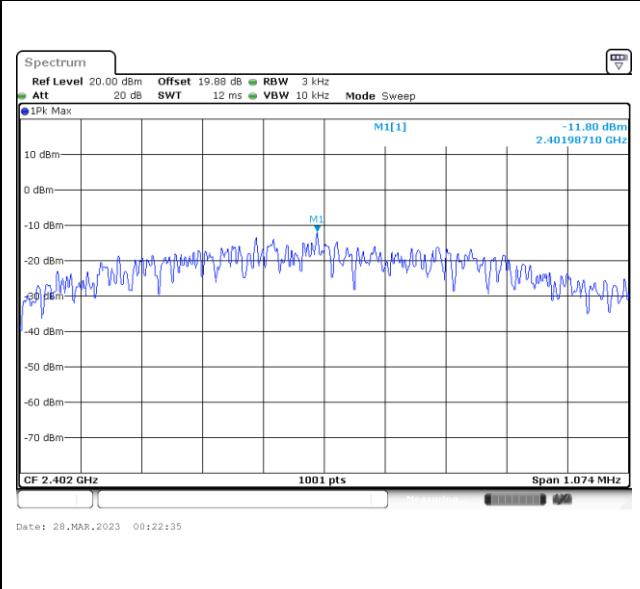

Power Density (dBm/3kHz) Plot Channel 19

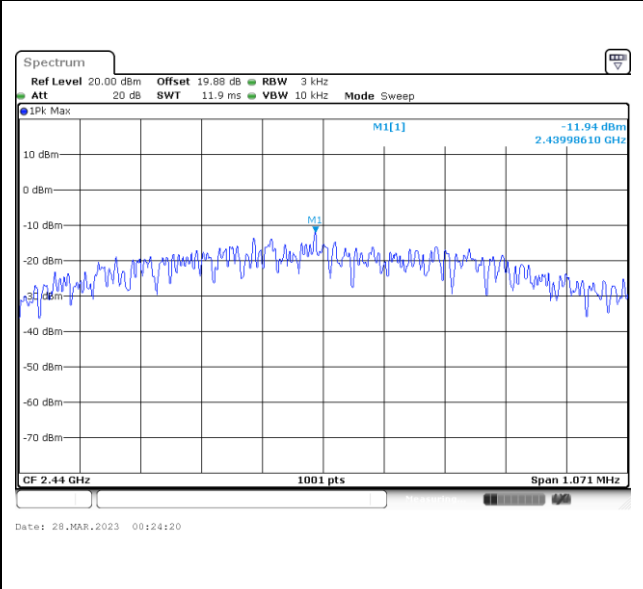

Power Density (dBm/3kHz) Plot Channel 39

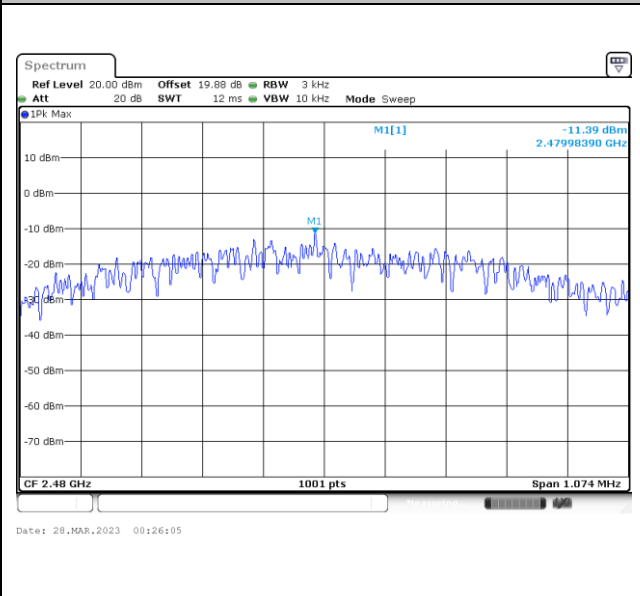



Band Edge and Spurious Emission

<1Mbps> Channel 00

100kHz PSD reference Level Plot

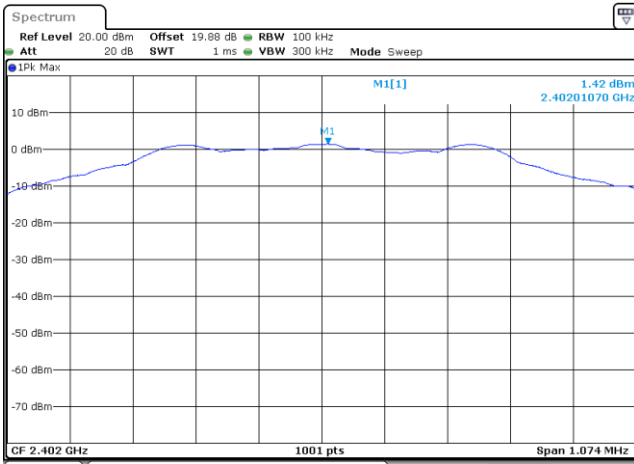

Low Channel Plot

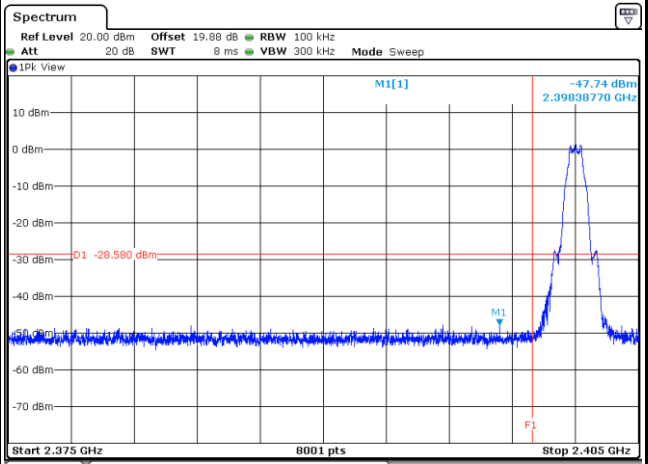

Spurious Emission 30MHz~1GHz Plot

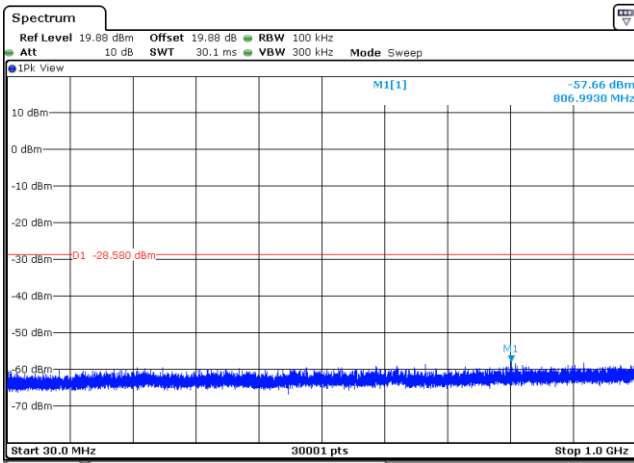

Spurious Emission 1GHz~26.5GHz Plot

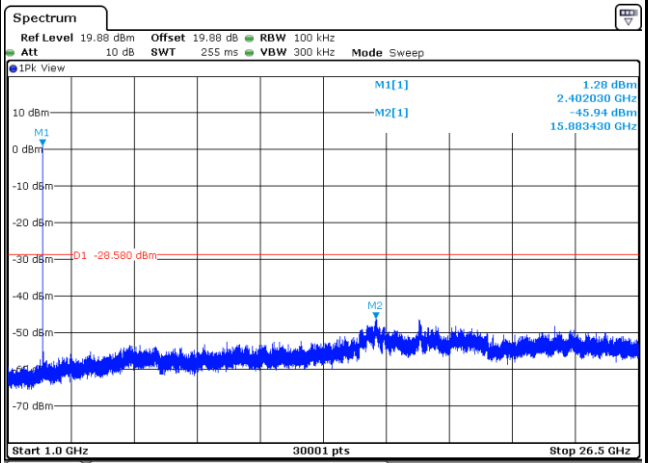



<1Mbps> Channel 19

100kHz PSD reference Level Plot

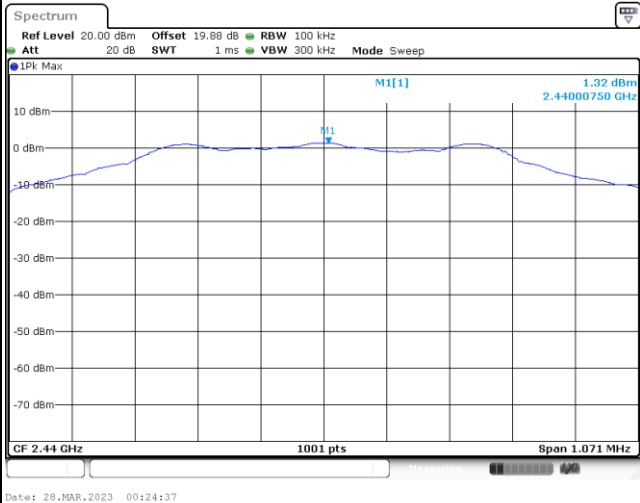

Middle Channel Plot

Spurious Emission 30MHz~1GHz Plot

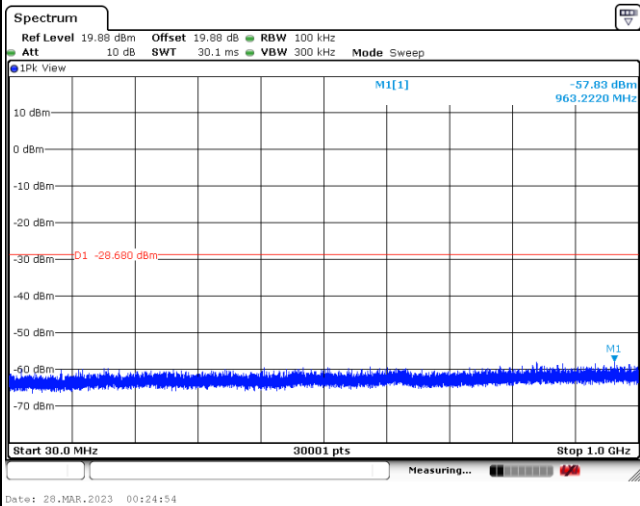

Spurious Emission 1GHz~26.5GHz Plot

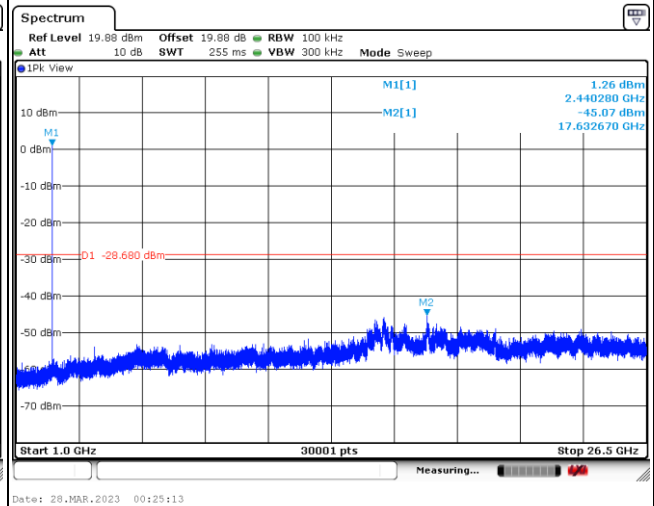

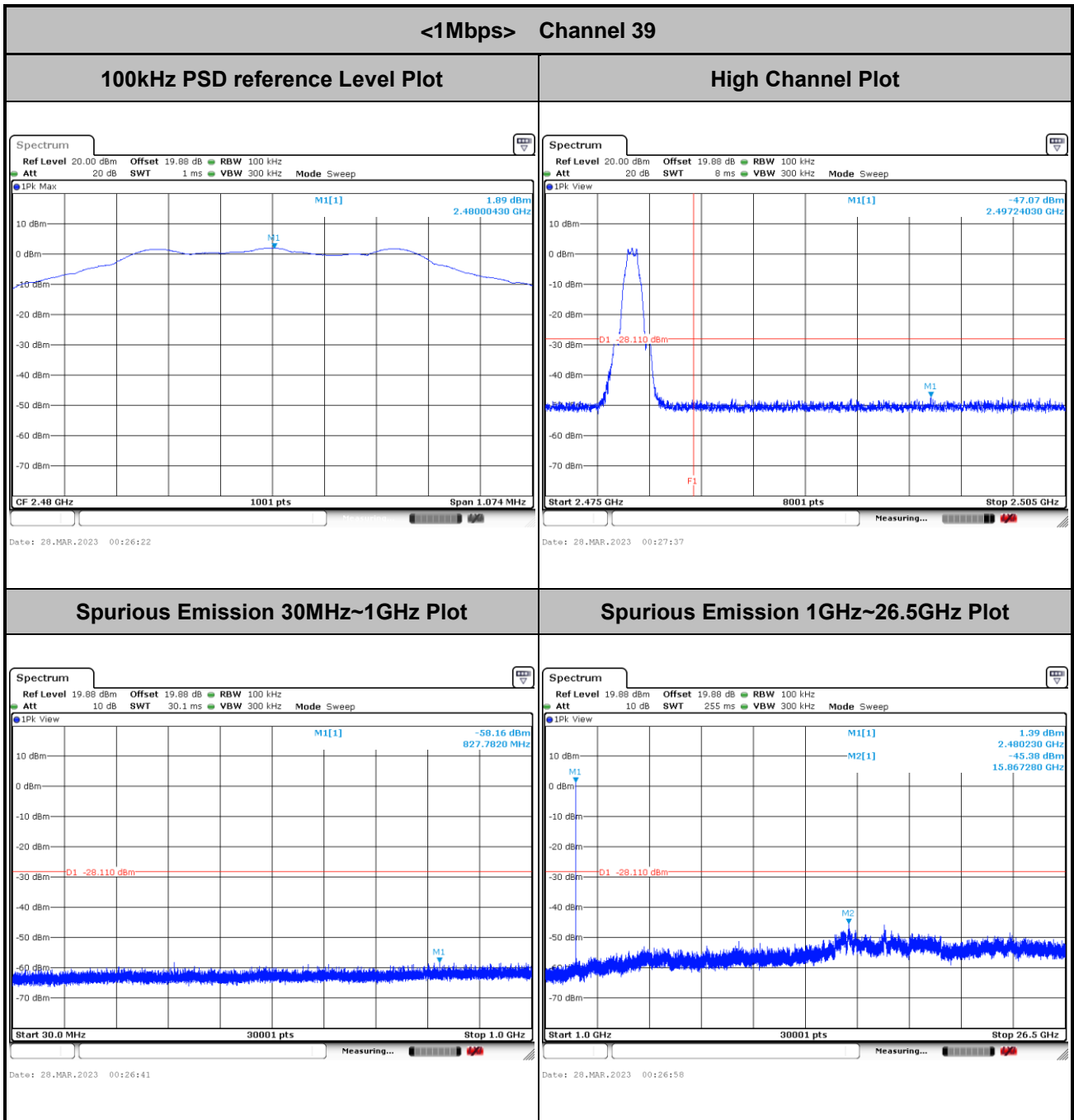



Appendix B. AC Conducted Emission Test Results

Test Engineer :	Louis Chung	Temperature :	22.3~25.1°C
		Relative Humidity :	60.2~68.7%

EUT Information

Report NO : 720928-02
 Test Mode : Mode 1
 Test Voltage : 120Vac/60Hz
 Phase : Line

Full Spectrum

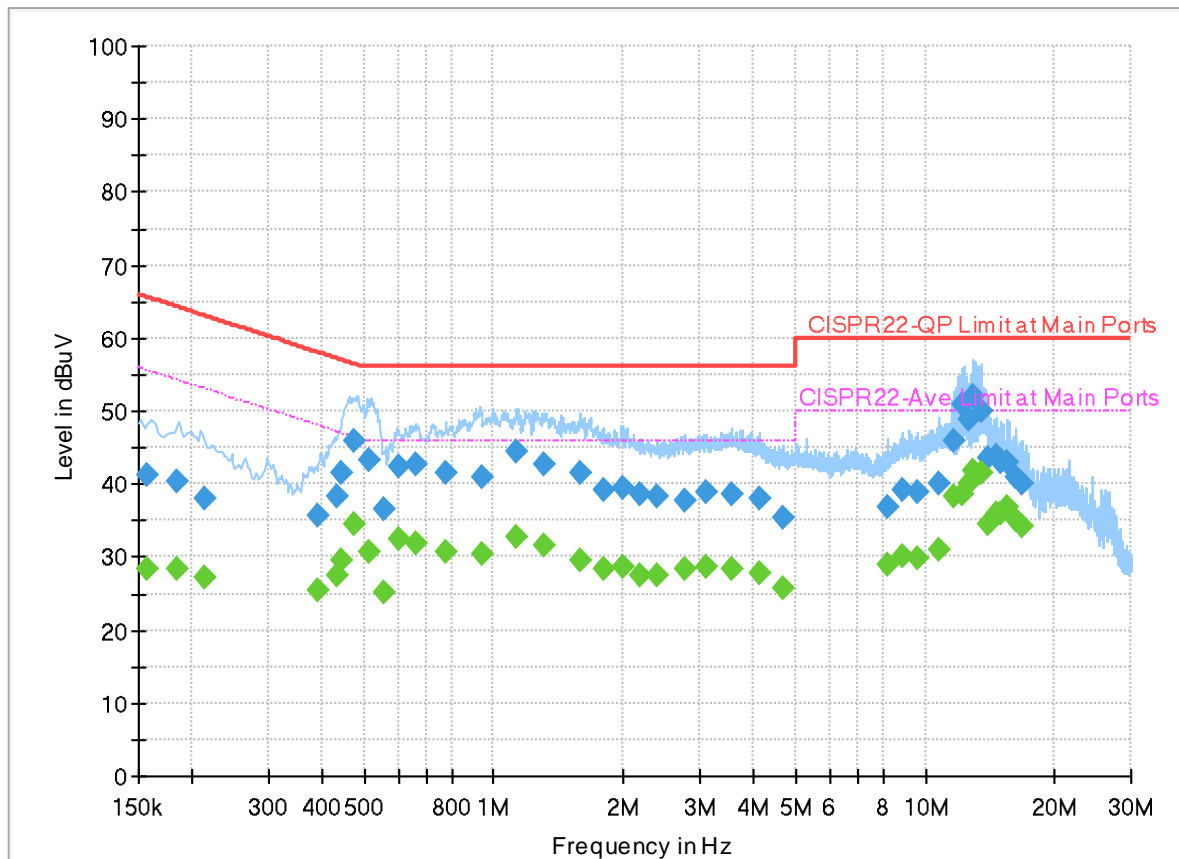

Final_Result

Frequency (MHz)	QuasiPeak (dBuV)	CAverage (dBuV)	Limit (dBuV)	Margin (dB)	Line	Filter	Corr. (dB)
0.157740	---	28.27	55.58	27.31	L1	OFF	19.9
0.157740	41.13	---	65.58	24.45	L1	OFF	19.9
0.183390	---	28.48	54.33	25.85	L1	OFF	19.9
0.183390	40.42	---	64.33	23.91	L1	OFF	19.9
0.213000	---	27.20	53.09	25.89	L1	OFF	20.0
0.213000	37.95	---	63.09	25.14	L1	OFF	20.0
0.391380	---	25.36	48.03	22.67	L1	OFF	20.0
0.391380	35.64	---	58.03	22.39	L1	OFF	20.0
0.431250	---	27.42	47.23	19.81	L1	OFF	20.0
0.431250	38.17	---	57.23	19.06	L1	OFF	20.0
0.444750	---	29.61	46.97	17.36	L1	OFF	20.0
0.444750	41.59	---	56.97	15.38	L1	OFF	20.0
0.476250	---	34.60	46.40	11.80	L1	OFF	20.0
0.476250	45.81	---	56.40	10.59	L1	OFF	20.0
0.515220	---	30.74	46.00	15.26	L1	OFF	20.0
0.515220	43.18	---	56.00	12.82	L1	OFF	20.0
0.555000	---	25.03	46.00	20.97	L1	OFF	20.0
0.555000	36.51	---	56.00	19.49	L1	OFF	20.0
0.601530	---	32.51	46.00	13.49	L1	OFF	20.0

0.601530	42.40	---	56.00	13.60	L1	OFF	20.0
0.656970	---	31.93	46.00	14.07	L1	OFF	20.0
0.656970	42.82	---	56.00	13.18	L1	OFF	20.0
0.776220	---	30.74	46.00	15.26	L1	OFF	20.0
0.776220	41.56	---	56.00	14.44	L1	OFF	20.0
0.937500	---	30.51	46.00	15.49	L1	OFF	20.0
0.937500	40.98	---	56.00	15.02	L1	OFF	20.0
1.128210	---	32.75	46.00	13.25	L1	OFF	20.0
1.128210	44.42	---	56.00	11.58	L1	OFF	20.0
1.312980	---	31.60	46.00	14.40	L1	OFF	20.0
1.312980	42.71	---	56.00	13.29	L1	OFF	20.0
1.586760	---	29.67	46.00	16.33	L1	OFF	20.0
1.586760	41.51	---	56.00	14.49	L1	OFF	20.0
1.801500	---	28.36	46.00	17.64	L1	OFF	20.0
1.801500	39.09	---	56.00	16.91	L1	OFF	20.0
1.988610	---	28.62	46.00	17.38	L1	OFF	20.0
1.988610	39.37	---	56.00	16.63	L1	OFF	20.0
2.193000	---	27.62	46.00	18.38	L1	OFF	20.0
2.193000	38.65	---	56.00	17.35	L1	OFF	20.0
2.383890	---	27.59	46.00	18.41	L1	OFF	20.0
2.383890	38.32	---	56.00	17.68	L1	OFF	20.0
2.775750	---	28.50	46.00	17.50	L1	OFF	20.0
2.775750	37.64	---	56.00	18.36	L1	OFF	20.0
3.104250	---	28.59	46.00	17.41	L1	OFF	20.0
3.104250	39.02	---	56.00	16.98	L1	OFF	20.0
3.573150	---	28.23	46.00	17.77	L1	OFF	20.0
3.573150	38.56	---	56.00	17.44	L1	OFF	20.0
4.123500	---	27.76	46.00	18.24	L1	OFF	20.0
4.123500	37.97	---	56.00	18.03	L1	OFF	20.0
4.659540	---	25.82	46.00	20.18	L1	OFF	20.0
4.659540	35.42	---	56.00	20.58	L1	OFF	20.0
8.197710	---	28.87	50.00	21.13	L1	OFF	20.1
8.197710	36.92	---	60.00	23.08	L1	OFF	20.1
8.889180	---	30.22	50.00	19.78	L1	OFF	20.1
8.889180	39.18	---	60.00	20.82	L1	OFF	20.1
9.594420	---	29.94	50.00	20.06	L1	OFF	20.1
9.594420	38.82	---	60.00	21.18	L1	OFF	20.1
10.739490	---	31.04	50.00	18.96	L1	OFF	20.1
10.739490	39.99	---	60.00	20.01	L1	OFF	20.1
11.668290	---	38.32	50.00	11.68	L1	OFF	20.1
11.668290	45.90	---	60.00	14.10	L1	OFF	20.1
12.176250	---	38.69	50.00	11.31	L1	OFF	20.1
12.176250	50.88	---	60.00	9.12	L1	OFF	20.1
12.669000	---	40.15	50.00	9.85	L1	OFF	20.1
12.669000	48.91	---	60.00	11.09	L1	OFF	20.1
12.967980	---	41.89	50.00	8.11	L1	OFF	20.1
12.967980	52.03	---	60.00	7.97	L1	OFF	20.1
13.564320	---	41.48	50.00	8.52	L1	OFF	20.1
13.564320	50.12	---	60.00	9.88	L1	OFF	20.1
13.956180	---	34.47	50.00	15.53	L1	OFF	20.1
13.956180	43.45	---	60.00	16.55	L1	OFF	20.1
14.559810	---	35.94	50.00	14.06	L1	OFF	20.1
14.559810	43.82	---	60.00	16.18	L1	OFF	20.1
15.039510	---	36.02	50.00	13.98	L1	OFF	20.1
15.039510	43.04	---	60.00	16.96	L1	OFF	20.1
15.560520	---	36.78	50.00	13.22	L1	OFF	20.1
15.560520	43.10	---	60.00	16.90	L1	OFF	20.1
16.158120	---	35.14	50.00	14.86	L1	OFF	20.1
16.158120	40.97	---	60.00	19.03	L1	OFF	20.1
16.799640	---	34.28	50.00	15.72	L1	OFF	20.1
16.799640	40.03	---	60.00	19.97	L1	OFF	20.1

EUT Information

Report NO : 720928-02
 Test Mode : Mode 1
 Test Voltage : 120Vac/60Hz
 Phase : Neutral

Full Spectrum

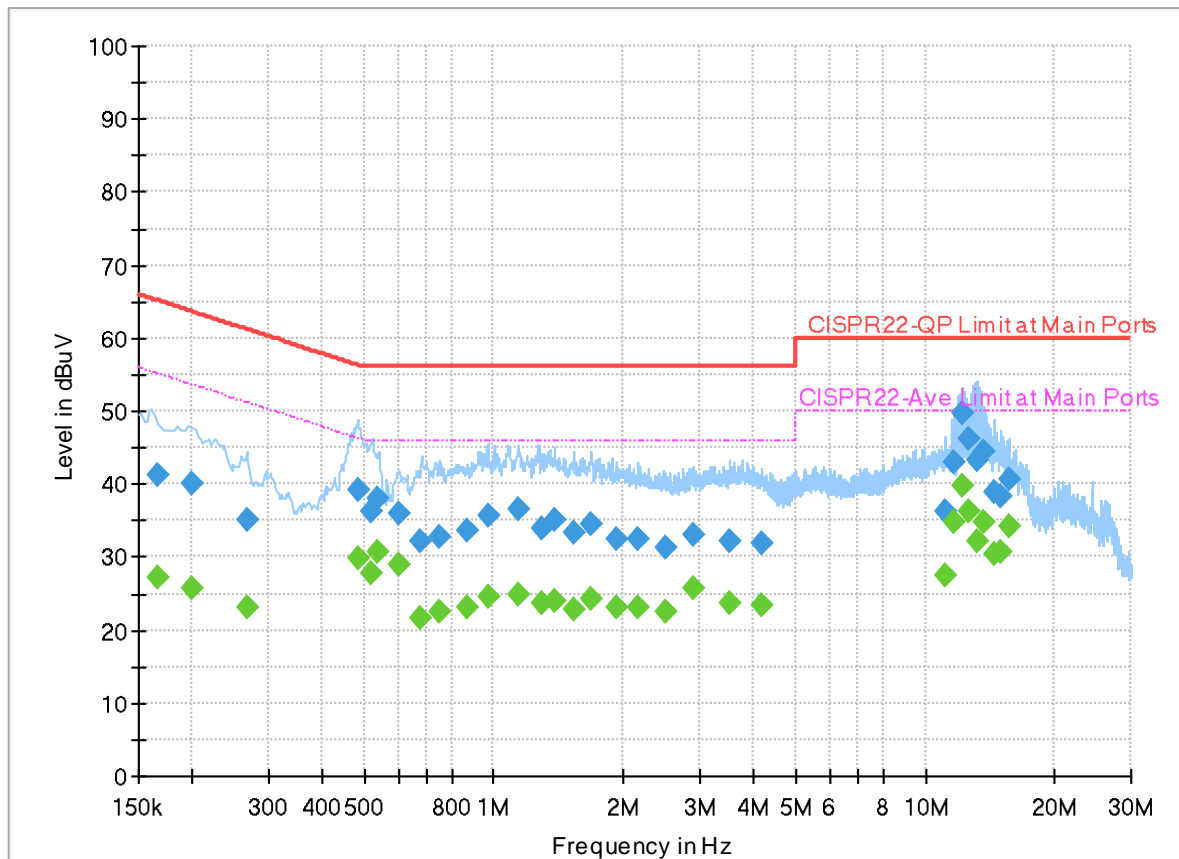

Final_Result

Frequency (MHz)	QuasiPeak (dBuV)	CAverage (dBuV)	Limit (dBuV)	Margin (dB)	Line	Filter	Corr. (dB)
0.165750	---	27.28	55.17	27.89	N	OFF	20.0
0.165750	41.31	---	65.17	23.86	N	OFF	20.0
0.198960	---	25.71	53.65	27.94	N	OFF	20.0
0.198960	39.94	---	63.65	23.71	N	OFF	20.0
0.266820	---	23.23	51.22	27.99	N	OFF	20.0
0.266820	35.07	---	61.22	26.15	N	OFF	20.0
0.487500	---	29.92	46.21	16.29	N	OFF	20.0
0.487500	39.06	---	56.21	17.15	N	OFF	20.0
0.521970	---	27.70	46.00	18.30	N	OFF	20.0
0.521970	36.32	---	56.00	19.68	N	OFF	20.0
0.538260	---	30.56	46.00	15.44	N	OFF	20.0
0.538260	37.95	---	56.00	18.05	N	OFF	20.0
0.601440	---	28.98	46.00	17.02	N	OFF	20.0
0.601440	36.05	---	56.00	19.95	N	OFF	20.0
0.678210	---	21.54	46.00	24.46	N	OFF	20.0
0.678210	32.14	---	56.00	23.86	N	OFF	20.0
0.744000	---	22.60	46.00	23.40	N	OFF	20.0
0.744000	32.67	---	56.00	23.33	N	OFF	20.0
0.867030	---	23.03	46.00	22.97	N	OFF	20.0

0.867030	33.77	---	56.00	22.23	N	OFF	20.0
0.968460	---	24.71	46.00	21.29	N	OFF	20.0
0.968460	35.66	---	56.00	20.34	N	OFF	20.0
1.141890	---	24.99	46.00	21.01	N	OFF	20.0
1.141890	36.58	---	56.00	19.42	N	OFF	20.0
1.291200	---	23.56	46.00	22.44	N	OFF	20.0
1.291200	34.02	---	56.00	21.98	N	OFF	20.0
1.387500	---	23.84	46.00	22.16	N	OFF	20.0
1.387500	34.99	---	56.00	21.01	N	OFF	20.0
1.531500	---	22.78	46.00	23.22	N	OFF	20.0
1.531500	33.21	---	56.00	22.79	N	OFF	20.0
1.673250	---	24.17	46.00	21.83	N	OFF	20.0
1.673250	34.39	---	56.00	21.61	N	OFF	20.0
1.929750	---	22.95	46.00	23.05	N	OFF	20.0
1.929750	32.56	---	56.00	23.44	N	OFF	20.0
2.161320	---	23.05	46.00	22.95	N	OFF	20.0
2.161320	32.56	---	56.00	23.44	N	OFF	20.0
2.493060	---	22.41	46.00	23.59	N	OFF	20.0
2.493060	31.42	---	56.00	24.58	N	OFF	20.0
2.900580	---	25.78	46.00	20.22	N	OFF	20.0
2.900580	32.97	---	56.00	23.03	N	OFF	20.0
3.532470	---	23.72	46.00	22.28	N	OFF	20.0
3.532470	32.22	---	56.00	23.78	N	OFF	20.0
4.185330	---	23.39	46.00	22.61	N	OFF	20.0
4.185330	31.86	---	56.00	24.14	N	OFF	20.0
11.105790	---	27.57	50.00	22.43	N	OFF	20.1
11.105790	36.21	---	60.00	23.79	N	OFF	20.1
11.673690	---	34.70	50.00	15.30	N	OFF	20.1
11.673690	42.94	---	60.00	17.06	N	OFF	20.1
12.171840	---	39.67	50.00	10.33	N	OFF	20.1
12.171840	49.70	---	60.00	10.30	N	OFF	20.1
12.671700	---	36.30	50.00	13.70	N	OFF	20.1
12.671700	46.08	---	60.00	13.92	N	OFF	20.1
13.178130	---	32.02	50.00	17.98	N	OFF	20.1
13.178130	43.13	---	60.00	16.87	N	OFF	20.1
13.665840	---	34.87	50.00	15.13	N	OFF	20.2
13.665840	44.36	---	60.00	15.64	N	OFF	20.2
14.483490	---	30.27	50.00	19.73	N	OFF	20.2
14.483490	38.78	---	60.00	21.22	N	OFF	20.2
15.043470	---	30.84	50.00	19.16	N	OFF	20.2
15.043470	38.32	---	60.00	21.68	N	OFF	20.2
15.599130	---	34.20	50.00	15.80	N	OFF	20.2
15.599130	40.76	---	60.00	19.24	N	OFF	20.2



Appendix C. Radiated Spurious Emission

Test Engineer :	Michael Liu and Leo Li	Temperature :	22.1~23.1°C
		Relative Humidity :	55~60%



2.4GHz 2400~2483.5MHz

BLE (Band Edge @ 3m)

BLE	Note	Frequency	Level	Margin	Limit	Read	Antenna	Path	Preamp	Ant	Table	Peak	Pol.	
		(MHz)	(dBμV/m)	(dB)	(dBμV/m)	(dBμV)	(dB/m)	(dB)	(dB)	(cm)	(deg)	(P/A)	(H/V)	
BLE CH 00 2402MHz		2381.715	50.92	-23.08	74	37.31	27.1	18.97	32.46	190	204	P	H	
		2373.315	41.46	-12.54	54	27.86	27.1	18.95	32.45	190	204	A	H	
	*	2402	98.19	-	-	84.56	27.1	19	32.47	190	204	P	H	
	*	2402	97.64	-	-	84.01	27.1	19	32.47	190	204	A	H	
													H	
													H	
			2359.665	51.1	-22.9	74	37.52	27.1	18.92	32.44	370	281	P	V
			2347.8	41.45	-12.55	54	27.89	27.1	18.9	32.44	370	281	A	V
	*		2402	96.79	-	-	83.16	27.1	19	32.47	370	281	P	V
	*		2402	96.31	-	-	82.68	27.1	19	32.47	370	281	A	V
														V
														V
BLE CH 19 2440MHz		2364.24	50.85	-23.15	74	37.27	27.1	18.93	32.45	159	199	P	H	
		2357.2	41.5	-12.5	54	27.92	27.1	18.92	32.44	159	199	A	H	
	*	2440	98.09	-	-	84.49	27.02	19.08	32.5	159	199	P	H	
	*	2440	97.58	-	-	83.98	27.02	19.08	32.5	159	199	A	H	
			2496.8	50.67	-23.33	74	37.21	26.81	19.19	32.54	159	199	P	H
			2491.28	41.53	-12.47	54	28.05	26.83	19.18	32.53	159	199	A	H
			2322	50.93	-23.07	74	37.4	27.1	18.85	32.42	314	277	P	V
			2315.44	41.46	-12.54	54	27.93	27.1	18.84	32.41	314	277	A	V
	*		2440	95.81	-	-	82.21	27.02	19.08	32.5	314	277	P	V
	*		2440	95.26	-	-	81.66	27.02	19.08	32.5	314	277	A	V
			2485.44	50.43	-23.57	74	36.93	26.86	19.17	32.53	314	277	P	V
			2494.64	41.32	-12.68	54	27.86	26.82	19.18	32.54	314	277	A	V



BLE CH 39 2480MHz	*	2480	97.28	-	-	83.77	26.88	19.16	32.53	211	200	P	H
	*	2480	96.75	-	-	83.24	26.88	19.16	32.53	211	200	A	H
		2483.76	55.56	-18.44	74	42.07	26.86	19.16	32.53	211	200	P	H
		2483.84	41.88	-12.12	54	28.39	26.86	19.16	32.53	211	200	A	H
													H
													H
	*	2480	94.34	-	-	80.83	26.88	19.16	32.53	350	283	P	V
	*	2480	93.77	-	-	80.26	26.88	19.16	32.53	350	283	A	V
		2484	52.81	-21.19	74	39.32	26.86	19.16	32.53	350	283	P	V
		2499.04	41.57	-12.43	54	28.12	26.8	19.19	32.54	350	283	A	V
													V
													V
Remark	<ol style="list-style-type: none"> 1. No other spurious found. 2. All results are PASS against Peak and Average limit line. 												



2.4GHz 2400~2483.5MHz

BLE (Harmonic @ 3m)

BLE	Note	Frequency (MHz)	Level (dBμV/m)	Margin (dB)	Limit Line (dBμV/m)	Read Level (dBμV)	Antenna Factor (dB/m)	Path Loss (dB)	Preamp Factor (dB)	Ant Pos (cm)	Table Pos (deg)	Peak Avg. (P/A)	Pol. (H/V)
BLE CH 00 2402MHz		4804	45.36	-28.64	74	31.83	32.61	14.51	33.59	-	-	P	H
													H
													H
													H
													H
													H
													H
													H
													H
													H
													H
													H
													H
													H
													H
													H
													H
													H
													H
			4804	45.99	-28.01	74	32.46	32.61	14.51	33.59	-	-	P
													V
													V
													V
													V
													V
													V
													V
													V
													V
													V
													V
													V
													V
													V



BLE	Note	Frequency (MHz)	Level (dBμV/m)	Margin (dB)	Limit Line (dBμV/m)	Read Level (dBμV)	Antenna Factor (dB/m)	Path Loss (dB)	Preamp Factor (dB)	Ant Pos (cm)	Table Pos (deg)	Peak Avg. (P/A)	Pol. (H/V)	
BLE CH 19 2440MHz		4880	46.79	-27.21	74	33.14	32.76	14.46	33.57	-	-	P	H	
		7320	51.15	-22.85	74	33.08	37.44	16.58	35.95	-	-	P	H	
		7320	40.76	-13.24	54	22.69	37.44	16.58	35.95	-	-	A	H	
													H	
													H	
													H	
													H	
													H	
													H	
													H	
													H	
													H	
			4880	46.55	-27.45	74	32.9	32.76	14.46	33.57	-	-	P	V
			7320	51.49	-22.51	74	33.42	37.44	16.58	35.95	-	-	P	V
			7320	40.77	-13.23	54	22.7	37.44	16.58	35.95	-	-	A	V
														V
														V
														V
														V
														V
													V	
													V	



BLE	Note	Frequency (MHz)	Level (dBµV/m)	Margin (dB)	Limit Line (dBµV/m)	Read Level (dBµV)	Antenna Factor (dB/m)	Path Loss (dB)	Preamp Factor (dB)	Ant Pos (cm)	Table Pos (deg)	Peak Avg. (P/A)	Pol. (H/V)	
BLE CH 39 2480MHz		4960	46.53	-27.47	74	32.91	32.78	14.4	33.56	-	-	P	H	
		7440	49.42	-24.58	74	31.46	37.12	16.88	36.04	-	-	P	H	
		7440	39.68	-14.32	54	21.72	37.12	16.88	36.04	-	-	A	H	
													H	
													H	
													H	
													H	
													H	
													H	
													H	
													H	
													H	
			4960	46.44	-27.56	74	32.82	32.78	14.4	33.56	-	-	P	V
			7440	49.91	-24.09	74	31.95	37.12	16.88	36.04	-	-	P	V
			7440	39.73	-14.27	54	21.77	37.12	16.88	36.04	-	-	A	V
														V
														V
														V
														V
														V
													V	
													V	
Remark	<ol style="list-style-type: none"> No other spurious found. All results are PASS against Peak and Average limit line. The emission position marked as "-" means no suspected emission found with sufficient margin against limit line or noise floor only. 													



Emission below 1GHz

2.4GHz BLE (LF)

BLE	Note	Frequency	Level	Margin	Limit	Read	Antenna	Path	Preamp	Ant	Table	Peak	Pol.	
		(MHz)	(dBμV/m)	(dB)	(dBμV/m)	(dBμV)	(dB/m)	(dB)	(dB)	(cm)	(deg)	(P/A)	(H/V)	
2.4GHz BLE LF		30	22.97	-17.03	40	29.51	25.2	1.03	32.77	-	-	P	H	
		132.82	18.14	-25.36	43.5	30.86	17.5	2.48	32.7	-	-	P	H	
		261.83	21.25	-24.75	46	30.76	19.9	3.34	32.75	-	-	P	H	
		399.57	30.53	-15.47	46	37.55	21.78	4.02	32.82	-	-	P	H	
		666.32	42.59	-3.41	46	44.13	26.23	5.12	32.89	122	182	Q	H	
		722.58	36.7	-9.3	46	36.88	27.31	5.31	32.8	-	-	P	H	
														H
														H
														H
														H
														H
														H
			30	24.67	-15.33	40	31.21	25.2	1.03	32.77	-	-	P	V
			134.76	17.71	-25.79	43.5	30.39	17.52	2.5	32.7	-	-	P	V
			262.8	20.89	-25.11	46	30.39	19.9	3.35	32.75	-	-	P	V
			399.57	25.56	-20.44	46	32.58	21.78	4.02	32.82	-	-	P	V
			666.32	35.04	-10.96	46	36.58	26.23	5.12	32.89	-	-	P	V
			953.44	36.58	-9.42	46	30.82	31.14	6.11	31.49	-	-	P	V
														V
														V
													V	
													V	
													V	

Remark

- No other spurious found.
- All results are PASS against limit line.
- The emission position marked as "-" means no suspected emission found and emission level has at least 6dB margin against limit or emission is noise floor only.



Note symbol

*	Fundamental Frequency which can be ignored. However, the level of any unwanted emissions shall not exceed the level of the fundamental frequency.
!	Test result is over limit line.
P/A	Peak or Average
H/V	Horizontal or Vertical



A calculation example for radiated spurious emission is shown as below:

BLE	Note	Frequency	Level	Margin	Limit	Read	Antenna	Path	Preamp	Ant	Table	Peak	Pol.
		(MHz)	(dBμV/m)	(dB)	(dBμV/m)	(dBμV)	(dB/m)	(dB)	(dB)	(cm)	(deg)	(P/A)	(H/V)
BLE CH 00 2402MHz		2390	55.45	-18.55	74	54.51	32.22	4.58	35.86	103	308	P	H
		2390	43.54	-10.46	54	42.6	32.22	4.58	35.86	103	308	A	H

1. Path Loss(dB) = Cable loss(dB) + Filter loss(dB) + Attenuator loss(dB)
2. Level(dBμV/m) =
Antenna Factor(dB/m) + Path Loss(dB) + Read Level(dBμV) - Preamp Factor(dB)
3. Margin(dB) = Level(dBμV/m) – Limit Line(dBμV/m)

For Peak Limit @ 2390MHz:

1. Level(dBμV/m)
= Antenna Factor(dB/m) + Path Loss(dB) + Read Level(dBμV) - Preamp Factor(dB)
= 32.22(dB/m) + 4.58(dB) + 54.51(dBμV) – 35.86 (dB)
= 55.45 (dBμV/m)
2. Margin(dB)
= Level(dBμV/m) – Limit Line(dBμV/m)
= 55.45(dBμV/m) – 74(dBμV/m)
= -18.55(dB)

For Average Limit @ 2390MHz:

1. Level(dBμV/m)
= Antenna Factor(dB/m) + Path Loss(dB) + Read Level(dBμV) - Preamp Factor(dB)
= 32.22(dB/m) + 4.58(dB) + 42.6(dBμV) – 35.86 (dB)
= 43.54 (dBμV/m)
2. Margin(dB)
= Level(dBμV/m) – Limit Line(dBμV/m)
= 43.54(dBμV/m) – 54(dBμV/m)
= -10.46(dB)

Both peak and average measured complies with the limit line, so test result is “PASS”.



Appendix D. Radiated Spurious Emission Plots

Test Engineer :	Michael Liu and Leo Li	Temperature :	22.1~23.1°C
		Relative Humidity :	55~60%

Note symbol

-L	Low channel location
-R	High channel location



2.4GHz 2400~2483.5MHz

BLE (Band Edge @ 3m)

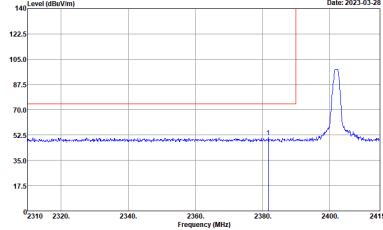
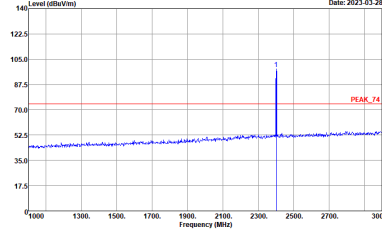
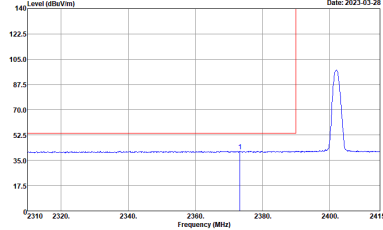
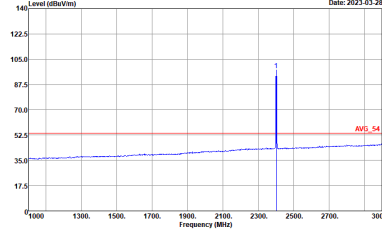
BLE	2.4GHz 2400~2483.5MHz Band Edge @ 3m	
	BLE CH00 2402MHz	
	Horizontal	Fundamental
Peak	 <p>Date: 2023-03-28</p> <p>Site : 03CH22-HY Condition : PEAK_BE_74 3m DRH18-E_LE2C05A18EN HORIZONTAL : RBW:1000.000KHz VBW:3000.000KHz SWT:Auto</p>	 <p>Date: 2023-03-28</p> <p>Site : 03CH22-HY Condition : PEAK_74 3m DRH18-E_LE2C05A18EN HORIZONTAL : RBW:1000.000KHz VBW:3000.000KHz SWT:Auto</p>
Avg.	 <p>Date: 2023-03-28</p> <p>Site : 03CH22-HY Condition : AVG_BE_54 3m DRH18-E_LE2C05A18EN HORIZONTAL : RBW:1000.000KHz VBW:3.000KHz SWT:Auto</p>	 <p>Date: 2023-03-28</p> <p>Site : 03CH22-HY Condition : AVG_54 3m DRH18-E_LE2C05A18EN HORIZONTAL : RBW:1000.000KHz VBW:3.000KHz SWT:Auto</p>



BLE	2.4GHz 2400~2483.5MHz Band Edge @ 3m	
	BLE CH00 2402MHz	
	Vertical	Fundamental
Peak	<p>Date: 2023-03-28</p> <p>Site : 03CH22-HY Condition : PEAK_BE_74 3m DRH18-E_LE2C05A18EN VERTICAL : RBW:1000.000KHz VBW:3000.000KHz SWT:Auto</p>	<p>Date: 2023-03-28</p> <p>Site : 03CH22-HY Condition : PEAK_74 3m DRH18-E_LE2C05A18EN VERTICAL : RBW:1000.000KHz VBW:3000.000KHz SWT:Auto</p>
Avg	<p>Date: 2023-03-28</p> <p>Site : 03CH22-HY Condition : AV6_BE_54 3m DRH18-E_LE2C05A18EN VERTICAL : RBW:1000.000KHz VBW:3000.000KHz SWT:Auto</p>	<p>Date: 2023-03-28</p> <p>Site : 03CH22-HY Condition : AV6_54 3m DRH18-E_LE2C05A18EN VERTICAL : RBW:1000.000KHz VBW:3000.000KHz SWT:Auto</p>

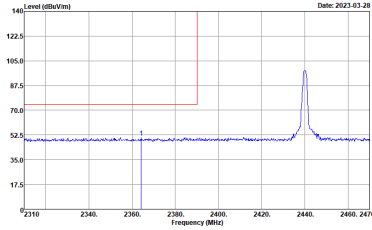
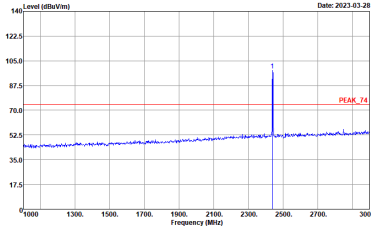
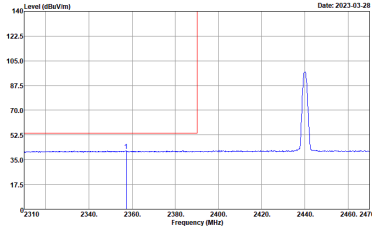
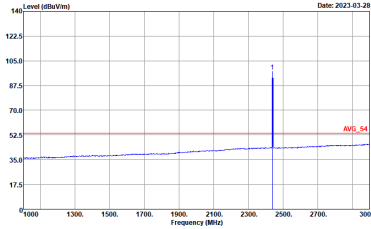

BLE	2.4GHz 2400~2483.5MHz Band Edge @ 3m	
BLE CH19 2440MHz - L		
Horizontal		Fundamental
Peak	 <p>Site : 03CH22-HY Condition : PEAK_BE_74 3m DRH18-E_LEZ005A18EN HORIZONTAL : RBW:1000.000KHz VBW:3000.000KHz SWT:Auto</p>	 <p>Site : 03CH22-HY Condition : PEAK_74 3m DRH18-E_LEZ005A18EN HORIZONTAL : RBW:1000.000KHz VBW:3000.000KHz SWT:Auto</p>
Avg.	 <p>Site : 03CH22-HY Condition : AVG_BE_54 3m DRH18-E_LEZ005A18EN HORIZONTAL : RBW:1000.000KHz VBW:3.000KHz SWT:Auto</p>	 <p>Site : 03CH22-HY Condition : AVG_54 3m DRH18-E_LEZ005A18EN HORIZONTAL : RBW:1000.000KHz VBW:3.000KHz SWT:Auto</p>

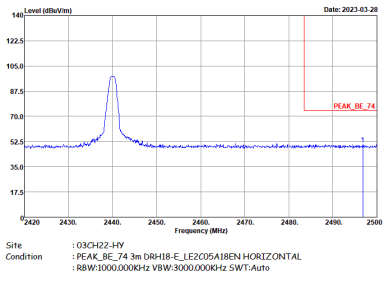
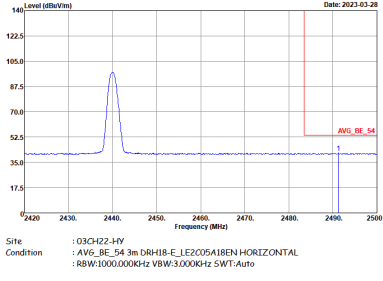

BLE	2.4GHz 2400~2483.5MHz Band Edge @ 3m	
	BLE CH19 2440MHz - R	
	Horizontal	Fundamental
Peak	 <p>Site : 03CH22-HY Condition : PEAK_BE_74 3m DRH18-E_LE2C05A18EN HORIZONTAL RBW:1000.000kHz VBW:3000.000kHz SWT:Auto</p>	Left blank
Avg.	 <p>Site : 03CH22-HY Condition : AVG_BE_54 3m DRH18-E_LE2C05A18EN HORIZONTAL RBW:1000.000kHz VBW:3000.000kHz SWT:Auto</p>	Left blank



BLE	2.4GHz 2400~2483.5MHz Band Edge @ 3m	
	BLE CH19 2440MHz - L	
	Vertical	Fundamental
Peak	<p>Date: 2023-03-28</p> <p>Site : 03CH22-HY Condition : PEAK_BE_74 3m DRH18-E_LE2C05A18EN VERTICAL : RBW:1000.000KHz VBW:3000.000KHz SWT:Auto</p>	<p>Date: 2023-03-28</p> <p>Site : 03CH22-HY Condition : PEAK_74 3m DRH18-E_LE2C05A18EN VERTICAL : RBW:1000.000KHz VBW:3000.000KHz SWT:Auto</p>
Avg.	<p>Date: 2023-03-28</p> <p>Site : 03CH22-HY Condition : AV6_BE_54 3m DRH18-E_LE2C05A18EN VERTICAL : RBW:1000.000KHz VBW:3000.000KHz SWT:Auto</p>	<p>Date: 2023-03-28</p> <p>Site : 03CH22-HY Condition : AV6_54 3m DRH18-E_LE2C05A18EN VERTICAL : RBW:1000.000KHz VBW:3000.000KHz SWT:Auto</p>

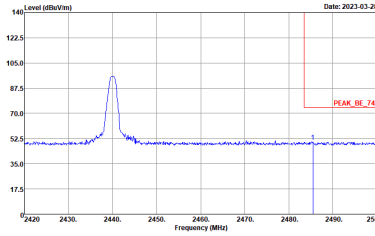
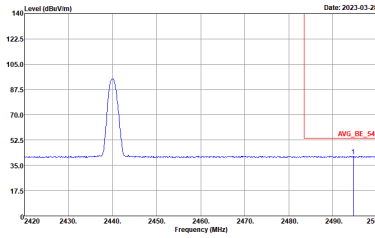

BLE	2.4GHz 2400~2483.5MHz Band Edge @ 3m	
	BLE CH19 2440MHz - R	
	Vertical	Fundamental
Peak	 <p>Site : 03CH22-HY Condition : PEAK_BE_74 3m DRH18-E_LE2C05A18EN VERTICAL : RBW:1000.000KHz VBW:3000.000KHz SWT:Auto</p>	Left blank
Avg.	 <p>Site : 03CH22-HY Condition : AVG_BE_54 3m DRH18-E_LE2C05A18EN VERTICAL : RBW:1000.000KHz VBW:3000.000KHz SWT:Auto</p>	Left blank

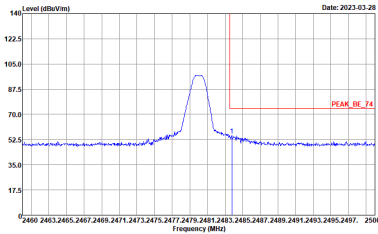
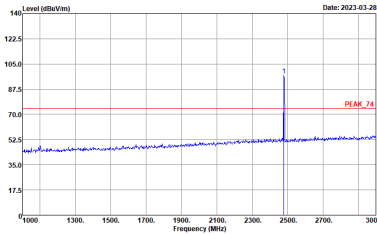
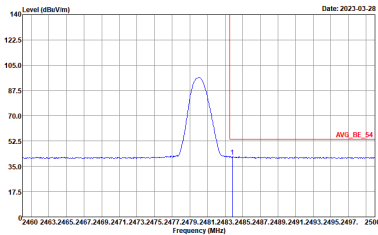
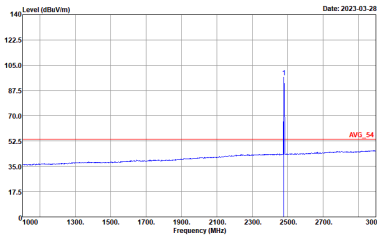

BLE	2.4GHz 2400~2483.5MHz Band Edge @ 3m	
BLE CH39 2480MHz		
Horizontal		Fundamental
Peak	 <p>Site : 03CH22-HY Condition : PEAK_BE_74 3m DRH18-E_LE2C05A18EN HORIZONTAL : RBW:1000.000KHz VBW:3000.000KHz SWT:Auto</p>	 <p>Site : 03CH22-HY Condition : PEAK_74 3m DRH18-E_LE2C05A18EN HORIZONTAL : RBW:1000.000KHz VBW:3000.000KHz SWT:Auto</p>
Avg.	 <p>Site : 03CH22-HY Condition : AV6_BE_54 3m DRH18-E_LE2C05A18EN HORIZONTAL : RBW:1000.000KHz VBW:3.000KHz SWT:Auto</p>	 <p>Site : 03CH22-HY Condition : AV6_54 3m DRH18-E_LE2C05A18EN HORIZONTAL : RBW:1000.000KHz VBW:3.000KHz SWT:Auto</p>



BLE	2.4GHz 2400~2483.5MHz Band Edge @ 3m	
	BLE CH39 2480MHz	
	Vertical	Fundamental
Peak	<p>Site : 03CH22-HY Condition : PEAK_BE_74 3m DRH18-E_LE2C05A18EN VERTICAL : RBW:1000.000KHz VBW:3000.000KHz SWT:Auto</p>	<p>Site : 03CH22-HY Condition : PEAK_74 3m DRH18-E_LE2C05A18EN VERTICAL : RBW:1000.000KHz VBW:3000.000KHz SWT:Auto</p>
Avg.	<p>Site : 03CH22-HY Condition : AV6_BE_54 3m DRH18-E_LE2C05A18EN VERTICAL : RBW:1000.000KHz VBW:3000.000KHz SWT:Auto</p>	<p>Site : 03CH22-HY Condition : AV6_54 3m DRH18-E_LE2C05A18EN VERTICAL : RBW:1000.000KHz VBW:3000.000KHz SWT:Auto</p>



2.4GHz 2400~2483.5MHz

BLE (Harmonic @ 3m)

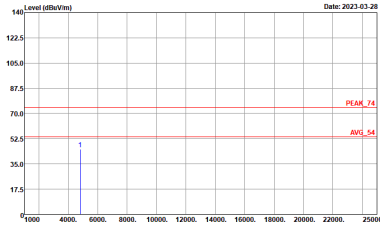
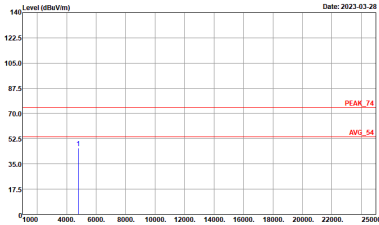
BLE	2.4GHz 2400~2483.5MHz Harmonic @ 3m	
	BLE CH00 2402MHz	
	Horizontal	Vertical
Peak Avg.	 <p>Date: 2023-03-28</p> <p>Site : 03CH22-HY Condition : PEAK_74 3m DRH18-E_LEZ005A18EN HORIZONTAL</p>	 <p>Date: 2023-03-28</p> <p>Site : 03CH22-HY Condition : PEAK_74 3m DRH18-E_LEZ005A18EN VERTICAL</p>

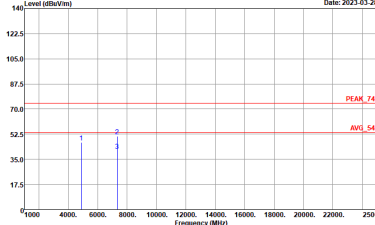
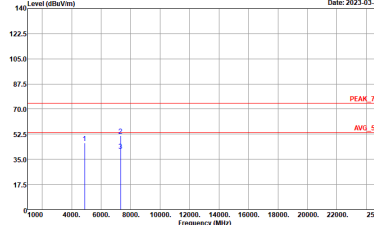

BLE	2.4GHz 2400~2483.5MHz Harmonic @ 3m	
BLE CH19 2440MHz		
	Horizontal	Vertical
Peak Avg.	 <p>Site : 03CH22-HY Condition : PEAK_74 3m DRH18-E_LE2C05A18EN HORIZONTAL</p>	 <p>Site : 03CH22-HY Condition : PEAK_74 3m DRH18-E_LE2C05A18EN VERTICAL</p>



BLE	2.4GHz 2400~2483.5MHz Harmonic @ 3m	
	BLE CH39 2480MHz	
	Horizontal	Vertical
Peak	<p>Site : 03CH22-HY Condition : PEAK_74 3m DRH18-E_LE2C05A18EN HORIZONTAL</p>	<p>Site : 03CH22-HY Condition : PEAK_74 3m DRH18-E_LE2C05A18EN VERTICAL</p>



Emission below 1GHz

2.4GHz BLE (LF)

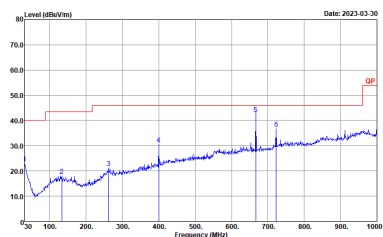
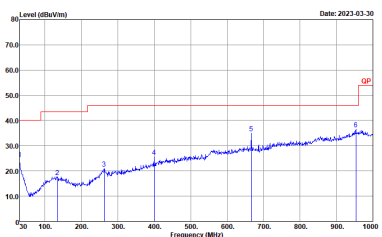
BLE	2.4GHz 2400~2483.5MHz	
	BLE LF	
	Horizontal	Vertical
QP / Peak	 <p data-bbox="430 840 686 862">Site : 03CH22-HY Condition : QP 3m CBL6111D_633046002 HORIZONTAL</p>	 <p data-bbox="909 840 1165 862">Site : 03CH22-HY Condition : QP 3m CBL6111D_633046002 VERTICAL</p>



Appendix E. Duty Cycle Plots

Band	Duty Cycle(%)	T(us)	1/T(kHz)	VBW Setting
Bluetooth - LE for 1Mbps	62.30	390	2.56	3kHz

