



# FCC RADIO TEST REPORT

**FCC ID** : UZ7CS6080  
**Equipment** : Scanner  
**Brand Name** : Zebra  
**Model Name** : CS6080  
**Applicant** : Zebra Technologies Corporation  
1 Zebra Plaza, Holtsville, NY 11742  
**Manufacturer** : Zebra Technologies Corporation  
1 Zebra Plaza, Holtsville, NY 11742  
**Standard** : FCC Part 15 Subpart C §15.247

The product was received on Apr. 29, 2020 and testing was started from May 08, 2020 and completed on Jun. 26, 2020. We, SPORTON INTERNATIONAL INC., EMC & Wireless Communications Laboratory, would like to declare that the tested sample has been evaluated in accordance with the test procedures and has been in compliance with the applicable technical standards.

The test results in this report apply exclusively to the tested model / sample. Without written approval of SPORTON INTERNATIONAL INC. EMC & Wireless Communications Laboratory, the test report shall not be reproduced except in full.

*Louis Wu*

Reviewed by: Louis Wu

**SPORTON INTERNATIONAL INC. EMC & Wireless Communications Laboratory**

No. 52, Huaya 1st Rd., Guishan Dist., Taoyuan City, Taiwan (R.O.C.)



## Table of Contents

|   |           |
|---|-----------|
| History of this test report.....                                | 3         |
| Summary of Test Result.....                                     | 4         |
| <b>1 General Description.....</b>                               | <b>5</b>  |
| 1.1 Product Feature of Equipment Under Test.....                | 5         |
| 1.2 Product Specification of Equipment Under Test.....          | 6         |
| 1.3 Modification of EUT .....                                   | 6         |
| 1.4 Testing Location .....                                      | 6         |
| 1.5 Applicable Standards.....                                   | 7         |
| <b>2 Test Configuration of Equipment Under Test.....</b>        | <b>8</b>  |
| 2.1 Carrier Frequency Channel .....                             | 8         |
| 2.2 Test Mode.....  | 11        |
| 2.3 Connection Diagram of Test System.....                      | 12        |
| 2.4 Support Unit used in test configuration and system .....    | 13        |
| 2.5 EUT Operation Test Setup .....                              | 13        |
| 2.6 Measurement Results Explanation Example.....                | 13        |
| <b>3 Test Result.....</b>                                       | <b>14</b> |
| 3.1 Number of Channel Measurement .....                         | 14        |
| 3.2 Hopping Channel Separation Measurement .....                | 16        |
| 3.3 Dwell Time Measurement.....                                 | 22        |
| 3.4 20dB and 99% Bandwidth Measurement .....                    | 24        |
| 3.5 Output Power Measurement.....                               | 36        |
| 3.6 Conducted Band Edges Measurement.....                       | 38        |
| 3.7 Conducted Spurious Emission Measurement .....               | 45        |
| 3.8 Radiated Band Edges and Spurious Emission Measurement ..... | 55        |
| 3.9 AC Conducted Emission Measurement.....                      | 60        |
| 3.10 Antenna Requirements.....                                  | 62        |
| <b>4 List of Measuring Equipment .....</b>                      | <b>63</b> |
| <b>5 Uncertainty of Evaluation.....</b>                         | <b>65</b> |
| <b>Appendix A. AC Conducted Emission Test Result</b>            |           |
| <b>Appendix B. Radiated Spurious Emission</b>                   |           |
| <b>Appendix C. Radiated Spurious Emission Plots</b>             |           |
| <b>Appendix D. Duty Cycle Plots</b>                             |           |
| <b>Appendix E. Setup Photographs</b>                            |           |



### History of this test report

| Report No. | Version | Description                  | Issued Date   |
|------------|---------|------------------------------|---------------|
| FR042916A  | 01      | Initial issue of report      | Aug. 14, 2020 |
| FR042916A  | 02      | Revising antenna information | Aug. 20, 2020 |
|            |         |                              |               |
|            |         |                              |               |
|            |         |                              |               |
|            |         |                              |               |
|            |         |                              |               |
|            |         |                              |               |
|            |         |                              |               |
|            |         |                              |               |
|            |         |                              |               |
|            |         |                              |               |
|            |         |                              |               |
|            |         |                              |               |
|            |         |                              |               |
|            |         |                              |               |
|            |         |                              |               |
|            |         |                              |               |
|            |         |                              |               |
|            |         |                              |               |
|            |         |                              |               |



### Summary of Test Result

| Report Clause | Ref Std. Clause    | Test Items   | Result (PASS/FAIL) | Remark                                   |
|---------------|--------------------|--|--------------------|--|
| 3.1           | 15.247(a)(1)       | Number of Channels                                 | Pass               | -  |
| 3.2           | 15.247(a)(1)       | Hopping Channel Separation                         | Pass               | -  |
| 3.3           | 15.247(a)(1)       | Dwell Time of Each Channel                         | Pass               | -  |
| 3.4           | 15.247(a)(1)       | 20dB Bandwidth                                     | Pass               | -  |
| 3.4           | 2.1049             | 99% Occupied Bandwidth                             | Reporting only     | -  |
| 3.5           | 15.247(b)(1)       | Peak Output Power                                  | Pass               | -  |
| 3.6           | 15.247(d)          | Conducted Band Edges                               | Pass               | -  |
| 3.7           | 15.247(d)          | Conducted Spurious Emission                        | Pass               | -  |
| 3.8           | 15.247(d)          | Radiated Band Edges and Radiated Spurious Emission | Pass               | Under limit<br>6.45 dB at<br>191.990 MHz |
| 3.9           | 15.207             | AC Conducted Emission                              | Pass               | Under limit<br>8.06 dB at<br>0.530 MHz   |
| 3.10          | 15.203 & 15.247(b) | Antenna Requirement                                | Pass               | -  |

**Declaration of Conformity:**

The test results with all measurement uncertainty excluded are presented in accordance with the regulation limits or requirements declared by manufacturers.

**Comments and Explanations:**

The declared of product specification for EUT presented in the report are provided by the manufacturer, and the manufacturer takes all the responsibilities for the accuracy of product specification.

Reviewed by: Wii Chang

Report Producer: Vivian Hsu



# 1 General Description

## 1.1 Product Feature of Equipment Under Test

| Product Feature                 |                                |
|---------------------------------|--------------------------------|
| Equipment                       | Scanner                        |
| Brand Name                      | Zebra                          |
| Model Name                      | CS6080                         |
| FCC ID                          | UZ7CS6080                      |
| Sample 1                        | non-MFI                        |
| Sample 2                        | non-MFI (HC)                   |
| Sample 3                        | with MFI                       |
| Sample 4                        | with MFI (HC)                  |
| EUT supports Radios application | NFC/WPC<br>Bluetooth BR/EDR/LE |
| HW Version                      | EV2                            |
| SW Version                      | N15                            |
| MFD                             | 08MAY20                        |
| EUT Stage                       | Engineering Sample             |

Remark: The above EUT's information was declared by manufacturer.

| Specification of Accessories |            |       |             |                |
|------------------------------|------------|-------|-------------|----------------|
| Adapter                      | Brand Name | Zebra | Part Number | PWR-WUA5V6W0WW |
| Battery                      | Brand Name | Zebra | Model Name  | BT-000413      |
| USB Cable 1                  | Brand Name | Zebra | Part Number | CB-000707-01   |
| USB Cable 2                  | Brand Name | Zebra | Part Number | CB-000707-02   |

| Supported Unit Used in Test Configuration and System |            |       |              |              |
|--|------------|-------|--------------|--------------|
| USB type C cable 1                                   | Brand Name | Zebra | Part Number  | CB-000722-01 |
| USB type C cable 2                                   | Brand Name | Zebra | Part Number  | CB-000723-01 |
| HC Cradle  | Brand Name | Zebra | Model Number | CR6080-PC    |



## 1.2 Product Specification of Equipment Under Test

| Standards-related Product Specification |   |
|---|---|
| Tx/Rx Frequency Range                   | 2402 MHz ~ 2480 MHz   |
| Number of Channels                      | 79  |
| Carrier Frequency of Each Channel       | 2402+n*1 MHz; n=0~78  |
| Maximum Output Power to Antenna         | Bluetooth BR(1Mbps) : 6.07 dBm (0.0040 W)<br>Bluetooth EDR (2Mbps) : 7.79 dBm (0.0060 W)<br>Bluetooth EDR (3Mbps) : 7.73 dBm (0.0059 W) |
| Antenna Type                            | Chip Antenna type with gain 1.76 dBi  |
| Type of Modulation                      | Bluetooth BR (1Mbps) : GFSK<br>Bluetooth EDR (2Mbps) : $\pi/4$ -DQPSK<br>Bluetooth EDR (3Mbps) : 8-DPSK                                 |

## 1.3 Modification of EUT

No modifications are made to the EUT during all test items.

## 1.4 Testing Location

|                    |   |         |
|--------------------|---|---------|
| Test Site          | SPORTON INTERNATIONAL INC. EMC & Wireless Communications Laboratory   |         |
| Test Site Location | No.52, Huaya 1st Rd., Guishan Dist.,<br>Taoyuan City, Taiwan (R.O.C.)<br>TEL: +886-3-327-3456<br>FAX: +886-3-328-4978 |         |
| Test Site No.      | <b>Sporton Site No.</b>   |         |
|                    | TH05-HY   | CO05-HY |

**Note:** The test site complies with ANSI C63.4 2014 requirement.

|                    |   |  |
|--------------------|---|--|
| Test Site          | SPORTON INTERNATIONAL INC. EMC & Wireless Communications Laboratory   |  |
| Test Site Location | No.58, Aly. 75, Ln. 564, Wenhua 3rd, Rd., Guishan Dist.,<br>Taoyuan City, Taiwan (R.O.C.)<br>TEL: +886-3-327-0868<br>FAX: +886-3-327-0855 |  |
| Test Site No.      | <b>Sporton Site No.</b>   |  |
|                    | 03CH16-HY   |  |

**Note:** The test site complies with ANSI C63.4 2014 requirement.

FCC designation No.: TW1190 and TW0007



## **1.5 Applicable Standards**

According to the specifications of the manufacturer, the EUT must comply with the requirements of the following standards:

- ♦ FCC Part 15 Subpart C §15.247
- ♦ FCC KDB Publication No. 558074 D01 DTS Meas. Guidance v05r02
- ♦ FCC KDB 414788 D01 Radiated Test Site v01r01
- ♦ ANSI C63.10-2013

### **Remark:**

1. All test items were verified and recorded according to the standards and without any deviation during the test.
2. The TAF code is not including all the FCC KDB listed without accreditation.
3. This EUT has also been tested and complied with the requirements of FCC Part 15, Subpart B, recorded in a separate test report.



## 2 Test Configuration of Equipment Under Test

### 2.1 Carrier Frequency Channel

| Frequency Band  | Channel | Freq. (MHz) | Channel | Freq. (MHz) | Channel | Freq. (MHz) |
|-----------------|---------|-------------|---------|-------------|---------|-------------|
| 2400-2483.5 MHz | 0       | 2402        | 27      | 2429        | 54      | 2456        |
|                 | 1       | 2403        | 28      | 2430        | 55      | 2457        |
|                 | 2       | 2404        | 29      | 2431        | 56      | 2458        |
|                 | 3       | 2405        | 30      | 2432        | 57      | 2459        |
|                 | 4       | 2406        | 31      | 2433        | 58      | 2460        |
|                 | 5       | 2407        | 32      | 2434        | 59      | 2461        |
|                 | 6       | 2408        | 33      | 2435        | 60      | 2462        |
|                 | 7       | 2409        | 34      | 2436        | 61      | 2463        |
|                 | 8       | 2410        | 35      | 2437        | 62      | 2464        |
|                 | 9       | 2411        | 36      | 2438        | 63      | 2465        |
|                 | 10      | 2412        | 37      | 2439        | 64      | 2466        |
|                 | 11      | 2413        | 38      | 2440        | 65      | 2467        |
|                 | 12      | 2414        | 39      | 2441        | 66      | 2468        |
|                 | 13      | 2415        | 40      | 2442        | 67      | 2469        |
|                 | 14      | 2416        | 41      | 2443        | 68      | 2470        |
|                 | 15      | 2417        | 42      | 2444        | 69      | 2471        |
|                 | 16      | 2418        | 43      | 2445        | 70      | 2472        |
|                 | 17      | 2419        | 44      | 2446        | 71      | 2473        |
|                 | 18      | 2420        | 45      | 2447        | 72      | 2474        |
|                 | 19      | 2421        | 46      | 2448        | 73      | 2475        |
|                 | 20      | 2422        | 47      | 2449        | 74      | 2476        |
|                 | 21      | 2423        | 48      | 2450        | 75      | 2477        |
|                 | 22      | 2424        | 49      | 2451        | 76      | 2478        |
|                 | 23      | 2425        | 50      | 2452        | 77      | 2479        |
|                 | 24      | 2426        | 51      | 2453        | 78      | 2480        |
|                 | 25      | 2427        | 52      | 2454        | -       | -           |
|                 | 26      | 2428        | 53      | 2455        | -       | -           |





| Channel | Frequency | Bluetooth Average Output Power |          |          |
|---------|-----------|--------------------------------|----------|----------|
|         |           | GFSK / 1Mbps                   |          |          |
|         |           | DH1                            | DH3      | DH5      |
| Ch00    | 2402MHz   | 5.50 dBm                       | 5.54 dBm | 5.58 dBm |
| Ch39    | 2441MHz   | 4.84 dBm                       | 4.87 dBm | 4.90 dBm |
| Ch78    | 2480MHz   | 4.74 dBm                       | 4.80 dBm | 4.88 dBm |

| Channel | Frequency | Bluetooth Average Output Power |          |          |
|---------|-----------|--------------------------------|----------|----------|
|         |           | $\pi/4$ -DQPSK / 2Mbps         |          |          |
|         |           | 2DH1                           | 2DH3     | 2DH5     |
| Ch00    | 2402MHz   | 5.51 dBm                       | 5.65 dBm | 5.70 dBm |
| Ch39    | 2441MHz   | 4.90 dBm                       | 4.98 dBm | 5.02 dBm |
| Ch78    | 2480MHz   | 4.81 dBm                       | 4.85 dBm | 4.93 dBm |

| Channel | Frequency | Bluetooth Average Output Power |          |          |
|---------|-----------|--------------------------------|----------|----------|
|         |           | 8-DPSK / 3Mbps                 |          |          |
|         |           | 3DH1                           | 3DH3     | 3DH5     |
| Ch00    | 2402MHz   | 5.48 dBm                       | 5.66 dBm | 5.64 dBm |
| Ch39    | 2441MHz   | 4.83 dBm                       | 4.96 dBm | 4.94 dBm |
| Ch78    | 2480MHz   | 4.76 dBm                       | 4.86 dBm | 4.89 dBm |



| Channel | Frequency | Bluetooth Peak Output Power |          |          |
|---------|-----------|-----------------------------|----------|----------|
|         |           | GFSK / 1Mbps                |          |          |
|         |           | DH1                         | DH3      | DH5      |
| Ch00    | 2402MHz   | 5.92 dBm                    | 6.06 dBm | 6.07 dBm |
| Ch39    | 2441MHz   | 5.75 dBm                    | 5.76 dBm | 5.77 dBm |
| Ch78    | 2480MHz   | 5.50 dBm                    | 5.51 dBm | 5.52 dBm |

| Channel | Frequency | Bluetooth Peak Output Power |          |          |
|---------|-----------|-----------------------------|----------|----------|
|         |           | $\pi/4$ -DQPSK / 2Mbps      |          |          |
|         |           | 2DH1                        | 2DH3     | 2DH5     |
| Ch00    | 2402MHz   | 7.74 dBm                    | 7.76 dBm | 7.79 dBm |
| Ch39    | 2441MHz   | 7.44 dBm                    | 7.51 dBm | 7.55 dBm |
| Ch78    | 2480MHz   | 7.36 dBm                    | 7.37 dBm | 7.50 dBm |

| Channel | Frequency | Bluetooth Peak Output Power |          |          |
|---------|-----------|-----------------------------|----------|----------|
|         |           | 8-DPSK / 3Mbps              |          |          |
|         |           | 3DH1                        | 3DH3     | 3DH5     |
| Ch00    | 2402MHz   | 7.71 dBm                    | 7.72 dBm | 7.73 dBm |
| Ch39    | 2441MHz   | 7.41 dBm                    | 7.45 dBm | 7.51 dBm |
| Ch78    | 2480MHz   | 7.32 dBm                    | 7.33 dBm | 7.44 dBm |

Remark: The data rate was set in 2Mbps for all the test items due to the highest RF output power.



### 2.2 Test Mode

- a. The EUT has been associated with peripherals and configuration operated in a manner tended to maximize its emission characteristics in a typical application. Frequency range investigated: conduction emission (150 kHz to 30 MHz), radiation emission (9 kHz to the 10th harmonic of the highest fundamental frequency or to 40 GHz, whichever is lower). For radiated measurement, pre-scanned in three orthogonal panels, X, Y, Z. The worst cases (Z plane) were recorded in this report, and the worst mode of radiated spurious emissions is Bluetooth 2Mbps mode, and recorded in this report.
- b. AC power line Conducted Emission was tested under maximum output power.

The following summary table is showing all test modes to demonstrate in compliance with the standard.

| Summary table of Test Cases  |  |                                       |                               |
|--|--|---------------------------------------|-------------------------------|
| Test Item  | Data Rate / Modulation   |                                       |                               |
|  | Bluetooth BR 1Mbps<br>GFSK   | Bluetooth EDR 2Mbps<br>$\pi/4$ -DQPSK | Bluetooth EDR 3Mbps<br>8-DPSK |
| Conducted Test Cases   | Mode 1: CH00_2402 MHz  | Mode 4: CH00_2402 MHz                 | Mode 7: CH00_2402 MHz         |
|  | Mode 2: CH39_2441 MHz  | Mode 5: CH39_2441 MHz                 | Mode 8: CH39_2441 MHz         |
|  | Mode 3: CH78_2480 MHz  | Mode 6: CH78_2480 MHz                 | Mode 9: CH78_2480 MHz         |
| Radiated Test Cases  | Bluetooth EDR 2Mbps $\pi/4$ -DQPSK   |                                       |                               |
|  | Mode 1: CH00_2402 MHz  |                                       |                               |
|  | Mode 2: CH39_2441 MHz  |                                       |                               |
| Mode 3: CH78_2480 MHz  |  |                                       |                               |
| AC Conducted Emission  | Mode 1 :NFC On + Bluetooth Link + Scanner (CS6080) scan bar code + USB Cable (Charging from Adapter (PWR-WUA5V6W0WW)) for Sample 1 |                                       |                               |
| <b>Remark:</b> <ol style="list-style-type: none"> <li>For radiated test cases, the worst mode data rate 2Mbps was reported only since the highest RF output power in the preliminary tests. The conducted spurious emissions and conducted band edge measurement for other data rates were not worse than 2Mbps, and no other significantly frequencies found in conducted spurious emission.</li> <li>For Radiated Test Cases, the tests were performed with USB Cable 1 and Sample 1.</li> </ol> |  |                                       |                               |

## 2.3 Connection Diagram of Test System

### <AC Conducted Emission>

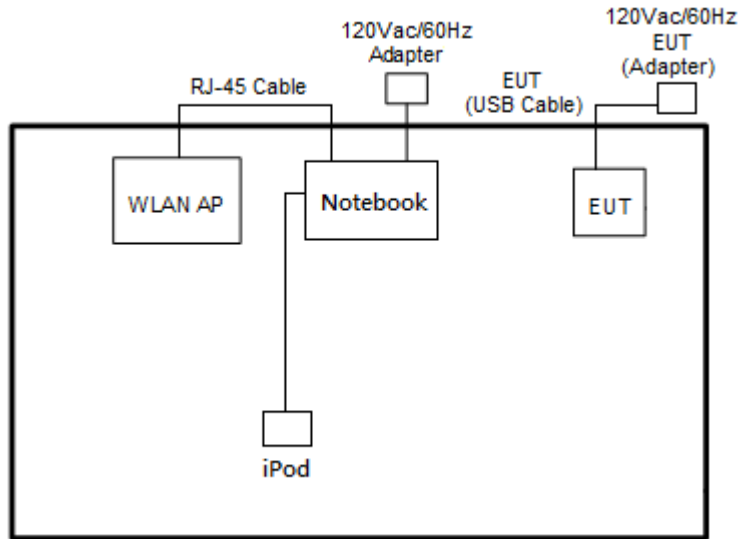

### <Bluetooth Tx Mode>

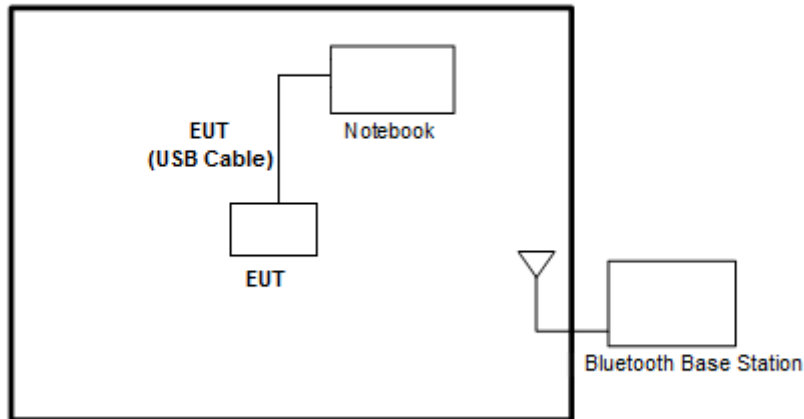

## 2.4 Support Unit used in test configuration and system

| Item | Equipment              | Trade Name | Model Name     | FCC ID  | Data Cable      | Power Cord   |
|------|------------------------|------------|----------------|---|-----------------|--|
| 1.   | Bluetooth Base Station | R&S        | CBT32          | N/A   | N/A             | Unshielded, 1.8 m  |
| 2.   | WLAN AP                | ASUS       | RT-AC66U       | MSQ-RTAC66U                                     | N/A             | Unshielded, 1.8 m  |
| 3.   | Notebook               | DELL       | Latitude E6320 | FCC DoC/<br>Contains<br>FCC ID:<br>QDS-BRCM1054 | N/A             | AC I/P:<br>Unshielded, 1.2 m<br>DC O/P:<br>Shielded, 1.8 m |
| 4.   | iPod                   | Apple      | A1285          | FCC DoC   | Shielded, 1.0 m | N/A  |

## 2.5 EUT Operation Test Setup

The RF test items, make the EUT get into the engineering modes to contact with base station to provide channel selection, power level, data rate and the application type and for continuous transmitting signals.

## 2.6 Measurement Results Explanation Example

**For all conducted test items:**

The offset level is set in the spectrum analyzer to compensate the RF cable loss and attenuator factor between EUT conducted output port and spectrum analyzer. With the offset compensation, the spectrum analyzer reading level is exactly the EUT RF output level.

Example:

The spectrum analyzer offset is derived from RF cable loss and attenuator factor.

*Offset = RF cable loss + attenuator factor.*

Following shows an offset computation example with cable loss 4.2 dB and 10dB attenuator.

$$\begin{aligned}
 \text{Offset(dB)} &= \text{RF cable loss(dB)} + \text{attenuator factor(dB)}. \\
 &= 4.2 + 10 = 14.2 \text{ (dB)}
 \end{aligned}$$

### 3 Test Result

#### 3.1 Number of Channel Measurement

##### 3.1.1 Limits of Number of Hopping Frequency

Frequency hopping systems in the 2400-2483.5 MHz band shall use at least 15 channels.

##### 3.1.2 Measuring Instruments

See list of measuring equipment of this test report.

##### 3.1.3 Test Procedure

1. The testing follows ANSI C63.10-2013 clause 7.8.3.
2. The RF output of EUT was connected to the spectrum analyzer by RF cable and attenuator. The path loss was compensated to the results for each measurement.
3. Set to the maximum power setting and enable the EUT transmit continuously.
4. Enable the EUT hopping function.
5. Use the following spectrum analyzer settings: Span = the frequency band of operation; RBW = 300kHz; VBW  $\geq$  RBW; Sweep = auto; Detector function = peak; Trace = max hold.
6. The number of hopping frequency used is defined as the number of total channel.
7. Record the measurement data derived from spectrum analyzer.

##### 3.1.4 Test Setup

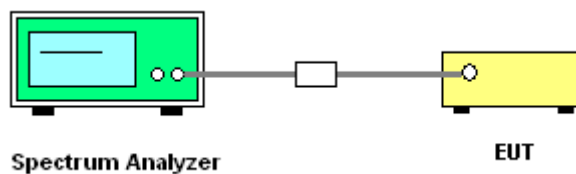



3.1.5 Test Result of Number of Hopping Frequency

|                 |           |                     |         |
|-----------------|-----------|---------------------|---------|
| Test Engineer : | Owen Yang | Temperature :       | 21~25°C |
|                 |           | Relative Humidity : | 51~54%  |

| Number of Hopping (Channel) | Adaptive Frequency Hopping (Channel) | Limits (Channel) | Pass/Fail |
|-----------------------------|--------------------------------------|------------------|-----------|
| 79                          | 20                                   | > 15             | Pass      |

Number of Hopping Channel Plot on Channel 00 - 78

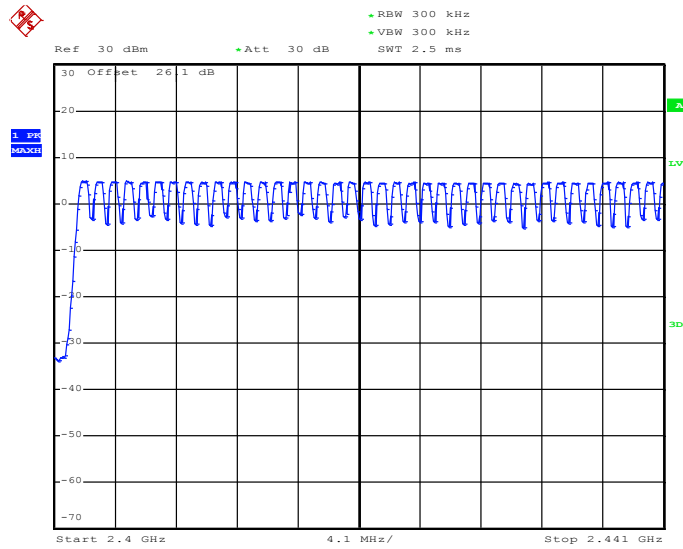

Date: 28.MAY.2020 14:13:39

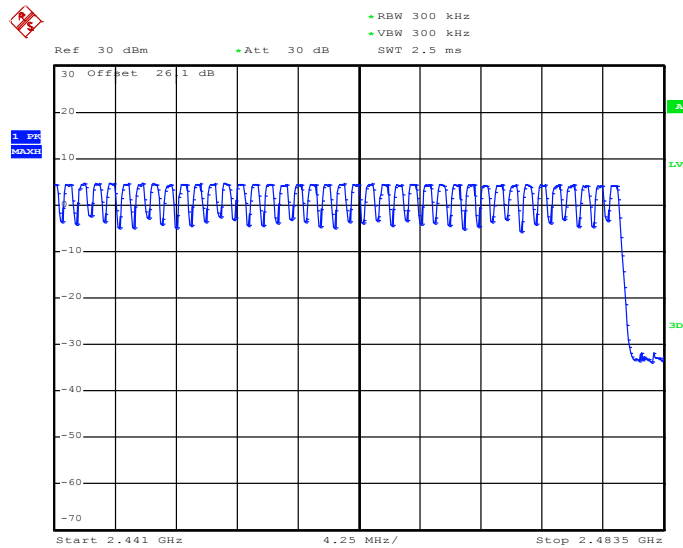

Date: 28.MAY.2020 14:14:20

## 3.2 Hopping Channel Separation Measurement

### 3.2.1 Limit of Hopping Channel Separation

Frequency hopping systems operating in the 2400-2483.5 MHz band may have hopping channel carrier frequencies that are separated by 25 kHz or two-thirds of the 20 dB bandwidth of the hopping channel, whichever is greater.

### 3.2.2 Measuring Instruments

See list of measuring equipment of this test report.

### 3.2.3 Test Procedures

1. The testing follows ANSI C63.10-2013 clause 7.8.2.
2. The RF output of EUT was connected to the spectrum analyzer by RF cable and attenuator. The path loss was compensated to the results for each measurement.
3. Set to the maximum power setting and enable the EUT transmit continuously.
4. Enable the EUT hopping function.
5. Use the following spectrum analyzer settings:  
Span = wide enough to capture the peaks of two adjacent channels;  
RBW = 300kHz; VBW  $\geq$  RBW; Sweep = auto; Detector function = peak; Trace = max hold.
6. Measure and record the results in the test report.

### 3.2.4 Test Setup







3.2.5 Test Result of Hopping Channel Separation

|                 |           |                     |         |
|-----------------|-----------|---------------------|---------|
| Test Engineer : | Owen Yang | Temperature :       | 21~25°C |
|                 |           | Relative Humidity : | 51~54%  |

| Mod. | Data Rate | NTX | CH. | Freq. (MHz) | Hopping Channel Separation Measurement (MHz) | Hopping Channel Separation Limit (MHz) | Pass/Fail |
|------|-----------|-----|-----|-------------|--|--|-----------|
| DH   | 1Mbps     | 1   | 0   | 2402        | 1.002  | 0.6347                                 | Pass      |
| DH   | 1Mbps     | 1   | 39  | 2441        | 0.996  | 0.6347                                 | Pass      |
| DH   | 1Mbps     | 1   | 78  | 2480        | 1.002  | 0.6347                                 | Pass      |
| 2DH  | 2Mbps     | 1   | 0   | 2402        | 0.996  | 0.8960                                 | Pass      |
| 2DH  | 2Mbps     | 1   | 39  | 2441        | 0.996  | 0.8920                                 | Pass      |
| 2DH  | 2Mbps     | 1   | 78  | 2480        | 1.008  | 0.8920                                 | Pass      |
| 3DH  | 3Mbps     | 1   | 0   | 2402        | 1.002  | 0.8880                                 | Pass      |
| 3DH  | 3Mbps     | 1   | 39  | 2441        | 1.002  | 0.8880                                 | Pass      |
| 3DH  | 3Mbps     | 1   | 78  | 2480        | 1.002  | 0.8880                                 | Pass      |

<1Mbps>

Channel Separation Plot on Channel 00 - 01

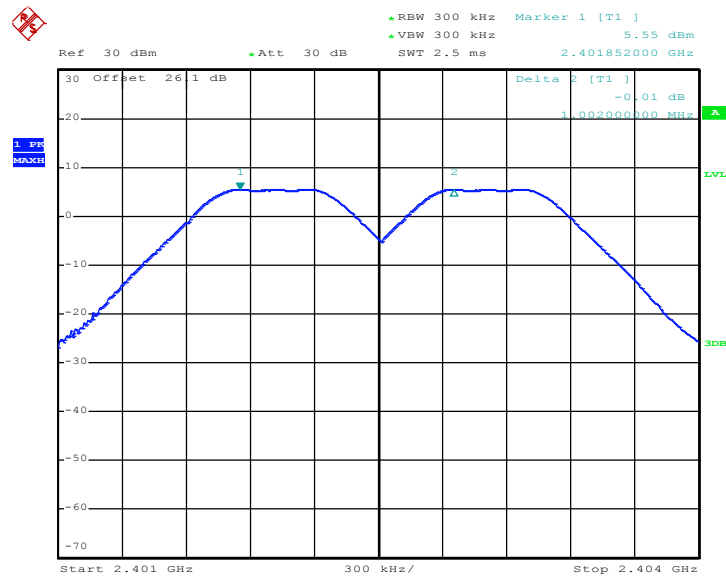

Date: 28.MAY.2020 15:35:49



Channel Separation Plot on Channel 39 - 40

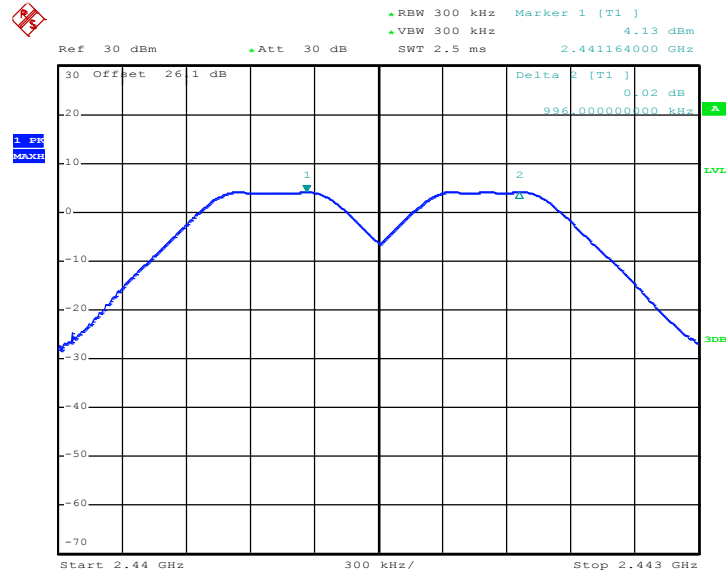

Date: 28.MAY.2020 13:51:00

Channel Separation Plot on Channel 77 - 78

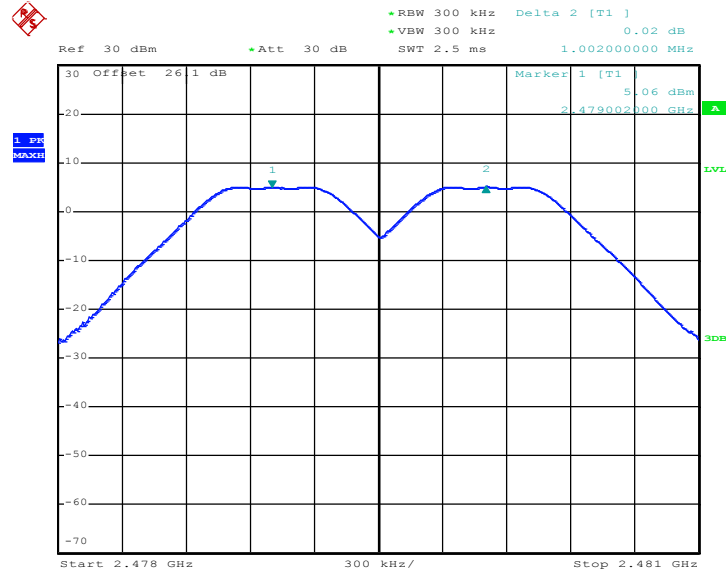

Date: 28.MAY.2020 15:36:55



<2Mbps>

Channel Separation Plot on Channel 00 - 01

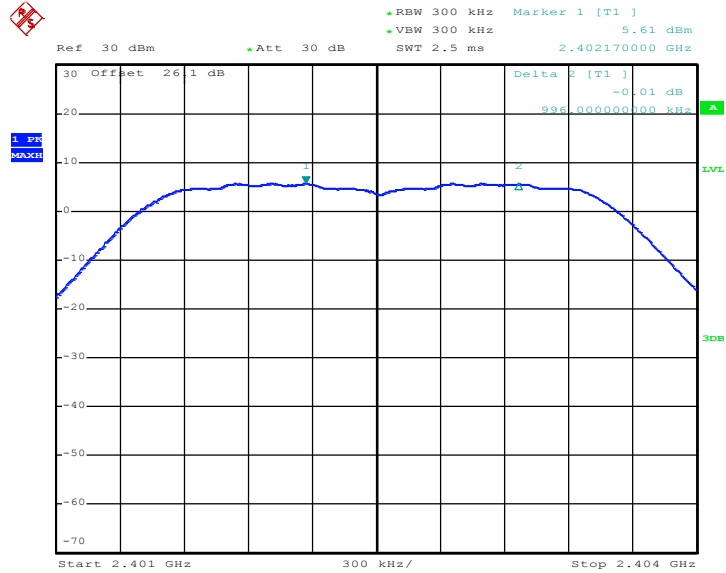

Date: 28.MAY.2020 15:40:07

Channel Separation Plot on Channel 39 - 40

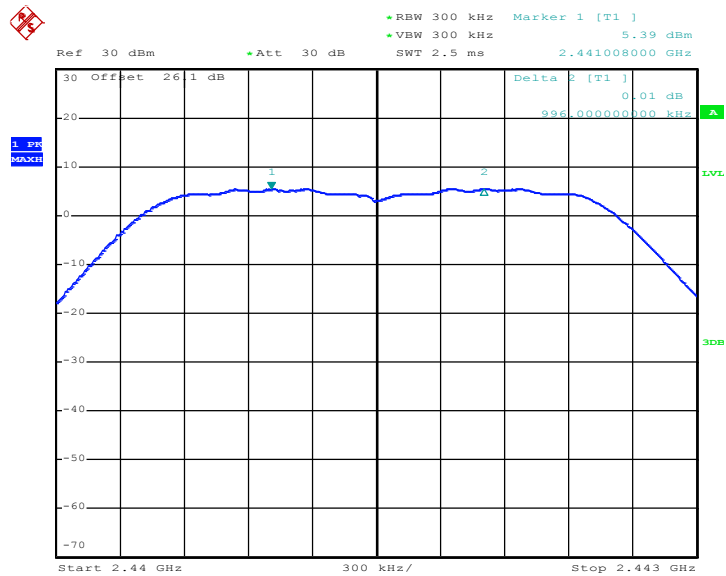

Date: 28.MAY.2020 15:42:21



Channel Separation Plot on Channel 77 - 78

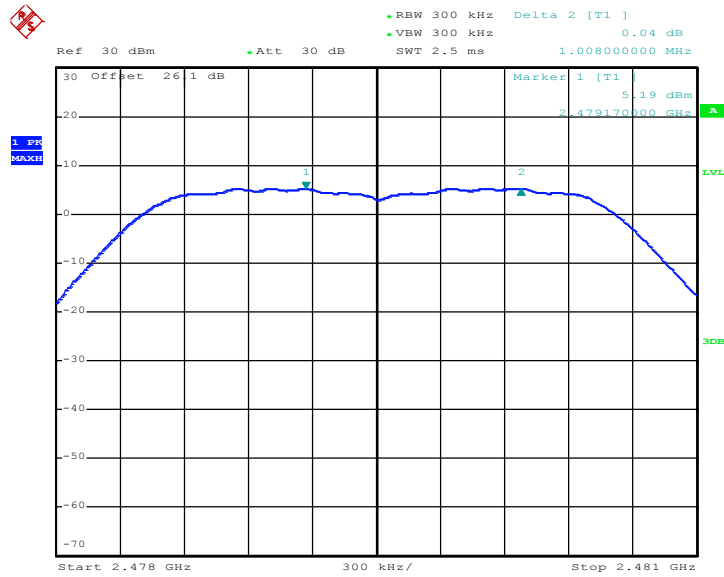

Date: 28.MAY.2020 15:34:26

<3Mbps>

Channel Separation Plot on Channel 00 - 01

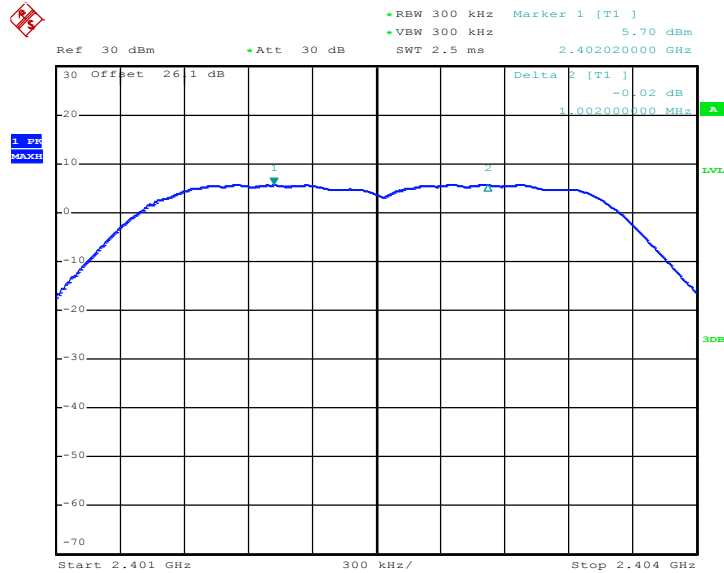

Date: 28.MAY.2020 16:05:06



Channel Separation Plot on Channel 39 - 40

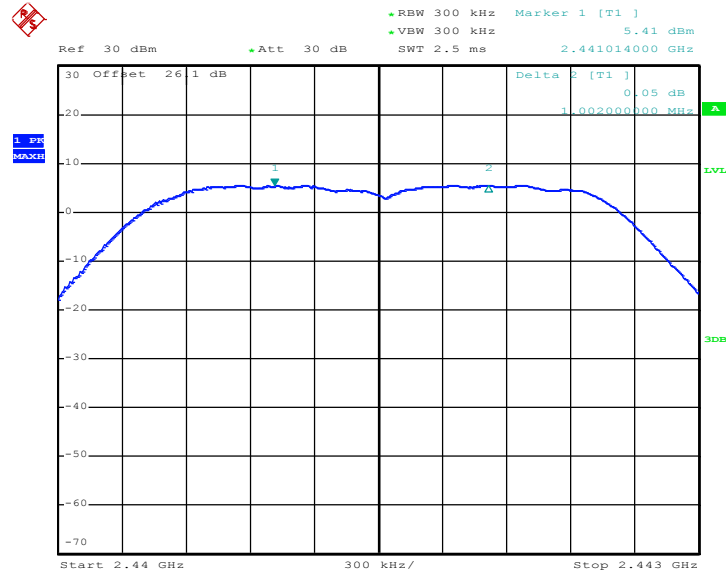

Date: 28.MAY.2020 16:03:42

Channel Separation Plot on Channel 77 - 78

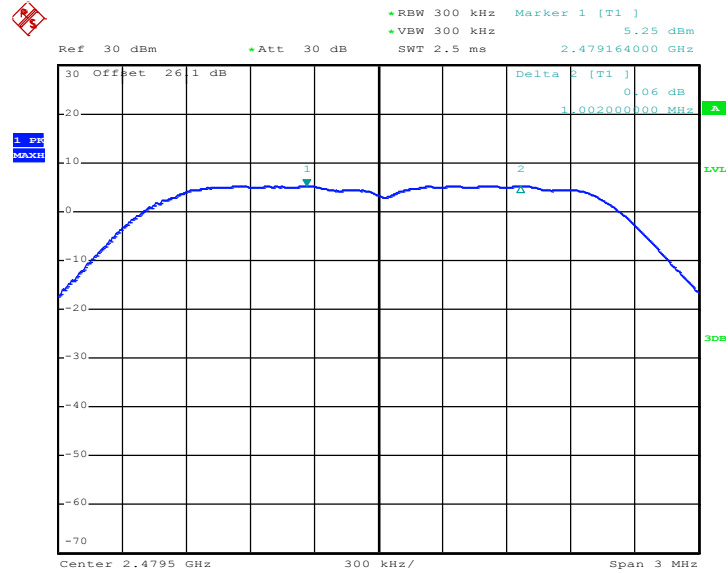

Date: 28.MAY.2020 16:12:07

### 3.3 Dwell Time Measurement

#### 3.3.1 Limit of Dwell Time

The average time of occupancy on any channel shall not be greater than 0.4 seconds within a period of 0.4 seconds multiplied by the number of hopping channels employed.

#### 3.3.2 Measuring Instruments

See list of measuring equipment of this test report.

#### 3.3.3 Test Procedures

1. The testing follows ANSI C63.10-2013 clause 7.8.4.
2. The RF output of EUT was connected to the spectrum analyzer by RF cable and attenuator. The path loss was compensated to the results for each measurement.
3. Set to the maximum power setting and enable the EUT transmit continuously.
4. Enable the EUT hopping function.
5. Use the following spectrum analyzer settings: Span = zero span, centered on a hopping channel; RBW = 1 MHz; VBW  $\geq$  RBW; Sweep = as necessary to capture the entire dwell time per hopping channel; Detector function = peak; Trace = max hold.
6. Measure and record the results in the test report.

#### 3.3.4 Test Setup





3.3.5 Test Result of Dwell Time

|                 |           |                     |         |
|-----------------|-----------|---------------------|---------|
| Test Engineer : | Owen Yang | Temperature :       | 21~25°C |
|                 |           | Relative Humidity : | 51~54%  |

| Mod.  | Hopping Channel Number Rate | Hops Over Occupancy Time(hops) | Package Transfer Time (msec) | Dwell Time (sec) | Limits (sec) | Pass/Fail |
|-------|-----------------------------|--------------------------------|------------------------------|------------------|--------------|-----------|
| Nomal | 79                          | 106.67                         | 2.90                         | 0.31             | 0.4          | Pass      |
| AFH   | 20                          | 53.33                          | 2.90                         | 0.15             | 0.4          | Pass      |

Package Transfer Time Plot

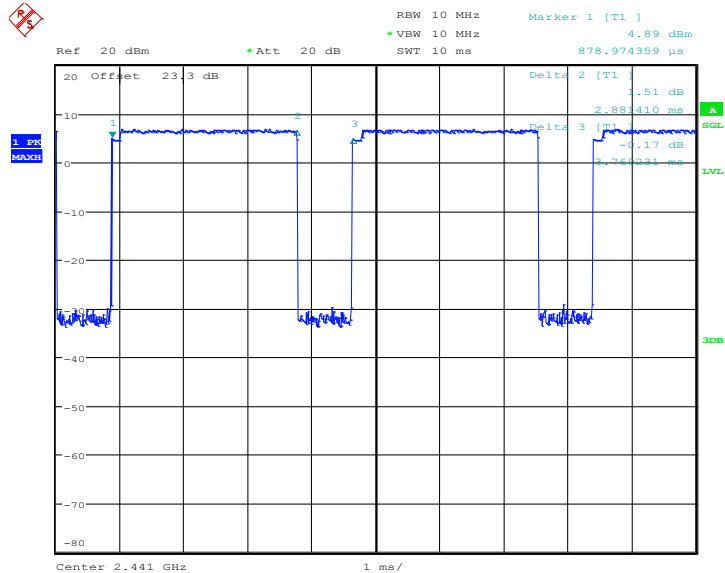

Remark:

1. In normal mode, hopping rate is 1600 hops/s with 6 slots in 79 hopping channels. With channel hopping rate (1600 / 6 / 79) in Occupancy Time Limit (0.4 x 79) (s), Hops Over Occupancy Time comes to (1600 / 6 / 79) x (0.4 x 79) = 106.67 hops.
2. In AFH mode, hopping rate is 800 hops/s with 6 slots in 20 hopping channels. With channel hopping rate (800 / 6 / 20) in Occupancy Time Limit (0.4 x 20) (s), Hops Over Occupancy Time comes to (800 / 6 / 20) x (0.4 x 20) = 53.33 hops.
3. Dwell Time(s) = Hops Over Occupancy Time (hops) x Package Transfer Time

### 3.4 20dB and 99% Bandwidth Measurement

#### 3.4.1 Limit of 20dB and 99% Bandwidth

Reporting only

#### 3.4.2 Measuring Instruments

See list of measuring equipment of this test report.

#### 3.4.3 Test Procedures

1. The testing follows ANSI C63.10-2013 clause 6.9.2 and 6.9.3.
2. The RF output of EUT was connected to the spectrum analyzer by RF cable and attenuator. The path loss was compensated to the results for each measurement.
3. Set to the maximum power setting and enable the EUT transmit continuously.
4. Use the following spectrum analyzer settings for 20dB Bandwidth measurement.  
Span = approximately 2 to 5 times the 20 dB bandwidth, centered on a hopping channel;  
RBW  $\geq$  1% of the 20 dB bandwidth; VBW  $\geq$  RBW; Sweep = auto; Detector function = peak;  
Trace = max hold.
5. Use the following spectrum analyzer settings for 99 % Bandwidth measurement.  
Span = approximately 1.5 to 5 times the 99% bandwidth, centered on a hopping channel;  
RBW  $\geq$  1-5% of the 99% bandwidth; VBW  $\geq$  3 \* RBW; Sweep = auto; Detector function = peak;  
Trace = max hold.
6. Measure and record the results in the test report.

#### 3.4.4 Test Setup







3.4.5 Test Result of 20dB Bandwidth

|                 |           |                     |         |
|-----------------|-----------|---------------------|---------|
| Test Engineer : | Owen Yang | Temperature :       | 21~25°C |
|                 |           | Relative Humidity : | 51~54%  |

| Mod. | Data Rate | NTX | CH. | Freq. (MHz) | 20db BW (MHz) | Pass/Fail |
|------|-----------|-----|-----|-------------|---------------|-----------|
| DH   | 1Mbps     | 1   | 0   | 2402        | 0.952         | Pass      |
| DH   | 1Mbps     | 1   | 39  | 2441        | 0.952         | Pass      |
| DH   | 1Mbps     | 1   | 78  | 2480        | 0.952         | Pass      |
| 2DH  | 2Mbps     | 1   | 0   | 2402        | 1.344         | Pass      |
| 2DH  | 2Mbps     | 1   | 39  | 2441        | 1.338         | Pass      |
| 2DH  | 2Mbps     | 1   | 78  | 2480        | 1.338         | Pass      |
| 3DH  | 3Mbps     | 1   | 0   | 2402        | 1.332         | Pass      |
| 3DH  | 3Mbps     | 1   | 39  | 2441        | 1.332         | Pass      |
| 3DH  | 3Mbps     | 1   | 78  | 2480        | 1.332         | Pass      |



<1Mbps>

20 dB Bandwidth Plot on Channel 00

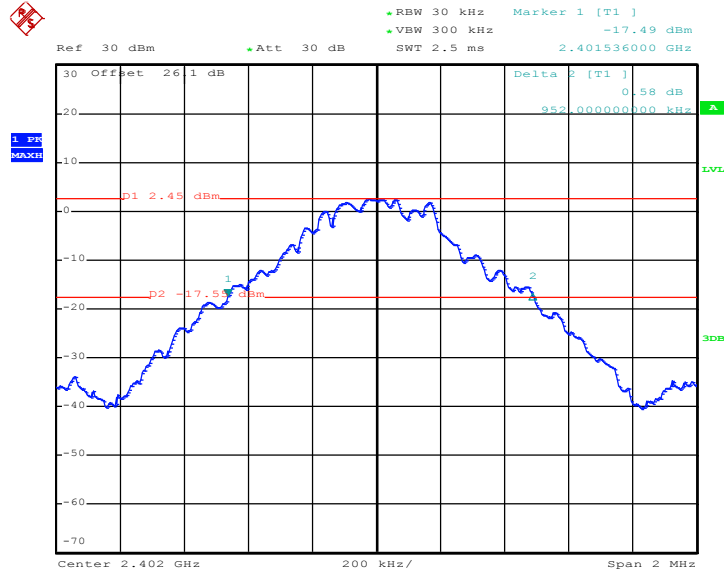

Date: 28.MAY.2020 13:45:13

20 dB Bandwidth Plot on Channel 39

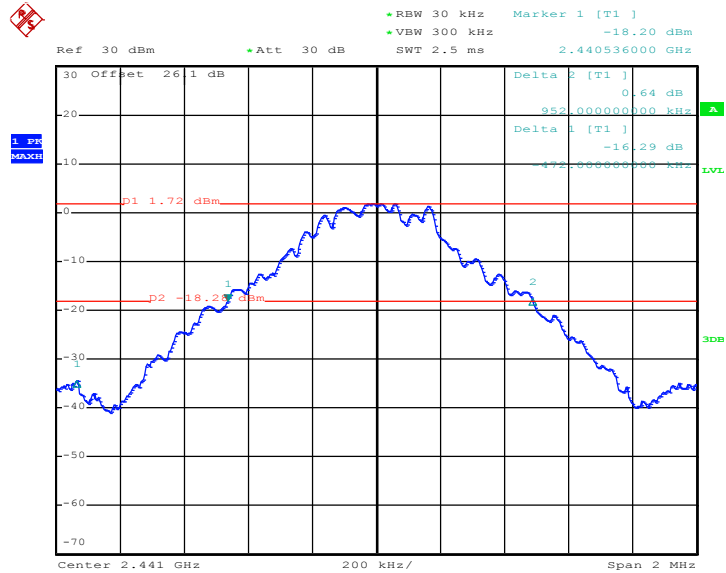

Date: 28.MAY.2020 13:52:35



20 dB Bandwidth Plot on Channel 78

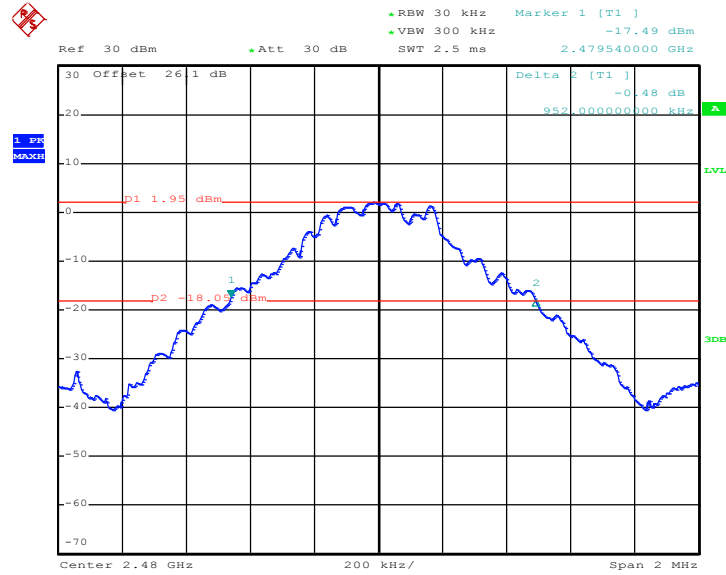

Date: 28.MAY.2020 13:58:29

<2Mbps>

20 dB Bandwidth Plot on Channel 00

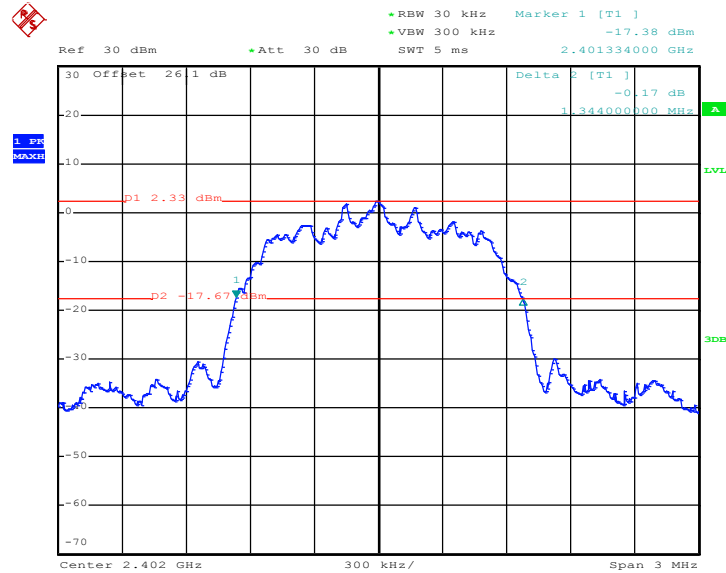

Date: 28.MAY.2020 14:26:29



### 20 dB Bandwidth Plot on Channel 39

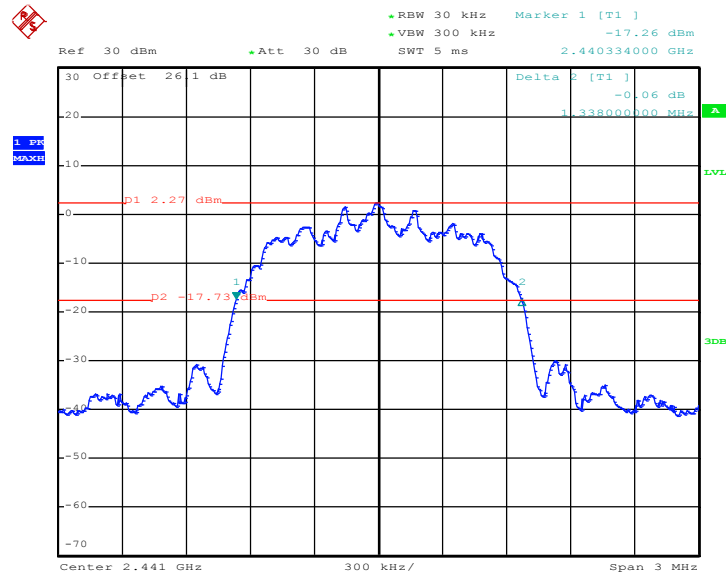

Date: 28.MAY.2020 15:17:20

### 20 dB Bandwidth Plot on Channel 78

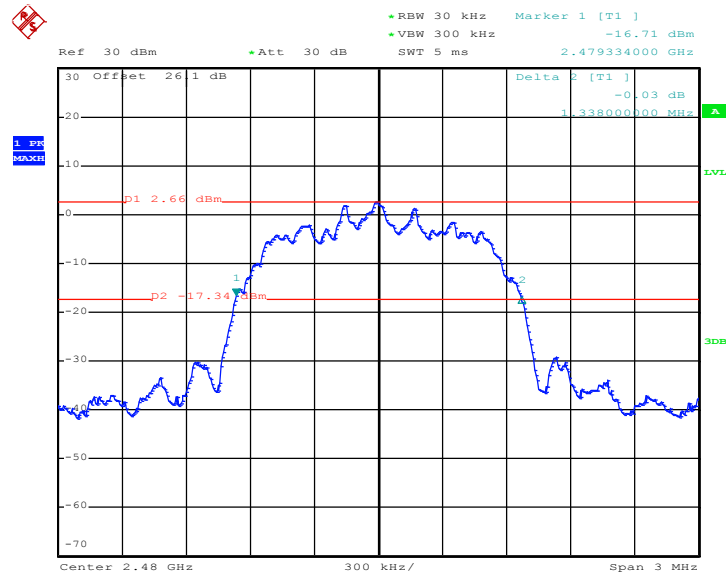

Date: 28.MAY.2020 15:48:00



<3Mbps>

20 dB Bandwidth Plot on Channel 00

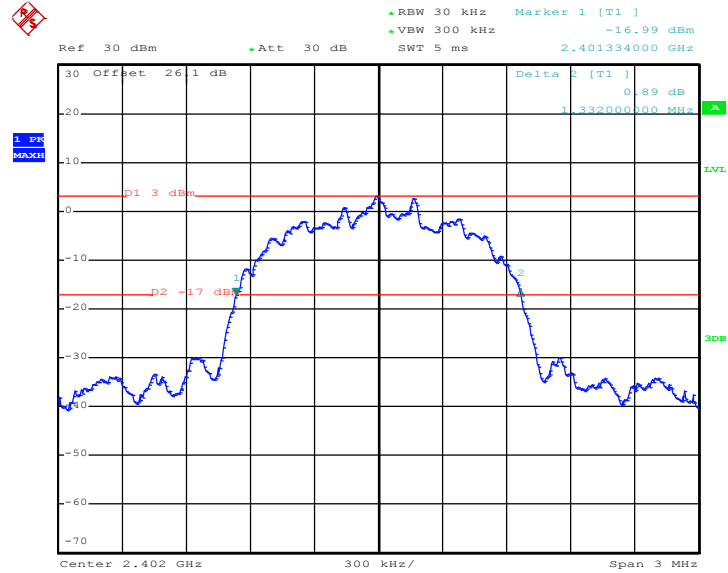

Date: 28.MAY.2020 15:58:30

20 dB Bandwidth Plot on Channel 39

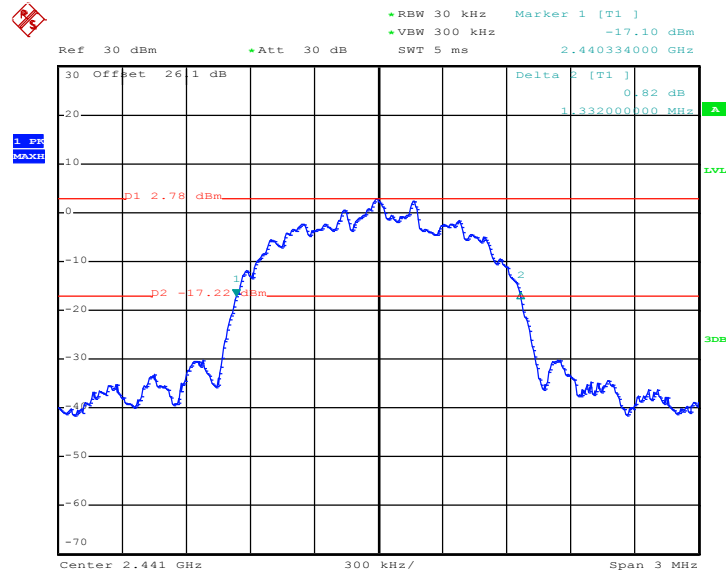

Date: 28.MAY.2020 16:06:50



20 dB Bandwidth Plot on Channel 78

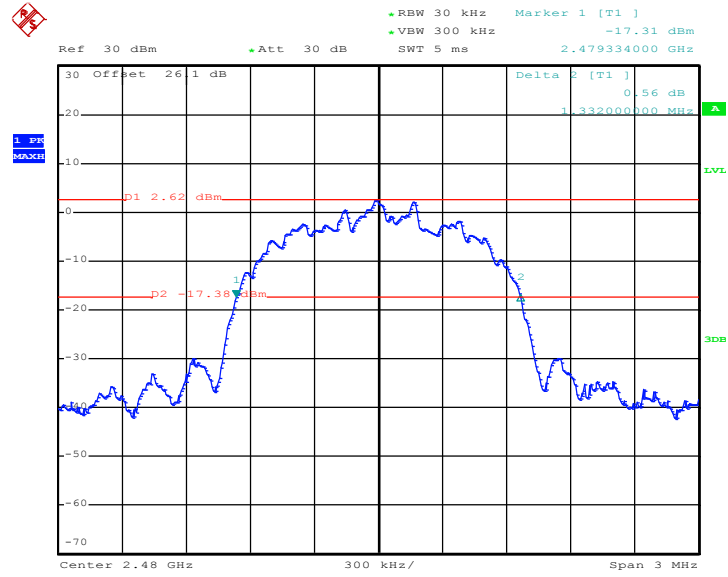

Date: 28.MAY.2020 16:13:22



3.4.6 Test Result of 99% Occupied Bandwidth

|                 |           |                     |         |
|-----------------|-----------|---------------------|---------|
| Test Engineer : | Owen Yang | Temperature :       | 21~25°C |
|                 |           | Relative Humidity : | 51~54%  |

| Mod. | Data Rate | Ntx | CH. | Freq. (MHz) | 99% Bandwidth (MHz) | Pass/Fail |
|------|-----------|-----|-----|-------------|---------------------|-----------|
| DH   | 1Mbps     | 1   | 0   | 2402        | 0.856               | Pass      |
| DH   | 1Mbps     | 1   | 39  | 2441        | 0.864               | Pass      |
| DH   | 1Mbps     | 1   | 78  | 2480        | 0.860               | Pass      |
| 2DH  | 2Mbps     | 1   | 0   | 2402        | 1.196               | Pass      |
| 2DH  | 2Mbps     | 1   | 39  | 2441        | 1.196               | Pass      |
| 2DH  | 2Mbps     | 1   | 78  | 2480        | 1.200               | Pass      |
| 3DH  | 3Mbps     | 1   | 0   | 2402        | 1.200               | Pass      |
| 3DH  | 3Mbps     | 1   | 39  | 2441        | 1.208               | Pass      |
| 3DH  | 3Mbps     | 1   | 78  | 2480        | 1.204               | Pass      |

<1Mbps>

99% Occupied Bandwidth Plot on Channel 00

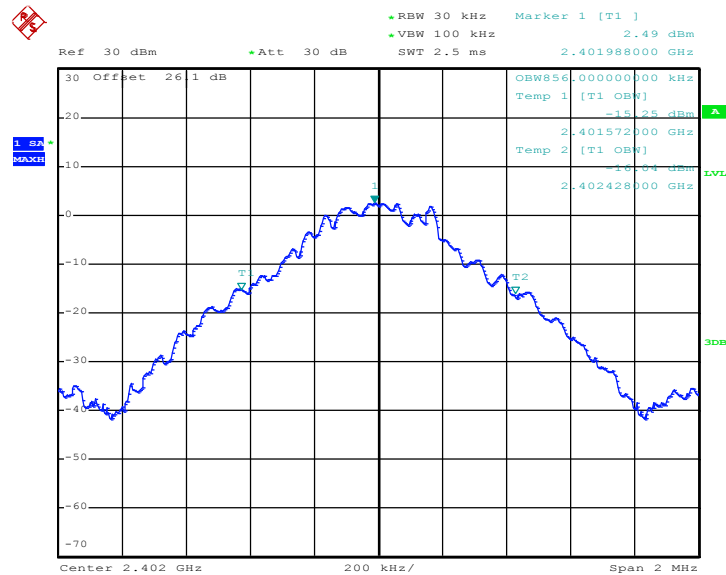

Date: 28.MAY.2020 13:46:23



99% Occupied Bandwidth Plot on Channel 39

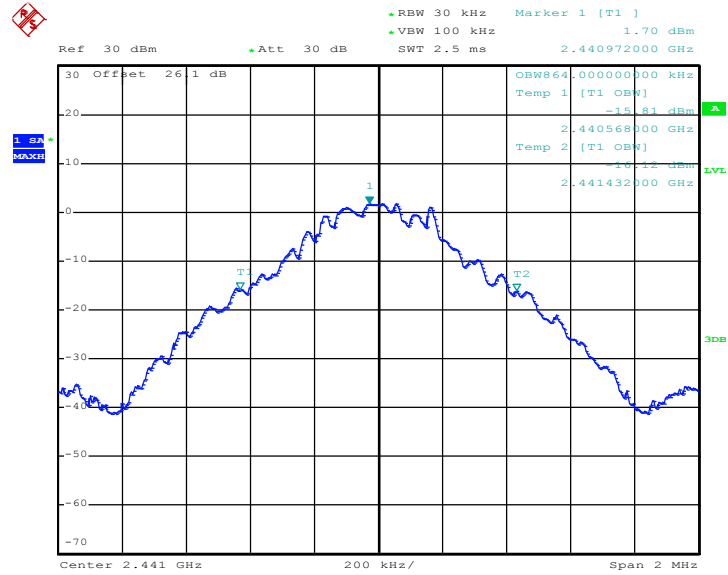

Date: 28.MAY.2020 13:53:16

99% Occupied Bandwidth Plot on Channel 78

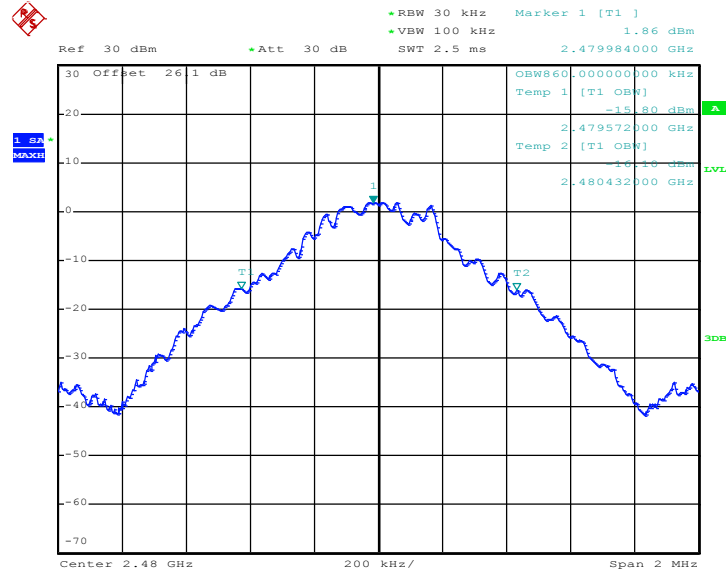

Date: 28.MAY.2020 14:00:06





<2Mbps>

99% Occupied Bandwidth Plot on Channel 00

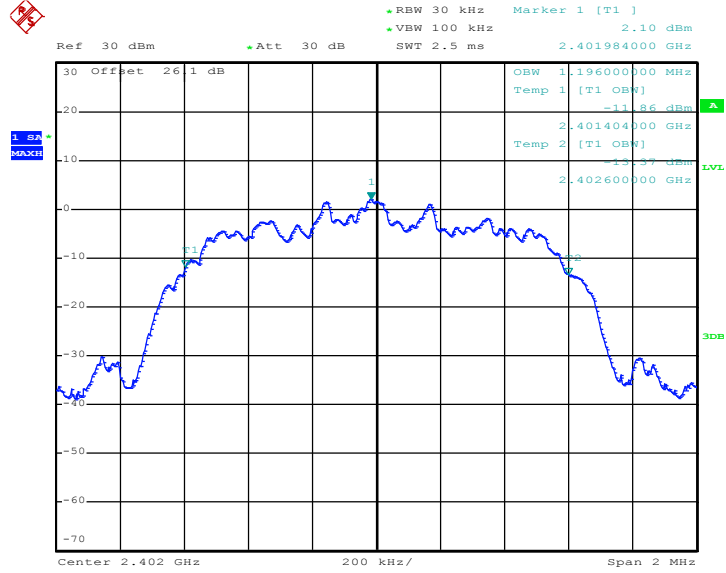

Date: 28.MAY.2020 14:28:58

99% Occupied Bandwidth Plot on Channel 39

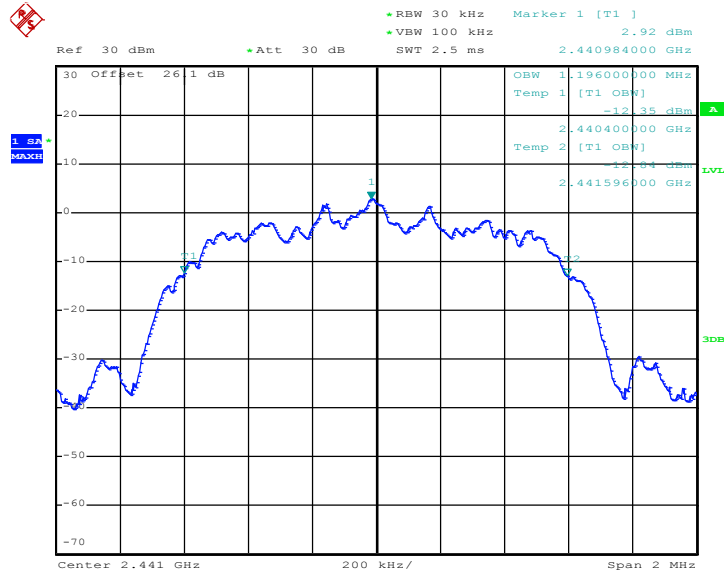

Date: 28.MAY.2020 15:31:14



99% Occupied Bandwidth Plot on Channel 78

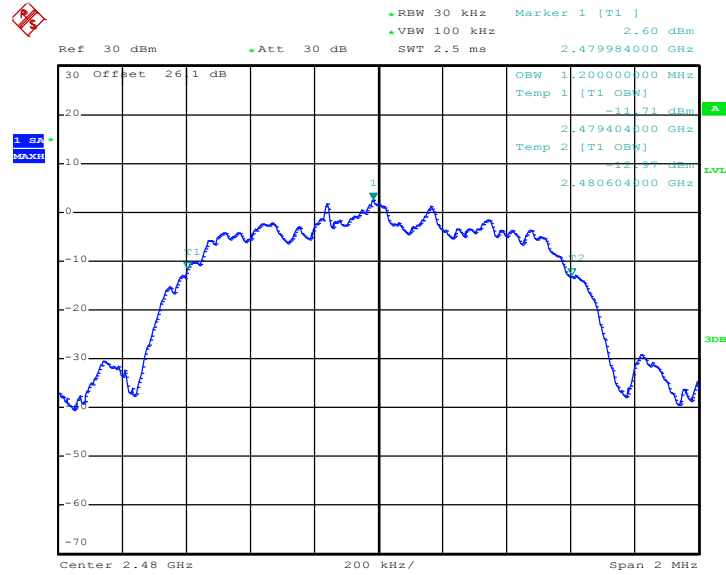

Date: 28.MAY.2020 15:49:28

<3Mbps>

99% Occupied Bandwidth Plot on Channel 00

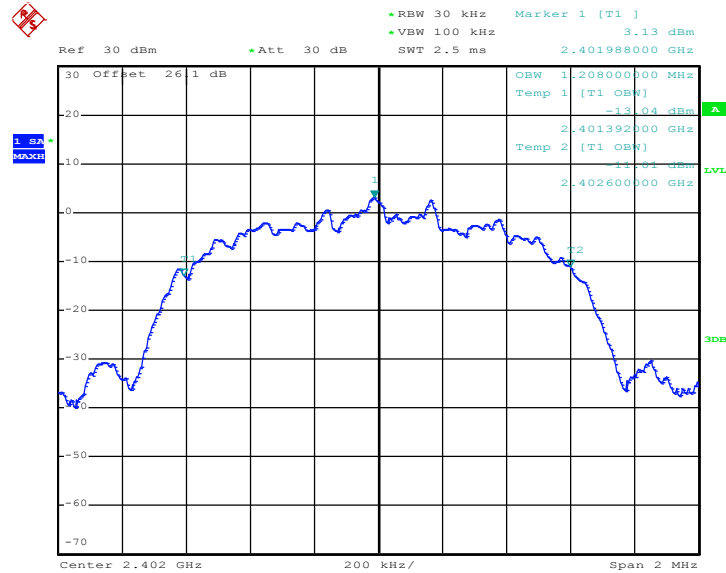

Date: 28.MAY.2020 16:00:07



99% Occupied Bandwidth Plot on Channel 39

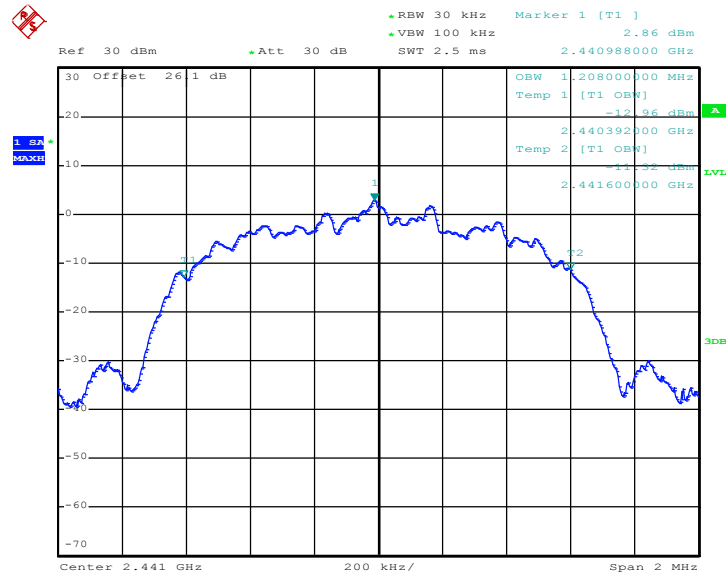

Date: 28.MAY.2020 16:07:29

99% Occupied Bandwidth Plot on Channel 78

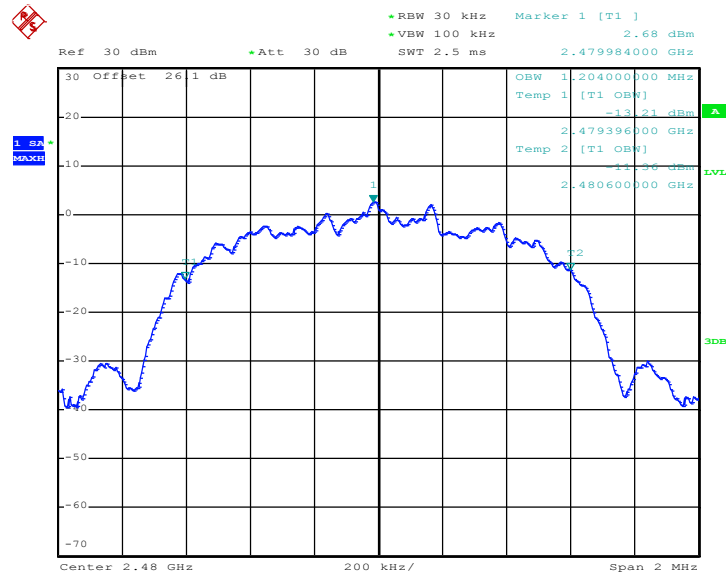

Date: 28.MAY.2020 16:14:43

Note: The occupied channel bandwidth is maintained within the band of operation for all of the modulations.

## 3.5 Output Power Measurement

### 3.5.1 Limit of Output Power

The maximum peak conducted output power of the intentional radiator shall not exceed the following:  
For frequency hopping systems operating in the 2400-2483.5 MHz band employing at least 75 non-overlapping hopping channels, and all frequency hopping systems in the 5725-5850 MHz band: 1 watt. For all other frequency hopping systems in the 2400-2483.5 MHz band 0.125 watts.

### 3.5.2 Measuring Instruments

See list of measuring equipment of this test report.

### 3.5.3 Test Procedures

1. The testing follows ANSI C63.10-2013 clause 7.8.5.
2. The RF output of EUT was connected to the power meter by RF cable and attenuator. The path loss was compensated to the results for each measurement.
3. Set to the maximum power setting and enable the EUT transmit continuously.
4. Measure the conducted output power with cable loss and record the results in the test report.
5. Measure and record the results in the test report.

### 3.5.4 Test Setup

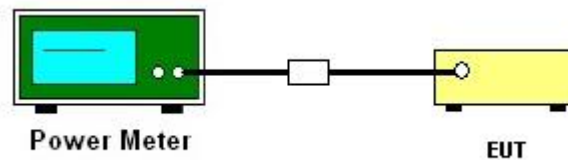



3.5.5 Test Result of Peak Output Power

|                 |  |           |  |                     |         |
|-----------------|--|-----------|--|---------------------|---------|
| Test Engineer : |  | Owen Yang |  | Temperature :       | 21~25°C |
|                 |  |           |  | Relative Humidity : | 51~54%  |

| DH  | CH. | N <sub>TX</sub> | Peak Power (dBm) | Power Limit (dBm) | Test Result |
|-----|-----|-----------------|------------------|-------------------|-------------|
| DH1 | 0   | 1               | 6.07             | 30.00             | Pass        |
|     | 39  | 1               | 5.77             | 30.00             | Pass        |
|     | 78  | 1               | 5.52             | 30.00             | Pass        |

| 2DH  | CH. | N <sub>TX</sub> | Peak Power (dBm) | Power Limit (dBm) | Test Result |
|------|-----|-----------------|------------------|-------------------|-------------|
| 2DH1 | 0   | 1               | 7.79             | 20.97             | Pass        |
|      | 39  | 1               | 7.55             | 20.97             | Pass        |
|      | 78  | 1               | 7.50             | 20.97             | Pass        |

| 3DH  | CH. | N <sub>TX</sub> | Peak Power (dBm) | Power Limit (dBm) | Test Result |
|------|-----|-----------------|------------------|-------------------|-------------|
| 3DH1 | 0   | 1               | 7.73             | 20.97             | Pass        |
|      | 39  | 1               | 7.51             | 20.97             | Pass        |
|      | 78  | 1               | 7.44             | 20.97             | Pass        |

3.5.6 Test Result of Average Output Power (Reporting Only)

|                 |  |           |  |                     |         |
|-----------------|--|-----------|--|---------------------|---------|
| Test Engineer : |  | Owen Yang |  | Temperature :       | 21~25°C |
|                 |  |           |  | Relative Humidity : | 51~54%  |

| DH  | CH. | N <sub>TX</sub> | Average Power (dBm) | Duty Factor (dB) |
|-----|-----|-----------------|---------------------|------------------|
| DH1 | 0   | 1               | 5.58                | 1.14             |
|     | 39  | 1               | 4.90                | 1.14             |
|     | 78  | 1               | 4.88                | 1.14             |

| 2DH  | CH. | N <sub>TX</sub> | Average Power (dBm) | Duty Factor (dB) |
|------|-----|-----------------|---------------------|------------------|
| 2DH1 | 0   | 1               | 5.70                | 1.14             |
|      | 39  | 1               | 5.02                | 1.14             |
|      | 78  | 1               | 4.93                | 1.14             |

| 3DH  | CH. | N <sub>TX</sub> | Average Power (dBm) | Duty Factor (dB) |
|------|-----|-----------------|---------------------|------------------|
| 3DH1 | 0   | 1               | 5.66                | 1.12             |
|      | 39  | 1               | 4.96                | 1.12             |
|      | 78  | 1               | 4.86                | 1.12             |

## 3.6 Conducted Band Edges Measurement

### 3.6.1 Limit of Band Edges

In any 100 kHz bandwidth outside the intentional radiation frequency band, the radio frequency power shall be at least 20 dB below the highest level of the radiated power. In addition, radiated emissions which fall in the restricted bands must also comply with the radiated emission limits.

### 3.6.2 Measuring Instruments

See list of measuring equipment of this test report.

### 3.6.3 Test Procedures

1. The testing follows ANSI C63.10-2013 clause 7.8.6.
2. Set to the maximum power setting and enable the EUT transmit continuously.

Set RBW = 100kHz, VBW = 300kHz. Band edge emissions must be at least 20 dB down from the highest emission level within the authorized band as measured with a 100kHz RBW. The attenuation shall be 30 dB instead of 20 dB when RMS conducted output power procedure is used.

Enable hopping function of the EUT and then repeat step 2. and 3.

Measure and record the results in the test report.

### 3.6.4 Test Setup

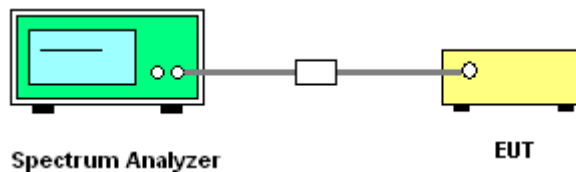



### 3.6.5 Test Result of Conducted Band Edges

|                 |           |                     |         |
|-----------------|-----------|---------------------|---------|
| Test Engineer : | Owen Yang | Temperature :       | 21~25°C |
|                 |           | Relative Humidity : | 51~54%  |

<1Mbps>

#### Low Band Edge Plot on Channel 00

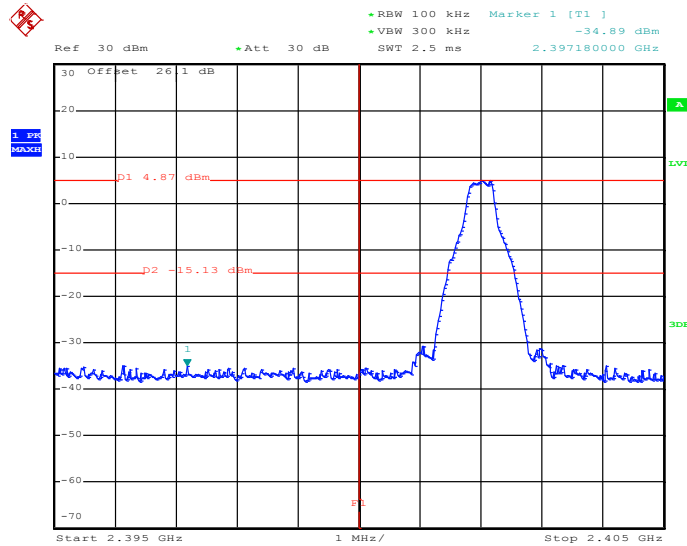

Date: 28.MAY.2020 13:45:38

#### High Band Edge Plot on Channel 78

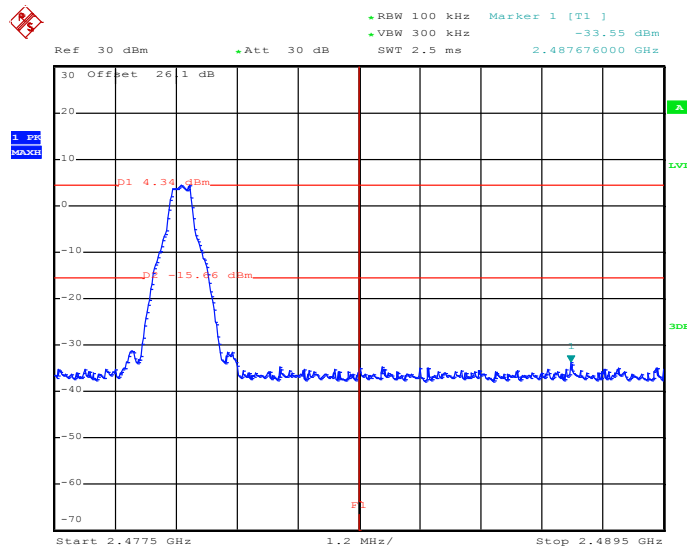

Date: 28.MAY.2020 13:58:57



<2Mbps>

Low Band Edge Plot on Channel 00

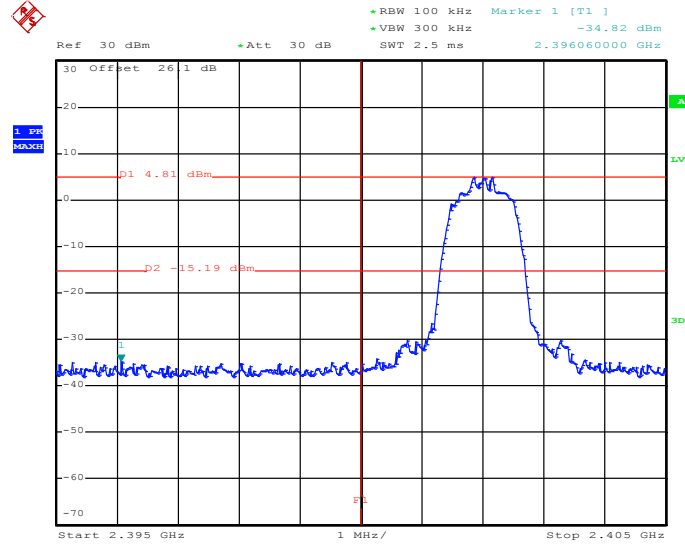

Date: 28.MAY.2020 14:27:45

High Band Edge Plot on Channel 78

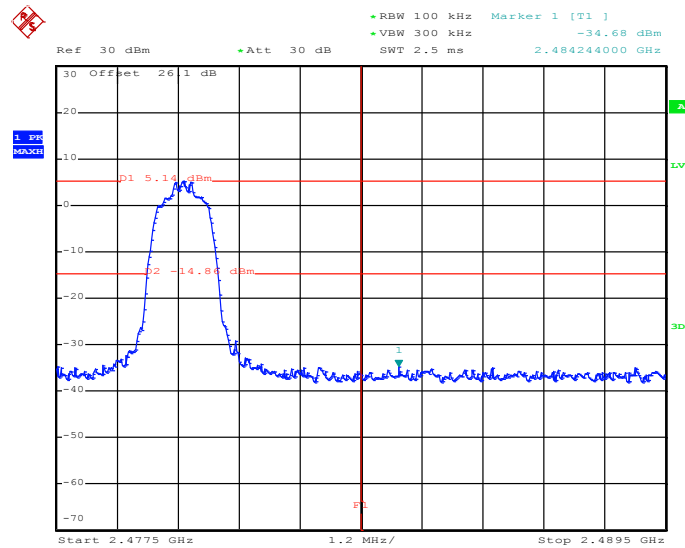

Date: 28.MAY.2020 15:48:23





<3Mbps>

Low Band Edge Plot on Channel 00

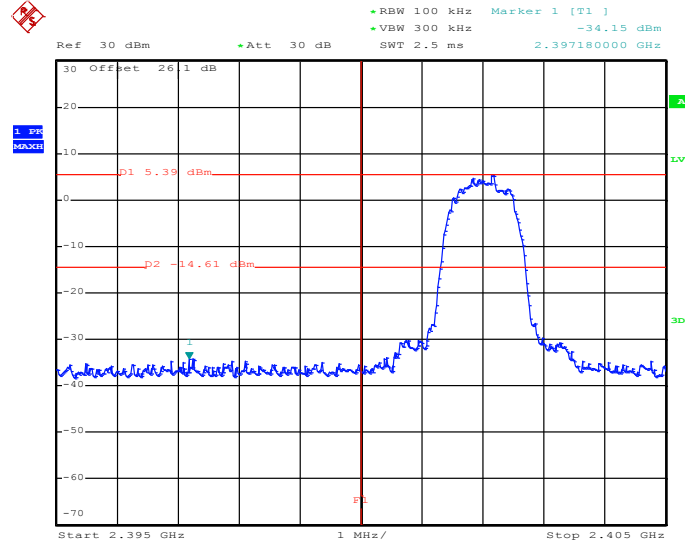

Date: 28.MAY.2020 15:59:03

High Band Edge Plot on Channel 78

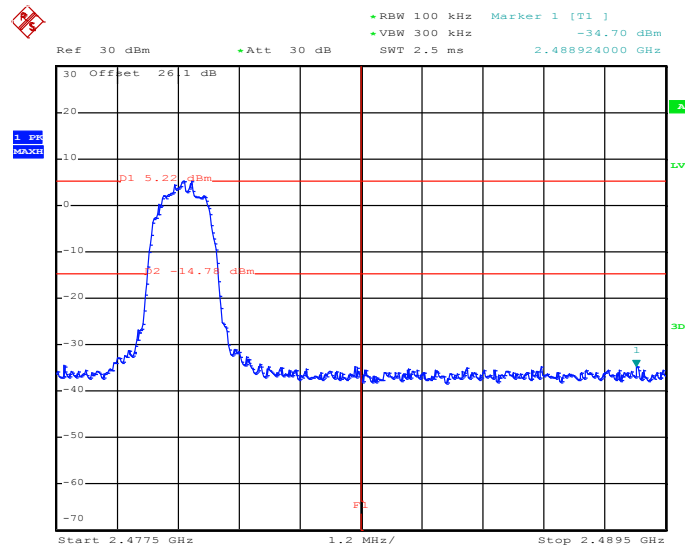

Date: 28.MAY.2020 16:13:43



### 3.6.6 Test Result of Conducted Hopping Mode Band Edges

|                 |           |                     |         |
|-----------------|-----------|---------------------|---------|
| Test Engineer : | Owen Yang | Temperature :       | 21~25°C |
|                 |           | Relative Humidity : | 51~54%  |

<1Mbps>

#### Hopping Mode Low Band Edge Plot

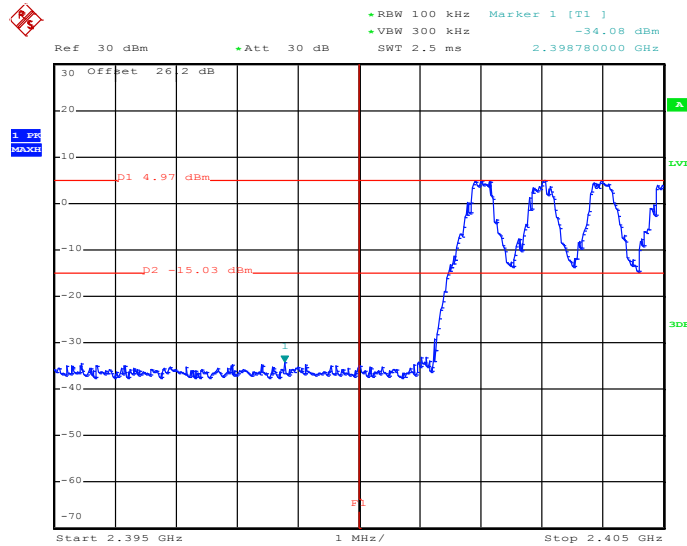

Date: 28.MAY.2020 11:57:03

#### Hopping Mode High Band Edge Plot

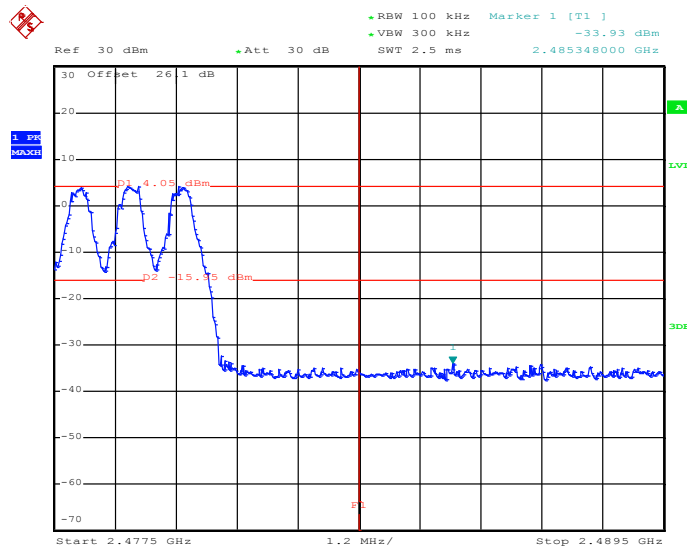

Date: 28.MAY.2020 11:58:55



<2Mbps>

Hopping Mode Low Band Edge Plot

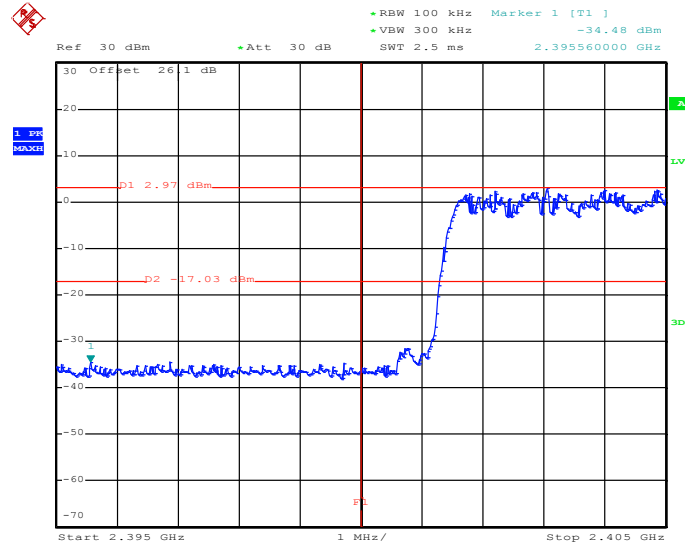

Date: 28.MAY.2020 12:00:48

Hopping Mode High Band Edge Plot

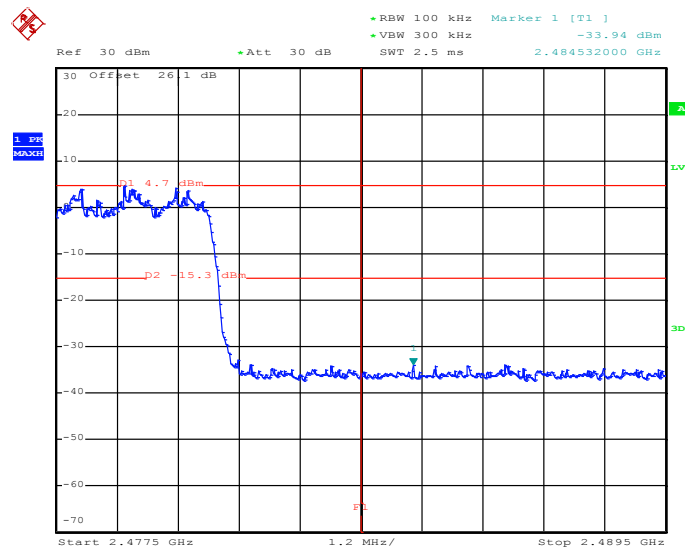

Date: 28.MAY.2020 12:00:00



<3Mbps>

Hopping Mode Low Band Edge Plot

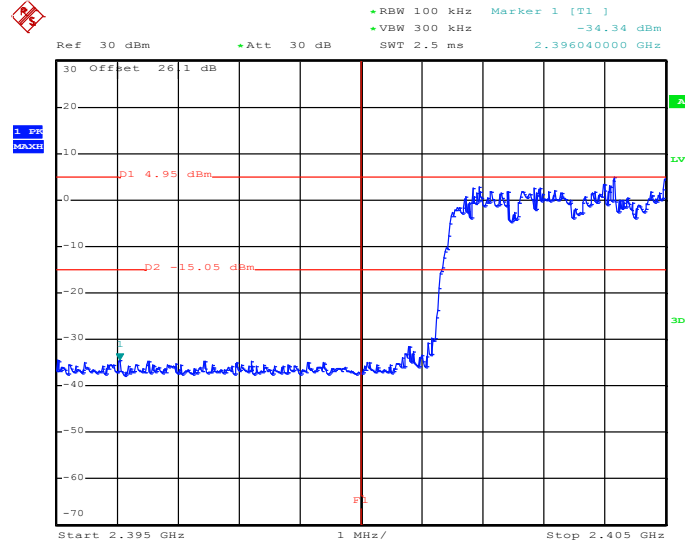

Date: 28.MAY.2020 13:39:58

Hopping Mode High Band Edge Plot

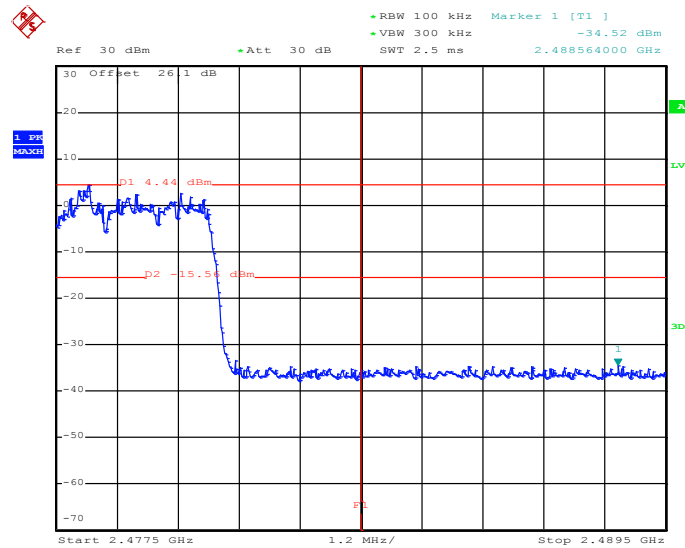

Date: 28.MAY.2020 13:40:38

## 3.7 Conducted Spurious Emission Measurement

### 3.7.1 Limit of Spurious Emission Measurement

In any 100 kHz bandwidth outside the intentional radiation frequency band, the radio frequency power shall be at least 20 dB below the highest level of the radiated power. In addition, radiated emissions which fall in the restricted bands must also comply with the radiated emission limits.

### 3.7.2 Measuring Instruments

See list of measuring equipment of this test report.

### 3.7.3 Test Procedure

1. The testing follows ANSI C63.10-2013 clause 7.8.8.
2. The RF output of EUT was connected to the spectrum analyzer by RF cable and attenuator. The path loss was compensated to the results for each measurement.
3. Set to the maximum power setting and enable the EUT transmit continuously.
4. Set RBW = 100 kHz, VBW = 300kHz, scan up through 10th harmonic. All harmonics / spurs must be at least 20 dB down from the highest emission level within the authorized band as measured with a 100 kHz RBW.
5. Measure and record the results in the test report.
6. The RF fundamental frequency should be excluded against the limit line in the operating frequency band.

### 3.7.4 Test Setup





### 3.7.5 Test Result of Conducted Spurious Emission

|                 |           |                     |         |
|-----------------|-----------|---------------------|---------|
| Test Engineer : | Owen Yang | Temperature :       | 21~25°C |
|                 |           | Relative Humidity : | 51~54%  |

<1Mbps>

CSE Plot on Ch 00 between 30MHz ~ 3 GHz

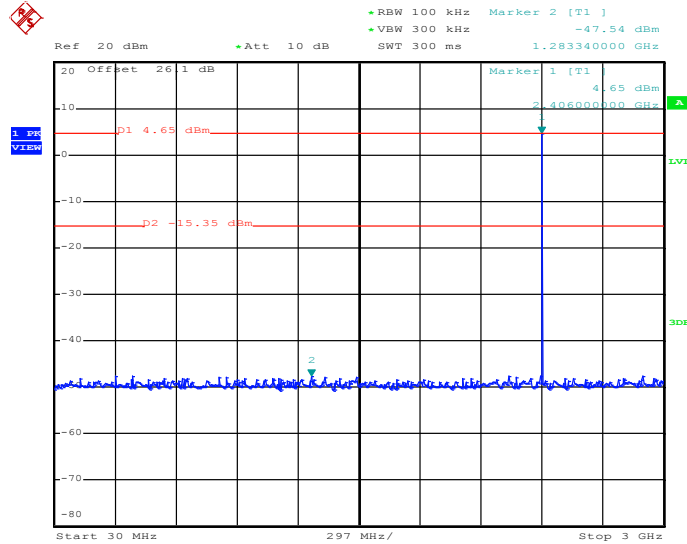

Date: 28.MAY.2020 15:02:47

1Mbps CSE Plot on Ch 00 between 2 GHz ~ 25 GHz

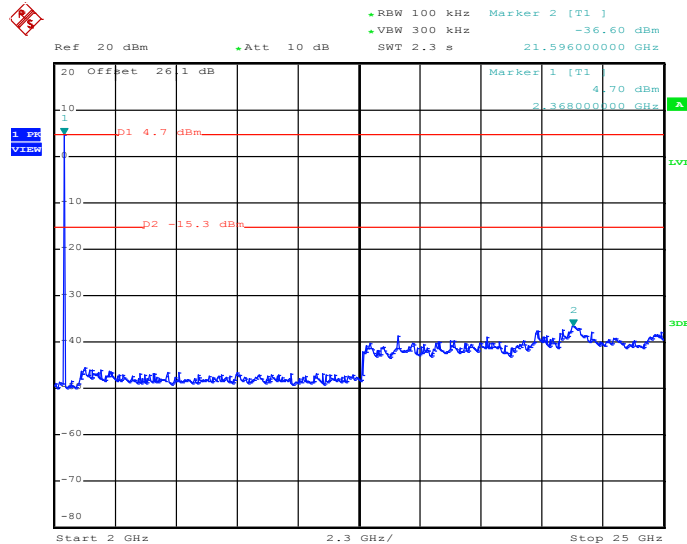

Date: 28.MAY.2020 15:03:32



CSE Plot on Ch 39 between 30MHz ~ 3 GHz

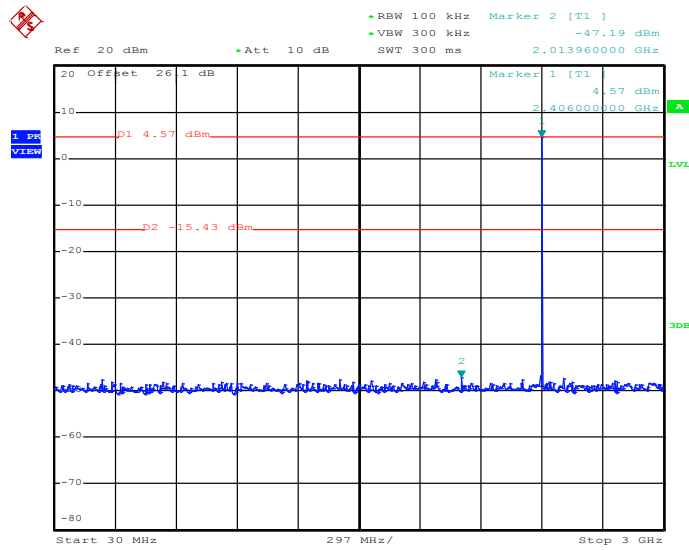

Date: 28.MAY.2020 15:04:26

CSE Plot on Ch 39 between 2 GHz ~ 25 GHz

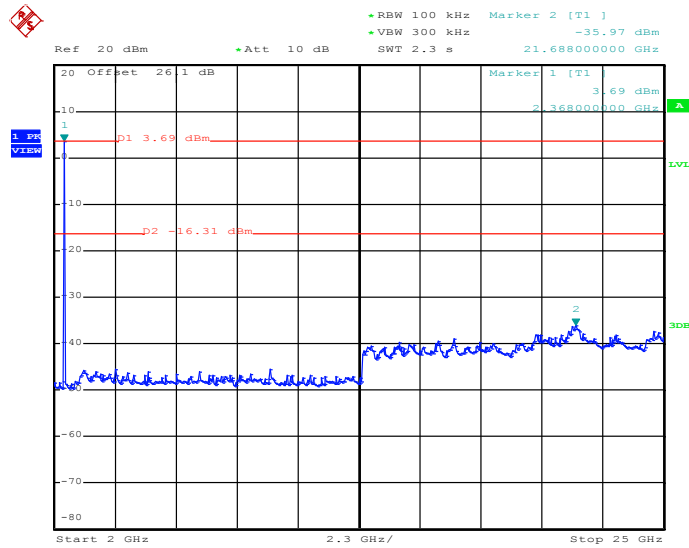

Date: 28.MAY.2020 15:04:59



CSE Plot on Ch 78 between 30MHz ~ 3 GHz

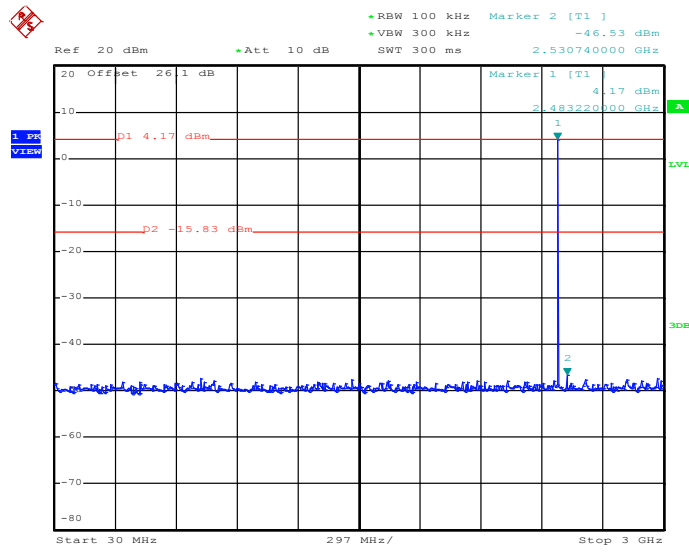

Date: 28.MAY.2020 15:06:05

CSE Plot on Ch 78 between 2 GHz ~ 25 GHz

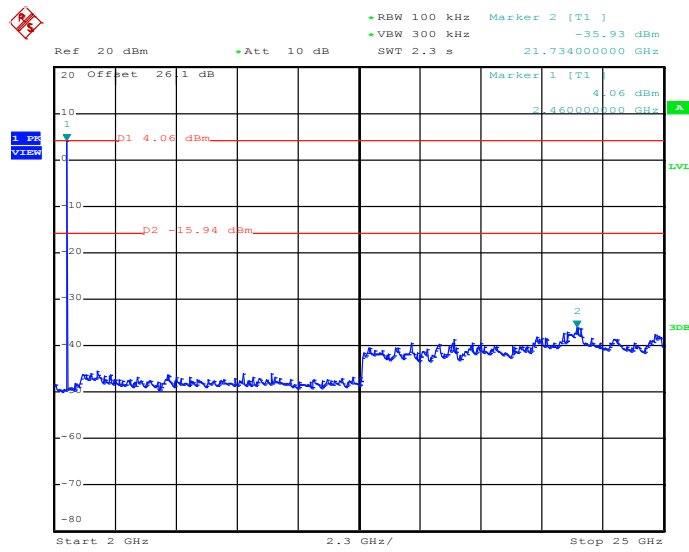

Date: 28.MAY.2020 15:06:34





<2Mbps>

CSE Plot on Ch 00 between 30MHz ~ 3 GHz

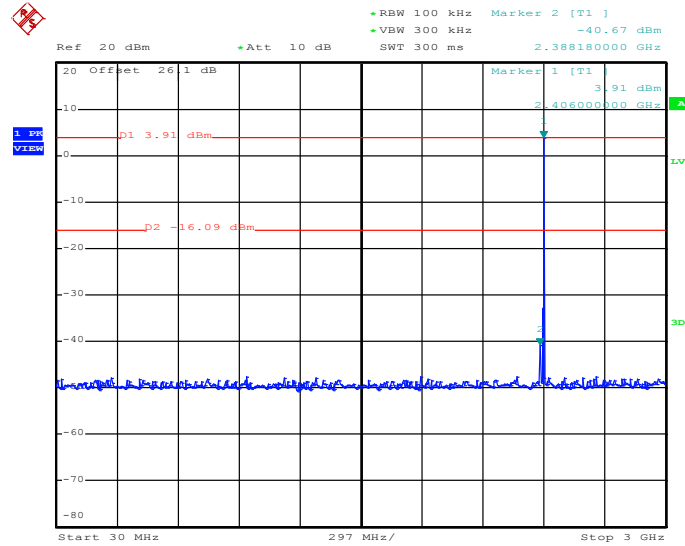

Date: 28.MAY.2020 15:11:56

CSE Plot on Ch 00 between 2 GHz ~ 25 GHz

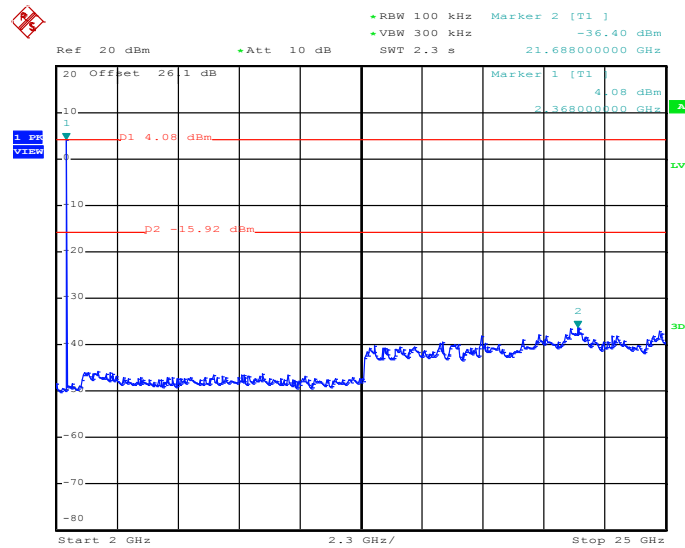

Date: 28.MAY.2020 15:12:40



CSE Plot on Ch 39 between 30MHz ~ 3 GHz

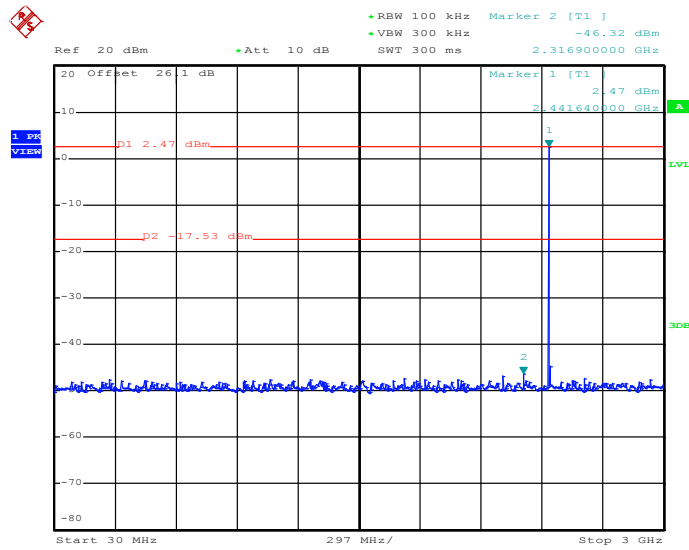

Date: 28.MAY.2020 15:32:02

CSE Plot on Ch 39 between 2 GHz ~ 25 GHz

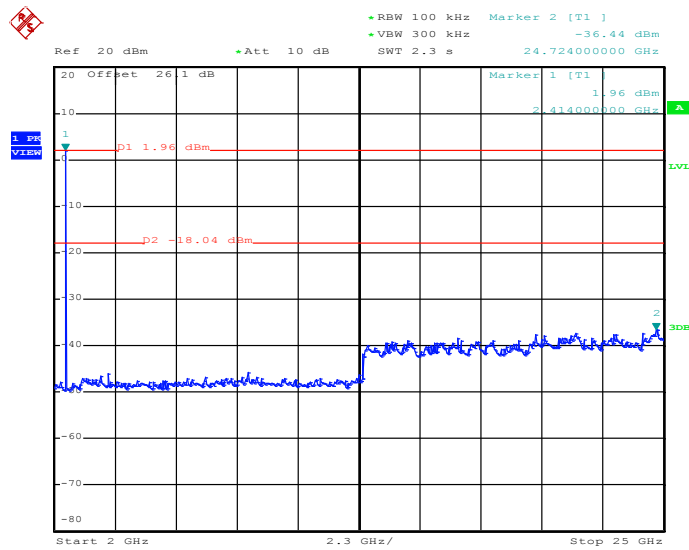

Date: 28.MAY.2020 15:32:32



CSE Plot on Ch 78 between 30MHz ~ 3 GHz

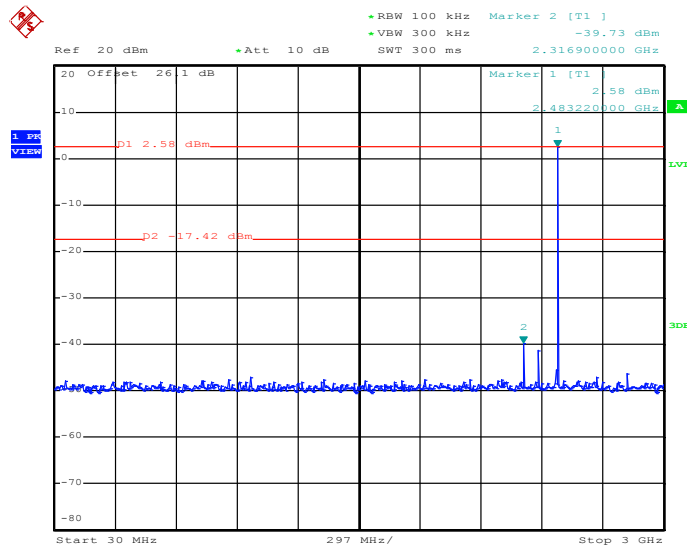

Date: 28.MAY.2020 15:51:41

CSE Plot on Ch 78 between 2 GHz ~ 25 GHz

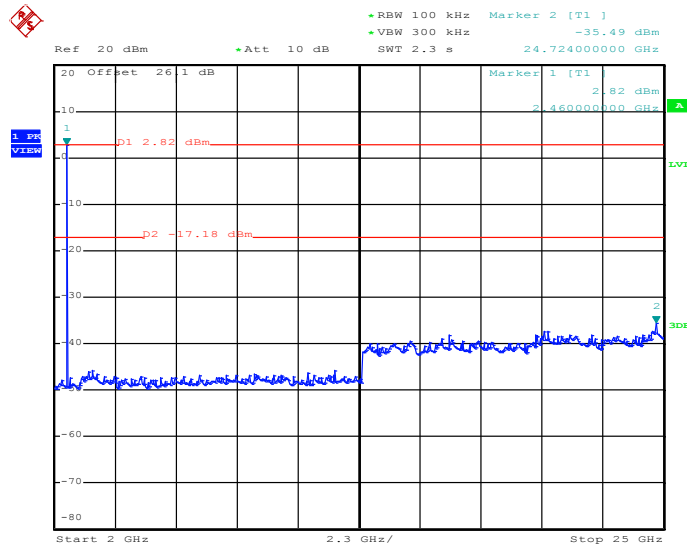

Date: 28.MAY.2020 15:52:11



<3Mbps>

CSE Plot on Ch 00 between 30MHz ~ 3 GHz

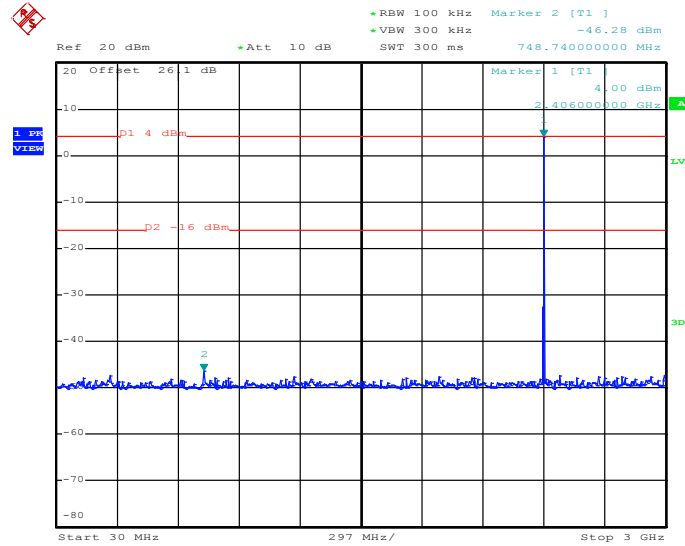

Date: 28.MAY.2020 16:00:53

CSE Plot on Ch 00 between 2 GHz ~ 25 GHz

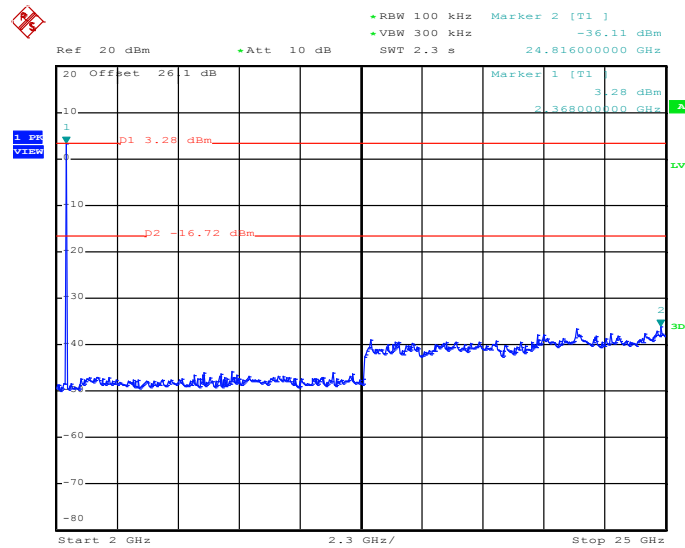

Date: 28.MAY.2020 16:01:42



CSE Plot on Ch 39 between 30MHz ~ 3 GHz

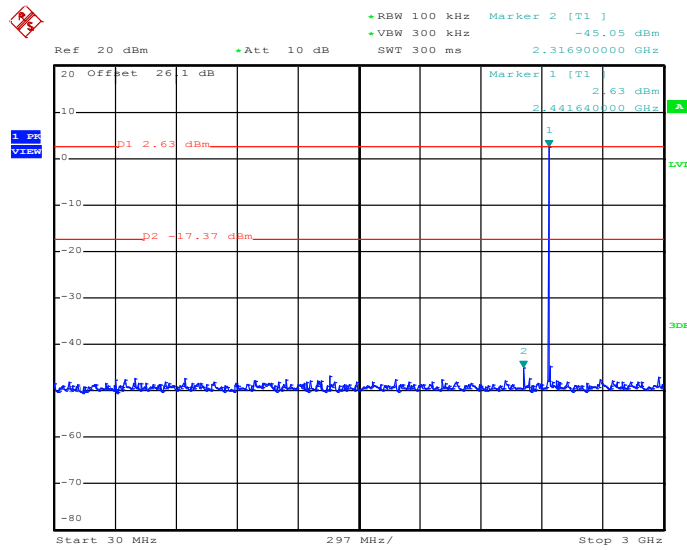

Date: 28.MAY.2020 16:09:32

CSE Plot on Ch 39 between 2 GHz ~ 25 GHz

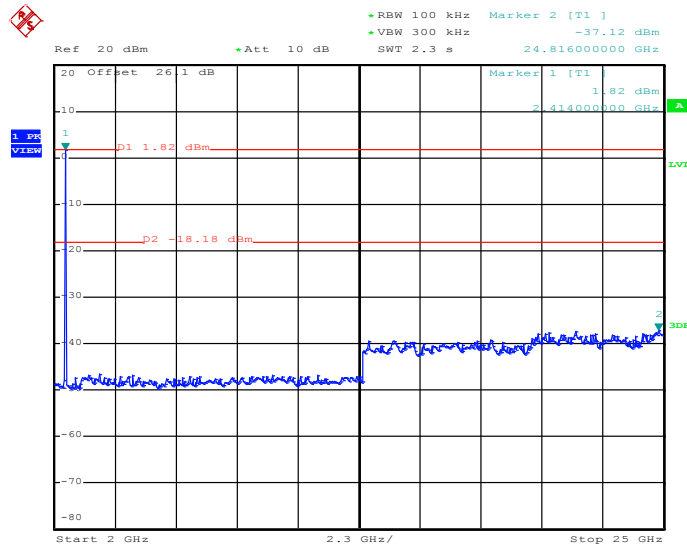

Date: 28.MAY.2020 16:10:05



CSE Plot on Ch 78 between 30MHz ~ 3 GHz

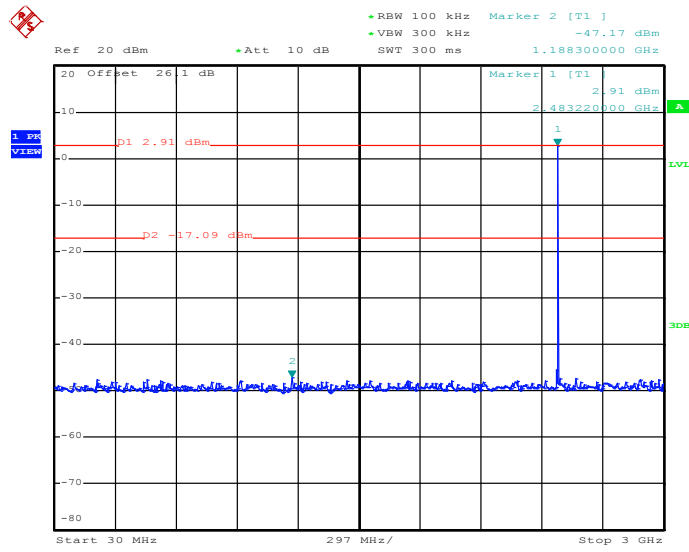

Date: 28.MAY.2020 17:12:29

CSE Plot on Ch 78 between 2 GHz ~ 25 GHz

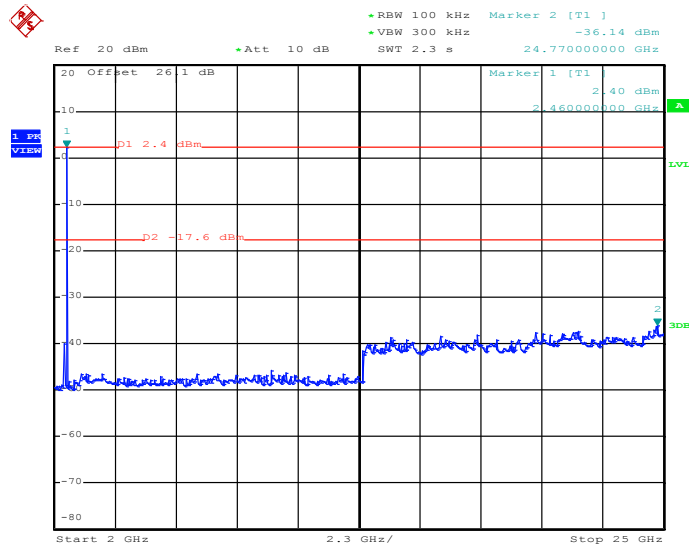

Date: 28.MAY.2020 17:13:02



### 3.8 Radiated Band Edges and Spurious Emission Measurement

#### 3.8.1 Limit of Radiated Band Edges and Spurious Emission

In any 100 kHz bandwidth outside the intentional radiator frequency band, all harmonics/spurious must be at least 20 dB below the highest emission level within the authorized band. In addition, radiated emissions which fall in the restricted bands must also comply with the limits as below.

| Frequency (MHz) | Field Strength (microvolts/meter) | Measurement Distance (meters) |
|-----------------|-----------------------------------|-------------------------------|
| 0.009 – 0.490   | 2400/F(kHz)                       | 300                           |
| 0.490 – 1.705   | 24000/F(kHz)                      | 30                            |
| 1.705 – 30.0    | 30                                | 30                            |
| 30 – 88         | 100                               | 3                             |
| 88 – 216        | 150                               | 3                             |
| 216 - 960       | 200                               | 3                             |
| Above 960       | 500                               | 3                             |

#### 3.8.2 Measuring Instruments

See list of measuring equipment of this test report.



3.8.3 Test Procedures

1. The EUT was placed on a turntable with 0.8 meter for frequency below 1GHz and 1.5 meter for frequency above 1GHz respectively above ground.
2. The EUT was set 3 meters from the interference receiving antenna, which was mounted on the top of a variable height antenna tower.
3. For each suspected emission, the EUT was arranged to its worst case and then tune the Antenna tower (from 1 m to 4 m) and turntable (from 0 degree to 360 degrees) to find the maximum reading. A pre-amp and a high pass filter are used for the test in order to get better signal level to comply with the guidelines.
4. Set to the maximum power setting and enable the EUT transmit continuously.
5. Use the following spectrum analyzer settings:
  - (1) Span shall wide enough to fully capture the emission being measured;
  - (2) Set RBW=100 kHz for  $f < 1 \text{ GHz}$ , RBW=1MHz for  $f > 1\text{GHz}$  ; VBW  $\geq$  RBW; Sweep = auto; Detector function = peak; Trace = max hold for peak
  - (3) For average measurement: use duty cycle correction factor method per 15.35(c).  
Duty cycle = On time/100 milliseconds  
On time =  $N_1 * L_1 + N_2 * L_2 + \dots + N_{n-1} * L_{n-1} + N_n * L_n$   
Where  $N_1$  is number of type 1 pulses,  $L_1$  is length of type 1 pulses, etc.  
Average Emission Level = Peak Emission Level +  $20 * \log(\text{Duty cycle})$

Corrected Reading: Antenna Factor + Cable Loss + Read Level - Preamp Factor = Level

For testing below 1GHz, if the emission level of the EUT in peak mode was 3 dB lower than the limit specified, then peak values of EUT will be reported, otherwise, the emissions will be repeated one by one using the CISPR quasi-peak method and reported.

For testing above 1GHz, the emission level of the EUT in peak mode was 20dB lower than average limit (that means the emission level in average mode also complies with the limit in average mode), then peak values of EUT will be reported, otherwise, the emissions will be measured in average mode again and reported.

Note: The average levels were calculated from the peak level corrected with duty cycle correction factor (-24.76dB) derived from  $20 \log(\text{dwell time}/100\text{ms})$ . This correction is only for signals that hop with the fundamental signal, such as band-edge and harmonic. Other spurious signals that are independent of the hopping signal would not use this correction.



### 3.8.4 Test Setup

For radiated emissions below 30MHz

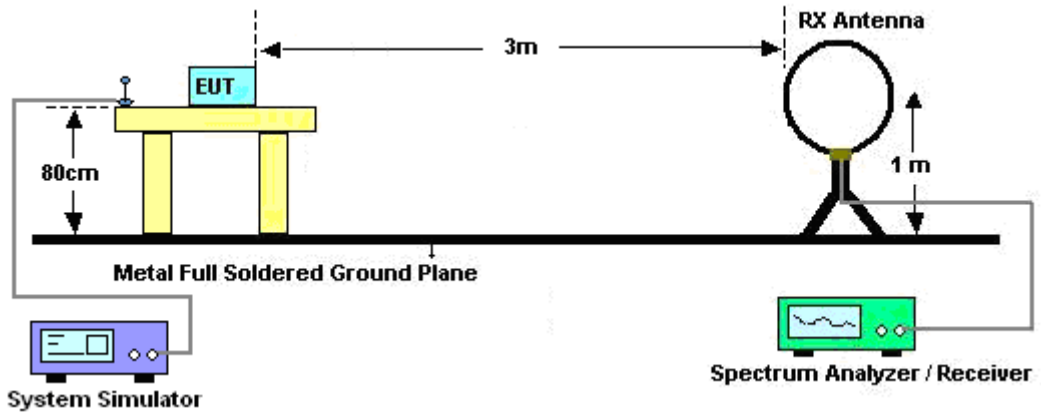

For radiated emissions from 30MHz to 1GHz

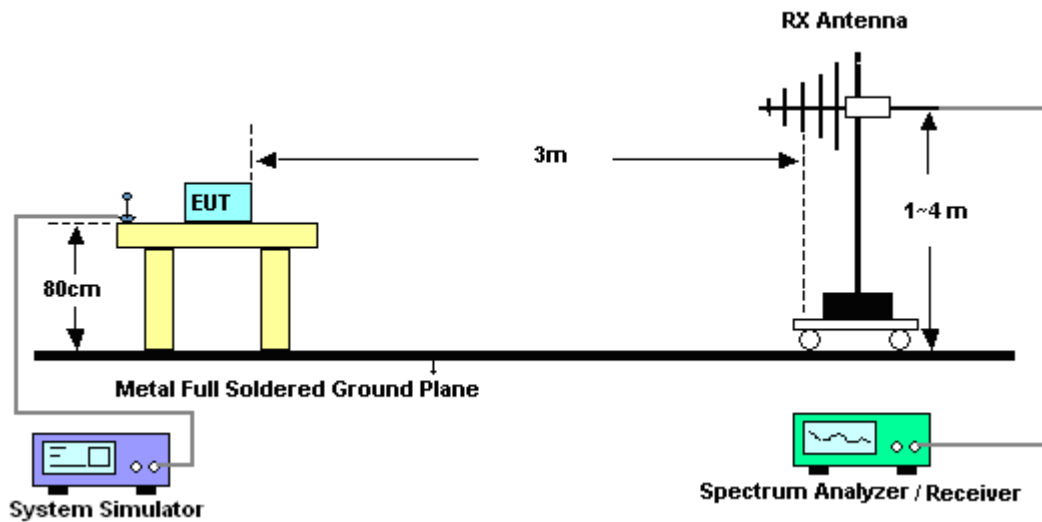

For radiated emissions above 1GHz

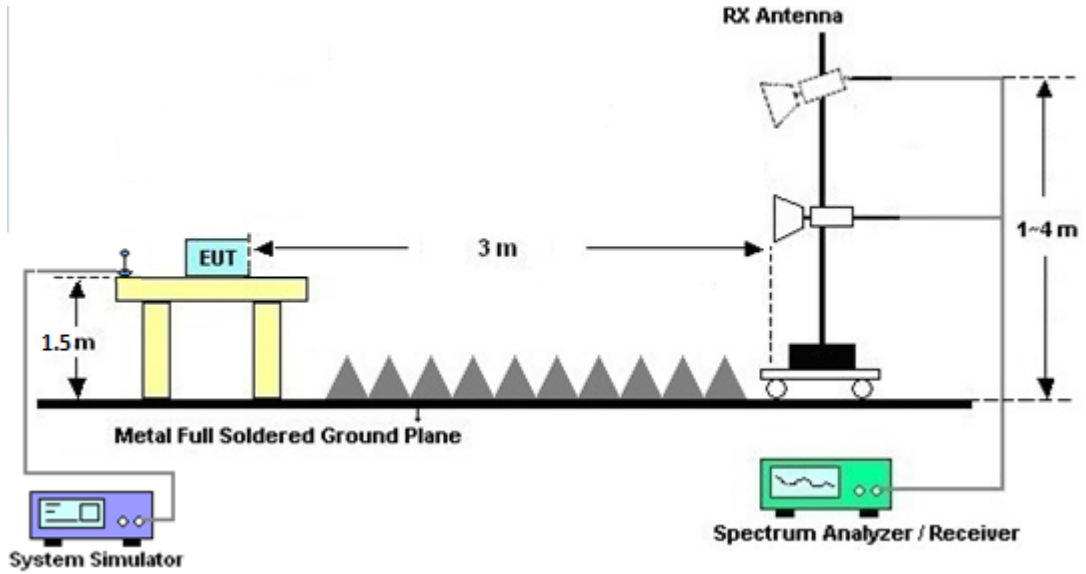

For radiated emissions above 18GHz

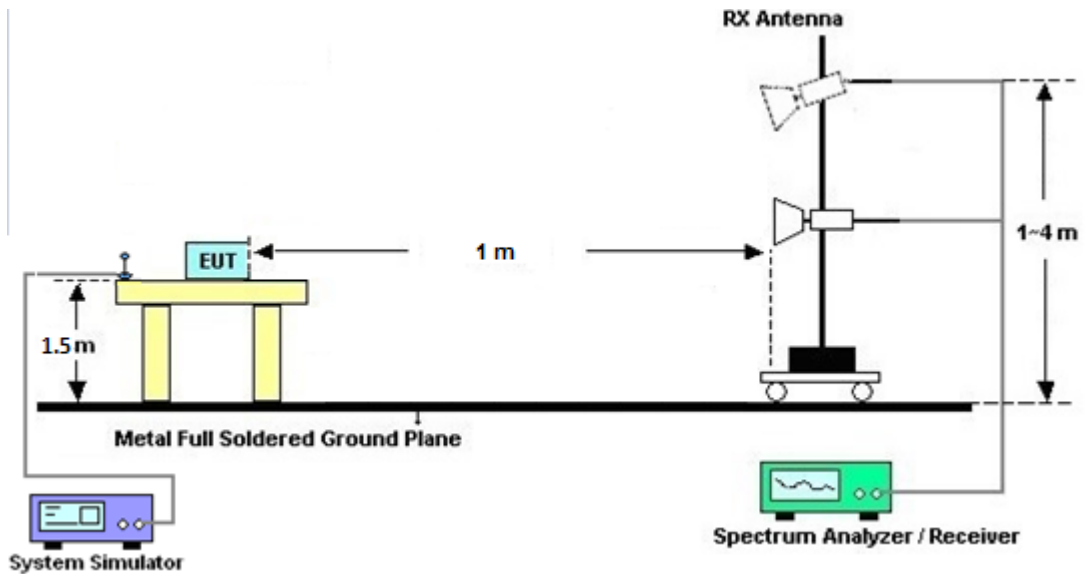



### **3.8.5 Test Results of Radiated Spurious Emissions (9 kHz ~ 30 MHz)**

The low frequency, which started from 9 kHz to 30MHz, was pre-scanned and the result which was 20dB lower than the limit line was not reported.

There is a comparison data of both open-field test site and alternative test site - semi-Anechoic chamber according to 414788 D01 Radiated Test Site v01r01, and the result came out very similar.

### **3.8.6 Test Result of Radiated Spurious at Band Edges**

Please refer to Appendix B and C.

### **3.8.7 Duty Cycle**

Please refer to Appendix D.

### **3.8.8 Test Result of Radiated Spurious Emission (30MHz ~ 10<sup>th</sup> Harmonic)**

Please refer to Appendix B and C.

### 3.9 AC Conducted Emission Measurement

#### 3.9.1 Limit of AC Conducted Emission

For equipment that is designed to be connected to the public utility (AC) power line, the radio frequency voltage that is conducted back onto the AC power line on any frequency or frequencies within the band 150 kHz to 30 MHz shall not exceed the limits in the following table.

| Frequency of emission (MHz) | Conducted limit (dB $\mu$ V) |           |
|-----------------------------|------------------------------|-----------|
|                             | Quasi-peak                   | Average   |
| 0.15-0.5                    | 66 to 56*                    | 56 to 46* |
| 0.5-5                       | 56                           | 46        |
| 5-30                        | 60                           | 50        |

\*Decreases with the logarithm of the frequency.

#### 3.9.2 Measuring Instruments

See list of measuring equipment of this test report.

#### 3.9.3 Test Procedures

1. The EUT was placed 0.4 meter from the conducting wall of the shielding room was kept at least 80 centimeters from any other grounded conducting surface.
2. Connect EUT to the power mains through a line impedance stabilization network (LISN).
3. All the support units are connecting to the other LISN.
4. The LISN provides 50 ohm coupling impedance for the measuring instrument.
5. The FCC states that a 50 ohm, 50 microhenry LISN should be used.
6. Both sides of AC line were checked for maximum conducted interference.
7. The frequency range from 150 kHz to 30 MHz was searched.
8. Set the test-receiver system to Peak Detect Function and specified bandwidth (IF Bandwidth = 9kHz) with Maximum Hold Mode. Then measurement is also conducted by Average Detector and Quasi-Peak Detector Function respectively.

### 3.9.4 Test Setup

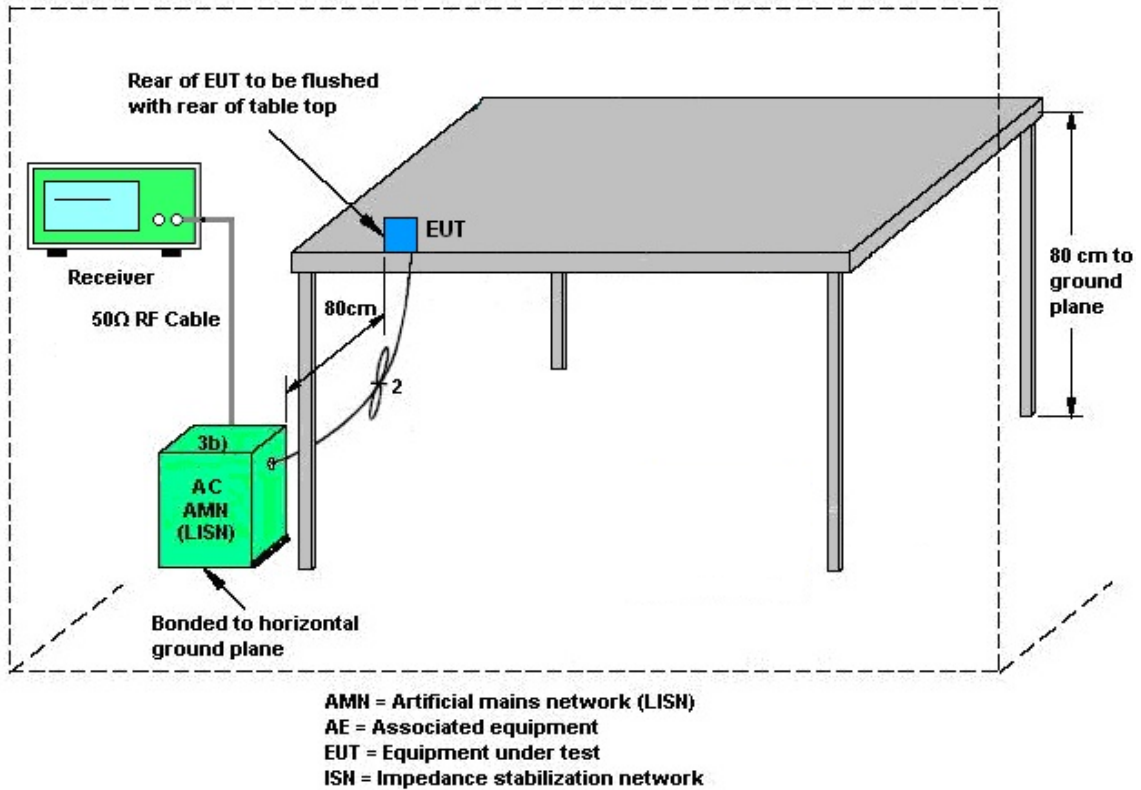

### 3.9.5 Test Result of AC Conducted Emission

Please refer to Appendix A.



## **3.10 Antenna Requirements**

### **3.10.1 Standard Applicable**

If directional gain of transmitting antennas is greater than 6dBi, the power shall be reduced by the same level in dB comparing to gain minus 6dBi. The use of a permanently attached antenna or of an antenna that uses a unique coupling to the intentional radiator shall be considered sufficient to comply with the rule.

### **3.10.2 Antenna Anti-Replacement Construction**

An embedded-in antenna design is used.

### **3.10.3 Antenna Gain**

The antenna peak gain of EUT is less than 6 dBi. Therefore, it is not necessary to reduce maximum peak output power limit.



## 4 List of Measuring Equipment

| Instrument               | Manufacturer      | Model No.                       | Serial No.           | Characteristics | Calibration Date | Test Date                       | Due Date      | Remark                   |
|--------------------------|-------------------|---------------------------------|----------------------|-----------------|------------------|---------------------------------|---------------|--------------------------|
| AC Power Source          | ChainTek          | APC-1000W                       | N/A                  | N/A             | N/A              | May 08, 2020~<br>May 28, 2020   | N/A           | Conduction<br>(CO05-HY)  |
| EMI Test Receiver        | Rohde & Schwarz   | ESR3                            | 102388               | 9kHz~3.6GHz     | Nov. 15, 2019    | May 08, 2020~<br>May 28, 2020   | Nov. 14, 2020 | Conduction<br>(CO05-HY)  |
| Hygrometer               | Testo             | 608-H1                          | 34913912             | N/A             | Nov. 07, 2019    | May 08, 2020~<br>May 28, 2020   | Nov. 06, 2020 | Conduction<br>(CO05-HY)  |
| LISN                     | Rohde & Schwarz   | ENV216                          | 100081               | 9kHz~30MHz      | Nov. 15, 2019    | May 08, 2020~<br>May 28, 2020   | Nov. 14, 2020 | Conduction<br>(CO05-HY)  |
| Software                 | Rohde & Schwarz   | EMC32<br>V10.30                 | N/A                  | N/A             | N/A              | May 08, 2020~<br>May 28, 2020   | N/A           | Conduction<br>(CO05-HY)  |
| LF Cable                 | HUBER +<br>SUHNER | RG-214/U                        | LF01                 | N/A             | Jan. 02, 2020    | May 08, 2020~<br>May 28, 2020   | Jan. 01, 2021 | Conduction<br>(CO05-HY)  |
| Pulse Limiter            | Rohde & Schwarz   | ESH3-Z2                         | 100851               | N/A             | Jan. 02, 2020    | May 08, 2020~<br>May 28, 2020   | Jan. 01, 2021 | Conduction<br>(CO05-HY)  |
| Hygrometer               | Testo             | 608-H2                          | 41410069             | N/A             | Jun. 17, 2019    | May 28, 2020                    | Jun. 16, 2020 | Conducted<br>(TH05-HY)   |
| Power Meter              | Agilent           | E4416A                          | GB412923<br>44       | N/A             | Dec. 27, 2019    | May 28, 2020                    | Dec. 26, 2020 | Conducted<br>(TH05-HY)   |
| Power Sensor             | Agilent           | E9327A                          | US404415<br>48       | 50MHz~18GHz     | Dec. 27, 2019    | May 28, 2020                    | Dec. 26, 2020 | Conducted<br>(TH05-HY)   |
| Signal Analyzer          | Rohde & Schwarz   | FSQ                             | 200578/02<br>6       | 20Hz~26.5GHz    | Jul. 10, 2019    | May 28, 2020                    | Jul. 09, 2020 | Conducted<br>(TH05-HY)   |
| BT Base Station          | Rohde & Schwarz   | CBT                             | 101136               | BT 3.0          | Oct. 27, 2019    | May 28, 2020                    | Oct. 26, 2020 | Conducted<br>(TH05-HY)   |
| Switch Box & RF<br>Cable | Burgeon           | ETF-058                         | EC130048<br>4        | N/A             | Aug. 22, 2019    | May 28, 2020                    | Aug. 21, 2020 | Conducted<br>(TH05-HY)   |
| Loop Antenna             | Rohde & Schwarz   | HFH2-Z2                         | 100488               | 9 kHz~30 MHz    | Jan. 09, 2020    | Jun. 22, 2020~<br>Jun. 26, 2020 | Jan. 08, 2021 | Radiation<br>(03CH16-HY) |
| Bilog Antenna            | TESEQ             | CBL6111D&0<br>0802N1D01N-<br>06 | 47020&06             | 30MHz to 1GHz   | Oct. 12, 2019    | Jun. 22, 2020~<br>Jun. 26, 2020 | Oct. 11, 2020 | Radiation<br>(03CH16-HY) |
| Horn Antenna             | SCHWARZBE<br>CK   | BBHA 9120 D                     | 9120D-152<br>2       | 1G~18GHz        | Sep. 19, 2019    | Jun. 22, 2020~<br>Jun. 26, 2020 | Sep. 18, 2020 | Radiation<br>(03CH16-HY) |
| SHF-EHF Horn<br>Antenna  | SCHWARZBE<br>CK   | BBHA 9170                       | BBHA9170<br>980      | 18GHz~40GHz     | Jan. 10, 2020    | Jun. 22, 2020~<br>Jun. 26, 2020 | Jan. 09, 2021 | Radiation<br>(03CH16-HY) |
| Amplifier                | SONOMA            | 310N                            | 371607               | 9kHz~1G         | Oct. 01, 2019    | Jun. 22, 2020~<br>Jun. 26, 2020 | Sep. 30, 2020 | Radiation<br>(03CH16-HY) |
| Preamplifier             | Jet-Power         | JPA0118-55-3<br>03              | 171000180<br>0055007 | 1GHz~18GHz      | Mar. 31, 2020    | Jun. 22, 2020~<br>Jun. 26, 2020 | Mar. 30, 2021 | Radiation<br>(03CH16-HY) |
| Preamplifier             | EMEC              | EM18G40G                        | 060715               | 18GHz ~40GHz    | Dec. 13, 2019    | Jun. 22, 2020~<br>Jun. 26, 2020 | Dec. 12, 2020 | Radiation<br>(03CH16-HY) |
| Preamplifier             | Keysight          | 83017A                          | MY532702<br>64       | 1GHz~26.5GHz    | Dec. 11, 2019    | Jun. 22, 2020~<br>Jun. 26, 2020 | Dec. 10, 2020 | Radiation<br>(03CH16-HY) |
| EMI Test Receiver        | Keysight          | N9038A(MXE<br>)                 | MY572901<br>11       | 3Hz~26.5GHz     | Dec. 05, 2019    | Jun. 22, 2020~<br>Jun. 26, 2020 | Dec. 04, 2020 | Radiation<br>(03CH16-HY) |



| Instrument | Manufacturer   | Model No.         | Serial No.     | Characteristics | Calibration Date | Test Date                       | Due Date      | Remark                |
|------------|----------------|-------------------|----------------|-----------------|------------------|---------------------------------|---------------|-----------------------|
| RF Cable   | HUBER + SUHNER | SUCOFLEX 104      | MY11680/4PE    | NA              | Aug. 30, 2019    | Jun. 22, 2020~<br>Jun. 26, 2020 | Aug. 29, 2020 | Radiation (03CH16-HY) |
| RF Cable   | HUBER + SUHNER | SUCOFLEX 104      | MY11688/4PE    | NA              | Aug. 30, 2019    | Jun. 22, 2020~<br>Jun. 26, 2020 | Aug. 29, 2020 | Radiation (03CH16-HY) |
| RF Cable   | HUBER + SUHNER | SUCOFLEX 102      | EC-A5-300-5757 | NA              | Aug. 30, 2019    | Jun. 22, 2020~<br>Jun. 26, 2020 | Aug. 29, 2020 | Radiation (03CH16-HY) |
| Software   | Audix          | E3<br>6.2009-8-24 | RK-001136      | N/A             | N/A              | Jun. 22, 2020~<br>Jun. 26, 2020 | N/A           | Radiation (03CH16-HY) |





## 5 Uncertainty of Evaluation

### Uncertainty of Conducted Emission Measurement (150 kHz ~ 30 MHz)

|   |     |
|---|-----|
| Measuring Uncertainty for a Level of Confidence of 95% ( $U = 2Uc(y)$ ) | 2.3 |
|---|-----|

### Uncertainty of Radiated Emission Measurement (30 MHz ~ 1000 MHz)

|   |     |
|---|-----|
| Measuring Uncertainty for a Level of Confidence of 95% ( $U = 2Uc(y)$ ) | 4.9 |
|---|-----|

### Uncertainty of Radiated Emission Measurement (1000 MHz ~ 18000 MHz)

|   |     |
|---|-----|
| Measuring Uncertainty for a Level of Confidence of 95% ( $U = 2Uc(y)$ ) | 6.7 |
|---|-----|

### Uncertainty of Radiated Emission Measurement (18000 MHz ~ 40000 MHz)

|   |     |
|---|-----|
| Measuring Uncertainty for a Level of Confidence of 95% ( $U = 2Uc(y)$ ) | 3.9 |
|---|-----|



## Appendix A. AC Conducted Emission Test Results

|                 |                          |                     |         |
|-----------------|--------------------------|---------------------|---------|
| Test Engineer : | Howard Huang and Tom Lee | Temperature :       | 21~24°C |
|                 |                          | Relative Humidity : | 42~50%  |
| Test Voltage :  | 120Vac / 60Hz            | Phase :             | Line    |

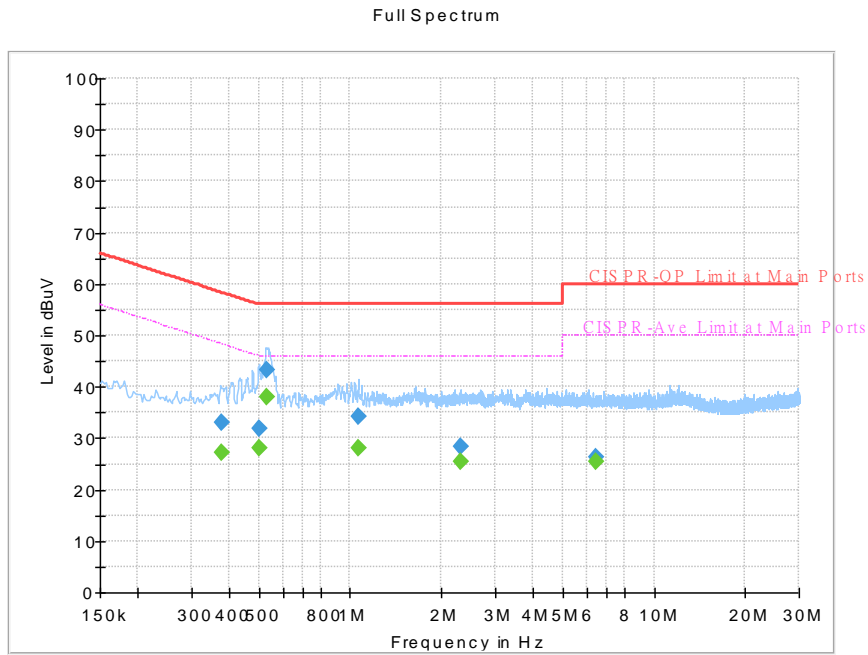

### Final Result

| Frequency (MHz) | QuasiPeak (dBuV) | CAverage (dBuV) | Limit (dBuV) | Margin (dB) | Line | Filter | Corr. (dB) |
|-----------------|------------------|-----------------|--------------|-------------|------|--------|------------|
| 0.377250        | ---              | 27.20           | 48.34        | 21.14       | L1   | OFF    | 19.6       |
| 0.377250        | 32.94            | ---             | 58.34        | 25.40       | L1   | OFF    | 19.6       |
| 0.503610        | ---              | 27.95           | 46.00        | 18.05       | L1   | OFF    | 19.6       |
| 0.503610        | 31.87            | ---             | 56.00        | 24.13       | L1   | OFF    | 19.6       |
| 0.530250        | ---              | 37.94           | 46.00        | 8.06        | L1   | OFF    | 19.6       |
| 0.530250        | 43.15            | ---             | 56.00        | 12.85       | L1   | OFF    | 19.6       |
| 1.064310        | ---              | 28.09           | 46.00        | 17.91       | L1   | OFF    | 19.6       |
| 1.064310        | 34.32            | ---             | 56.00        | 21.68       | L1   | OFF    | 19.6       |
| 2.318730        | ---              | 25.31           | 46.00        | 20.69       | L1   | OFF    | 19.6       |
| 2.318730        | 28.43            | ---             | 56.00        | 27.57       | L1   | OFF    | 19.6       |
| 6.434250        | ---              | 25.34           | 50.00        | 24.66       | L1   | OFF    | 19.9       |
| 6.434250        | 26.30            | ---             | 60.00        | 33.70       | L1   | OFF    | 19.9       |



|                 |                          |                     |         |
|-----------------|--------------------------|---------------------|---------|
| Test Engineer : | Howard Huang and Tom Lee | Temperature :       | 21~24°C |
|                 |                          | Relative Humidity : | 42~50%  |
| Test Voltage :  | 120Vac / 60Hz            | Phase :             | Neutral |

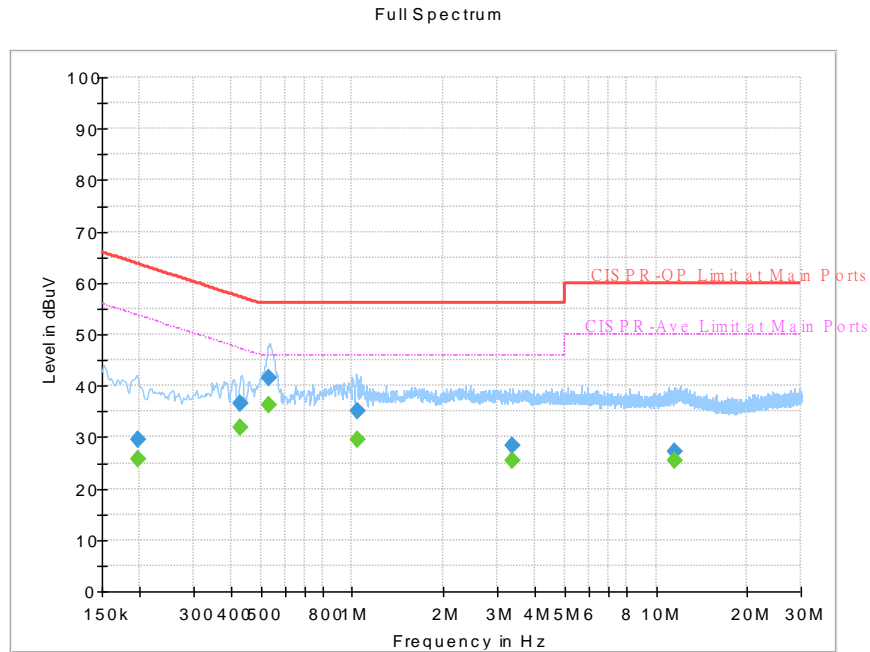

**Final Result**

| Frequency (MHz) | QuasiPeak (dBuV) | CAverage (dBuV) | Limit (dBuV) | Margin (dB) | Line | Filter | Corr. (dB) |
|-----------------|------------------|-----------------|--------------|-------------|------|--------|------------|
| 0.198240        | ---              | 25.79           | 53.68        | 27.89       | N    | OFF    | 19.6       |
| 0.198240        | 29.47            | ---             | 63.68        | 34.21       | N    | OFF    | 19.6       |
| 0.430170        | ---              | 31.76           | 47.25        | 15.49       | N    | OFF    | 19.6       |
| 0.430170        | 36.58            | ---             | 57.25        | 20.67       | N    | OFF    | 19.6       |
| 0.530880        | ---              | 36.32           | 46.00        | 9.68        | N    | OFF    | 19.6       |
| 0.530880        | 41.59            | ---             | 56.00        | 14.41       | N    | OFF    | 19.6       |
| 1.035510        | ---              | 29.55           | 46.00        | 16.45       | N    | OFF    | 19.6       |
| 1.035510        | 35.19            | ---             | 56.00        | 20.81       | N    | OFF    | 19.6       |
| 3.352110        | ---              | 25.30           | 46.00        | 20.70       | N    | OFF    | 19.7       |
| 3.352110        | 28.26            | ---             | 56.00        | 27.74       | N    | OFF    | 19.7       |
| 11.581530       | ---              | 25.55           | 50.00        | 24.45       | N    | OFF    | 20.1       |
| 11.581530       | 27.17            | ---             | 60.00        | 32.83       | N    | OFF    | 20.1       |



## Appendix B. Radiated Spurious Emission

|                 |                                 |                     |           |
|-----------------|---------------------------------|---------------------|-----------|
| Test Engineer : | Karl Hou, CR Liao and Andy Yang | Temperature :       | 20 ~ 25°C |
|                 |                                 | Relative Humidity : | 50 ~ 60%  |

### 2.4GHz 2400~2483.5MHz

#### BT (Band Edge @ 3m)

| BT                     | Note | Frequency | Level      | Over Limit | Limit Line | Read Level | Antenna Factor | Path Loss | Preamp Factor | Ant Pos | Table Pos | Peak Avg. | Pol.    |   |
|------------------------|------|-----------|------------|------------|------------|------------|----------------|-----------|---------------|---------|-----------|-----------|---------|---|
|                        |      | ( MHz )   | ( dBμV/m ) | ( dB )     | ( dBμV/m ) | ( dBμV )   | ( dB/m )       | ( dB )    | ( dB )        | ( cm )  | ( deg )   | ( P/A )   | ( H/V ) |   |
| BT<br>CH00<br>2402MHz  |      | 2386.125  | 57.68      | -16.32     | 74         | 51.63      | 27.66          | 8.17      | 29.78         | 112     | 12        | P         | H       |   |
|                        |      | 2386.125  | 32.92      | -21.08     | 54         | -          | -              | -         | -             | -       | -         | A         | H       |   |
|                        | *    | 2402      | 99.3       | -          | -          | 93.3       | 27.6           | 8.19      | 29.79         | 112     | 12        | P         | H       |   |
|                        | *    | 2402      | 74.54      | -          | -          | -          | -              | -         | -             | -       | -         | A         | H       |   |
|                        |      |           |            |            |            |            |                |           |               |         |           |           | H       |   |
|                        |      |           | 2386.02    | 54.4       | -19.6      | 74         | 48.35          | 27.66     | 8.17          | 29.78   | 308       | 258       | P       | V |
|                        |      |           | 2386.02    | 29.64      | -24.36     | 54         | -              | -         | -             | -       | -         | -         | A       | V |
|                        | *    |           | 2402       | 96.68      | -          | -          | 90.68          | 27.6      | 8.19          | 29.79   | 308       | 258       | P       | V |
|                        | *    |           | 2402       | 71.92      | -          | -          | -              | -         | -             | -       | -         | -         | A       | V |
|                        |      |           |            |            |            |            |                |           |               |         |           |           |         | V |
| BT<br>CH 39<br>2441MHz |      | 2386.02   | 57.63      | -16.37     | 74         | 51.58      | 27.66          | 8.17      | 29.78         | 121     | 12        | P         | H       |   |
|                        |      | 2386.02   | 32.87      | -21.13     | 54         | -          | -              | -         | -             | -       | -         | A         | H       |   |
|                        | *    | 2441      | 99.04      | -          | -          | 92.99      | 27.6           | 8.26      | 29.81         | 121     | 12        | P         | H       |   |
|                        | *    | 2441      | 74.28      | -          | -          | -          | -              | -         | -             | -       | -         | A         | H       |   |
|                        |      |           | 2486.35    | 46.45      | -27.55     | 74         | 40.41          | 27.53     | 8.33          | 29.82   | 121       | 12        | P       | H |
|                        |      |           | 2486.35    | 21.69      | -32.31     | 54         | -              | -         | -             | -       | -         | -         | A       | H |
|                        |      |           | 2385.88    | 52.87      | -21.13     | 74         | 46.82          | 27.66     | 8.17          | 29.78   | 271       | 246       | P       | V |
|                        |      |           | 2385.88    | 28.11      | -25.89     | 54         | -              | -         | -             | -       | -         | -         | A       | V |
|                        | *    |           | 2441       | 96.05      | -          | -          | 90             | 27.6      | 8.26          | 29.81   | 271       | 246       | P       | V |
|                        | *    |           | 2441       | 71.29      | -          | -          | -              | -         | -             | -       | -         | -         | A       | V |
|                        |      |           | 2494.61    | 46.35      | -27.65     | 74         | 40.33          | 27.51     | 8.34          | 29.83   | 271       | 246       | P       | V |
|                        |      |           | 2494.61    | 21.59      | -32.41     | 54         | -              | -         | -             | -       | -         | -         | A       | V |



|                                 |   |         |        |        |    |       |       |      |       |     |     |   |   |
|---------------------------------|---|---------|--------|--------|----|-------|-------|------|-------|-----|-----|---|---|
| <b>BT<br/>CH 78<br/>2480MHz</b> | *   | 2480    | 100.13 | -      | -  | 94.09 | 27.54 | 8.32 | 29.82 | 100 | 13  | P | H |
|                                 | *   | 2480    | 75.37  | -      | -  | -     | -     | -    | -     | -   | -   | A | H |
|                                 |   | 2484    | 50.12  | -23.88 | 74 | 44.09 | 27.53 | 8.32 | 29.82 | 100 | 13  | P | H |
|                                 |   | 2484    | 25.36  | -28.64 | 54 | -     | -     | -    | -     | -   | -   | A | H |
|                                 |   |         |        |        |    |       |       |      |       |     |     |   | H |
|                                 |   |         |        |        |    |       |       |      |       |     |     |   | H |
|                                 | *   | 2480    | 96.26  | -      | -  | 90.22 | 27.54 | 8.32 | 29.82 | 298 | 251 | P | V |
|                                 | *   | 2480    | 71.5   | -      | -  | -     | -     | -    | -     | -   | -   | A | V |
|                                 |   | 2484.64 | 48.37  | -25.63 | 74 | 42.33 | 27.53 | 8.33 | 29.82 | 298 | 251 | P | V |
|                                 |   | 2484.64 | 23.61  | -30.39 | 54 | -     | -     | -    | -     | -   | -   | A | V |
|                                 |   |         |        |        |    |       |       |      |       |     |     |   | V |
|                                 |   |         |        |        |    |       |       |      |       |     |     |   | V |
| <b>Remark</b>                   | 1. No other spurious found.<br>2. All results are PASS against Peak and Average limit line. |         |        |        |    |       |       |      |       |     |     |   |   |



2.4GHz 2400~2483.5MHz  
BT (Harmonic @ 3m)

| BT                     | Note  | Frequency<br>( MHz ) | Level<br>( dBμV/m ) | Over<br>Limit<br>( dB ) | Limit<br>Line<br>( dBμV/m ) | Read<br>Level<br>( dBμV ) | Antenna<br>Factor<br>( dB/m ) | Path<br>Loss<br>( dB ) | Preamp<br>Factor<br>( dB ) | Ant<br>Pos<br>( cm ) | Table<br>Pos<br>( deg ) | Peak<br>Avg.<br>( P/A ) | Pol.<br>( H/V ) |
|------------------------|---|----------------------|---------------------|-------------------------|-----------------------------|---------------------------|-------------------------------|------------------------|----------------------------|----------------------|-------------------------|-------------------------|-----------------|
| BT<br>CH 00<br>2402MHz |   | 4804                 | 50.06               | -23.94                  | 74                          | 65.63                     | 31.11                         | 12.4                   | 59.08                      | 100                  | 0                       | P                       | H               |
|                        |   | 4804                 | 25.3                | -28.7                   | 54                          | -                         | -                             | -                      | -                          | -                    | -                       | A                       | H               |
|                        |   |                      |                     |                         |                             |                           |                               |                        |                            |                      |                         |                         | H               |
|                        |   |                      |                     |                         |                             |                           |                               |                        |                            |                      |                         |                         | H               |
|                        |   | 4804                 | 46.94               | -27.06                  | 74                          | 62.51                     | 31.11                         | 12.4                   | 59.08                      | 100                  | 0                       | P                       | V               |
|                        |   | 4804                 | 22.18               | -31.82                  | 54                          | -                         | -                             | -                      | -                          | -                    | -                       | A                       | V               |
|                        |   |                      |                     |                         |                             |                           |                               |                        |                            |                      |                         |                         | V               |
|                        |   |                      |                     |                         |                             |                           |                               |                        |                            |                      |                         |                         | V               |
| BT<br>CH 39<br>2441MHz |   | 4882                 | 49.03               | -24.97                  | 74                          | 64.61                     | 31.07                         | 12.48                  | 59.13                      | 100                  | 0                       | P                       | H               |
|                        |   | 4882                 | 24.27               | -29.73                  | 54                          | -                         | -                             | -                      | -                          | -                    | -                       | A                       | H               |
|                        |   | 7323                 | 48.68               | -25.32                  | 74                          | 55.06                     | 36.49                         | 15.68                  | 58.55                      | 100                  | 0                       | P                       | H               |
|                        |   | 7323                 | 23.92               | -30.08                  | 54                          | -                         | -                             | -                      | -                          | -                    | -                       | A                       | H               |
|                        |   | 4882                 | 48.14               | -25.86                  | 74                          | 63.72                     | 31.07                         | 12.48                  | 59.13                      | 100                  | 0                       | P                       | V               |
|                        |   | 4882                 | 23.38               | -30.62                  | 54                          | -                         | -                             | -                      | -                          | -                    | -                       | A                       | V               |
|                        |   | 7323                 | 47.45               | -26.55                  | 74                          | 53.83                     | 36.49                         | 15.68                  | 58.55                      | 100                  | 0                       | P                       | V               |
|                        |   | 7323                 | 22.69               | -31.31                  | 54                          | -                         | -                             | -                      | -                          | -                    | -                       | A                       | V               |
| BT<br>CH 78<br>2480MHz |   | 4960                 | 48.16               | -25.84                  | 74                          | 63.52                     | 31.26                         | 12.56                  | 59.18                      | 100                  | 0                       | P                       | H               |
|                        |   | 4960                 | 23.4                | -30.6                   | 54                          | -                         | -                             | -                      | -                          | -                    | -                       | A                       | H               |
|                        |   | 7440                 | 49.44               | -24.56                  | 74                          | 55.46                     | 36.58                         | 15.78                  | 58.38                      | 100                  | 0                       | P                       | H               |
|                        |   | 7440                 | 24.68               | -29.32                  | 54                          | -                         | -                             | -                      | -                          | -                    | -                       | A                       | H               |
|                        |   | 4960                 | 45.37               | -28.63                  | 74                          | 60.73                     | 31.26                         | 12.56                  | 59.18                      | 100                  | 0                       | P                       | V               |
|                        |   | 4960                 | 20.61               | -33.39                  | 54                          | -                         | -                             | -                      | -                          | -                    | -                       | A                       | V               |
|                        |   | 7440                 | 47.74               | -26.26                  | 74                          | 53.76                     | 36.58                         | 15.78                  | 58.38                      | 100                  | 0                       | P                       | V               |
|                        |   | 7440                 | 22.98               | -31.02                  | 54                          | -                         | -                             | -                      | -                          | -                    | -                       | A                       | V               |
| Remark                 | 1. No other spurious found.<br>2. All results are PASS against Peak and Average limit line. |                      |                     |                         |                             |                           |                               |                        |                            |                      |                         |                         |                 |



Emission above 18GHz

2.4GHz BT (SHF)

| BT                  | Note   | Frequency | Level      | Over   | Limit      | Read     | Antenna  | Path   | Preamp | Ant    | Table   | Peak    | Pol.    |
|---------------------|--|-----------|------------|--------|------------|----------|----------|--------|--------|--------|---------|---------|---------|
|                     |  | ( MHz )   | ( dBμV/m ) | ( dB ) | ( dBμV/m ) | ( dBμV ) | ( dB/m ) | ( dB ) | ( dB ) | ( cm ) | ( deg ) | ( P/A ) | ( H/V ) |
| 2.4GHz<br>BT<br>SHF |  | 19141     | 37.42      | -36.58 | 74         | 42.72    | 37.99    | 11.03  | 54.32  | 150    | 0       | P       | H       |
|                     |  |           |            |        |            |          |          |        |        |        |         |         | H       |
|                     |  |           |            |        |            |          |          |        |        |        |         |         | H       |
|                     |  |           |            |        |            |          |          |        |        |        |         |         | H       |
|                     |  |           |            |        |            |          |          |        |        |        |         |         | H       |
|                     |  |           |            |        |            |          |          |        |        |        |         |         | H       |
|                     |  |           |            |        |            |          |          |        |        |        |         |         | H       |
|                     |  |           |            |        |            |          |          |        |        |        |         |         | H       |
|                     |  |           |            |        |            |          |          |        |        |        |         |         | H       |
|                     |  |           |            |        |            |          |          |        |        |        |         |         | H       |
|                     |  |           |            |        |            |          |          |        |        |        |         |         | H       |
|                     |  |           |            |        |            |          |          |        |        |        |         |         | H       |
|                     |  |           |            |        |            |          |          |        |        |        |         |         | H       |
|                     |  |           |            |        |            |          |          |        |        |        |         |         | H       |
|                     |  |           |            |        |            |          |          |        |        |        |         |         | H       |
|                     |  |           |            |        |            |          |          |        |        |        |         |         | H       |
|                     |  |           |            |        |            |          |          |        |        |        |         |         | H       |
|                     |  |           |            |        |            |          |          |        |        |        |         |         | H       |
|                     |  |           |            |        |            |          |          |        |        |        |         |         | H       |
|                     |  |           | 21416      | 38.48  | -35.52     | 74       | 41.58    | 38.07  | 12.31  | 53.48  | 150     | 0       | P       |
|                     |  |           |            |        |            |          |          |        |        |        |         |         | V       |
|                     |  |           |            |        |            |          |          |        |        |        |         |         | V       |
|                     |  |           |            |        |            |          |          |        |        |        |         |         | V       |
|                     |  |           |            |        |            |          |          |        |        |        |         |         | V       |
|                     |  |           |            |        |            |          |          |        |        |        |         |         | V       |
|                     |  |           |            |        |            |          |          |        |        |        |         |         | V       |
|                     |  |           |            |        |            |          |          |        |        |        |         |         | V       |
|                     |  |           |            |        |            |          |          |        |        |        |         |         | V       |
|                     |  |           |            |        |            |          |          |        |        |        |         |         | V       |
|                     |  |           |            |        |            |          |          |        |        |        |         |         | V       |
|                     |  |           |            |        |            |          |          |        |        |        |         |         | V       |
|                     |  |           |            |        |            |          |          |        |        |        |         |         | V       |
|                     |  |           |            |        |            |          |          |        |        |        |         |         | V       |
|                     |  |           |            |        |            |          |          |        |        |        |         |         | V       |
| Remark              | 1. No other spurious found.<br>2. All results are PASS against limit line. |           |            |        |            |          |          |        |        |        |         |         |         |



Emission below 1GHz

2.4GHz BT (LF)

| BT                 | Note   | Frequency | Level      | Over   | Limit      | Read     | Antenna  | Path   | Preamp | Ant    | Table   | Peak    | Pol.    |   |
|--------------------|--|-----------|------------|--------|------------|----------|----------|--------|--------|--------|---------|---------|---------|---|
|                    |  | ( MHz )   | ( dBμV/m ) | ( dB ) | ( dBμV/m ) | ( dBμV ) | ( dB/m ) | ( dB ) | ( dB ) | ( cm ) | ( deg ) | ( P/A ) | ( H/V ) |   |
| 2.4GHz<br>BT<br>LF |  | 126.03    | 33.71      | -9.79  | 43.5       | 46.59    | 17.43    | 1.96   | 32.27  | -      | -       | P       | H       |   |
|                    |  | 137.67    | 32.93      | -10.57 | 43.5       | 45.78    | 17.38    | 2.05   | 32.28  | -      | -       | P       | H       |   |
|                    |  | 191.99    | 37.05      | -6.45  | 43.5       | 52.25    | 14.71    | 2.4    | 32.31  | 100    | 0       | P       | H       |   |
|                    |  | 426.73    | 29.52      | -16.48 | 46         | 35.34    | 22.82    | 3.53   | 32.17  | -      | -       | P       | H       |   |
|                    |  | 894.27    | 34.25      | -11.75 | 46         | 32.08    | 28.98    | 5.14   | 31.95  | -      | -       | P       | H       |   |
|                    |  | 952.47    | 34.72      | -11.28 | 46         | 29.9     | 30.8     | 5.32   | 31.3   | -      | -       | P       | H       |   |
|                    |  |           |            |        |            |          |          |        |        |        |         |         |         | H |
|                    |  |           |            |        |            |          |          |        |        |        |         |         |         | H |
|                    |  |           |            |        |            |          |          |        |        |        |         |         |         | H |
|                    |  |           |            |        |            |          |          |        |        |        |         |         |         | H |
|                    |  |           |            |        |            |          |          |        |        |        |         |         |         | H |
|                    |  |           |            |        |            |          |          |        |        |        |         |         |         | H |
|                    |  |           |            |        |            |          |          |        |        |        |         |         |         | H |
|                    |  |           | 126.03     | 29.95  | -13.55     | 43.5     | 42.83    | 17.43  | 1.96   | 32.27  | -       | -       | P       | V |
|                    |  |           | 183.26     | 31.27  | -12.23     | 43.5     | 46.44    | 14.78  | 2.36   | 32.31  | -       | -       | P       | V |
|                    |  |           | 312.27     | 27.47  | -18.53     | 46       | 37.36    | 19.37  | 3.08   | 32.34  | -       | -       | P       | V |
|                    |  |           | 473.29     | 30.38  | -15.62     | 46       | 35.27    | 23.56  | 3.67   | 32.12  | -       | -       | P       | V |
|                    |  |           | 901.06     | 38.98  | -7.02      | 46       | 36.72    | 29.02  | 5.15   | 31.91  | 100     | 0       | P       | V |
|                    |  |           | 945.68     | 34.58  | -11.42     | 46       | 30.1     | 30.56  | 5.3    | 31.38  | -       | -       | P       | V |
|                    |  |           |            |        |            |          |          |        |        |        |         |         |         | V |
|                    |  |           |            |        |            |          |          |        |        |        |         |         | V       |   |
|                    |  |           |            |        |            |          |          |        |        |        |         |         | V       |   |
|                    |  |           |            |        |            |          |          |        |        |        |         |         | V       |   |
|                    |  |           |            |        |            |          |          |        |        |        |         |         | V       |   |
|                    |  |           |            |        |            |          |          |        |        |        |         |         | V       |   |
| Remark             | 1. No other spurious found.<br>2. All results are PASS against limit line. |           |            |        |            |          |          |        |        |        |         |         |         |   |





**Note symbol**

|     |  |
|-----|--|
| *   | <b>Fundamental Frequency</b> which can be ignored. However, the level of any unwanted emissions shall not exceed the level of the fundamental frequency. |
| !   | Test result is <b>over limit</b> line.   |
| P/A | <b>Peak</b> or <b>Average</b>  |
| H/V | <b>Horizontal</b> or <b>Vertical</b>   |



A calculation example for radiated spurious emission is shown as below:

| BT      | Note | Frequency | Level      | Over   | Limit      | Read     | Antenna  | Path   | Preamp | Ant    | Table   | Peak    | Pol.    |
|---------|------|-----------|------------|--------|------------|----------|----------|--------|--------|--------|---------|---------|---------|
|         |      | ( MHz )   | ( dBμV/m ) | ( dB ) | Line       | Level    | Factor   | Loss   | Factor | Pos    | Pos     | Avg.    |         |
|         |      |           |            |        | ( dBμV/m ) | ( dBμV ) | ( dB/m ) | ( dB ) | ( dB ) | ( cm ) | ( deg ) | ( P/A ) | ( H/V ) |
| BT      |      | 2390      | 55.45      | -18.55 | 74         | 54.51    | 32.22    | 4.58   | 35.86  | 103    | 308     | P       | H       |
| CH 00   |      | 2390      | 43.54      | -10.46 | 54         | 42.6     | 32.22    | 4.58   | 35.86  | 103    | 308     | A       | H       |
| 2402MHz |      |           |            |        |            |          |          |        |        |        |         |         |         |

1. Path Loss(dB) = Cable loss(dB) + Filter loss(dB) + Attenuator loss(dB)
2. Level(dBμV/m) =  
Antenna Factor(dB/m) + Path Loss(dB) + Read Level(dBμV) - Preamp Factor(dB)
3. Over Limit(dB) = Level(dBμV/m) – Limit Line(dBμV/m)

**For Peak Limit @ 2390MHz:**

1. Level(dBμV/m)  
= Antenna Factor(dB/m) + Path Loss(dB) + Read Level(dBμV) - Preamp Factor(dB)  
= 32.22(dB/m) + 4.58(dB) + 54.51(dBμV) – 35.86 (dB)  
= 55.45 (dBμV/m)
2. Over Limit(dB)  
= Level(dBμV/m) – Limit Line(dBμV/m)  
= 55.45(dBμV/m) – 74(dBμV/m)  
= -18.55(dB)

**For Average Limit @ 2390MHz:**

1. Level(dBμV/m)  
= Antenna Factor(dB/m) + Path Loss(dB) + Read Level(dBμV) - Preamp Factor(dB)  
= 32.22(dB/m) + 4.58(dB) + 42.6(dBμV) – 35.86 (dB)  
= 43.54 (dBμV/m)
2. Over Limit(dB)  
= Level(dBμV/m) – Limit Line(dBμV/m)  
= 43.54(dBμV/m) – 54(dBμV/m)  
= -10.46(dB)

**Both peak and average measured complies with the limit line, so test result is “PASS”.**



## Appendix C. Radiated Spurious Emission Plots

|                 |                                 |                     |           |
|-----------------|---------------------------------|---------------------|-----------|
| Test Engineer : | Karl Hou, CR Liao and Andy Yang | Temperature :       | 20 ~ 25°C |
|                 |                                 | Relative Humidity : | 50 ~ 60%  |

### 2.4GHz 2400~2483.5MHz

#### BT (Band Edge @ 3m)

| BT   | 2.4GHz 2400~2483.5MHz Band Edge @ 3m  |  |
|------|---|--|
|      | BT CH00 2402MHz   |  |
|      | Horizontal  | Fundamental  |
| Peak | <p>Site : 03CH16-HY<br/>           Condition : PEAK_BE_74 3m 91200_1522 HORIZONTAL<br/>           RBW:1000.000KHz VBW:3000.000KHz SWT:Auto<br/>           Detector : Peak<br/>           Project : 042916</p> | <p>Site : 03CH16-HY<br/>           Condition : PEAK_74 3m 91200_1522 HORIZONTAL<br/>           RBW:1000.000KHz VBW:3000.000KHz SWT:Auto<br/>           Detector : Peak<br/>           Project : 042916</p> |

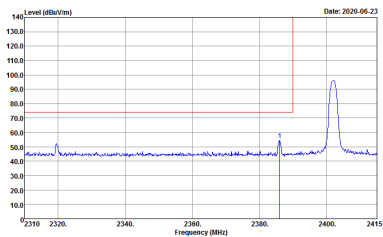
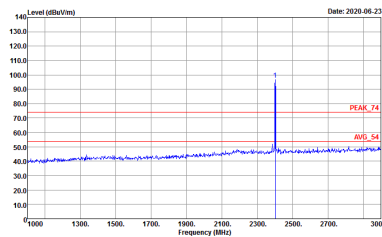

| BT              | 2.4GHz 2400~2483.5MHz Band Edge @ 3m  |  |
|-----------------|---|--|
| BT CH00 2402MHz |   |  |
| Vertical        |   | Fundamental  |
| Peak            |  <p data-bbox="430 728 702 795">Site : 03CH16-11Y<br/>Condition : PEAK_BE_74 3m 91200_1522 VERTICAL<br/>Detector : Peak<br/>Project : 042916</p> |  <p data-bbox="901 728 1173 795">Site : 03CH16-11Y<br/>Condition : PEAK_74 3m 91200_1522 VERTICAL<br/>Detector : Peak<br/>Project : 042916</p> |



|      |   |  |
|------|---|--|
| BT   | 2.4GHz 2400~2483.5MHz Band Edge @ 3m  |  |
|      | BT CH39 2441MHz   |  |
|      | Horizontal  | Fundamental  |
| Peak | <p>Site : 03CH16-HY<br/>         Condition : PEAK_BE_74 3m 91200_1522 HORIZONTAL<br/>         : RBW:1000.000KHz VBW:3000.000KHz SWT:Auto<br/>         Detector : Peak<br/>         Project : 042916</p> | <p>Site : 03CH16-HY<br/>         Condition : PEAK_74 3m 91200_1522 HORIZONTAL<br/>         : RBW:1000.000KHz VBW:3000.000KHz SWT:Auto<br/>         Detector : Peak<br/>         Project : 042916</p> |
| Peak | <p>Site : 03CH16-HY<br/>         Condition : PEAK_BE_74 3m 91200_1522 HORIZONTAL<br/>         : RBW:1000.000KHz VBW:3000.000KHz SWT:Auto<br/>         Detector : Peak<br/>         Project : 042916</p> | Left blank   |

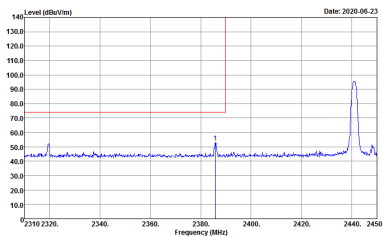

| BT                 | 2.4GHz 2400~2483.5MHz Band Edge @ 3m  |   |
|--------------------|---|---|
|                    | BT CH39 2441MHz   |   |
|                    | Vertical  | Fundamental   |
| <p><b>Peak</b></p> |  <p>Date: 2020-06-23</p> <p>Site : 03CH16-HY<br/>           Condition : PEAK_BE_74 3m 91200_1522 VERTICAL<br/>           RBW:1000.000KHz VBW:3000.000KHz SWT:Auto<br/>           Detector : Peak<br/>           Project : 042916</p>   |  <p>Date: 2020-06-23</p> <p>Site : 03CH16-HY<br/>           Condition : PEAK_74 3m 91200_1522 VERTICAL<br/>           RBW:1000.000KHz VBW:3000.000KHz SWT:Auto<br/>           Detector : Peak<br/>           Project : 042916</p> |
| <p><b>Peak</b></p> |  <p>Date: 2020-06-23</p> <p>Site : 03CH16-HY<br/>           Condition : PEAK_BE_74 3m 91200_1522 VERTICAL<br/>           RBW:1000.000KHz VBW:3000.000KHz SWT:Auto<br/>           Detector : Peak<br/>           Project : 042916</p> | <p><b>Left blank</b></p>  |

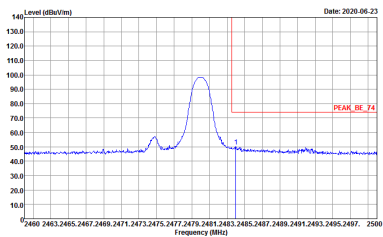
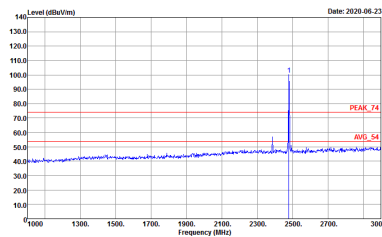

|      |   |   |
|------|---|---|
| BT   | 2.4GHz 2400~2483.5MHz Band Edge @ 3m  |   |
|      | BT CH78 2480MHz   |   |
|      | Horizontal  | Fundamental   |
| Peak |  <p>Site : 03CH16-11Y<br/>Condition : PEAK_BE_74 3m 91200_1522 HORIZONTAL<br/>Detector : Peak<br/>Project : 042916</p> |  <p>Site : 03CH16-11Y<br/>Condition : PEAK_74 3m 91200_1522 HORIZONTAL<br/>Detector : Peak<br/>Project : 042916</p> |



|      |   |  |
|------|---|--|
| BT   | 2.4GHz 2400~2483.5MHz Band Edge @ 3m  |  |
|      | BT CH78 2480MHz   |  |
|      | Vertical  | Fundamental  |
| Peak | <p>Site : 03CH6-11Y<br/>Condition : PEAK_BE_74 3m 91200_1522 VERTICAL<br/>Detector : Peak<br/>Project : -042916</p> | <p>Site : 03CH6-11Y<br/>Condition : PEAK_74 3m 91200_1522 VERTICAL<br/>Detector : Peak<br/>Project : -042916</p> |





2.4GHz 2400~2483.5MHz

BT (Harmonic @ 3m)

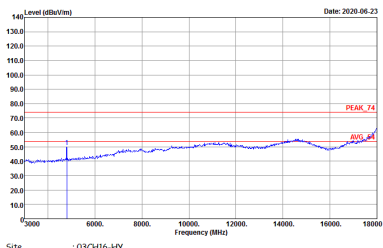
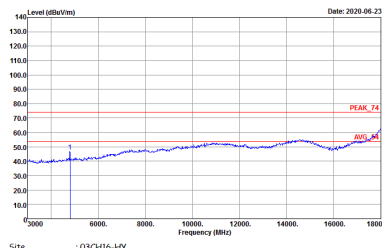
| BT           | 2.4GHz 2400~2483.5MHz Harmonic @ 3m   |  |
|--------------|---|--|
|              | BT CH00 2402MHz   |  |
|              | Horizontal  | Vertical   |
| Peak<br>Avg. |  <p>Site : 03CH16-HY<br/>Condition : PEAK_74 3m 91200_1522 HORIZONTAL<br/>Detector : Peak<br/>Project : 042916</p> |  <p>Site : 03CH16-HY<br/>Condition : PEAK_74 3m 91200_1522 VERTICAL<br/>Detector : Peak<br/>Project : 042916</p> |

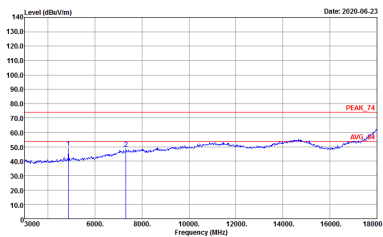
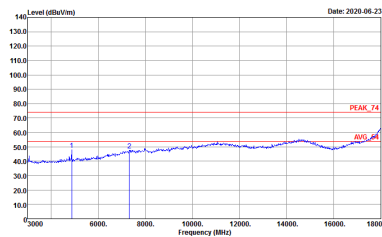

| BT                   | 2.4GHz 2400~2483.5MHz Harmonic @ 3m  |   |
|----------------------|--|---|
| BT CH39 2441MHz      |  |   |
| Horizontal           |  | Vertical  |
| <p>Peak<br/>Avg.</p> |  <p>Site : 03CH16-11Y<br/>Condition : PEAK_74 3m 91200_1522 HORIZONTAL<br/>Detector : Peak<br/>Project : 042916</p> |  <p>Site : 03CH16-11Y<br/>Condition : PEAK_74 3m 91200_1522 VERTICAL<br/>Detector : Peak<br/>Project : 042916</p> |

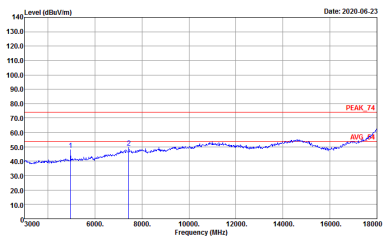
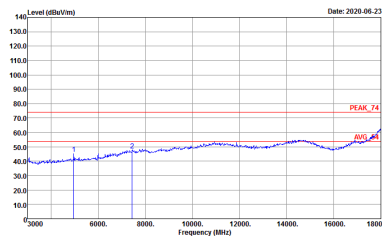

| BT                   | 2.4GHz 2400~2483.5MHz Harmonic @ 3m  |   |
|----------------------|--|---|
| BT CH78 2480MHz      |  |   |
|                      | Horizontal   | Vertical  |
| <p>Peak<br/>Avg.</p> |  <p>Site : 03CH16-11Y<br/>Condition : PEAK_74 3m 91200_1522 HORIZONTAL<br/>Detector : Peak<br/>Project : 042916</p> |  <p>Site : 03CH16-11Y<br/>Condition : PEAK_74 3m 91200_1522 VERTICAL<br/>Detector : Peak<br/>Project : 042916</p> |



Emission above 18GHz

2.4GHz BT (SHF)

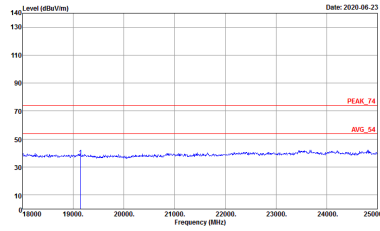
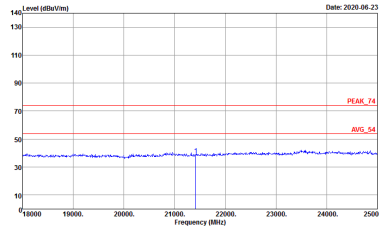
| BT           | 2.4GHz 2400~2483.5MHz   |  |
|--------------|---|--|
|              | BT SHF  |  |
|              | Horizontal  | Vertical   |
| QP /<br>Peak |  <p>Site : 03CH16-HY<br/>Condition : PEAK_74 1m SHF HORN 88HA9170584 HORIZONTAL<br/>Detector : Peak<br/>Project : 042916</p> |  <p>Site : 03CH16-HY<br/>Condition : PEAK_74 1m SHF HORN 88HA9170584 VERTICAL<br/>Detector : Peak<br/>Project : 042916</p> |



Emission below 1GHz

2.4GHz BT (LF)

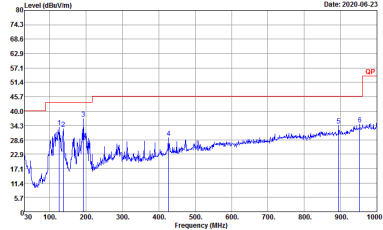
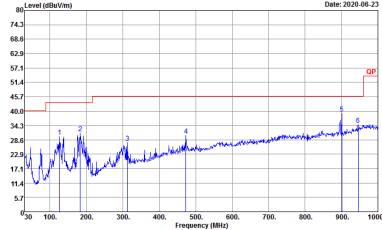
|              |   |  |
|--------------|---|--|
| BT           | 2.4GHz 2400~2483.5MHz   |  |
|              | BT LF   |  |
|              | Horizontal  | Vertical   |
| QP /<br>Peak |  <p>Site : 03CH16-HY<br/> Condition : QP 3m BIL06_47020606 HORIZONTAL<br/> Detector : Peak<br/> Project : 042916</p> |  <p>Site : 03CH16-HY<br/> Condition : QP 3m BIL06_47020606 VERTICAL<br/> Detector : Peak<br/> Project : 042916</p> |



# Appendix D. Duty Cycle Plots

### 2DH5 on time (One Pulse) Plot on Channel 39

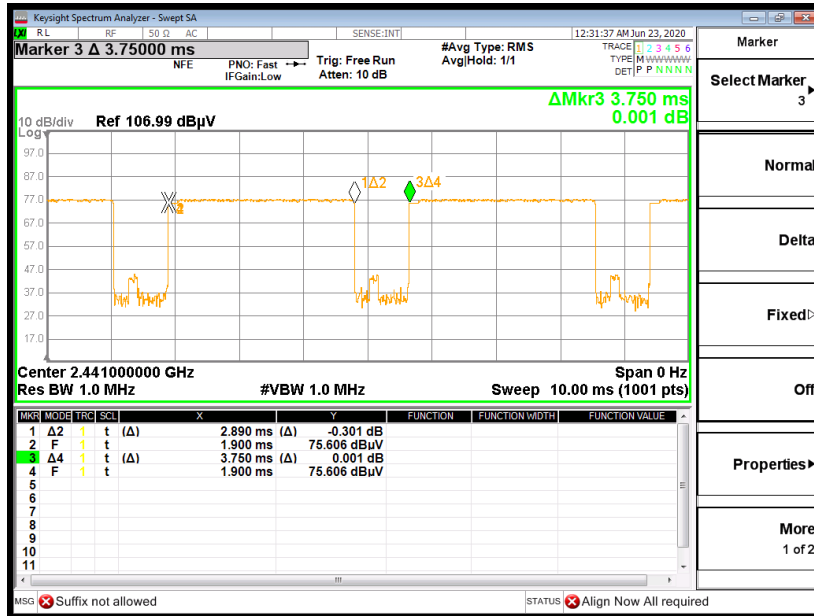

### on time (Count Pulses) Plot on Channel 39

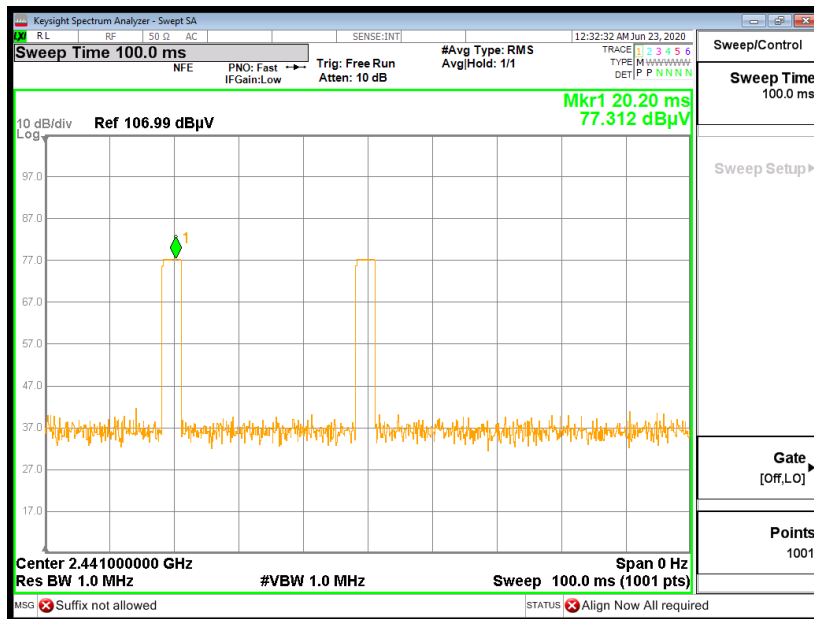

#### Note:

1. Worst case Duty cycle = on time/100 milliseconds =  $2 * 2.89 / 100 = 5.78 \%$
2. Worst case Duty cycle correction factor =  $20 * \log(\text{Duty cycle}) = -24.76 \text{ dB}$
3. 2DH5 has the highest duty cycle worst case and is reported.



**Duty Cycle Correction Factor Consideration for AFH mode:**

Bluetooth normal hopping rate is 1600Hz and reduced to 800Hz in AFH mode; due to the reduced number of hopping frequencies, with the same packet configuration the dwell time in each channel frequency within 100msec period is longer in AFH mode than normal mode.

In AFH mode, the minimum hopping frequencies are 20, to get the longest dwell time DH5 packet is observed; the period to have DH5 packet completing one hopping sequence is

$$2.89 \text{ ms} \times 20 \text{ channels} = 57.8 \text{ ms}$$

There cannot be 2 complete hopping sequences within 100ms period, considering the random hopping behavior, maximum 2 hops can be possibly observed within the period.  $[100 \text{ ms} / 57.8 \text{ ms}] = 2 \text{ hops}$

Thus, the maximum possible ON time:

$$2.89 \text{ ms} \times 2 = 5.78 \text{ ms}$$

Worst case Duty Cycle Correction factor, which is derived from the maximum possible ON time,

$$20 \times \log(5.78 \text{ ms}/100 \text{ ms}) = -24.76 \text{ dB}$$