



FCC RF Test Report

APPLICANT : Zebra Technologies Corporation
EQUIPMENT : Presentation Cradle
BRAND NAME : Zebra
MODEL NAME : CR2278
MARKETING NAME : CR2278
FCC ID : UZ7CR2278
STANDARD : FCC Part 15 Subpart C §15.247
CLASSIFICATION : (DTS) Digital Transmission System

The product was received on Feb. 09, 2017 and testing was completed on Apr. 12, 2017. We, SPORTON INTERNATIONAL INC., would like to declare that the tested sample has been evaluated in accordance with the test procedures and has been in compliance with the applicable technical standards.

The test results in this report apply exclusively to the tested model / sample. Without written approval of SPORTON INTERNATIONAL INC., the test report shall not be reproduced except in full.

Reviewed by: Joseph Lin / Supervisor

Approved by: Jones Tsai / Manager



SPORTON INTERNATIONAL INC.

No. 52, Hwa Ya 1st Rd., Hwa Ya Technology Park, Kwei-Shan District, Tao Yuan City, Taiwan, R.O.C.

SPORTON INTERNATIONAL INC.

TEL : 886-3-327-3456

FAX : 886-3-328-4978

FCC ID : UZ7CR2278

Page Number : 1 of 37

Report Issued Date : Apr. 24, 2017

Report Version : Rev. 01

Report Template No.: BU5-FR15CBT4.0 Version 2.0



TABLE OF CONTENTS

SUMMARY OF TEST RESULT 4

1 GENERAL DESCRIPTION..... 5

1.1 Applicant 5

1.2 Manufacturer..... 5

1.3 Product Feature of Equipment Under Test..... 5

1.4 Product Specification of Equipment Under Test..... 6

1.5 Modification of EUT 6

1.6 Testing Location 6

1.7 Applicable Standards..... 6

2 TEST CONFIGURATION OF EQUIPMENT UNDER TEST..... 7

2.1 Carrier Frequency Channel 7

2.2 Test Mode..... 8

2.3 Connection Diagram of Test System..... 10

2.4 Support Unit used in test configuration and system 11

2.5 EUT Operation Test Setup 11

2.6 Measurement Results Explanation Example..... 11

3 TEST RESULT 12

3.1 6dB and 99% Bandwidth Measurement 12

3.2 Peak Output Power Measurement 17

3.3 Power Spectral Density Measurement 19

3.4 Conducted Band Edges and Spurious Emission Measurement 24

3.5 Radiated Band Edges and Spurious Emission Measurement 29

3.6 AC Conducted Emission Measurement..... 33

3.7 Antenna Requirements 35

4 LIST OF MEASURING EQUIPMENT 36

5 UNCERTAINTY OF EVALUATION..... 37

APPENDIX A. AC CONDUCTED EMISSION TEST RESULT

APPENDIX B. RADIATED SPURIOUS EMISSION

APPENDIX C. RADIATED SPURIOUS EMISSION PLOTS

APPENDIX D. DUTY CYCLE PLOTS

APPENDIX E. SETUP PHOTOGRAPHS



REVISION HISTORY

REPORT NO.	VERSION	DESCRIPTION	ISSUED DATE
FR720923B	Rev. 01	Initial issue of report	Apr. 24, 2017



SUMMARY OF TEST RESULT

Report Section	FCC Rule	Description	Limit	Result	Remark
3.1	15.247(a)(2)	6dB Bandwidth	$\geq 0.5\text{MHz}$	Pass	-
3.1	-	99% Bandwidth	-	Pass	-
3.2	15.247(b)(3)	Peak Output Power	$\leq 30\text{dBm}$	Pass	-
3.3	15.247(e)	Power Spectral Density	$\leq 8\text{dBm}/3\text{kHz}$	Pass	-
3.4	15.247(d)	Conducted Band Edges and Spurious Emission	$\leq 20\text{dBc}$	Pass	-
3.5	15.247(d)	Radiated Band Edges and Spurious Emission	15.209(a) & 15.247(d)	Pass	Under limit 7.63 dB at 2493.920 MHz
3.6	15.207	AC Conducted Emission	15.207(a)	Pass	Under limit 8.90 dB at 0.518 MHz
3.7	15.203 & 15.247(b)	Antenna Requirement	N/A	Pass	-



1 General Description

1.1 Applicant

Zebra Technologies Corporation
1 Zebra Plaza, Holtsville, NY 11742-1300, USA

1.2 Manufacturer

Zebra Technologies Corporation
1 Zebra Plaza, Holtsville, NY 11742-1300, USA

1.3 Product Feature of Equipment Under Test

Product Feature	
Equipment	Presentation Cradle
Brand Name	Zebra
Model Name	CR2278
Marketing Name	CR2278
FCC ID	UZ7CR2278
EUT supports Radios application	Bluetooth BR/EDR/LE
HW Version	A
SW Version	REV A
MFD	15FEB17
EUT Stage	Identical Prototype

Remark: The above EUT's information was declared by manufacturer. Please refer to the specifications or user's manual for more detailed description.

Specification of Accessories				
Adapter	Brand Name	Zebra	Part Number	PWR-WUA5V4W0US
RJ-50 to USB Cable	Brand Name	Zebra	Part Number	CBA-U21-S07ZAR
RJ-50-RS232 Cable	Brand Name	Zebra	Part Number	CBA-R01-S07PAR



1.4 Product Specification of Equipment Under Test

Standards-related Product Specification	
Tx/Rx Frequency Range	2402 MHz ~ 2480 MHz
Number of Channels	40
Carrier Frequency of Each Channel	40 Channel(37 hopping + 3 advertising channel)
Maximum Output Power to Antenna	2.87 dBm (0.0019 W)
99% Occupied Bandwidth	1.016MHz
Antenna Type / Gain	Printed Circuit Antenna type with gain 2.73 dBi
Type of Modulation	Bluetooth LE : GFSK

1.5 Modification of EUT

No modifications are made to the EUT during all test items.

1.6 Testing Location

Sporton Lab is accredited to ISO 17025 by Taiwan Accreditation Foundation (TAF code : 1190) and the FCC designation No. TW1190 under the FCC 2.948(e) by Mutual Recognition Agreement (MRA) in FCC Test.

Test Site	SPORTON INTERNATIONAL INC.		
Test Site Location	No. 52, Hwa Ya 1 st Rd., Hwa Ya Technology Park, Kwei-Shan District, Tao Yuan City, Taiwan, R.O.C. TEL: +886-3-327-3456 FAX: +886-3-328-4978		
Test Site No.	Sporton Site No.		
	TH05-HY	CO05-HY	03CH07-HY

Note: The test site complies with ANSI C63.4 2014 requirement.

1.7 Applicable Standards

According to the specifications of the manufacturer, the EUT must comply with the requirements of the following standards:

- ♦ FCC Part 15 Subpart C §15.247
- ♦ FCC KDB Publication No. 558074 D01 DTS Meas. Guidance v04
- ♦ ANSI C63.10-2013

Remark: All test items were verified and recorded according to the standards and without any deviation during the test.



2 Test Configuration of Equipment Under Test

2.1 Carrier Frequency Channel

Frequency Band	Channel	Freq. (MHz)	Channel	Freq. (MHz)
2400-2483.5 MHz	0	2402	21	2444
	1	2404	22	2446
	2	2406	23	2448
	3	2408	24	2450
	4	2410	25	2452
	5	2412	26	2454
	6	2414	27	2456
	7	2416	28	2458
	8	2418	29	2460
	9	2420	30	2462
	10	2422	31	2464
	11	2424	32	2466
	12	2426	33	2468
	13	2428	34	2470
	14	2430	35	2472
	15	2432	36	2474
	16	2434	37	2476
	17	2436	38	2478
	18	2438	39	2480
	19	2440	-	-
20	2442	-	-	



2.2 Test Mode

The RF output power was recorded in the following table:

Channel	Frequency	Bluetooth – LE Average Output Power	
		Data Rate / Modulation	
		GFSK	
		1Mbps	
Ch00	2402MHz	0.79 dBm	
Ch19	2440MHz	0.68 dBm	
Ch39	2480MHz	0.61 dBm	

Channel	Frequency	Bluetooth – LE Peak Output Power	
		Data Rate / Modulation	
		GFSK	
		1Mbps	
Ch00	2402MHz	2.87 dBm	
Ch19	2440MHz	2.85 dBm	
Ch39	2480MHz	2.70 dBm	

- a. The EUT has been associated with peripherals and configuration operated in a manner tended to maximize its emission characteristics in a typical application. Frequency range investigated: conduction emission (150 kHz to 30 MHz), radiation emission (9 kHz to the 10th harmonic of the highest fundamental frequency or to 40 GHz, whichever is lower).
- b. AC power line Conducted Emission was tested under maximum output power.



The following summary table is showing all test modes to demonstrate in compliance with the standard.

Summary table of Test Cases	
Test Item	Data Rate / Modulation
	Bluetooth – LE / GFSK
Conducted TCs	Mode 1: Bluetooth Tx CH00_2402 MHz_1Mbps Mode 2: Bluetooth Tx CH19_2440 MHz_1Mbps Mode 3: Bluetooth Tx CH39_2480 MHz_1Mbps
Radiated TCs	Mode 1: Bluetooth Tx CH00_2402 MHz_1Mbps Mode 2: Bluetooth Tx CH19_2440 MHz_1Mbps Mode 3: Bluetooth Tx CH39_2480 MHz_1Mbps
AC Conducted Emission	Mode 1: Bluetooth Link between EUT (Digital Scanner) and EUT (Cradle) + EUT (Digital Scanner) Scan + Adapter + EUT (Cradle) RJ-50 to RS-232 Cable (Data Link with PC)

2.3 Connection Diagram of Test System

<Bluetooth – LE Tx Mode>

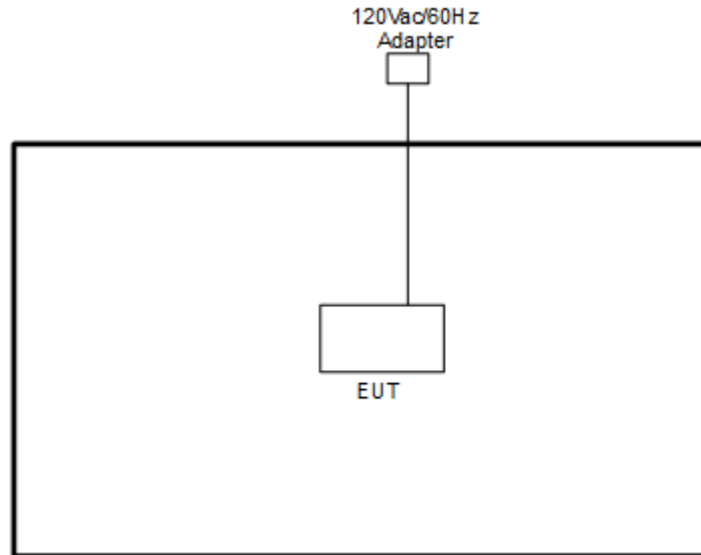

<AC Conducted Emission Mode>

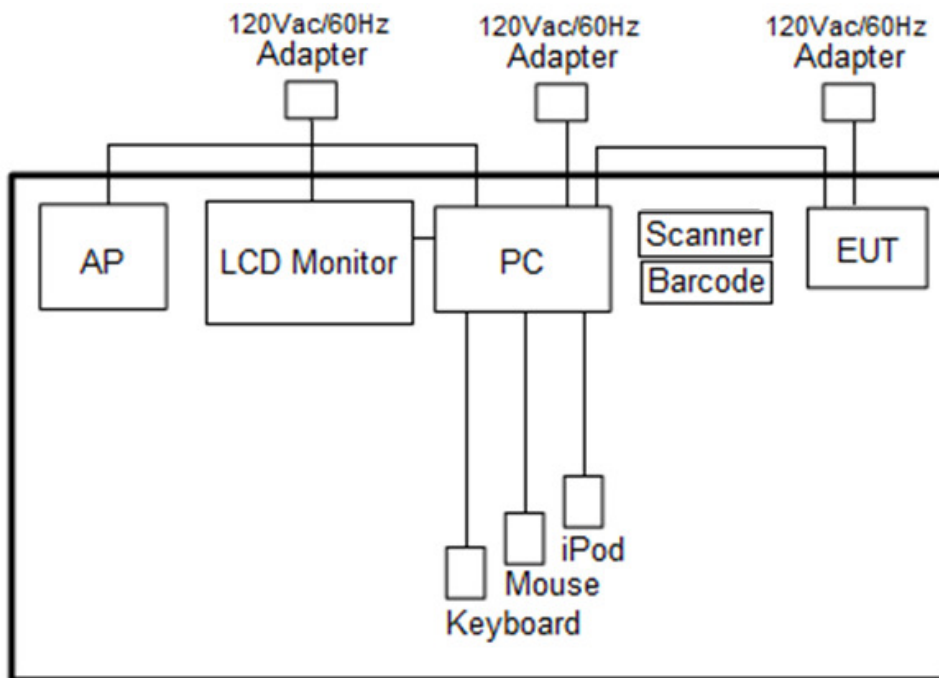



2.4 Support Unit used in test configuration and system

Item	Equipment	Trade Name	Model Name	FCC ID	Data Cable	Power Cord
1.	WLAN AP	ASUS	RT-AC66U	MSQ-RTAC66U	N/A	Unshielded, 1.8 m
2.	LCD Monitor	DELL	U2410	FCC DoC	Shielded, 1.6 m	Unshielded, 1.8 m
3.	PC	HP	HP Compaq Elite 8300 Microtower	FCC DoC	N/A	Unshielded, 1.8 m
4.	(USB) Keyboard	Logitech	K120	FCC DoC	Shielded, 1.8 m	N/A
5.	(USB) Mouse	DELL	MS-111L	FCC DoC	Shielded, 1.8 m	N/A
6.	iPod	Apple	A1285	FCC DoC	Shielded, 1.0 m	N/A
7.	Barcode	N/A	N/A	N/A	N/A	N/A

2.5 EUT Operation Test Setup

The RF test items, an engineering test program was provided and enabled to make EUT transmitting and receiving signals.

2.6 Measurement Results Explanation Example

For all conducted test items:

The offset level is set in the spectrum analyzer to compensate the RF cable loss and attenuator factor between EUT conducted output port and spectrum analyzer. With the offset compensation, the spectrum analyzer reading level is exactly the EUT RF output level.

Example :

The spectrum analyzer offset is derived from RF cable loss and attenuator factor.

Offset = RF cable loss + attenuator factor.

Following shows an offset computation example with cable loss 4.2 dB and 10dB attenuator.

$$\begin{aligned} \text{Offset(dB)} &= \text{RF cable loss(dB)} + \text{attenuator factor(dB)}. \\ &= 4.2 + 10 = 14.2 \text{ (dB)} \end{aligned}$$

3 Test Result

3.1 6dB and 99% Bandwidth Measurement

3.1.1 Limit of 6dB and 99% Bandwidth

The minimum 6 dB bandwidth shall be at least 500 kHz.

3.1.2 Measuring Instruments

The section 4.0 of List of Measuring Equipment of this test report is used for test.

3.1.3 Test Procedures

1. The testing follows FCC KDB Publication No. 558074 D01 DTS Meas. Guidance v04.
2. The RF output of EUT was connected to the spectrum analyzer by RF cable and attenuator. The path loss was compensated to the results for each measurement.
3. Set to the maximum power setting and enable the EUT transmit continuously.
4. Make the measurement with the spectrum analyzer's resolution bandwidth (RBW) = 100 kHz. Set the Video bandwidth (VBW) = 300 kHz. In order to make an accurate measurement. The 6 dB bandwidth must be greater than 500 kHz.
5. For 99% Bandwidth Measurement, the spectrum analyzer's resolution bandwidth (RBW) is set 30kHz and set the Video bandwidth (VBW) = 100kHz.
6. Measure and record the results in the test report.

3.1.4 Test Setup





3.1.5 Test Result of 6dB Bandwidth

Mod.	Data Rate	NTX	CH.	Freq. (MHz)	99% Occupied BW (MHz)	6dB BW (MHz)	6dB BW Limit (MHz)	Pass/Fail
BLE	1Mbps	1	0	2402	1.02	0.66	0.50	Pass
BLE	1Mbps	1	19	2440	1.01	0.66	0.50	Pass
BLE	1Mbps	1	39	2480	1.01	0.65	0.50	Pass

6 dB Bandwidth Plot on Channel 00

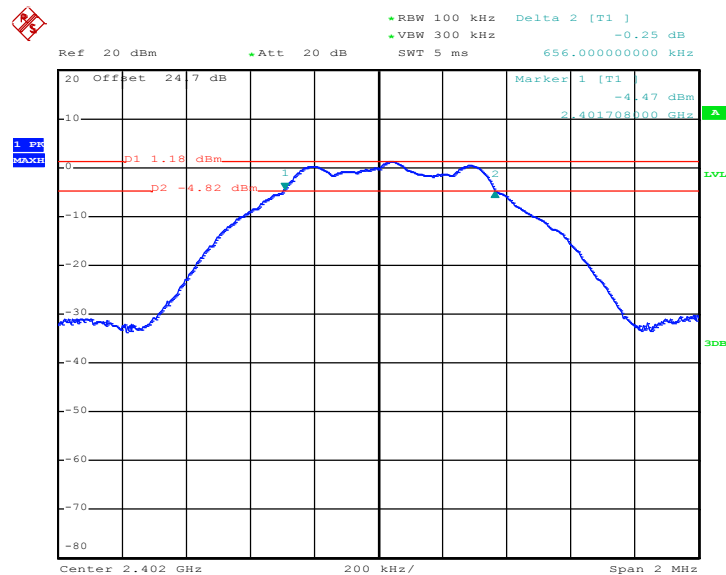

Date: 12.APR.2017 15:57:35



6 dB Bandwidth Plot on Channel 19

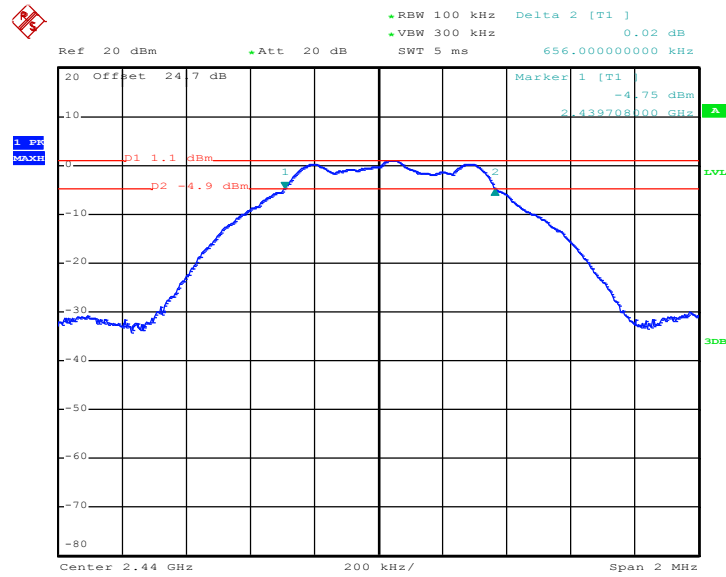

Date: 12.APR.2017 16:02:11

6 dB Bandwidth Plot on Channel 39

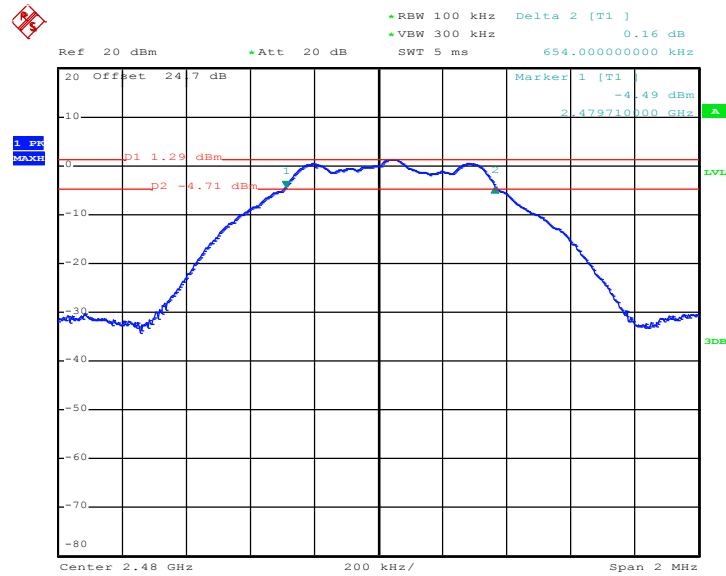

Date: 12.APR.2017 16:04:58



3.1.6 Test Result of 99% Occupied Bandwidth

99% Bandwidth Plot on Channel 00

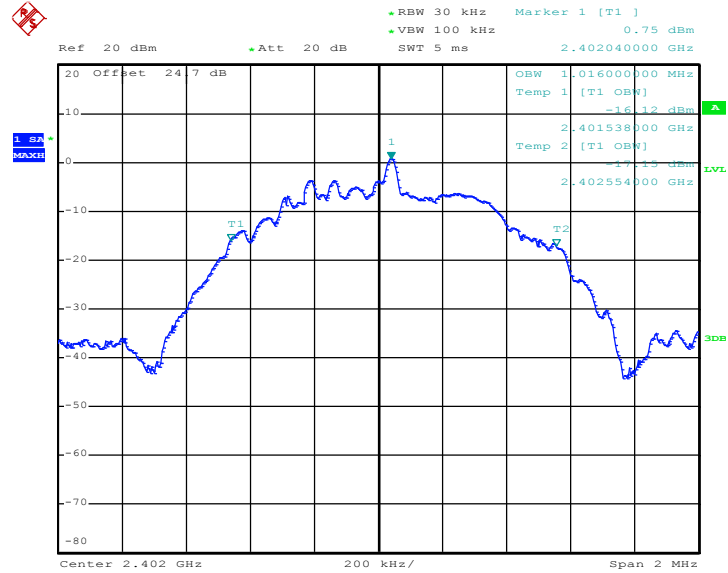

Date: 12.APR.2017 15:59:41



99% Occupied Bandwidth Plot on Channel 19

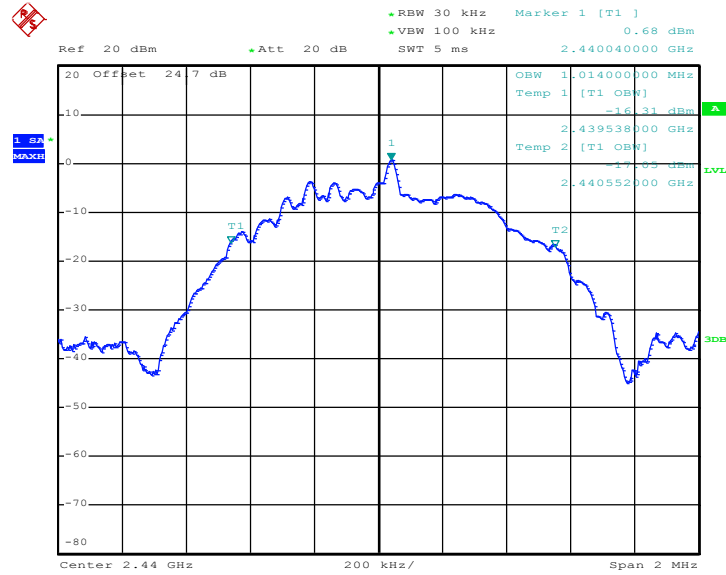

Date: 12.APR.2017 16:03:30

99% Occupied Bandwidth Plot on Channel 39

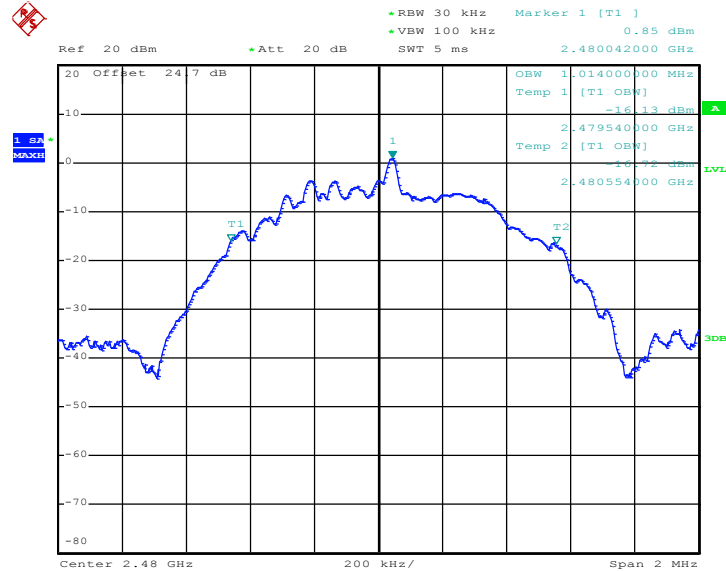

Date: 12.APR.2017 16:07:06

Note: The occupied channel bandwidth is maintained within the band of operation for all of the modulations.

3.2 Peak Output Power Measurement

3.2.1 Limit of Peak Output Power

For systems using digital modulation in the 2400-2483.5MHz, the limit for peak output power is 30dBm. If transmitting antenna of directional gain greater than 6dBi is used, the peak output power from the intentional radiator shall be reduced below the above stated value by the amount in dB that the directional gain of the antenna exceeds 6 dBi. In case of point-to-point operation, the limit has to be reduced by 1dB for every 3dB that the directional gain of the antenna exceeds 6dBi.

3.2.2 Measuring Instruments

The section 4.0 of List of Measuring Equipment of this test report is used for test.

3.2.3 Test Procedures

1. The testing follows the Measurement Procedure of FCC KDB No. 558074 DTS D01 Meas. Guidance v04 section 9.1.2 PKPM1 Peak power meter method.
2. The RF output of EUT was connected to the power meter by RF cable and attenuator. The path loss was compensated to the results for each measurement.
3. Set to the maximum power setting and enable the EUT transmit continuously.
4. Measure the conducted output power and record the results in the test report.

3.2.4 Test Setup

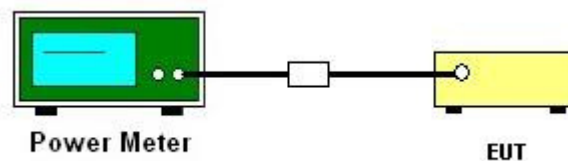



3.2.5 Test Result of Peak Output Power

Mod.	Data Rate	NTX	CH.	Freq. (MHz)	Peak Conducted Power (dBm)	Conducted Power Limit (dBm)	DG (dBi)	EIRP Power (dBm)	EIRP Power Limit (dBm)	Pass /Fail
BLE	1Mbps	1	0	2402	2.37	30.00	2.73	5.10	36.00	Pass
BLE	1Mbps	1	19	2440	2.35	30.00	2.73	5.08	36.00	Pass
BLE	1Mbps	1	39	2480	2.20	30.00	2.73	4.93	36.00	Pass

Mod.	Data Rate	NTX	CH.	Freq. (MHz)	Duty Factor (dB)	Average Conducted Power (dBm)
BLE	1Mbps	1	0	2402	1.87	0.79
BLE	1Mbps	1	19	2440	1.87	0.68
BLE	1Mbps	1	39	2480	1.87	0.61

3.3 Power Spectral Density Measurement

3.3.1 Limit of Power Spectral Density

The peak power spectral density shall not be greater than 8dBm in any 3kHz band at any time interval of continuous transmission.

3.3.2 Measuring Instruments

The section 4.0 of List of Measuring Equipment of this test report is used for test.

3.3.3 Test Procedures

1. The testing follows Measurement Procedure 10.2 Method PKPSD of FCC KDB Publication No. 558074 D01 DTS Meas. Guidance v04
2. The RF output of EUT was connected to the spectrum analyzer by RF cable and attenuator. The path loss was compensated to the results for each measurement.
3. Set to the maximum power setting and enable the EUT transmit continuously.
4. Make the measurement with the spectrum analyzer's resolution bandwidth (RBW) = 3 kHz. Video bandwidth VBW = 10 kHz In order to make an accurate measurement, set the span to 1.5 times DTS Channel Bandwidth. (6dB BW)
5. Detector = peak, Sweep time = auto couple, Trace mode = max hold, Allow trace to fully stabilize. Use the peak marker function to determine the maximum power level.
6. Measure and record the results in the test report.
7. The Measured power density (dBm)/ 100kHz is a reference level and used as 20dBc down limit line for Conducted Band Edges and Conducted Spurious Emission.

3.3.4 Test Setup

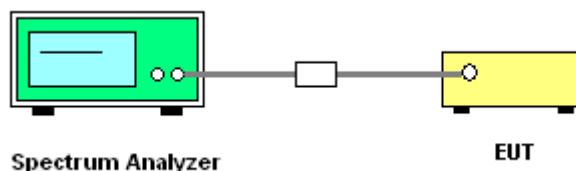



3.3.5 Test Result of Power Spectral Density

Mod.	Data Rate	NTX	CH.	Freq. (MHz)	Peak PSD (dBm /100kHz)	Peak PSD (dBm /3kHz)	DG (dBi)	Peak PSD Limit (dBm /3kHz)	Pass/Fail
BLE	1Mbps	1	0	2402	1.20	-13.51	2.73	8.00	Pass
BLE	1Mbps	1	19	2440	1.10	-13.47	2.73	8.00	Pass
BLE	1Mbps	1	39	2480	1.30	-13.37	2.73	8.00	Pass

3.3.6 Test Result of Power Spectral Density Plots (100kHz)

PSD 100kHz Plot on Channel 00

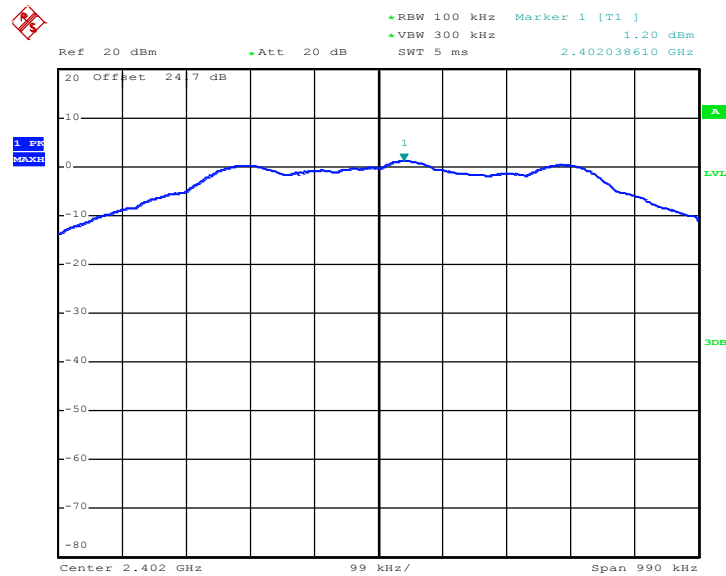

Date: 12.APR.2017 15:58:35



PSD 100kHz Plot on Channel 19

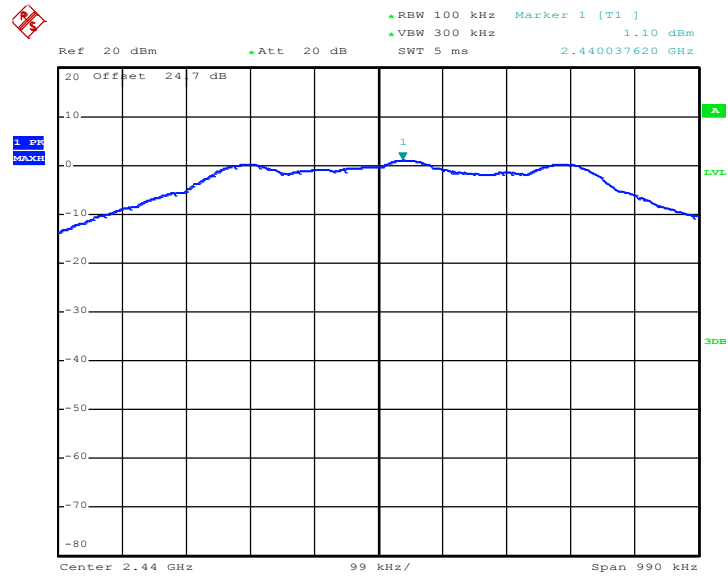

Date: 12.APR.2017 16:02:43

PSD 100kHz Plot on Channel 39

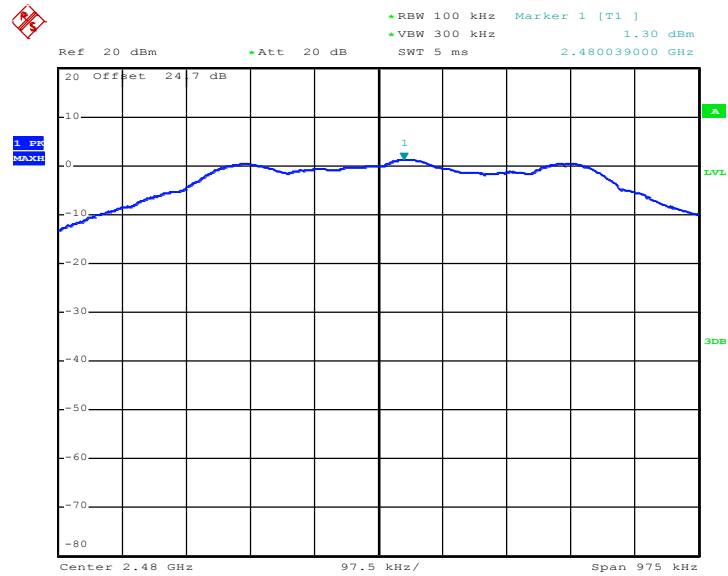

Date: 12.APR.2017 16:05:49



3.3.7 Test Result of Power Spectral Density Plots (3kHz)

PSD 3kHz Plot on Channel 00

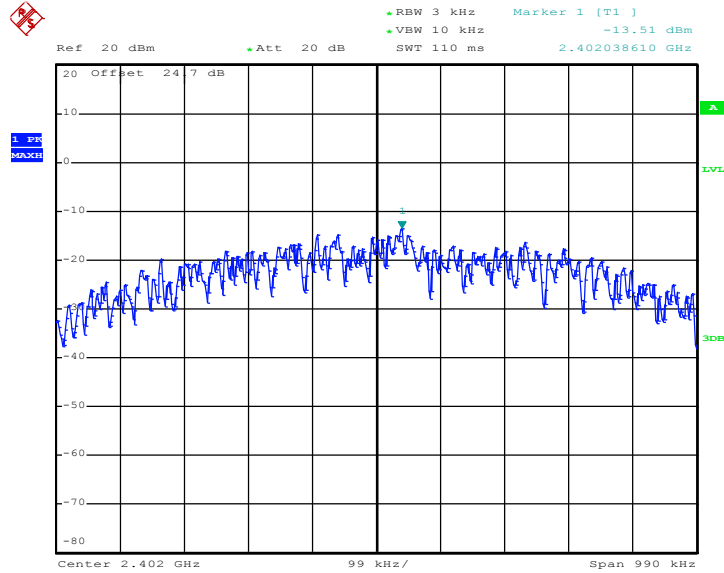

Date: 12.APR.2017 15:58:13



PSD 3kHz Plot on Channel 19

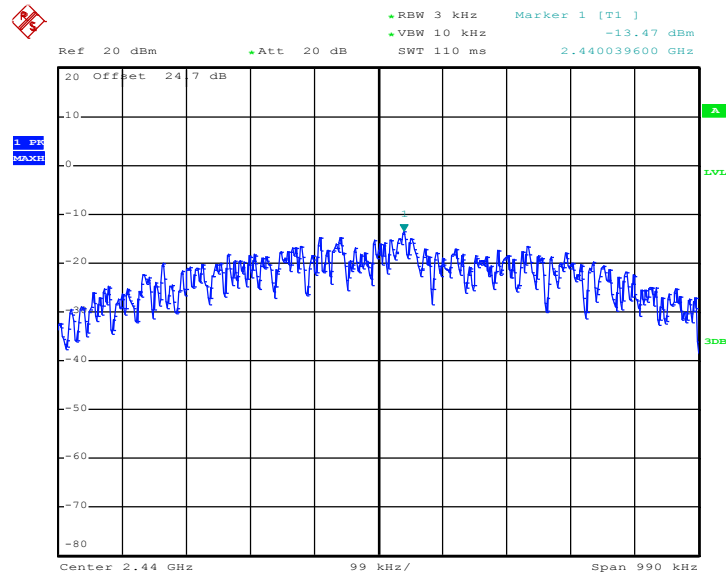

Date: 12.APR.2017 16:02:31

PSD 3kHz Plot on Channel 39

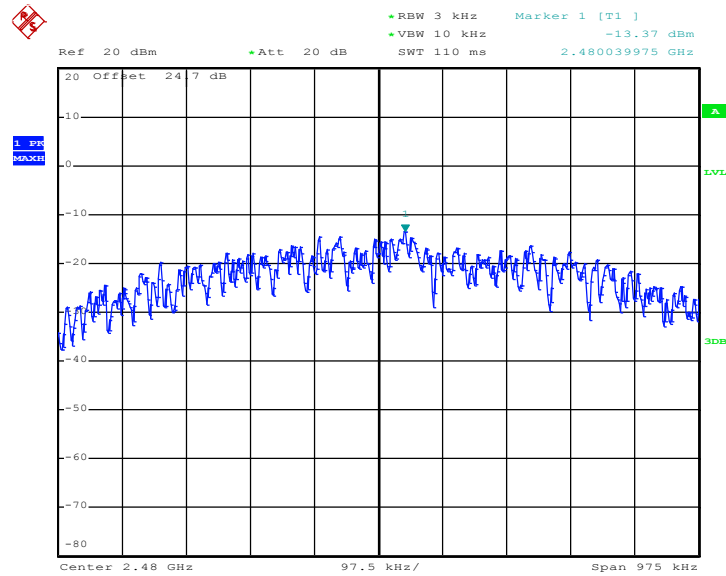

Date: 12.APR.2017 16:05:32

3.4 Conducted Band Edges and Spurious Emission Measurement

3.4.1 Limit of Conducted Band Edges and Spurious Emission

All harmonics/spurious must be at least 20 dB down from the highest emission level within the authorized band.

3.4.2 Measuring Instruments

The section 4.0 of List of Measuring Equipment of this test report is used for test.

3.4.3 Test Procedure

1. The testing follows FCC KDB Publication No. 558074 D01 DTS Meas. Guidance v04.
2. The RF output of EUT was connected to the spectrum analyzer by RF cable and attenuator. The path loss was compensated to the results for each measurement.
3. Set to the maximum power setting and enable the EUT transmit continuously.
4. Set RBW = 100 kHz, VBW=300 kHz, Peak Detector. Unwanted Emissions measured in any 100 kHz bandwidth outside of the authorized frequency band shall be attenuated by at least 20 dB relative to the maximum in-band peak PSD level in 100 kHz when maximum peak conducted output power procedure is used. If the transmitter complies with the conducted power limits based on the use of RMS averaging over a time interval, the attenuation required under this paragraph shall be 30 dB instead of 20 dB.
5. Measure and record the results in the test report.
6. The RF fundamental frequency should be excluded against the limit line in the operating frequency band.

3.4.4 Test Setup





3.4.5 Test Result of Conducted Band Edges Plots

Low Band Edge Plot on Channel 00

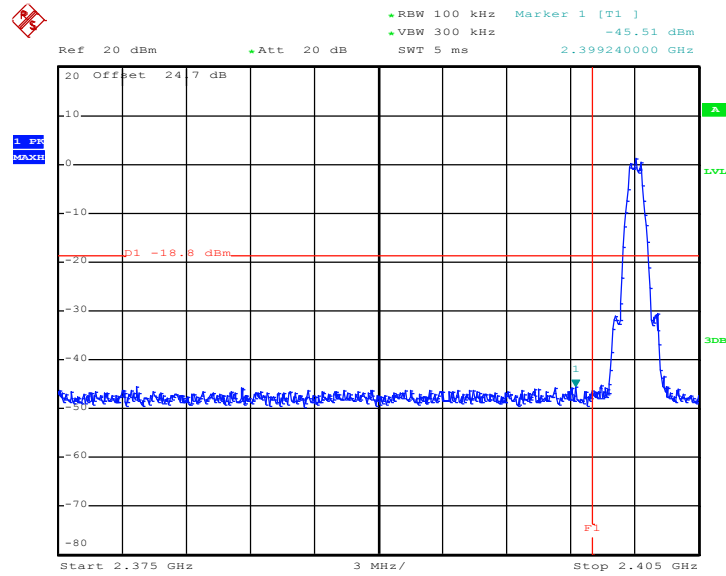

Date: 12.APR.2017 15:58:54

High Band Edge Plot on Channel 39

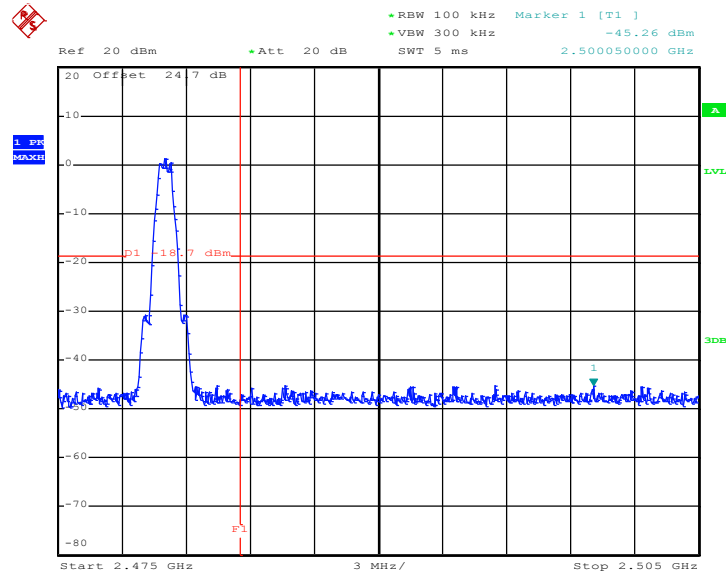

Date: 12.APR.2017 16:06:12



3.4.6 Test Result of Conducted Spurious Emission Plots

Conducted Spurious Emission Plot on Bluetooth LE 1Mbps GFSK Channel 00

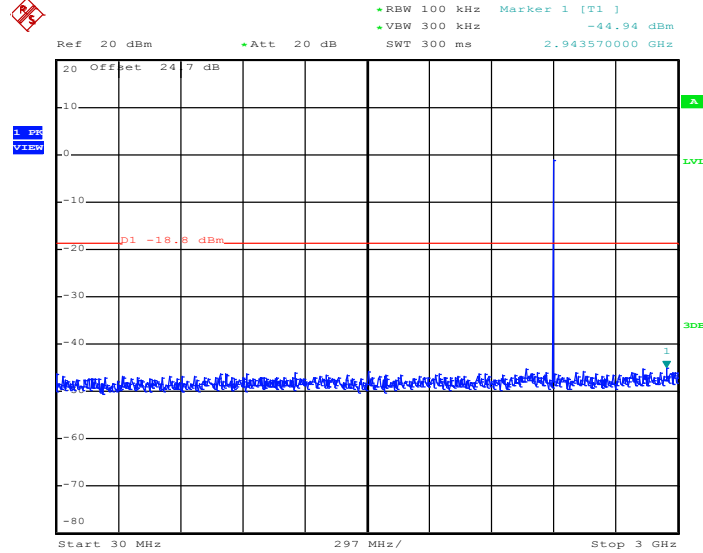

Date: 12.APR.2017 15:59:09

Conducted Spurious Emission Plot on Bluetooth LE 1Mbps GFSK Channel 00

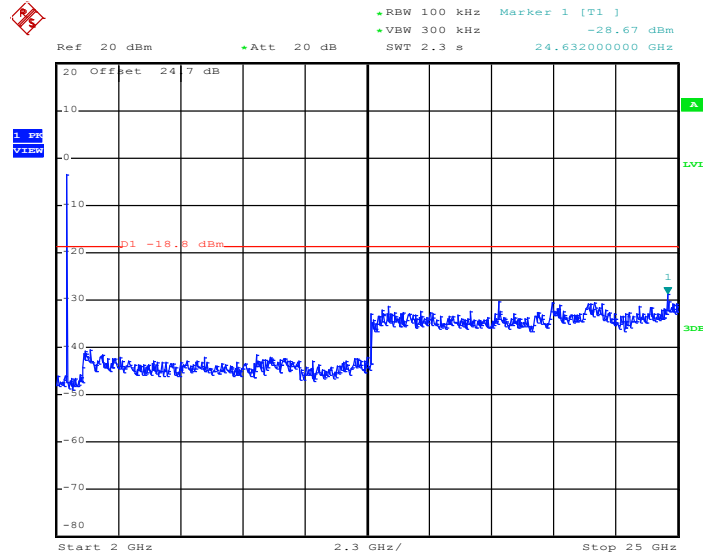

Date: 12.APR.2017 15:59:17



Conducted Spurious Emission Plot on Bluetooth LE 1Mbps GFSK Channel 19

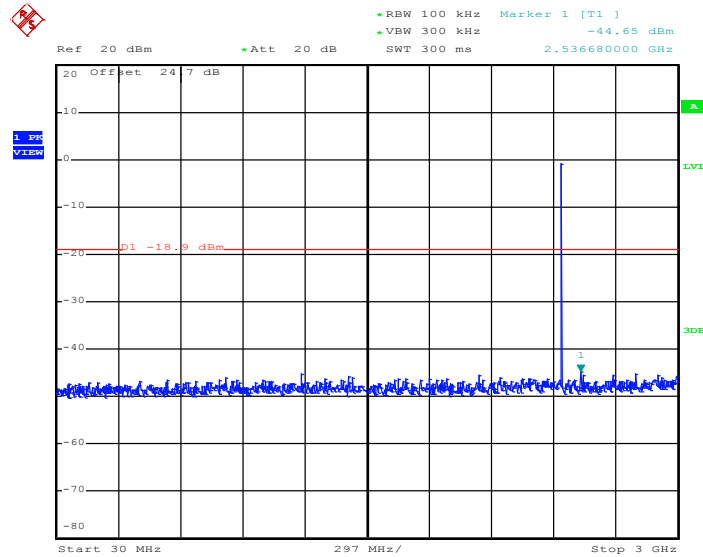

Date: 12.APR.2017 16:02:56

Conducted Spurious Emission Plot on Bluetooth LE 1Mbps GFSK Channel 19

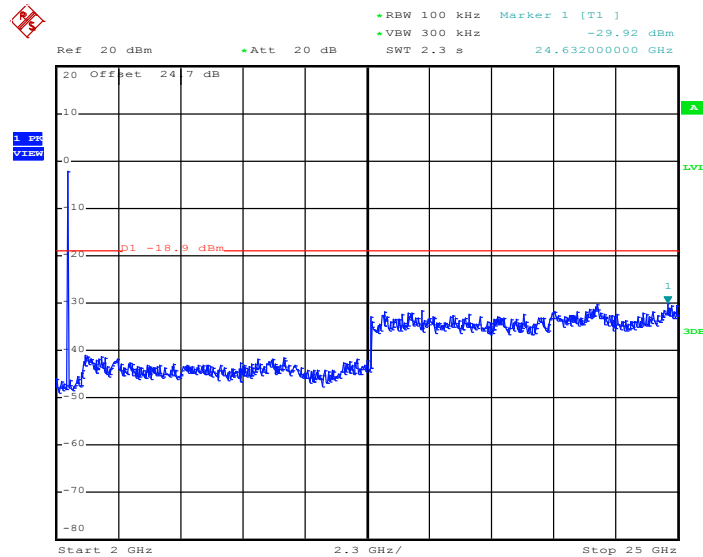

Date: 12.APR.2017 16:03:05



Conducted Spurious Emission Plot on Bluetooth LE 1Mbps GFSK Channel 39

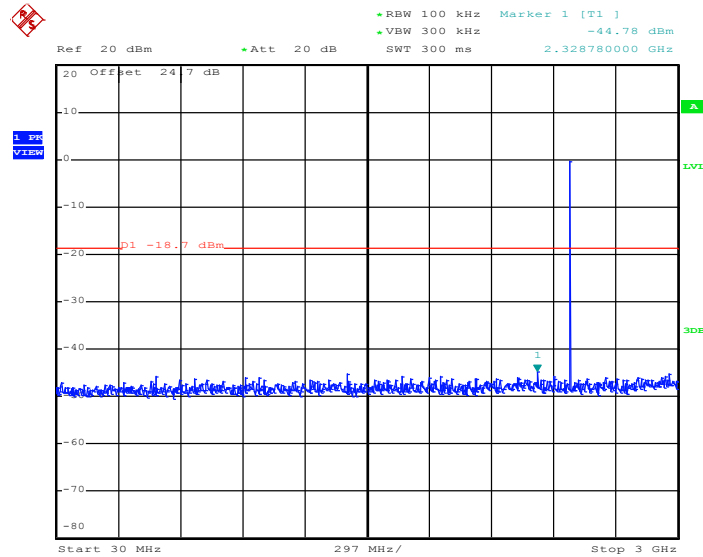

Date: 12.APR.2017 16:06:30

Conducted Spurious Emission Plot on Bluetooth LE 1Mbps GFSK Channel 39

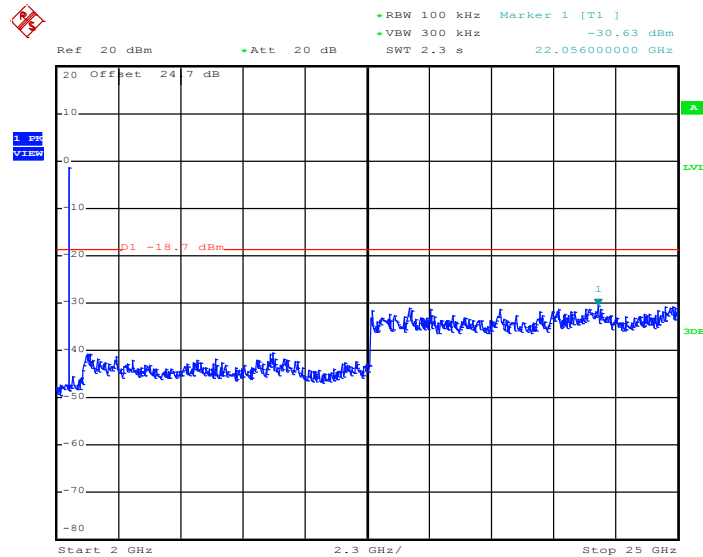

Date: 12.APR.2017 16:06:39



3.5 Radiated Band Edges and Spurious Emission Measurement

3.5.1 Limit of Radiated Band Edges and Spurious Emission

In any 100 kHz bandwidth outside the intentional radiator frequency band, all harmonics/spurious must be at least 20 dB below the highest emission level within the authorized band. If the output power of this device was measured by spectrum analyzer, the attenuation under this paragraph shall be 30 dB instead of 20 dB. In addition, radiated emissions which fall in the restricted bands must also comply with the limits as below.

Frequency (MHz)	Field Strength (microvolts/meter)	Measurement Distance (meters)
0.009 – 0.490	2400/F(kHz)	300
0.490 – 1.705	24000/F(kHz)	30
1.705 – 30.0	30	30
30 – 88	100	3
88 – 216	150	3
216 - 960	200	3
Above 960	500	3

3.5.2 Measuring Instruments

The section 4.0 of List of Measuring Equipment of this test report is used for test.



3.5.3 Test Procedures

1. The testing follows FCC KDB Publication No. 558074 D01 DTS Meas. Guidance v04.
2. The EUT was arranged to its worst case and then tune the antenna tower (from 1 m to 4 m) and turntable (from 0 degree to 360 degrees) to find the maximum reading. A pre-amp and a high pass filter are used for the test in order to get better signal level.
3. The EUT was placed on a turntable with 0.8 meter for frequency below 1GHz and 1.5 meter for frequency above 1GHz respectively above ground.
4. The EUT was set 3 meters from the interference receiving antenna, which was mounted on the top of a variable height antenna tower.
5. Corrected Reading: Antenna Factor + Cable Loss + Read Level - Preamp Factor = Level
6. For testing below 1GHz, if the emission level of the EUT in peak mode was 3 dB lower than the limit specified, then peak values of EUT will be reported, otherwise, the emissions will be repeated one by one using the CISPR quasi-peak method and reported.
7. For testing above 1GHz, the emission level of the EUT in peak mode was 20dB lower than average limit (that means the emission level in average mode also complies with the limit in average mode), then peak values of EUT will be reported, otherwise, the emissions will be measured in average mode again and reported.
8. Use the following spectrum analyzer settings:
 - (1) Span shall wide enough to fully capture the emission being measured;
 - (2) Set RBW=100 kHz for $f < 1$ GHz; VBW \geq RBW; Sweep = auto; Detector function = peak; Trace = max hold;
 - (3) Set RBW = 1 MHz, VBW= 3MHz for $f \geq 1$ GHz for peak measurement.
For average measurement:
 - VBW = 10 Hz, when duty cycle is no less than 98 percent.
 - VBW $\geq 1/T$, when duty cycle is less than 98 percent where T is the minimum transmission duration over which the transmitter is on and is transmitting at its maximum power control level for the tested mode of operation.

3.5.4 Test Setup

For radiated emissions below 30MHz

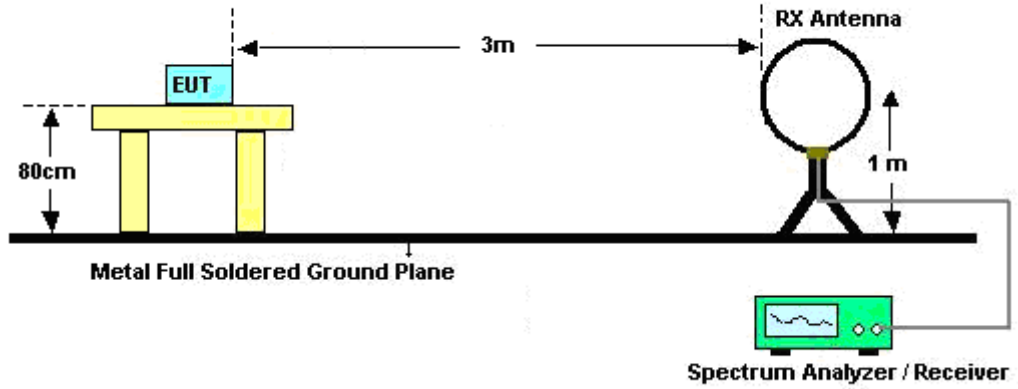

For radiated emissions from 30MHz to 1GHz

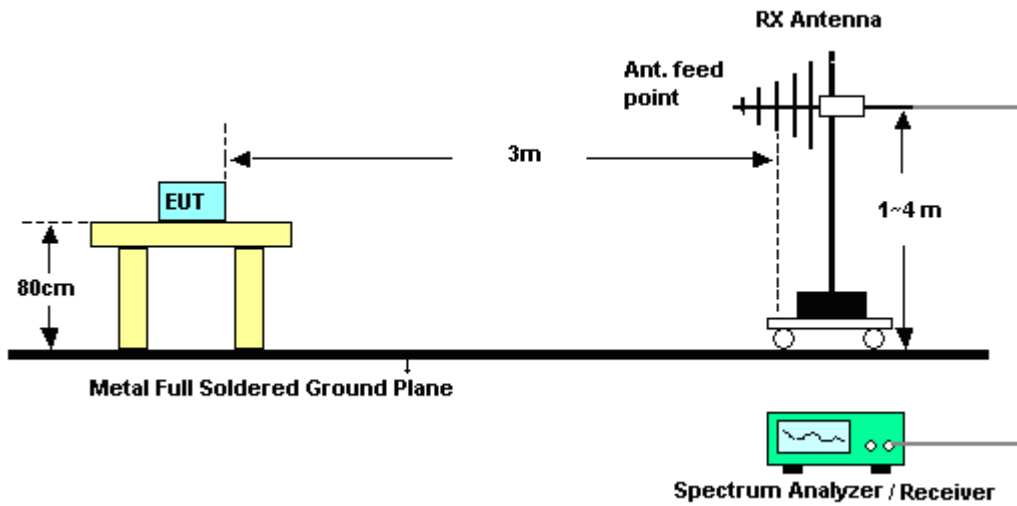

For radiated emissions above 1GHz

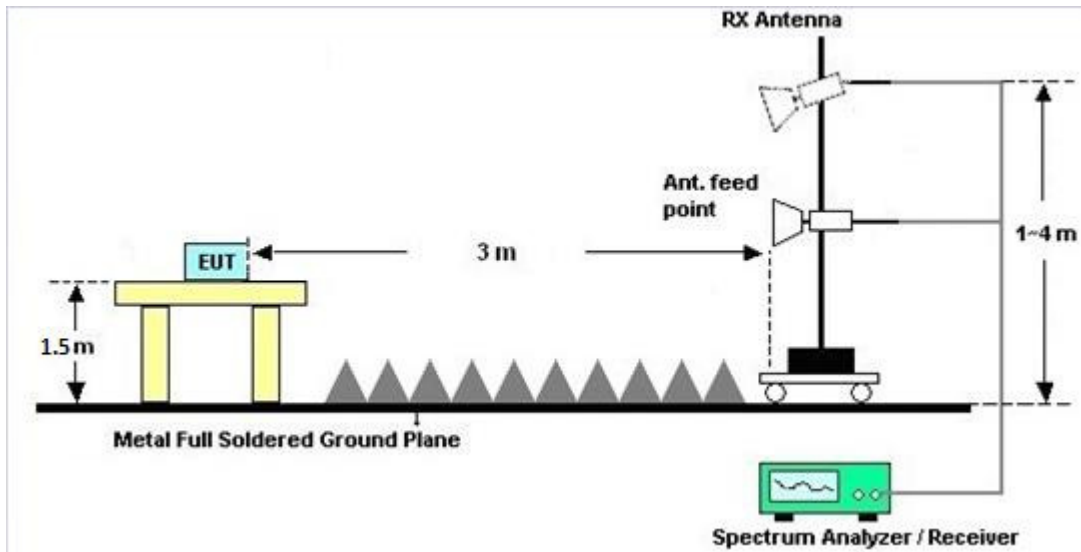

3.5.5 Test Results of Radiated Spurious Emissions (9 kHz ~ 30 MHz)

The low frequency, which started from 9 kHz to 30MHz, was pre-scanned and the result which was 20dB lower than the limit line was not reported.

3.5.6 Test Result of Radiated Spurious at Band Edges

Please refer to Appendix B and C.

3.5.7 Duty Cycle

Please refer to Appendix D.

3.5.8 Test Result of Radiated Spurious Emission (30MHz ~ 10th Harmonic)

Please refer to Appendix B and C.



3.6 AC Conducted Emission Measurement

3.6.1 Limit of AC Conducted Emission

For equipment that is designed to be connected to the public utility (AC) power line, the radio frequency voltage that is conducted back onto the AC power line on any frequency or frequencies within the band 150 kHz to 30 MHz shall not exceed the limits in the following table.

Frequency of emission (MHz)	Conducted limit (dBµV)	
	Quasi-peak	Average
0.15-0.5	66 to 56*	56 to 46*
0.5-5	56	46
5-30	60	50

*Decreases with the logarithm of the frequency.

3.6.2 Measuring Instruments

The section 4.0 of List of Measuring Equipment of this test report is used for test.

3.6.3 Test Procedures

1. The EUT was placed 0.4 meter from the conducting wall of the shielding room was kept at least 80 centimeters from any other grounded conducting surface.
2. Connect EUT to the power mains through a line impedance stabilization network (LISN).
3. All the support units are connecting to the other LISN.
4. The LISN provides 50 ohm coupling impedance for the measuring instrument.
5. The FCC states that a 50 ohm, 50 microhenry LISN should be used.
6. Both sides of AC line were checked for maximum conducted interference.
7. The frequency range from 150 kHz to 30 MHz was searched.
8. Set the test-receiver system to Peak Detect Function and specified bandwidth (IF Bandwidth = 9kHz) with Maximum Hold Mode. Then measurement is also conducted by Average Detector and Quasi-Peak Detector Function respectively.

3.6.4 Test Setup

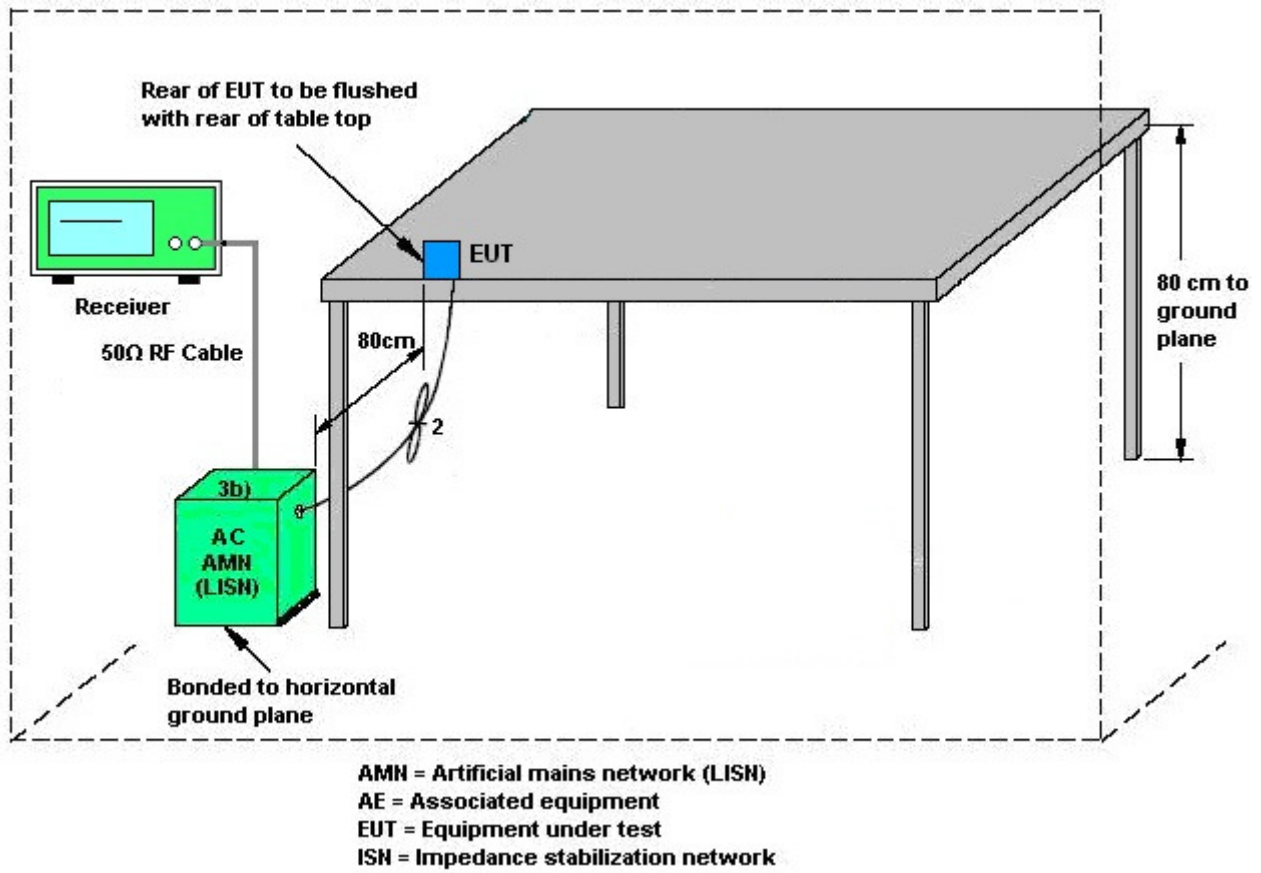

3.6.5 Test Result of AC Conducted Emission

Please refer to Appendix A.



3.7 Antenna Requirements

3.7.1 Standard Applicable

If directional gain of transmitting antennas is greater than 6dBi, the power shall be reduced by the same level in dB comparing to gain minus 6dBi. The use of a permanently attached antenna or of an antenna that uses a unique coupling to the intentional radiator shall be considered sufficient to comply with the rule.

3.7.2 Antenna Anti-Replacement Construction

An embedded-in antenna design is used.

3.7.3 Antenna Gain

The antenna peak gain of EUT is less than 6 dBi. Therefore, it is not necessary to reduce maximum peak output power limit.



4 List of Measuring Equipment

Instrument	Manufacturer	Model No.	Serial No.	Characteristics	Calibration Date	Test Date	Due Date	Remark
Power Meter	Agilent	E4416A	GB412923 44	300MHz~40GHz	Dec. 26, 2016	Mar. 24, 2017 ~ Apr. 12, 2017	Dec. 25, 2017	Conducted (TH05-HY)
Power Sensor	Agilent	E9327A	US404415 48	300MHz~40GHz	Dec. 26, 2016	Mar. 24, 2017 ~ Apr. 12, 2017	Dec. 25, 2017	Conducted (TH05-HY)
Spectrum Analyzer	Rohde & Schwarz	FSP40	100055	9kHz-40GHz	Jul. 17, 2016	Mar. 24, 2017 ~ Apr. 12, 2017	Jul. 16, 2017	Conducted (TH05-HY)
AC Power Source	ChainTek	APC-1000W	N/A	N/A	N/A	Apr. 02, 2017	N/A	Conduction (CO05-HY)
EMI Test Receiver	Rohde & Schwarz	ESCI 7	100724	9kHz~7GHz	Aug. 30, 2016	Apr. 02, 2017	Aug. 29, 2017	Conduction (CO05-HY)
LISN	Rohde & Schwarz	ENV216	100080	9kHz~30MHz	Nov. 29, 2016	Apr. 02, 2017	Nov. 28, 2017	Conduction (CO05-HY)
LISN	Rohde & Schwarz	ENV216	100081	9kHz~30MHz	Dec. 06, 2016	Apr. 02, 2017	Dec. 05, 2017	Conduction (CO05-HY)
Bilog Antenna	TESEQ	CBL 6111D&00800 N1D01N-06	35419&03	30MHz to 1GHz	Jan. 07, 2017	Mar. 30, 2017~ Apr. 02, 2017	Jan. 06, 2018	Radiation (03CH07-HY)
Double Ridge Horn Antenna	ESCO	3117	00075962	1GHz ~ 18GHz	Aug. 19, 2016	Mar. 30, 2017~ Apr. 02, 2017	Aug. 18, 2017	Radiation (03CH07-HY)
Loop Antenna	Rohde & Schwarz	HFH2-Z2	100315	9 kHz~30 MHz	Sep. 02, 2015	Mar. 30, 2017~ Apr. 02, 2017	Sep. 01, 2017	Radiation (03CH07-HY)
Preamplifier	MITEQ	AMF-7D-00101 800-30-10P	1590075	1GHz ~ 18GHz	Apr. 15, 2016	Mar. 30, 2017~ Apr. 02, 2017	Apr. 14, 2017	Radiation (03CH07-HY)
Preamplifier	COM-POWER	PA-103A	161241	10MHz-1GHz	Mar. 14, 2017	Mar. 30, 2017~ Apr. 02, 2017	Mar. 13, 2018	Radiation (03CH07-HY)
Preamplifier	Agilent	8449B	3008A023 62	1GHz~ 26.5GHz	Oct. 12, 2016	Mar. 30, 2017~ Apr. 02, 2017	Oct. 11, 2017	Radiation (03CH07-HY)
EMI Test Receiver	Agilent	N9038A(MXE)	MY532900 53	20Hz to 26.5GHz	Jan. 12, 2017	Mar. 30, 2017~ Apr. 02, 2017	Jan. 11, 2018	Radiation (03CH07-HY)
Antenna Mast	Max-Full	MFA520BS	N/A	1m~4m	N/A	Mar. 30, 2017~ Apr. 02, 2017	N/A	Radiation (03CH07-HY)
Turn Table	ChainTek	Chaintek 3000	N/A	0~360 Degree	N/A	Mar. 30, 2017~ Apr. 02, 2017	N/A	Radiation (03CH07-HY)
Preamplifier	MITEQ	JS44-1800400 0-33-8P	1840917	18GHz ~ 40GHz	Jun. 14, 2016	Mar. 30, 2017~ Apr. 02, 2017	Jun. 13, 2017	Radiation (03CH07-HY)
SHF-EHF Horn Antenna	SCHWARZBE CK	BBHA 9170	BBHA9170 584	18GHz- 40GHz	Nov. 08, 2016	Mar. 30, 2017~ Apr. 02, 2017	Nov. 07, 2017	Radiation (03CH07-HY)



5 Uncertainty of Evaluation

Uncertainty of Conducted Emission Measurement (150 kHz ~ 30 MHz)

Measuring Uncertainty for a Level of Confidence of 95% ($U = 2Uc(y)$)	2.70
---	------

Uncertainty of Radiated Emission Measurement (30 MHz ~ 1000 MHz)

Measuring Uncertainty for a Level of Confidence of 95% ($U = 2Uc(y)$)	5.70
---	------

Uncertainty of Radiated Emission Measurement (1000 MHz ~ 18000 MHz)

Measuring Uncertainty for a Level of Confidence of 95% ($U = 2Uc(y)$)	5.50
---	------

Uncertainty of Radiated Emission Measurement (18000 MHz ~ 40000 MHz)

Measuring Uncertainty for a Level of Confidence of 95% ($U = 2Uc(y)$)	5.20
---	------



Appendix A. AC Conducted Emission Test Results

Test Engineer :	Kai-Chun Chu	Temperature :	22~23°C
		Relative Humidity :	53~54%

EUT Information

Report NO : 720923
 Test Mode : Mode 1
 Test Voltage : 120Vac/60Hz
 Phase : Line

ENV216 Auto Test-L

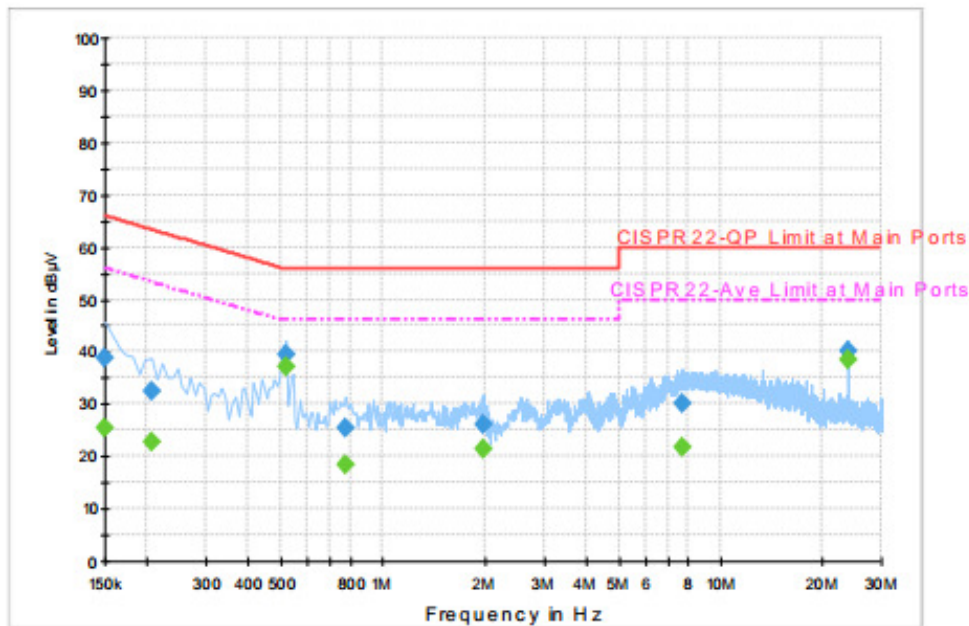

Final Result 1

Frequency (MHz)	QuasiPeak (dBµV)	Filter	Line	Corr. (dB)	Margin (dB)	Limit (dBµV)
0.150000	38.7	Off	L1	19.6	27.3	66.0
0.206000	32.4	Off	L1	19.5	31.0	63.4
0.518000	39.4	Off	L1	19.5	16.6	56.0
0.774000	25.3	Off	L1	19.5	30.7	56.0
1.990000	26.0	Off	L1	19.6	30.0	56.0
7.726000	30.0	Off	L1	19.6	30.0	60.0
23.886000	40.3	Off	L1	19.8	19.7	60.0

Final Result 2

Frequency (MHz)	Average (dBµV)	Filter	Line	Corr. (dB)	Margin (dB)	Limit (dBµV)
0.150000	25.5	Off	L1	19.6	30.5	56.0
0.206000	22.8	Off	L1	19.5	30.6	53.4
0.518000	37.1	Off	L1	19.5	8.9	46.0
0.774000	18.6	Off	L1	19.5	27.4	46.0
1.990000	21.4	Off	L1	19.6	24.6	46.0
7.726000	21.7	Off	L1	19.6	28.3	50.0
23.886000	38.3	Off	L1	19.8	11.7	50.0



EUT Information

Report NO : 720923
 Test Mode : Mode 1
 Test Voltage : 120Vac/60Hz
 Phase : Neutral

ENV216 Auto Test-N

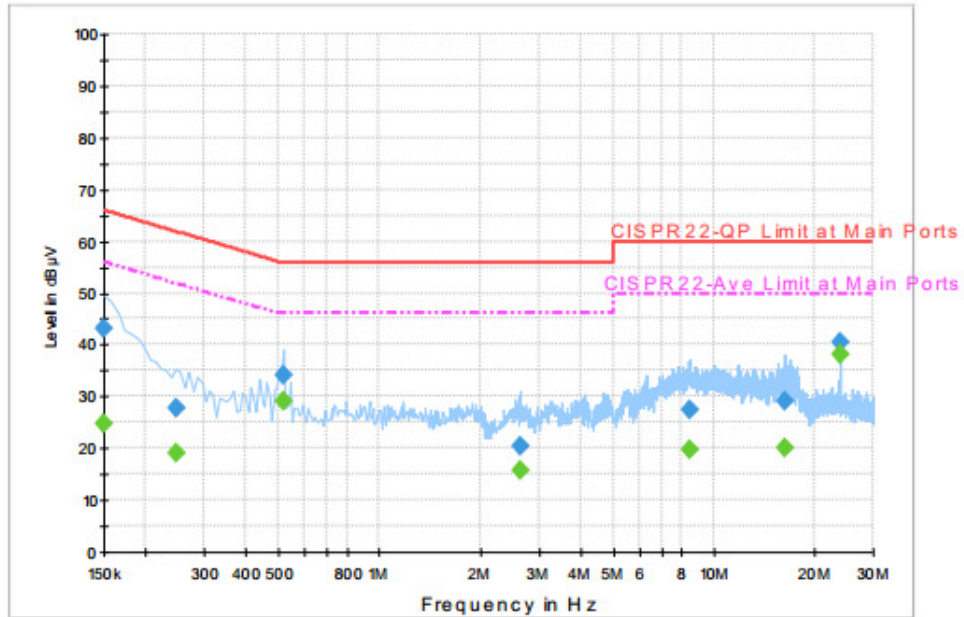

Final Result 1

Frequency (MHz)	QuasiPeak (dBµV)	Filter	Line	Corr. (dB)	Margin (dB)	Limit (dBµV)
0.150000	43.1	Off	N	19.5	22.9	66.0
0.246000	27.8	Off	N	19.5	34.1	61.9
0.518000	34.1	Off	N	19.5	21.9	56.0
2.630000	20.4	Off	N	19.3	35.6	56.0
8.454000	27.4	Off	N	19.7	32.6	60.0
16.390000	29.1	Off	N	19.8	30.9	60.0
23.886000	40.4	Off	N	19.9	19.6	60.0

Final Result 2

Frequency (MHz)	Average (dBµV)	Filter	Line	Corr. (dB)	Margin (dB)	Limit (dBµV)
0.150000	24.9	Off	N	19.5	31.1	56.0
0.246000	19.1	Off	N	19.5	32.8	51.9
0.518000	29.2	Off	N	19.5	16.8	46.0
2.630000	15.8	Off	N	19.3	30.2	46.0
8.454000	19.9	Off	N	19.7	30.1	50.0
16.390000	20.2	Off	N	19.8	29.8	50.0
23.886000	38.0	Off	N	19.9	12.0	50.0



Appendix B. Radiated Spurious Emission

Test Engineer :	Jesse Wang and James Chiu	Temperature :	21~24°C
		Relative Humidity :	50~53%

2.4GHz 2400~2483.5MHz

BLE (Band Edge @ 3m)

BLE	Note	Frequency (MHz)	Level (dBμV/m)	Over Limit (dB)	Limit Line (dBμV/m)	Read Level (dBμV)	Antenna Factor (dB/m)	Cable Loss (dB)	Preamp Factor (dB)	Ant Pos (cm)	Table Pos (deg)	Peak Avg. (P/A)	Pol. (H/V)	
BLE CH 00 2402MHz		2360.82	54.73	-19.27	74	49.35	32.09	8.26	34.97	311	55	P	H	
		2385.495	45.86	-8.14	54	40.45	32.14	8.24	34.97	311	55	A	H	
	*	2402	99.1	-	-	93.65	32.19	8.24	34.98	311	55	P	H	
	*	2402	98.9	-	-	93.45	32.19	8.24	34.98	311	55	A	H	
													H	
														H
			2388.225	55.31	-18.69	74	49.85	32.19	8.24	34.97	368	351	P	V
			2386.65	45.93	-8.07	54	40.47	32.19	8.24	34.97	368	351	A	V
	*		2402	98.28	-	-	92.83	32.19	8.24	34.98	368	351	P	V
	*		2402	97.6	-	-	92.15	32.19	8.24	34.98	368	351	A	V
														V
														V
BLE CH 19 2440MHz		2323.02	55.86	-18.14	74	50.56	31.98	8.28	34.96	305	58	P	H	
		2386.72	45.85	-8.15	54	40.39	32.19	8.24	34.97	305	58	A	H	
	*	2440	99.01	-	-	93.39	32.34	8.27	34.99	305	58	P	H	
	*	2440	98.08	-	-	92.46	32.34	8.27	34.99	305	58	A	H	
			2494.96	54.8	-19.2	74	49.01	32.5	8.3	35.01	305	58	P	H
			2487.26	46.08	-7.92	54	40.33	32.45	8.3	35	305	58	A	H
			2387.98	54.82	-19.18	74	49.36	32.19	8.24	34.97	304	353	P	V
			2320.92	45.88	-8.12	54	40.58	31.98	8.28	34.96	304	353	A	V
	*		2440	98.32	-	-	92.7	32.34	8.27	34.99	304	353	P	V
	*		2440	98.06	-	-	92.44	32.34	8.27	34.99	304	353	A	V
			2490.27	55.28	-18.72	74	49.48	32.5	8.3	35	304	353	P	V
			2498.6	46.27	-7.73	54	40.48	32.5	8.3	35.01	304	353	A	V



BLE CH 39 2480MHz	*	2480	99.96	-	-	94.21	32.45	8.3	35	293	57	P	H
	*	2480	99.71	-	-	93.96	32.45	8.3	35	293	57	A	H
		2488.12	56.11	-17.89	74	50.31	32.5	8.3	35	293	57	P	H
		2493.92	46.37	-7.63	54	40.58	32.5	8.3	35.01	293	57	A	H
													H
													H
	*	2480	99.11	-	-	93.36	32.45	8.3	35	380	352	P	V
	*	2480	98.85	-	-	93.1	32.45	8.3	35	380	352	A	V
		2490.92	55.16	-18.84	74	49.36	32.5	8.3	35	380	352	P	V
		2493.92	46.29	-7.71	54	40.5	32.5	8.3	35.01	380	352	A	V
													V
													V
Remark	1. No other spurious found. 2. All results are PASS against Peak and Average limit line.												



**2.4GHz 2400~2483.5MHz
BLE (Harmonic @ 3m)**

BLE	Note	Frequency (MHz)	Level (dBμV/m)	Over Limit (dB)	Limit Line (dBμV/m)	Read Level (dBμV)	Antenna Factor (dB/m)	Cable Loss (dB)	Preamp Factor (dB)	Ant Pos (cm)	Table Pos (deg)	Peak Avg. (P/A)	Pol. (H/V)	
BLE CH 00 2402MHz		4804	42.92	-31.08	74	56.36	33.68	11.96	59.08	100	0	P	H	
													H	
													H	
													H	
			4804	42.04	-31.96	74	55.48	33.68	11.96	59.08	100	0	P	V
														V
														V
BLE CH 19 2440MHz		4880	48.13	-25.87	74	61.63	33.54	11.9	58.94	100	0	P	H	
		7320	47.18	-26.82	74	55.55	34.65	14.94	57.96	100	0	P	H	
													H	
													H	
			4880	45.53	-28.47	74	59.03	33.54	11.9	58.94	100	0	P	V
			7320	49.05	-24.95	74	57.42	34.65	14.94	57.96	100	0	P	V
														V
BLE CH 39 2480MHz		4960	49.57	-24.43	74	63.13	33.37	11.84	58.77	100	0	P	H	
		7440	47.68	-26.32	74	56.38	34.33	15.1	58.13	100	0	P	H	
													H	
													H	
			4960	48.51	-25.49	74	62.07	33.37	11.84	58.77	100	0	P	V
			7440	49.75	-24.25	74	58.45	34.33	15.1	58.13	100	0	P	V
														V
Remark	1. No other spurious found. 2. All results are PASS against Peak and Average limit line.													



Emission below 1GHz

2.4GHz BLE (LF)

BLE	Note	Frequency	Level	Over	Limit	Read	Antenna	Cable	Preamp	Ant	Table	Peak	Pol.	
		(MHz)	(dBμV/m)	(dB)	(dBμV/m)	(dBμV)	(dB/m)	(dB)	(dB)	(cm)	(deg)	(P/A)	(H/V)	
2.4GHz BLE LF		30.27	27.25	-12.75	40	30.89	26	1.71	31.35			P	H	
		106.14	21.3	-22.2	43.5	33.57	16.94	2.34	31.55			P	H	
		252.21	32.65	-13.35	46	41.79	19.2	3.03	31.37			P	H	
		336.4	29.19	-16.81	46	36.18	20.82	3.43	31.24			P	H	
		379.1	29.24	-16.76	46	34.93	21.91	3.57	31.17			P	H	
		420.4	33.98	-12.02	46	38.52	22.68	3.88	31.1	100	59	P	H	
													H	
													H	
													H	
													H	
													H	
													H	
			31.89	28.13	-11.87	40	32.88	24.92	1.71	31.38	100	172	P	V
			139.89	24.67	-18.83	43.5	35.85	18	2.34	31.52			P	V
			252.21	30.41	-15.59	46	39.55	19.2	3.03	31.37			P	V
			420.4	29.3	-16.7	46	33.84	22.68	3.88	31.1			P	V
			588.4	34.49	-11.51	46	35.73	25.22	4.39	30.85			P	V
			929.3	34.08	-11.92	46	29.56	29.71	5.33	30.52			P	V
													V	
													V	
												V		
												V		
												V		
												V		
Remark	1. No other spurious found. 2. All results are PASS against limit line.													



Note symbol

*	Fundamental Frequency which can be ignored. However, the level of any unwanted emissions shall not exceed the level of the fundamental frequency.
!	Test result is over limit line.
P/A	Peak or Average
H/V	Horizontal or Vertical



A calculation example for radiated spurious emission is shown as below:

WIFI	Note	Frequency	Level	Over	Limit	Read	Antenna	Cable	Preamp	Ant	Table	Peak	Pol.
Ant.				Limit	Line	Level	Factor	Loss	Factor	Pos	Pos	Avg.	
1+2		(MHz)	(dBμV/m)	(dB)	(dBμV/m)	(dBμV)	(dB/m)	(dB)	(dB)	(cm)	(deg)	(P/A)	(H/V)
802.11b		2390	55.45	-18.55	74	54.51	32.22	4.58	35.86	103	308	P	H
CH 01													
2412MHz		2390	43.54	-10.46	54	42.6	32.22	4.58	35.86	103	308	A	H

- Level(dBμV/m) =
Antenna Factor(dB/m) + Cable Loss(dB) + Read Level(dBμV) - Preamp Factor(dB)
- Over Limit(dB) = Level(dBμV/m) – Limit Line(dBμV/m)

For Peak Limit @ 2390MHz:

- Level(dBμV/m)
= Antenna Factor(dB/m) + Cable Loss(dB) + Read Level(dBμV) - Preamp Factor(dB)
= 32.22(dB/m) + 4.58(dB) + 54.51(dBμV) – 35.86 (dB)
= 55.45 (dBμV/m)
- Over Limit(dB)
= Level(dBμV/m) – Limit Line(dBμV/m)
= 55.45(dBμV/m) – 74(dBμV/m)
= -18.55(dB)

For Average Limit @ 2390MHz:

- Level(dBμV/m)
= Antenna Factor(dB/m) + Cable Loss(dB) + Read Level(dBμV) - Preamp Factor(dB)
= 32.22(dB/m) + 4.58(dB) + 42.6(dBμV) – 35.86 (dB)
= 43.54 (dBμV/m)
- Over Limit(dB)
= Level(dBμV/m) – Limit Line(dBμV/m)
= 43.54(dBμV/m) – 54(dBμV/m)
= -10.46(dB)

Both peak and average measured complies with the limit line, so test result is “PASS”.



Appendix C. Radiated Spurious Emission Plots

Test Engineer :	Jesse Wang and James Chiu	Temperature :	21~24°C
		Relative Humidity :	50~53%

Note symbol

-L	Low channel location
-R	High channel location



2.4GHz 2400~2483.5MHz

BLE (Band Edge @ 3m)

BLE	2.4GHz 2400~2483.5MHz Band Edge @ 3m	
ANT	BLE CH00 2402MHz	
1	Horizontal	Fundamental
Peak	<p>Site Condition : 03CH07-HY : PEAK_BE_74 3m HF-ANT_130829 HORIZONTAL : RBW:1000.000kHz VBW:3000.000kHz SWT:Auto</p>	<p>Site Condition : 03CH07-HY : PEAK_74 3m HF-ANT_130829 HORIZONTAL : RBW:1000.000kHz VBW:3000.000kHz SWT:Auto</p>
Avg.	<p>Site Condition : 03CH07-HY : AVG_BE_54 3m HF-ANT_130829 HORIZONTAL : RBW:1000.000kHz VBW:3.000kHz SWT:Auto</p>	<p>Site Condition : 03CH07-HY : AVG_54 3m HF-ANT_130829 HORIZONTAL : RBW:1000.000kHz VBW:3.000kHz SWT:Auto</p>



BLE	2.4GHz 2400~2483.5MHz Band Edge @ 3m	
ANT	BLE CH00 2402MHz	
1	Vertical	Fundamental
Peak	<p>Site Condition : 03CH07-HY : PEAK_BE_74 3m HF ANT_130829 VERTICAL : RBW:1000.000kHz VBW:3000.000kHz SWT:Auto</p>	<p>Site Condition : 03CH07-HY : PEAK_74 3m HF ANT_130829 VERTICAL : RBW:1000.000kHz VBW:3000.000kHz SWT:Auto</p>
Avg	<p>Site Condition : 03CH07-HY : AVG_BE_54 3m HF ANT_130829 VERTICAL : RBW:1000.000kHz VBW:3.000kHz SWT:Auto</p>	<p>Site Condition : 03CH07-HY : AVG_54 3m HF ANT_130829 VERTICAL : RBW:1000.000kHz VBW:3.000kHz SWT:Auto</p>



BLE	2.4GHz 2400~2483.5MHz Band Edge @ 3m	
ANT	BLE CH19 2440MHz - L	
1	Horizontal	Fundamental
Peak	<p>Site Condition : 03CH07-HY PEAK_BE_74 3m HF-ANT_130829 HORIZONTAL RDW:1000.000kHz VSW:3.000kHz SWT:Auto</p>	<p>Site Condition : 03CH07-HY PEAK_74 3m HF-ANT_130829 HORIZONTAL RDW:1000.000kHz VSW:3.000kHz SWT:Auto</p>
Avg.	<p>Site Condition : 03CH07-HY AVG_BE_54 3m HF-ANT_130829 HORIZONTAL RDW:1000.000kHz VSW:3.000kHz SWT:Auto</p>	<p>Site Condition : 03CH07-HY AVG_54 3m HF-ANT_130829 HORIZONTAL RDW:1000.000kHz VSW:3.000kHz SWT:Auto</p>



BLE	2.4GHz 2400~2483.5MHz Band Edge @ 3m	
ANT	BLE CH19 2440MHz - R	
1	Horizontal	Fundamental
<p>Peak</p>	<p>Site : 03CH07-HY Condition : PEAK_BE_74 3m HF ANT_130829 HORIZONTAL : RBW:1000.000kHz VBW:3000.000kHz SWT:Auto</p>	<p>Left blank</p>
<p>Avg.</p>	<p>Site : 03CH07-HY Condition : AVG_BE_54 3m HF ANT_130829 HORIZONTAL : RBW:1000.000kHz VBW:3.000kHz SWT:Auto</p>	<p>Left blank</p>



BLE	2.4GHz 2400~2483.5MHz Band Edge @ 3m	
ANT	BLE CH19 2440MHz - L	
1	Vertical	Fundamental
Peak	<p>Site Condition : 03CH07-HY : PEAK_BE_74 3m HF ANT_130829 VERTICAL : RBW:1000.000kHz VBW:3000.000kHz SWT:Auto</p>	<p>Site Condition : 03CH07-HY : PEAK_74 3m HF ANT_130829 VERTICAL : RBW:1000.000kHz VBW:3000.000kHz SWT:Auto</p>
Avg.	<p>Site Condition : 03CH07-HY : AVG_BE_54 3m HF ANT_130829 VERTICAL : RBW:1000.000kHz VBW:3.000kHz SWT:Auto</p>	<p>Site Condition : 03CH07-HY : AVG_54 3m HF ANT_130829 VERTICAL : RBW:1000.000kHz VBW:3.000kHz SWT:Auto</p>

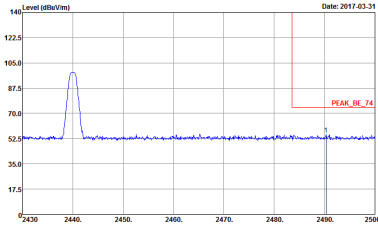
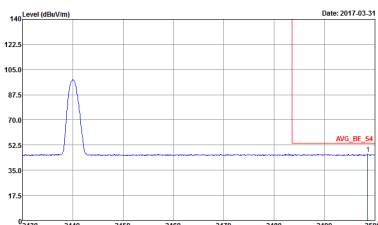

BLE	2.4GHz 2400~2483.5MHz Band Edge @ 3m	
ANT	BLE CH19 2440MHz - R	
1	Vertical	Fundamental
<p>Peak</p>	 <p>Site : 03CH07-HY Condition : PEAK_BE_74 3m HF ANT_130829 VERTICAL : RBW:1000.000kHz VBW:3.000kHz SVT:Auto</p>	<p>Left blank</p>
<p>Avg.</p>	 <p>Site : 03CH07-HY Condition : AVG_BE_54 3m HF ANT_130829 VERTICAL : RBW:1000.000kHz VBW:3.000kHz SVT:Auto</p>	<p>Left blank</p>



BLE	2.4GHz 2400~2483.5MHz Band Edge @ 3m	
ANT	BLE CH39 2480MHz	
1	Horizontal	Fundamental
<p>Peak</p>	<p>Site Condition : 03CH07-HY : PEAK_BE_74 3m HF ANT 130829 HORIZONTAL : RBW:1000.000kHz VBW:3000.000kHz SWT:Auto</p>	<p>Site Condition : 03CH07-HY : PEAK_74 3m HF ANT 130829 HORIZONTAL : RBW:1000.000kHz VBW:3000.000kHz SWT:Auto</p>
<p>Avg.</p>	<p>Site Condition : 03CH07-HY : AVG_BE_54 3m HF ANT 130829 HORIZONTAL : RBW:1000.000kHz VBW:3.000kHz SWT:Auto</p>	<p>Site Condition : 03CH07-HY : AVG_54 3m HF ANT 130829 HORIZONTAL : RBW:1000.000kHz VBW:3.000kHz SWT:Auto</p>



BLE	2.4GHz 2400~2483.5MHz Band Edge @ 3m	
ANT	BLE CH39 2480MHz	
1	Vertical	Fundamental
Peak	<p>Site Condition : 03CH07-HY : PEAK_BE_74 3m HF ANT_130829 VERTICAL : RBW:1000.000kHz VBW:3000.000kHz SWT:Auto</p>	<p>Site Condition : 03CH07-HY : PEAK_74 3m HF ANT_130829 VERTICAL : RBW:1000.000kHz VBW:3000.000kHz SWT:Auto</p>
Avg.	<p>Site Condition : 03CH07-HY : AVG_BE_54 3m HF ANT_130829 VERTICAL : RBW:1000.000kHz VBW:3.000kHz SWT:Auto</p>	<p>Site Condition : 03CH07-HY : AVG_54 3m HF ANT_130829 VERTICAL : RBW:1000.000kHz VBW:3.000kHz SWT:Auto</p>



2.4GHz 2400~2483.5MHz
BLE (Harmonic @ 3m)

BLE	2.4GHz 2400~2483.5MHz Harmonic @ 3m	
ANT	BLE CH00 2402MHz	
1	Horizontal	Vertical
<p>Peak Avg.</p>	<p>Site : 03CH07-HY Condition : PEAK_74 3m SHF-EHF_131029 HORIZONTAL Detector : Peak</p>	<p>Site : 03CH07-HY Condition : PEAK_74 3m HF-ANT_130829 VERTICAL Detector : Peak</p>



BLE	2.4GHz 2400~2483.5MHz Harmonic @ 3m	
ANT	BLE CH19 2440MHz	
1	Horizontal	Vertical
Peak Avg.	<p>Site : 03CH07-HY Condition : PEAK_74 3m SHF-EHF_131029 HORIZONTAL Detector : Peak</p>	<p>Site : 03CH07-HY Condition : PEAK_74 3m SHF-EHF_131029 VERTICAL Detector : Peak</p>



BLE	2.4GHz 2400~2483.5MHz Harmonic @ 3m	
ANT	BLE CH39 2480MHz	
1	Horizontal	Vertical
Peak	<p>Site : 03CH07-HY Condition : PEAK_74 3m SHF-EHF_131029 HORIZONTAL Detector : Peak</p>	<p>Site : 03CH07-HY Condition : PEAK_74 3m SHF-EHF_131029 VERTICAL Detector : Peak</p>



Emission below 1GHz
2.4GHz BLE (LF)

BLE	2.4GHz 2400~2483.5MHz	
ANT	BLE LF	
1	Horizontal	Vertical
QP / Peak	<p>Site : 03CH07-HY Condition : QP 3m LF-ANT:35419(6) HORIZONTAL Detector : Peak</p>	<p>Site : 03CH07-HY Condition : QP 3m LF-ANT:35419(6) VERTICAL Detector : Peak</p>

Appendix D. Duty Cycle Plots

Antenna	Band	Duty Cycle(%)	T(us)	1/T(kHz)	VBW Setting
1	Bluetooth -LE	64.97	408	2.450980392	3kHz

Bluetooth - LE

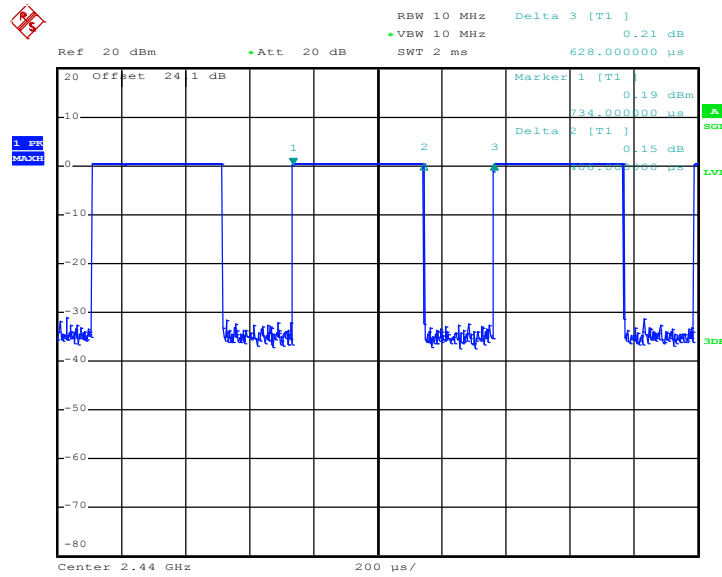

Date: 24.MAR.2017 21:56:28