



# FCC RADIO TEST REPORT

FCC ID : UZ7CC6000  
Equipment : Customer Concierge  
Brand Name : ZEBRA  
Model Name : CC6000  
Applicant : Zebra Technologies Corporation  
1 Zebra Plaza, Holtsville, NY 11742  
Manufacturer : Zebra Technologies Corporation  
1 Zebra Plaza, Holtsville, NY 11742  
Standard : FCC Part 15 Subpart C §15.247

The product was received on Jan. 11, 2019 and testing was started from Jan. 22, 2019 and completed on Feb. 20, 2019. We, SPORTON INTERNATIONAL INC. EMC & Wireless Communications Laboratory, would like to declare that the tested sample has been evaluated in accordance with the test procedures and has been in compliance with the applicable technical standards.

The report must not be used by the client to claim product certification, approval, or endorsement by TAF or any agency of government.

The test results in this report apply exclusively to the tested model / sample. Without written approval of SPORTON INTERNATIONAL INC. EMC & Wireless Communications Laboratory, the test report shall not be reproduced except in full.

Approved by: Jones Tsai

**SPORTON INTERNATIONAL INC. EMC & Wireless Communications Laboratory**

No. 52, Huaya 1st Rd., Guishan Dist., Taoyuan City, Taiwan (R.O.C.)



## Table of Contents

History of this test report .....	3
Summary of Test Result .....	4
<b>1 General Description .....</b>	<b>5</b>
1.1 Product Feature of Equipment Under Test .....	5
1.2 Product Specification of Equipment Under Test .....	6
1.3 Modification of EUT .....	6
1.4 Testing Location .....	6
1.5 Applicable Standards .....	7
<b>2 Test Configuration of Equipment Under Test .....</b>	<b>8</b>
2.1 Carrier Frequency Channel .....	8
2.2 Test Mode .....	9
2.3 Connection Diagram of Test System .....	11
2.4 Support Unit used in test configuration and system .....	12
2.5 EUT Operation Test Setup .....	12
2.6 Measurement Results Explanation Example .....	13
<b>3 Test Result .....</b>	<b>14</b>
3.1 6dB and 99% Bandwidth Measurement .....	14
3.2 Output Power Measurement .....	23
3.3 Power Spectral Density Measurement .....	24
3.4 Conducted Band Edges and Spurious Emission Measurement .....	32
3.5 Radiated Band Edges and Spurious Emission Measurement .....	41
3.6 AC Conducted Emission Measurement .....	45
3.7 Antenna Requirements .....	47
<b>4 List of Measuring Equipment .....</b>	<b>48</b>
<b>5 Uncertainty of Evaluation .....</b>	<b>50</b>
<b>Appendix A. AC Conducted Emission Test Result</b>	
<b>Appendix B. Radiated Spurious Emission</b>	
<b>Appendix C. Radiated Spurious Emission Plots</b>	
<b>Appendix D. Duty Cycle Plots</b>	
<b>Appendix E. Setup Photographs</b>	





## Summary of Test Result

Report Clause	Ref Std. Clause	Test Items	Result (PASS/FAIL)	Remark
3.1	15.247(a)(2)	6dB Bandwidth	Pass	-
3.1	2.1049	99% Occupied Bandwidth	Reporting only	-
3.2	15.247(b)(3)	Output Power	Pass	-
3.3	15.247(e)	Power Spectral Density	Pass	-
3.4	15.247(d)	Conducted Band Edges and Spurious Emission	Pass	-
3.5	15.247(d)	Radiated Band Edges and Spurious Emission	Pass	Under limit 3.92 dB at 118.830 MHz
3.6	15.207	AC Conducted Emission	Pass	Under limit 5.73 dB at 0.564 MHz
3.7	15.203 & 15.247(b)	Antenna Requirement	Pass	-

**Declaration of Conformity:**

The test results with all measurement uncertainty excluded are presented in accordance with the regulation limits or requirements declared by manufacturers.

**Comments and Explanations:**

The declared of product specification for EUT presented in the report are provided by the manufacturer, and the manufacturer takes all the responsibilities for the accuracy of product specification.

**Reviewed by: Wii Chang**

**Report Producer: Polly Tsai**



# 1 General Description

## 1.1 Product Feature of Equipment Under Test

Product Feature	
Equipment	Customer Concierge
Brand Name	ZEBRA
Model Name	CC6000
FCC ID	UZ7CC6000
EUT supports Radios application	NFC WLAN 11a/b/g/n HT20/HT40 WLAN 11ac VHT20/VHT40/VHT80 Bluetooth BR/EDR/LE
HW Version	DV
SW Version	01-15-05.00.OG-U00-PRD
FW Version	01-15-05.00.OG-U00-PRD
MFD	21DEC18
EUT Stage	Engineering Sample

Remark: The above EUT's information was declared by manufacturer.

### <Sample Information>

	Sample 1	Sample 2	Sample 3
Component Category	CC6000 Landscape Display with Camera	CC6000 Landscape Display, No Camera	CC6000 Portrait Display with Camera
Data capture options	SE4710	SE4710	SE4710
Camera	Front Facing ≥5 Mp	None	Front Facing ≥5 Mp

Supported Unit Used in Test Configuration and System				
AC Adaptor	Brand Name	ZEBRA	Part Number	PWR-BUA5V16W0WW
DC Cable	Brand Name	ZEBRA	Part Number	CBL-DC-383A1-01
AC Cable	Brand Name	ZEBRA	Part Number	50-16000-182R
POE	Brand Name	Microsemi	Part Number	PD-9501GR/AC



## 1.2 Product Specification of Equipment Under Test

Standards-related Product Specification	
<b>Tx/Rx Frequency Range</b>	2402 MHz ~ 2480 MHz
<b>Number of Channels</b>	40
<b>Carrier Frequency of Each Channel</b>	40 Channel(37 hopping + 3 advertising channel)
<b>Maximum Output Power to Antenna</b>	1.95 dBm (0.0016 W) for 1Mbps 1.85 dBm (0.0015 W) for 2Mbps
<b>99% Occupied Bandwidth</b>	1.030 MHz for 1Mbps 2.052 MHz for 2Mbps
<b>Antenna Type / Gain</b>	PIFA Antenna type with gain 3.86 dBi
<b>Type of Modulation</b>	Bluetooth LE : GFSK

## 1.3 Modification of EUT

No modifications are made to the EUT during all test items.

## 1.4 Testing Location

<b>Test Site</b>	SPORTON INTERNATIONAL INC.	
<b>Test Site Location</b>	No.52, Huaya 1st Rd., Guishan Dist., Taoyuan City, Taiwan (R.O.C.) TEL: +886-3-327-3456 FAX: +886-3-328-4978	
<b>Test Site No.</b>	<b>Sporton Site No.</b>	
	TH05-HY	CO05-HY

**Note:** The test site complies with ANSI C63.4 2014 requirement.

<b>Test Site</b>	SPORTON INTERNATIONAL INC.	
<b>Test Site Location</b>	No.58, Aly. 75, Ln. 564, Wenhua 3rd, Rd., Guishan Dist., Taoyuan City, Taiwan (R.O.C.) TEL: +886-3-327-0868 FAX: +886-3-327-0855	
<b>Test Site No.</b>	<b>Sporton Site No.</b>	
	03CH15-HY	

**Note:** The test site complies with ANSI C63.4 2014 requirement.

FCC Designation No.: TW1190 and TW0007



## **1.5 Applicable Standards**

According to the specifications of the manufacturer, the EUT must comply with the requirements of the following standards:

- ♦ FCC Part 15 Subpart C §15.247
- ♦ FCC KDB Publication No. 558074 D01 DTS Meas. Guidance v05
- ♦ FCC KDB 414788 D01 Radiated Test Site v01r01.
- ♦ ANSI C63.10-2013

**Remark:**

1. All test items were verified and recorded according to the standards and without any deviation during the test.
2. This EUT has also been tested and complied with the requirements of FCC Part 15, Subpart B, recorded in a separate test report.



## 2 Test Configuration of Equipment Under Test

### 2.1 Carrier Frequency Channel

Frequency Band	Channel	Freq. (MHz)	Channel	Freq. (MHz)
2400-2483.5 MHz	0	2402	21	2444
	1	2404	22	2446
	2	2406	23	2448
	3	2408	24	2450
	4	2410	25	2452
	5	2412	26	2454
	6	2414	27	2456
	7	2416	28	2458
	8	2418	29	2460
	9	2420	30	2462
	10	2422	31	2464
	11	2424	32	2466
	12	2426	33	2468
	13	2428	34	2470
	14	2430	35	2472
	15	2432	36	2474
	16	2434	37	2476
	17	2436	38	2478
	18	2438	39	2480
	19	2440	-	-
20	2442	-	-	



## 2.2 Test Mode

Channel	Frequency	Bluetooth – LE 1Mbps RF Average Output Power	
		Data Rate / Modulation	
		GFSK	
		1Mbps	
Ch00	2402MHz	1.85 dBm	
Ch19	2440MHz	1.95 dBm	
Ch39	2480MHz	1.55 dBm	

Channel	Frequency	Bluetooth – LE 2Mbps RF Average Output Power	
		Data Rate / Modulation	
		GFSK	
		2Mbps	
Ch00	2402MHz	1.75 dBm	
Ch19	2440MHz	1.85 dBm	
Ch39	2480MHz	1.45 dBm	

- a. The EUT has been associated with peripherals and configuration operated in a manner tended to maximize its emission characteristics in a typical application. Frequency range investigated: conduction emission (150 kHz to 30 MHz), radiation emission (9 kHz to the 10th harmonic of the highest fundamental frequency or to 40 GHz, whichever is lower). For radiated measurement, pre-scanned in three orthogonal panels, X, Y, Z. The worst cases (Y plane) were recorded in this report.
  
- b. AC power line Conducted Emission was tested under maximum output power.



The following summary table is showing all test modes to demonstrate in compliance with the standard.

Summary table of Test Cases	
Test Item	Data Rate / Modulation
	Bluetooth – LE / GFSK
<b>Conducted Test Cases</b>	Mode 1: Bluetooth Tx CH00_2402 MHz_1Mbps Mode 2: Bluetooth Tx CH19_2440 MHz_1Mbps Mode 3: Bluetooth Tx CH39_2480 MHz_1Mbps Mode 4: Bluetooth Tx CH00_2402 MHz_2Mbps Mode 5: Bluetooth Tx CH19_2440 MHz_2Mbps Mode 6: Bluetooth Tx CH39_2480 MHz_2Mbps
<b>Radiated Test Cases</b>	Mode 1: Bluetooth Tx CH00_2402 MHz_1Mbps Mode 2: Bluetooth Tx CH19_2440 MHz_1Mbps Mode 3: Bluetooth Tx CH39_2480 MHz_1Mbps Mode 4: Bluetooth Tx CH00_2402 MHz_2Mbps Mode 5: Bluetooth Tx CH19_2440 MHz_2Mbps Mode 6: Bluetooth Tx CH39_2480 MHz_2Mbps
<b>AC Conducted Emission</b>	Mode 1: Bluetooth Link + WLAN (2.4GHz) Link + Scanner + USB (3.1/Type C) Data Link with Notebook (Notebook to eMMC) + USB (2.0/Type A) USB Flash Disk Load + USB (2.0/Type A) USB Flash Disk Load + POE + LAN Load with AP + Headset for Sample 3
<b>Remark:</b> For Radiated Test Cases, the tests were performed with Sample 2.	

## 2.3 Connection Diagram of Test System

### <Bluetooth – LE Tx Mode>

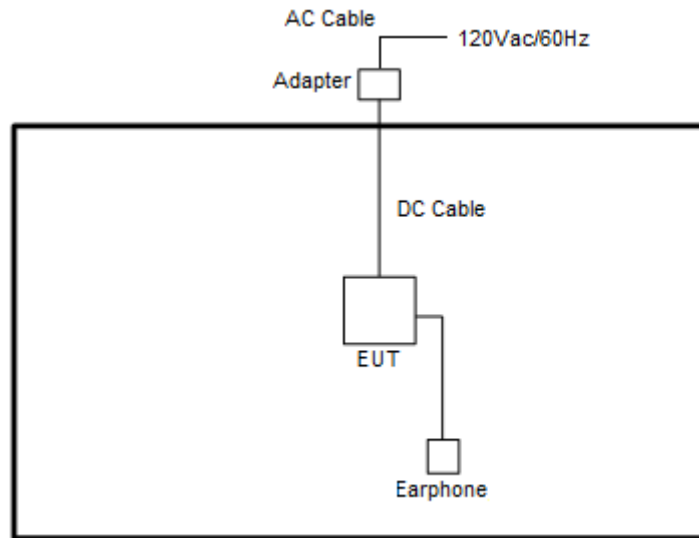

### <AC Conducted Emission Mode>

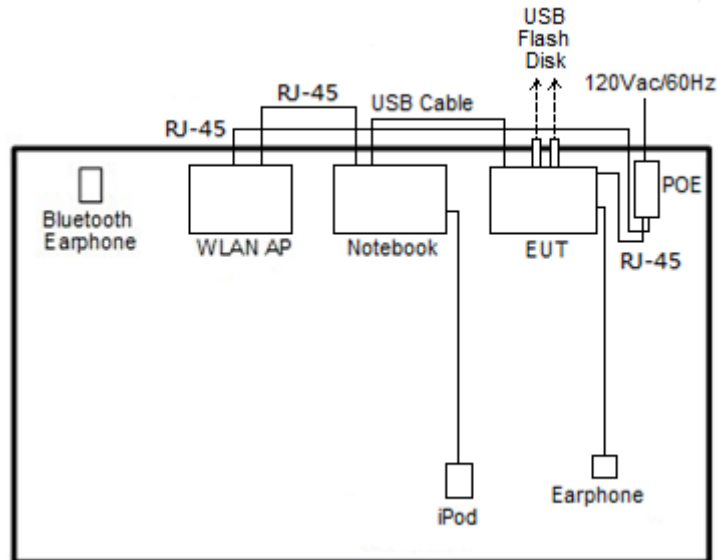



## 2.4 Support Unit used in test configuration and system

Item	Equipment	Trade Name	Model Name	FCC ID	Data Cable	Power Cord
1.	WLAN AP	ASUS	RT-AC66U	MSQ-RTAC66U	N/A	Unshielded, 1.8 m
2.	Bluetooth Earphone	Sony Ericsson	MW600	PY7DDA-2029	N/A	N/A
3.	iPod	Apple	A1285	FCC DoC	Shielded, 1.0 m	N/A
4.	iPod Earphone	Apple	N/A	Verification	Unshielded, 1.0 m	N/A
5.	Notebook	ASUS	P2430U	FCC DoC	N/A	AC I/P: Unshielded, 1.2 m DC O/P: Shielded, 1.8 m
6.	Notebook	DELL	Latitude E6320	FCC DoC/ Contains FCC ID: QDS-BRCM1054	N/A	AC I/P: Unshielded, 1.2 m DC O/P: Shielded, 1.8 m
7.	Notebook	Lenovo	L570	FCC DoC	N/A	AC I/P: Unshielded, 1.2 m DC O/P: Shielded, 1.8 m
8.	USB Flash Disk	TOSHIBA	TOSHIBA 32G	FCC DoC	N/A	N/A
9.	USB Flash Disk	SanDisk	Cruzer Glide 3.0 16G	FCC DoC	N/A	N/A
10.	SD Card	SanDisk	MicroSD HC	FCC DoC	N/A	N/A

## 2.5 EUT Operation Test Setup

The RF test items, utility “QRCT” was installed in Notebook which was programmed in order to make the EUT get into the engineering modes to provide channel selection, power level, data rate and the application type and for continuous transmitting signals.



## 2.6 Measurement Results Explanation Example

For all conducted test items:

The offset level is set in the spectrum analyzer to compensate the RF cable loss and attenuator factor between EUT conducted output port and spectrum analyzer. With the offset compensation, the spectrum analyzer reading level is exactly the EUT RF output level.

Example :

The spectrum analyzer offset is derived from RF cable loss and attenuator factor.

*Offset = RF cable loss + attenuator factor.*

Following shows an offset computation example with cable loss 4.2 dB and 10dB attenuator.

$$\begin{aligned} \text{Offset(dB)} &= \text{RF cable loss(dB)} + \text{attenuator factor(dB)}. \\ &= 4.2 + 10 = 14.2 \text{ (dB)} \end{aligned}$$

### 3 Test Result

#### 3.1 6dB and 99% Bandwidth Measurement

##### 3.1.1 Limit of 6dB and 99% Bandwidth

The minimum 6 dB bandwidth shall be at least 500 kHz.

##### 3.1.2 Measuring Instruments

See list of measuring equipment of this test report.

##### 3.1.3 Test Procedures

1. The testing follows the ANSI C63.10 Section 6.9.3 (OBW) and 11.8.1 (6dB BW).
2. The RF output of EUT was connected to the spectrum analyzer by RF cable and attenuator. The path loss was compensated to the results for each measurement.
3. Set to the maximum power setting and enable the EUT transmit continuously.
4. Make the measurement with the spectrum analyzer's resolution bandwidth (RBW) = 100 kHz. Set the Video bandwidth (VBW) = 300 kHz. In order to make an accurate measurement. The 6 dB bandwidth must be greater than 500 kHz.
5. For 99% Bandwidth Measurement, the spectrum analyzer's resolution bandwidth (RBW) is set 1-5% of the emission bandwidth and set the Video bandwidth (VBW)  $\geq 3 * RBW$ .
6. Measure and record the results in the test report.

##### 3.1.4 Test Setup

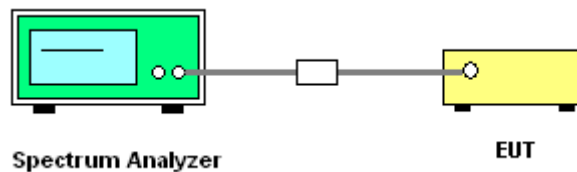



3.1.5 Test Result of 6dB Bandwidth

Test Engineer :	Luffy Lin and Allen Lin	Temperature :	21~25°C
		Relative Humidity :	51~54%

Mod.	Data Rate	NTX	CH.	Freq. (MHz)	6dB BW (MHz)	6dB BW Limit (MHz)	Pass/Fail
BLE	1Mbps	1	0	2402	0.662	0.50	Pass
BLE	1Mbps	1	19	2440	0.660	0.50	Pass
BLE	1Mbps	1	39	2480	0.662	0.50	Pass
BLE	2Mbps	1	0	2402	1.124	0.50	Pass
BLE	2Mbps	1	19	2440	1.144	0.50	Pass
BLE	2Mbps	1	39	2480	1.128	0.50	Pass

<1Mbps>

6 dB Bandwidth Plot on Channel 00

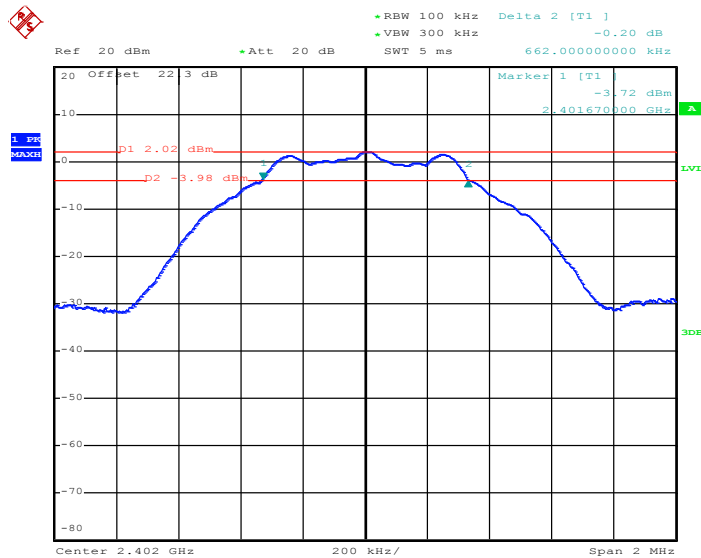

Date: 31.JAN.2019 15:02:05



6 dB Bandwidth Plot on Channel 19

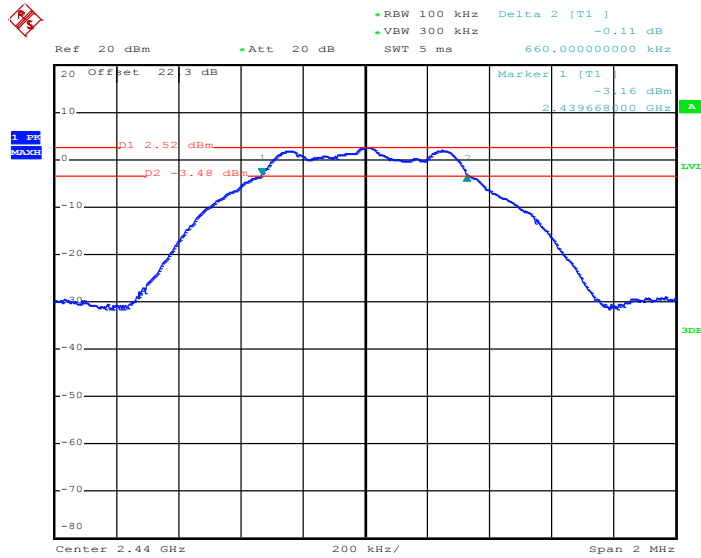

Date: 31.JAN.2019 15:06:51

6 dB Bandwidth Plot on Channel 39

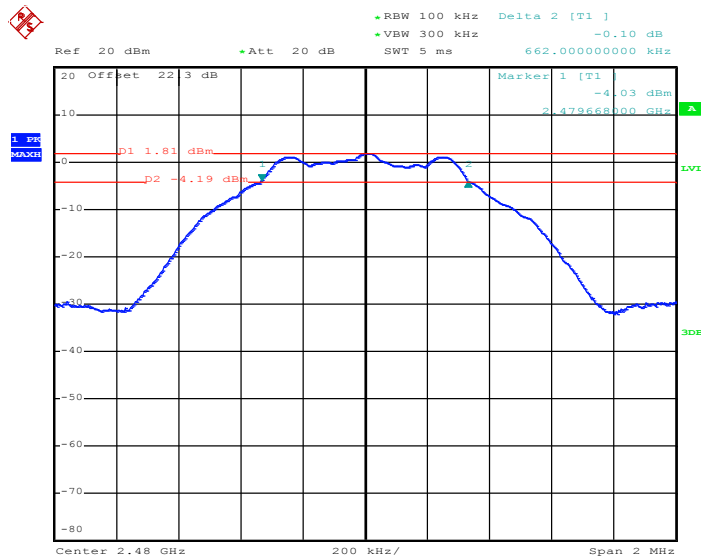

Date: 31.JAN.2019 15:11:11





<2Mbps>

6 dB Bandwidth Plot on Channel 00

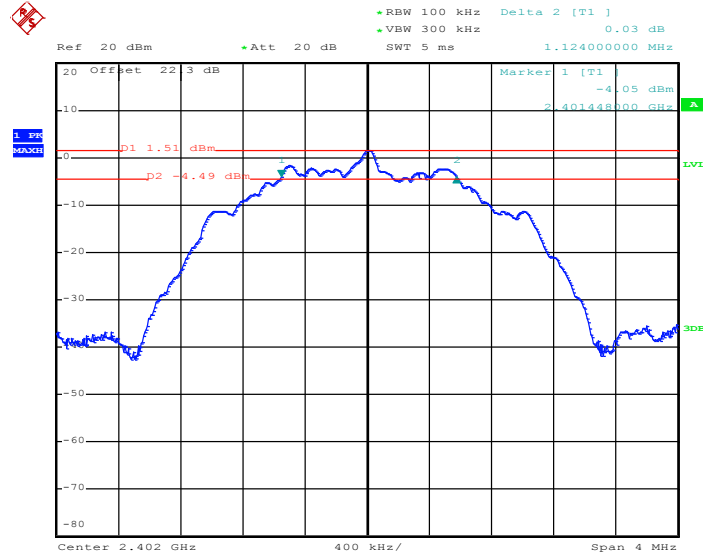

Date: 31.JAN.2019 15:19:19

6 dB Bandwidth Plot on Channel 19

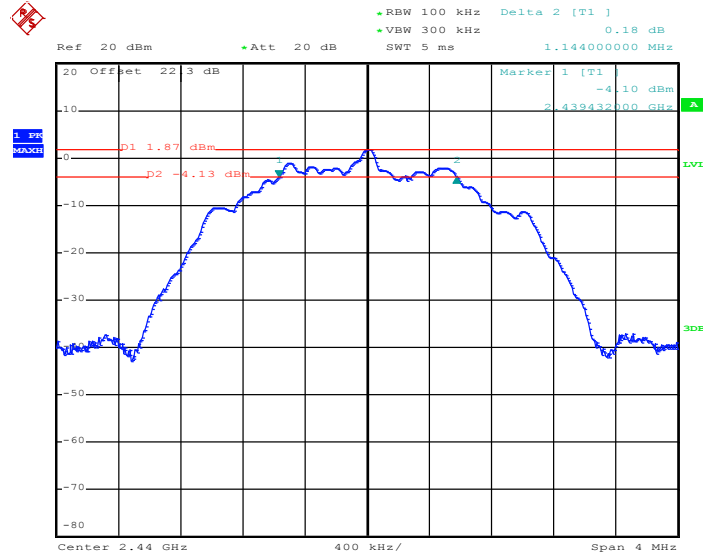

Date: 31.JAN.2019 15:24:04



6 dB Bandwidth Plot on Channel 39

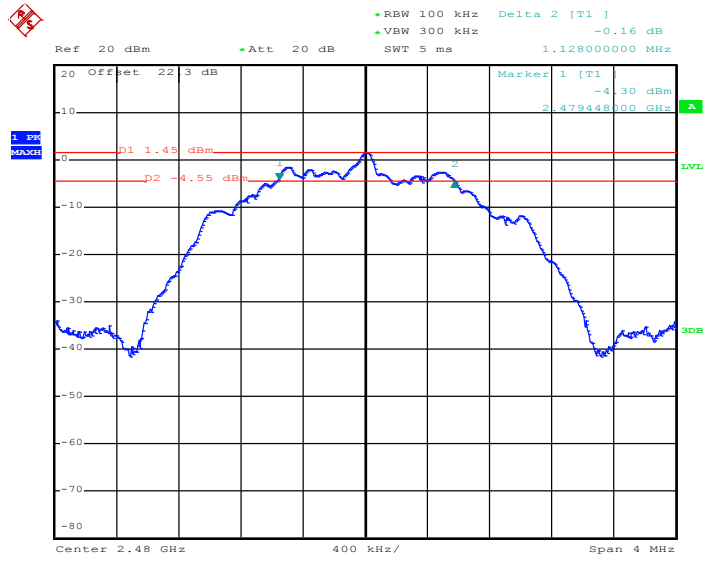

Date: 31.JAN.2019 15:27:25



3.1.6 Test Result of 99% Occupied Bandwidth

Test Engineer :	Luffy Lin and Allen Lin	Temperature :	21~25°C
		Relative Humidity :	51~54%

Mod.	Data Rate	NTX	CH.	Freq. (MHz)	99% Occupied BW (MHz)	Pass/Fail
BLE	1Mbps	1	0	2402	1.030	Pass
BLE	1Mbps	1	19	2440	1.030	Pass
BLE	1Mbps	1	39	2480	1.030	Pass
BLE	2Mbps	1	0	2402	2.044	Pass
BLE	2Mbps	1	19	2440	2.044	Pass
BLE	2Mbps	1	39	2480	2.052	Pass

<1Mbps>

99% Bandwidth Plot on Channel 00

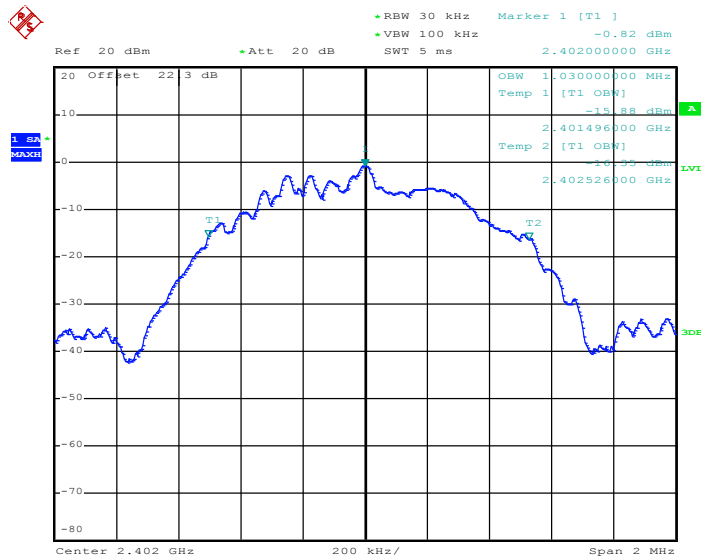

Date: 31.JAN.2019 15:05:08



99% Occupied Bandwidth Plot on Channel 19

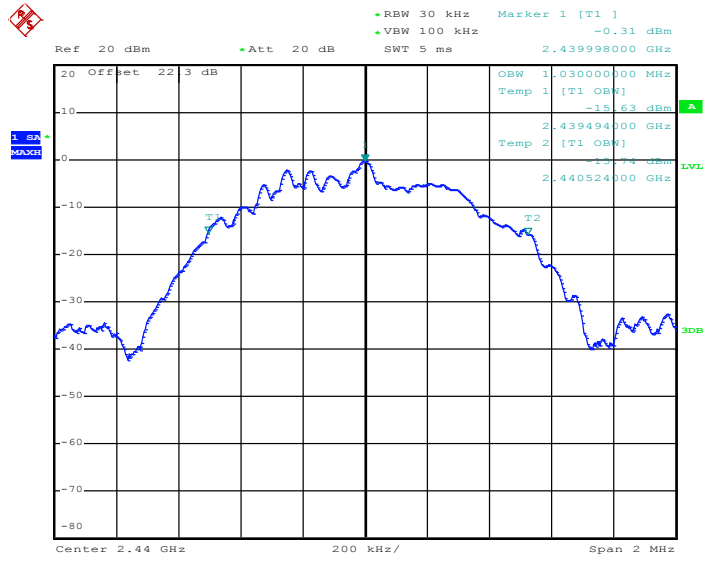

Date: 31.JAN.2019 15:09:11

99% Occupied Bandwidth Plot on Channel 39

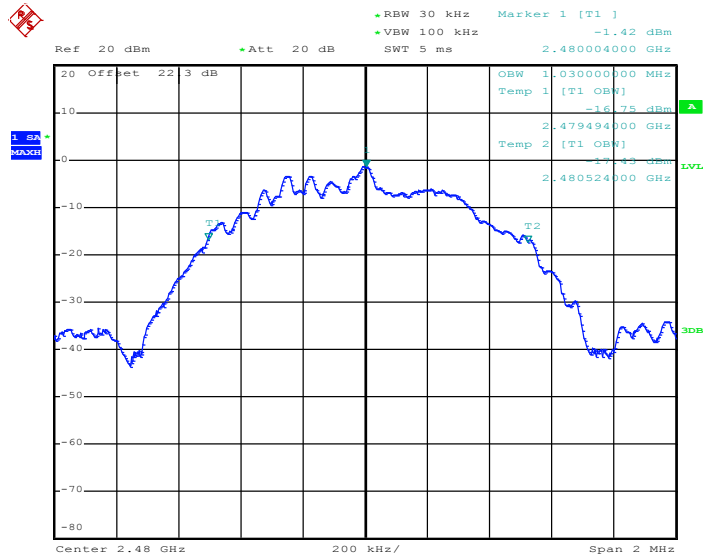

Date: 31.JAN.2019 15:14:36



<2Mbps>

99% Bandwidth Plot on Channel 00

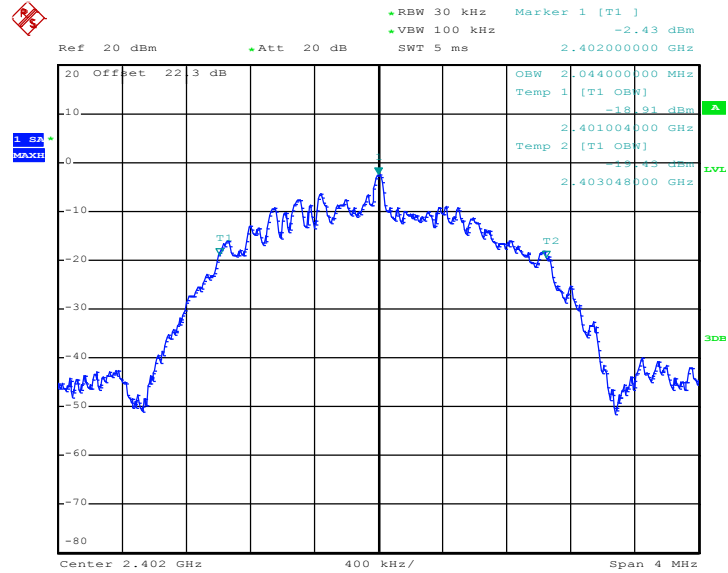

Date: 31.JAN.2019 15:22:14

99% Occupied Bandwidth Plot on Channel 19

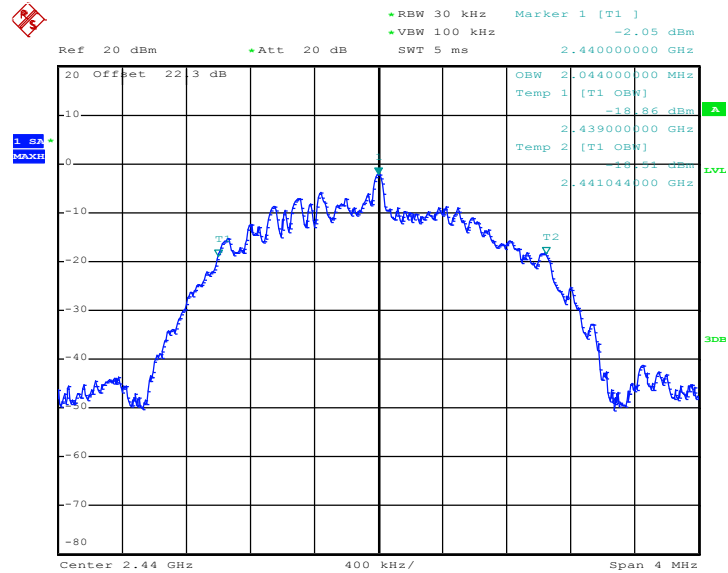

Date: 31.JAN.2019 15:26:15



99% Occupied Bandwidth Plot on Channel 39

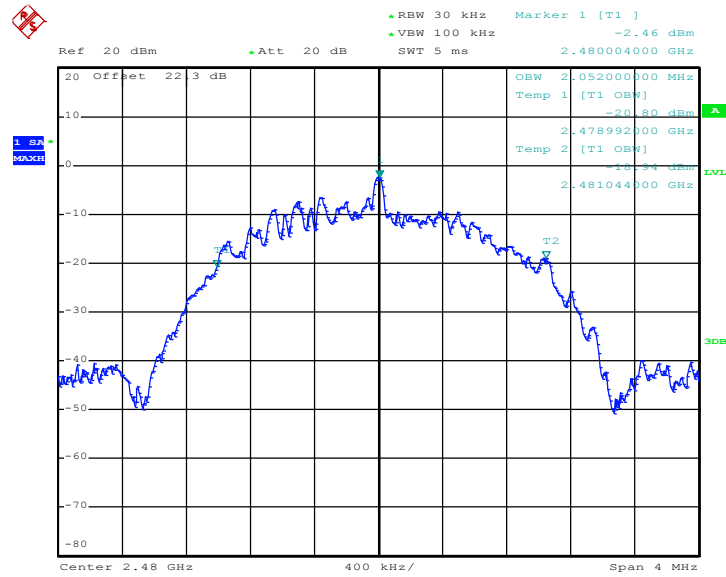

Date: 31.JAN.2019 15:29:21

Note : The occupied channel bandwidth is maintained within the band of operation for all of the modulations.

### 3.2 Output Power Measurement

#### 3.2.1 Limit of Output Power

For systems using digital modulation in the 2400-2483.5MHz, the limit for peak output power is 30dBm. If transmitting antenna of directional gain greater than 6dBi is used, the peak output power from the intentional radiator shall be reduced below the above stated value by the amount in dB that the directional gain of the antenna exceeds 6 dBi. In case of point-to-point operation, the limit has to be reduced by 1dB for every 3dB that the directional gain of the antenna exceeds 6dBi.

#### 3.2.2 Measuring Instruments

See list of measuring equipment of this test report.

#### 3.2.3 Test Procedures

1. For Average Power, the testing follows ANSI C63.10 Section 11.9.2.3.2 Method AVGPM-G.
2. The RF output of EUT was connected to the power meter by RF cable and attenuator.
3. The path loss was compensated to the results for each measurement.
4. Set to the maximum power setting and enable the EUT transmit continuously.
5. Measure the conducted output power and record the results in the test report.

#### 3.2.4 Test Setup

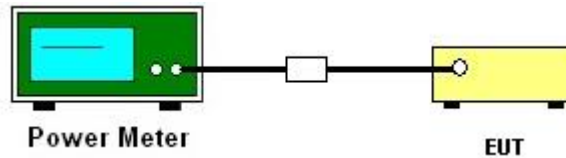

#### 3.2.5 Test Result of Average Output Power

Test Engineer :	Luffy Lin and Allen Lin	Temperature :	21~25°C
		Relative Humidity :	51~54%

Mod.	Data Rate	NTX	CH.	Freq. (MHz)	Duty Factor (dB)	Average Conducted Power (dBm)
BLE	1Mbps	1	0	2402	2.06	1.85
BLE	1Mbps	1	19	2440	2.06	<b>1.95</b>
BLE	1Mbps	1	39	2480	2.06	1.55
BLE	2Mbps	1	0	2402	4.90	1.75
BLE	2Mbps	1	19	2440	4.90	<b>1.85</b>
BLE	2Mbps	1	39	2480	4.90	1.45

### 3.3 Power Spectral Density Measurement

#### 3.3.1 Limit of Power Spectral Density

The peak power spectral density shall not be greater than 8dBm in any 3kHz band at any time interval of continuous transmission.

#### 3.3.2 Measuring Instruments

See list of measuring equipment of this test report.

#### 3.3.3 Test Procedures

1. The testing follows the ANSI C63.10 Section 11.10.2 Method PKPSD.
2. The RF output of EUT was connected to the spectrum analyzer by RF cable and attenuator. The path loss was compensated to the results for each measurement.
3. Set to the maximum power setting and enable the EUT transmit continuously.
4. Make the measurement with the spectrum analyzer's resolution bandwidth (RBW) = 3 kHz. Video bandwidth VBW = 10 kHz In order to make an accurate measurement, set the span to 1.5 times DTS Channel Bandwidth. (6dB BW)
5. Detector = peak, Sweep time = auto couple, Trace mode = max hold, Allow trace to fully stabilize. Use the peak marker function to determine the maximum power level.
6. Measure and record the results in the test report.
7. The Measured power density (dBm)/ 100kHz is a reference level and used as 20dBc down limit line for Conducted Band Edges and Conducted Spurious Emission.

#### 3.3.4 Test Setup

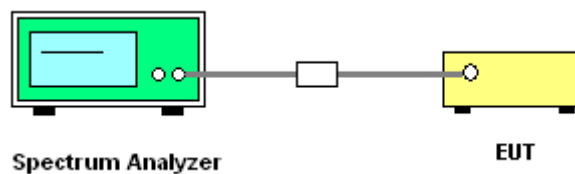





3.3.5 Test Result of Power Spectral Density

Test Engineer :	Luffy Lin and Allen Lin	Temperature :	21~25°C
		Relative Humidity :	51~54%

Mod.	Data Rate	NTX	CH.	Freq. (MHz)	Peak PSD (dBm /100kHz)	Peak PSD (dBm /3kHz)	DG (dBi)	Peak PSD Limit (dBm /3kHz)	Pass/Fail
BLE	1Mbps	1	0	2402	2.04	-12.77	3.86	8.00	Pass
BLE	1Mbps	1	19	2440	2.53	-12.24	3.86	8.00	Pass
BLE	1Mbps	1	39	2480	1.45	-13.01	3.86	8.00	Pass
BLE	2Mbps	1	0	2402	1.50	-16.81	3.86	8.00	Pass
BLE	2Mbps	1	19	2440	1.86	-16.40	3.86	8.00	Pass
BLE	2Mbps	1	39	2480	1.45	-16.85	3.86	8.00	Pass

3.3.6 Test Result of Power Spectral Density Plots (100kHz)

Test Engineer :	Luffy Lin and Allen Lin	Temperature :	21~25°C
		Relative Humidity :	51~54%

<1Mbps>

PSD 100kHz Plot on Channel 00

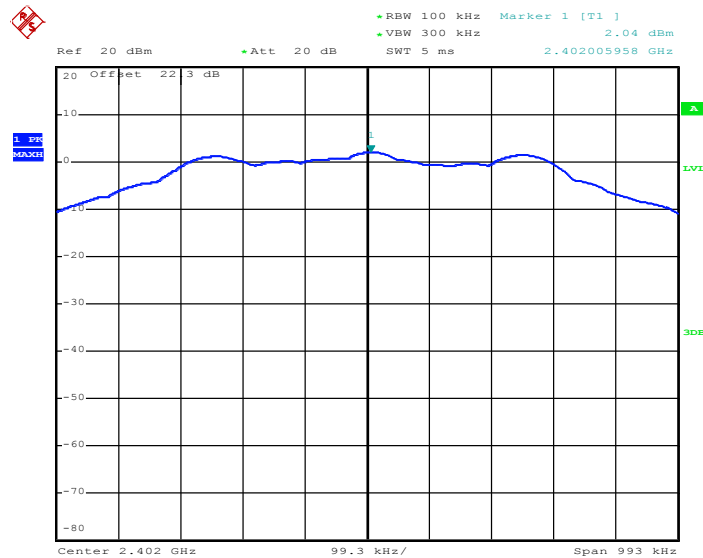

Date: 31.JAN.2019 15:03:41



PSD 100kHz Plot on Channel 19

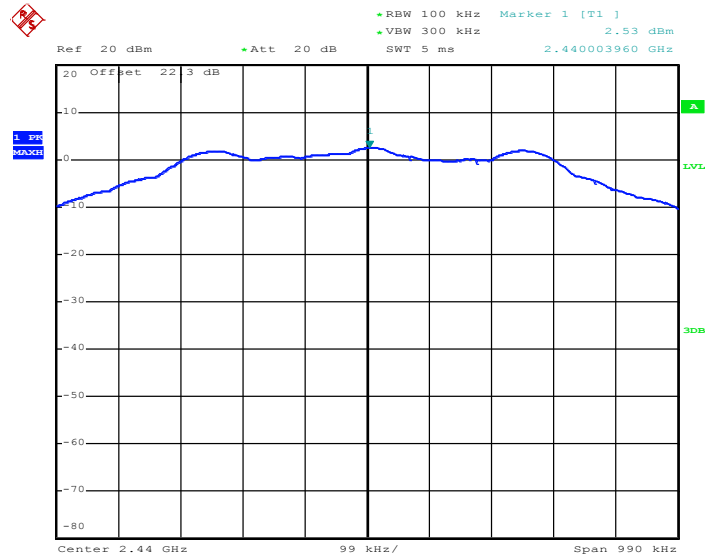

Date: 31.JAN.2019 15:07:40

PSD 100kHz Plot on Channel 39

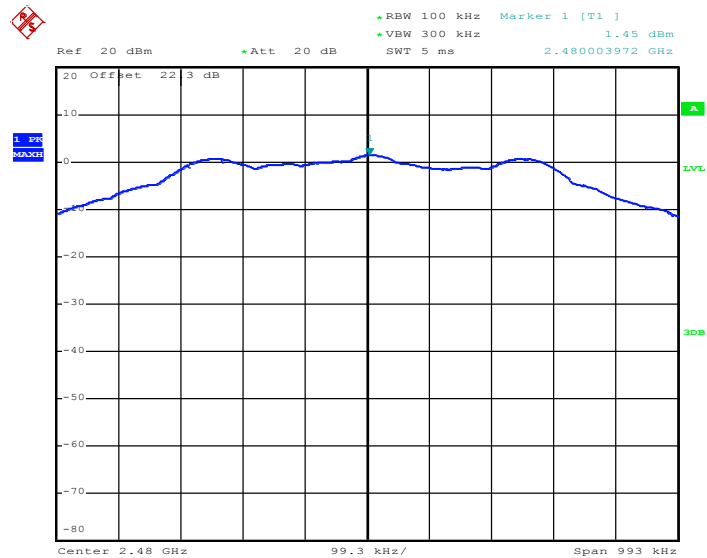

Date: 31.JAN.2019 15:12:47



<2Mbps>

PSD 100kHz Plot on Channel 00

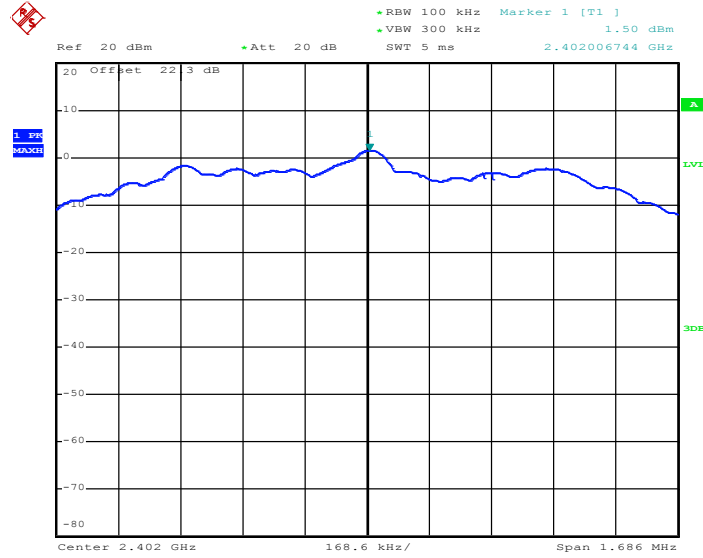

Date: 31.JAN.2019 15:20:20

PSD 100kHz Plot on Channel 19

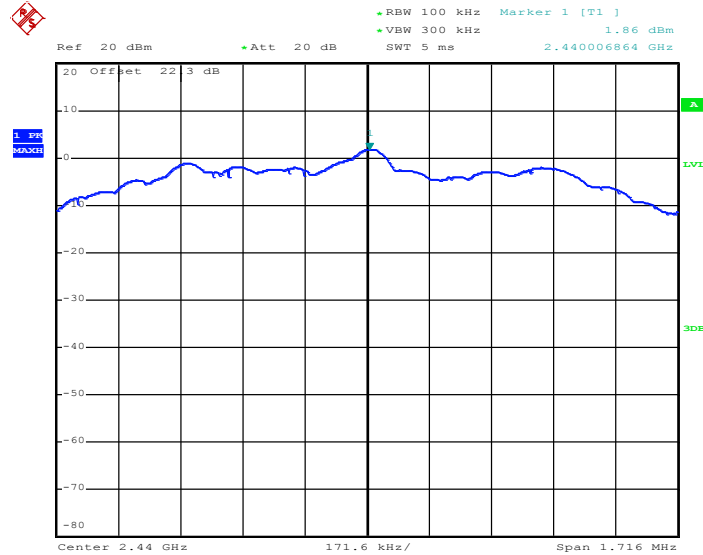

Date: 31.JAN.2019 15:24:55



PSD 100kHz Plot on Channel 39

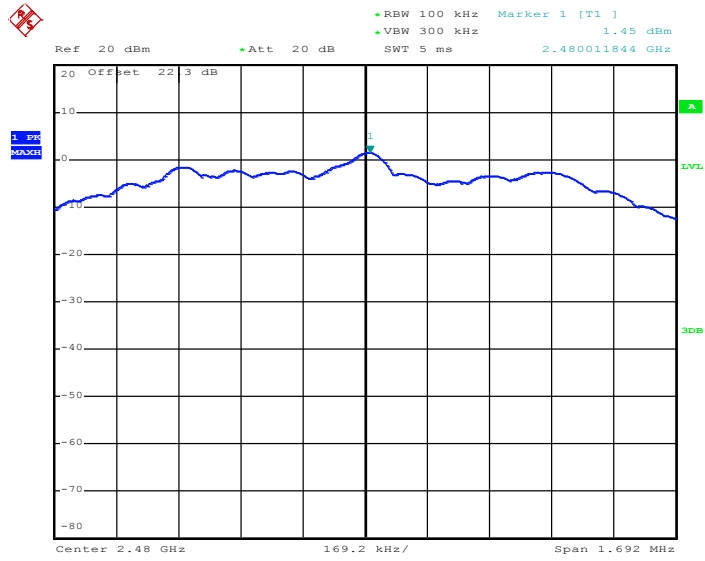

Date: 31.JAN.2019 15:28:16



3.3.7 Test Result of Power Spectral Density Plots (3kHz)

Test Engineer :	Luffy Lin and Allen Lin	Temperature :	21~25°C
		Relative Humidity :	51~54%

<1Mbps>

PSD 3kHz Plot on Channel 00

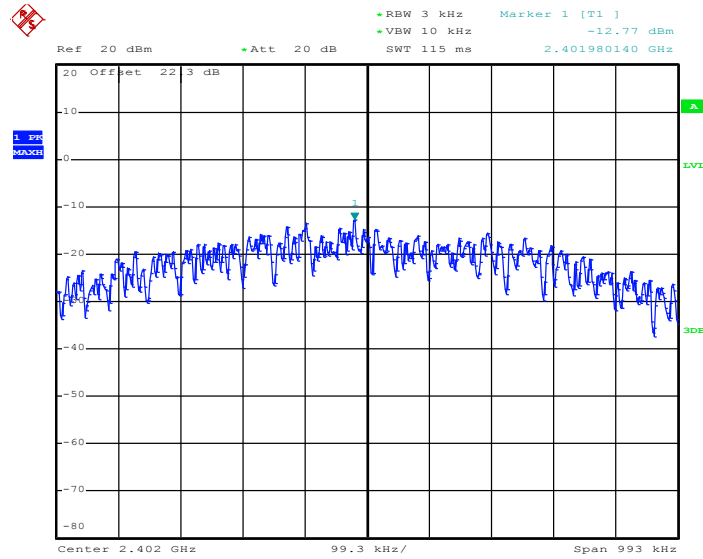

Date: 31.JAN.2019 15:03:02

PSD 3kHz Plot on Channel 19

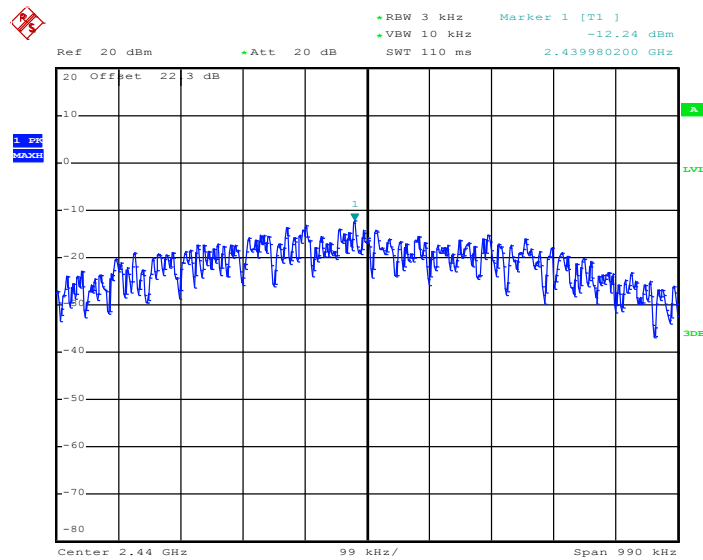

Date: 31.JAN.2019 15:07:24



PSD 3kHz Plot on Channel 39

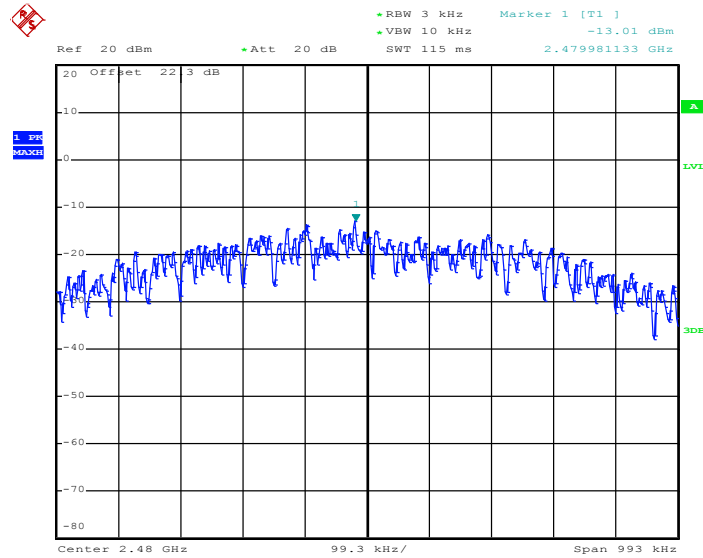

Date: 31.JAN.2019 15:12:08

<2Mbps>

PSD 3kHz Plot on Channel 00

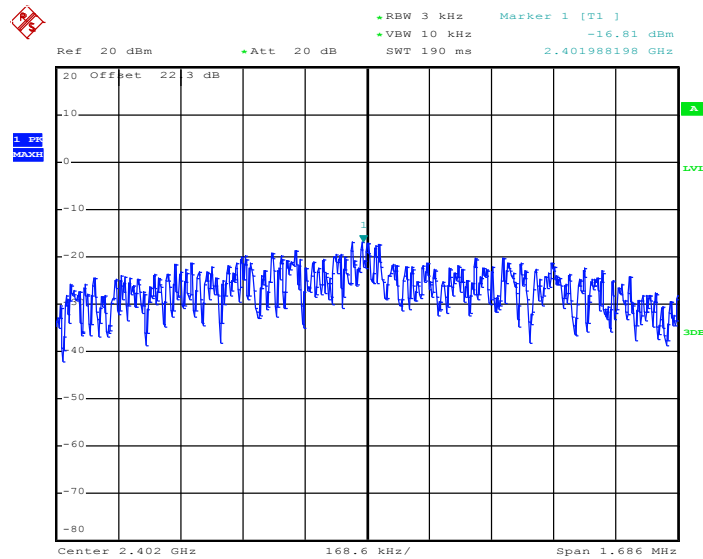

Date: 31.JAN.2019 15:19:52



PSD 3kHz Plot on Channel 19

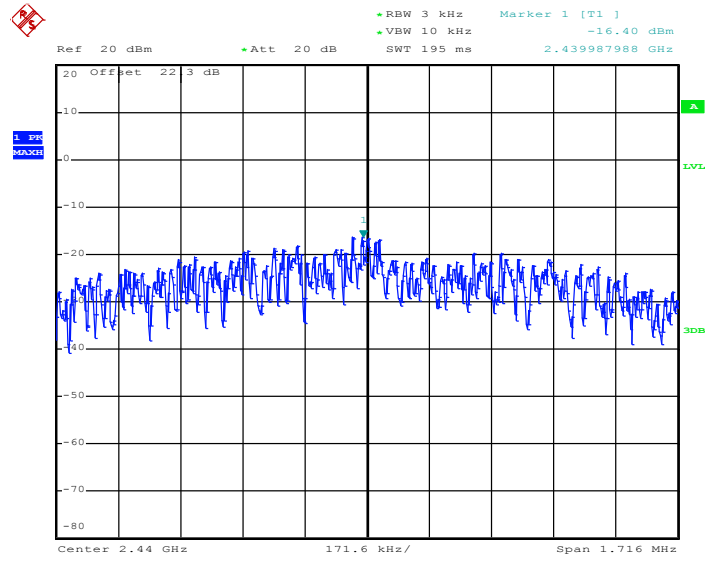

Date: 31.JAN.2019 15:24:39

PSD 3kHz Plot on Channel 39

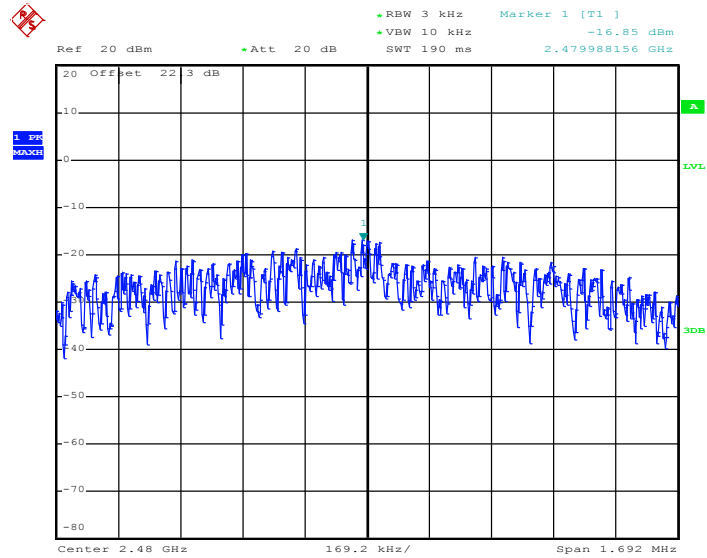

Date: 31.JAN.2019 15:27:56

## 3.4 Conducted Band Edges and Spurious Emission Measurement

### 3.4.1 Limit of Conducted Band Edges and Spurious Emission

All harmonics/spurious must be at least 30 dB down from the highest emission level within the authorized band.

### 3.4.2 Measuring Instruments

See list of measuring equipment of this test report.

### 3.4.3 Test Procedure

1. The testing follows the ANSI C63.10 Section 11.11.3 Emission level measurement.
2. The RF output of EUT was connected to the spectrum analyzer by RF cable and attenuator. The path loss was compensated to the results for each measurement.
3. Set to the maximum power setting and enable the EUT transmit continuously.
4. Set RBW = 100 kHz, VBW=300 kHz, Peak Detector. Unwanted Emissions measured in any 100 kHz bandwidth outside of the authorized frequency band shall be attenuated by at least 20 dB relative to the maximum in-band peak PSD level in 100 kHz when maximum peak conducted output power procedure is used. If the transmitter complies with the conducted power limits based on the use of RMS averaging over a time interval, the attenuation required under this paragraph shall be 30 dB instead of 20 dB.
5. Measure and record the results in the test report.
6. The RF fundamental frequency should be excluded against the limit line in the operating frequency band.

### 3.4.4 Test Setup

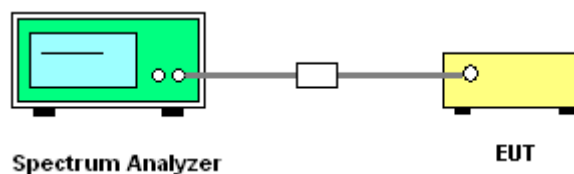





### 3.4.5 Test Result of Conducted Band Edges Plots

Test Engineer :	Luffy Lin and Allen Lin	Temperature :	21~25°C
		Relative Humidity :	51~54%

<1Mbps>

#### Low Band Edge Plot on Channel 00

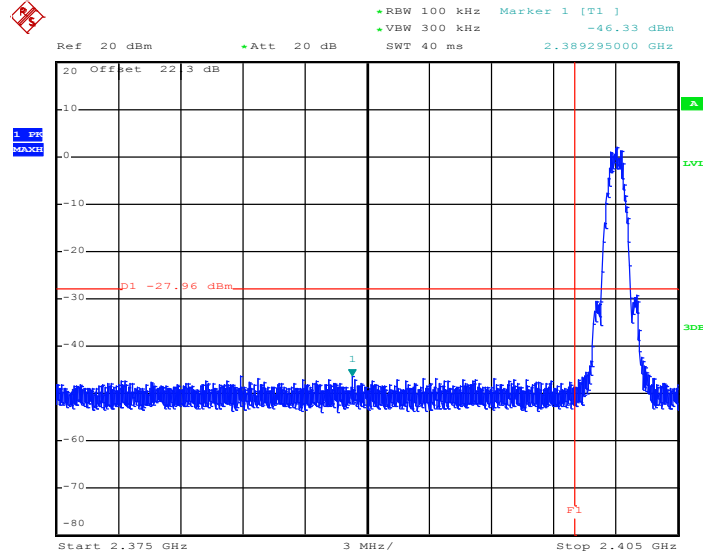

Date: 31.JAN.2019 15:03:59

#### High Band Edge Plot on Channel 39

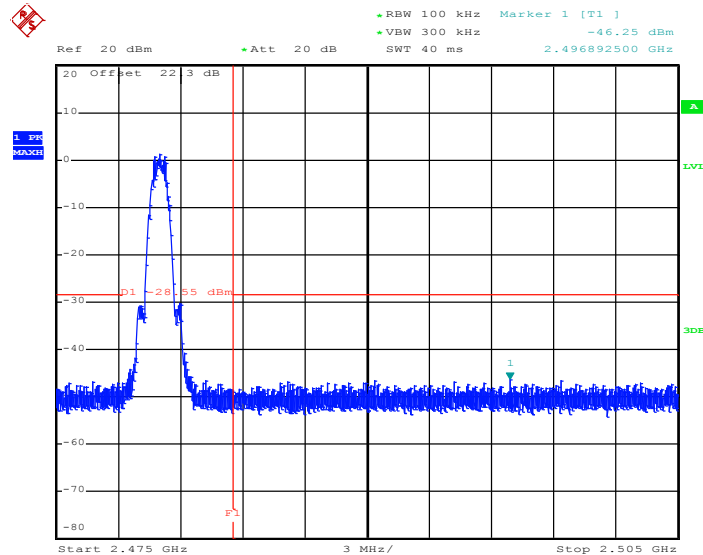

Date: 31.JAN.2019 15:13:00



<2Mbps>

Low Band Edge Plot on Channel 00

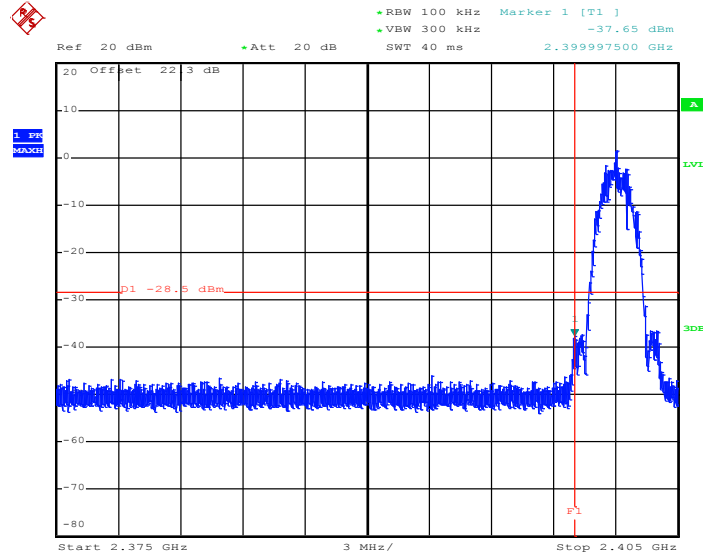

Date: 31.JAN.2019 15:22:31

High Band Edge Plot on Channel 39

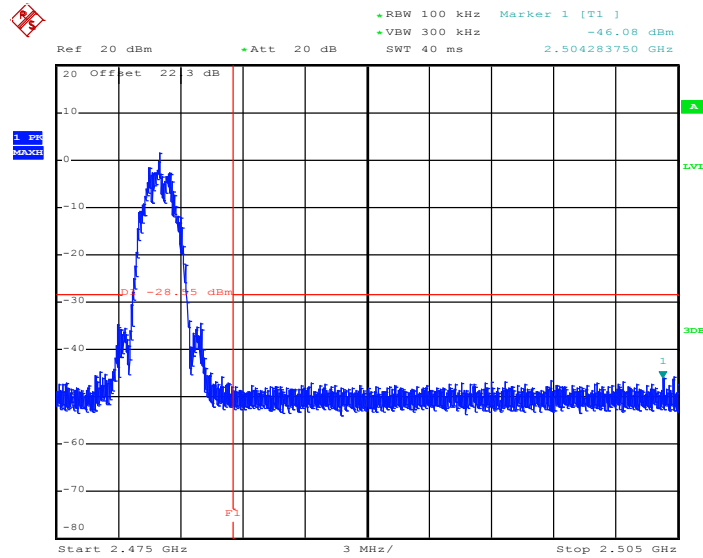

Date: 31.JAN.2019 15:28:30



3.4.6 Test Result of Conducted Spurious Emission Plots

Test Engineer :	Luffy Lin and Allen Lin	Temperature :	21~25°C
		Relative Humidity :	51~54%

Conducted Spurious Emission Plot on Bluetooth LE 1Mbps GFSK Channel 00

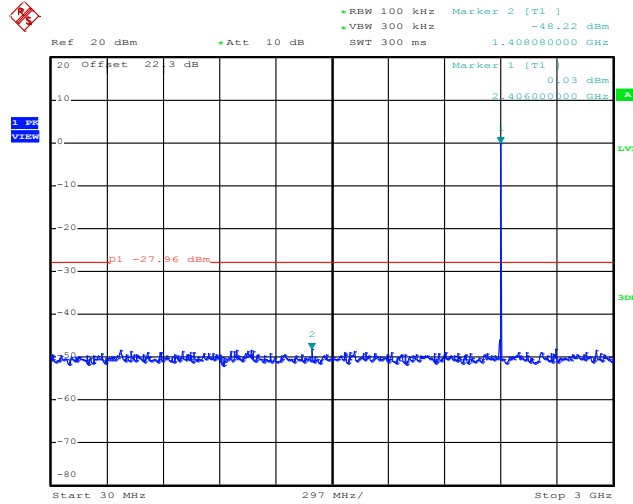

Date: 31.JAN.2019 15:04:26

Conducted Spurious Emission Plot on Bluetooth LE 1Mbps GFSK Channel 00

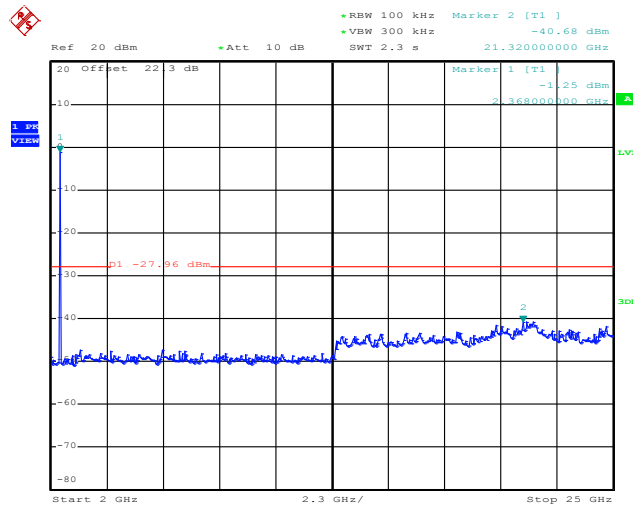

Date: 31.JAN.2019 15:04:47



### Conducted Spurious Emission Plot on Bluetooth LE 1Mbps GFSK Channel 19

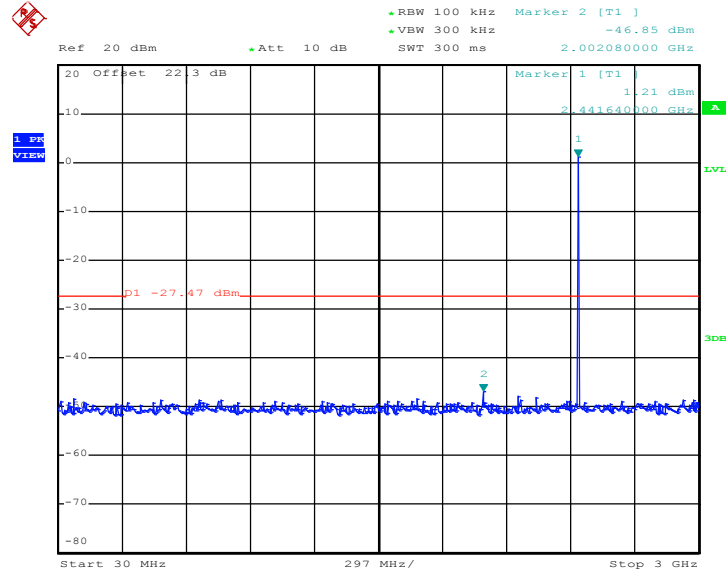

Date: 31.JAN.2019 15:08:19

### Conducted Spurious Emission Plot on Bluetooth LE 1Mbps GFSK Channel 19

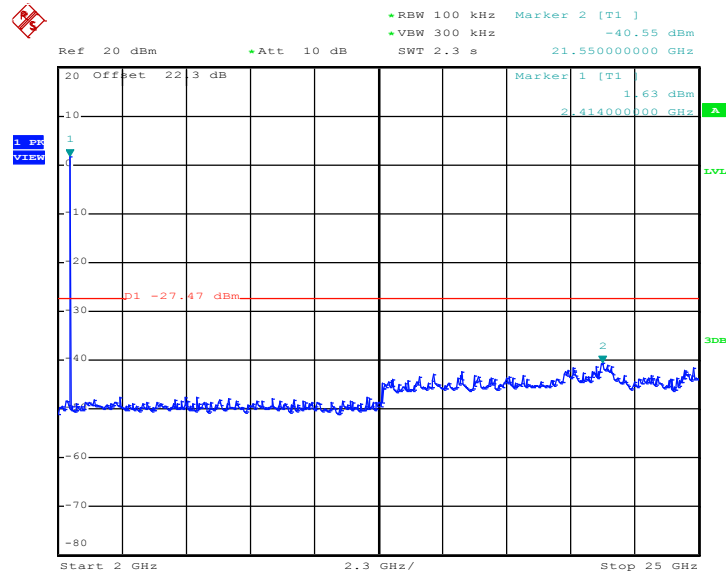

Date: 31.JAN.2019 15:08:49



Conducted Spurious Emission Plot on Bluetooth LE 1Mbps GFSK Channel 39

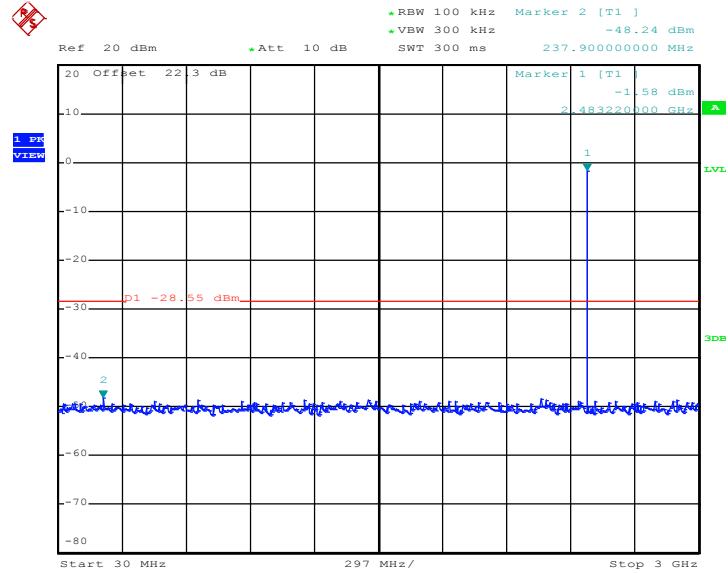

Date: 31.JAN.2019 15:13:21

Conducted Spurious Emission Plot on Bluetooth LE 1Mbps GFSK Channel 39

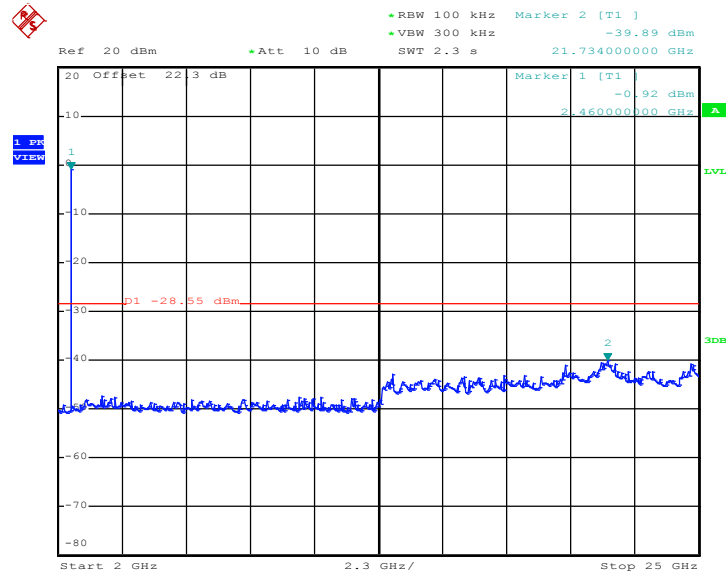

Date: 31.JAN.2019 15:14:18



### Conducted Spurious Emission Plot on Bluetooth LE 2Mbps GFSK Channel 00

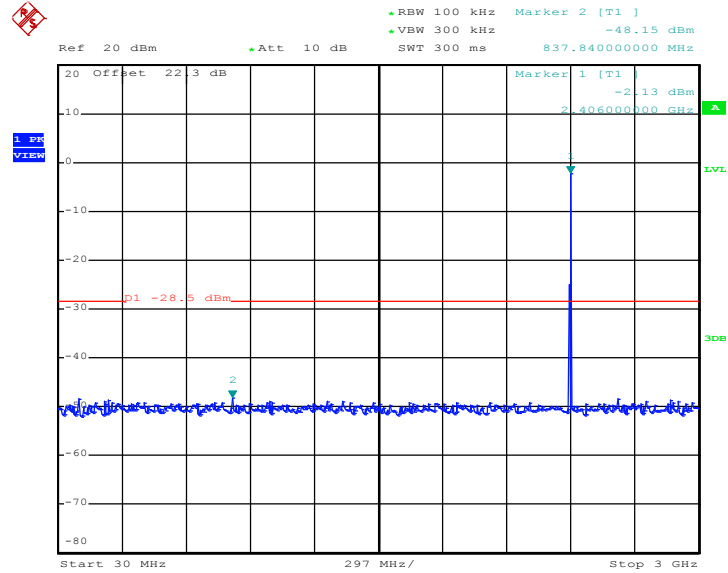

Date: 31.JAN.2019 15:21:06

### Conducted Spurious Emission Plot on Bluetooth LE 2Mbps GFSK Channel 00

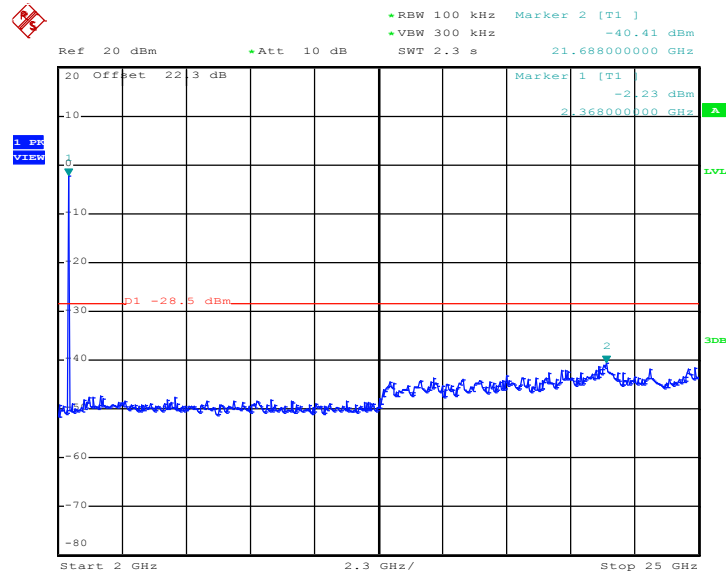

Date: 31.JAN.2019 15:21:54



### Conducted Spurious Emission Plot on Bluetooth LE 2Mbps GFSK Channel 19

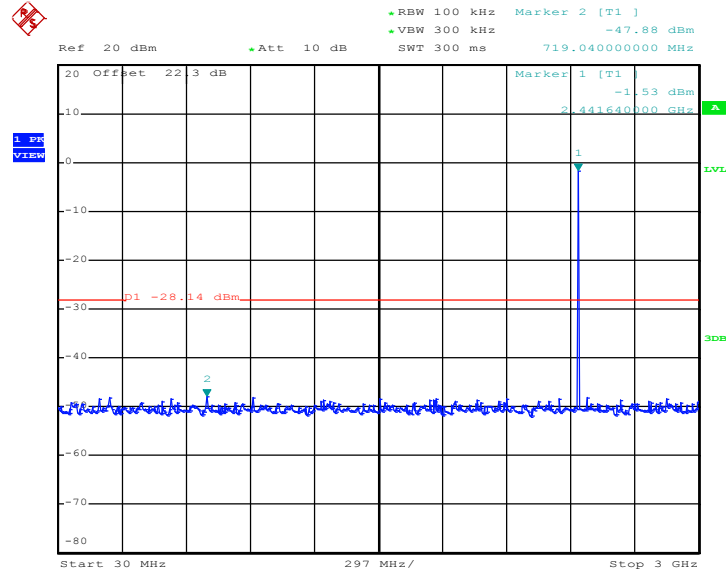

Date: 31.JAN.2019 15:25:11

### Conducted Spurious Emission Plot on Bluetooth LE 2Mbps GFSK Channel 19

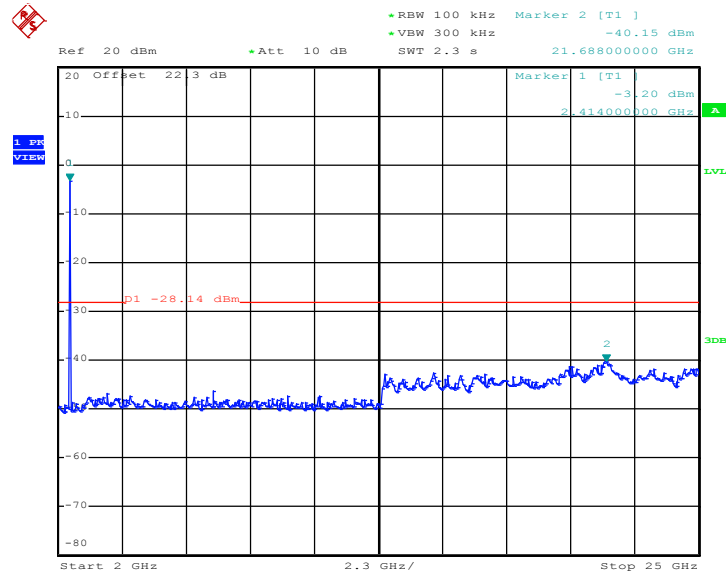

Date: 31.JAN.2019 15:25:57



### Conducted Spurious Emission Plot on Bluetooth LE 2Mbps GFSK Channel 39

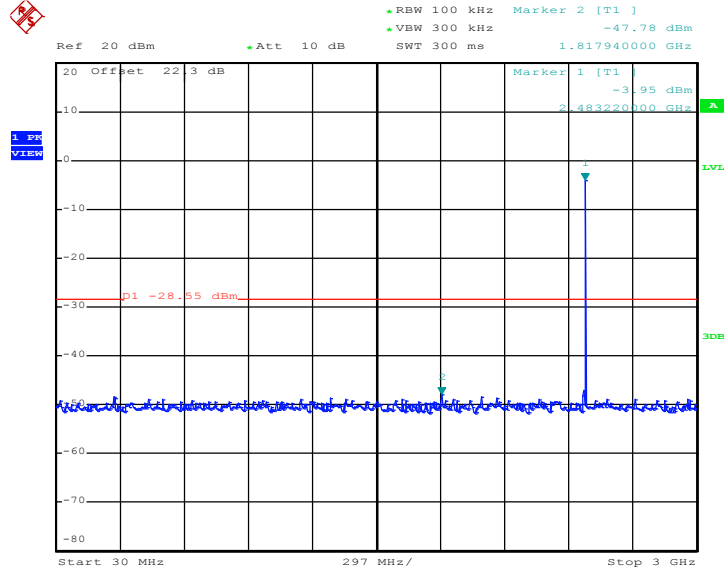

Date: 31.JAN.2019 15:28:49

### Conducted Spurious Emission Plot on Bluetooth LE 2Mbps GFSK Channel 39

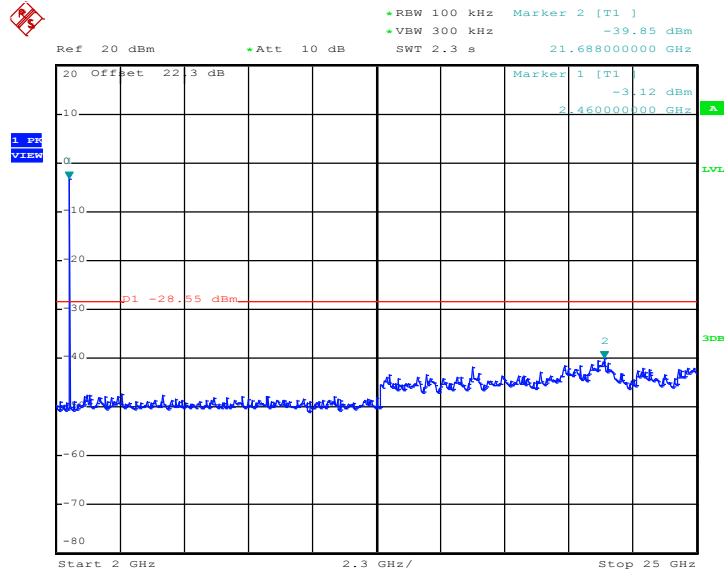

Date: 31.JAN.2019 15:29:05





### 3.5 Radiated Band Edges and Spurious Emission Measurement

#### 3.5.1 Limit of Radiated Band Edges and Spurious Emission

In any 100 kHz bandwidth outside the intentional radiator frequency band, all harmonics/spurious must be at least 20 dB below the highest emission level within the authorized band. If the output power of this device was measured by spectrum analyzer, the attenuation under this paragraph shall be 30 dB instead of 20 dB. In addition, radiated emissions which fall in the restricted bands must also comply with the limits as below.

Frequency (MHz)	Field Strength (microvolts/meter)	Measurement Distance (meters)
0.009 – 0.490	2400/F(kHz)	300
0.490 – 1.705	24000/F(kHz)	30
1.705 – 30.0	30	30
30 – 88	100	3
88 – 216	150	3
216 - 960	200	3
Above 960	500	3

#### 3.5.2 Measuring Instruments

See list of measuring equipment of this test report.



### 3.5.3 Test Procedures

1. The testing follows the ANSI C63.10 Section 11.12.1 Radiated emission measurements.
2. The EUT was arranged to its worst case and then tune the antenna tower (from 1 m to 4 m) and turntable (from 0 degree to 360 degrees) to find the maximum reading. A pre-amp and a high pass filter are used for the test in order to get better signal level.
3. The EUT was placed on a turntable with 0.8 meter for frequency below 1GHz and 1.5 meter for frequency above 1GHz respectively above ground.
4. The EUT was set 3 meters from the interference receiving antenna, which was mounted on the top of a variable height antenna tower.
5. Corrected Reading: Antenna Factor + Cable Loss + Read Level - Preamp Factor = Level
6. For testing below 1GHz, if the emission level of the EUT in peak mode was 3 dB lower than the limit specified, then peak values of EUT will be reported, otherwise, the emissions will be repeated one by one using the CISPR quasi-peak method and reported.
7. For testing above 1GHz, the emission level of the EUT in peak mode was 20dB lower than average limit (that means the emission level in average mode also complies with the limit in average mode), then peak values of EUT will be reported, otherwise, the emissions will be measured in average mode again and reported.
8. Use the following spectrum analyzer settings:
  - (1) Span shall wide enough to fully capture the emission being measured;
  - (2) Set RBW=100 kHz for  $f < 1$  GHz;  $VBW \geq RBW$ ; Sweep = auto; Detector function = peak; Trace = max hold;
  - (3) Set RBW = 1 MHz, VBW= 3MHz for  $f \geq 1$  GHz for peak measurement.  
For average measurement:
    - $VBW = 10$  Hz, when duty cycle is no less than 98 percent.
    - $VBW \geq 1/T$ , when duty cycle is less than 98 percent where T is the minimum transmission duration over which the transmitter is on and is transmitting at its maximum power control level for the tested mode of operation.

### 3.5.4 Test Setup

For radiated emissions below 30MHz

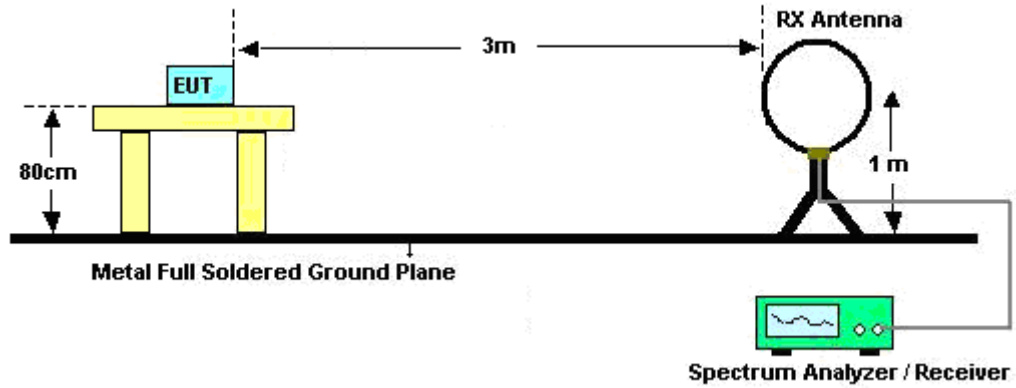

For radiated emissions from 30MHz to 1GHz

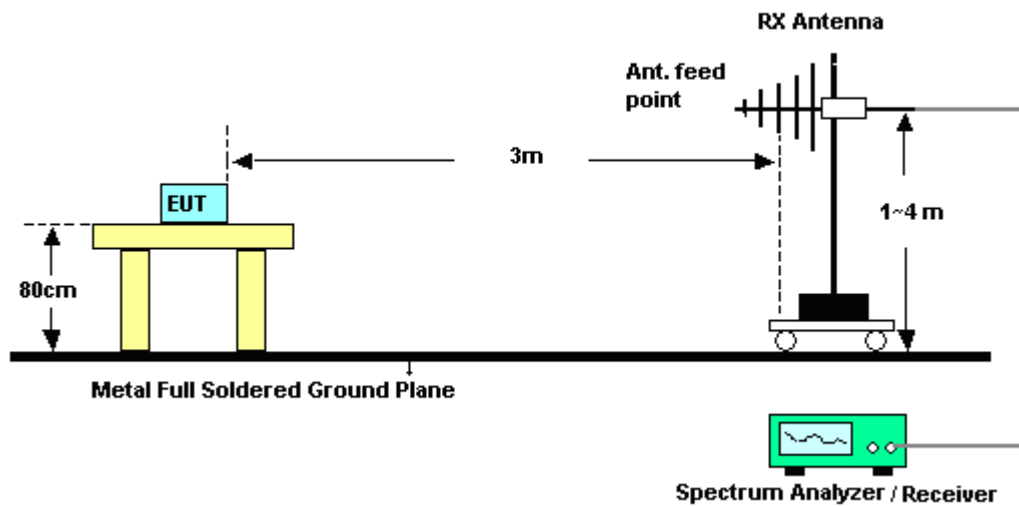

For radiated emissions above 1GHz

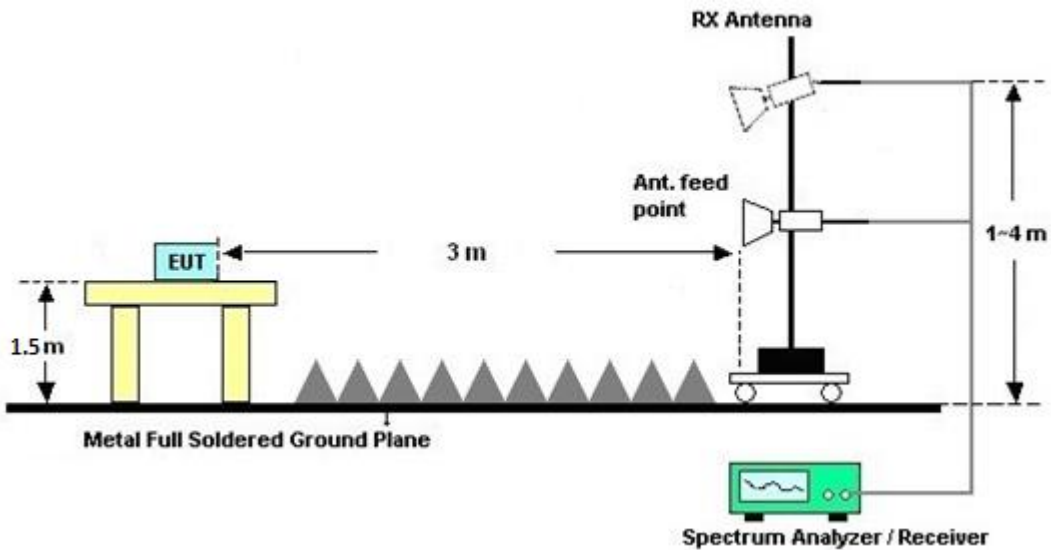

### 3.5.5 Test Results of Radiated Spurious Emissions (9 kHz ~ 30 MHz)

The low frequency, which started from 9 kHz to 30MHz, was pre-scanned and the result which was 20dB lower than the limit line was not reported.

There is a comparison data of both open-field test site and alternative test site - semi-Anechoic chamber according to 414788 D01 Radiated Test Site v01r01, and the result came out very similar.

### 3.5.6 Test Result of Radiated Spurious at Band Edges

Please refer to Appendix B and C.

### 3.5.7 Duty Cycle

Please refer to Appendix D.

### 3.5.8 Test Result of Radiated Spurious Emission (30MHz ~ 10th Harmonic)

Please refer to Appendix B and C.



### 3.6 AC Conducted Emission Measurement

#### 3.6.1 Limit of AC Conducted Emission

For equipment that is designed to be connected to the public utility (AC) power line, the radio frequency voltage that is conducted back onto the AC power line on any frequency or frequencies within the band 150 kHz to 30 MHz shall not exceed the limits in the following table.

Frequency of emission (MHz)	Conducted limit (dB $\mu$ V)	
	Quasi-peak	Average
0.15-0.5	66 to 56*	56 to 46*
0.5-5	56	46
5-30	60	50

\*Decreases with the logarithm of the frequency.

#### 3.6.2 Measuring Instruments

See list of measuring equipment of this test report.

#### 3.6.3 Test Procedures

1. The EUT was placed 0.4 meter from the conducting wall of the shielding room was kept at least 80 centimeters from any other grounded conducting surface.
2. Connect EUT to the power mains through a line impedance stabilization network (LISN).
3. All the support units are connecting to the other LISN.
4. The LISN provides 50 ohm coupling impedance for the measuring instrument.
5. The FCC states that a 50 ohm, 50 microhenry LISN should be used.
6. Both sides of AC line were checked for maximum conducted interference.
7. The frequency range from 150 kHz to 30 MHz was searched.
8. Set the test-receiver system to Peak Detect Function and specified bandwidth (IF Bandwidth = 9kHz) with Maximum Hold Mode. Then measurement is also conducted by Average Detector and Quasi-Peak Detector Function respectively.

### 3.6.4 Test Setup

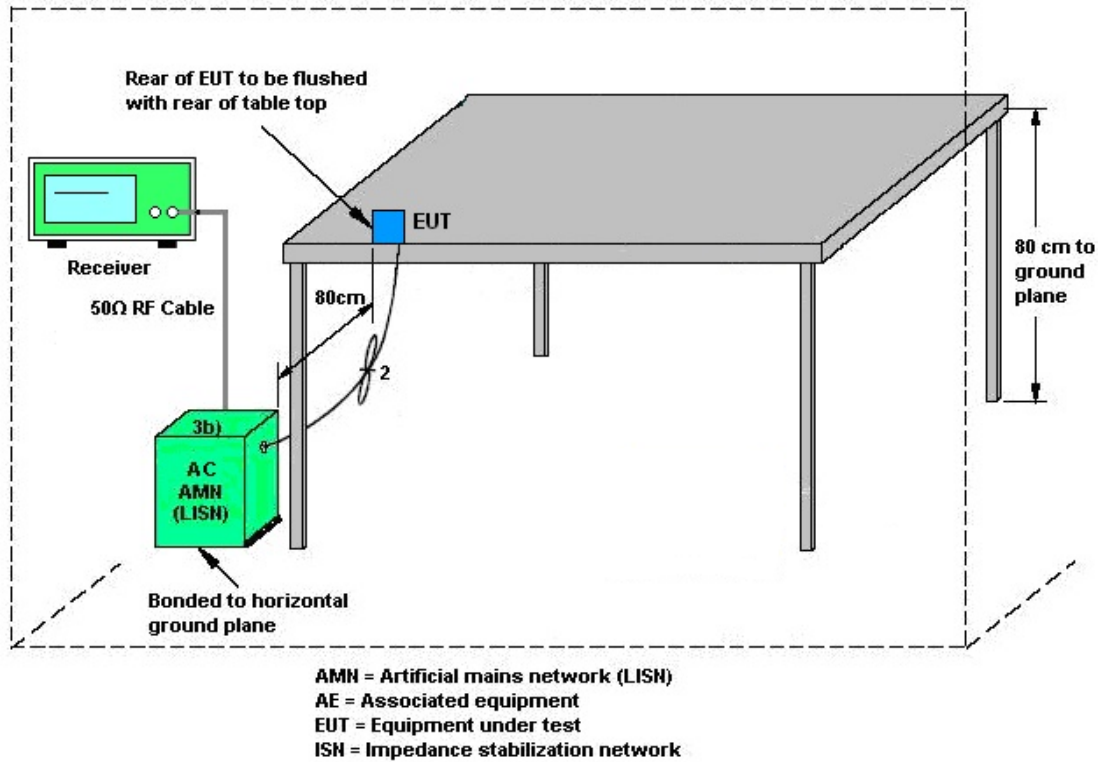

### 3.6.5 Test Result of AC Conducted Emission

Please refer to Appendix A.



## **3.7 Antenna Requirements**

### **3.7.1 Standard Applicable**

If directional gain of transmitting antennas is greater than 6dBi, the power shall be reduced by the same level in dB comparing to gain minus 6dBi. The use of a permanently attached antenna or of an antenna that uses a unique coupling to the intentional radiator shall be considered sufficient to comply with the rule.

### **3.7.2 Antenna Anti-Replacement Construction**

An embedded-in antenna design is used.

### **3.7.3 Antenna Gain**

The antenna peak gain of EUT is less than 6 dBi. Therefore, it is not necessary to reduce maximum peak output power limit.



## 4 List of Measuring Equipment

Instrument	Manufacturer	Model No.	Serial No.	Characteristics	Calibration Date	Test Date	Due Date	Remark
Power Sensor	DARE	RadiPower	15I00041S NO09	10MHz~6GHz	May 07, 2018	Jan. 22, 2019~ Jan. 31, 2019	May 06, 2019	Conducted (TH05-HY)
Spectrum Analyzer	Rohde & Schwarz	FSP40	100057	9kHz-40GHz	Nov. 21, 2018	Jan. 22, 2019~ Jan. 31, 2019	Nov. 20, 2019	Conducted (TH05-HY)
Switch Box & RF Cable	Burgeon	ETF-058	EC130048 4	N/A	Mar. 01, 2018	Jan. 22, 2019~ Jan. 31, 2019	Feb. 28, 2019	Conducted (TH05-HY)
AC Power Source	ChainTek	APC-1000W	N/A	N/A	N/A	Feb. 20, 2019	N/A	Conduction (CO05-HY)
EMI Test Receiver	Rohde & Schwarz	ESR3	102388	9KHz~3.6GHz	Nov. 12, 2018	Feb. 20, 2019	Nov. 11, 2019	Conduction (CO05-HY)
LISN	Rohde & Schwarz	ENV216	100080	9kHz~30MHz	Nov. 14, 2018	Feb. 20, 2019	Nov. 13, 2019	Conduction (CO05-HY)
LISN	Rohde & Schwarz	ENV216	100081	9kHz~30MHz	Nov. 09, 2018	Feb. 20, 2019	Nov. 08, 2019	Conduction (CO05-HY)
Software	Rohde & Schwarz	EMC32 V10.30	N/A	N/A	N/A	Feb. 20, 2019	N/A	Conduction (CO05-HY)
LF Cable	HUBER + SUHNER	RG-214/U	LF01	N/A	Dec. 31, 2018	Feb. 20, 2019	Dec. 30, 2019	Conduction (CO05-HY)
Pulse Limiter	Rohde & Schwarz	ESH3-Z2	100851	N/A	Dec. 31, 2018	Feb. 20, 2019	Dec. 30, 2019	Conduction (CO05-HY)
Loop Antenna	TESEQ	HLA 6120	31244	9 kHz~30 MHz	Mar. 29, 2018	Jan. 23, 2019~ Feb. 19, 2019	Mar. 28, 2019	Radiation (03CH15-HY)
Preamplifier	EMEC	EM18G40G	060715	18GHz ~ 40GHz	Dec. 06, 2018	Jan. 23, 2019~ Feb. 19, 2019	Dec. 05, 2019	Radiation (03CH15-HY)
Bilog Antenna	TESEQ	CBL6111D&0 0802N1D01N- 06	47020&06	30MHz to 1GHz	Oct. 13, 2018	Jan. 23, 2019~ Feb. 19, 2019	Oct. 12, 2019	Radiation (03CH15-HY)
Horn Antenna	SCHWARZBE CK	BBHA 9120D	9120D-162 0	1G~18GHz	Oct. 17, 2018	Jan. 23, 2019~ Feb. 19, 2019	Oct. 16, 2019	Radiation (03CH15-HY)
SHF-EHF Horn Antenna	SCHWARZBE CK	BBHA 9170	BBHA9170 576	18GHz ~ 40GHz	May 08, 2018	Jan. 23, 2019~ Feb. 19, 2019	May 07, 2019	Radiation (03CH15-HY)
Amplifier	SONOMA	310N	363440	9kHz~1GHz	Dec. 28, 2018	Jan. 23, 2019~ Feb. 19, 2019	Dec. 27, 2019	Radiation (03CH15-HY)
Preamplifier	Jet-Power	JPA0118-55-3 03	171000180 00550006	1GHz~18GHz	Jul. 10, 2018	Jan. 23, 2019~ Feb. 19, 2019	Jul. 09, 2019	Radiation (03CH15-HY)
Preamplifier	Keysight	83017A	MY532701 95	1GHz~26.5GHz	Aug. 23, 2018	Jan. 23, 2019~ Feb. 19, 2019	Aug. 22, 2019	Radiation (03CH15-HY)
EMI Test Receiver	Keysight	N9038A (MXE)	MY541300 85	20Hz ~ 8.4GHz	Nov. 01, 2018	Jan. 23, 2019~ Feb. 19, 2019	Oct. 31, 2019	Radiation (03CH15-HY)
Spectrum Analyzer	Agilent	E4446A	MY501801 36	3Hz~44GHz	Apr. 25, 2018	Jan. 23, 2019~ Feb. 19, 2019	Apr. 24, 2019	Radiation (03CH15-HY)
Antenna Mast	ChainTek	MBS-520-1	N/A	1m~4m	N/A	Jan. 23, 2019~ Feb. 19, 2019	N/A	Radiation (03CH15-HY)
Turn Table	ChainTek	T-200-S-1	N/A	0~360 Degree	N/A	Jan. 23, 2019~ Feb. 19, 2019	N/A	Radiation (03CH15-HY)
Software	Audix	E3 6.2009-8-24	RK-00045 1	N/A	N/A	Jan. 23, 2019~ Feb. 19, 2019	N/A	Radiation (03CH15-HY)
RF Cable	HUBER + SUHNER	SUCOFLEX 104	MY36980/ 4	30M-18G	Apr. 16, 2018	Jan. 23, 2019~ Feb. 19, 2019	Apr. 15, 2019	Radiation (03CH15-HY)
RF Cable	HUBER + SUHNER	SUCOFLEX 104	MY9838/4	30M-18G	Apr. 16, 2018	Jan. 23, 2019~ Feb. 19, 2019	Apr. 15, 2019	Radiation (03CH15-HY)
RF Cable	HUBER + SUHNER	MTJ	000000-M T18A-100 D3210	30M-18G	Apr. 16, 2018	Jan. 23, 2019~ Feb. 19, 2019	Apr. 15, 2019	Radiation (03CH15-HY)
RF Cable	HUBER + SUHNER	SUCOFLEX 102	MY2859/2	30MHz-40GHz	Mar. 14, 2018	Jan. 23, 2019~ Feb. 19, 2019	Mar. 13, 2019	Radiation (03CH15-HY)
RF Cable	HUBER + SUHNER	SUCOFLEX 102	MY4274/2	30MHz-40GHz	Mar. 14, 2018	Jan. 23, 2019~ Feb. 19, 2019	Mar. 13, 2019	Radiation (03CH15-HY)





Instrument	Manufacturer	Model No.	Serial No.	Characteristics	Calibration Date	Test Date	Due Date	Remark
Filter	Wainwright	WHKX12-270 0-3000-18000 -60SS	SN2	3.0 GHz High pass	Jul. 16, 2018	Jan. 23, 2019~ Feb. 19, 2019	Jul. 15, 2019	Radiation (03CH15-HY)
Filter	Wainwright	WLK4-1000-1 530-8000-40S S	SN11	1G Low Pass	Sep. 16, 2018	Jan. 23, 2019~ Feb. 19, 2019	Sep. 15, 2019	Radiation (03CH15-HY)



## 5 Uncertainty of Evaluation

### Uncertainty of Conducted Emission Measurement (150 kHz ~ 30 MHz)

Measuring Uncertainty for a Level of Confidence of 95% ( $U = 2Uc(y)$ )	2.2
---	-----

### Uncertainty of Radiated Emission Measurement (30 MHz ~ 1000 MHz)

Measuring Uncertainty for a Level of Confidence of 95% ( $U = 2Uc(y)$ )	5.2
---	-----

### Uncertainty of Radiated Emission Measurement (1000 MHz ~ 18000 MHz)

Measuring Uncertainty for a Level of Confidence of 95% ( $U = 2Uc(y)$ )	5.5
---	-----

### Uncertainty of Radiated Emission Measurement (18000 MHz ~ 40000 MHz)

Measuring Uncertainty for a Level of Confidence of 95% ( $U = 2Uc(y)$ )	5.2
---	-----



## Appendix A. AC Conducted Emission Test Results

Test Mode :	Mode 1	Temperature :	23~24°C
Test Engineer :	Rick Lin	Relative Humidity :	51~53%
Test Voltage :	120Vac / 60Hz	Phase :	Line

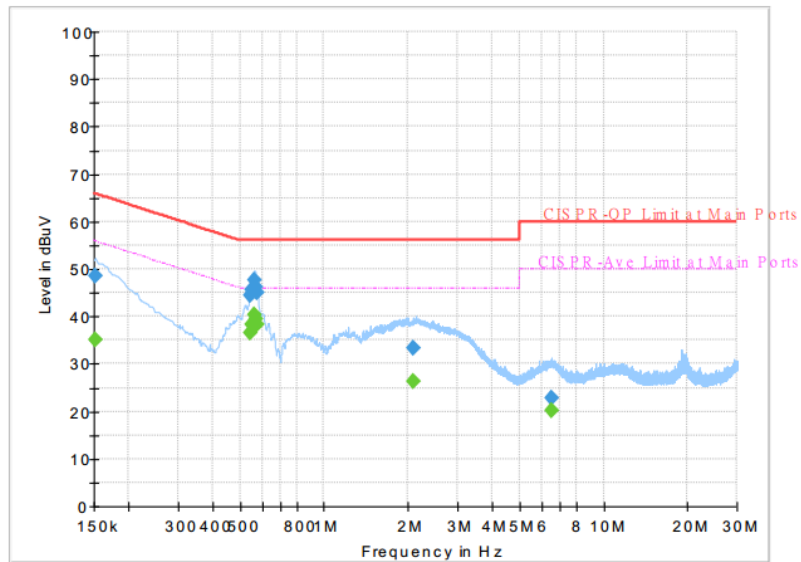

**Final Result :**

Frequency (MHz)	QuasiPeak (dBuV)	CAverage (dBuV)	Limit (dBuV)	Margin (dB)	Line	Filter	Corr. (dB)
0.152250	---	35.18	55.88	20.70	L1	OFF	19.5
0.152250	48.64	---	65.88	17.24	L1	OFF	19.5
0.546000	---	36.42	46.00	9.58	L1	OFF	19.5
0.546000	44.32	---	56.00	11.68	L1	OFF	19.5
0.550500	---	38.28	46.00	7.72	L1	OFF	19.5
0.550500	45.60	---	56.00	10.40	L1	OFF	19.5
0.564000	---	40.27	46.00	5.73	L1	OFF	19.5
0.564000	47.61	---	56.00	8.39	L1	OFF	19.5
0.570750	---	39.42	46.00	6.58	L1	OFF	19.5
0.570750	46.33	---	56.00	9.67	L1	OFF	19.5
0.575250	---	38.29	46.00	7.71	L1	OFF	19.5
0.575250	45.09	---	56.00	10.91	L1	OFF	19.5
2.080500	---	26.27	46.00	19.73	L1	OFF	19.4
2.080500	33.37	---	56.00	22.63	L1	OFF	19.4
6.492750	---	20.14	50.00	29.86	L1	OFF	19.6
6.492750	22.67	---	60.00	37.33	L1	OFF	19.6



Test Mode :	Mode 1	Temperature :	23~24°C
Test Engineer :	Rick Lin	Relative Humidity :	51~53%
Test Voltage :	120Vac / 60Hz	Phase :	Neutral

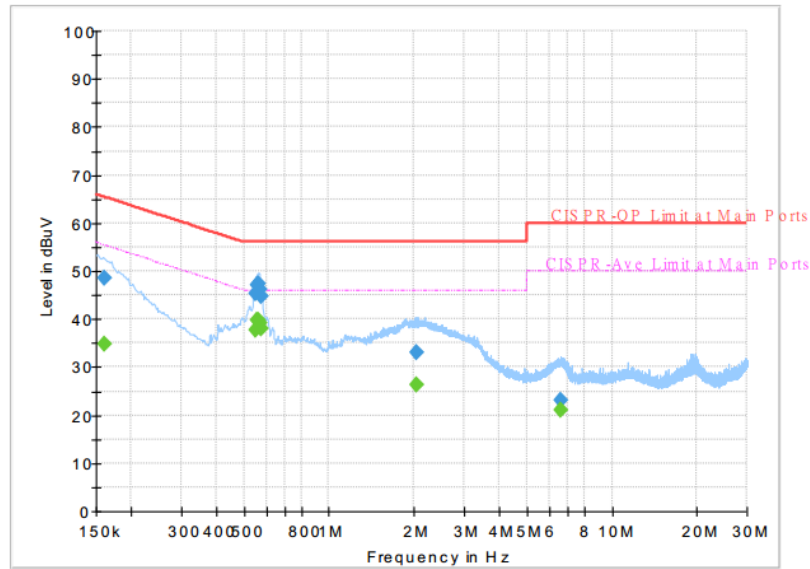

Final Result :

Frequency (MHz)	QuasiPeak (dBuV)	CAverage (dBuV)	Limit (dBuV)	Margin (dB)	Line	Filter	Corr. (dB)
0.161250	---	34.91	55.40	20.49	N	OFF	19.5
0.161250	48.51	---	65.40	16.89	N	OFF	19.5
0.548250	---	37.70	46.00	8.30	N	OFF	19.5
0.548250	45.32	---	56.00	10.68	N	OFF	19.5
0.557250	---	39.78	46.00	6.22	N	OFF	19.5
0.557250	47.01	---	56.00	8.99	N	OFF	19.5
0.564000	---	39.74	46.00	6.26	N	OFF	19.5
0.564000	47.24	---	56.00	8.76	N	OFF	19.5
0.570750	---	39.32	46.00	6.68	N	OFF	19.5
0.570750	46.30	---	56.00	9.70	N	OFF	19.5
0.575250	---	38.09	46.00	7.91	N	OFF	19.5
0.575250	44.82	---	56.00	11.18	N	OFF	19.5
2.037750	---	26.25	46.00	19.75	N	OFF	19.5
2.037750	33.16	---	56.00	22.84	N	OFF	19.5
6.609750	---	21.02	50.00	28.98	N	OFF	19.6
6.609750	23.09	---	60.00	36.91	N	OFF	19.6



## Appendix B. Radiated Spurious Emission

Test Engineer :	Watt Tseng, Karl Hou, and Bigshow Wang	Temperature :	23~26°C
		Relative Humidity :	50~57%

### 2.4GHz 2400~2483.5MHz

#### BLE 1Mbps (Band Edge @ 3m)

BLE	Note	Frequency	Level	Over	Limit	Read	Antenna	Path	Preamp	Ant	Table	Peak	Pol.	
		( MHz )	( dBμV/m )	( dB )	Limit	Line	Level	Factor	Loss	Factor	Pos	Pos	Avg.	
					( dBμV/m )	( dBμV )	( dB/m )	( dB )	( dB )	( cm )	( deg )	( P/A )	( H/V )	
BLE CH 00 2402MHz		2358.615	53.88	-20.12	74	41.36	27.67	15.73	30.88	394	308	P	H	
		2376.36	44.77	-9.23	54	32.25	27.63	15.75	30.86	394	308	A	H	
	*	2402	95.49	-	-	82.95	27.6	15.79	30.85	394	308	P	H	
	*	2402	94.85	-	-	82.31	27.6	15.79	30.85	394	308	A	H	
													H	
													H	
			2334.885	54.12	-19.88	74	41.62	27.7	15.69	30.89	349	341	P	V
			2326.38	44.61	-9.39	54	32.05	27.77	15.68	30.89	349	341	A	V
	*		2402	98.83	-	-	86.29	27.6	15.79	30.85	349	341	P	V
	*		2402	98.28	-	-	85.74	27.6	15.79	30.85	349	341	A	V
														V
														V
BLE CH 19 2440MHz		2333.1	53.64	-20.36	74	41.07	27.77	15.69	30.89	365	243	P	H	
		2371.74	44.67	-9.33	54	32.15	27.63	15.75	30.86	365	243	A	H	
	*	2440	95.33	-	-	82.72	27.6	15.85	30.84	365	243	P	H	
	*	2440	94.73	-	-	82.12	27.6	15.85	30.84	365	243	A	H	
			2486.98	52.68	-21.32	74	40.12	27.47	15.91	30.82	365	243	P	H
			2484.04	44.41	-9.59	54	31.85	27.47	15.91	30.82	365	243	A	H
			2337.58	53.77	-20.23	74	41.26	27.7	15.7	30.89	338	343	P	V
			2319.38	44.6	-9.4	54	32.05	27.77	15.67	30.89	338	343	A	V
	*		2440	98.29	-	-	85.68	27.6	15.85	30.84	338	343	P	V
	*		2440	97.73	-	-	85.12	27.6	15.85	30.84	338	343	A	V
			2487.12	53.12	-20.88	74	40.56	27.47	15.91	30.82	338	343	P	V
			2492.65	44.44	-9.56	54	31.93	27.4	15.92	30.81	338	343	A	V



<b>BLE CH 39 2480MHz</b>	*	2480	96.27	-	-	83.72	27.47	15.9	30.82	318	243	P	H
	*	2480	95.75	-	-	83.2	27.47	15.9	30.82	318	243	A	H
		2493.92	53.27	-20.73	74	40.76	27.4	15.92	30.81	318	243	P	H
		2487.04	44.38	-9.62	54	31.82	27.47	15.91	30.82	318	243	A	H
													H
													H
	*	2480	99.77	-	-	87.22	27.47	15.9	30.82	367	333	P	V
	*	2480	99.24	-	-	86.69	27.47	15.9	30.82	367	333	A	V
		2497.68	53.3	-20.7	74	40.78	27.4	15.93	30.81	367	333	P	V
		2487.52	44.61	-9.39	54	32.12	27.4	15.91	30.82	367	333	A	V
													V
													V
<b>Remark</b>	1. No other spurious found. 2. All results are PASS against Peak and Average limit line.												



**2.4GHz 2400~2483.5MHz  
BLE 1Mbps (Harmonic @ 3m)**

BLE	Note	Frequency ( MHz )	Level ( dBµV/m )	Over Limit ( dB )	Limit Line ( dBµV/m )	Read Level ( dBµV )	Antenna Factor ( dB/m )	Path Loss ( dB )	Preamp Factor ( dB )	Ant Pos ( cm )	Table Pos ( deg )	Peak Avg. ( P/A )	Pol. ( H/V )
BLE CH 00 2402MHz		4804	39.63	-34.37	74	57.93	31.3	8.44	58.04	100	0	P	H
													H
													H
													H
		4804	39.97	-34.03	74	58.27	31.3	8.44	58.04	100	0	P	V
													V
													V
BLE CH 19 2440MHz		4880	39.8	-34.2	74	57.93	31.3	8.67	58.1	100	0	P	H
		7320	44.03	-29.97	74	54.87	36.23	11.27	58.34	100	0	P	H
													H
													H
		4880	39.71	-34.29	74	57.84	31.3	8.67	58.1	100	0	P	V
		7320	43.98	-30.02	74	54.82	36.23	11.27	58.34	100	0	P	V
													V
BLE CH 39 2480MHz		4960	40.42	-33.58	74	58.22	31.47	8.9	58.17	100	0	P	H
		7440	44.5	-29.5	74	54.88	36.6	11.33	58.31	100	0	P	H
													H
													H
		4960	40.18	-33.82	74	57.98	31.47	8.9	58.17	100	0	P	V
		7440	45.75	-28.25	74	56.13	36.6	11.33	58.31	100	0	P	V
													V
Remark	1. No other spurious found.												
	2. All results are PASS against Peak and Average limit line.												



Emission below 1GHz

2.4GHz BLE 1Mbps (LF)

BLE	Note	Frequency	Level	Over	Limit	Read	Antenna	Path	Preamp	Ant	Table	Peak	Pol.	
		( MHz )	( dBμV/m )	( dB )	( dBμV/m )	( dBμV )	( dB/m )	( dB )	( dB )	( cm )	( deg )	( P/A )	( H/V )	
2.4GHz BLE LF		78.6	35.6	-4.4	40	53.78	13.2	1.07	32.54	-	-	P	H	
		118.02	39.5	-4	43.5	53.27	17.37	1.3	32.51	100	0	P	H	
		135.57	37.57	-5.93	43.5	51.16	17.43	1.4	32.5	-	-	P	H	
		498.1	37.98	-8.02	46	43.89	23.92	2.63	32.57	-	-	P	H	
		568.8	36.6	-9.4	46	40.29	25.91	2.82	32.59	-	-	P	H	
		710.9	32.1	-13.9	46	34.39	26.83	3.14	32.38	-	-	P	H	
														H
														H
														H
														H
														H
														H
			37.02	35.82	-4.18	40	46.81	20.86	0.75	32.61	100	0	P	V
			121.26	33.1	-10.4	43.5	46.71	17.52	1.32	32.51	-	-	P	V
			138.27	34.34	-9.16	43.5	47.92	17.42	1.41	32.5	-	-	P	V
			497.4	36.88	-9.12	46	42.81	23.9	2.63	32.57	-	-	P	V
			568.8	38.39	-7.61	46	42.08	25.91	2.82	32.59	-	-	P	V
			640.2	31.28	-14.72	46	34.45	26.22	2.97	32.52	-	-	P	V
														V
														V
													V	
													V	
													V	
													V	
Remark	1. No other spurious found. 2. All results are PASS against limit line.													





2.4GHz 2400~2483.5MHz

BLE 2Mbps (Band Edge @ 3m)

BLE	Note	Frequency	Level	Over	Limit	Read	Antenna	Path	Preamp	Ant	Table	Peak	Pol.	
		( MHz )	( dBμV/m )	( dB )	( dBμV/m )	( dBμV )	( dB/m )	( dB )	( dB )	( cm )	( deg )	( P/A )	( H/V )	
BLE CH 00 2402MHz		2352.945	53.77	-20.23	74	41.26	27.67	15.72	30.88	348	308	P	H	
		2358.195	46.47	-7.53	54	33.95	27.67	15.73	30.88	348	308	A	H	
	*	2402	95.42	-	-	82.88	27.6	15.79	30.85	348	308	P	H	
	*	2402	94.18	-	-	81.64	27.6	15.79	30.85	348	308	A	H	
													H	
													H	
			2363.76	54.07	-19.93	74	41.54	27.67	15.74	30.88	393	342	P	V
			2334.99	46.22	-7.78	54	33.72	27.7	15.69	30.89	393	342	A	V
	*		2402	97.69	-	-	85.15	27.6	15.79	30.85	393	342	P	V
	*		2402	96.48	-	-	83.94	27.6	15.79	30.85	393	342	A	V
													V	
													V	
BLE CH 19 2440MHz		2313.08	53.45	-20.55	74	40.86	27.83	15.66	30.9	324	242	P	H	
		2318.54	46.39	-7.61	54	33.84	27.77	15.67	30.89	324	242	A	H	
	*	2440	96.35	-	-	83.74	27.6	15.85	30.84	324	242	P	H	
	*	2440	94.66	-	-	82.05	27.6	15.85	30.84	324	242	A	H	
			2488.73	53.18	-20.82	74	40.69	27.4	15.91	30.82	324	242	P	H
			2489.71	46.06	-7.94	54	33.56	27.4	15.92	30.82	324	242	A	H
			2310.98	53.36	-20.64	74	40.77	27.83	15.66	30.9	343	340	P	V
			2310.7	46.67	-7.33	54	34.08	27.83	15.66	30.9	343	340	A	V
	*		2440	97.1	-	-	84.49	27.6	15.85	30.84	343	340	P	V
	*		2440	95.96	-	-	83.35	27.6	15.85	30.84	343	340	A	V
			2489.29	53.83	-20.17	74	41.33	27.4	15.92	30.82	343	340	P	V
			2490.41	45.74	-8.26	54	33.24	27.4	15.92	30.82	343	340	A	V



<b>BLE CH 39 2480MHz</b>	*	2480	95.43	-	-	82.88	27.47	15.9	30.82	391	251	P	H
	*	2480	94.15	-	-	81.6	27.47	15.9	30.82	391	251	A	H
		2498.68	53.51	-20.49	74	40.99	27.4	15.93	30.81	391	251	P	H
		2493.12	45.89	-8.11	54	33.38	27.4	15.92	30.81	391	251	A	H
													H
													H
	*	2480	99.24	-	-	86.69	27.47	15.9	30.82	371	328	P	V
	*	2480	97.92	-	-	85.37	27.47	15.9	30.82	371	328	A	V
		2494.08	54.48	-19.52	74	41.97	27.4	15.92	30.81	371	328	P	V
		2497.92	45.96	-8.04	54	33.44	27.4	15.93	30.81	371	328	A	V
													V
													V
<b>Remark</b>	1. No other spurious found. 2. All results are PASS against Peak and Average limit line.												



**2.4GHz 2400~2483.5MHz  
BLE 2Mbps (Harmonic @ 3m)**

BLE	Note	Frequency ( MHz )	Level ( dBµV/m )	Over Limit ( dB )	Limit Line ( dBµV/m )	Read Level ( dBµV )	Antenna Factor ( dB/m )	Path Loss ( dB )	Preamp Factor ( dB )	Ant Pos ( cm )	Table Pos ( deg )	Peak Avg. ( P/A )	Pol. ( H/V )
BLE CH 00 2402MHz		4804	39.38	-34.62	74	57.68	31.3	8.44	58.04	100	0	P	H
													H
													H
													H
		4804	38.87	-35.13	74	57.17	31.3	8.44	58.04	100	0	P	V
													V
													V
BLE CH 19 2440MHz		4880	39.27	-34.73	74	57.4	31.3	8.67	58.1	100	0	P	H
		7320	45.92	-28.08	74	56.76	36.23	11.27	58.34	100	0	P	H
													H
													H
		4880	39.13	-34.87	74	57.26	31.3	8.67	58.1	100	0	P	V
		7320	43.38	-30.62	74	54.22	36.23	11.27	58.34	100	0	P	V
													V
BLE CH 39 2480MHz		4960	39.53	-34.47	74	57.33	31.47	8.9	58.17	100	0	P	H
		7440	43.95	-30.05	74	54.33	36.6	11.33	58.31	100	0	P	H
													H
													H
		4960	40.35	-33.65	74	58.15	31.47	8.9	58.17	100	0	P	V
		7440	44.02	-29.98	74	54.4	36.6	11.33	58.31	100	0	P	V
													V
Remark	1. No other spurious found. 2. All results are PASS against Peak and Average limit line.												



Emission below 1GHz

2.4GHz BLE 2Mbps (LF)

BLE	Note	Frequency	Level	Over	Limit	Read	Antenna	Path	Preamp	Ant	Table	Peak	Pol.	
		( MHz )	( dBμV/m )	( dB )	( dBμV/m )	( dBμV )	( dB/m )	( dB )	( dB )	( cm )	( deg )	( P/A )	( H/V )	
2.4GHz BLE LF		79.14	35.1	-4.9	40	53.2	13.28	1.07	32.54	-	-	P	H	
		118.83	39.58	-3.92	43.5	53.27	17.45	1.3	32.51	100	0	P	H	
		136.92	37.7	-5.8	43.5	51.29	17.43	1.4	32.5	-	-	P	H	
		329.4	31.15	-14.85	46	41.71	19.76	2.15	32.54	-	-	P	H	
		498.1	38.21	-7.79	46	44.12	23.92	2.63	32.57	-	-	P	H	
		568.8	37.32	-8.68	46	41.01	25.91	2.82	32.59	-	-	P	H	
														H
														H
														H
														H
														H
														H
			37.02	34.06	-5.94	40	45.05	20.86	0.75	32.61	100	0	P	V
			122.34	32.72	-10.78	43.5	46.33	17.52	1.32	32.51	-	-	P	V
			135.84	34.12	-9.38	43.5	47.71	17.43	1.4	32.5	-	-	P	V
			498.1	37.18	-8.82	46	43.09	23.92	2.63	32.57	-	-	P	V
			568.8	37.78	-8.22	46	41.47	25.91	2.82	32.59	-	-	P	V
			640.2	31.87	-14.13	46	35.04	26.22	2.97	32.52	-	-	P	V
														V
														V
													V	
													V	
													V	
													V	
Remark	1. No other spurious found. 2. All results are PASS against limit line.													



**Note symbol**

*	<b>Fundamental Frequency</b> which can be ignored. However, the level of any unwanted emissions shall not exceed the level of the fundamental frequency.
!	Test result is <b>over limit</b> line.
P/A	<b>Peak</b> or <b>Average</b>
H/V	<b>Horizontal</b> or <b>Vertical</b>



A calculation example for radiated spurious emission is shown as below:

BLE	Note	Frequency	Level	Over	Limit	Read	Antenna	Path	Preamp	Ant	Table	Peak	Pol.
		( MHz )	( dBμV/m )	( dB )	( dBμV/m )	( dBμV )	( dB/m )	( dB )	( dB )	( cm )	( deg )	( P/A )	( H/V )
BLE CH 00 2402MHz		2390	55.45	-18.55	74	54.51	32.22	4.58	35.86	103	308	P	H
		2390	43.54	-10.46	54	42.6	32.22	4.58	35.86	103	308	A	H

1. Path Loss(dB) = Cable loss(dB) + Filter loss(dB) + Attenuator loss(dB)
2. Level(dBμV/m) =  
Antenna Factor(dB/m) + Path Loss(dB) + Read Level(dBμV) - Preamp Factor(dB)
3. Over Limit(dB) = Level(dBμV/m) – Limit Line(dBμV/m)

**For Peak Limit @ 2390MHz:**

1. Level(dBμV/m)  
= Antenna Factor(dB/m) + Path Loss(dB) + Read Level(dBμV) - Preamp Factor(dB)  
= 32.22(dB/m) + 4.58(dB) + 54.51(dBμV) – 35.86 (dB)  
= 55.45 (dBμV/m)
2. Over Limit(dB)  
= Level(dBμV/m) – Limit Line(dBμV/m)  
= 55.45(dBμV/m) – 74(dBμV/m)  
= -18.55(dB)

**For Average Limit @ 2390MHz:**

1. Level(dBμV/m)  
= Antenna Factor(dB/m) + Path Loss(dB) + Read Level(dBμV) - Preamp Factor(dB)  
= 32.22(dB/m) + 4.58(dB) + 42.6(dBμV) – 35.86 (dB)  
= 43.54 (dBμV/m)
2. Over Limit(dB)  
= Level(dBμV/m) – Limit Line(dBμV/m)  
= 43.54(dBμV/m) – 54(dBμV/m)  
= -10.46(dB)

**Both peak and average measured complies with the limit line, so test result is “PASS”.**



## Appendix C. Radiated Spurious Emission Plots

Test Engineer :	Watt Tseng, Karl Hou, and Bigshow Wang	Temperature :	23~26°C
		Relative Humidity :	50~57%

**Note symbol**

-L	Low channel location
-R	High channel location



2.4GHz 2400~2483.5MHz

BLE 1Mbps (Band Edge @ 3m)

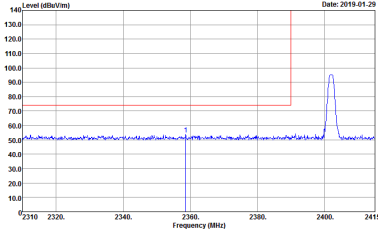
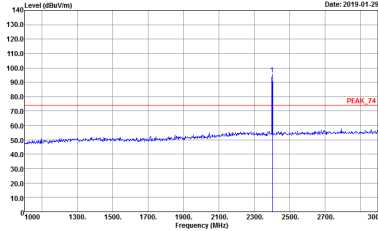
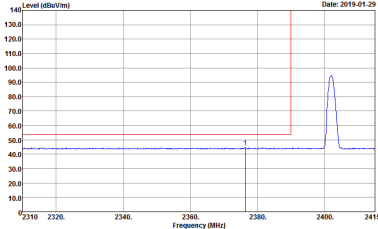
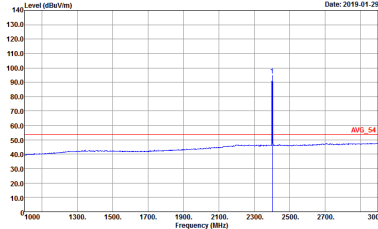
BLE	2.4GHz 2400~2483.5MHz Band Edge @ 3m	
BLE CH00 2402MHz		
	Horizontal	Fundamental
Peak	 <p>Site : 03CH15-HY            Condition : PEAK_BE_74 3m 91200_15_1620 HORIZONTAL            Detector : Peak            Project : 911104            Mode : 4</p>	 <p>Site : 03CH15-HY            Condition : PEAK_74 3m 91200_15_1620 HORIZONTAL            Detector : Peak            Project : 911104            Mode : 4</p>
Avg.	 <p>Site : 03CH15-HY            Condition : AVG_BE_54 3m 91200_15_1620 HORIZONTAL            Detector : Peak            Project : 911104            Mode : 4</p>	 <p>Site : 03CH15-HY            Condition : AVG_54 3m 91200_15_1620 HORIZONTAL            Detector : Peak            Project : 911104            Mode : 4</p>



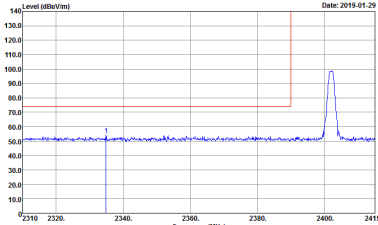
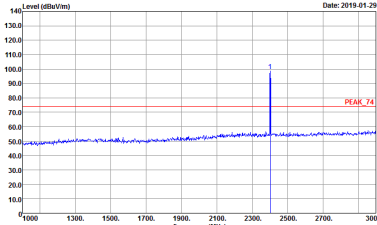
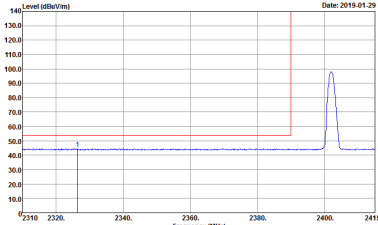
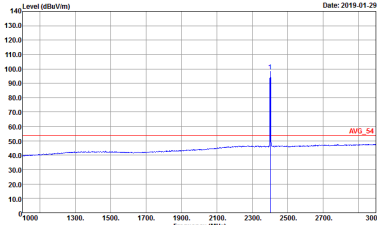

BLE	2.4GHz 2400~2483.5MHz Band Edge @ 3m	
BLE CH00 2402MHz		
Vertical		Fundamental
Peak	 <p>Site : 03CH15-HY            Condition : PEAK_BE_74 3m 91200_15_1620 VERTICAL            RBW:1000.000kHz VBW:3000.000kHz SWT:Auto            Detector : Peak            Project : 911104            Mode : 4</p>	 <p>Site : 03CH15-HY            Condition : PEAK_74 3m 91200_15_1620 VERTICAL            RBW:1000.000kHz VBW:3000.000kHz SWT:Auto            Detector : Peak            Project : 911104            Mode : 4</p>
	 <p>Site : 03CH15-HY            Condition : AVG_BE_54 3m 91200_15_1620 VERTICAL            RBW:1000.000kHz VBW:3.000kHz SWT:Auto            Detector : Peak            Project : 911104            Mode : 4</p>	 <p>Site : 03CH15-HY            Condition : AVG_54 3m 91200_15_1620 VERTICAL            RBW:1000.000kHz VBW:3.000kHz SWT:Auto            Detector : Peak            Project : 911104            Mode : 4</p>
Avg		

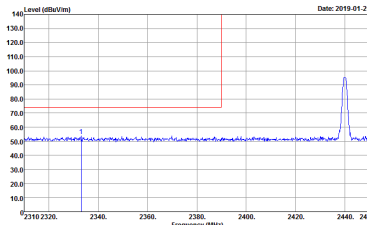
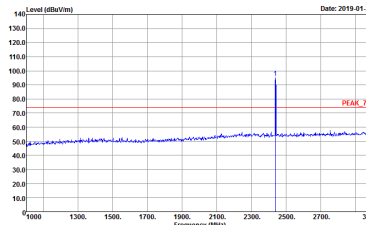
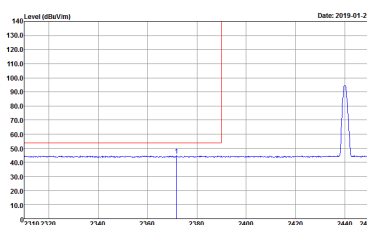
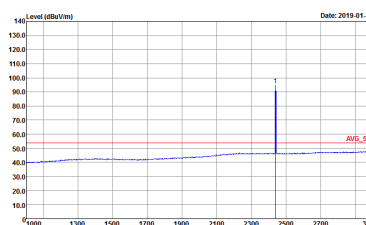

BLE	2.4GHz 2400~2483.5MHz Band Edge @ 3m	
	BLE CH19 2440MHz - L	
	Horizontal	Fundamental
Peak	 <p>Level (dBm/1m) vs Frequency (MHz) plot for Peak. The plot shows a sharp peak at approximately 2440 MHz. The y-axis ranges from 10.0 to 140.0 dBm/1m, and the x-axis ranges from 2310 to 2450 MHz. A red horizontal line is drawn at approximately 75 dBm/1m.</p> <p>Site : 03CH15-HV            Condition : PEAK_BE_74 3m 91200_15_1620 HORIZONTAL            Detector : Peak            Project : 911104            Mode : 5</p>	 <p>Level (dBm/1m) vs Frequency (MHz) plot for Fundamental. The plot shows a sharp peak at approximately 2440 MHz. The y-axis ranges from 10.0 to 140.0 dBm/1m, and the x-axis ranges from 1000 to 3000 MHz. A red horizontal line is drawn at approximately 75 dBm/1m, labeled 'PEAK_74'.</p> <p>Site : 03CH15-HV            Condition : PEAK_74 3m 91200_15_1620 HORIZONTAL            Detector : Peak            Project : 911104            Mode : 5</p>
Avg.	 <p>Level (dBm/1m) vs Frequency (MHz) plot for Avg. The plot shows a sharp peak at approximately 2440 MHz. The y-axis ranges from 10.0 to 140.0 dBm/1m, and the x-axis ranges from 2310 to 2450 MHz. A red horizontal line is drawn at approximately 75 dBm/1m.</p> <p>Site : 03CH15-HV            Condition : AVG_BE_54 3m 91200_15_1620 HORIZONTAL            Detector : Peak            Project : 911104            Mode : 5</p>	 <p>Level (dBm/1m) vs Frequency (MHz) plot for Fundamental. The plot shows a sharp peak at approximately 2440 MHz. The y-axis ranges from 10.0 to 140.0 dBm/1m, and the x-axis ranges from 1000 to 3000 MHz. A red horizontal line is drawn at approximately 75 dBm/1m, labeled 'AVG_54'.</p> <p>Site : 03CH15-HV            Condition : AVG_54 3m 91200_15_1620 HORIZONTAL            Detector : Peak            Project : 911104            Mode : 5</p>

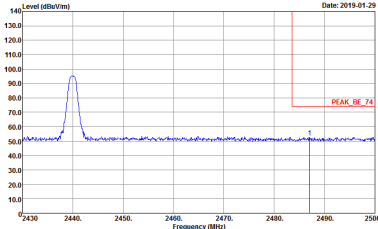
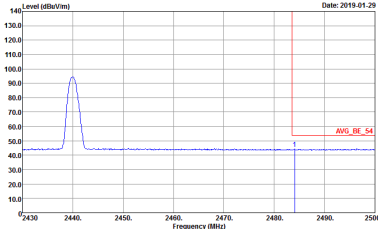

BLE	2.4GHz 2400~2483.5MHz Band Edge @ 3m	
BLE CH19 2440MHz - R		
	Horizontal	Fundamental
<p><b>Peak</b></p>	 <p>Site : 03CH15-HY            Condition : PEAK_BE_74 3m 91200_15_1620 HORIZONTAL            RBW:1000.000kHz VBW:3000.000kHz SWF:Auto            Detector : Peak            Project : 911104            Mode : 5</p>	<p><b>Left blank</b></p>
<p><b>Avg.</b></p>	 <p>Site : 03CH15-HY            Condition : AVG_BE_54 3m 91200_15_1620 HORIZONTAL            RBW:1000.000kHz VBW:3.000kHz SWF:Auto            Detector : Peak            Project : 911104            Mode : 5</p>	<p><b>Left blank</b></p>

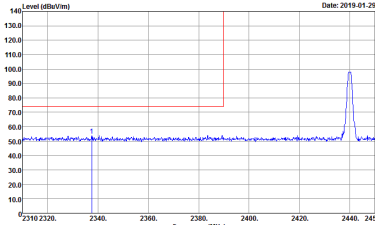
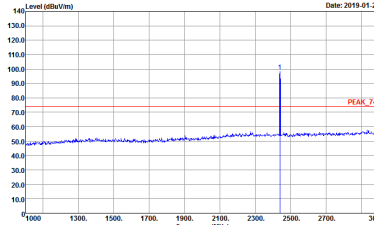
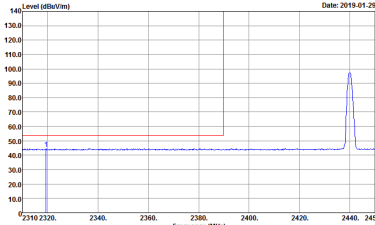
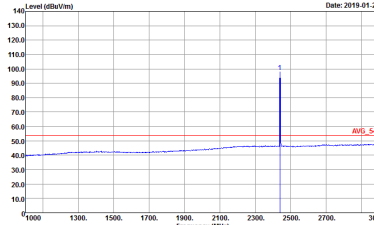

BLE	2.4GHz 2400~2483.5MHz Band Edge @ 3m	
BLE CH19 2440MHz - L		
	Vertical	Fundamental
Peak	 <p>Date: 2019-01-29</p> <p>Site : 03CH15-HY            Condition : PEAK_8E_74 3m 91200_15_1620 VERTICAL            RBW:1000.000KHz VBW:3000.000KHz SWT:Auto            Detector : Peak            Project : 911104            Mode : 5</p>	 <p>Date: 2019-01-29</p> <p>Site : 03CH15-HY            Condition : PEAK_74 3m 91200_15_1620 VERTICAL            RBW:1000.000KHz VBW:3000.000KHz SWT:Auto            Detector : Peak            Project : 911104            Mode : 5</p>
Avg.	 <p>Date: 2019-01-29</p> <p>Site : 03CH15-HY            Condition : AVG_8E_54 3m 91200_15_1620 VERTICAL            RBW:1000.000KHz VBW:3.000KHz SWT:Auto            Detector : Peak            Project : 911104            Mode : 5</p>	 <p>Date: 2019-01-29</p> <p>Site : 03CH15-HY            Condition : AVG_54 3m 91200_15_1620 VERTICAL            RBW:1000.000KHz VBW:3.000KHz SWT:Auto            Detector : Peak            Project : 911104            Mode : 5</p>

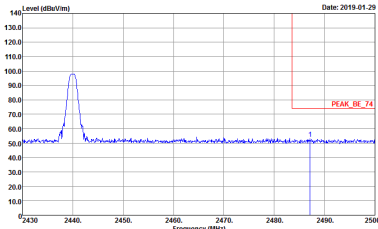
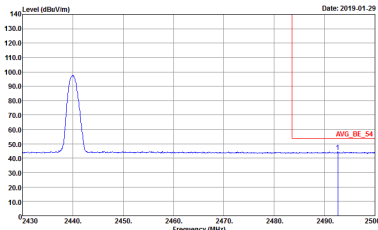

BLE	2.4GHz 2400~2483.5MHz Band Edge @ 3m	
BLE CH19 2440MHz - R		
	Vertical	Fundamental
<p><b>Peak</b></p>	 <p>Date: 2019-01-29</p> <p>Site : 03CH15-HY            Condition : PEAK_BE_74 3m 91200_15_1620 VERTICAL            RBW:1000.000KHz VBW:3000.000KHz SWF:Auto            Detector : Peak            Project : 911104            Mode : 5</p>	<p><b>Left blank</b></p>
<p><b>Avg.</b></p>	 <p>Date: 2019-01-29</p> <p>Site : 03CH15-HY            Condition : AVG_BE_54 3m 91200_15_1620 VERTICAL            RBW:1000.000KHz VBW:3.000KHz SWF:Auto            Detector : Peak            Project : 911104            Mode : 5</p>	<p><b>Left blank</b></p>



BLE	2.4GHz 2400~2483.5MHz Band Edge @ 3m	
BLE CH39 2480MHz		
	Horizontal	Fundamental
<p><b>Peak</b></p>	<p>Site : 03CH15-HY            Condition : PEAK_BE_74 3m 91200_15_1620 HORIZONTAL            RBW:1000.000KHz VBW:3000.000KHz SWT:Auto            Detector : Peak            Project : 911104            Mode : 6</p>	<p>Site : 03CH15-HY            Condition : PEAK_74 3m 91200_15_1620 HORIZONTAL            RBW:1000.000KHz VBW:3000.000KHz SWT:Auto            Detector : Peak            Project : 911104            Mode : 6</p>
<p><b>Avg.</b></p>	<p>Site : 03CH15-HY            Condition : AVG_BE_54 3m 91200_15_1620 HORIZONTAL            RBW:1000.000KHz VBW:3.000KHz SWT:Auto            Detector : Peak            Project : 911104            Mode : 6</p>	<p>Site : 03CH15-HY            Condition : AVG_54 3m 91200_15_1620 HORIZONTAL            RBW:1000.000KHz VBW:3.000KHz SWT:Auto            Detector : Peak            Project : 911104            Mode : 6</p>

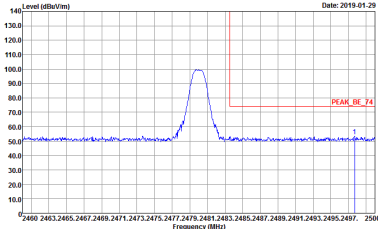
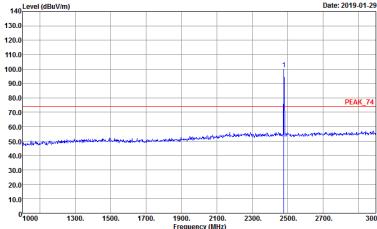
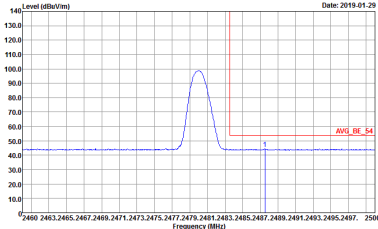
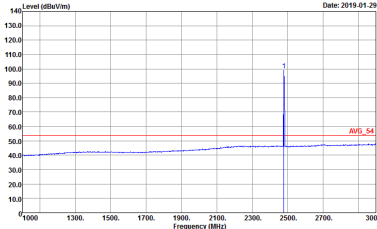

BLE	2.4GHz 2400~2483.5MHz Band Edge @ 3m	
BLE CH39 2480MHz		
	Vertical	Fundamental
<p><b>Peak</b></p>	 <p>Site : 03CH15-HY            Condition : PEAK_BE_74 3m 91200_15_1620 VERTICAL            RBW:1000.000KHz VBW:3000.000KHz SWT:Auto            Detector : Peak            Project : 911104            Mode : 6</p>	 <p>Site : 03CH15-HY            Condition : PEAK_74 3m 91200_15_1620 VERTICAL            RBW:1000.000KHz VBW:3000.000KHz SWT:Auto            Detector : Peak            Project : 911104            Mode : 6</p>
<p><b>Avg.</b></p>	 <p>Site : 03CH15-HY            Condition : AVG_BE_54 3m 91200_15_1620 VERTICAL            RBW:1000.000KHz VBW:3.000KHz SWT:Auto            Detector : Peak            Project : 911104            Mode : 6</p>	 <p>Site : 03CH15-HY            Condition : AVG_54 3m 91200_15_1620 VERTICAL            RBW:1000.000KHz VBW:3.000KHz SWT:Auto            Detector : Peak            Project : 911104            Mode : 6</p>



2.4GHz 2400~2483.5MHz

BLE 1Mbps (Harmonic @ 3m)

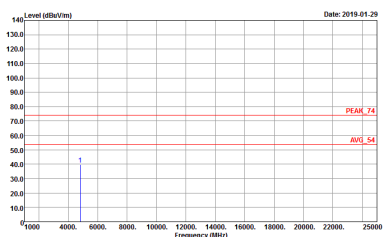
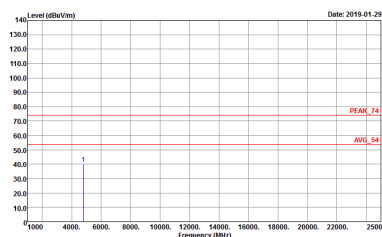
BLE	2.4GHz 2400~2483.5MHz Harmonic @ 3m	
	BLE CH00 2402MHz	
	Horizontal	Vertical
<p><b>Peak</b></p> <p><b>Avg.</b></p>	 <p>Site : 03CH15-1FY  Condition : PEAK_74 3m 91200_15_1620 HORIZONTAL  Detector : Peak  Project : 911104  Mode : 4</p>	 <p>Site : 03CH15-1FY  Condition : PEAK_74 3m 91200_15_1620 VERTICAL  Detector : Peak  Project : 911104  Mode : 4</p>





BLE	2.4GHz 2400~2483.5MHz Harmonic @ 3m	
	BLE CH19 2440MHz	
	Horizontal	Vertical
<b>Peak</b> <b>Avg.</b>	<p>Site : 03CH15-HY Condition : PEAK_74 3m 91200_15_1620 HORIZONTAL Detector : Peak Project : 911104 Mode : S</p>	<p>Site : 03CH15-HY Condition : PEAK_74 3m 91200_15_1620 VERTICAL Detector : Peak Project : 911104 Mode : S</p>



BLE	2.4GHz 2400~2483.5MHz Harmonic @ 3m	
	BLE CH39 2480MHz	
	Horizontal	Vertical
Peak	<p>Site : 03CH15-HY Condition : PEAK_74 3m 91200_15_1620 HORIZONTAL Detector : Peak Project : 911104 Mode : G</p>	<p>Site : 03CH15-HY Condition : PEAK_74 3m 91200_15_1620 VERTICAL Detector : Peak Project : 911104 Mode : G</p>



Emission below 1GHz  
2.4GHz BLE 1Mbps (LF)

BLE	2.4GHz 2400~2483.5MHz	
	BLE LF	
	Horizontal	Vertical
QP / Peak	<p>Site : 03CH15-HY Condition : QP 3m BTL0G_16_47020 HORIZONTAL Detector : Peak Project : 911104 Mode : S3</p>	<p>Site : 03CH15-HY Condition : QP 3m BTL0G_16_47020 VERTICAL Detector : Peak Project : 911104 Mode : S3</p>



2.4GHz 2400~2483.5MHz

BLE 2Mbps (Band Edge @ 3m)

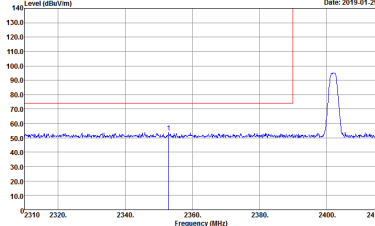
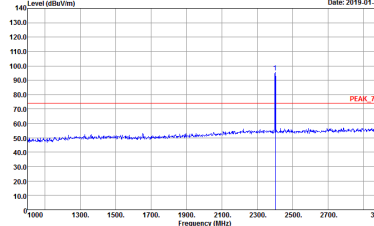
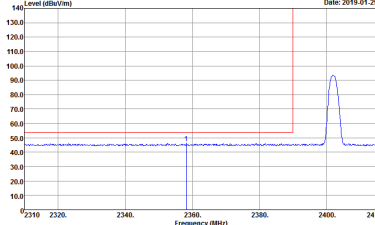
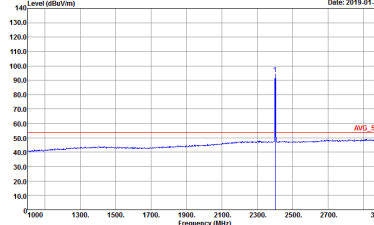
BLE	2.4GHz 2400~2483.5MHz Band Edge @ 3m	
BLE CH00 2402MHz		
	Horizontal	Fundamental
Peak	 <p>Site : 03CH15-HY            Condition : PEAK_BE_74 3m 91200_15_1620 HORIZONTAL            Detector : Peak            Project : 911104            Mode : 7</p>	 <p>Site : 03CH15-HY            Condition : PEAK_74 3m 91200_15_1620 HORIZONTAL            Detector : Peak            Project : 911104            Mode : 7</p>
Avg.	 <p>Site : 03CH15-HY            Condition : AVG_BE_54 3m 91200_15_1620 HORIZONTAL            Detector : Peak            Project : 911104            Mode : 7</p>	 <p>Site : 03CH15-HY            Condition : AVG_54 3m 91200_15_1620 HORIZONTAL            Detector : Peak            Project : 911104            Mode : 7</p>

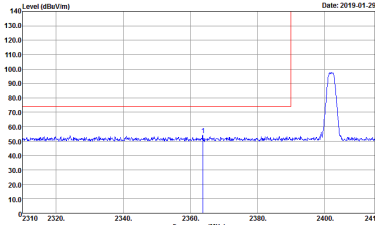
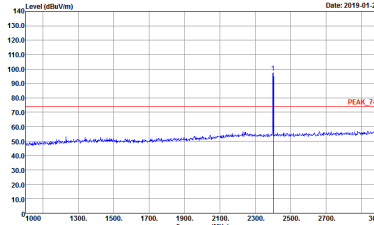
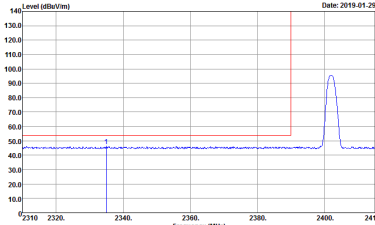
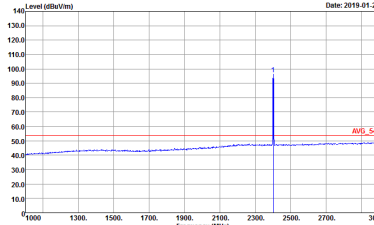

BLE	2.4GHz 2400~2483.5MHz Band Edge @ 3m	
BLE CH00 2402MHz		
	Vertical	Fundamental
Peak	 <p>Site : 03CH15-HY            Condition : PEAK_BE_74 3m 91200_15_1620 VERTICAL            : RBW:1000.000KHz VBW:3000.000KHz SWT:Auto            Detector : Peak            Project : 911104            Mode : 7</p>	 <p>Site : 03CH15-HY            Condition : PEAK_74 3m 91200_15_1620 VERTICAL            : RBW:1000.000KHz VBW:3000.000KHz SWT:Auto            Detector : Peak            Project : 911104            Mode : 7</p>
Avg	 <p>Site : 03CH15-HY            Condition : AVG_BE_54 3m 91200_15_1620 VERTICAL            : RBW:1000.000KHz VBW:10.000KHz SWT:Auto            Detector : Peak            Project : 911104            Mode : 7</p>	 <p>Site : 03CH15-HY            Condition : AVG_54 3m 91200_15_1620 VERTICAL            : RBW:1000.000KHz VBW:10.000KHz SWT:Auto            Detector : Peak            Project : 911104            Mode : 7</p>

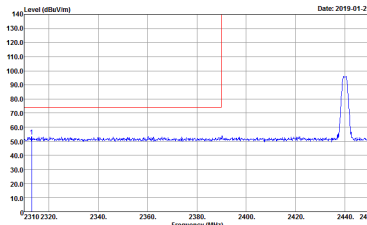
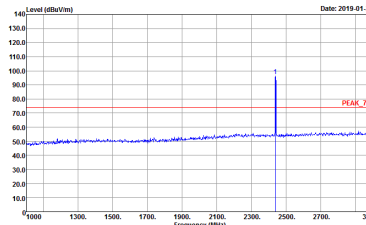
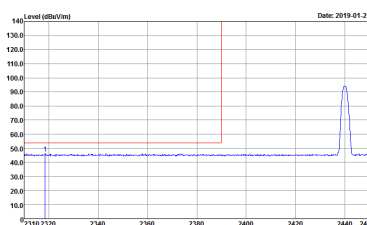
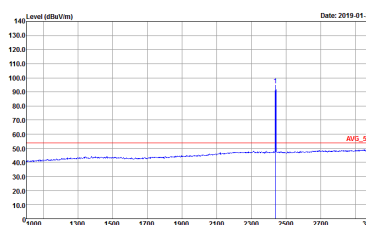

BLE	2.4GHz 2400~2483.5MHz Band Edge @ 3m	
	BLE CH19 2440MHz - L	
	Horizontal	Fundamental
Peak	 <p>Level (dBm/1m) vs Frequency (MHz) plot for Horizontal Peak. The plot shows a sharp peak at approximately 2440 MHz. The y-axis ranges from 10.0 to 140.0 dBm/1m, and the x-axis ranges from 2310 to 2450 MHz. A red horizontal line is drawn at approximately 75 dBm/1m.</p> <p>Site : 03CH15-HV            Condition : PEAK_BE_74 3m 91200_15_1620 HORIZONTAL            : RBW:1000.000KHz VBW:3000.000KHz SWT:Auto            Detector : Peak            Project : 911104            Mode : 8</p>	 <p>Level (dBm/1m) vs Frequency (MHz) plot for Fundamental Peak. The plot shows a sharp peak at approximately 2440 MHz. The y-axis ranges from 10.0 to 140.0 dBm/1m, and the x-axis ranges from 1000 to 3000 MHz. A red horizontal line is drawn at approximately 75 dBm/1m, labeled 'PEAK_74'.</p> <p>Site : 03CH15-HV            Condition : PEAK_74 3m 91200_15_1620 HORIZONTAL            : RBW:1000.000KHz VBW:3000.000KHz SWT:Auto            Detector : Peak            Project : 911104            Mode : 8</p>
Avg.	 <p>Level (dBm/1m) vs Frequency (MHz) plot for Horizontal Avg. The plot shows a sharp peak at approximately 2440 MHz. The y-axis ranges from 10.0 to 140.0 dBm/1m, and the x-axis ranges from 2310 to 2450 MHz. A red horizontal line is drawn at approximately 75 dBm/1m.</p> <p>Site : 03CH15-HV            Condition : AVG_BE_54 3m 91200_15_1620 HORIZONTAL            : RBW:1000.000KHz VBW:10.000KHz SWT:Auto            Detector : Peak            Project : 911104            Mode : 8</p>	 <p>Level (dBm/1m) vs Frequency (MHz) plot for Fundamental Avg. The plot shows a sharp peak at approximately 2440 MHz. The y-axis ranges from 10.0 to 140.0 dBm/1m, and the x-axis ranges from 1000 to 3000 MHz. A red horizontal line is drawn at approximately 75 dBm/1m, labeled 'AVG_54'.</p> <p>Site : 03CH15-HV            Condition : AVG_54 3m 91200_15_1620 HORIZONTAL            : RBW:1000.000KHz VBW:10.000KHz SWT:Auto            Detector : Peak            Project : 911104            Mode : 8</p>

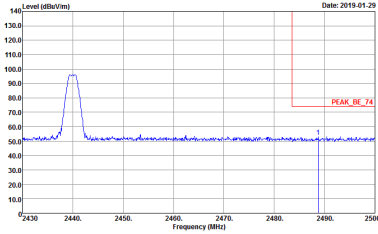
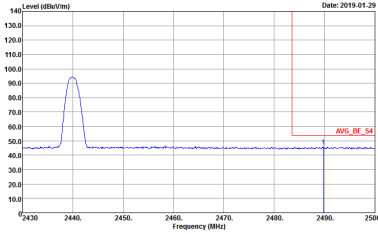

BLE	2.4GHz 2400~2483.5MHz Band Edge @ 3m	
BLE CH19 2440MHz - R		
Horizontal		Fundamental
<p><b>Peak</b></p>	 <p>Site : 03CH15-HY            Condition : PEAK_BE_74 3m 91200_15_1620 HORIZONTAL            : RBW:1000.000KHz VBW:3000.000KHz SWT:Auto            Detector : Peak            Project : 911104            Mode : 8</p>	<p><b>Left blank</b></p>
<p><b>Avg.</b></p>	 <p>Site : 03CH15-HY            Condition : AVG_BE_54 3m 91200_15_1620 HORIZONTAL            : RBW:1000.000KHz VBW:30.000KHz SWT:Auto            Detector : Peak            Project : 911104            Mode : 8</p>	<p><b>Left blank</b></p>

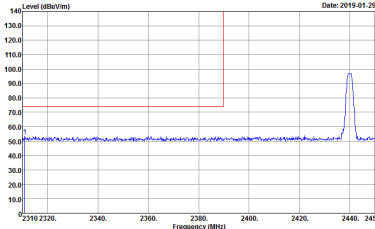
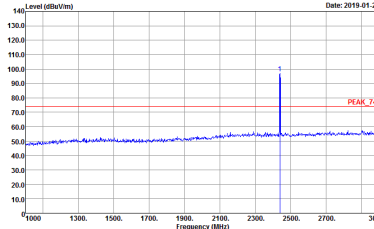
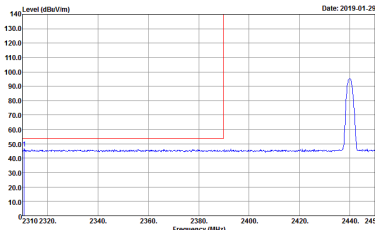
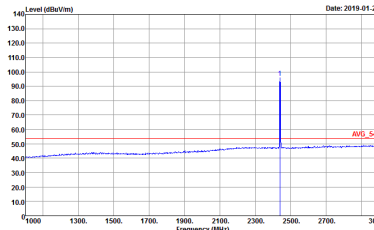

BLE	2.4GHz 2400~2483.5MHz Band Edge @ 3m	
BLE CH19 2440MHz - L		
Vertical		Fundamental
Peak	 <p>Date: 2019-01-29</p> <p>Site : 03CH15-HY            Condition : PEAK_8E_74 3m 91200_15_1620 VERTICAL            RBW:1000.000KHz VBW:3000.000KHz SWT:Auto            Detector : Peak            Project : 911104            Mode : 8</p>	 <p>Date: 2019-01-29</p> <p>Site : 03CH15-HY            Condition : PEAK_74 3m 91200_15_1620 VERTICAL            RBW:1000.000KHz VBW:3000.000KHz SWT:Auto            Detector : Peak            Project : 911104            Mode : 8</p>
Avg.	 <p>Date: 2019-01-29</p> <p>Site : 03CH15-HY            Condition : AVG_8E_54 3m 91200_15_1620 VERTICAL            RBW:1000.000KHz VBW:10.000KHz SWT:Auto            Detector : Peak            Project : 911104            Mode : 8</p>	 <p>Date: 2019-01-29</p> <p>Site : 03CH15-HY            Condition : AVG_54 3m 91200_15_1620 VERTICAL            RBW:1000.000KHz VBW:10.000KHz SWT:Auto            Detector : Peak            Project : 911104            Mode : 8</p>



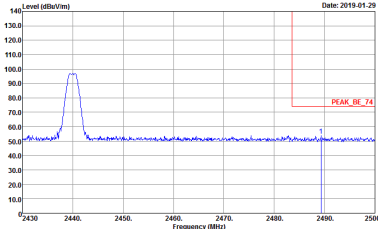
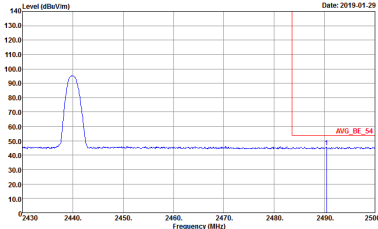

BLE	2.4GHz 2400~2483.5MHz Band Edge @ 3m	
BLE CH19 2440MHz - R		
	Vertical	Fundamental
<p><b>Peak</b></p>	 <p>Site : 03CH15-HY            Condition : PEAK_BE_74 3m 91200_15_1620 VERTICAL            RBW:1000.000KHz VBW:3000.000KHz SWT:Auto            Detector : Peak            Project : 911104            Mode : 8</p>	<p><b>Left blank</b></p>
<p><b>Avg.</b></p>	 <p>Site : 03CH15-HY            Condition : AVG_BE_54 3m 91200_15_1620 VERTICAL            RBW:1000.000KHz VBW:30.000KHz SWT:Auto            Detector : Peak            Project : 911104            Mode : 8</p>	<p><b>Left blank</b></p>

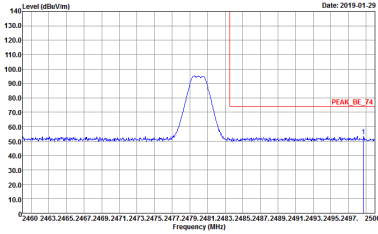
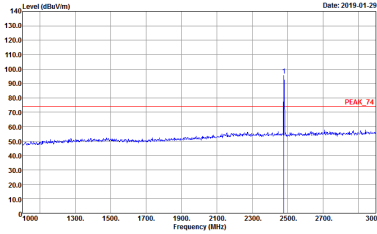
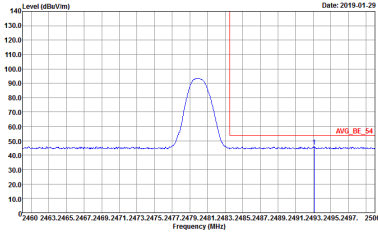
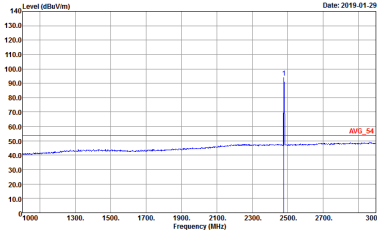

BLE	2.4GHz 2400~2483.5MHz Band Edge @ 3m	
BLE CH39 2480MHz		
Horizontal		Fundamental
Peak	 <p>Site : 03CH15-HY            Condition : PEAK_BE_74 3m 91200_15_1620 HORIZONTAL            Detector : Peak            Project : 911104            Mode : 9</p>	 <p>Site : 03CH15-HY            Condition : PEAK_74 3m 91200_15_1620 HORIZONTAL            Detector : Peak            Project : 911104            Mode : 9</p>
Avg.	 <p>Site : 03CH15-HY            Condition : AVG_BE_54 3m 91200_15_1620 HORIZONTAL            Detector : Peak            Project : 911104            Mode : 9</p>	 <p>Site : 03CH15-HY            Condition : AVG_54 3m 91200_15_1620 HORIZONTAL            Detector : Peak            Project : 911104            Mode : 9</p>

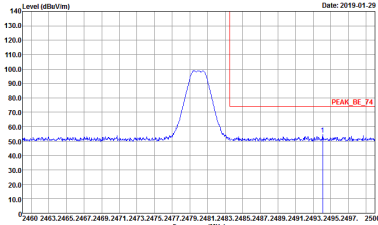
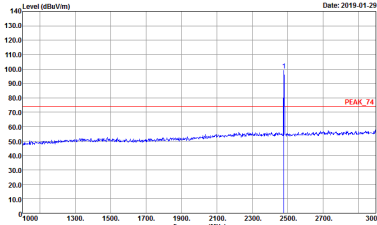
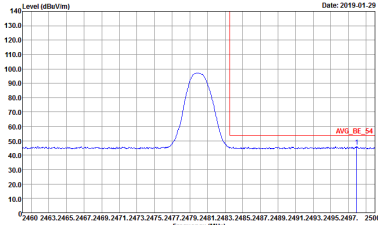
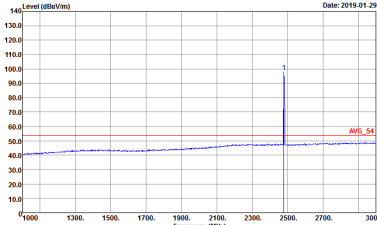

BLE	2.4GHz 2400~2483.5MHz Band Edge @ 3m	
BLE CH39 2480MHz		
Vertical		Fundamental
Peak	 <p>Site : 03CH15-HY            Condition : PEAK_BE_74 3m 91200_15_1620 VERTICAL            RBW:1000.000KHz VBW:3000.000KHz SWT:Auto            Detector : Peak            Project : 911104            Mode : 9</p>	 <p>Site : 03CH15-HY            Condition : PEAK_74 3m 91200_15_1620 VERTICAL            RBW:1000.000KHz VBW:3000.000KHz SWT:Auto            Detector : Peak            Project : 911104            Mode : 9</p>
Avg.	 <p>Site : 03CH15-HY            Condition : AVG_BE_54 3m 91200_15_1620 VERTICAL            RBW:1000.000KHz VBW:10.000KHz SWT:Auto            Detector : Peak            Project : 911104            Mode : 9</p>	 <p>Site : 03CH15-HY            Condition : AVG_54 3m 91200_15_1620 VERTICAL            RBW:1000.000KHz VBW:10.000KHz SWT:Auto            Detector : Peak            Project : 911104            Mode : 9</p>

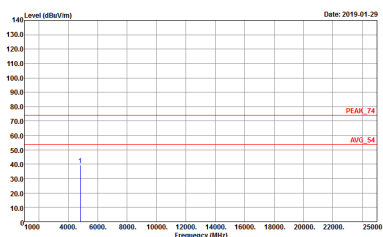
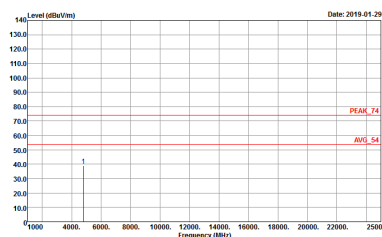

2.4GHz 2400~2483.5MHz  
BLE 2Mbps (Harmonic @ 3m)

BLE	2.4GHz 2400~2483.5MHz Harmonic @ 3m	
	BLE CH00 2402MHz	
	Horizontal	Vertical
<p><b>Peak</b> <b>Avg.</b></p>	 <p>Site : 03CH15-1FY Condition : PEAK_74 3m 91200_15_1620 HORIZONTAL Detector : Peak Project : 911104 Mode : 7</p>	 <p>Site : 03CH15-1FY Condition : PEAK_74 3m 91200_15_1620 VERTICAL Detector : Peak Project : 911104 Mode : 7</p>



BLE	2.4GHz 2400~2483.5MHz Harmonic @ 3m	
	BLE CH19 2440MHz	
	Horizontal	Vertical
<b>Peak</b> <b>Avg.</b>	<p>Site : 03CH15-HY Condition : PEAK_74 3m 91200_15_1620 HORIZONTAL Detector : Peak Project : 911104 Mode : S</p>	<p>Site : 03CH15-HY Condition : PEAK_74 3m 91200_15_1620 VERTICAL Detector : Peak Project : 911104 Mode : S</p>

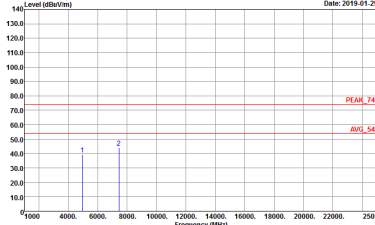
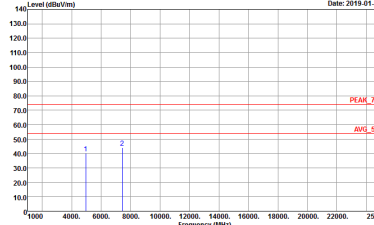

BLE	2.4GHz 2400~2483.5MHz Harmonic @ 3m	
BLE CH39 2480MHz		
	Horizontal	Vertical
Peak	 <p>Site : 03CH15-HY Condition : PEAK_74 3m 91200_15_1620 HORIZONTAL Detector : Peak Project : 911104 Mode : 9</p>	 <p>Site : 03CH15-HY Condition : PEAK_74 3m 91200_15_1620 VERTICAL Detector : Peak Project : 911104 Mode : 9</p>



Emission below 1GHz  
2.4GHz BLE 2Mbps (LF)

BLE	2.4GHz 2400~2483.5MHz	
	BLE LF	
	Horizontal	Vertical
QP / Peak	<p>Site : 03CH15-FY Condition : QP 3m 81LOG_16_47020 HORIZONTAL Detector : Peak Project : 911104 Mode : 54</p>	<p>Site : 03CH15-FY Condition : QP 3m 81LOG_16_47020 VERTICAL Detector : Peak Project : 911104 Mode : 54</p>



### Appendix D. Duty Cycle Plots

Band	Duty Cycle (%)	T(us)	1/T(kHz)	VBW Setting	Duty Factor (dB)
Bluetooth – LE for 1Mbps	62.18	388.00	2.58	3kHz	2.06
Bluetooth – LE for 2Mbps	32.37	202.00	4.81	10kHz	4.90

#### Bluetooth – LE for 1Mbps

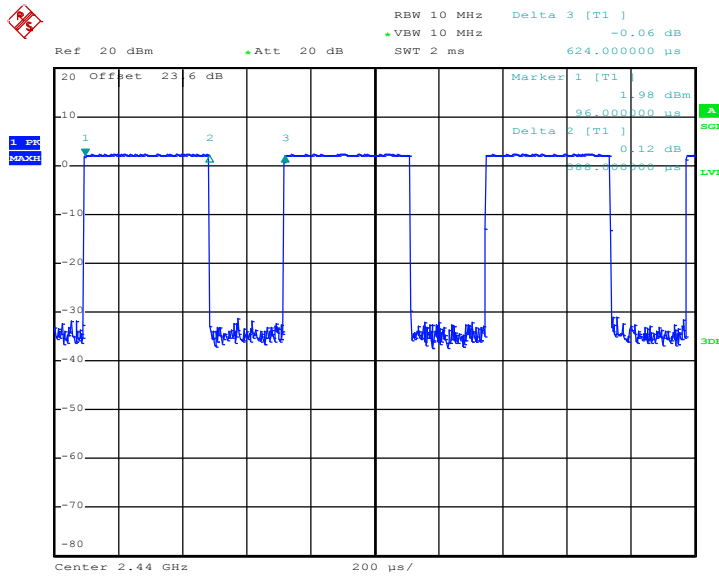

Date: 22.JAN.2019 21:25:48





Bluetooth – LE for 2Mbps

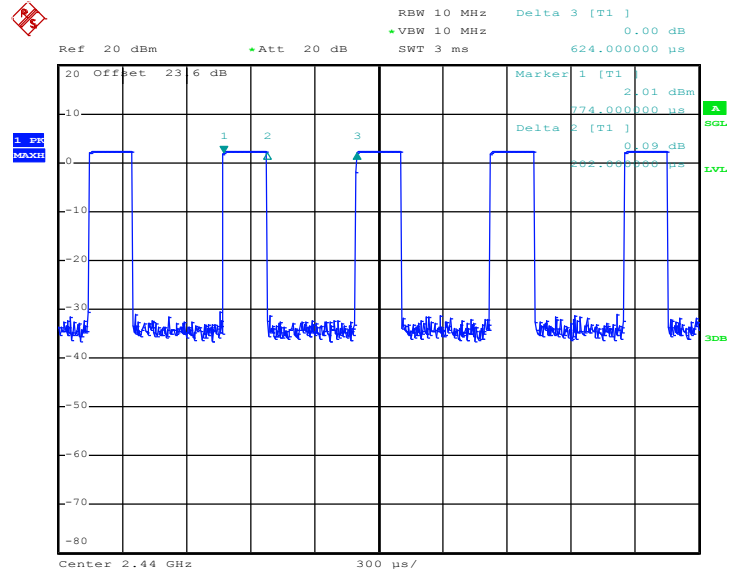

Date: 22.JAN.2019 21:28:36