



# FCC CO-LOCATION RADIO TEST REPORT

FCC ID : UZ7CC6000  
Equipment : Customer Concierge  
Brand Name : ZEBRA  
Model Name : CC6000  
Applicant : Zebra Technologies Corporation  
1 Zebra Plaza, Holtsville, NY 11742  
Manufacturer : Zebra Technologies Corporation  
1 Zebra Plaza, Holtsville, NY 11742  
Standard : FCC Part 15 Subpart E §15.407

The product was received on Jan. 11, 2019 and testing was started from Jan. 23, 2019 and completed on Feb. 19, 2019. We, SPORTON INTERNATIONAL INC. EMC & Wireless Communications Laboratory, would like to declare that the tested sample has been evaluated in accordance with the test procedures and has been in compliance with the applicable technical standards.

The report must not be used by the client to claim product certification, approval, or endorsement by TAF or any agency of government.

The test results in this report apply exclusively to the tested model / sample. Without written approval of SPORTON INTERNATIONAL INC. EMC & Wireless Communications Laboratory, the test report shall not be reproduced except in full.

Approved by: Jones Tsai

**SPORTON INTERNATIONAL INC. EMC & Wireless Communications Laboratory**  
No. 52, Huaya 1st Rd., Guishan Dist., Taoyuan City, Taiwan (R.O.C.)



## Table of Contents

History of this test report .....	3
Summary of Test Result .....	4
<b>1 General Description .....</b>	<b>5</b>
1.1 Product Feature of Equipment Under Test.....	5
1.2 Product Specification of Equipment Under Test.....	6
1.3 Modification of EUT.....	6
1.4 Testing Location.....	6
1.5 Applicable Standards .....	7
<b>2 Test Configuration of Equipment Under Test .....</b>	<b>8</b>
2.1 Carrier Frequency and Channel.....	8
2.2 Test Mode.....	8
2.3 Connection Diagram of Test System.....	8
2.4 Support Unit used in test configuration and system .....	9
2.5 EUT Operation Test Setup.....	9
<b>3 Test Result.....</b>	<b>10</b>
3.1 Unwanted Emissions Measurement.....	10
3.2 Antenna Requirements .....	14
<b>4 List of Measuring Equipment .....</b>	<b>15</b>
<b>5 Uncertainty of Evaluation .....</b>	<b>16</b>
<b>Appendix A. Radiated Spurious Emission</b>	
<b>Appendix B. Radiated Spurious Emission Plots</b>	
<b>Appendix C. Duty Cycle Plots</b>	
<b>Appendix D. Setup Photographs</b>	



### History of this test report

Report No.	Version	Description	Issued Date
FR911104G	01	Initial issue of report	Mar. 26, 2019



### Summary of Test Result

Report Clause	Ref Std. Clause	Test Items	Result (PASS/FAIL)	Remark
3.1	15.407(b)	Unwanted Emissions	Pass	Under limit 4.60 dB at 140.430 MHz
3.2	15.203 15.407(a)	Antenna Requirement	Pass	-

**Declaration of Conformity:**

The test results with all measurement uncertainty excluded are presented in accordance with the regulation limits or requirements declared by manufacturers.

**Comments and Explanations:**

The declared of product specification for EUT presented in the report are provided by the manufacturer, and the manufacturer takes all the responsibilities for the accuracy of product specification.

**Reviewed by: Wii Chang**

**Report Producer: Maggie Chiang**



# 1 General Description

## 1.1 Product Feature of Equipment Under Test

Product Feature	
Equipment	Customer Concierge
Brand Name	ZEBRA
Model Name	CC6000
FCC ID	UZ7CC6000
EUT supports Radios application	NFC WLAN 11a/b/g/n HT20/HT40 WLAN 11ac VHT20/VHT40/VHT80 Bluetooth BR/EDR/LE
HW Version	DV
SW Version	01-15-05.00.OG-U00-PRD
FW Version	FUSION_QA_2_1.4.0.002_O
MFD	21DEC18
EUT Stage	Engineering Sample

Remark: The above EUT's information was declared by manufacturer.

### <Sample Information>

	Sample 1	Sample 2	Sample 3
Component Category	CC6000 Landscape Display with Camera	CC6000 Landscape Display, No Camera	CC6000 Portrait Display with Camera
Data capture options	SE4710	SE4710	SE4710
Camera	Front Facing ≥5 Mp	None	Front Facing ≥5 Mp

Supported Unit Used in Test Configuration and System				
AC Adapter	Brand Name	ZEBRA	Part Number	PWR-BUA5V16W0WW
DC Cable	Brand Name	ZEBRA	Part Number	CBL-DC-383A1-01
AC Cable	Brand Name	ZEBRA	Part Number	50-16000-182R
POE	Brand Name	Microsemi	Model Number	PD-9501GR/AC



## 1.2 Product Specification of Equipment Under Test

Standards-related Product Specification	
<b>Tx/Rx Frequency Range</b>	WLAN 802.11ac: 2412 MHz ~ 2462 MHz WLAN 802.11ac: 5180 MHz ~ 5240 MHz; 5260 MHz ~ 5320 MHz; 5500 MHz ~ 5720 MHz; 5745 MHz ~ 5825 MHz
<b>Antenna Type / Gain</b>	<p><b>&lt;2412 MHz ~ 2462 MHz&gt;</b> Ant. 1 : PIFA Antenna with gain 3.86 dBi Ant. 2 : PIFA Antenna with gain 3.24 dBi</p> <p><b>&lt;5150 MHz ~ 5250 MHz&gt;</b> Ant. 1 : PIFA Antenna with gain 3.77 dBi Ant. 2 : PIFA Antenna with gain 3.20 dBi</p> <p><b>&lt;5250 MHz ~ 5350 MHz&gt;</b> Ant. 1 : PIFA Antenna with gain 5.20 dBi Ant. 2 : PIFA Antenna with gain 2.80 dBi</p> <p><b>&lt;5470 MHz ~ 5725 MHz&gt;</b> Ant. 1 : PIFA Antenna with gain 4.70 dBi Ant. 2 : PIFA Antenna with gain 5.20 dBi</p> <p><b>&lt;5725 MHz ~ 5850 MHz&gt;</b> Ant. 1 : PIFA Antenna with gain 4.70 dBi Ant. 2 : PIFA Antenna with gain 5.20 dBi</p>
<b>Type of Modulation</b>	802.11ac: OFDM (BPSK / QPSK / 16QAM / 64QAM / 256QAM)

## 1.3 Modification of EUT

No modifications are made to the EUT during all test items.

## 1.4 Testing Location

<b>Test Site</b>	SPORTON INTERNATIONAL INC.
<b>Test Site Location</b>	No.58, Aly. 75, Ln. 564, Wenhua 3rd, Rd., Guishan Dist., Taoyuan City, Taiwan (R.O.C.) TEL: +886-3-327-0868 FAX: +886-3-327-0855
<b>Test Site No.</b>	<b>Sporton Site No.</b> 03CH15-HY

**Note:** The test site complies with ANSI C63.4 2014 requirement.

FCC Designation No. TW0007



## **1.5 Applicable Standards**

According to the specifications of the manufacturer, the EUT must comply with the requirements of the following standards:

- ♦ FCC Part 15 Subpart E
- ♦ FCC KDB 789033 D02 General UNII Test Procedures New Rules v02r01.
- ♦ FCC KDB 414788 D01 Radiated Test Site v01r01.
- ♦ FCC KDB 662911 D01 Multiple Transmitter Output v02r01.
- ♦ FCC KDB Publication No. 558074 D01 DTS Meas. Guidance v05r01
- ♦ ANSI C63.10-2013

**Remark:**

1. All test items were verified and recorded according to the standards and without any deviation during the test.
2. This EUT has also been tested and complied with the requirements of FCC Part 15, Subpart B, recorded in a separate test report.

## 2 Test Configuration of Equipment Under Test

The EUT has been associated with peripherals and configuration operated in a manner tended to maximize its emission characteristics in a typical application. Frequency range investigated: radiation emission (9 kHz to the 10th harmonic of the highest fundamental frequency or to 40 GHz, whichever is lower). For radiated measurement, pre-scanned in three orthogonal panels, X, Y, Z. The worst cases (Y plane for WLAN2.4GHz + WLAN5GHz) were recorded in this report.

### 2.1 Carrier Frequency and Channel

2400-2483.5 MHz 802.11ac VTH40		5250-5350 MHz 802.11ac VTH80	
Channel	Freq. (MHz)	Channel	Freq. (MHz)
06	2437	58	5290

### 2.2 Test Mode

Final test modes are considering the modulation and worse data rates as below table.

<Co-Location>

Modulation	Data Rate
802.11ac VTH40 for Ant. 1 + 802.11ac VTH80 for Ant. 2	MCS0 + MCS0

### 2.3 Connection Diagram of Test System

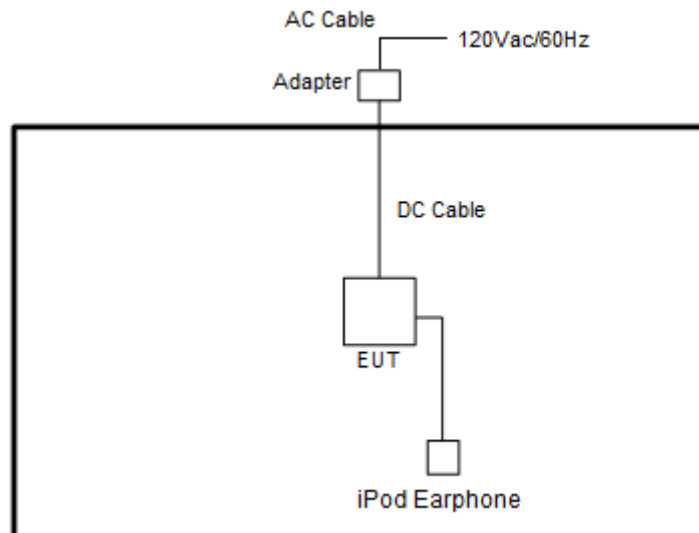





## 2.4 Support Unit used in test configuration and system

Item	Equipment	Trade Name	Model Name	FCC ID	Data Cable	Power Cord
1.	Notebook	Lenovo	L570	NA	N/A	AC I/P: Unshielded, 1.2m DC O/P: Shielded, 1.8m
2.	iPod Earphone	Apple	N/A	Verification	Unshielded, 1.0m	N/A

## 2.5 EUT Operation Test Setup

The RF test items, utility "QRCT" was installed in Notebook which was programmed in order to make the EUT get into the engineering modes to provide channel selection, power level, data rate and the application type and for continuous transmitting signals.



### 3 Test Result

#### 3.1 Unwanted Emissions Measurement

This section is to measure unwanted emissions through radiated measurement for band edge spurious emissions and out of band emissions measurement.

##### 3.1.1 Limit of Unwanted Emissions

(1) Unwanted spurious emissions fallen in restricted bands shall comply with the general field strength limits as below table,

Frequency (MHz)	Field Strength (microvolts/meter)	Measurement Distance (meters)
0.009 – 0.490	2400/F(kHz)	300
0.490 – 1.705	24000/F(kHz)	30
1.705 – 30.0	30	30
30 – 88	100	3
88 – 216	150	3
216 - 960	200	3
Above 960	500	3

**Note:** The following formula is used to convert the EIRP to field strength.

$$E = \frac{1000000\sqrt{30P}}{3} \text{ } \mu\text{V/m, where P is the eirp (Watts)}$$

EIRP (dBm)	Field Strength at 3m (dBμV/m)
- 27	68.3

(2) KDB789033 D02 v02r01 G)2)c)

- (i) Section 15.407(b)(1) to (b)(3) specify the unwanted emission limits for the U-NII-1 and U-NII-2 bands. As specified, emissions above 1000 MHz that are outside of the restricted bands are subject to a peak emission limit of -27 dBm/MHz.<sup>3</sup>
- (ii) Section 15.407(b)(4) specifies the unwanted emission limit for the U-NII-3 band. A band emissions mask is specified in Section 15.407(b)(4)(i). The emission limits are in terms of a Peak detector. An alternative to the band emissions mask is specified in Section 15.407(b)(4)(ii). The alternative limits are based on the highest antenna gain specified in the filing. There are also marketing and importation restrictions for the devices using the alternative limit.<sup>4</sup>

**Note 3:** An out-of-band emission that complies with both the average and peak limits of Section 15.209 is not required to satisfy the -27 dBm/MHz peak emission limit.

**Note 4:** Only devices with antenna gains of 10 dBi or less may be approved using the emission limits specified in Section 15.247(d) till March 2, 2018; all other devices operating in this band must use the mask specified in Section 15.407(b)(4)(i).



### 3.1.2 Measuring Instruments

See list of measuring equipment of this test report.

### 3.1.3 Test Procedures

1. The testing follows FCC KDB 789033 D02 General UNII Test Procedures New Rules **v02r01**.  
Section G) Unwanted emissions measurement.  
(1) Procedure for Unwanted Emissions Measurements Below 1000MHz
  - RBW = 120 kHz
  - VBW = 300 kHz
  - Detector = Peak
  - Trace mode = max hold  
(2) Procedure for Peak Unwanted Emissions Measurements Above 1000 MHz
  - RBW = 1 MHz
  - VBW  $\geq$  3 MHz
  - Detector = Peak
  - Sweep time = auto
  - Trace mode = max hold  
(3) Procedures for Average Unwanted Emissions Measurements Above 1000MHz
  - RBW = 1 MHz
  - VBW = 10 Hz, when duty cycle is no less than 98 percent.
  - VBW  $\geq$  1/T, when duty cycle is less than 98 percent where T is the minimum transmission duration over which the transmitter is on and is transmitting at its maximum power control level for the tested mode of operation.
2. The EUT was placed on a turntable with 0.8 meter for frequency below 1GHz and 1.5 meter for frequency above 1GHz respectively above ground.
3. The EUT was set 3 meters from the interference receiving antenna which was mounted on the top of a variable height antenna tower.
4. The antenna is a broadband antenna and its height is adjusted between one meter and four meters above ground to find the maximum value of the field strength for both horizontal polarization and vertical polarization of the antenna.
5. For each suspected emission, the EUT was arranged to its worst case and then adjust the antenna tower (from 1 m to 4 m) and turntable (from 0 degree to 360 degrees) to find the maximum reading.

6. For testing below 1GHz, if the emission level of the EUT in peak mode was 3 dB lower than the limit specified, then peak values of EUT will be reported, otherwise, the emissions will be repeated one by one using the CISPR quasi-peak method and reported.
7. For testing above 1GHz, the emission level of the EUT in peak mode was 20dB lower than average limit (that means the emission level in average mode also complies with the limit in average mode), then peak values of EUT will be reported, otherwise, the emissions will be measured in average mode again and reported.

### 3.1.4 Test Setup

For radiated emissions below 30MHz

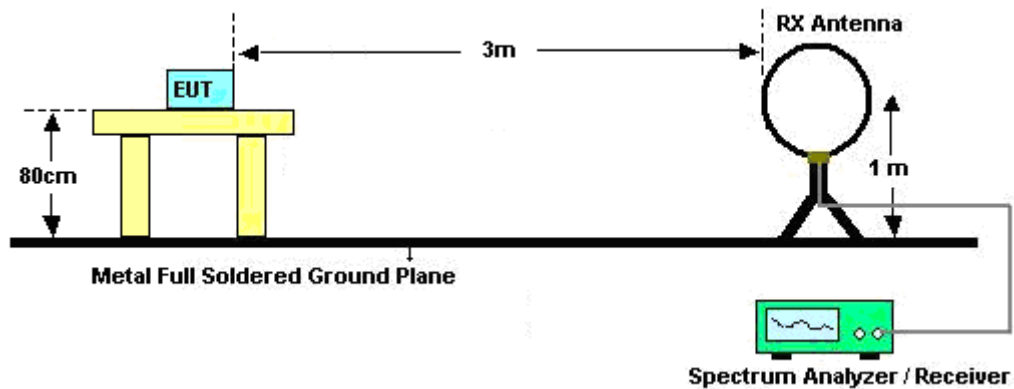

For radiated emissions from 30MHz to 1GHz

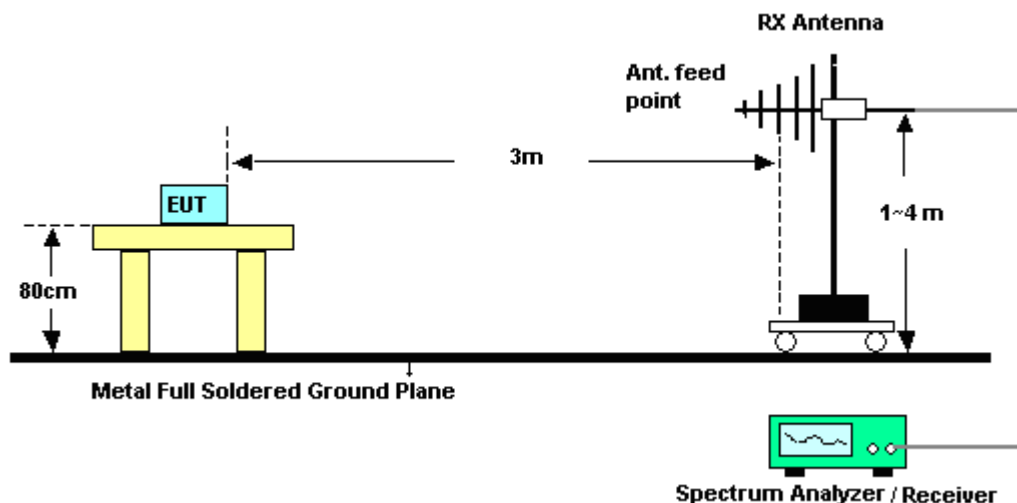

For radiated emissions above 1GHz

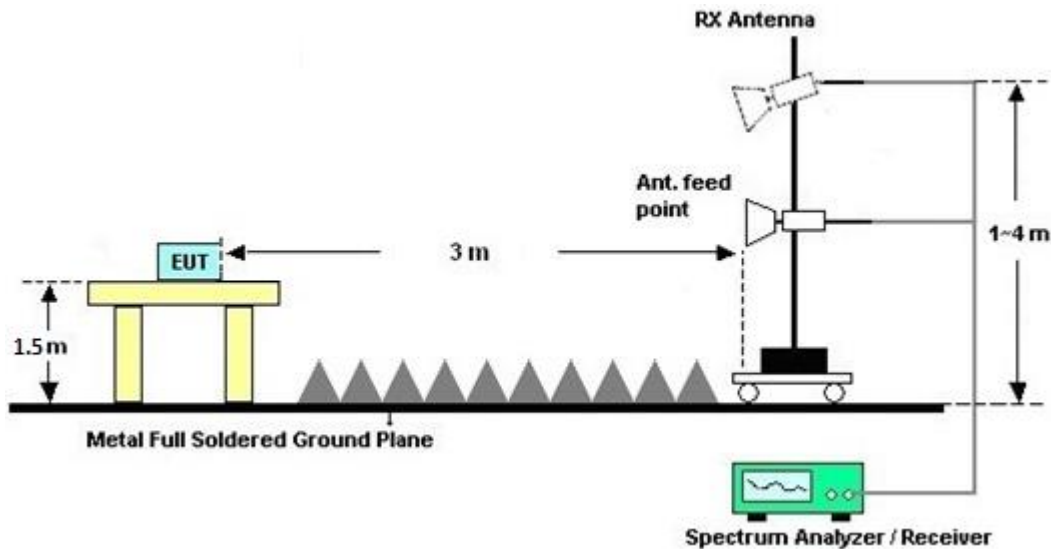

### 3.1.5 Test Results of Radiated Spurious Emissions (9 kHz ~ 30 MHz)

The low frequency, which started from 9 kHz to 30MHz, was pre-scanned and the result which was 20dB lower than the limit line was not reported.

There is a comparison data of both open-field test site and alternative test site - semi-Anechoic chamber according to 414788 D01 Radiated Test Site v01r01, and the result came out very similar.

### 3.1.6 Test Result of Radiated Spurious at Band Edges

Please refer to Appendix A and B.

### 3.1.7 Duty Cycle

Please refer to Appendix C.

### 3.1.8 Test Result of Radiated Spurious Emissions (30MHz ~ 10th Harmonic)

Please refer to Appendix A and B.



## **3.2 Antenna Requirements**

### **3.2.1 Standard Applicable**

If transmitting antenna directional gain is greater than 6 dBi, both the peak transmit power and the peak power spectral density shall be reduced by the amount in dB that the directional gain of the antenna exceeds 6 dBi.

### **3.2.2 Antenna Anti-Replacement Construction**

An embedded-in antenna design is used.

### **3.2.3 Antenna Gain**

The antenna peak gain of EUT is less than 6 dBi. Therefore, it is not necessary to reduce maximum peak output power limit.



## 4 List of Measuring Equipment

Instrument	Manufacturer	Model No.	Serial No.	Characteristics	Calibration Date	Test Date	Due Date	Remark
Loop Antenna	TESEQ	HLA 6120	31244	9 kHz~30 MHz	Mar. 29, 2018	Jan. 23, 2019~ Feb. 19, 2019	Mar. 28, 2019	Radiation (03CH15-HY)
Preamplifier	EMEC	EM18G40G	060715	18GHz ~ 40GHz	Dec. 06, 2018	Jan. 23, 2019~ Feb. 19, 2019	Dec. 05, 2019	Radiation (03CH15-HY)
Bilog Antenna	TESEQ	CBL6111D&0 0802N1D01N- 06	47020&06	30MHz to 1GHz	Oct. 13, 2018	Jan. 23, 2019~ Feb. 19, 2019	Oct. 12, 2019	Radiation (03CH15-HY)
Horn Antenna	SCHWARZBE CK	BBHA 9120D	9120D-162 0	1G~18GHz	Oct. 17, 2018	Jan. 23, 2019~ Feb. 19, 2019	Oct. 16, 2019	Radiation (03CH15-HY)
SHF-EHF Horn Antenna	SCHWARZBE CK	BBHA 9170	BBHA9170 576	18GHz ~ 40GHz	May 08, 2018	Jan. 23, 2019~ Feb. 19, 2019	May 07, 2019	Radiation (03CH15-HY)
Amplifier	SONOMA	310N	363440	9kHz~1GHz	Dec. 28, 2018	Jan. 23, 2019~ Feb. 19, 2019	Dec. 27, 2019	Radiation (03CH15-HY)
Preamplifier	Jet-Power	JPA0118-55-3 03	171000180 00550006	1GHz~18GHz	Jul. 10, 2018	Jan. 23, 2019~ Feb. 19, 2019	Jul. 09, 2019	Radiation (03CH15-HY)
Preamplifier	Keysight	83017A	MY5327019 5	1GHz~26.5GHz	Aug. 23, 2018	Jan. 23, 2019~ Feb. 19, 2019	Aug. 22, 2019	Radiation (03CH15-HY)
EMI Test Receiver	Keysight	N9038A (MXE)	MY5413008 5	20Hz ~ 8.4GHz	Nov. 01, 2018	Jan. 23, 2019~ Feb. 19, 2019	Oct. 31, 2019	Radiation (03CH15-HY)
Spectrum Analyzer	Agilent	E4446A	MY5018013 6	3Hz~44GHz	Apr. 25, 2018	Jan. 23, 2019~ Feb. 19, 2019	Apr. 24, 2019	Radiation (03CH15-HY)
Antenna Mast	ChainTek	MBS-520-1	N/A	1m~4m	N/A	Jan. 23, 2019~ Feb. 19, 2019	N/A	Radiation (03CH15-HY)
Turn Table	ChainTek	T-200-S-1	N/A	0~360 Degree	N/A	Jan. 23, 2019~ Feb. 19, 2019	N/A	Radiation (03CH15-HY)
Software	Audix	E3 6.2009-8-24	RK-000451	N/A	N/A	Jan. 23, 2019~ Feb. 19, 2019	N/A	Radiation (03CH15-HY)
RF Cable	HUBER + SUHNER	SUCOFLEX 104	MY36980/4	30M-18G	Apr. 16, 2018	Jan. 23, 2019~ Feb. 19, 2019	Apr. 15, 2019	Radiation (03CH15-HY)
RF Cable	HUBER + SUHNER	SUCOFLEX 104	MY9838/4	30M-18G	Apr. 16, 2018	Jan. 23, 2019~ Feb. 19, 2019	Apr. 15, 2019	Radiation (03CH15-HY)
RF Cable	HUBER + SUHNER	MTJ	000000-MT 18A-100D3 210	30M-18G	Apr. 16, 2018	Jan. 23, 2019~ Feb. 19, 2019	Apr. 15, 2019	Radiation (03CH15-HY)
RF Cable	HUBER + SUHNER	SUCOFLEX 102	MY2859/2	30MHz-40GHz	Mar. 14, 2018	Jan. 23, 2019~ Feb. 19, 2019	Mar. 13, 2019	Radiation (03CH15-HY)
RF Cable	HUBER + SUHNER	SUCOFLEX 102	MY4274/2	30MHz-40GHz	Mar. 14, 2018	Jan. 23, 2019~ Feb. 19, 2019	Mar. 13, 2019	Radiation (03CH15-HY)
Filter	Wainwright	WHKX12-270 0-3000-18000 -60SS	SN2	3.0 GHz High pass	Jul. 16, 2018	Jan. 23, 2019~ Feb. 19, 2019	Jul. 15, 2019	Radiation (03CH15-HY)
Filter	Wainwright	WLK4-1000-1 530-8000-40S S	SN11	1G Low Pass	Sep. 16, 2018	Jan. 23, 2019~ Feb. 19, 2019	Sep. 15, 2019	Radiation (03CH15-HY)



## 5 Uncertainty of Evaluation

### Uncertainty of Radiated Emission Measurement (30 MHz ~ 1000 MHz)

Measuring Uncertainty for a Level of Confidence of 95% ( $U = 2Uc(y)$ )	5.2
---	-----

### Uncertainty of Radiated Emission Measurement (1000 MHz ~ 18000 MHz)

Measuring Uncertainty for a Level of Confidence of 95% ( $U = 2Uc(y)$ )	5.5
---	-----

### Uncertainty of Radiated Emission Measurement (18000 MHz ~ 40000 MHz)

Measuring Uncertainty for a Level of Confidence of 95% ( $U = 2Uc(y)$ )	5.2
---	-----





## Appendix A. Radiated Spurious Emission

Test Engineer :	Watt Tseng, Karl Hou, and BigShow Wang	Temperature :	23~26°C
		Relative Humidity :	50~57%

### 2.4GHz 2400~2483.5MHz

#### WIFI 802.11ac VHT40 (Band Edge @ 3m)

WIFI	Note	Frequency	Level	Over	Limit	Read	Antenna	Path	Preamp	Ant	Table	Peak	Pol.
Ant.				Limit	Line	Level	Factor	Loss	Factor	Pos	Pos	Avg.	
1		( MHz )	( dBμV/m )	( dB )	( dBμV/m )	( dBμV )	( dB/m )	( dB )	( dB )	( cm )	( deg )	( P/A )	( H/V )
802.11ac VHT40 CH 06 2437MHz		2389.38	55.06	-18.94	74	42.55	27.6	15.77	30.86	369	238	P	H
		2389.94	45.87	-8.13	54	33.35	27.6	15.77	30.85	369	238	A	H
	*	2437	104.52	-	-	91.92	27.6	15.84	30.84	369	238	P	H
	*	2437	96.05	-	-	83.45	27.6	15.84	30.84	369	238	A	H
		2485.86	55.65	-18.35	74	43.09	27.47	15.91	30.82	369	238	P	H
		2483.5	46.18	-7.82	54	33.62	27.47	15.91	30.82	369	238	A	H
		2328.2	53.53	-20.47	74	40.97	27.77	15.68	30.89	338	326	P	V
		2389.94	45.34	-8.66	54	32.82	27.6	15.77	30.85	338	326	A	V
	*	2437	105.04	-	-	92.44	27.6	15.84	30.84	338	326	P	V
	*	2437	97.52	-	-	84.92	27.6	15.84	30.84	338	326	A	V
	2484.32	59.22	-14.78	74	46.66	27.47	15.91	30.82	338	326	P	V	
	2483.5	49.18	-4.82	54	36.62	27.47	15.91	30.82	338	326	A	V	
Remark	1. No other spurious found. 2. All results are PASS against Peak and Average limit line.												



Band 2 5250~5350MHz

WIFI 802.11ac VHT80 (Band Edge @ 3m)

WIFI	Note	Frequency	Level	Over	Limit	Read	Antenna	Path	Preamp	Ant	Table	Peak	Pol.
Ant.				Limit	Line	Level	Factor	Loss	Factor	Pos	Pos	Avg.	
2		( MHz )	( dBμV/m )	( dB )	( dBμV/m )	( dBμV )	( dB/m )	( dB )	( dB )	( cm )	( deg )	( P/A )	( H/V )
802.11ac VHT80 CH 58 5290MHz		5092.14	50.06	-23.94	74	39.64	31.9	8.61	30.09	244	52	P	H
		5065.96	41.4	-12.6	54	31	31.9	8.59	30.09	244	52	A	H
	*	5290	101.12	-	-	90.97	31.4	8.86	30.11	244	52	P	H
	*	5290	93.3	-	-	83.15	31.4	8.86	30.11	244	52	A	H
		5359.92	54.89	-19.11	74	44.59	31.4	9.02	30.12	244	52	P	H
		5351.04	47.31	-6.69	54	37.03	31.4	9	30.12	244	52	A	H
		5080.24	50.09	-23.91	74	39.68	31.9	8.6	30.09	264	87	P	V
		5065.96	41.5	-12.5	54	31.1	31.9	8.59	30.09	264	87	A	V
	*	5290	102.63	-	-	92.48	31.4	8.86	30.11	264	87	P	V
	*	5290	94.87	-	-	84.72	31.4	8.86	30.11	264	87	A	V
		5357.28	55.35	-18.65	74	45.06	31.4	9.01	30.12	264	87	P	V
		5350.56	47.94	-6.06	54	37.66	31.4	9	30.12	264	87	A	V
Remark	1. No other spurious found. 2. All results are PASS against Peak and Average limit line.												



2.4GHz 2400~2483.5MHz & Band 2 5250~5350MHz
WIFI 802.11ac VHT40+VHT80 (Harmonic @ 3m)

Table with 14 columns: WIFI Ant. Simultaneously, Note, Frequency (MHz), Level (dBµV/m), Over Limit (dB), Limit Line (dBµV/m), Read Level (dBµV), Antenna Factor (dB/m), Path Loss (dB), Preamp Factor (dB), Ant Pos (cm), Table Pos (deg), Peak Avg. (P/A), Pol. (H/V). Rows include 802.11ac VHT40 CH 06 2437MHz and VHT80 CH 58 5290MHz. A Remark section at the bottom states: 1. No other spurious found. 2. All results are PASS against Peak and Average limit line.



Emission below 1GHz

WIFI 802.11ac VHT40+VHT80 (LF)

WIFI	Note	Frequency	Level	Over	Limit	Read	Antenna	Path	Preamp	Ant	Table	Peak	Pol.	
Ant.				Limit	Line	Level	Factor	Loss	Factor	Pos	Pos	Avg.		
Simultaneously		( MHz )	( dBμV/m )	( dB )	( dBμV/m )	(dBμV)	( dB/m )	( dB )	( dB )	( cm )	( deg )	(P/A)	(H/V)	
802.11ac VHT40 CH 06 2437MHz + VHT80 CH 58 5290MHz		78.06	30.41	-9.59	40	48.6	13.2	1.16	32.55	-	-	P	H	
		135.84	38.43	-5.07	43.5	52.02	17.43	1.48	32.5	100	0	P	H	
		166.89	34.16	-9.34	43.5	49.12	15.8	1.74	32.5	-	-	P	H	
		497.4	35.24	-10.76	46	41.17	23.9	2.74	32.57	-	-	P	H	
		568.8	35.31	-10.69	46	39	25.91	2.99	32.59	-	-	P	H	
		710.9	32.11	-13.89	46	34.4	26.83	3.26	32.38	-	-	P	H	
														H
														H
														H
														H
														H
			35.94	35.29	-4.71	40	45.72	21.44	0.74	32.61	-	-	P	V
			77.79	32.2	-7.8	40	50.48	13.11	1.16	32.55	-	-	P	V
			140.43	38.9	-4.6	43.5	52.47	17.42	1.51	32.5	100	0	P	V
			498.1	34.78	-11.22	46	40.69	23.92	2.74	32.57	-	-	P	V
			568.8	37.03	-8.97	46	40.72	25.91	2.99	32.59	-	-	P	V
			746.6	38.14	-7.86	46	39	28.13	3.32	32.31	-	-	P	V
														V
													V	
													V	
													V	
													V	
													V	
Remark	1. No other spurious found. 2. All results are PASS against limit line.													



**Note symbol**

*	<b>Fundamental Frequency</b> which can be ignored. However, the level of any unwanted emissions shall not exceed the level of the fundamental frequency.
!	Test result is <b>over limit</b> line.
P/A	<b>Peak</b> or <b>Average</b>
H/V	<b>Horizontal</b> or <b>Vertical</b>



A calculation example for radiated spurious emission is shown as below:

WIFI	Note	Frequency	Level	Over	Limit	Read	Antenna	Path	Preamp	Ant	Table	Peak	Pol.
Ant.				Limit	Line	Level	Factor	Loss	Factor	Pos	Pos	Avg.	
1		( MHz )	( dBμV/m )	( dB )	( dBμV/m )	( dBμV )	( dB/m )	( dB )	( dB )	( cm )	( deg )	( P/A )	( H/V )
802.11b		2390	55.45	-18.55	74	54.51	32.22	4.58	35.86	103	308	P	H
CH 01													
2412MHz		2390	43.54	-10.46	54	42.6	32.22	4.58	35.86	103	308	A	H

1. Path Loss(dB) = Cable loss(dB) + Filter loss(dB) + Attenuator loss(dB)
2. Level(dBμV/m) =  
Antenna Factor(dB/m) + Path Loss(dB) + Read Level(dBμV) - Preamp Factor(dB)
3. Over Limit(dB) = Level(dBμV/m) – Limit Line(dBμV/m)

**For Peak Limit @ 2390MHz:**

1. Level(dBμV/m)  
= Antenna Factor(dB/m) + Path Loss(dB) + Read Level(dBμV) - Preamp Factor(dB)  
= 32.22(dB/m) + 4.58(dB) + 54.51(dBμV) – 35.86 (dB)  
= 55.45 (dBμV/m)
2. Over Limit(dB)  
= Level(dBμV/m) – Limit Line(dBμV/m)  
= 55.45(dBμV/m) – 74(dBμV/m)  
= -18.55(dB)

**For Average Limit @ 2390MHz:**

1. Level(dBμV/m)  
= Antenna Factor(dB/m) + Path Loss(dB) + Read Level(dBμV) - Preamp Factor(dB)  
= 32.22(dB/m) + 4.58(dB) + 42.6(dBμV) – 35.86 (dB)  
= 43.54 (dBμV/m)
2. Over Limit(dB)  
= Level(dBμV/m) – Limit Line(dBμV/m)  
= 43.54(dBμV/m) – 54(dBμV/m)  
= -10.46(dB)

**Both peak and average measured complies with the limit line, so test result is “PASS”.**



## Appendix B. Radiated Spurious Emission Plots

Test Engineer :	Watt Tseng, Karl Hou, and BigShow Wang	Temperature :	23~26°C
		Relative Humidity :	50~57%

**Note symbol**

-L	Low channel location
-R	High channel location



2.4GHz 2400~2483.5MHz

WIFI 802.11ac VHT40 (Band Edge @ 3m)

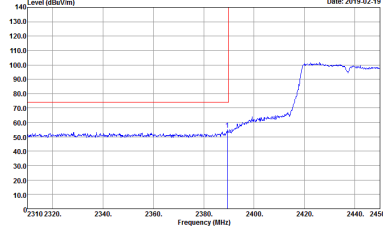
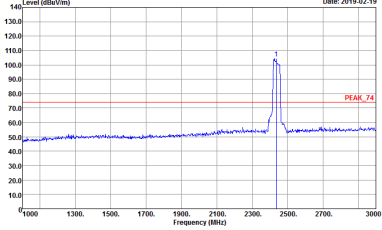
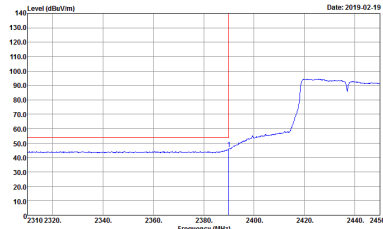
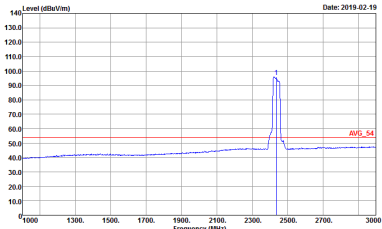
WIFI	2.4GHz 2400~2483.5MHz Band Edge @ 3m	
ANT	802.11ac VH40 CH06 2437MHz - L	
1	Horizontal	Fundamental
<b>Peak</b>	 <p>Site : 03CH15-HY            Condition : PEAK_BE_74 3m 91200_15_1620 HORIZONTAL            Detector : Peak            Project : 911104            Mode : 59            Setting : 16.5</p>	 <p>Site : 03CH15-HY            Condition : PEAK_74 3m 91200_15_1620 HORIZONTAL            Detector : Peak            Project : 911104            Mode : 59            Setting : 16.5</p>
<b>Avg.</b>	 <p>Site : 03CH15-HY            Condition : AV6_BE_54 3m 91200_15_1620 HORIZONTAL            Detector : Peak            Project : 911104            Mode : 59            Setting : 16.5</p>	 <p>Site : 03CH15-HY            Condition : AV6_54 3m 91200_15_1620 HORIZONTAL            Detector : Peak            Project : 911104            Mode : 59            Setting : 16.5</p>



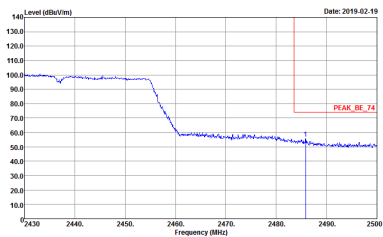
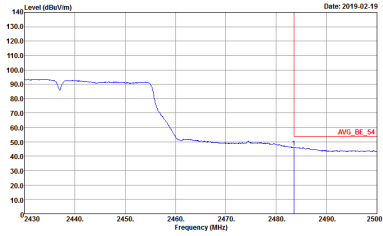

WIFI	2.4GHz 2400~2483.5MHz Band Edge @ 3m	
ANT	802.11ac VH40 CH06 2437MHz - R	
1	Horizontal	Fundamental
<p><b>Peak</b></p>	 <p>Site : 03CH15-HY            Condition : PEAK_BE_74 3m 91200_15_1620 HORIZONTAL            RBW:1000.000KHz VBW:3000.000KHz SWF:Auto            Detector : Peak            Project : 911104            Mode : 59            Setting : 16.5</p>	<p><b>Left blank</b></p>
<p><b>Avg.</b></p>	 <p>Site : 03CH15-HY            Condition : AVG_BE_54 3m 91200_15_1620 HORIZONTAL            RBW:1000.000KHz VBW:3000.000KHz SWF:Auto            Detector : Peak            Project : 911104            Mode : 59            Setting : 16.5</p>	<p><b>Left blank</b></p>



WIFI	2.4GHz 2400~2483.5MHz Band Edge @ 3m	
ANT	802.11ac VH40 CH06 2437MHz - L	
1	Vertical	Fundamental
<b>Peak</b>	<p>Site : 03CH15-HY            Condition : PEAK_BE_74 3m 91200_15_1620 VERTICAL            : RBW:1000.000kHz VBW:3000.000kHz SWT:Auto            Detector : Peak            Project : 911104            Mode : 59            Setting : 16.5</p>	<p>Site : 03CH15-HY            Condition : PEAK_74 3m 91200_15_1620 VERTICAL            : RBW:1000.000kHz VBW:3000.000kHz SWT:Auto            Detector : Peak            Project : 911104            Mode : 59            Setting : 16.5</p>
<b>Avg.</b>	<p>Site : 03CH15-HY            Condition : AVG_BE_54 3m 91200_15_1620 VERTICAL            : RBW:1000.000kHz VBW:3000.000kHz SWT:Auto            Detector : Peak            Project : 911104            Mode : 59            Setting : 16.5</p>	<p>Site : 03CH15-HY            Condition : AVG_54 3m 91200_15_1620 VERTICAL            : RBW:1000.000kHz VBW:3000.000kHz SWT:Auto            Detector : Peak            Project : 911104            Mode : 59            Setting : 16.5</p>

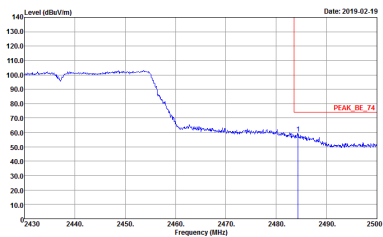
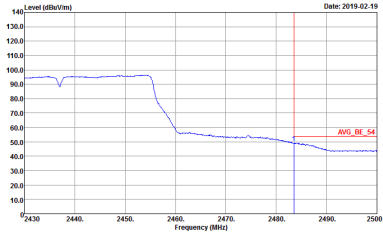

WIFI	2.4GHz 2400~2483.5MHz Band Edge @ 3m	
ANT	802.11ac VH40 CH06 2437MHz - R	
1	Vertical	Fundamental
<p><b>Peak</b></p>	 <p>Site : 03CH15-HY            Condition : PEAK_BE_74 3m 91200_15_1620 VERTICAL            RBW:1000.000KHz VBW:3000.000KHz SWT:Auto            Detector : Peak            Project : 911104            Mode : 59            Setting : 16.5</p>	<p><b>Left blank</b></p>
<p><b>Avg.</b></p>	 <p>Site : 03CH15-HY            Condition : AVG_BE_54 3m 91200_15_1620 VERTICAL            RBW:1000.000KHz VBW:3.000KHz SWT:Auto            Detector : Peak            Project : 911104            Mode : 59            Setting : 16.5</p>	<p><b>Left blank</b></p>

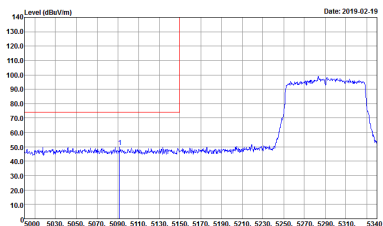
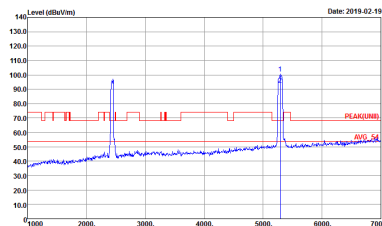
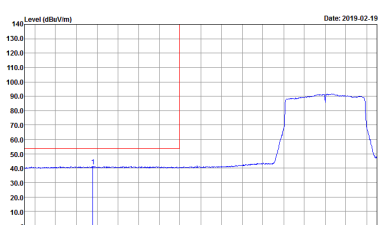

**Band 2 5250~5350MHz**  
**WIFI 802.11ac VHT80 (Band Edge @ 3m)**

WIFI	Band 2 5250~5350MHz Band Edge @ 3m	
ANT	802.11ac VHT80 CH58 5290MHz - L	
2	Horizontal	Fundamental
<b>Peak</b>	 <p>Site : 03CH15-HY            Condition : PEAK_BE_74 3m 91200_15_1620 HORIZONTAL            RBW:1000.000KHz VBW:3000.000KHz SWT:Auto            Detector : Peak            Project : 911104            Mode : 59            Setting : 17</p>	 <p>Site : 03CH15-HY            Condition : PEAK(UNIT) 3m 91200_15_1620 HORIZONTAL            RBW:1000.000KHz VBW:3000.000KHz SWT:Auto            Detector : Peak            Project : 911104            Mode : 59            Setting : 17</p>
<b>Avg.</b>	 <p>Site : 03CH15-HY            Condition : AVG_BE_54 3m 91200_15_1620 HORIZONTAL            RBW:1000.000KHz VBW:3.000KHz SWT:Auto            Detector : Peak            Project : 911104            Mode : 59            Setting : 17</p>	<b>Left blank</b>

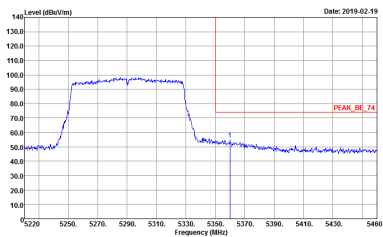
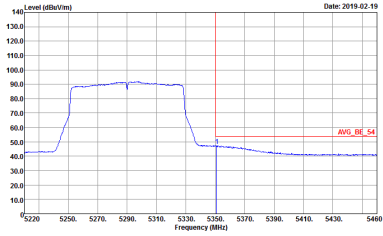

WIFI	Band 2 5250~5350MHz Band Edge @ 3m	
ANT	802.11ac VHT80 CH58 5290MHz - R	
2	Horizontal	Fundamental
<p><b>Peak</b></p>	 <p>Site : 03CH15-HY            Condition : PEAK_BE_74 3m 91200_15_1620 HORIZONTAL            Detector : Peak            Project : 911104            Mode : 59            Setting : 17</p>	<p><b>Left blank</b></p>
<p><b>Avg.</b></p>	 <p>Site : 03CH15-HY            Condition : AVG_BE_54 3m 91200_15_1620 HORIZONTAL            Detector : Peak            Project : 911104            Mode : 59            Setting : 17</p>	<p><b>Left blank</b></p>

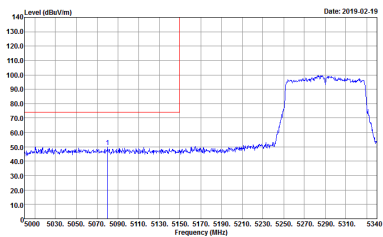
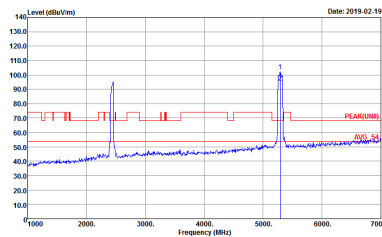
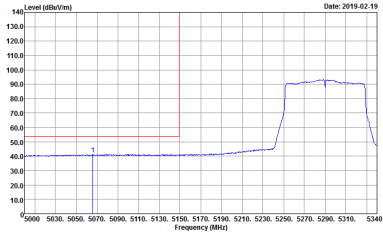

WIFI	Band 2 5250~5350MHz Band Edge @ 3m	
ANT	802.11ac VHT80 CH58 5290MHz - L	
2	Vertical	Fundamental
<p><b>Peak</b></p>	 <p>Date: 2019-02-19</p> <p>Site : 03CH15-HY            Condition : PEAK_BE_74 3m 9120D_15_1620 VERTICAL            : RBW:1000.000KHz VBW:3000.000KHz SWT:Auto            Detector : Peak            Project : 911104            Mode : 59            Setting : 17</p>	 <p>Date: 2019-02-19</p> <p>Site : 03CH15-HY            Condition : PEAK(LINII) 3m 9120D_15_1620 VERTICAL            : RBW:1000.000KHz VBW:3000.000KHz SWT:Auto            Detector : Peak            Project : 911104            Mode : 59            Setting : 17</p>
<p><b>Avg.</b></p>	 <p>Date: 2019-02-19</p> <p>Site : 03CH15-HY            Condition : AVG_BE_54 3m 9120D_15_1620 VERTICAL            : RBW:1000.000KHz VBW:3000.000KHz SWT:Auto            Detector : Peak            Project : 911104            Mode : 59            Setting : 17</p>	<p><b>Left blank</b></p>

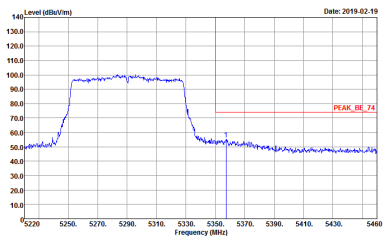
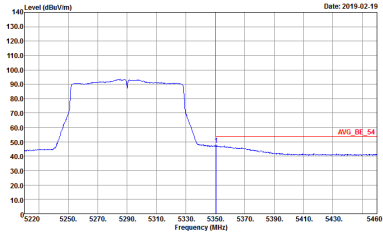

WIFI	Band 2 5250~5350MHz Band Edge @ 3m	
ANT	802.11ac VHT80 CH58 5290MHz - R	
2	Vertical	Fundamental
<p><b>Peak</b></p>	 <p>Site : 03CH15-HY            Condition : PEAK_BE_74 3m 9120D_15_1620 VERTICAL            Detector : Peak            Project : 911104            Mode : 59            Setting : 17</p>	<p><b>Left blank</b></p>
<p><b>Avg.</b></p>	 <p>Site : 03CH15-HY            Condition : AVG_BE_54 3m 9120D_15_1620 VERTICAL            Detector : Peak            Project : 911104            Mode : 59            Setting : 17</p>	<p><b>Left blank</b></p>



2.4GHz 2400~2483.5MHz + Band 2 - 5250~5350MHz

WIFI 802.11ac VHT40+ VHT80 (Harmonic @ 3m)

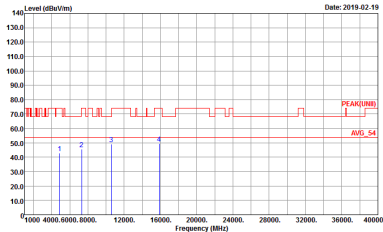
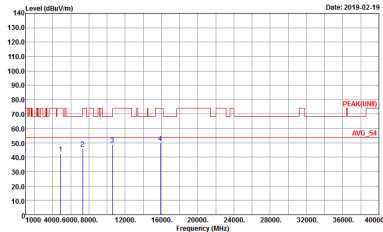
WIFI	2.4GHz 2400~2483.5MHz+ Band 2 5250~5350MHz Harmonic @ 3m	
ANT	802.11ac VHT40 CH06 2437MHz + VHT80 CH58 5290MHz	
Simultaneously	Horizontal	Vertical
<p>Peak</p> <p>Avg.</p>	 <p>Site : 03CH15-HY          Condition : PEAK(UNIT) 3m 91200_15_1620 HORIZONTAL          Detector : Peak          Project : 911104          Mode : 59</p>	 <p>Site : 03CH15-HY          Condition : PEAK(UNIT) 3m 91200_15_1620 VERTICAL          Detector : Peak          Project : 911104          Mode : 59</p>





Emission below 1GHz
WIFI 802.11ac VHT40+VHT80 (LF)

Table with 3 columns: WIFI, ANT, Simultaneously. It contains two graphs showing emission levels (dBuV/m) vs Frequency (MHz) for Horizontal and Vertical orientations. Includes metadata like Site, Condition, Detector, Project, and Mode.

### Appendix C. Duty Cycle Plots

Antenna	Band	Duty Cycle (%)	T(us)	1/T(kHz)	VBW Setting	Duty Factor (dB)
1	2.4GHz 802.11ac VHT40	90.48	950.00	1.05	3kHz	0.43
2	5GHz 802.11ac VHT80	86.11	465.00	2.15	3kHz	0.65

<Ant. 1>

802.11ac VHT40

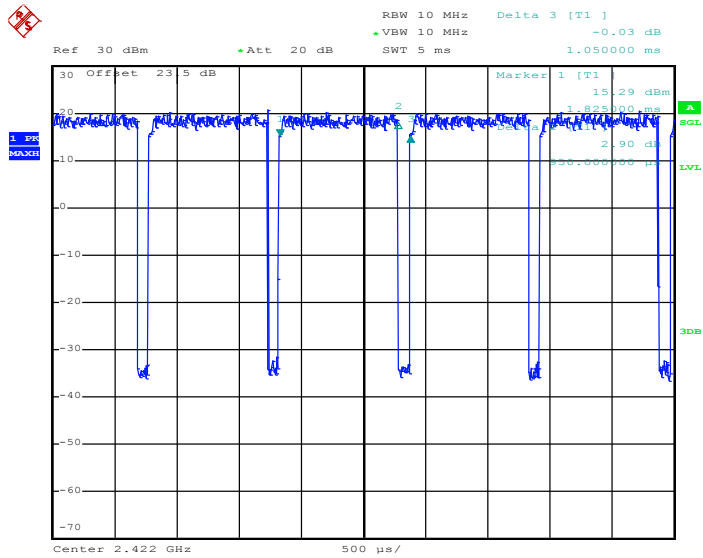

Date: 22.JAN.2019 00:39:10



<Ant. 2>

802.11ac VHT80

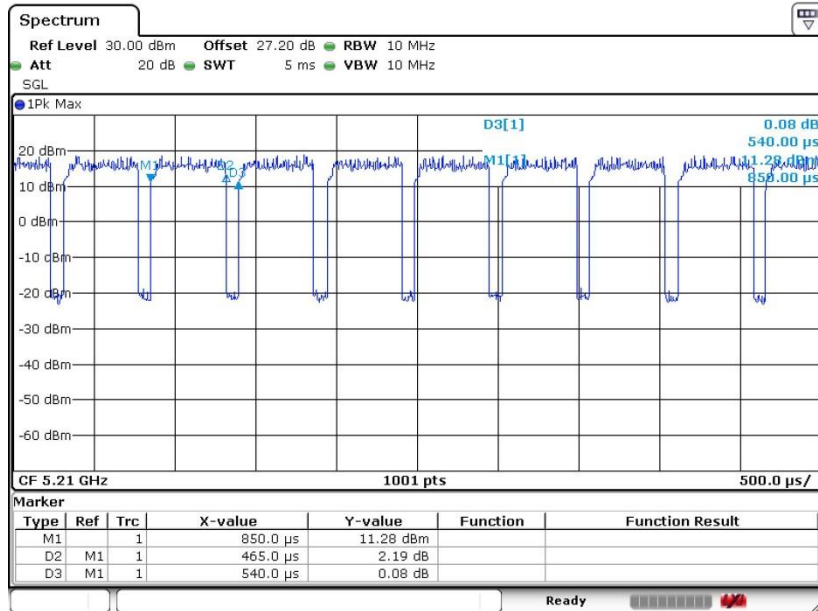

Date: 22.JAN.2019 17:14:31