



# SPORTON International Inc.

No. 52, Hwa Ya 1st Rd., Hwa Ya Technology Park, Kwei-Shan Hsiang, Tao Yuan Hsien, Taiwan, R.O.C.  
Ph: 886-3-327-3456 / FAX: 886-3-327-0973 / www.sporton.com.tw

## FCC RADIO TEST REPORT

Applicant's company	Zebra Technologies, Corp.
Applicant Address	1 Zebra Plaza Holtsville, NY 11742 USA
FCC ID	UZ7AP8432I
Manufacturer's company	Wistron NeWeb Corporation
Manufacturer Address	20 Park Avenue II, Hsinchu Science Park, Hsinchu 308 Taiwan

Product Name	802.11AC MU-MIMO, dual Radio, INT ANT
Brand Name	ZEBRA
Model Name	AP-8432I
Test Rule	47 CFR FCC Part 15 Subpart C § 15.247
Test Freq. Range	2402 ~ 2480MHz
Received Date	Feb. 01, 2016
Final Test Date	Feb. 23, 2016
Submission Type	Original Equipment

### Statement

**Test result included is only for the Bluetooth LE of the product.**

The test result in this report refers exclusively to the presented test model / sample.

Without written approval of SPORTON International Inc., the test report shall not be reproduced except in full.

The measurements and test results shown in this test report were made in accordance with the procedures and found in compliance with the limit given in **ANSI C63.10-2013, 47 CFR FCC Part 15 Subpart C** and **KDB558074 D01 v03r04**.

The test equipment used to perform the test is calibrated and traceable to NML/ROC.



## Table of Contents

<b>1. VERIFICATION OF COMPLIANCE .....</b>	<b>1</b>
<b>2. SUMMARY OF THE TEST RESULT .....</b>	<b>2</b>
<b>3. GENERAL INFORMATION .....</b>	<b>3</b>
3.1. Product Details.....	3
3.2. Accessories.....	3
3.3. Table for Filed Antenna.....	4
3.4. Table for Carrier Frequencies .....	5
3.5. Table for Test Modes.....	5
3.6. Table for Testing Locations.....	7
3.7. Table for Supporting Units .....	8
3.8. Table for Parameters of Test Software Setting .....	9
3.9. EUT Operation during Test .....	9
3.10. Duty Cycle.....	9
3.11. Test Configurations .....	10
<b>4. TEST RESULT .....</b>	<b>15</b>
4.1. AC Power Line Conducted Emissions Measurement.....	15
4.2. Maximum Conducted Output Power Measurement.....	23
4.3. Power Spectral Density Measurement .....	25
4.4. 6dB Spectrum Bandwidth Measurement .....	29
4.5. Radiated Emissions Measurement .....	33
4.6. Emissions Measurement .....	49
4.7. Antenna Requirements .....	55
<b>5. LIST OF MEASURING EQUIPMENTS .....</b>	<b>56</b>
<b>6. MEASUREMENT UNCERTAINTY.....</b>	<b>58</b>
<b>APPENDIX A. TEST PHOTOS .....</b>	<b>A1 ~ A5</b>
<b>APPENDIX B. RADIATED EMISSION CO-LOCATION REPORT.....</b>	<b>B1 ~ B7</b>



### History of This Test Report

REPORT NO.	VERSION	DESCRIPTION	ISSUED DATE
FR592302-09AB	Rev. 01	Initial issue of report	Mar. 15, 2016

## 1. VERIFICATION OF COMPLIANCE

Product Name : 802.11AC MU-MIMO, dual Radio, INT ANT  
Brand Name : ZEBRA  
Model No. : AP-8432I  
Applicant : Zebra Technologies, Corp.  
Test Rule Part(s) : 47 CFR FCC Part 15 Subpart C § 15.247

Sporton International as requested by the applicant to evaluate the EMC performance of the product sample received on Feb. 01, 2016 would like to declare that the tested sample has been evaluated and found to be in compliance with the tested rule parts. The data recorded as well as the test configuration specified is true and accurate for showing the sample's EMC nature.

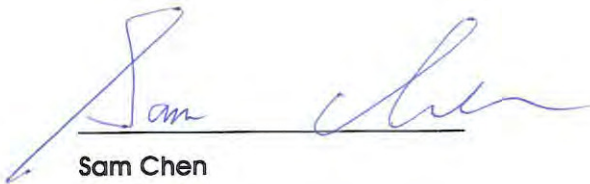

Sam Chen

SPORTON INTERNATIONAL INC.

## 2. SUMMARY OF THE TEST RESULT

Applied Standard: 47 CFR FCC Part 15 Subpart C				
Part	Rule Section	Description of Test	Result	Under Limit
4.1	15.207	AC Power Line Conducted Emissions	Complies	10.50 dB
4.2	15.247(b)(3)	Maximum Conducted Output Power	Complies	25.02 dB
4.3	15.247(e)	Power Spectral Density	Complies	17.54 dB
4.4	15.247(a)(2)	6dB Spectrum Bandwidth	Complies	-
4.5	15.247(d)	Radiated Emissions	Complies	3.13 dB
4.6	15.247(d)	Band Edge Emissions	Complies	3.43 dB
4.7	15.203	Antenna Requirements	Complies	-

### 3. GENERAL INFORMATION

#### 3.1. Product Details

Items	Description
Power Type	From Power Adapter or PoE
Modulation	DSSS
Data Rate (Mbps)	GFSK: 1
Frequency Range	2402 ~ 2480MHz
Channel Number	40 (37 hopping + 3 advertising channel)
Channel Band Width (99%)	1.39 MHz
Maximum Conducted Output Power	3.28 dBm
Carrier Frequencies	Please refer to section 3.4
Antenna	Please refer to section 3.3
Note : This device contains two radio transmitter module, radio 1 (FCC ID: UZ7CDR5G) and radio 2 (FCC ID: UZ7CDRDB).	

#### 3.2. Accessories

N/A

### 3.3. Table for Filed Antenna

Set	Brand	Model Name (Part Number)	Antenna Type	Connector	Indoor/Outdoor	Rmark	EUT/R(Radio)
1	ZEBRA	CEDAR-INT-ANT	Monopole	U.FL	Indoor	WLAN/BT	R1~R3

Note 1:

Set	Antenna Gain (dBi)			
	Radio 1 / 5G			
	Chain 1	Chain 2	Chain 3	Chain 4
1	6.8	6.7	6.6	5.9

Set	Antenna Gain (dBi)					
	Radio 2 / 2.4G			Radio 2 / 5G		
	Chain 1	Chain 2	Chain 3	Chain 1	Chain 2	Chain 3
1	4.1	4.4	4.4	5.9	5.4	5.9

Set	Antenna Gain (dBi)
	Radio 3 / BT
1	7.7

Note 2:

The EUT has three radios, Radio 1 supports WLAN 5GHz, Radio 2 supports WLAN 2.4GHz + 5GHz and Radio 3 supports Bluetooth functions.

For Bluetooth Function	
Mode	Chain 1
For 1TX	TX/RX

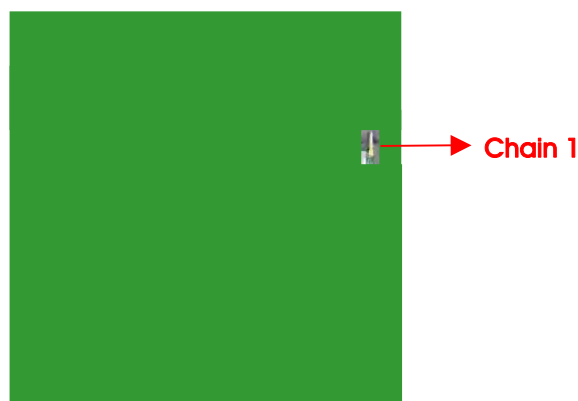

### 3.4. Table for Carrier Frequencies

Frequency Band	Channel No.	Frequency	Channel No.	Frequency
2400~2483.5MHz	0	2402 MHz	20	2442 MHz
	1	2404 MHz	:	:
	2	2406 MHz	37	2476 MHz
	:	:	38	2478 MHz
	18	2438 MHz	39	2480 MHz
	19	2440 MHz	-	-

### 3.5. Table for Test Modes

Preliminary tests were performed in different data rate to find the worst radiated emission. The data rate shown in the table below is the worst-case rate with respect to the specific test item. Investigation has been done on all the possible configurations for searching the worst cases. The following table is a list of the test modes shown in this test report.

Test Items	Mode	Data Rate	Channel	Chain
AC Power Line Conducted Emissions	Normal Link	-	-	-
Maximum Conducted Output Power Power Spectral Density	GFSK	1 Mbps	0/20/39	1
6dB Spectrum Bandwidth	GFSK	1 Mbps	0/20/39	1
Radiated Emissions 9kHz~1GHz	Normal Link	-	-	-
Radiated Emissions 1GHz~10 <sup>th</sup> Harmonic	GFSK	1 Mbps	0/20/39	1
Band Edge Emissions	GFSK	1 Mbps	0/20/39	1

Note1:

The adapter and PoE are for measurement only, would not be marketed.

The adapter and PoE information as below:

Power	Brand	Model
PoE	Symbol	PD-9001GR/AT/AC
Adapter	PHIHONG	PSAC45W-480

Note2: The power does not affect the test result of RF tests, so only adapter was tested and recorded in this report for Radiated Emission above 1GHz and Radiated Emission Co-location tests.

Note3: All the specification of test configurations and test modes were based on customer's request

Note4: The USB port can not be used by end user. It is generally used for updating FW by professional installer.



The following test modes were performed for all tests:

Conducted Emission test					
The EUT was performed at Y axis and Z axis position for Radiated emission below 1GHz test, and the worst case was found at Y axis. So the measurement will follow this same test configuration.					
Mode	Y axis	Z axis	Set 1	Adapter	PoE
1	●	-	● Radio1/5G Radio2/2.4G Radio3/BT	●	-
2	●	-	● Radio1/5G Radio2/5G Radio3/BT	●	-
3 Note1	●	-	● Radio1/5G Radio2/2.4G Radio3/BT	-	●
Note1: Mode 1 has been evaluated to be the worst case between Mode 1~2, thus measurement for Mode 3 will follow this same test mode. All test results were recorded in the report.					

Radiated Emissions below 1GHz test					
Mode	Y axis	Z axis	Set 1	Adapter	PoE
1	●	-	● Radio1/5G Radio2/2.4G Radio3/BT	●	-
2	-	●	● Radio1/5G Radio2/2.4G Radio3/BT	●	-
3 Note1	●	-	● Radio1/5G Radio2/5G Radio3/BT	●	-
4 Note2	●	-	● Radio1/5G Radio2/5G Radio3/BT	-	●
Note1: Mode 1 has been evaluated to be the worst case between Mode 1~2, thus measurement for Mode 3 will follow this same test mode. Note2: Mode 3 has been evaluated to be the worst case among Mode 1~3, thus measurement for Mode 4 will follow this same test mode. All test results were recorded in the report.					

Radiated Emissions above 1GHz test				
The EUT was performed at Y axis and Z axis position, and the worst case was found at Y axis. So the measurement will follow this same test configuration.				
Mode	Y axis	Z axis	Set 1	Adapter
1	●	-	●	●

Radiated Emission Co-location test				
Mode	Y axis	Z axis	Set 1	Adapter
1	●	-	● Radio1/5G Radio2/2.4G Radio3/BT	●
2	-	●	● Radio1/5G Radio2/2.4G Radio3/BT	●
3 Note1	●	-	● Radio1/5G Radio2/5G Radio3/BT	●
Note1: Mode 1 has been evaluated to be the worst case between Mode 1~2, thus measurement for Mode 3 will follow this same test mode. All test results were recorded in the report.				

#### For Co-location MPE Test:

The EUT could be applied with Radio 1 (5GHz WLAN function FCC ID: UZ7CDR5G) + Radio 2 (2.4/5GHz WLAN function FCC ID: UZ7CDRDB) + Radio 3 (BT function FCC ID: UZ7AP8432I); therefore Co-location Maximum Permissible Exposure (Please refer to FA592302-09).

### 3.6. Table for Testing Locations

Test Site Location				
Address:	No.8, Lane 724, Bo-ai St., Jhubei City, Hsinchu County 302, Taiwan, R.O.C.			
TEL:	886-3-656-9065			
FAX:	886-3-656-9085			
Test Site No.	Site Category	Location	FCC Reg. No.	IC File No.
03CH01-CB	SAC	Hsin Chu	262045	IC 4086D
CO01-CB	Conduction	Hsin Chu	262045	IC 4086D
TH01-CB	OVEN Room	Hsin Chu	-	-

Open Area Test Site (OATS); Semi Anechoic Chamber (SAC).

### 3.7. Table for Supporting Units

For Test Site No: 03CH01-CB

<Below 1GHz>

For Adapter mode:

Support Unit	Brand	Model	FCC ID
NB*4	DELL	E4300	DoC
Bluetooth tester	Anritsu	MT8852B	DoC
Flash disk	Transcend	JF700	DoC
PoE PD Simulator (PD load)	WNC	PDS-16	DoC
Adapter	PHIHONG	PSAC45W-480	N/A

For PoE mode:

Support Unit	Brand	Model	FCC ID
NB*4	DELL	E4300	DoC
Bluetooth tester	Anritsu	MT8852B	DoC
Flash disk	Transcend	JF700	DoC
PoE PD Simulator (PD load)	WNC	PDS-16	DoC
PoE	Symbol	PD-9001GR/AT/AC	DoC

<Aelow 1GHz>

Support Unit	Brand	Model	FCC ID
NB	DELL	E4300	DoC

For Test Site No: CO01-CB

For Adapter mode:

Support Unit	Brand	Model	FCC ID
NB*4	DELL	E6430	DoC
Bluetooth tester	Anritsu	MT8852B	DoC
Flash disk	Silicon	I-Series	DoC
PoE PD Simulator (PD load)	WNC	PDS-16	DoC
Adapter	PHIHONG	PSAC45W-480	N/A

**For PoE mode:**

Support Unit	Brand	Model	FCC ID
NB*4	DELL	E6430	DoC
Bluetooth tester	Anritsu	MT8852B	DoC
Flash disk	Silicon	I-Series	DoC
PoE PD Simulator (PD load)	WNC	PDS-16	DoC
PoE	Symbol	PD-9001GR/AT/AC	DoC

**For Test Site No: TH01-CB**

Support Unit	Brand	Model	FCC ID
NB	DELL	E4300	DoC

### 3.8. Table for Parameters of Test Software Setting

During testing, Channel and Power Controlling Software provided by the customer was used to control the operating channel as well as the output power level. The RF output power selection is for the setting of RF output power expected by the customer and is going to be fixed on the firmware of the final end product.

**Power Parameters:**

Test Software Version	DoS		
Frequency	2402 MHz	2442 MHz	2480 MHz
Power Parameters	Default	Default	Default

### 3.9. EUT Operation during Test

The EUT was programmed to be in continuously transmitting mode.

### 3.10. Duty Cycle

Mode	On Time (ms)	On+Off Time (ms)	Duty Cycle (%)	Duty Factor (dB)	1/T Minimum VBW (kHz)
GFSK	0.391	0.621	63.01%	2.01	2.56

### 3.11. Test Configurations

#### 3.11.1. AC Power Line Conduction Emissions Test Configuration

For Adapter Mode:

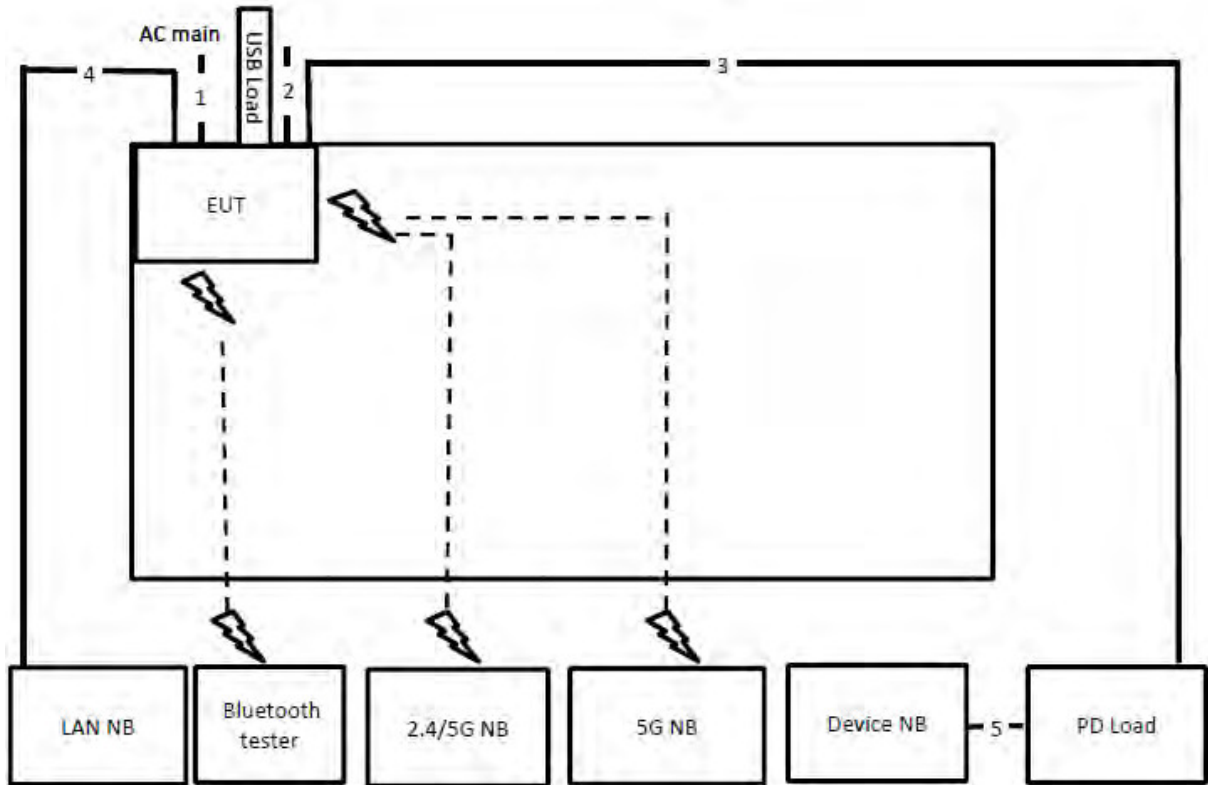

Item	Connection	Shielded	Length
1	Power cable	No	4.3m
2	Console cable	No	1.5m
3	RJ-45 cable	No	10m
4	RJ-45 cable	No	10m
5	RJ-45 cable	No	1.5m

For PoE Mode:

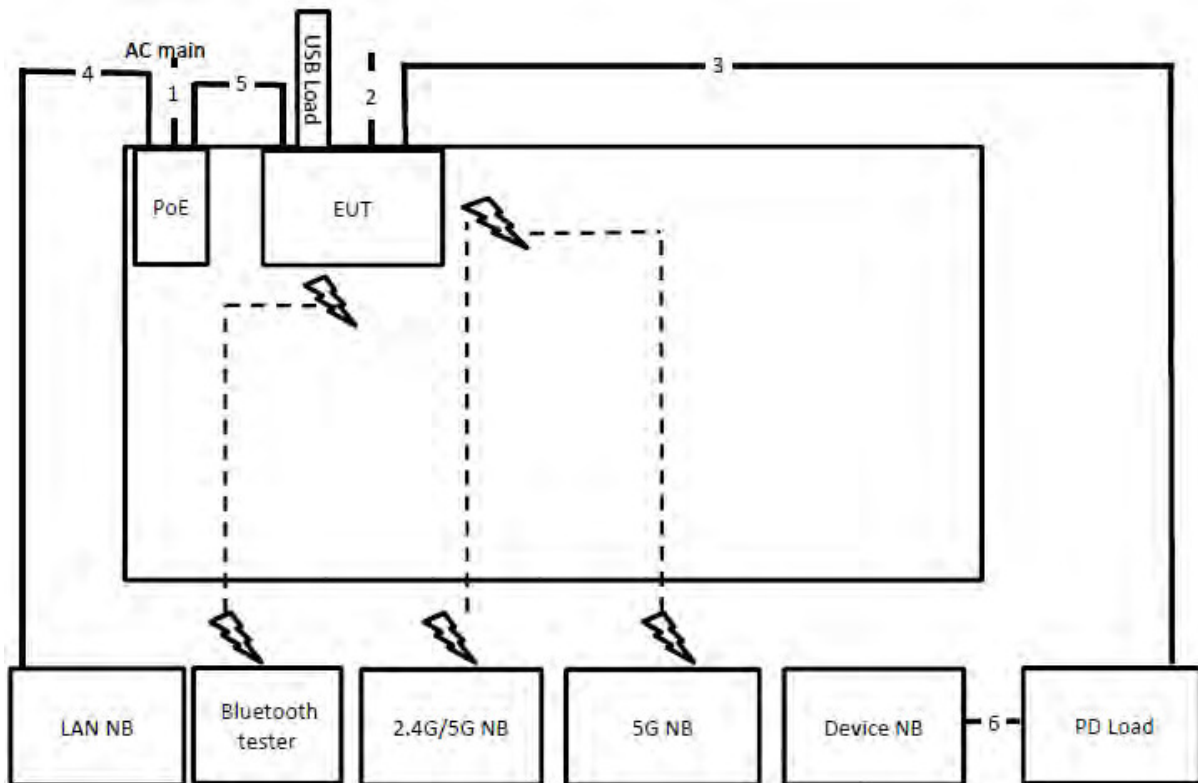

Item	Connection	Shielded	Length
1	Power cable	No	1.5m
2	Console cable	No	1.5m
3	RJ-45 cable	No	10m
4	RJ-45 cable	No	10m
5	RJ-45 cable	No	1.5m
6	RJ-45 cable	No	1.5m

### 3.11.2. Radiation Emissions Test Configuration

Test Configuration: 30MHz~1GHz

For Adapter Mode:

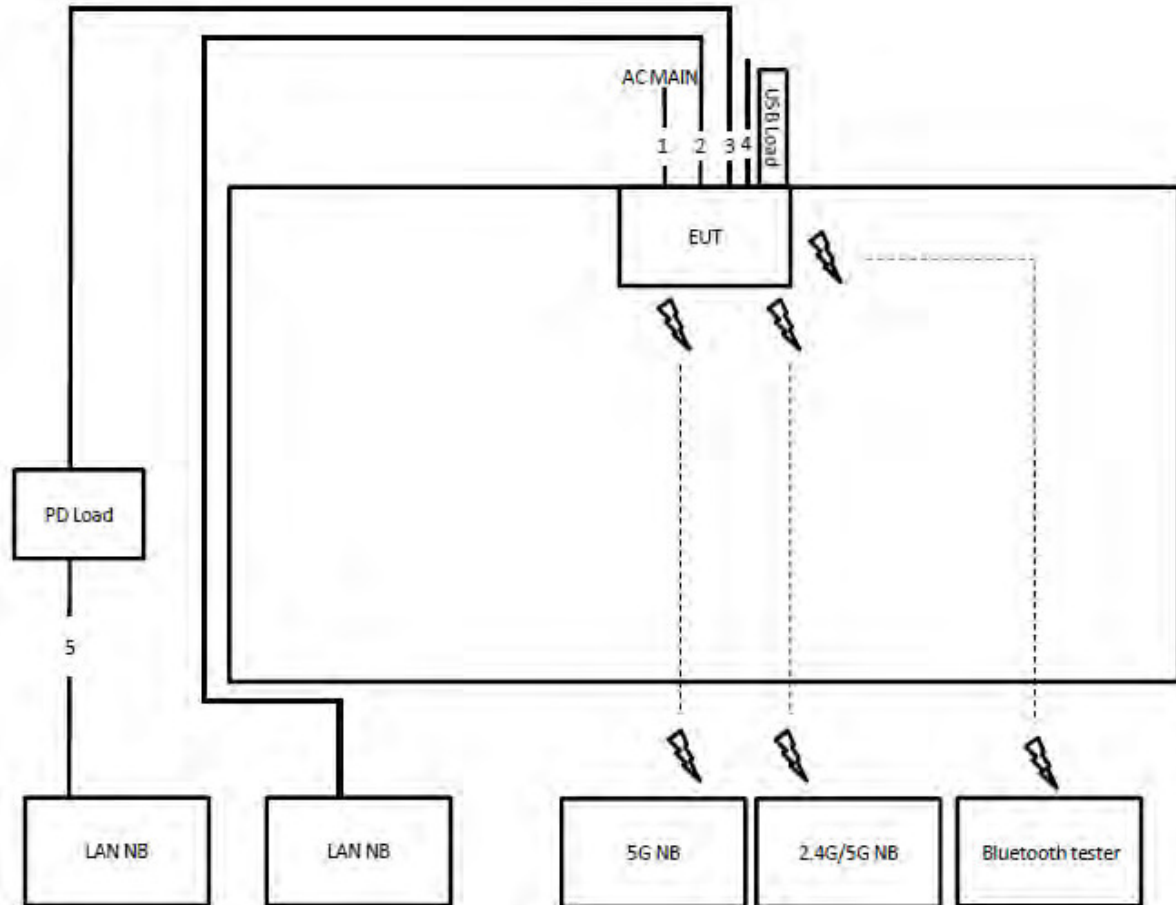

Item	Connection	Shielded	Length
1	Power cable	No	4.3m
2	RJ-45 cable	No	10m
3	RJ-45 cable	No	10m
4	Console cable	No	1.5m
5	RJ-45 cable	No	1m

For PoE Mode:

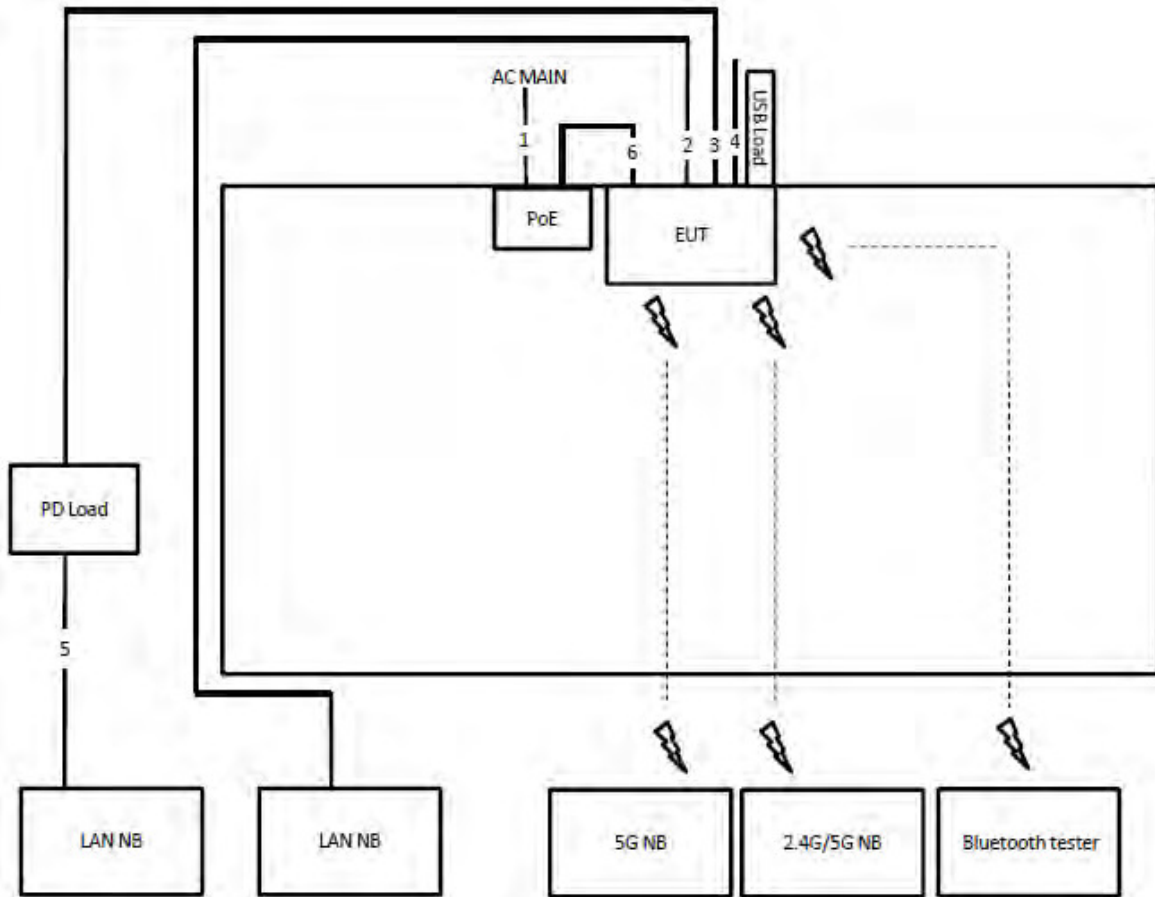

Item	Connection	Shielded	Length
1	Power cable	No	1.5m
2	RJ-45 cable	No	10m
3	RJ-45 cable	No	10m
4	Console cable	No	1.5m
5	RJ-45 cable	No	1m
6	RJ-45 cable	No	1.5m



Test Configuration: above 1GHz

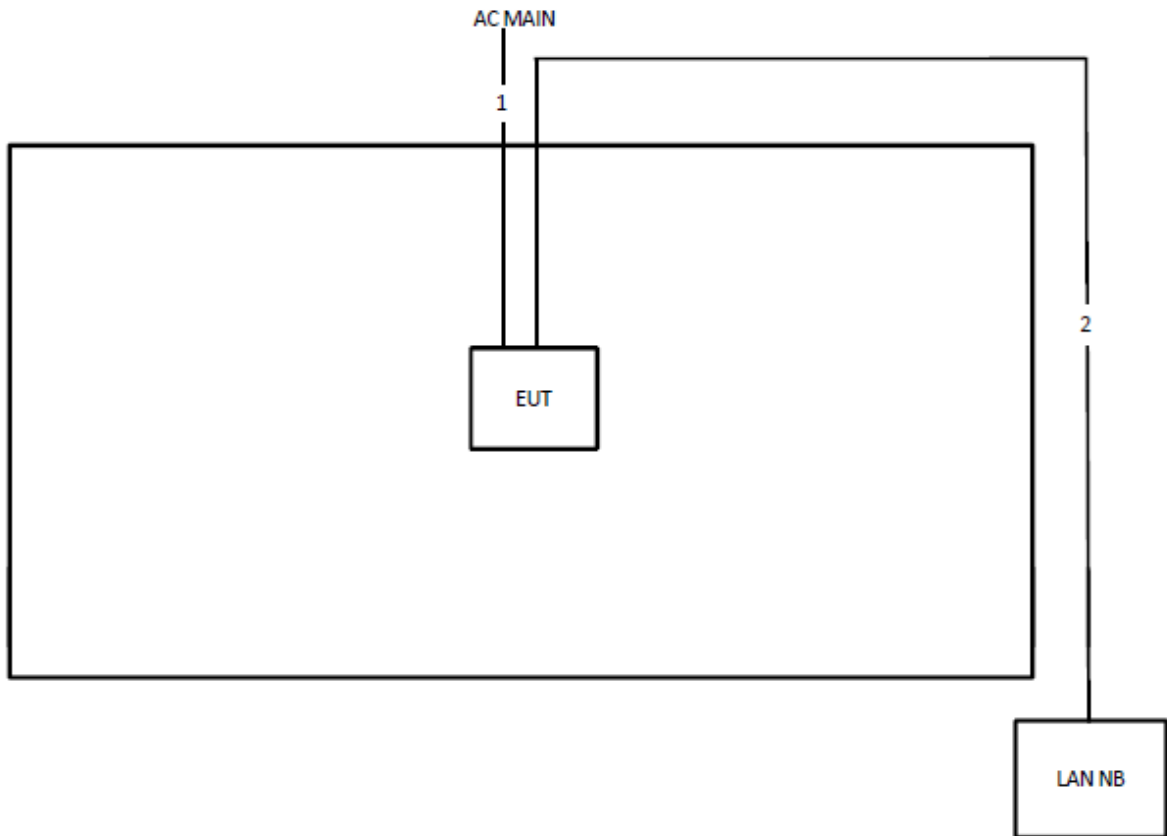

Item	Connection	Shielded	Length
1	Power cable	No	4.3m
2	RJ-45 cable	No	10m

## 4. TEST RESULT

### 4.1. AC Power Line Conducted Emissions Measurement

#### 4.1.1. Limit

For this product which is designed to be connected to the AC power line, the radio frequency voltage that is conducted back onto the AC power line on any frequency or frequencies within the band 150 kHz to 30 MHz shall not exceed below limits table.

Frequency (MHz)	QP Limit (dBuV)	AV Limit (dBuV)
0.15~0.5	66~56	56~46
0.5~5	56	46
5~30	60	50

#### 4.1.2. Measuring Instruments and Setting

Please refer to section 5 of equipments list in this report. The following table is the setting of the receiver.

Receiver Parameters	Setting
Attenuation	10 dB
Start Frequency	0.15 MHz
Stop Frequency	30 MHz
IF Bandwidth	9 kHz

#### 4.1.3. Test Procedures

1. Configure the EUT according to ANSI C63.10. The EUT or host of EUT has to be placed 0.4 meter far from the conducting wall of the shielding room and at least 80 centimeters from any other grounded conducting surface.
2. Connect EUT or host of EUT to the power mains through a line impedance stabilization network (LISN).
3. All the support units are connected to the other LISNs. The LISN should provide 50uH/50ohms coupling impedance.
4. The frequency range from 150 kHz to 30 MHz was searched.
5. Set the test-receiver system to Peak Detect Function and Specified Bandwidth with Maximum Hold Mode.
6. The measurement has to be done between each power line and ground at the power terminal.

#### 4.1.4. Test Setup Layout

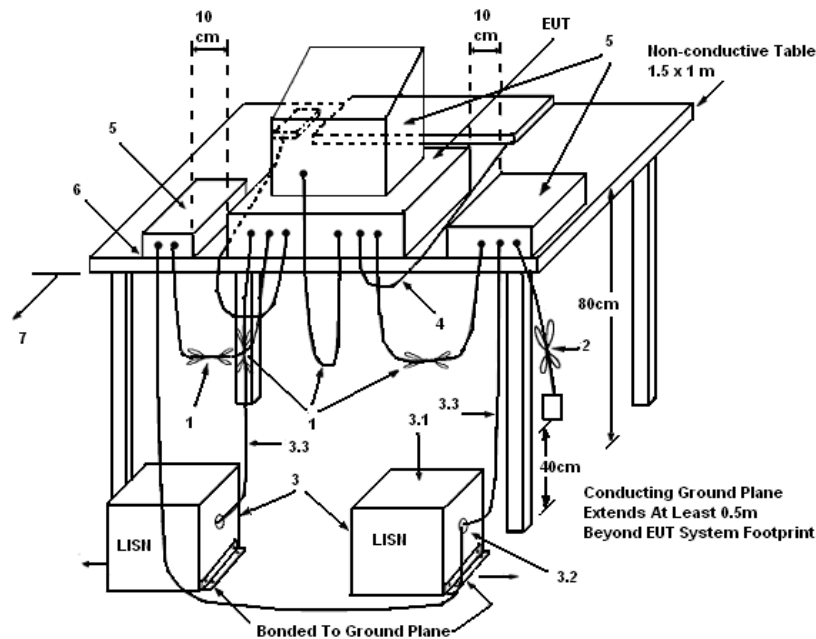

#### LEGEND:

- (1) Interconnecting cables that hang closer than 40 cm to the ground plane shall be folded back and forth in the center forming a bundle 30 to 40 cm long.
- (2) I/O cables that are not connected to a peripheral shall be bundled in the center. The end of the cable may be terminated, if required, using the correct terminating impedance. The overall length shall not exceed 1 m.
- (3) EUT connected to one LISN. Unused LISN measuring port connectors shall be terminated in 50 Ω. LISN can be placed on top of, or immediately beneath, reference ground plane.
  - (3.1) All other equipment powered from additional LISN(s).
  - (3.2) Multiple outlet strip can be used for multiple power cords of non-EUT equipment.
  - (3.3) LISN at least 80 cm from nearest part of EUT chassis.
- (4) Cables of hand-operated devices, such as keyboards, mice, etc., shall be placed as for normal use.
- (5) Non-EUT components of EUT system being tested.
- (6) Rear of EUT, including peripherals, shall all be aligned and flush with rear of tabletop.
- (7) Rear of tabletop shall be 40 cm removed from a vertical conducting plane that is bonded to the ground plane.

#### 4.1.5. Test Deviation

There is no deviation with the original standard.

#### 4.1.6. EUT Operation during Test

The EUT was placed on the test table and programmed in normal function.

4.1.7. Results of AC Power Line Conducted Emissions Measurement

Temperature	20°C	Humidity	50%
Test Engineer	Deven Huang	Phase	Line
Configuration	Normal Link	Test Mode	Mode 1

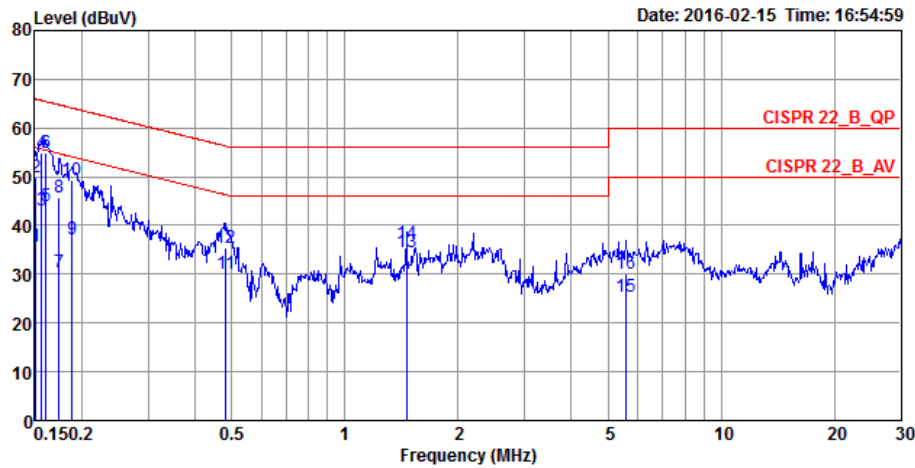

	Freq	Level	Over Limit	Limit Line	Read Level	LISN Factor	Cable Loss	Pol/Phase	Remark
	MHz	dBuV	dB	dBuV	dBuV	dB	dB		
1	0.1508	35.69	-20.27	55.96	25.74	9.93	0.02	LINE	Average
2	0.1508	49.83	-16.13	65.96	39.88	9.93	0.02	LINE	QP
3	0.1565	42.98	-12.67	55.65	33.03	9.93	0.02	LINE	Average
4	0.1565	54.99	-10.66	65.65	45.04	9.93	0.02	LINE	QP
5	0.1607	43.92	-11.51	55.43	33.97	9.93	0.02	LINE	Average
6	0.1607	54.87	-10.56	65.43	44.92	9.93	0.02	LINE	QP
7	0.1740	30.46	-24.31	54.77	20.51	9.93	0.02	LINE	Average
8	0.1740	45.88	-18.89	64.77	35.93	9.93	0.02	LINE	QP
9	0.1884	37.32	-16.79	54.11	27.37	9.93	0.02	LINE	Average
10	0.1884	49.31	-14.80	64.11	39.36	9.93	0.02	LINE	QP
11	0.4837	29.97	-16.30	46.27	19.99	9.94	0.04	LINE	Average
12	0.4837	35.32	-20.95	56.27	25.34	9.94	0.04	LINE	QP
13	1.4562	34.55	-11.45	46.00	24.51	9.98	0.06	LINE	Average
14	1.4562	36.38	-19.62	56.00	26.34	9.98	0.06	LINE	QP
15	5.5936	25.49	-24.51	50.00	15.30	10.08	0.11	LINE	Average
16	5.5936	30.18	-29.82	60.00	19.99	10.08	0.11	LINE	QP

Temperature	20°C	Humidity	50%
Test Engineer	Deven Huang	Phase	Neutral
Configuration	Normal Link	Test Mode	Mode 1

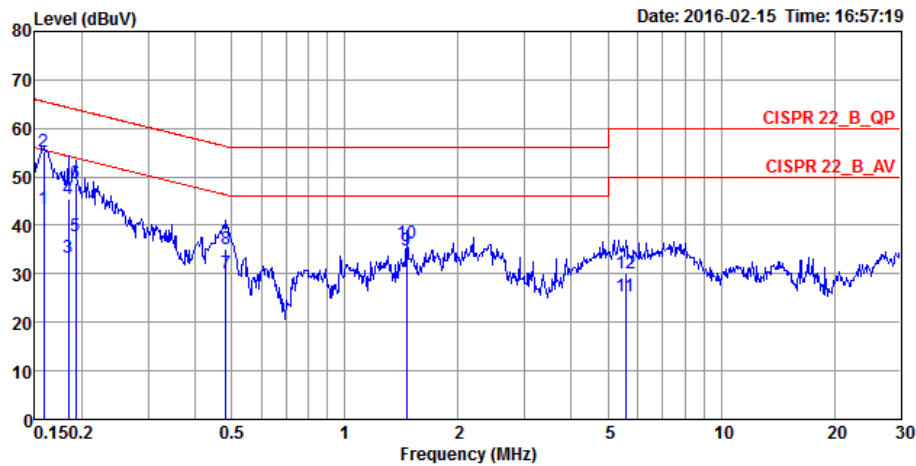

	Freq	Level	Over Limit	Limit Line	Read Level	LISN Factor	Cable Loss	Pol/Phase	Remark
	MHz	dBuV	dB	dBuV	dBuV	dB	dB		
1	0.1582	43.40	-12.16	55.56	33.60	9.78	0.02	NEUTRAL	Average
2	0.1582	55.06	-10.50	65.56	45.26	9.78	0.02	NEUTRAL	QP
3	0.1844	33.27	-21.01	54.28	23.46	9.79	0.02	NEUTRAL	Average
4	0.1844	45.55	-18.73	64.28	35.74	9.79	0.02	NEUTRAL	QP
5	0.1924	37.90	-16.03	53.93	28.09	9.79	0.02	NEUTRAL	Average
6	0.1924	48.76	-15.17	63.93	38.95	9.79	0.02	NEUTRAL	QP
7	0.4837	30.13	-16.14	46.27	20.30	9.79	0.04	NEUTRAL	Average
8	0.4837	35.23	-21.04	56.27	25.40	9.79	0.04	NEUTRAL	QP
9	1.4562	34.75	-11.25	46.00	24.86	9.83	0.06	NEUTRAL	Average
10	1.4562	36.44	-19.56	56.00	26.55	9.83	0.06	NEUTRAL	QP
11	5.5641	25.25	-24.75	50.00	15.22	9.92	0.11	NEUTRAL	Average
12	5.5641	30.19	-29.81	60.00	20.16	9.92	0.11	NEUTRAL	QP

Note: Level = Read Level + LISN Factor + Cable Loss.

Temperature	20°C	Humidity	50%
Test Engineer	Deven Huang	Phase	Line
Configuration	Normal Link	Test Mode	Mode 2

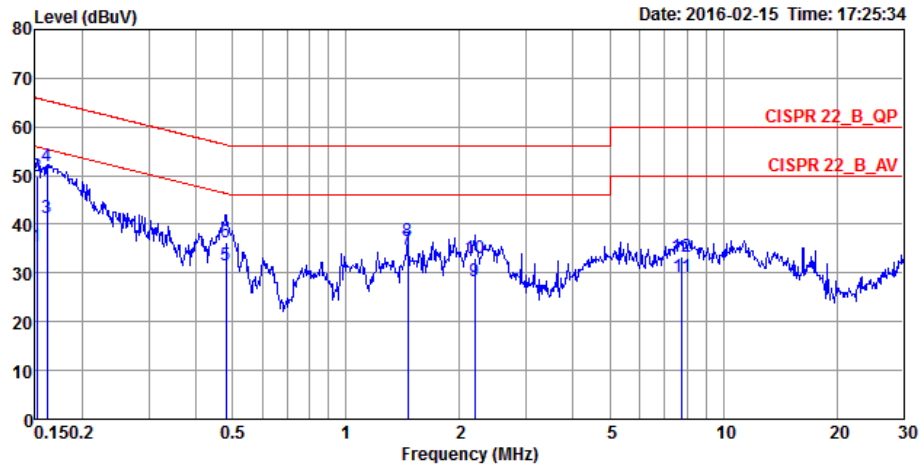

	Freq	Level	Over Limit	Limit Line	Read Level	LISN Factor	Cable Loss	Pol/Phase	Remark
	MHz	dBuV	dB	dBuV	dBuV	dB	dB		
1	0.1516	35.44	-20.47	55.91	25.49	9.93	0.02	LINE	Average
2	0.1516	49.87	-16.04	65.91	39.92	9.93	0.02	LINE	QP
3	0.1616	41.41	-13.97	55.38	31.46	9.93	0.02	LINE	Average
4	0.1616	51.93	-13.45	65.38	41.98	9.93	0.02	LINE	QP
5	0.4812	31.57	-14.75	46.32	21.59	9.94	0.04	LINE	Average
6	0.4812	36.43	-19.89	56.32	26.45	9.94	0.04	LINE	QP
7	1.4562	34.83	-11.17	46.00	24.79	9.98	0.06	LINE	Average
8	1.4562	36.63	-19.37	56.00	26.59	9.98	0.06	LINE	QP
9	2.1898	28.36	-17.64	46.00	18.31	9.99	0.06	LINE	Average
10	2.1898	33.12	-22.88	56.00	23.07	9.99	0.06	LINE	QP
11	7.7689	29.22	-20.78	50.00	18.93	10.13	0.16	LINE	Average
12	7.7689	33.25	-26.75	60.00	22.96	10.13	0.16	LINE	QP

Temperature	20°C	Humidity	50%
Test Engineer	Deven Huang	Phase	Neutral
Configuration	Normal Link	Test Mode	Mode 2

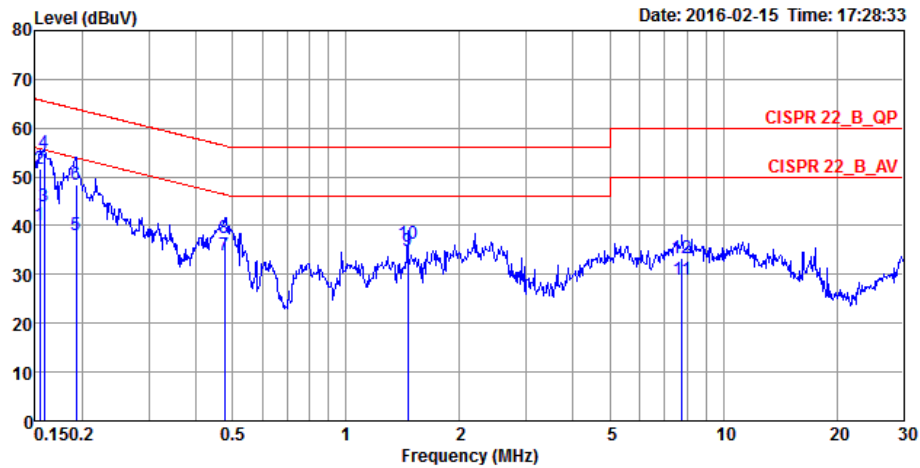

	Freq	Level	Over Limit	Limit Line	Read Level	LISN Factor	Cable Loss	Pol/Phase	Remark
	MHz	dBuV	dB	dBuV	dBuV	dB	dB		
1	0.1540	40.07	-15.71	55.78	30.27	9.78	0.02	NEUTRAL	Average
2	0.1540	51.64	-14.14	65.78	41.84	9.78	0.02	NEUTRAL	QP
3	0.1582	44.10	-11.46	55.56	34.30	9.78	0.02	NEUTRAL	Average
4	0.1582	54.86	-10.70	65.56	45.06	9.78	0.02	NEUTRAL	QP
5	0.1924	38.04	-15.89	53.93	28.23	9.79	0.02	NEUTRAL	Average
6	0.1924	48.44	-15.49	63.93	38.63	9.79	0.02	NEUTRAL	QP
7	0.4761	34.02	-12.39	46.41	24.19	9.79	0.04	NEUTRAL	Average
8	0.4761	37.54	-18.87	56.41	27.71	9.79	0.04	NEUTRAL	QP
9	1.4562	34.75	-11.25	46.00	24.86	9.83	0.06	NEUTRAL	Average
10	1.4562	36.44	-19.56	56.00	26.55	9.83	0.06	NEUTRAL	QP
11	7.7689	28.92	-21.08	50.00	18.79	9.97	0.16	NEUTRAL	Average
12	7.7689	33.45	-26.55	60.00	23.32	9.97	0.16	NEUTRAL	QP

Note: Level = Read Level + LISN Factor + Cable Loss.

Temperature	20°C	Humidity	50%
Test Engineer	Deven Huang	Phase	Line
Configuration	Normal Link	Test Mode	Mode 3

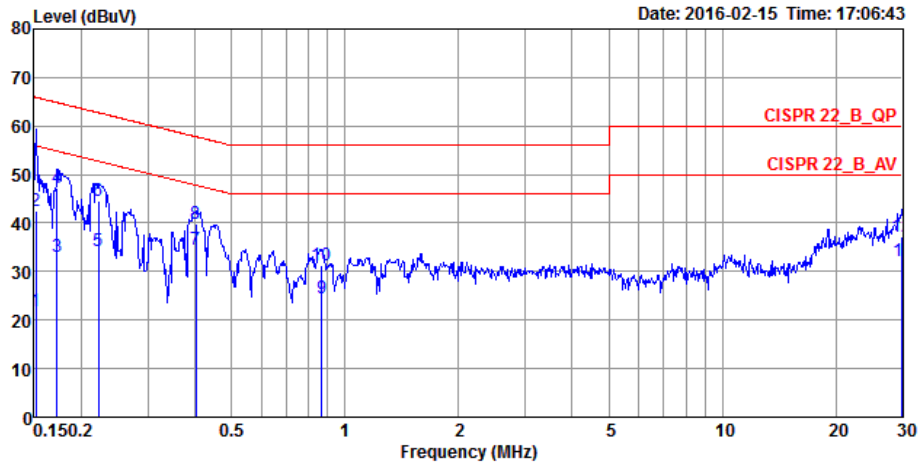

	Freq	Level	Over Limit	Limit Line	Read Level	LISN Factor	Cable Loss	Pol/Phase	Remark
	MHz	dBuV	dB	dBuV	dBuV	dB	dB		
1	0.1516	21.77	-34.14	55.91	11.82	9.93	0.02	LINE	Average
2	0.1516	42.55	-23.36	65.91	32.60	9.93	0.02	LINE	QP
3	0.1722	33.08	-21.78	54.86	23.13	9.93	0.02	LINE	Average
4	0.1722	47.34	-17.52	64.86	37.39	9.93	0.02	LINE	QP
5	0.2220	34.11	-18.63	52.74	24.15	9.93	0.03	LINE	Average
6	0.2220	44.53	-18.21	62.74	34.57	9.93	0.03	LINE	QP
7	0.4019	34.47	-13.34	47.81	24.50	9.93	0.04	LINE	Average
8	0.4019	39.75	-18.06	57.81	29.78	9.93	0.04	LINE	QP
9	0.8664	24.53	-21.47	46.00	14.53	9.96	0.04	LINE	Average
10	0.8664	31.21	-24.79	56.00	21.21	9.96	0.04	LINE	QP
11	30.0000	32.28	-17.72	50.00	21.32	10.68	0.28	LINE	Average
12	30.0000	37.13	-22.87	60.00	26.17	10.68	0.28	LINE	QP



Temperature	20°C	Humidity	50%
Test Engineer	Deven Huang	Phase	Neutral
Configuration	Normal Link	Test Mode	Mode 3

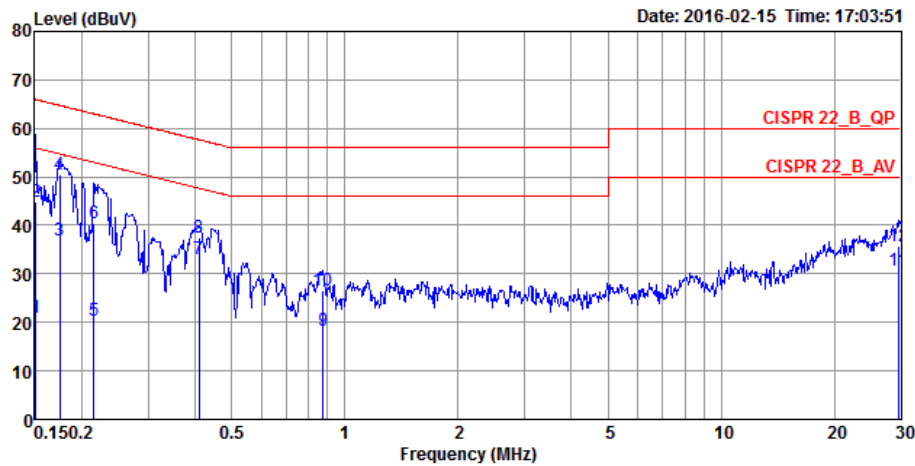

	Freq	Level	Over Limit	Limit Line	Read Level	LISN Factor	Cable Loss	Pol/Phase	Remark
	MHz	dBuV	dB	dBuV	dBuV	dB	dB		
1	0.1508	20.88	-35.08	55.96	11.08	9.78	0.02	NEUTRAL	Average
2	0.1508	45.01	-20.95	65.96	35.21	9.78	0.02	NEUTRAL	QP
3	0.1749	36.99	-17.73	54.72	27.18	9.79	0.02	NEUTRAL	Average
4	0.1749	50.50	-14.22	64.72	40.69	9.79	0.02	NEUTRAL	QP
5	0.2151	20.36	-32.65	53.01	10.55	9.79	0.02	NEUTRAL	Average
6	0.2151	40.58	-22.43	63.01	30.77	9.79	0.02	NEUTRAL	QP
7	0.4105	33.03	-14.61	47.64	23.20	9.79	0.04	NEUTRAL	Average
8	0.4105	37.45	-20.19	57.64	27.62	9.79	0.04	NEUTRAL	QP
9	0.8757	18.32	-27.68	46.00	8.46	9.81	0.05	NEUTRAL	Average
10	0.8757	26.71	-29.29	56.00	16.85	9.81	0.05	NEUTRAL	QP
11	29.5269	30.80	-19.20	50.00	20.18	10.34	0.28	NEUTRAL	Average
12	29.5269	35.62	-24.38	60.00	25.00	10.34	0.28	NEUTRAL	QP

Note: Level = Read Level + LISN Factor + Cable Loss.

## 4.2. Maximum Conducted Output Power Measurement

### 4.2.1. Limit

The limit for output power is 30dBm.

### 4.2.2. Measuring Instruments and Setting

Please refer to section 5 of equipments list in this report. The following table is the setting of the power meter.

Power Meter Parameter	Setting
Bandwidth	50MHz bandwidth is greater than the EUT emission bandwidth
Detector	Average

### 4.2.3. Test Procedures

1. Test procedures refer KDB558074 D01 v03r04 section 9.2.3.2.
2. This procedure provides an alternative for determining the RMS output power using a broadband RF average power meter with a thermocouple detector.

### 4.2.4. Test Setup Layout

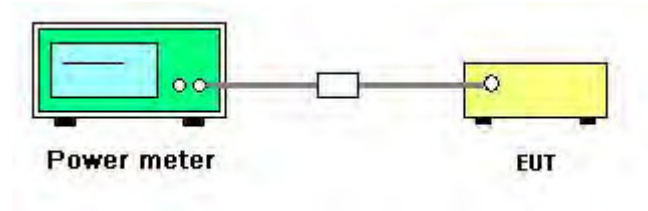

### 4.2.5. Test Deviation

There is no deviation with the original standard.

### 4.2.6. EUT Operation during Test

The EUT was programmed to be in continuously transmitting mode.

#### 4.2.7. Test Result of Maximum Conducted Output Power

Temperature	25°C	Humidity	59%
Test Engineer	Peter Wu	Configurations	GFSK
Test Date	Feb. 18, 2016		

Channel	Frequency	Conducted Power (dBm)	Max. Limit (dBm)	Result
0	2402 MHz	3.01	28.30	Complies
20	2442 MHz	3.28	28.30	Complies
39	2480 MHz	3.12	28.30	Complies

Note: Gain = 7.70dBi > 6dBi, so limit = 30-(7.70-6)=28.30dBm

### 4.3. Power Spectral Density Measurement

#### 4.3.1. Limit

For digitally modulated systems, the power spectral density conducted from the intentional radiator to the antenna shall not be greater than 8 dBm in any 3 kHz band during any time interval of continuous transmission.

#### 4.3.2. Measuring Instruments and Setting

Please refer to section 5 of equipments list in this report. The following table is the setting of the spectrum analyzer.

Spectrum Parameter	Setting
Attenuation	Auto
Span Frequency	5-30 % greater than the DTS channel bandwidth.
RBW	$3 \text{ kHz} \leq \text{RBW} \leq 100\text{kHz}$
VBW	$\geq 3 \times \text{RBW}$
Detector	Peak
Trace	Max Hold
Sweep Time	Auto couple

#### 4.3.3. Test Procedures

1. Test was performed in accordance with KDB558074 D01 v03r04 for Performing Compliance Measurements on Digital Transmission Systems (DTS) - section 10.2 Method PKPSD (peak PSD).
2. Use this procedure when the maximum conducted output power in the fundamental emission is used to demonstrate compliance. The EUT must be configured to transmit continuously at full power over the measurement duration.
3. Ensure that the number of measurement points in the sweep  $\geq 2 \times \text{span/RBW}$  (use of a greater number of measurement points than this minimum requirement is recommended).
4. Use the peak marker function to determine the maximum level in any 3 kHz band segment within the fundamental EBW.
5. The resulting PSD level must be  $\leq 8 \text{ dBm}$ .

#### 4.3.4. Test Setup Layout

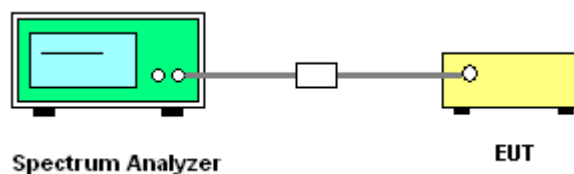

#### 4.3.5. Test Deviation

There is no deviation with the original standard.

#### 4.3.6. EUT Operation during Test

The EUT was programmed to be in continuously transmitting mode.

#### 4.3.7. Test Result of Power Spectral Density

<b>Temperature</b>	25°C	<b>Humidity</b>	59%
<b>Test Engineer</b>	Peter Wu	<b>Configurations</b>	GFSK

Channel	Frequency	Power Density (dBm/3kHz)	Power Density Limit (dBm/3kHz)	Result
0	2402 MHz	-11.42	6.30	<b>Complies</b>
20	2442 MHz	-11.24	6.30	<b>Complies</b>
39	2480 MHz	-11.32	6.30	<b>Complies</b>

Note: Gain = 7.70dBi > 6dBi, so limit = 8-(7.70-6)=6.30dBm/3kHz

Note: All the test values were listed in the report.

For plots, only the channel with worse result was shown.

### Power Density Plot on Configuration Bluetooth / 2442 MHz

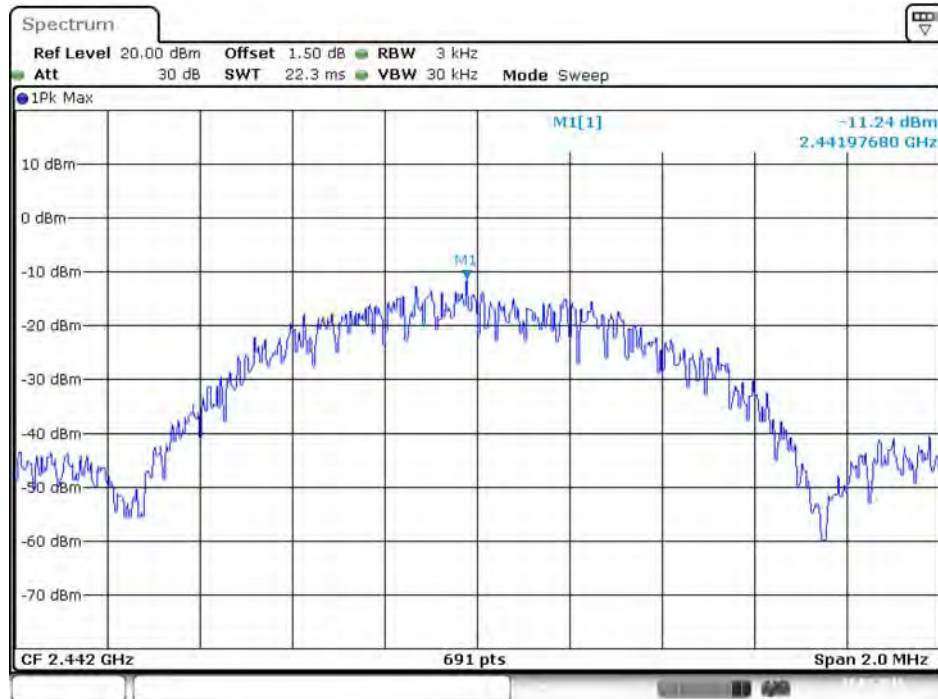

Date: 18.FEB.2016 11:07:30

## 4.4. 6dB Spectrum Bandwidth Measurement

### 4.4.1. Limit

For digital modulation systems, the minimum 6dB bandwidth shall be at least 500 kHz.

### 4.4.2. Measuring Instruments and Setting

Please refer to section 5 of equipments list in this report. The following table is the setting of the spectrum analyzer.

6dB Spectrum Bandwidth	
Spectrum Parameters	Setting
Attenuation	Auto
Span Frequency	> 6dB Bandwidth
RBW	100kHz
VBW	$\geq 3 \times \text{RBW}$
Detector	Peak
Trace	Max Hold
Sweep Time	Auto
99% Occupied Bandwidth	
Spectrum Parameters	Setting
Span	1.5 times to 5.0 times the OBW
RBW	1 % to 5 % of the OBW
VBW	$\geq 3 \times \text{RBW}$
Detector	Peak
Trace	Max Hold

### 4.4.3. Test Procedures

For Radiated 6dB Bandwidth Measurement:

1. The transmitter was radiated to the spectrum analyzer in peak hold mode.
2. Test was performed in accordance with KDB558074 D01 v03r04 for Performing Compliance Measurements on Digital Transmission Systems (DTS) - section 8.0 DTS bandwidth = > 8.1 Option 1.
3. Measured the spectrum width with power higher than 6dB below carrier.

### 4.4.4. Test Setup Layout

For Radiated 6dB Bandwidth Measurement:

This test setup layout is the same as that shown in section 4.5.4.



#### 4.4.5. Test Deviation

There is no deviation with the original standard.

#### 4.4.6. EUT Operation during Test

The EUT was programmed to be in continuously transmitting mode.

#### 4.4.7. Test Result of 6dB Spectrum Bandwidth

<b>Temperature</b>	25°C	<b>Humidity</b>	59%
<b>Test Engineer</b>	Peter Wu	<b>Configurations</b>	GFSK

Channel	Frequency	6dB Bandwidth (MHz)	99% Occupied Bandwidth (MHz)	Min. Limit (kHz)	Test Result
0	2402 MHz	0.71	1.39	500	Complies
20	2442 MHz	0.70	1.39	500	Complies
39	2480 MHz	0.72	1.39	500	Complies

Note: All the test values were listed in the report.

For plots, only the channel with worse result was shown.

### 6 dB Bandwidth Plot on Configuration Bluetooth / 2442 MHz

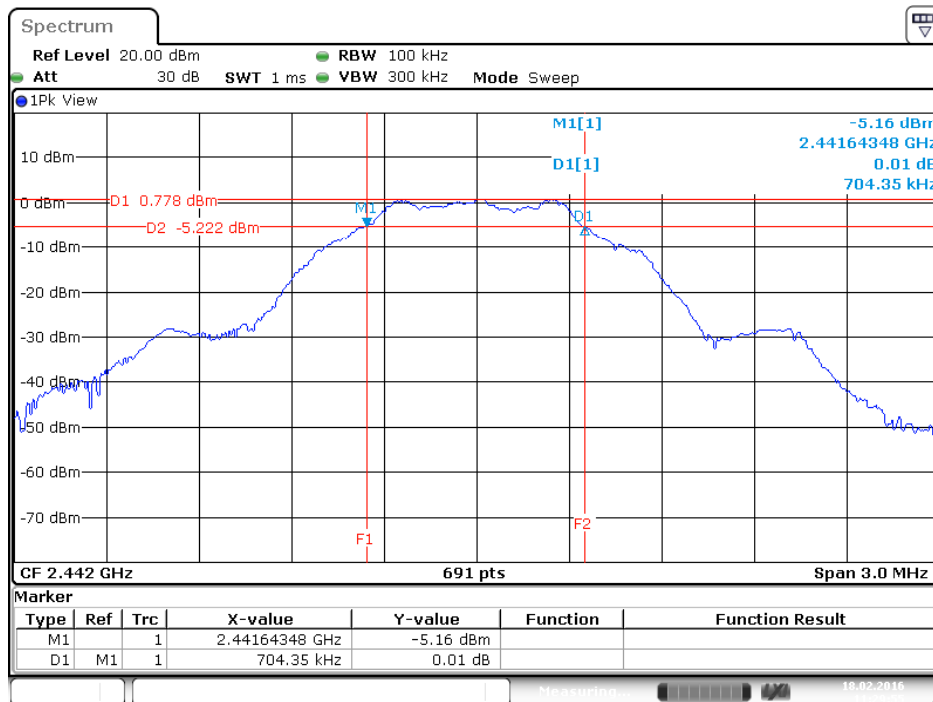

### 99% Occupied Bandwidth Plot on Configuration Bluetooth / 2442 MHz



## 4.5. Radiated Emissions Measurement

### 4.5.1. Limit

30dBc in any 100 kHz bandwidth outside the operating frequency band. In case the emission fall within the restricted band specified on 15.205(a), then the 15.209(a) limit in the table below has to be followed.

Frequencies (MHz)	Field Strength (micorvolts/meter)	Measurement Distance (meters)
0.009~0.490	2400/F(kHz)	300
0.490~1.705	24000/F(kHz)	30
1.705~30.0	30	30
30~88	100	3
88~216	150	3
216~960	200	3
Above 960	500	3

### 4.5.2. Measuring Instruments and Setting

Please refer to section 5 of equipments list in this report. The following table is the setting of spectrum analyzer and receiver.

Spectrum Parameter	Setting
Attenuation	Auto
Start Frequency	1000 MHz
Stop Frequency	10th carrier harmonic
RBW / VBW (Emission in restricted band)	1 MHz / 3MHz for Peak, 1 MHz / 1/T for Average
RBW / VBW (Emission in non-restricted band)	100kHz / 300kHz for peak

Receiver Parameter	Setting
Attenuation	Auto
Start ~ Stop Frequency	9kHz~150kHz / RBW 200Hz for QP
Start ~ Stop Frequency	150kHz~30MHz / RBW 9kHz for QP
Start ~ Stop Frequency	30MHz~1000MHz / RBW 120kHz for QP

#### 4.5.3. Test Procedures

1. Configure the EUT according to ANSI C63.10. The EUT was placed on the top of the turntable 1.5 meter above ground. The phase center of the receiving antenna mounted on the top of a height-variable antenna tower was placed 1m & 3m far away from the turntable.
2. Power on the EUT and all the supporting units. The turntable was rotated by 360 degrees to determine the position of the highest radiation.
3. The height of the broadband receiving antenna was varied between one meter and four meters above ground to find the maximum emissions field strength of both horizontal and vertical polarization.
4. For each suspected emissions, the antenna tower was scan (from 1 M to 4 M) and then the turntable was rotated (from 0 degree to 360 degrees) to find the maximum reading.
5. Set the test-receiver system to Peak or CISPR quasi-peak Detect Function with specified bandwidth under Maximum Hold Mode.
6. For emissions above 1GHz, use 1MHz VBW and 3MHz RBW for peak reading. Then 1MHz RBW and 1/T VBW for average reading in spectrum analyzer.
7. If the emissions level of the EUT in peak mode was 3 dB lower than the average limit specified, then testing will be stopped and peak values of EUT will be reported, otherwise, the emissions which do not have 3 dB margin will be repeated one by one using the quasi-peak method for below 1GHz.
8. For testing above 1GHz, the emissions level of the EUT in peak mode was lower than average limit (that means the emissions level in peak mode also complies with the limit in average mode), then testing will be stopped and peak values of EUT will be reported, otherwise, the emissions will be measured in average mode again and reported.
9. In case the emission is lower than 30MHz, loop antenna has to be used for measurement and the recorded data should be QP measured by receiver. High – Low scan is not required in this case.

#### 4.5.4. Test Setup Layout

For Radiated Emissions: 9kHz ~30MHz

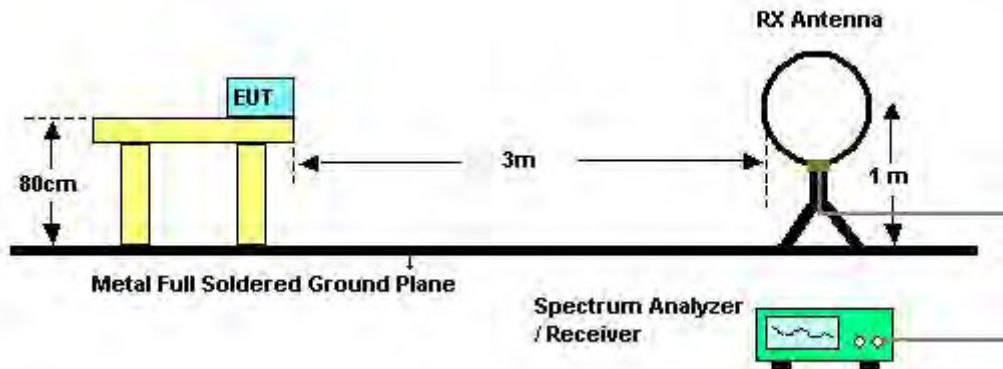

For Radiated Emissions: 30MHz~1GHz

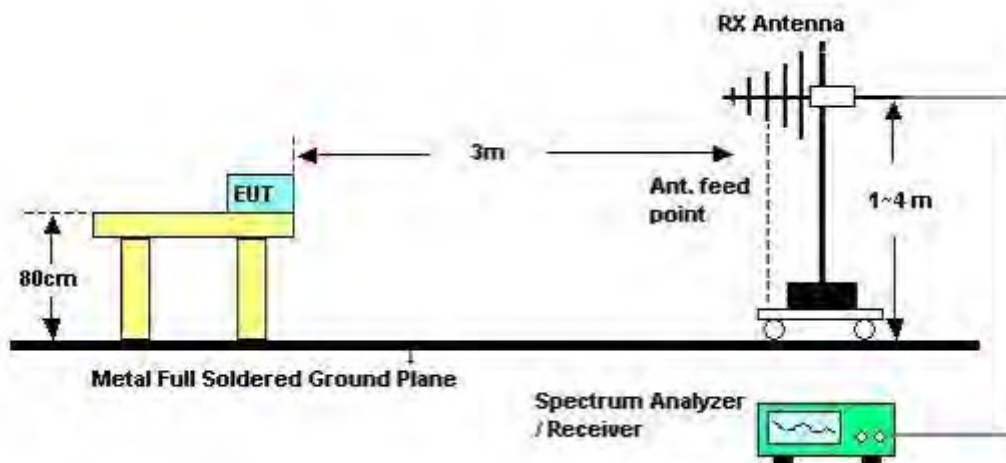

For Radiated Emissions: Above 1GHz

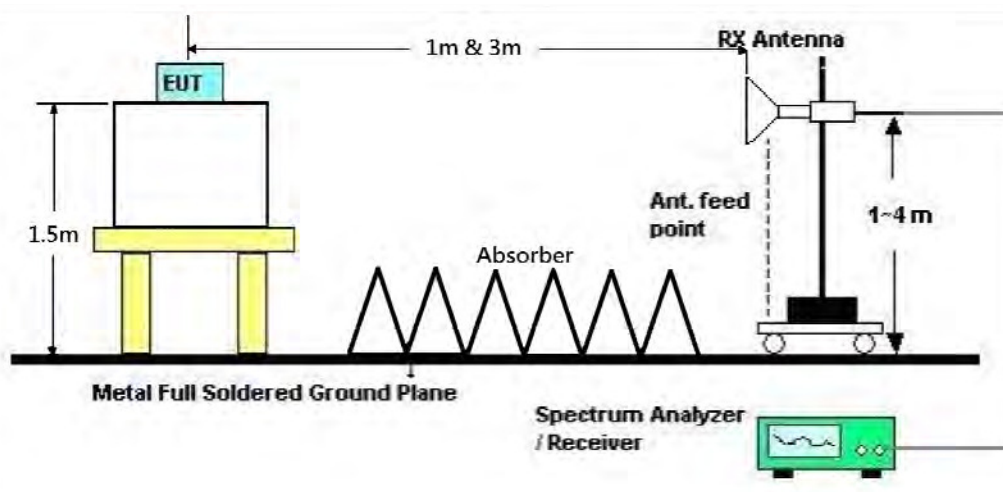

#### 4.5.5. Test Deviation

There is no deviation with the original standard.

#### 4.5.6. EUT Operation during Test

The EUT was programmed to be in continuously transmitting mode.

#### 4.5.7. Results of Radiated Emissions (9kHz~30MHz)

<b>Temperature</b>	24°C	<b>Humidity</b>	55%
<b>Test Engineer</b>	Lucke Hsieh	<b>Test Date</b>	Feb. 05, 2016
<b>Configurations</b>	Normal Link		

<b>Freq. (MHz)</b>	<b>Level (dBuV)</b>	<b>Over Limit (dB)</b>	<b>Limit Line (dBuV)</b>	<b>Remark</b>
-	-	-	-	See Note

Note:

The amplitude of spurious emissions that are attenuated by more than 20 dB below the permissible value has no need to be reported.

Distance extrapolation factor =  $40 \log(\text{specific distance} / \text{test distance})$  (dB);

Limit line = specific limits (dBuV) + distance extrapolation factor.



4.5.8. Results of Radiated Emissions (30MHz~1GHz)

Temperature	24°C	Humidity	55%
Test Engineer	Lucke Hsieh	Configurations	Normal Link
Test Mode	Mode 1		

Horizontal

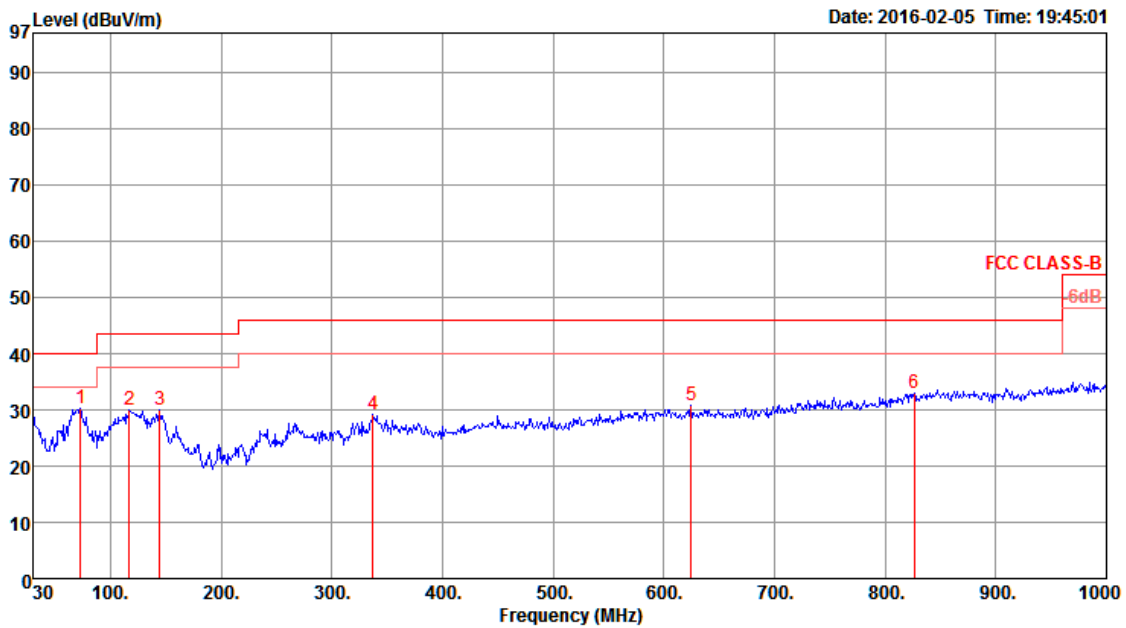

	Freq	Level	Limit	Over	Read	Cable	Antenna	Preamp	T/Pos	A/Pos	Remark	Pol/Phase
	MHz	dBuV/m	dBuV/m	dB	dBuV	dB	dB/m	dB	deg	cm		
1	72.68	30.19	40.00	-9.81	46.59	0.52	12.44	29.36	137	100	Peak	HORIZONTAL
2	117.30	30.07	43.50	-13.43	40.23	0.79	18.22	29.17	188	125	Peak	HORIZONTAL
3	144.46	29.94	43.50	-13.56	40.83	0.90	17.24	29.03	237	100	Peak	HORIZONTAL
4	337.49	29.15	46.00	-16.85	35.50	1.62	20.65	28.62	258	100	Peak	HORIZONTAL
5	624.61	30.81	46.00	-15.19	32.36	2.35	25.21	29.11	151	150	Peak	HORIZONTAL
6	826.37	32.95	46.00	-13.05	31.54	2.85	26.98	28.42	234	100	Peak	HORIZONTAL

**Vertical**

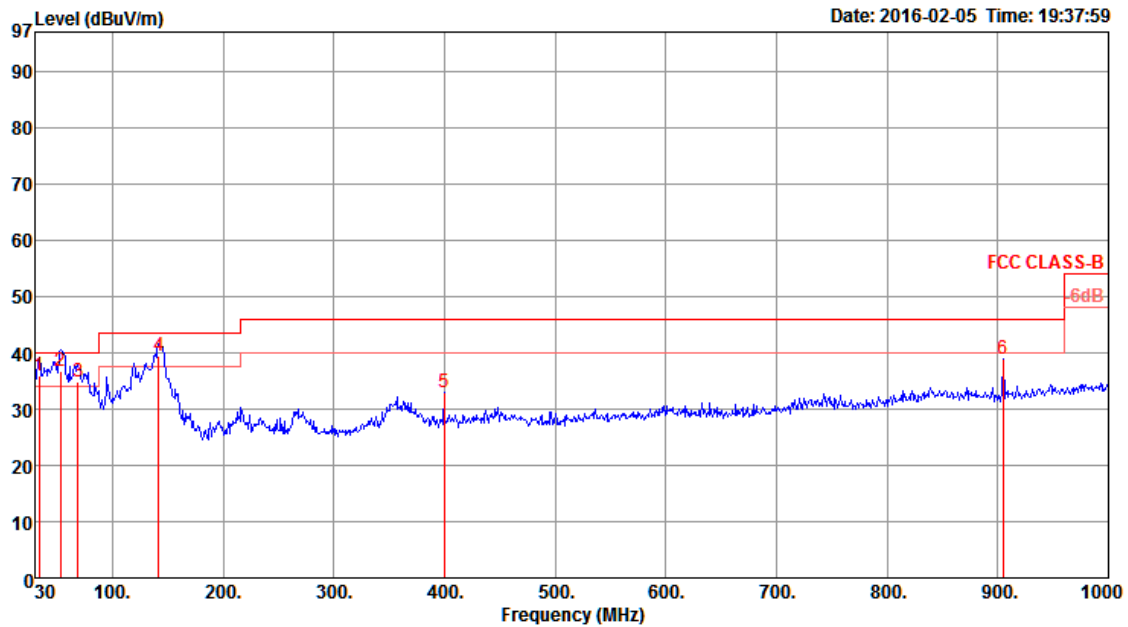

	Freq	Level	Limit	Over	Read	Cable	Antenna	Preamp	T/Pos	A/Pos	Remark	Pol/Phase
	MHz	dBuV/m	dBuV/m	dB	dBuV	dB	dB/m	dB	deg	cm		
1	33.88	36.06	40.00	-3.94	42.22	0.22	23.11	29.49	212	100	QP	VERTICAL
2	53.28	36.82	40.00	-3.18	52.11	0.41	13.74	29.44	178	100	QP	VERTICAL
3	68.80	34.94	40.00	-5.06	51.62	0.48	12.21	29.37	155	104	QP	VERTICAL
4	141.55	39.43	43.50	-4.07	50.11	0.89	17.48	29.05	122	182	QP	VERTICAL
5	399.57	32.86	46.00	-13.14	37.76	1.79	22.36	29.05	132	125	Peak	VERTICAL
6	904.94	38.80	46.00	-7.20	36.22	2.96	27.54	27.92	119	100	Peak	VERTICAL

**Note:**

The amplitude of spurious emissions which are attenuated by more than 20 dB below the permissible value has no need to be reported.

Emission level (dBuV/m) = 20 log Emission level (uV/m).

Corrected Reading: Antenna Factor + Cable Loss + Read Level - Preamp Factor = Level.

Temperature	24°C	Humidity	55%
Test Engineer	Lucke Hsieh	Configurations	Normal Link
Test Mode	Mode 2		

**Horizontal**

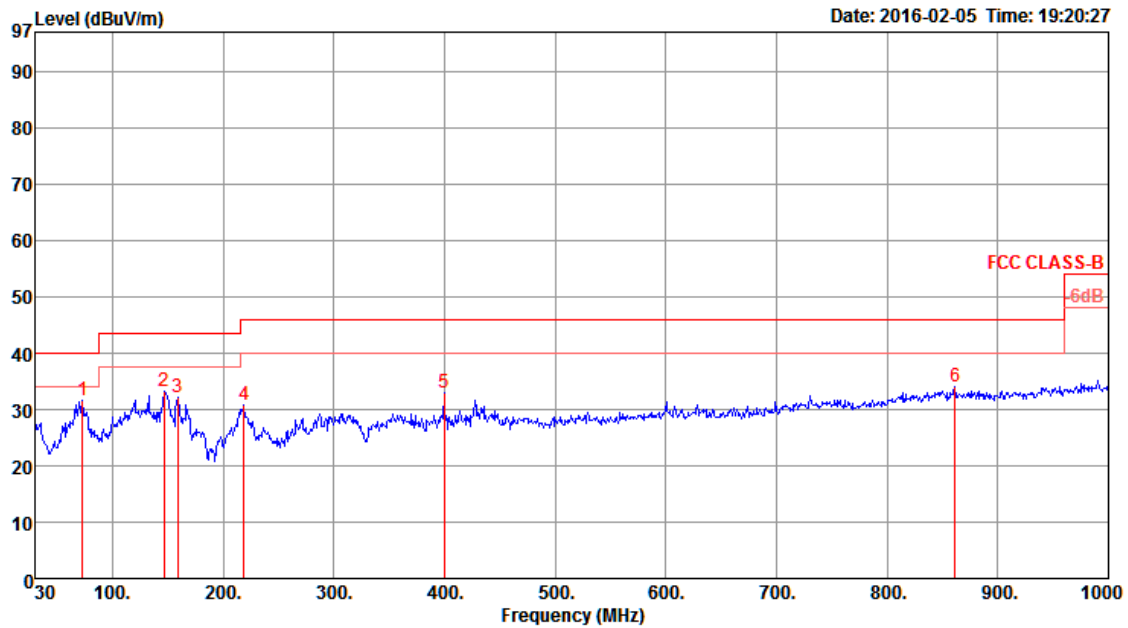

	Freq	Level	Limit	Over	Read	Cable	Antenna	Preamp	T/Pos	A/Pos	Remark	Pol/Phase
	MHz	dBuV/m	dBuV/m	dB	dBuV	dB	dB/m	dB	deg	cm		
1	72.68	31.61	40.00	-8.39	48.01	0.52	12.44	29.36	251	100	Peak	HORIZONTAL
2	146.40	33.30	43.50	-10.20	44.34	0.91	17.08	29.03	137	120	Peak	HORIZONTAL
3	159.01	32.07	43.50	-11.43	43.68	0.95	16.42	28.98	189	150	Peak	HORIZONTAL
4	219.15	30.75	46.00	-15.25	42.05	1.21	16.21	28.72	178	100	Peak	HORIZONTAL
5	399.57	32.85	46.00	-13.15	37.75	1.79	22.36	29.05	231	100	Peak	HORIZONTAL
6	861.29	34.06	46.00	-11.94	32.12	2.90	27.26	28.22	331	200	Peak	HORIZONTAL

**Vertical**

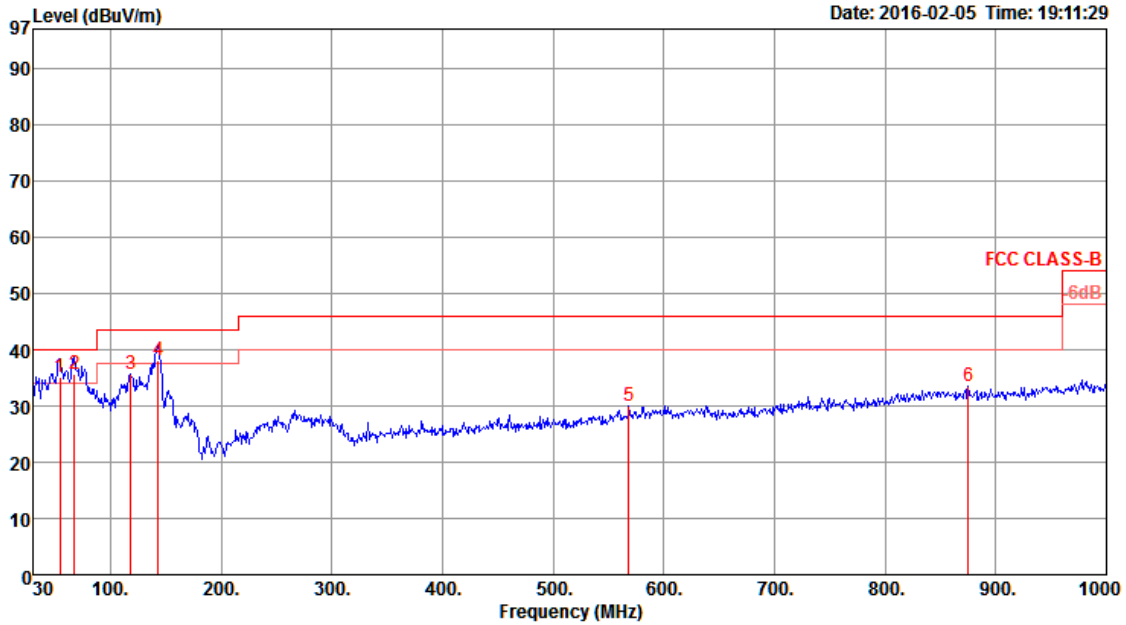

	Freq	Level	Limit	Over	Read	Cable	Antenna	Preamp	T/Pos	A/Pos	Remark	Pol/Phase
	MHz	dBuV/m	dBuV/m	dB	dBuV	dB	dB/m	dB	deg	cm		
1	54.25	35.23	40.00	-4.77	50.73	0.41	13.53	29.44	136	100	QP	VERTICAL
2	67.83	35.78	40.00	-4.22	52.46	0.48	12.22	29.38	102	125	QP	VERTICAL
3	118.27	35.71	43.50	-7.79	45.83	0.79	18.25	29.16	156	100	Peak	VERTICAL
4	143.49	38.19	43.50	-5.31	49.01	0.90	17.32	29.04	77	100	QP	VERTICAL
5	568.35	30.04	46.00	-15.96	32.32	2.21	24.75	29.24	247	100	Peak	VERTICAL
6	874.87	33.47	46.00	-12.53	31.31	2.93	27.35	28.12	308	125	Peak	VERTICAL

**Note:**

The amplitude of spurious emissions which are attenuated by more than 20 dB below the permissible value has no need to be reported.

Emission level (dBuV/m) = 20 log Emission level (uV/m).

Corrected Reading: Antenna Factor + Cable Loss + Read Level - Preamp Factor = Level.

Temperature	24°C	Humidity	55%
Test Engineer	Lucke Hsieh	Configurations	Normal Link
Test Mode	Mode 3		

**Horizontal**

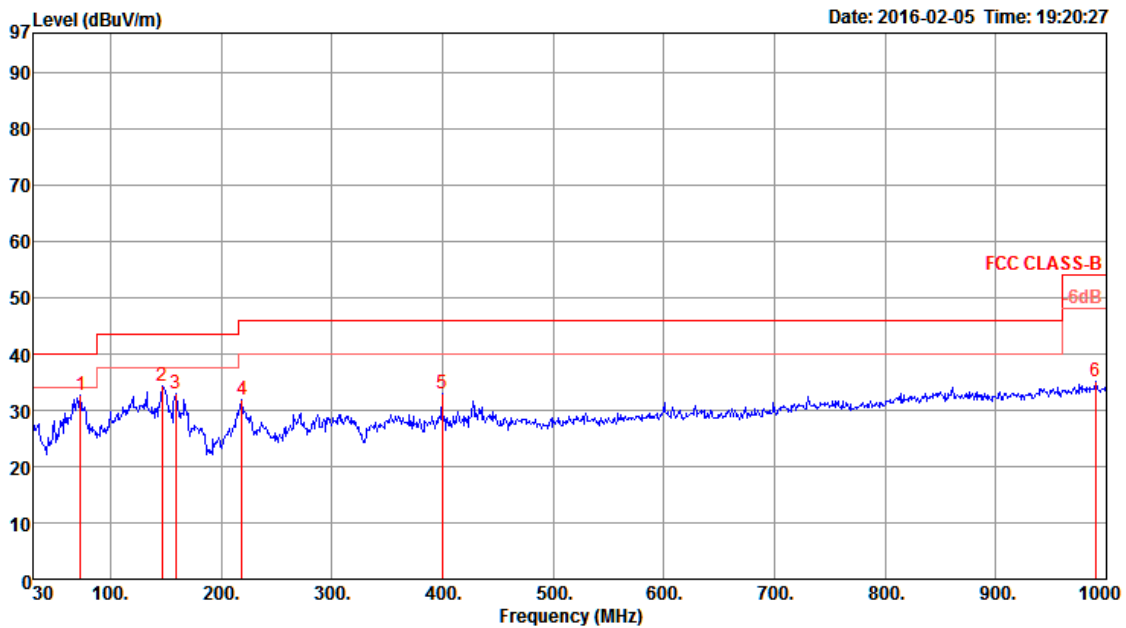

	Freq	Level	Limit	Over	Read	Cable	Antenna	Preamp	T/Pos	A/Pos	Remark	Pol/Phase
	MHz	dBuV/m	dBuV/m	dB	dBuV	dB	dB/m	dB	deg	cm		
1	72.68	32.61	40.00	-7.39	49.01	0.52	12.44	29.36	0	100	Peak	HORIZONTAL
2	146.40	34.30	43.50	-9.20	45.34	0.91	17.08	29.03	0	100	Peak	HORIZONTAL
3	159.01	33.07	43.50	-10.43	44.68	0.95	16.42	28.98	0	100	Peak	HORIZONTAL
4	219.15	31.75	46.00	-14.25	43.05	1.21	16.21	28.72	0	100	Peak	HORIZONTAL
5	399.57	32.85	46.00	-13.15	37.75	1.79	22.36	29.05	0	100	Peak	HORIZONTAL
6	990.30	35.19	54.00	-18.81	31.53	3.01	27.96	27.31	0	100	Peak	HORIZONTAL

**Vertical**

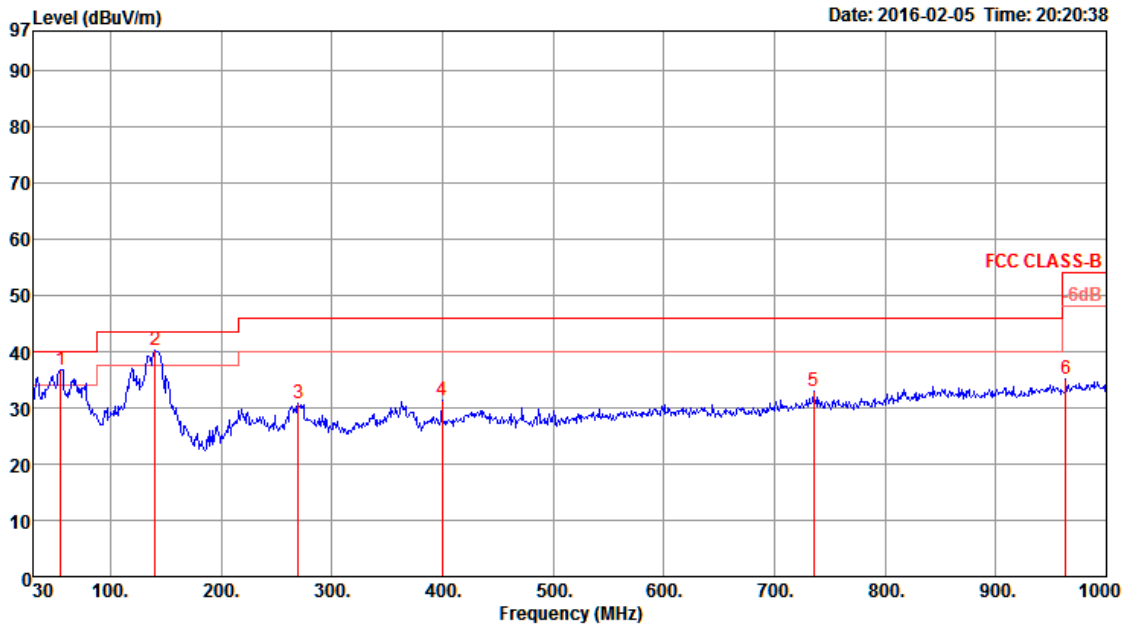

Peak	Freq MHz	Level dBuV/m	Limit Line dBuV/m	Over Limit dB	Read Level dBuV	Cable Loss dB	Antenna Factor dB/m	Preamp Factor dB	T/Pos deg	A/Pos cm	Remark	Pol/Phase
1	55.22	36.87	40.00	-3.13	52.56	0.42	13.32	29.43	0	400	Peak	VERTICAL
2	140.58	40.28	43.50	-3.22	50.88	0.89	17.56	29.05	0	400	Peak	VERTICAL
3	269.59	30.91	46.00	-15.09	38.55	1.40	19.42	28.46	0	400	Peak	VERTICAL
4	399.57	31.29	46.00	-14.71	36.19	1.79	22.36	29.05	0	400	Peak	VERTICAL
5	735.19	32.85	46.00	-13.15	32.92	2.64	26.09	28.80	0	400	Peak	VERTICAL
6	963.14	35.01	54.00	-18.99	31.67	3.00	27.85	27.51	0	400	Peak	VERTICAL

**Note:**

The amplitude of spurious emissions which are attenuated by more than 20 dB below the permissible value has no need to be reported.

Emission level (dBuV/m) = 20 log Emission level (uV/m).

Corrected Reading: Antenna Factor + Cable Loss + Read Level - Preamp Factor = Level.

Temperature	24°C	Humidity	55%
Test Engineer	Lucke Hsieh	Configurations	Normal Link
Test Mode	Mode 4		

**Horizontal**

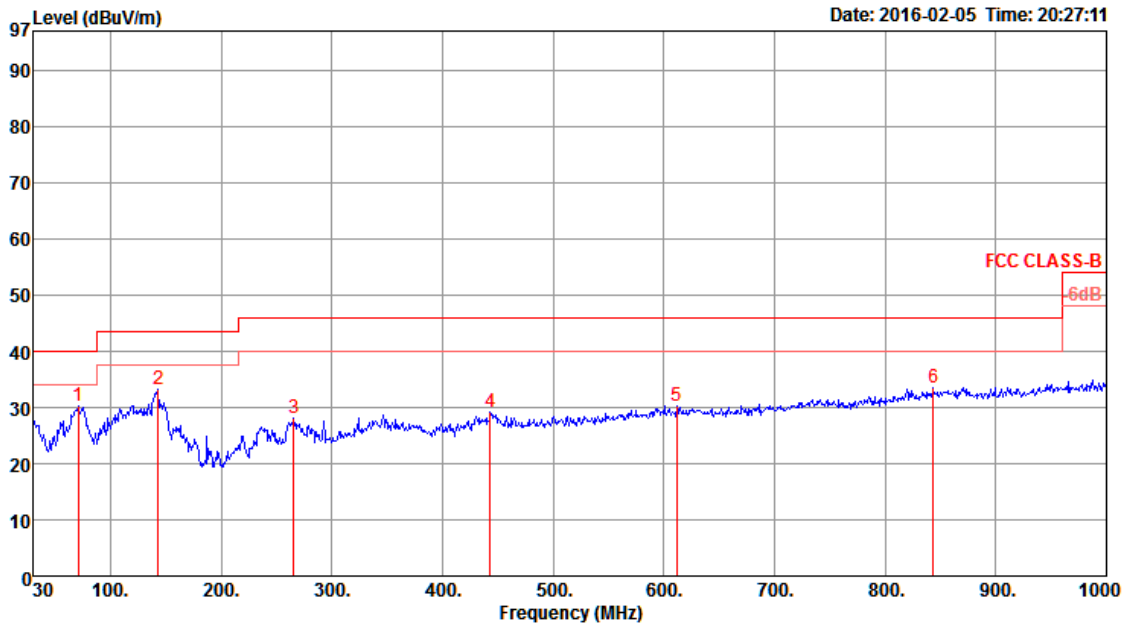

	Freq	Level	Limit	Over	Read	Cable	Antenna	Preamp	T/Pos	A/Pos	Remark	Pol/Phase
	MHz	dBuV/m	dBuV/m	dB	dBuV	dB	dB/m	dB	deg	cm		
1	70.74	30.29	40.00	-9.71	46.89	0.49	12.27	29.36	158	100	Peak	HORIZONTAL
2	143.49	33.13	43.50	-10.37	43.95	0.90	17.32	29.04	132	100	Peak	HORIZONTAL
3	265.71	28.04	46.00	-17.96	35.65	1.38	19.49	28.48	115	100	Peak	HORIZONTAL
4	443.22	29.18	46.00	-16.82	33.47	1.90	23.02	29.21	254	200	Peak	HORIZONTAL
5	612.00	30.32	46.00	-15.68	32.05	2.32	25.10	29.15	152	150	Peak	HORIZONTAL
6	843.83	33.63	46.00	-12.37	31.93	2.88	27.14	28.32	92	100	Peak	HORIZONTAL

**Vertical**

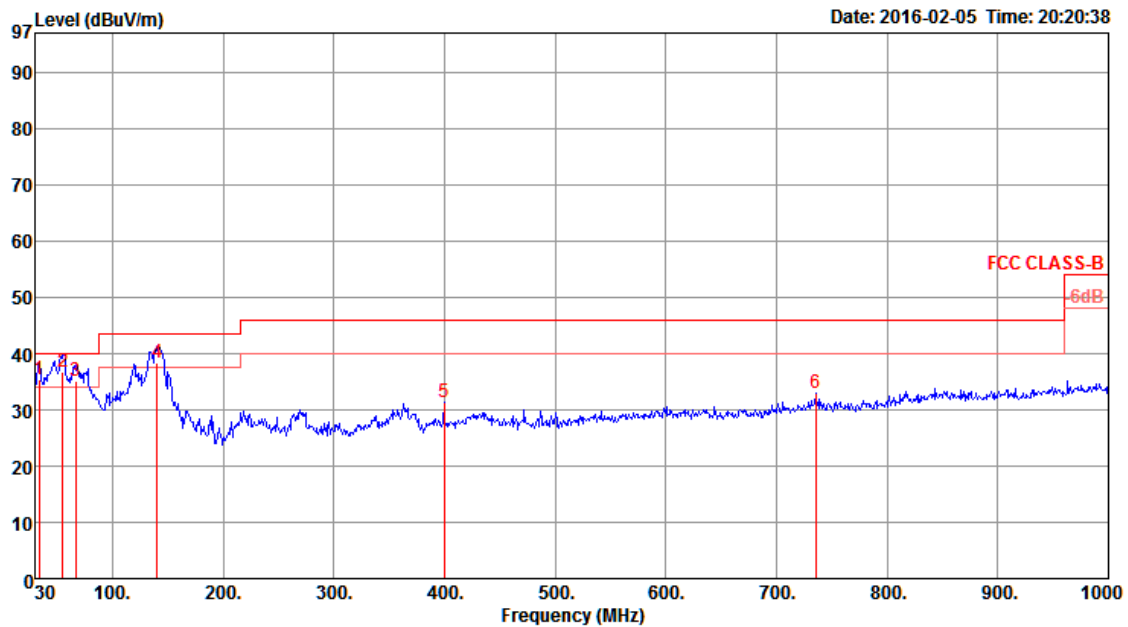

	Freq	Level	Limit	Over	Read	Cable	Antenna	Preamp	T/Pos	A/Pos	Remark	Pol/Phase
	MHz	dBuV/m	dBuV/m	dB	dBuV	dB	dB/m	dB	deg	cm		
1	33.88	35.27	40.00	-4.73	41.43	0.22	23.11	29.49	178	100	QP	VERTICAL
2	55.22	36.63	40.00	-3.37	52.32	0.42	13.32	29.43	157	100	QP	VERTICAL
3	66.86	35.00	40.00	-5.00	51.68	0.47	12.23	29.38	167	125	QP	VERTICAL
4	140.58	38.42	43.50	-5.08	49.02	0.89	17.56	29.05	258	192	QP	VERTICAL
5	399.57	31.29	46.00	-14.71	36.19	1.79	22.36	29.05	211	100	Peak	VERTICAL
6	735.19	32.85	46.00	-13.15	32.92	2.64	26.09	28.80	151	100	Peak	VERTICAL

**Note:**

The amplitude of spurious emissions which are attenuated by more than 20 dB below the permissible value has no need to be reported.

Emission level (dBuV/m) = 20 log Emission level (uV/m).

Corrected Reading: Antenna Factor + Cable Loss + Read Level - Preamp Factor = Level.



**4.5.9. Results for Radiated Emissions (1GHz~10<sup>th</sup> Harmonic)**

<b>Temperature</b>	24°C	<b>Humidity</b>	55%
<b>Test Engineer</b>	Lucke Hsieh	<b>Configurations</b>	Channel 0
<b>Test Date</b>	Feb. 03, 2016		

**Horizontal**

	Freq	Level	Limit Line	Over Limit	Read Level	CableAntenna Loss	Antenna Factor	Preamp Factor	A/Pos	T/Pos	Remark	Pol/Phase
	MHz	dBuV/m	dBuV/m	dB	dBuV	dB	dB/m	dB	cm	deg		
1	4803.09	49.44	74.00	-24.56	41.15	8.15	33.08	32.94	150	68	Peak	HORIZONTAL
2	4804.72	36.26	54.00	-17.74	27.97	8.15	33.08	32.94	150	68	Average	HORIZONTAL

**Vertical**

	Freq	Level	Limit Line	Over Limit	Read Level	CableAntenna Loss	Antenna Factor	Preamp Factor	A/Pos	T/Pos	Remark	Pol/Phase
	MHz	dBuV/m	dBuV/m	dB	dBuV	dB	dB/m	dB	cm	deg		
1	4804.64	36.33	54.00	-17.67	28.04	8.15	33.08	32.94	150	56	Average	VERTICAL
2	4804.95	49.46	74.00	-24.54	41.17	8.15	33.08	32.94	150	56	Peak	VERTICAL



<b>Temperature</b>	24°C	<b>Humidity</b>	55%
<b>Test Engineer</b>	Lucke Hsieh	<b>Configurations</b>	Channel 20
<b>Test Date</b>	Feb. 03, 2016		

**Horizontal**

	Freq	Level	Limit Line	Over Limit	Read Level	CableAntenna Loss	Antenna Factor	Preamp Factor	A/Pos	T/Pos	Remark	Pol/Phase
	MHz	dBuV/m	dBuV/m	dB	dBuV	dB	dB/m	dB	cm	deg		
1	4882.26	35.87	54.00	-18.13	27.64	7.90	33.26	32.93	150	109	Average	HORIZONTAL
2	4883.88	49.09	74.00	-24.91	40.86	7.90	33.26	32.93	150	109	Peak	HORIZONTAL

**Vertical**

	Freq	Level	Limit Line	Over Limit	Read Level	CableAntenna Loss	Antenna Factor	Preamp Factor	A/Pos	T/Pos	Remark	Pol/Phase
	MHz	dBuV/m	dBuV/m	dB	dBuV	dB	dB/m	dB	cm	deg		
1	4881.66	48.79	74.00	-25.21	40.56	7.90	33.26	32.93	150	88	Peak	VERTICAL
2	4882.79	35.77	54.00	-18.23	27.54	7.90	33.26	32.93	150	88	Average	VERTICAL



<b>Temperature</b>	24°C	<b>Humidity</b>	55%
<b>Test Engineer</b>	Lucke Hsieh	<b>Configurations</b>	Channel 39
<b>Test Date</b>	Feb. 03, 2016		

**Horizontal**

	Freq	Level	Limit Line	Over Limit	Read Level	Cable Loss	Antenna Factor	Preamp Factor	A/Pos	T/Pos	Remark	Pol/Phase
	MHz	dBuV/m	dBuV/m	dB	dBuV	dB	dB/m	dB	cm	deg		
1	4957.65	49.08	74.00	-24.92	40.89	7.69	33.41	32.91	150	188	Peak	HORIZONTAL
2	4959.39	36.00	54.00	-18.00	27.81	7.69	33.41	32.91	150	188	Average	HORIZONTAL

**Vertical**

	Freq	Level	Limit Line	Over Limit	Read Level	Cable Loss	Antenna Factor	Preamp Factor	A/Pos	T/Pos	Remark	Pol/Phase
	MHz	dBuV/m	dBuV/m	dB	dBuV	dB	dB/m	dB	cm	deg		
1	4960.37	50.22	74.00	-23.78	42.03	7.69	33.41	32.91	150	135	Peak	VERTICAL
2	4960.92	36.20	54.00	-17.80	28.01	7.69	33.41	32.91	150	135	Average	VERTICAL

**Note:**

The amplitude of spurious emissions that are attenuated by more than 20dB below the permissible value has no need to be reported.

Emission level (dBuV/m) = 20 log Emission level (uV/m).

Corrected Reading: Antenna Factor + Cable Loss + Read Level - Preamp Factor = Level.

## 4.6. Emissions Measurement

### 4.6.1. Limit

30dBc in any 100 kHz bandwidth outside the operating frequency band. In case the emission fall within the restricted band specified on 15.205(a), then the 15.209(a) limit in the table below has to be followed.

Frequencies (MHz)	Field Strength (micorvolts/meter)	Measurement Distance (meters)
0.009~0.490	2400/F(kHz)	300
0.490~1.705	24000/F(kHz)	30
1.705~30.0	30	30
30~88	100	3
88~216	150	3
216~960	200	3
Above 960	500	3

### 4.6.2. Measuring Instruments and Setting

Please refer to section 5 of equipments list in this report. The following table is the setting of the spectrum analyzer.

Spectrum Parameter	Setting
Attenuation	Auto
Span Frequency	100 MHz
RBW / VBW (Emission in restricted band)	1MHz / 3MHz for Peak, 1MHz / 1/T for Average
RBW / VBW (30dBc in any 100 kHz bandwidth emission)	100 kHz / 300 kHz for Peak

### 4.6.3. Test Procedures

For Radiated band edges Measurement:

1. The test procedure is the same as section 4.5.3.

For Radiated Out of Band Emission Measurement:

1. Test was performed in accordance with KDB558074 D01 v03r04 for Performing Compliance Measurements on Digital Transmission Systems (DTS) Operating Under §15.247 section 10.1 Unwanted Emissions into Non-Restricted Frequency Bands Measurement Procedure.

#### **4.6.4. Test Setup Layout**

For Radiated band edges Measurement:

This test setup layout is the same as that shown in section 4.5.4.

For Radiated Out of Band Emission Measurement:

This test setup layout is the same as that shown in section 4.5.4.

#### **4.6.5. Test Deviation**

There is no deviation with the original standard.

#### **4.6.6. EUT Operation during Test**

The EUT was programmed to be in continuously transmitting mode.

#### 4.6.7. Test Result of Band Edge and Fundamental Emissions

Temperature	24°C	Humidity	55%
Test Engineer	Lucke Hsieh	Configurations	Channel 0, 20, 39
Test Date	Feb. 03, 2016		

##### Channel 0

	Freq	Level	Limit Line	Over Limit	Read Level	CableAntenna Loss	Antenna Factor	Preamp Factor	A/Pos	T/Pos	Remark	Pol/Phase
	MHz	dBuV/m	dBuV/m	dB	dBuV	dB	dB/m	dB	cm	deg		
1	2381.80	58.26	74.00	-15.74	24.96	5.00	28.30	0.00	223	0	Peak	HORIZONTAL
2	2382.00	50.57	54.00	-3.43	17.27	5.00	28.30	0.00	223	0	Average	HORIZONTAL
3	2402.00	98.72			65.35	5.03	28.34	0.00	223	0	Average	HORIZONTAL
4	2402.40	100.11			66.74	5.03	28.34	0.00	223	0	Peak	HORIZONTAL

Item 3, 4 are the fundamental frequency at 2402 MHz.

##### Channel 20

	Freq	Level	Limit Line	Over Limit	Read Level	CableAntenna Loss	Antenna Factor	Preamp Factor	A/Pos	T/Pos	Remark	Pol/Phase
	MHz	dBuV/m	dBuV/m	dB	dBuV	dB	dB/m	dB	cm	deg		
1	2385.20	56.10	74.00	-17.90	22.78	5.01	28.31	0.00	234	360	Peak	VERTICAL
2	2390.00	45.39	54.00	-8.61	12.07	5.01	28.31	0.00	234	360	Average	VERTICAL
3	2442.00	99.42			65.93	5.08	28.41	0.00	234	360	Average	VERTICAL
4	2442.40	100.88			67.39	5.08	28.41	0.00	234	360	Peak	VERTICAL
5	2483.50	45.95	54.00	-8.05	12.35	5.12	28.48	0.00	234	360	Average	VERTICAL
6	2484.80	57.11	74.00	-16.89	23.51	5.12	28.48	0.00	234	360	Peak	VERTICAL

Item 3, 4 are the fundamental frequency at 2442 MHz.

##### Channel 39

	Freq	Level	Limit Line	Over Limit	Read Level	CableAntenna Loss	Antenna Factor	Preamp Factor	A/Pos	T/Pos	Remark	Pol/Phase
	MHz	dBuV/m	dBuV/m	dB	dBuV	dB	dB/m	dB	cm	deg		
1	2479.80	99.25			65.68	5.11	28.46	0.00	253	0	Peak	VERTICAL
2	2480.00	97.68			64.11	5.11	28.46	0.00	253	0	Average	VERTICAL
3	2499.60	56.82	74.00	-17.18	23.18	5.14	28.50	0.00	253	0	Peak	VERTICAL
4	2499.80	49.12	54.00	-4.88	15.48	5.14	28.50	0.00	253	0	Average	VERTICAL

Item 1, 2 are the fundamental frequency at 2480 MHz.

Note:

Emission level (dBuV/m) = 20 log Emission level (uV/m).

Corrected Reading: Antenna Factor + Cable Loss + Read Level - Preamp Factor = Level.

**For Emission not in Restricted Band**  
**Plot on Configuration / Reference Level**

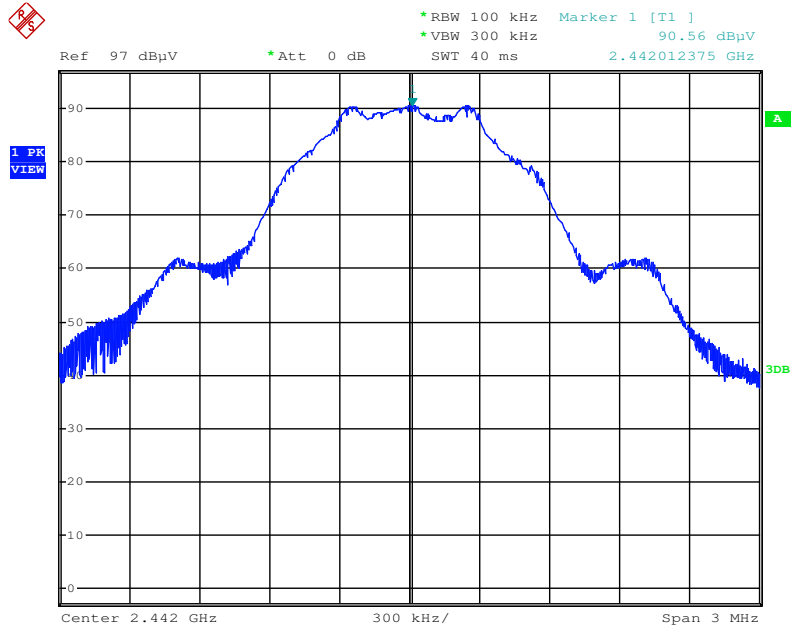

Date: 3.FEB.2016 19:13:46

**Plot on Configuration For Bluetooth 4.0 / Channel 0 / 30MHz~2400MHz (down 30dBc)**

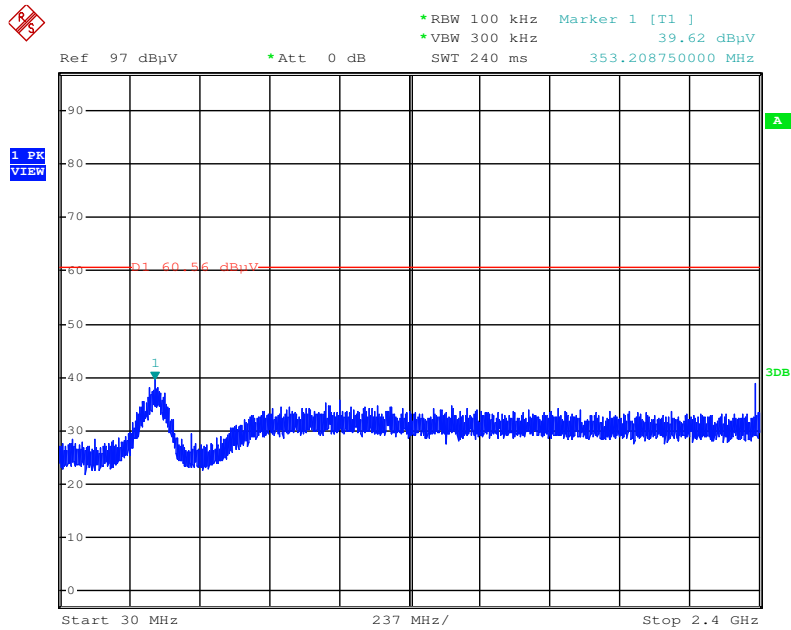

Date: 3.FEB.2016 19:15:27

Plot on Configuration For Bluetooth 4.0 / Channel 0 / 2500MHz~26500MHz (down 30dBc)

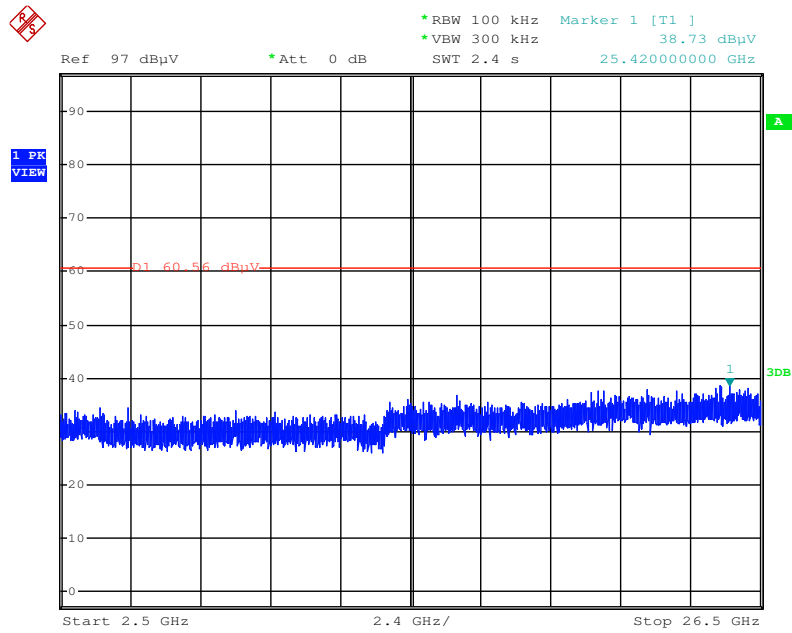

Date: 3.FEB.2016 19:15:52

Plot on Configuration For Bluetooth 4.0 / Channel 39 / 30MHz~2400MHz (down 30dBc)

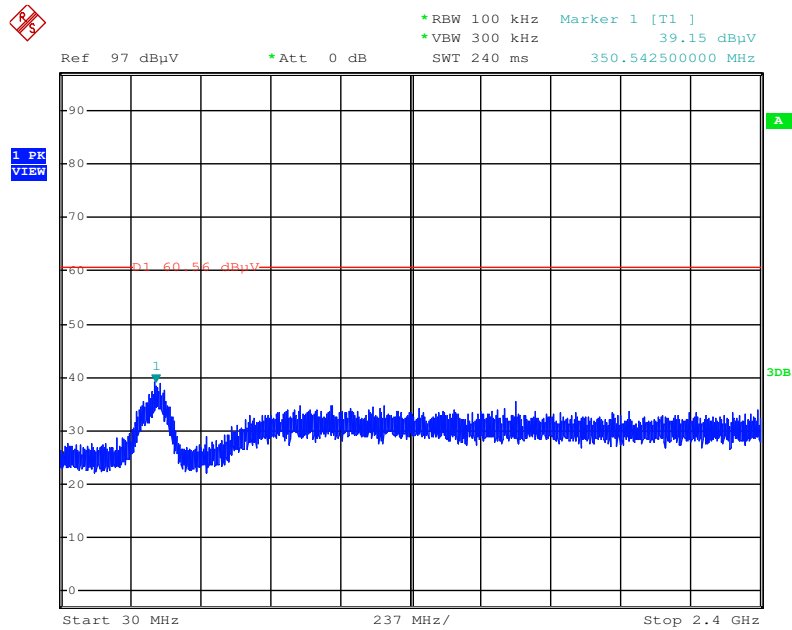

Date: 3.FEB.2016 19:16:26



Plot on Configuration For Bluetooth 4.0 / Channel 39 / 2500MHz~26500MHz (down 30dBc)

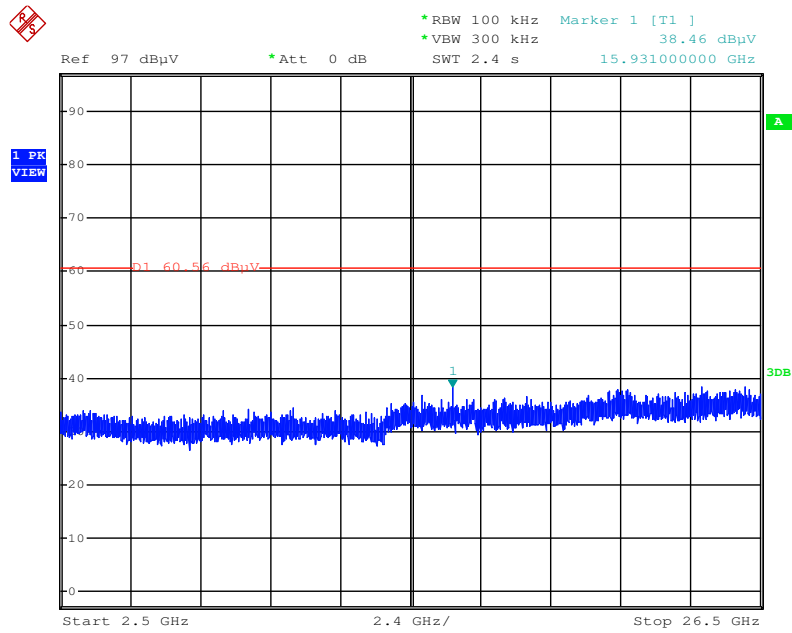

Date: 3.FEB.2016 19:16:54

## 4.7. Antenna Requirements

### 4.7.1. Limit

Except for special regulations, the Low-power Radio-frequency Devices must not be equipped with any jacket for installing an antenna with extension cable. An intentional radiator shall be designed to ensure that no antenna other than that furnished by the responsible party shall be used with the device. The use of a permanently attached antenna or of an antenna that uses a unique coupling to the intentional radiator shall be considered sufficient to comply with the provisions of this Section. The manufacturer may design the unit so that the user can replace a broken antenna, but the use of a standard antenna jack or electrical connector is prohibited. Further, this requirement does not apply to intentional radiators that must be professionally installed.

### 4.7.2. Antenna Connector Construction

Please refer to section 3.3 in this test report; antenna connector complied with the requirements.

## 5. LIST OF MEASURING EQUIPMENTS

Instrument	Manufacturer	Model No.	Serial No.	Characteristics	Calibration Date	Remark
EMI Test Receiver	R&S	ESCS 30	100355	9kHz ~ 2.75GHz	Apr. 22, 2015	Conduction (CO01-CB)
LISN	F.C.C.	FCC-LISN-50-16-2	04083	150kHz ~ 100MHz	Dec. 08, 2015	Conduction (CO01-CB)
LISN	Schwarzbeck	NSLK 8127	8127647	9kHz ~ 30MHz	Dec. 23, 2015	Conduction (CO01-CB)
COND Cable	Woken	Cable	01	150kHz ~ 30MHz	May 25, 2015	Conduction (CO01-CB)
Software	Audix	E3	6.120210n	-	N.C.R.	Conduction (CO01-CB)
BILOG ANTENNA	Schaffner	CBL6112D	37880	20MHz ~ 2GHz	Sep. 03, 2015	Radiation (03CH01-CB)
Horn Antenna	EMCO	3115	00075790	750MHz ~ 18GHz	Oct. 22, 2015	Radiation (03CH01-CB)
Horn Antenna	Schwarzbeck	BBHA 9170	BBHA9170252	15GHz ~ 40GHz	Jul. 21, 2015	Radiation (03CH01-CB)
Pre-Amplifier	Agilent	8447D	2944A10991	0.1MHz ~ 1.3GHz	Feb. 24, 2015	Radiation (03CH01-CB)
Pre-Amplifier	Agilent	8449B	3008A02310	1GHz ~ 26.5GHz	Jan. 18, 2016	Radiation (03CH01-CB)
Pre-Amplifier	WM	TF-130N-R1	923365	26GHz ~ 40GHz	Feb.10, 2015	Radiation (03CH01-CB)
Pre-Amplifier	MITEQ	TTA1840-35-HG	1864479	18GHz ~ 40GHz	Jun. 23, 2015	Radiation (03CH01-CB)
Spectrum Analyzer	R&S	FSP40	100056	9kHz ~ 40GHz	Oct. 27, 2015	Radiation (03CH01-CB)
EMI Receiver	Agilent	N9038A	MY52260123	9kHz ~ 8.4GHz	Jan. 27, 2016	Radiation (03CH01-CB)
RF Cable-low	Woken	Low Cable-1	N/A	30 MHz ~ 1 GHz	Nov. 02, 2015	Radiation (03CH01-CB)
RF Cable-high	Woken	High Cable-16	N/A	1 GHz ~ 18 GHz	Nov. 02, 2015	Radiation (03CH01-CB)
RF Cable-high	Woken	High Cable-17	N/A	1 GHz ~ 18 GHz	Nov. 02, 2015	Radiation (03CH01-CB)
RF Cable-high	Woken	High Cable-40G-1	N/A	18GHz ~ 40 GHz	Nov. 02, 2015	Radiation (03CH01-CB)
RF Cable-high	Woken	High Cable-40G-2	N/A	18GHz ~ 40 GHz	Nov. 02, 2015	Radiation (03CH01-CB)
Loop Antenna	Teseq	HLA 6120	24155	9kHz - 30 MHz	Mar. 12, 2015*	Radiation (03CH01-CB)
Test Software	Audix	E3	6.2009-I0-7	N/A	N/A	Radiation (03CH01-CB)
Spectrum analyzer	R&S	FSV40	100979	9kHz~40GHz	Dec. 09, 2015	Conducted (TH01-CB)
RF Cable-high	Woken	RG402	High Cable-7	1 GHz – 26.5 GHz	Nov. 02, 2015	Conducted (TH01-CB)
RF Cable-high	Woken	RG402	High Cable-8	1 GHz – 26.5 GHz	Nov. 02, 2015	Conducted (TH01-CB)
RF Cable-high	Woken	RG402	High Cable-9	1 GHz – 26.5 GHz	Nov. 02, 2015	Conducted (TH01-CB)



RF Cable-high	Woken	RG402	High Cable-10	1 GHz – 26.5 GHz	Nov. 02, 2015	Conducted (TH01-CB)
RF Cable-high	Woken	RG402	High Cable-6	1 GHz – 26.5 GHz	Nov. 02, 2015	Conducted (TH01-CB)
Power Sensor	Agilent	U2021XA	MY54320014	50MHz~18GHz	Mar. 23, 2015	Conducted (TH01-CB)

Note: Calibration Interval of instruments listed above is one year.

\* Calibration Interval of instruments listed above is two years.

N.C.R. means Non-Calibration required.

## 6. MEASUREMENT UNCERTAINTY

Test Items	Uncertainty	Remark
Conducted Emission (150kHz ~ 30MHz)	3.2 dB	Confidence levels of 95%
Radiated Emission (30MHz ~ 1,000MHz)	3.6 dB	Confidence levels of 95%
Radiated Emission (1GHz ~ 18GHz)	3.7 dB	Confidence levels of 95%
Radiated Emission (18GHz ~ 40GHz)	3.5 dB	Confidence levels of 95%
Conducted Emission	1.7 dB	Confidence levels of 95%