

## FCC Test Report (WLAN)

**Report No.:** RF160715E05-1

**FCC ID:** UZ7AP7622

**Test Model:** AP-7622

**Received Date:** July. 15, 2016

**Test Date:** Sep. 13 to 29, 2016

**Issued Date:** Oct. 28, 2016

**Applicant:** Zebra Technologies Corporation

**Address:** One Zebra Plaza, Holtsville, NY,11742, USA

**Manufacturer:** Zebra Technologies Corporation

**Address:** One Zebra Plaza, Holtsville, NY,11742, USA

**Issued By:** Bureau Veritas Consumer Products Services (H.K.) Ltd., Taoyuan Branch  
Hsin Chu Laboratory

**Lab Address:** E-2, No.1, Li Hsin 1st Road, Hsinchu Science Park, Hsinchu City 300,  
Taiwan R.O.C.

**Test Location (1):** E-2, No.1, Li Hsin 1st Road, Hsinchu Science Park, Hsinchu City 300,  
Taiwan R.O.C.

**Test Location (2):** No. 49, Ln. 206, Wende Rd., Shangshan Tsuen, Chiung Lin Hsiang, Hsin  
Chu Hsien 307, Taiwan R.O.C.



This report is for your exclusive use. Any copying or replication of this report to or for any other person or entity, or use of our name or trademark, is permitted only with our prior written permission. This report sets forth our findings solely with respect to the test samples identified herein. The results set forth in this report are not indicative or representative of the quality or characteristics of the lot from which a test sample was taken or any similar or identical product unless specifically and expressly noted. Our report includes all of the tests requested by you and the results thereof based upon the information that you provided to us. You have 60 days from date of issuance of this report to notify us of any material error or omission caused by our negligence, provided, however, that such notice shall be in writing and shall specifically address the issue you wish to raise. A failure to raise such issue within the prescribed time shall constitute your unqualified acceptance of the completeness of this report, the tests conducted and the correctness of the report contents. Unless specific mention, the uncertainty of measurement has been explicitly taken into account to declare the compliance or non-compliance to the specification. The report must not be used by the client to claim product certification, approval, or endorsement by TAF or any government agencies.

## Table of Contents

<b>Release Control Record</b> .....	<b>4</b>
<b>1 Certificate of Conformity</b> .....	<b>5</b>
<b>2 Summary of Test Results</b> .....	<b>6</b>
2.1 Measurement Uncertainty .....	6
2.2 Modification Record .....	6
<b>3 General Information</b> .....	<b>7</b>
3.1 General Description of EUT (WLAN) .....	7
3.2 Description of Test Modes .....	10
3.2.1 Test Mode Applicability and Tested Channel Detail .....	11
3.3 Duty Cycle of Test Signal .....	13
3.4 Description of Support Units .....	14
3.4.1 Configuration of System under Test .....	15
3.5 General Description of Applied Standard .....	18
<b>4 Test Types and Results</b> .....	<b>19</b>
4.1 Radiated Emission and Bandedge Measurement .....	19
4.1.1 Limits of Radiated Emission and Bandedge Measurement .....	19
4.1.2 Test Instruments .....	20
4.1.3 Test Procedure .....	21
4.1.4 Deviation from Test Standard .....	21
4.1.5 Test Setup .....	22
4.1.6 EUT Operating Condition .....	23
4.1.7 Test Results (Mode 1) .....	24
4.1.8 Test Results (Mode 2) .....	60
4.2 Conducted Emission Measurement .....	78
4.2.1 Limits of Conducted Emission Measurement .....	78
4.2.2 Test Instruments .....	78
4.2.3 Test Procedure .....	79
4.2.4 Deviation from Test Standard .....	79
4.2.5 Test Setup .....	79
4.2.6 EUT Operating Condition .....	79
4.2.7 Test Results (Mode 1) .....	80
4.2.8 Test Results (Mode 2) .....	82
4.3 Transmit Power Measurement .....	84
4.3.1 Limits of Transmit Power Measurement .....	84
4.3.2 Test Setup .....	84
4.3.3 Test Instruments .....	84
4.3.4 Test Procedure .....	84
4.3.5 Deviation from Test Standard .....	84
4.3.6 EUT Operating Condition .....	84
4.3.7 Test Result .....	85
4.4 Occupied Bandwidth Measurement .....	91
4.4.1 Test Setup .....	91
4.4.2 Test Instruments .....	91
4.4.3 Test Procedure .....	91
4.4.4 Test Results .....	92
4.5 Peak Power Spectral Density Measurement .....	96
4.5.1 Limits of Peak Power Spectral Density Measurement .....	96
4.5.2 Test Setup .....	96
4.5.3 Test Instruments .....	96
4.5.4 Test Procedure .....	97
4.5.5 Deviation from Test Standard .....	97
4.5.6 EUT Operating Condition .....	97
4.5.7 Test Results .....	98

4.6	Frequency Stability Measurement.....	104
4.6.1	Limits of Frequency Stability Measurement .....	104
4.6.2	Test Setup.....	104
4.6.3	Test Instruments .....	104
4.6.4	Test Procedure .....	104
4.6.5	Deviation from Test Standard .....	104
4.6.6	EUT Operating Condition .....	104
4.6.7	Test Results .....	105
4.7	6dB Bandwidth Measurement.....	106
4.7.1	Limits of 6dB Bandwidth Measurement.....	106
4.7.2	Test Setup.....	106
4.7.3	Test Instruments .....	106
4.7.4	Test Procedure .....	106
4.7.5	Deviation from Test Standard .....	106
4.7.6	EUT Operating Condition .....	106
4.7.7	Test Results .....	107
<b>5</b>	<b>Pictures of Test Arrangements.....</b>	<b>109</b>
	<b>Annex A- Radiated Out of Band Emission (OOBE) Measurement (For U-NII-3 band) .....</b>	<b>110</b>
	<b>Appendix – Information on the Testing Laboratories .....</b>	<b>113</b>

### Release Control Record

Issue No.	Description	Date Issued
RF160715E05-1	Original release.	Oct. 28, 2016

## 1 Certificate of Conformity

**Product:** Access Point

**Brand:** ZEBRA

**Test Model:** AP-7622

**Sample Status:** ENGINEERING SAMPLE

**Applicant:** Zebra Technologies Corporation

**Test Date:** Sep. 13 to 29, 2016

**Standard:** 47 CFR FCC Part 15, Subpart E (Section 15.407)  
ANSI C63.10: 2013

The above equipment has been tested by **Bureau Veritas Consumer Products Services (H.K.) Ltd., Taoyuan Branch**, and found compliance with the requirement of the above standards. The test record, data evaluation & Equipment Under Test (EUT) configurations represented herein are true and accurate accounts of the measurements of the sample's EMC characteristics under the conditions specified in this report.

**Prepared by :** Wendy Wu , **Date:** Oct. 28, 2016  
Wendy Wu / Specialist

**Approved by :** May Chen , **Date:** Oct. 28, 2016  
May Chen / Manager

## 2 Summary of Test Results

47 CFR FCC Part 15, Subpart E (Section 15.407)			
FCC Clause	Test Item	Result	Remarks
15.407(b)(6)	AC Power Conducted Emissions	Pass	Meet the requirement of limit. Minimum passing margin is -12.94dB at 23.12891MHz.
15.407(b) (1/2/3/4(i/ii)/6)	Radiated Emissions & Band Edge Measurement*	Pass	Meet the requirement of limit. Minimum passing margin is -1.1dB at 5150.00MHz, 5646.90MHz.
15.407(a)(1/2/3)	Max Average Transmit Power	Pass	Meet the requirement of limit.
---	Occupied Bandwidth Measurement	-	Reference only.
15.407(a)(1/2/3)	Peak Power Spectral Density	Pass	Meet the requirement of limit.
15.407(e)	6dB bandwidth	Pass	Meet the requirement of limit. (U-NII-3 Band only)
15.407(g)	Frequency Stability	Pass	Meet the requirement of limit.
15.203	Antenna Requirement	Pass	Antenna connector is i-pex(MHF) not a standard connector.

\*For U-NII-3 band compliance with rule part 15.407(b)(4)(i), the OOB test plots were recorded in Annex A.

### 2.1 Measurement Uncertainty

Where relevant, the following measurement uncertainty levels have been estimated for tests performed on the EUT as specified in CISPR 16-4-2:

Measurement	Frequency	Expanded Uncertainty (k=2) (±)
Conducted Emissions at mains ports	150kHz ~ 30MHz	1.83 dB
Radiated Emissions up to 1 GHz	30MHz ~ 1GHz	5.43 dB
Radiated Emissions above 1 GHz	1GHz ~ 6GHz	3.72 dB
	6GHz ~ 18GHz	4.00 dB
	18GHz ~ 40GHz	4.11 dB

### 2.2 Modification Record

There were no modifications required for compliance.

### 3 General Information

#### 3.1 General Description of EUT (WLAN)

Product	Access Point
Brand	ZEBRA
Test Model	AP-7622
Status of EUT	ENGINEERING SAMPLE
SW Version	esdk 5.0.9.1
HW Version	ZEBRA_ASPEN-C_BCM47452_V20_D1_20160603_fischer.brd
Power Supply Rating	12Vdc from power adapter or 55Vdc from POE
Modulation Type	CCK, DQPSK, DBPSK for DSSS 64QAM, 16QAM, QPSK, BPSK for OFDM 256QAM for OFDM in 11ac mode and VHT20/40 mode in 2.4GHz band
Modulation Technology	DSSS, OFDM
Transfer Rate	802.11b: up to 11Mbps 802.11a/g: up to 54Mbps 802.11n: up to 300Mbps 802.11ac: up to 866.7Mbps
Operating Frequency	<b>2.4GHz:</b> 2.412 ~ 2.462GHz <b>5GHz:</b> 5.18 ~ 5.24GHz, 5.745 ~ 5.825GHz
Number of Channel	<b>2.4GHz:</b> 802.11b, 802.11g, 802.11n (HT20), VHT20: 11 802.11n (HT40), VHT40: 7 <b>5GHz:</b> 802.11a, 802.11n (HT20), 802.11ac (VHT20): 9 802.11n (HT40), 802.11ac (VHT40): 4 802.11ac (VHT80): 2
Output Power	<b>2.4GHz:</b> <b>CDD Mode:</b> 327.242mW <b>Beamforming Mode:</b> 121.377mW <b>5GHz:</b> <b>5.18GHz ~ 5.24GHz:</b> <b>CDD Mode:</b> 205.313mW <b>Beamforming Mode:</b> 155.046mW <b>5.745GHz ~ 5.825GHz:</b> <b>CDD Mode:</b> 293.877mW <b>Beamforming Mode:</b> 293.877mW
Antenna Type	Refer to Note
Antenna Connector	Refer to Note
Accessory Device	NA
Data Cable Supplied	NA

Note:

1. There are WLAN, BT technology used for the EUT.
2. Simultaneously transmission condition.

Condition	Technology		
1	WLAN (2.4GHz-Chain0)	WLAN (5GHz-Chain1)	BT
2	WLAN (2.4GHz-Chain1)	WLAN (5GHz-Chain0)	BT
3	WLAN (2.4GHz-Chain0)	WLAN (2.4GHz-Chain1)	BT
4	WLAN (5GHz-Chain0)	WLAN (5GHz-Chain1)	BT

**Note:** The emission of the simultaneous operation has been evaluated and no non-compliance was found.

3. The EUT must be supplied with a power adapter and POE as following table:

Adapter (Only for test not for sale)		
Brand	Model No.	Spec.
HIPRO	HP-A0502R3D	Input: 100-240Vac, 50-60Hz, 2.4A Output: 12Vdc, 4.16A DC output cable (Unshielded, 1.8m with one core)
POE(Only for test not for sale)		
Brand	Model No.	Spec.
Symbol	PD-9001GR/AT/AC	Input: 100-240Vac, 50/60Hz, 0.67A Output: 55Vdc, 0.6A P/N : AP-PSBIAS-2P3-ATR

From above adapters and POE, the spurious emission above 1GHz worst case was found in **POE**. Therefore only the test data of the modes were recorded in this report individually.

4. The antennas provided to the EUT, please refer to the following table:

No.	PCB Chain No	Brand	Model	Antenna Gain(dBi) Including cable loss	Frequency range	Antenna Type	Connector type
1	Chain 0	NA	NA	3.64	2.4~2.4835GHz	Monopole	i-pex(MHF)
				4.14	5.15~5.25GHz	Monopole	i-pex(MHF)
				4.33	5.25~5.35GHz	Monopole	i-pex(MHF)
				4.66	5.47~5.725GHz	Monopole	i-pex(MHF)
				4.85	5.725~5.85GHz	Monopole	i-pex(MHF)
2	Chain 1	NA	NA	2.65	2.4~2.4835GHz	Monopole	i-pex(MHF)
				4.5	5.15~5.25GHz	Monopole	i-pex(MHF)
				5.77	5.25~5.35GHz	Monopole	i-pex(MHF)
				5.54	5.47~5.725GHz	Monopole	i-pex(MHF)
				4.78	5.725~5.85GHz	Monopole	i-pex(MHF)
3	BT	NA	NA	2.42	2.4~2.483GHz	Monopole	i-pex(MHF)



5. The EUT incorporates a MIMO function:

2.4GHz Band			
MODULATION MODE	DATA RATE (MCS)	TX & RX CONFIGURATION	
802.11b	1 ~ 11Mbps	2TX/1TX diversity	2RX
802.11g	6 ~ 54Mbps	2TX/1TX diversity	2RX
802.11n (HT20)	MCS 0~7	2TX/1TX diversity	2RX
	MCS 8~15	2TX	2RX
802.11n (HT40)	MCS 0~7	2TX/1TX diversity	2RX
	MCS 8~15	2TX	2RX
VHT20	MCS 0~8, Nss=1	2TX/1TX diversity	2RX
	MCS 0~8, Nss=2	2TX	2RX
VHT40	MCS 0~9, Nss=1	2TX/1TX diversity	2RX
	MCS 0~9, Nss=2	2TX	2RX
5GHz Band			
MODULATION MODE	DATA RATE (MCS)	TX & RX CONFIGURATION	
802.11a	6 ~ 54Mbps	2TX/1TX diversity	2RX
802.11n (HT20)	MCS 0~7	2TX/1TX diversity	2RX
	MCS 8~15	2TX	2RX
802.11n (HT40)	MCS 0~7	2TX/1TX diversity	2RX
	MCS 8~15	2TX	2RX
802.11ac (VHT20)	MCS 0~8, Nss=1	2TX/1TX diversity	2RX
	MCS 0~8, Nss=2	2TX	2RX
802.11ac (VHT40)	MCS 0~9, Nss=1	2TX/1TX diversity	2RX
	MCS 0~9, Nss=2	2TX	2RX
802.11ac (VHT80)	MCS 0~9, Nss=1	2TX/1TX diversity	2RX
	MCS 0~9, Nss=2	2TX	2RX

Note:

1. All of modulation mode support beamforming function except 802.11a/b/g modulation mode.
2. The modulation and bandwidth are similar for 802.11n mode for 20MHz (40MHz) and 802.11ac mode for 20MHz (40MHz), therefore investigated worst case to representative mode in test report. (Final test mode refer section 3.2.1)
3. The EUT support diversity parameter for 1TX mode, the 1TX output power will remain the same as per chain of 2TX parameter, and all test items were performed by 2TX mode.

6. The above EUT information is declared by manufacturer and for more detailed features description, please refer to the manufacturer's specifications or user's manual.

### 3.2 Description of Test Modes

#### FOR 5180 ~ 5240MHz

4 channels are provided for 802.11a, 802.11n (HT20), 802.11ac (VHT20):

Channel	Frequency	Channel	Frequency
36	5180 MHz	44	5220 MHz
40	5200 MHz	48	5240 MHz

2 channels are provided for 802.11n (HT40), 802.11ac (VHT40):

Channel	Frequency	Channel	Frequency
38	5190 MHz	46	5230 MHz

1 channel is provided for 802.11ac (VHT80):

Channel	Frequency
42	5210MHz

#### FOR 5745 ~ 5825MHz:

5 channels are provided for 802.11a, 802.11n (HT20), 802.11ac (VHT20):

Channel	Frequency	Channel	Frequency
149	5745MHz	161	5805MHz
153	5765MHz	165	5825MHz
157	5785MHz		

2 channels are provided for 802.11n (HT40), 802.11ac (VHT40):

Channel	Frequency	Channel	Frequency
151	5755MHz	159	5795MHz

1 channel is provided for 802.11ac (VHT80):

Channel	Frequency
155	5775MHz

### 3.2.1 Test Mode Applicability and Tested Channel Detail

EUT Configure Mode	Applicable To				Description
	RE $\geq$ 1G	RE<1G	PLC	APCM	
1	√	√	√	√	Power from POE
2	-	√	√	-	Power from adapter

Where **RE $\geq$ 1G**: Radiated Emission above 1GHz      **RE<1G**: Radiated Emission below 1GHz  
**PLC**: Power Line Conducted Emission      **APCM**: Antenna Port Conducted Measurement

**NOTE:**

1. The EUT had been pre-tested on the positioned of each 2 axis. The worst case was found when positioned on **Y-plane**.
2. "-" means no effect.

#### **Radiated Emission Test (Above 1GHz):**

- Pre-Scan has been conducted to determine the worst-case mode from all possible combinations between available modulations, data rates and antenna ports (if EUT with antenna diversity architecture).
- Following channel(s) was (were) selected for the final test as listed below.

CDD Mode						
Mode	FREQ. Band (MHz)	Available Channel	Tested Channel	Modulation Technology	Modulation Type	Data Rate (Mbps)
802.11a	5180-5240	36 to 48	36, 40, 48	OFDM	BPSK	6
802.11ac (VHT20)		36 to 48	36, 40, 48	OFDM	BPSK	6.5
802.11ac (VHT40)		38 to 46	38, 46	OFDM	BPSK	13.5
802.11ac (VHT80)		42	42	OFDM	BPSK	29.3
802.11a	5745-5825	149 to 165	149, 157, 165	OFDM	BPSK	6
802.11ac (VHT20)		149 to 165	149, 157, 165	OFDM	BPSK	6.5
802.11ac (VHT40)		151 to 159	151, 159	OFDM	BPSK	13.5
802.11ac (VHT80)		155	155	OFDM	BPSK	29.3

#### **Radiated Emission Test (Below 1GHz):**

- Pre-Scan has been conducted to determine the worst-case mode from all possible combinations between available modulations, data rates and antenna ports (if EUT with antenna diversity architecture).
- Following channel(s) was (were) selected for the final test as listed below.

CDD Mode						
Mode	FREQ. Band (MHz)	Available Channel	Tested Channel	Modulation Technology	Modulation Type	Data Rate (Mbps)
802.11a	5180-5240	36 to 48	36, 40, 48	OFDM	BPSK	6
802.11ac (VHT20)		36 to 48	36, 40, 48	OFDM	BPSK	6.5
802.11ac (VHT40)		38 to 46	38, 46	OFDM	BPSK	13.5
802.11ac (VHT80)		42	42	OFDM	BPSK	29.3
802.11a	5745-5825	149 to 165	149, 157, 165	OFDM	BPSK	6
802.11ac (VHT20)		149 to 165	149, 157, 165	OFDM	BPSK	6.5
802.11ac (VHT40)		151 to 159	151, 159	OFDM	BPSK	13.5
802.11ac (VHT80)		155	155	OFDM	BPSK	29.3

### Power Line Conducted Emission Test:

- Pre-Scan has been conducted to determine the worst-case mode from all possible combinations between available modulations, data rates and antenna ports (if EUT with antenna diversity architecture).
- Following channel(s) was (were) selected for the final test as listed below.

CDD Mode						
Mode	FREQ. Band (MHz)	Available Channel	Tested Channel	Modulation Technology	Modulation Type	Data Rate (Mbps)
802.11ac (VHT20)	5745-5825	149 to 165	157	OFDM	BPSK	6.5

### Antenna Port Conducted Measurement:

- This item includes all test value of each mode, but only includes spectrum plot of worst value of each mode.
- Pre-Scan has been conducted to determine the worst-case mode from all possible combinations between available modulations, data rates and antenna ports (if EUT with antenna diversity architecture).
- Following channel(s) was (were) selected for the final test as listed below.

CDD Mode						
Mode	FREQ. Band (MHz)	Available Channel	Tested Channel	Modulation Technology	Modulation Type	Data Rate (Mbps)
802.11a	5180-5240	36 to 48	36, 40, 48	OFDM	BPSK	6
802.11ac (VHT20)		36 to 48	36, 40, 48	OFDM	BPSK	6.5
802.11ac (VHT40)		38 to 46	38, 46	OFDM	BPSK	13.5
802.11ac (VHT80)		42	42	OFDM	BPSK	29.3
802.11a	5745-5825	149 to 165	149, 157, 165	OFDM	BPSK	6
802.11ac (VHT20)		149 to 165	149, 157, 165	OFDM	BPSK	6.5
802.11ac (VHT40)		151 to 159	151, 159	OFDM	BPSK	13.5
802.11ac (VHT80)		155	155	OFDM	BPSK	29.3
Beamforming Mode (Output power only)						
Mode	FREQ. Band (MHz)	Available Channel	Tested Channel	Modulation Technology	Modulation Type	Data Rate (Mbps)
802.11ac (VHT20)	5180-5240	36 to 48	36, 40, 48	OFDM	BPSK	6.5
802.11ac (VHT40)		38 to 46	38, 46	OFDM	BPSK	13.5
802.11ac (VHT80)		42	42	OFDM	BPSK	29.3
802.11ac (VHT20)	5745-5825	149 to 165	149, 157, 165	OFDM	BPSK	6.5
802.11ac (VHT40)		151 to 159	151, 159	OFDM	BPSK	13.5
802.11ac (VHT80)		155	155	OFDM	BPSK	29.3

### Test Condition:

Applicable To	Environmental Conditions	Input Power	Tested By
RE $\geq$ 1G	25deg. C, 69%RH	120Vac, 60Hz	Weiwei Lo
RE $<$ 1G	28deg. C, 65%RH	120Vac, 60Hz	Andy Ho
PLC	25deg. C, 70%RH	120Vac, 60Hz	Barry Lee
APCM	25deg. C, 60%RH	120Vac, 60Hz	Anderson Chen

### 3.3 Duty Cycle of Test Signal

If duty cycle of test signal is  $\geq 98\%$ , duty factor is not required.

If duty cycle of test signal is  $< 98\%$ , duty factor shall be considered.

**802.11a:** Duty cycle =  $2.062 \text{ ms} / 2.086 \text{ ms} = 0.988$

**802.11ac (VHT20):** Duty cycle =  $1.916 \text{ ms} / 1.94 \text{ ms} = 0.988$

**802.11ac (VHT40):** Duty cycle =  $0.944 \text{ ms} / 0.963 \text{ ms} = 0.98$

**802.11ac (VHT80):** Duty cycle =  $0.459 \text{ ms} / 0.479 \text{ ms} = 0.958$ , Duty factor =  $10 * \log(1/0.958) = 0.19$

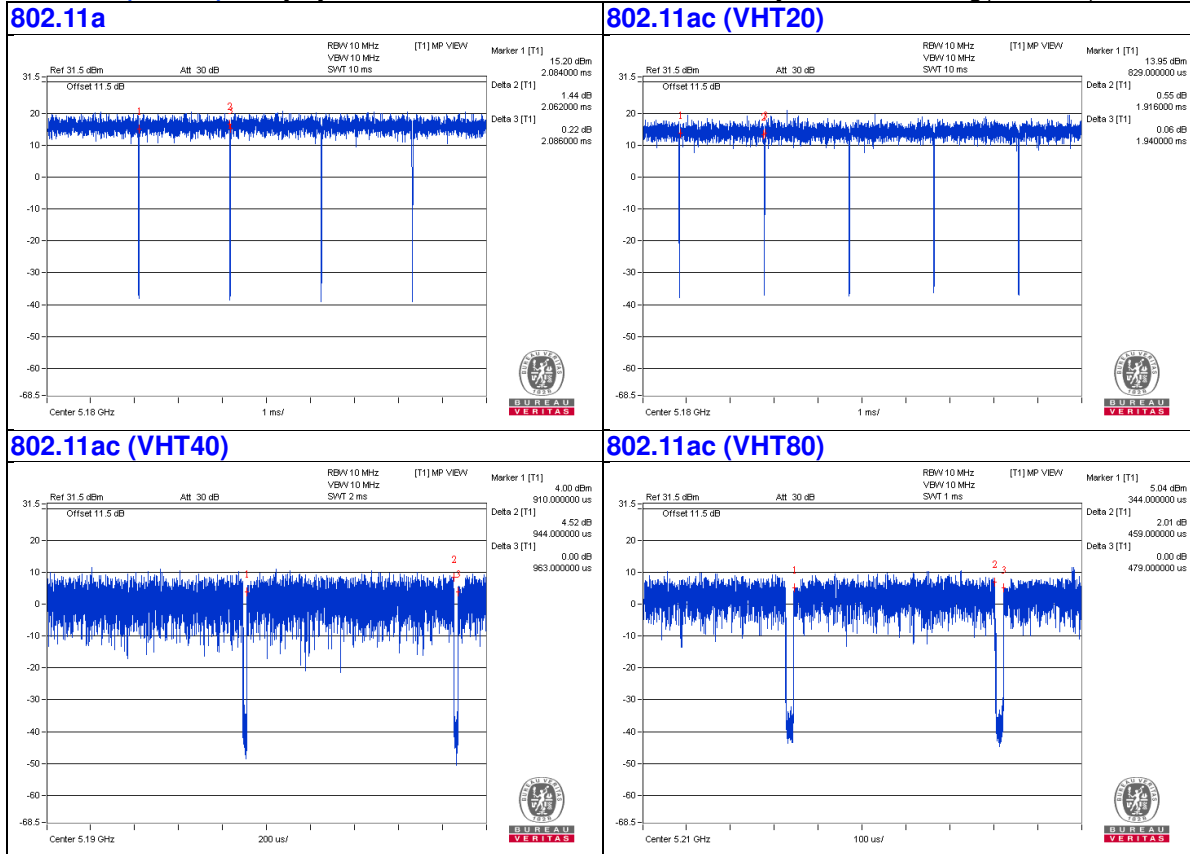

### 3.4 Description of Support Units

The EUT has been tested as an independent unit together with other necessary accessories or support units. The following support units or accessories were used to form a representative test configuration during the tests.

ID	Product	Brand	Model No.	Serial No.	FCC ID	Remarks
A.	Laptop	DELL	E6440	F9LYQ32	FCC DoC	Provided by Lab
B.	POE Adapter	Symbol	PD-9001GR/AT/AC	NA	NA	Supplied by client

Note:

1. All power cords of the above support units are non-shielded (1.8m).

ID	Descriptions	Qty.	Length (m)	Shielding (Yes/No)	Cores (Qty.)	Remarks
1.	RJ-45 Cable	1	10	No	0	Provided by Lab
2.	DC Cable	1	1.8	No	1	Supplied by client
3.	AC Cable	1	1.8	No	0	Provided by Lab
4.	RJ-45 Cable	1	3	No	0	Provided by Lab
5.	Console Cable	1	1.5	No	0	Provided by Lab

### 3.4.1 Configuration of System under Test

Adapter Mode:

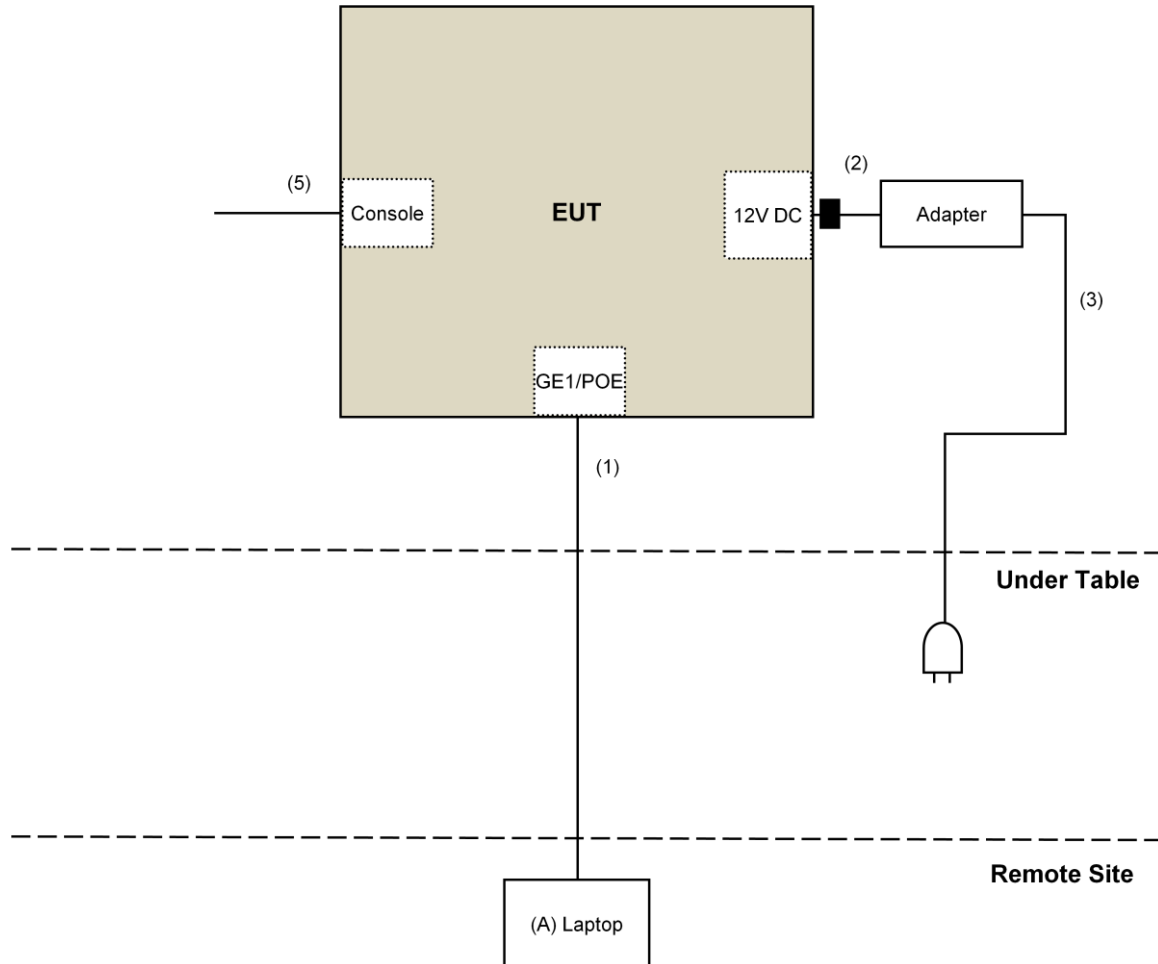

POE Mode (for Conduction test)

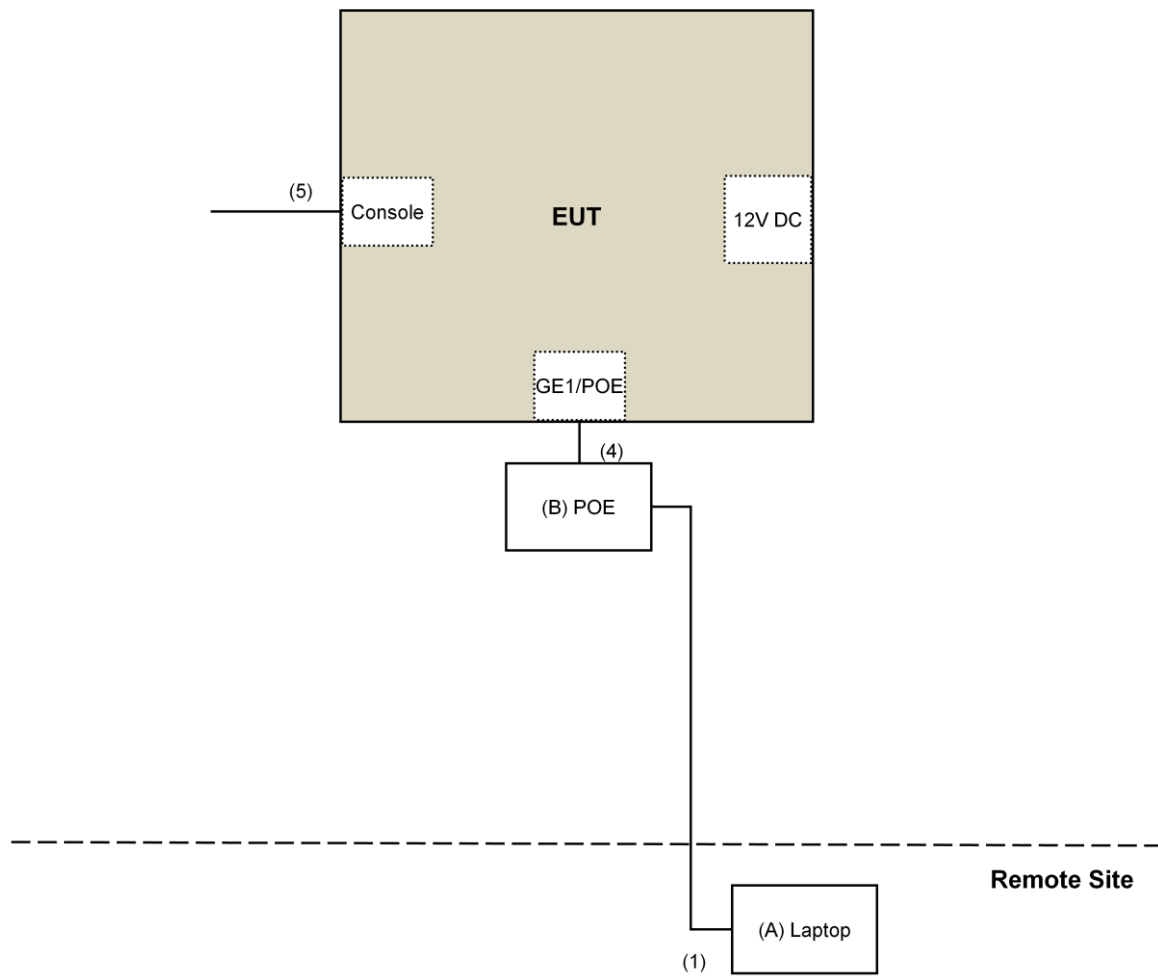



POE Mode (for other test)

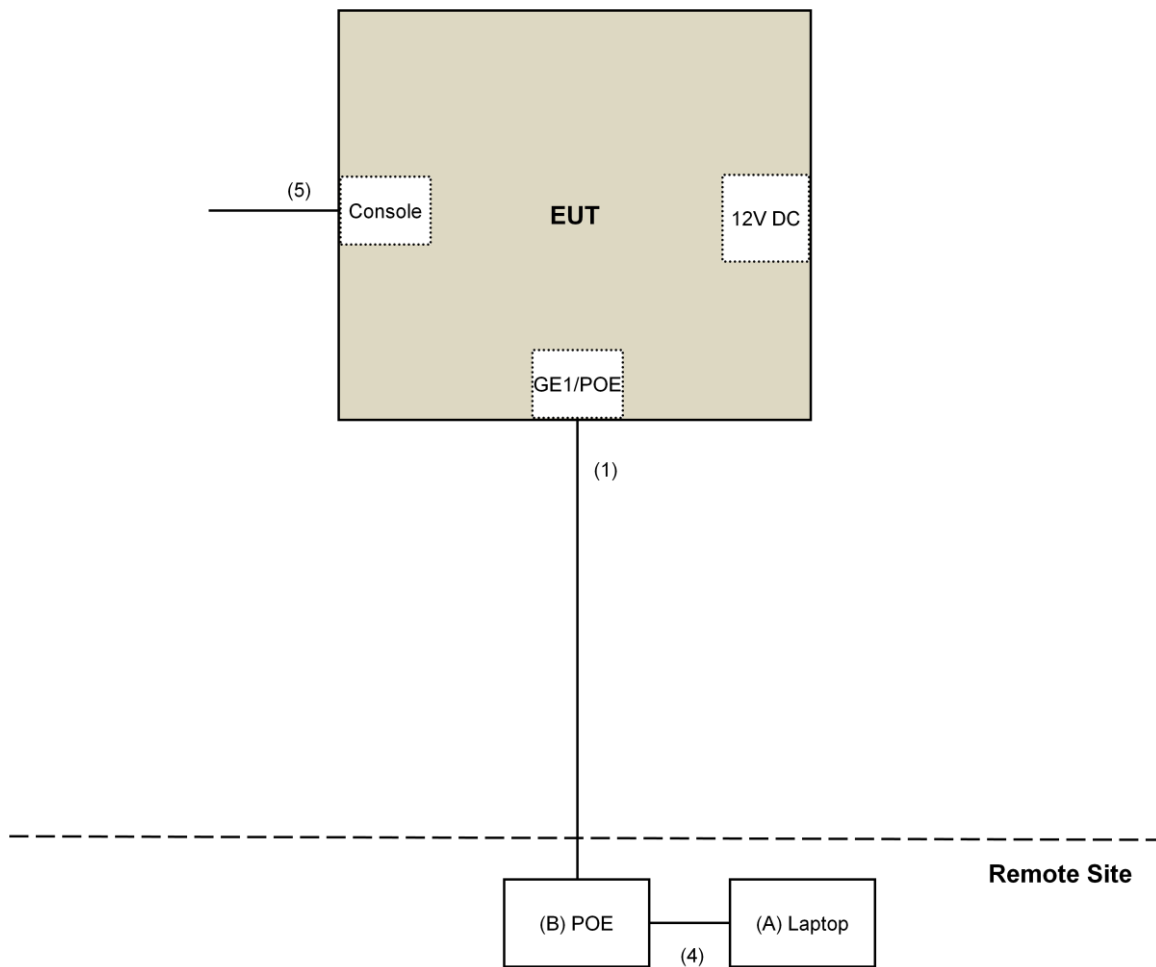

### 3.5 General Description of Applied Standard

The EUT is a RF Product. According to the specifications of the manufacturer, it must comply with the requirements of the following standards:

**FCC Part 15, Subpart E (15.407)**  
**KDB 789033 D02 General UNII Test Procedure New Rules v01r03**  
**KDB 662911 D01 Multiple Transmitter Output v02r01**  
**ANSI C63.10-2013**

All test items have been performed and recorded as per the above standards.

**NOTE:** The EUT has been verified to comply with the requirements of FCC Part 15, Subpart B, Class B (DoC). The test report has been issued separately.

## 4 Test Types and Results

### 4.1 Radiated Emission and Bandedge Measurement

#### 4.1.1 Limits of Radiated Emission and Bandedge Measurement

Radiated emissions which fall in the restricted bands must comply with the radiated emission limits specified as below table.

Frequencies (MHz)	Field Strength (microvolts/meter)	Measurement Distance (meters)
0.009 ~ 0.490	2400/F(kHz)	300
0.490 ~ 1.705	24000/F(kHz)	30
1.705 ~ 30.0	30	30
30 ~ 88	100	3
88 ~ 216	150	3
216 ~ 960	200	3
Above 960	500	3

#### NOTE:

1. The lower limit shall apply at the transition frequencies.
2. Emission level (dBuV/m) = 20 log Emission level (uV/m).
3. For frequencies above 1000MHz, the field strength limits are based on average detector, however, the peak field strength of any emission shall not exceed the maximum permitted average limits, specified above by more than 20dB under any condition of modulation.

Limits of unwanted emission out of the restricted bands

Applicable To		Limit	
789033 D02 General UNII Test Procedure New Rules v01r02		Field Strength at 3m	
		PK:74 (dBμV/m)	AV:54 (dBμV/m)
Frequency Band	Applicable To	EIRP Limit	Equivalent Field Strength at 3m
5150~5250 MHz	15.407(b)(1)	PK:-27 (dBm/MHz)	PK:68.2(dBμV/m)
5250~5350 MHz	15.407(b)(2)		
5470~5725 MHz	15.407(b)(3)		
5725~5850 MHz	<input checked="" type="checkbox"/> 15.407(b)(4)(i)	PK:-27 (dBm/MHz) <sup>*1</sup> PK:10 (dBm/MHz) <sup>*2</sup> PK:15.6 (dBm/MHz) <sup>*3</sup> PK:27 (dBm/MHz) <sup>*4</sup>	PK: 68.2(dBμV/m) <sup>*1</sup> PK:105.2 (dBμV/m) <sup>*2</sup> PK: 110.8(dBμV/m) <sup>*3</sup> PK:122.2 (dBμV/m) <sup>*4</sup>
	<input type="checkbox"/> 15.407(b)(4)(ii)	Emission limits in section 15.247(d)	
<sup>*1</sup> beyond 75 MHz or more above of the band edge.		<sup>*2</sup> below the band edge increasing linearly to 10 dBm/MHz at 25 MHz above.	
<sup>*3</sup> below the band edge increasing linearly to a level of 15.6 dBm/MHz at 5 MHz above.		<sup>*4</sup> from 5 MHz above or below the band edge increasing linearly to a level of 27 dBm/MHz at the band edge.	

#### Note:

The following formula is used to convert the equipment isotropic radiated power (eirp) to field strength:

$$E = \frac{1000000\sqrt{30P}}{3} \mu\text{V/m, where P is the eirp (Watts).}$$

## 4.1.2 Test Instruments

DESCRIPTION & MANUFACTURER	MODEL NO.	SERIAL NO.	CALIBRATED DATE	CALIBRATED UNTIL
Test Receiver Agilent	N9038A	MY51210202	Dec. 16, 2015	Dec. 15, 2016
Pre-Amplifier <sup>(*)</sup> EMCI	EMC001340	980142	Jan. 20, 2016	Jan. 19, 2018
Loop Antenna(*) Electro-Metrics	EM-6879	264	Dec. 16, 2014	Dec. 15, 2016
RF Cable	NA	LOOPCAB-001 LOOPCAB-002	Jan. 18, 2016	Jan. 17, 2017
Pre-Amplifier Mini-Circuits	ZFL-1000VH2B	AMP-ZFL-04	Nov. 11, 2015	Nov. 10, 2016
Trilog Broadband Antenna SCHWARZBECK	VULB 9168	9168-361	Jan. 07, 2016	Jan. 06, 2017
RF Cable	8D-FB	CHHCAB-001-1 CHHCAB-001-2	Oct. 04, 2015	Oct. 03, 2016
	RF-141	CHHCAB-004	Oct. 04, 2015	Oct. 03, 2016
Horn Antenna FT-RF	HA-07M18G-NF	0000220091110	Jan. 18, 2016	Jan. 17, 2017
Pre-Amplifier Agilent	8449B	3008A01923	Oct. 27, 2015	Oct. 26, 2016
RF Cable	NA	131206 131213 131215 SNMY23685/4	Jan. 15, 2016	Jan. 14, 2017
Spectrum Analyzer Agilent	E4446A	MY48250254	Nov. 25, 2015	Nov. 24, 2016
Pre-Amplifier SPACEK LABS	SLKka-48-6	9K16	Dec. 11, 2015	Dec. 10, 2016
Horn Antenna SCHWARZBECK	BBHA 9170	9170-424	Jan. 18, 2016	Jan. 17, 2017
RF Cable	SUCOFLEX 102	36442/2 36434/2	Dec. 10, 2015	Dec.09, 2016
Software	ADT_Radiated_V8.7.08	NA	NA	NA
Antenna Tower & Turn Table CT	CM100	NA	NA	NA
Boresight Antenna Fixture	FBA-01	FBA-WD02	NA	NA
Spectrum Analyzer R&S	FSP40	100060	May 11, 2016	May 10, 2017
Power meter Anritsu	ML2495A	1014008	May 5, 2016	May 4, 2017
Power sensor Anritsu	MA2411B	0917122	May 5, 2016	May 4, 2017
AC Power Source Extech Electronics	6205	1440452	NA	NA
Temperature & Humidity Chamber Giant Force	GTH-150-40-SP-AR	MAA0812-008	Jan. 15, 2016	Jan. 14, 2017
Digital Multimeter FLUKE	87III	73680266	Nov. 10, 2015	Nov. 09, 2016

**Note:**

1. The calibration interval of the above test instruments is 12 months and the calibrations are traceable to NML/ROC and NIST/USA.
2. \*The calibration interval of the above test instruments is 24 months and the calibrations are traceable to NML/ROC and NIST/USA.
3. The test was performed in 966 Chamber No. H.
4. The FCC Site Registration No. is 797305.
5. The CANADA Site Registration No. is IC 7450H-3.
6. Loop antenna was used for all emissions below 30 MHz.
7. Tested Date: Sep. 16 to 29, 2016

#### 4.1.3 Test Procedure

##### **For Radiated emission below 30MHz**

- a. The EUT was placed on the top of a rotating table 0.8 meters above the ground at a 3 meter chamber room. The table was rotated 360 degrees to determine the position of the highest radiation.
- b. The EUT was set 3 meters away from the interference-receiving antenna, which was mounted on the top of a variable-height antenna tower.
- c. Both X and Y axes of the antenna are set to make the measurement.
- d. For each suspected emission, the EUT was arranged to its worst case and the rotatable table was turned from 0 degrees to 360 degrees to find the maximum reading.
- e. The test-receiver system was set to Quasi-Peak Detect Function and Specified Bandwidth with Maximum Hold Mode.

##### **NOTE:**

1. The resolution bandwidth and video bandwidth of test receiver/spectrum analyzer is 9kHz at frequency below 30MHz.

##### **For Radiated emission above 30MHz**

- a. The EUT was placed on the top of a rotating table 0.8 meters (for 30MHz ~ 1GHz) / 1.5 meters (for above 1GHz) above the ground at 3 meter chamber room for test. The table was rotated 360 degrees to determine the position of the highest radiation.
- b. The EUT was set 3 meters away from the interference-receiving antenna, which was mounted on the top of a variable-height antenna tower.
- c. The height of antenna is varied from one meter to four meters above the ground to determine the maximum value of the field strength. Both horizontal and vertical polarizations of the antenna are set to make the measurement.
- d. For each suspected emission, the EUT was arranged to its worst case and then the antenna was tuned to heights from 1 meter to 4 meters and the rotatable table was turned from 0 degrees to 360 degrees to find the maximum reading.
- e. The test-receiver system was set to quasi-peak detect function and specified bandwidth with maximum hold mode when the test frequency is below 1 GHz.
- f. The test-receiver system was set to peak and average detect function and specified bandwidth with maximum hold mode when the test frequency is above 1 GHz. If the peak reading value also meets average limit, measurement with the average detector is unnecessary.

##### **Note:**

1. The resolution bandwidth and video bandwidth of test receiver/spectrum analyzer is 120kHz for Quasi-peak detection (QP) at frequency below 1GHz.
2. The resolution bandwidth of test receiver/spectrum analyzer is 1 MHz and the video bandwidth is 3 MHz for Peak detection (PK) at frequency above 1GHz.
3. The resolution bandwidth of test receiver/spectrum analyzer is 1MHz and the video bandwidth is  $\geq 1/T$  (Duty cycle < 98%) or 10Hz (Duty cycle  $\geq 98\%$ ) for Average detection (AV) at frequency above 1GHz.
4. All modes of operation were investigated and the worst-case emissions are reported.

#### 4.1.4 Deviation from Test Standard

No deviation.

#### 4.1.5 Test Setup

##### For Radiated emission below 30MHz

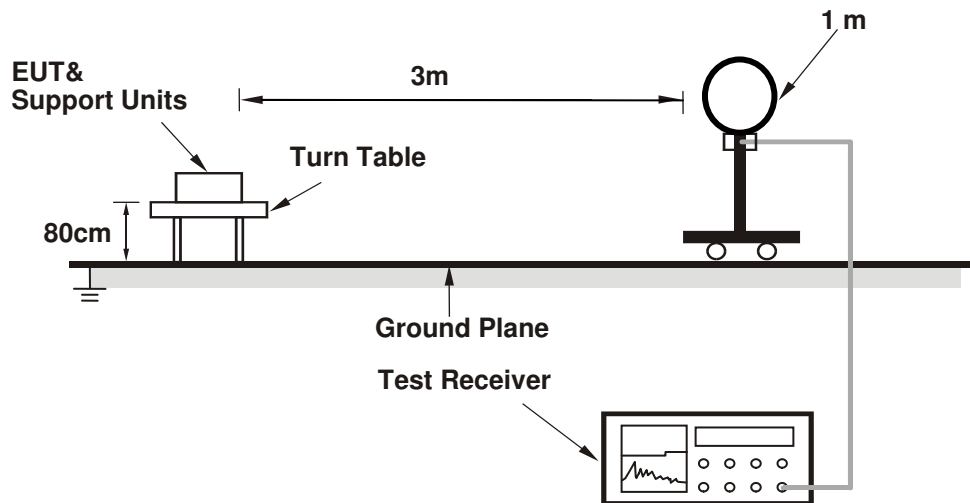

##### For Radiated emission 30MHz to 1GHz

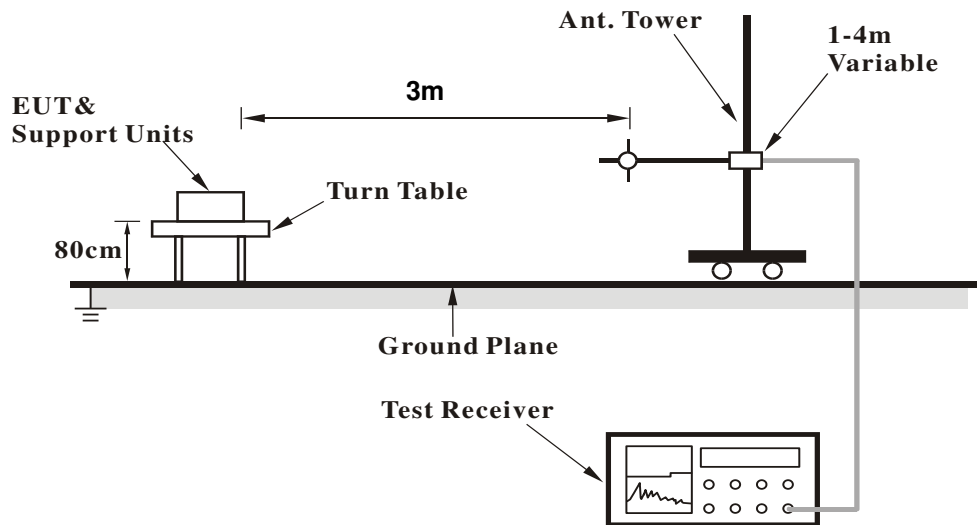

### For Radiated emission above 1GHz

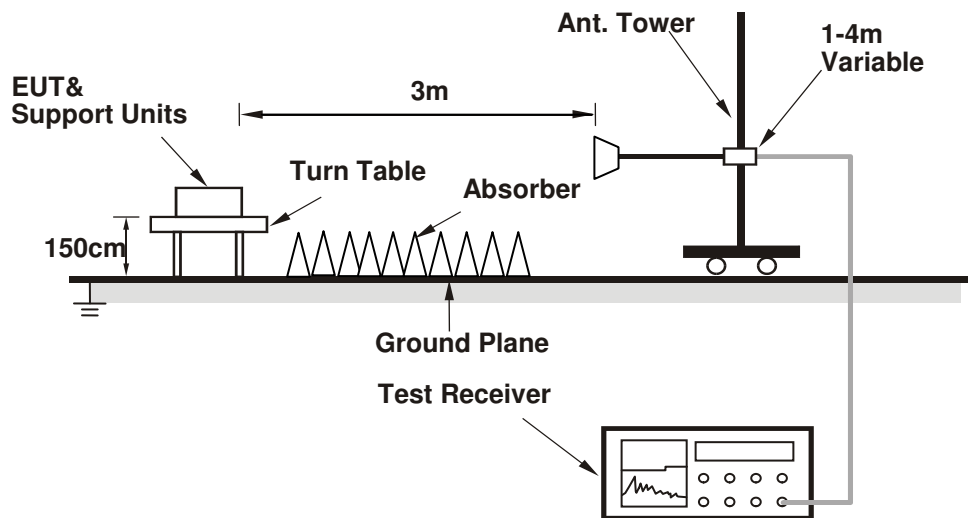

For the actual test configuration, please refer to the attached file (Test Setup Photo).

#### 4.1.6 EUT Operating Condition

- a. Connected the EUT with the Laptop which is placed on remote site.
- b. Controlling software (MTool\_2.0.2.7.exe) has been activated to set the EUT on specific status.

## 4.1.7 Test Results (Mode 1)

## Above 1GHz Data:

## 802.11a

<b>CHANNEL</b>	TX Channel 36	<b>DETECTOR FUNCTION</b>	Peak (PK)
<b>FREQUENCY RANGE</b>	1GHz ~ 40GHz		Average (AV)

**ANTENNA POLARITY & TEST DISTANCE: HORIZONTAL AT 3 M**

NO.	FREQ. (MHz)	EMISSION LEVEL (dBuV/m)	LIMIT (dBuV/m)	MARGIN (dB)	ANTENNA HEIGHT (m)	TABLE ANGLE (Degree)	RAW VALUE (dBuV)	CORRECTION FACTOR (dB/m)
1	5150.00	72.9 PK	74.0	-1.1	1.90 H	311	61.9	11.0
2	5150.00	51.0 AV	54.0	-3.0	1.90 H	311	40.0	11.0
3	*5180.00	113.1 PK			1.90 H	311	101.8	11.3
4	*5180.00	103.7 AV			1.90 H	311	92.4	11.3
5	#10360.00	52.6 PK	74.0	-21.4	1.47 H	328	35.3	17.3
6	#10360.00	39.6 AV	54.0	-14.4	1.47 H	328	22.3	17.3
7	15540.00	55.3 PK	74.0	-18.7	1.32 H	153	34.1	21.2
8	15540.00	43.8 AV	54.0	-10.2	1.32 H	153	22.6	21.2

**ANTENNA POLARITY & TEST DISTANCE: VERTICAL AT 3 M**

NO.	FREQ. (MHz)	EMISSION LEVEL (dBuV/m)	LIMIT (dBuV/m)	MARGIN (dB)	ANTENNA HEIGHT (m)	TABLE ANGLE (Degree)	RAW VALUE (dBuV)	CORRECTION FACTOR (dB/m)
1	5150.00	72.0 PK	74.0	-2.0	2.28 V	36	61.0	11.0
2	5150.00	48.8 AV	54.0	-5.2	2.28 V	36	37.8	11.0
3	*5180.00	110.4 PK			2.28 V	36	99.1	11.3
4	*5180.00	100.4 AV			2.28 V	36	89.1	11.3
5	#10360.00	52.4 PK	74.0	-21.6	1.40 V	184	35.1	17.3
6	#10360.00	41.3 AV	54.0	-12.7	1.40 V	184	24.0	17.3
7	15540.00	59.1 PK	74.0	-14.9	2.19 V	167	37.9	21.2
8	15540.00	47.8 AV	54.0	-6.2	2.19 V	167	26.6	21.2

**REMARKS:**

1. Emission Level(dBuV/m) = Raw Value(dBuV) + Correction Factor(dB/m)
2. Correction Factor(dB/m) = Antenna Factor(dB/m) + Cable Factor(dB) – Pre-Amplifier Factor(dB)
3. The other emission levels were very low against the limit.
4. Margin value = Emission Level – Limit value
5. " \* ": Fundamental frequency.
6. " # ": The radiated frequency is out of the restricted band.



<b>CHANNEL</b>	TX Channel 40	<b>DETECTOR FUNCTION</b>	Peak (PK)
<b>FREQUENCY RANGE</b>	1GHz ~ 40GHz		Average (AV)

**ANTENNA POLARITY & TEST DISTANCE: HORIZONTAL AT 3 M**

NO.	FREQ. (MHz)	EMISSION LEVEL (dBuV/m)	LIMIT (dBuV/m)	MARGIN (dB)	ANTENNA HEIGHT (m)	TABLE ANGLE (Degree)	RAW VALUE (dBuV)	CORRECTION FACTOR (dB/m)
1	5150.00	70.2 PK	74.0	-3.8	1.85 H	312	59.2	11.0
2	5150.00	52.8 AV	54.0	-1.2	1.85 H	312	41.8	11.0
3	*5200.00	116.8 PK			1.85 H	312	105.5	11.3
4	*5200.00	106.3 AV			1.85 H	312	95.0	11.3
5	#10400.00	52.1 PK	74.0	-21.9	1.51 H	327	34.6	17.5
6	#10400.00	39.2 AV	54.0	-14.8	1.51 H	327	21.7	17.5
7	15600.00	55.7 PK	74.0	-18.3	1.32 H	157	34.0	21.7
8	15600.00	43.9 AV	54.0	-10.1	1.32 H	157	22.2	21.7

**ANTENNA POLARITY & TEST DISTANCE: VERTICAL AT 3 M**

NO.	FREQ. (MHz)	EMISSION LEVEL (dBuV/m)	LIMIT (dBuV/m)	MARGIN (dB)	ANTENNA HEIGHT (m)	TABLE ANGLE (Degree)	RAW VALUE (dBuV)	CORRECTION FACTOR (dB/m)
1	5150.00	68.6 PK	74.0	-5.4	2.20 V	36	57.6	11.0
2	5150.00	47.3 AV	54.0	-6.7	2.20 V	36	36.3	11.0
3	*5200.00	114.1 PK			2.20 V	36	102.8	11.3
4	*5200.00	103.2 AV			2.20 V	36	91.9	11.3
5	#10400.00	51.1 PK	74.0	-22.9	1.63 V	148	33.6	17.5
6	#10400.00	39.4 AV	54.0	-14.6	1.63 V	148	21.9	17.5
7	15600.00	59.5 PK	74.0	-14.5	2.18 V	165	37.8	21.7
8	15600.00	47.5 AV	54.0	-6.5	2.18 V	165	25.8	21.7

**REMARKS:**

1. Emission Level(dBuV/m) = Raw Value(dBuV) + Correction Factor(dB/m)
2. Correction Factor(dB/m) = Antenna Factor(dB/m) + Cable Factor(dB) – Pre-Amplifier Factor(dB)
3. The other emission levels were very low against the limit.
4. Margin value = Emission Level – Limit value
5. " \* ": Fundamental frequency.
6. " # ": The radiated frequency is out of the restricted band.

<b>CHANNEL</b>	TX Channel 48	<b>DETECTOR FUNCTION</b>	Peak (PK)
<b>FREQUENCY RANGE</b>	1GHz ~ 40GHz		Average (AV)

**ANTENNA POLARITY & TEST DISTANCE: HORIZONTAL AT 3 M**

NO.	FREQ. (MHz)	EMISSION LEVEL (dBuV/m)	LIMIT (dBuV/m)	MARGIN (dB)	ANTENNA HEIGHT (m)	TABLE ANGLE (Degree)	RAW VALUE (dBuV)	CORRECTION FACTOR (dB/m)
1	*5240.00	119.4 PK			1.31 H	316	108.0	11.4
2	*5240.00	109.4 AV			1.31 H	316	98.0	11.4
3	5350.00	61.8 PK	74.0	-12.2	1.31 H	316	50.4	11.4
4	5350.00	49.2 AV	54.0	-4.8	1.31 H	316	37.8	11.4
5	#10480.00	52.5 PK	74.0	-21.5	1.52 H	322	35.4	17.1
6	#10480.00	39.3 AV	54.0	-14.7	1.52 H	322	22.2	17.1
7	15720.00	55.6 PK	74.0	-18.4	1.33 H	166	34.0	21.6
8	15720.00	43.8 AV	54.0	-10.2	1.33 H	166	22.2	21.6

**ANTENNA POLARITY & TEST DISTANCE: VERTICAL AT 3 M**

NO.	FREQ. (MHz)	EMISSION LEVEL (dBuV/m)	LIMIT (dBuV/m)	MARGIN (dB)	ANTENNA HEIGHT (m)	TABLE ANGLE (Degree)	RAW VALUE (dBuV)	CORRECTION FACTOR (dB/m)
1	*5240.00	116.4 PK			2.19 V	43	105.0	11.4
2	*5240.00	105.8 AV			2.19 V	43	94.4	11.4
3	5350.00	69.2 PK	74.0	-4.8	2.19 V	43	57.8	11.4
4	5350.00	47.8 AV	54.0	-6.2	2.19 V	43	36.4	11.4
5	#10480.00	51.8 PK	74.0	-22.2	1.24 V	178	34.7	17.1
6	#10480.00	42.4 AV	54.0	-11.6	1.24 V	178	25.3	17.1
7	15720.00	61.3 PK	74.0	-12.7	2.20 V	164	39.7	21.6
8	15720.00	47.0 AV	54.0	-7.0	2.20 V	164	25.4	21.6

**REMARKS:**

1. Emission Level(dBuV/m) = Raw Value(dBuV) + Correction Factor(dB/m)
2. Correction Factor(dB/m) = Antenna Factor(dB/m) + Cable Factor(dB) – Pre-Amplifier Factor(dB)
3. The other emission levels were very low against the limit.
4. Margin value = Emission Level – Limit value
5. " \* ": Fundamental frequency.
6. " # ": The radiated frequency is out of the restricted band.

<b>CHANNEL</b>	TX Channel 149	<b>DETECTOR FUNCTION</b>	Peak (PK)
<b>FREQUENCY RANGE</b>	1GHz ~ 40GHz		Average (AV)

**ANTENNA POLARITY & TEST DISTANCE: HORIZONTAL AT 3 M**

NO.	FREQ. (MHz)	EMISSION LEVEL (dBuV/m)	LIMIT (dBuV/m)	MARGIN (dB)	ANTENNA HEIGHT (m)	TABLE ANGLE (Degree)	RAW VALUE (dBuV)	CORRECTION FACTOR (dB/m)
1	#5577.07	66.5 PK	68.2	-1.7	1.28 H	70	54.8	11.7
2	*5745.00	118.8 PK			1.28 H	70	106.9	11.9
3	*5745.00	108.4 AV			1.28 H	70	96.5	11.9
4	#6022.62	66.2 PK	68.2	-2.0	1.28 H	70	54.2	12.0
5	11490.00	51.8 PK	74.0	-22.2	1.50 H	345	34.0	17.8
6	11490.00	38.6 AV	54.0	-15.4	1.50 H	345	20.8	17.8
7	#17235.00	55.0 PK	74.0	-19.0	1.25 H	194	28.6	26.4
8	#17235.00	43.3 AV	54.0	-10.7	1.25 H	194	16.9	26.4

**ANTENNA POLARITY & TEST DISTANCE: VERTICAL AT 3 M**

NO.	FREQ. (MHz)	EMISSION LEVEL (dBuV/m)	LIMIT (dBuV/m)	MARGIN (dB)	ANTENNA HEIGHT (m)	TABLE ANGLE (Degree)	RAW VALUE (dBuV)	CORRECTION FACTOR (dB/m)
1	#5551.90	66.2 PK	68.2	-2.0	2.51 V	352	54.6	11.6
2	*5745.00	115.2 PK			2.51 V	352	103.3	11.9
3	*5745.00	104.5 AV			2.51 V	352	92.6	11.9
4	#5943.30	66.5 PK	68.2	-1.7	2.51 V	352	54.8	11.7
5	11490.00	61.9 PK	74.0	-12.1	1.56 V	144	44.1	17.8
6	11490.00	41.8 AV	54.0	-12.2	1.56 V	144	24.0	17.8
7	#17235.00	59.4 PK	74.0	-14.6	1.64 V	224	33.0	26.4
8	#17235.00	45.6 AV	54.0	-8.4	1.64 V	224	19.2	26.4

**REMARKS:**

1. Emission Level(dBuV/m) = Raw Value(dBuV) + Correction Factor(dB/m)
2. Correction Factor(dB/m) = Antenna Factor(dB/m) + Cable Factor(dB) – Pre-Amplifier Factor(dB)
3. The other emission levels were very low against the limit.
4. Margin value = Emission Level – Limit value
5. " \* ": Fundamental frequency.
6. " # ": The radiated frequency is out of the restricted band.

<b>CHANNEL</b>	TX Channel 157	<b>DETECTOR FUNCTION</b>	Peak (PK)
<b>FREQUENCY RANGE</b>	1GHz ~ 40GHz		Average (AV)

**ANTENNA POLARITY & TEST DISTANCE: HORIZONTAL AT 3 M**

NO.	FREQ. (MHz)	EMISSION LEVEL (dBuV/m)	LIMIT (dBuV/m)	MARGIN (dB)	ANTENNA HEIGHT (m)	TABLE ANGLE (Degree)	RAW VALUE (dBuV)	CORRECTION FACTOR (dB/m)
1	#5589.90	65.8 PK	68.2	-2.4	1.21 H	70	54.1	11.7
2	*5785.00	118.5 PK			1.21 H	70	106.5	12.0
3	*5785.00	107.9 AV			1.21 H	70	95.9	12.0
4	#5942.35	66.6 PK	68.2	-1.6	1.21 H	70	54.9	11.7
5	11570.00	52.0 PK	74.0	-22.0	1.48 H	360	34.2	17.8
6	11570.00	38.8 AV	54.0	-15.2	1.48 H	360	21.0	17.8
7	#17355.00	55.3 PK	74.0	-18.7	1.27 H	205	28.8	26.5
8	#17355.00	43.7 AV	54.0	-10.3	1.27 H	205	17.2	26.5

**ANTENNA POLARITY & TEST DISTANCE: VERTICAL AT 3 M**

NO.	FREQ. (MHz)	EMISSION LEVEL (dBuV/m)	LIMIT (dBuV/m)	MARGIN (dB)	ANTENNA HEIGHT (m)	TABLE ANGLE (Degree)	RAW VALUE (dBuV)	CORRECTION FACTOR (dB/m)
1	#5617.45	64.4 PK	68.2	-3.8	2.35 V	360	52.7	11.7
2	*5785.00	115.9 PK			2.35 V	360	103.9	12.0
3	*5785.00	105.5 AV			2.35 V	360	93.5	12.0
4	#6013.12	64.4 PK	68.2	-3.8	2.35 V	360	52.4	12.0
5	11570.00	61.8 PK	74.0	-12.2	1.56 V	158	44.0	17.8
6	11570.00	42.0 AV	54.0	-12.0	1.56 V	158	24.2	17.8
7	#17355.00	59.7 PK	74.0	-14.3	1.64 V	232	33.2	26.5
8	#17355.00	45.7 AV	54.0	-8.3	1.64 V	232	19.2	26.5

**REMARKS:**

1. Emission Level(dBuV/m) = Raw Value(dBuV) + Correction Factor(dB/m)
2. Correction Factor(dB/m) = Antenna Factor(dB/m) + Cable Factor(dB) – Pre-Amplifier Factor(dB)
3. The other emission levels were very low against the limit.
4. Margin value = Emission Level – Limit value
5. " \* ": Fundamental frequency.
6. " # ": The radiated frequency is out of the restricted band.

<b>CHANNEL</b>	TX Channel 165	<b>DETECTOR FUNCTION</b>	Peak (PK)
<b>FREQUENCY RANGE</b>	1GHz ~ 40GHz		Average (AV)

**ANTENNA POLARITY & TEST DISTANCE: HORIZONTAL AT 3 M**

NO.	FREQ. (MHz)	EMISSION LEVEL (dBuV/m)	LIMIT (dBuV/m)	MARGIN (dB)	ANTENNA HEIGHT (m)	TABLE ANGLE (Degree)	RAW VALUE (dBuV)	CORRECTION FACTOR (dB/m)
1	#5586.57	66.8 PK	68.2	-1.4	1.38 H	67	55.1	11.7
2	*5825.00	118.3 PK			1.38 H	67	106.5	11.8
3	*5825.00	107.8 AV			1.38 H	67	96.0	11.8
4	#5981.30	66.0 PK	68.2	-2.2	1.38 H	67	54.2	11.8
5	11650.00	51.7 PK	74.0	-22.3	1.43 H	360	34.1	17.6
6	11650.00	38.7 AV	54.0	-15.3	1.43 H	360	21.1	17.6
7	#17475.00	55.1 PK	74.0	-18.9	1.24 H	191	28.5	26.6
8	#17475.00	43.6 AV	54.0	-10.4	1.24 H	191	17.0	26.6

**ANTENNA POLARITY & TEST DISTANCE: VERTICAL AT 3 M**

NO.	FREQ. (MHz)	EMISSION LEVEL (dBuV/m)	LIMIT (dBuV/m)	MARGIN (dB)	ANTENNA HEIGHT (m)	TABLE ANGLE (Degree)	RAW VALUE (dBuV)	CORRECTION FACTOR (dB/m)
1	#5631.23	65.6 PK	68.2	-2.6	2.32 V	360	53.9	11.7
2	*5825.00	115.3 PK			2.32 V	360	103.5	11.8
3	*5825.00	105.0 AV			2.32 V	360	93.2	11.8
4	#5982.73	64.6 PK	68.2	-3.6	2.32 V	360	52.8	11.8
5	11650.00	51.8 PK	74.0	-22.2	1.46 V	209	34.2	17.6
6	11650.00	43.0 AV	54.0	-11.0	1.46 V	209	25.4	17.6
7	#17475.00	59.6 PK	74.0	-14.4	1.64 V	235	33.0	26.6
8	#17475.00	45.4 AV	54.0	-8.6	1.64 V	235	18.8	26.6

**REMARKS:**

1. Emission Level(dBuV/m) = Raw Value(dBuV) + Correction Factor(dB/m)
2. Correction Factor(dB/m) = Antenna Factor(dB/m) + Cable Factor(dB) – Pre-Amplifier Factor(dB)
3. The other emission levels were very low against the limit.
4. Margin value = Emission Level – Limit value
5. " \* ": Fundamental frequency.
6. " # ": The radiated frequency is out of the restricted band.

802.11ac (VHT20)

<b>CHANNEL</b>	TX Channel 36	<b>DETECTOR FUNCTION</b>	Peak (PK)
<b>FREQUENCY RANGE</b>	1GHz ~ 40GHz		Average (AV)

ANTENNA POLARITY & TEST DISTANCE: HORIZONTAL AT 3 M								
NO.	FREQ. (MHz)	EMISSION LEVEL (dBuV/m)	LIMIT (dBuV/m)	MARGIN (dB)	ANTENNA HEIGHT (m)	TABLE ANGLE (Degree)	RAW VALUE (dBuV)	CORRECTION FACTOR (dB/m)
1	5150.00	72.7 PK	74.0	-1.3	1.36 H	315	61.7	11.0
2	5150.00	52.4 AV	54.0	-1.6	1.36 H	315	41.4	11.0
3	*5180.00	115.4 PK			1.36 H	315	104.1	11.3
4	*5180.00	103.7 AV			1.36 H	315	92.4	11.3
5	#10360.00	50.9 PK	74.0	-23.1	1.37 H	226	33.6	17.3
6	#10360.00	40.1 AV	54.0	-13.9	1.37 H	226	22.8	17.3
7	15540.00	55.1 PK	74.0	-18.9	1.50 H	360	33.9	21.2
8	15540.00	42.1 AV	54.0	-11.9	1.50 H	360	20.9	21.2

ANTENNA POLARITY & TEST DISTANCE: VERTICAL AT 3 M								
NO.	FREQ. (MHz)	EMISSION LEVEL (dBuV/m)	LIMIT (dBuV/m)	MARGIN (dB)	ANTENNA HEIGHT (m)	TABLE ANGLE (Degree)	RAW VALUE (dBuV)	CORRECTION FACTOR (dB/m)
1	5150.00	68.5 PK	74.0	-5.5	1.50 V	300	57.5	11.0
2	5150.00	47.2 AV	54.0	-6.8	1.50 V	300	36.2	11.0
3	*5180.00	112.6 PK			1.50 V	300	101.3	11.3
4	*5180.00	101.2 AV			1.50 V	300	89.9	11.3
5	#10360.00	48.5 PK	74.0	-25.5	1.50 V	349	31.2	17.3
6	#10360.00	36.7 AV	54.0	-17.3	1.50 V	349	19.4	17.3
7	15540.00	52.5 PK	74.0	-21.5	1.60 V	100	31.3	21.2
8	15540.00	40.3 AV	54.0	-13.7	1.60 V	100	19.1	21.2

**REMARKS:**

1. Emission Level(dBuV/m) = Raw Value(dBuV) + Correction Factor(dB/m)
2. Correction Factor(dB/m) = Antenna Factor(dB/m) + Cable Factor(dB) – Pre-Amplifier Factor(dB)
3. The other emission levels were very low against the limit.
4. Margin value = Emission Level – Limit value
5. " \* ": Fundamental frequency.
6. " # ": The radiated frequency is out of the restricted band.

<b>CHANNEL</b>	TX Channel 40	<b>DETECTOR FUNCTION</b>	Peak (PK)
<b>FREQUENCY RANGE</b>	1GHz ~ 40GHz		Average (AV)

**ANTENNA POLARITY & TEST DISTANCE: HORIZONTAL AT 3 M**

NO.	FREQ. (MHz)	EMISSION LEVEL (dBuV/m)	LIMIT (dBuV/m)	MARGIN (dB)	ANTENNA HEIGHT (m)	TABLE ANGLE (Degree)	RAW VALUE (dBuV)	CORRECTION FACTOR (dB/m)
1	5150.00	70.3 PK	74.0	-3.7	1.41 H	320	59.3	11.0
2	<b>5150.00</b>	<b>52.9 AV</b>	<b>54.0</b>	<b>-1.1</b>	<b>1.41 H</b>	<b>320</b>	<b>41.9</b>	<b>11.0</b>
3	*5200.00	115.1 PK			1.41 H	320	103.8	11.3
4	*5200.00	104.7 AV			1.41 H	320	93.4	11.3
5	#10400.00	51.8 PK	74.0	-22.2	1.55 H	330	34.3	17.5
6	#10400.00	38.9 AV	54.0	-15.1	1.55 H	330	21.4	17.5
7	15600.00	56.0 PK	74.0	-18.0	1.36 H	142	34.3	21.7
8	15600.00	44.0 AV	54.0	-10.0	1.36 H	142	22.3	21.7

**ANTENNA POLARITY & TEST DISTANCE: VERTICAL AT 3 M**

NO.	FREQ. (MHz)	EMISSION LEVEL (dBuV/m)	LIMIT (dBuV/m)	MARGIN (dB)	ANTENNA HEIGHT (m)	TABLE ANGLE (Degree)	RAW VALUE (dBuV)	CORRECTION FACTOR (dB/m)
1	5150.00	68.2 PK	74.0	-5.8	1.45 V	286	57.2	11.0
2	5150.00	46.9 AV	54.0	-7.1	1.45 V	286	35.9	11.0
3	*5200.00	112.4 PK			1.45 V	286	101.1	11.3
4	*5200.00	102.3 AV			1.45 V	286	91.0	11.3
5	#10400.00	50.9 PK	74.0	-23.1	1.65 V	142	33.4	17.5
6	#10400.00	39.1 AV	54.0	-14.9	1.65 V	142	21.6	17.5
7	15600.00	59.7 PK	74.0	-14.3	2.19 V	162	38.0	21.7
8	15600.00	47.6 AV	54.0	-6.4	2.19 V	162	25.9	21.7

**REMARKS:**

1. Emission Level(dBuV/m) = Raw Value(dBuV) + Correction Factor(dB/m)
2. Correction Factor(dB/m) = Antenna Factor(dB/m) + Cable Factor(dB) – Pre-Amplifier Factor(dB)
3. The other emission levels were very low against the limit.
4. Margin value = Emission Level – Limit value
5. " \* ": Fundamental frequency.
6. " # ": The radiated frequency is out of the restricted band.

<b>CHANNEL</b>	TX Channel 48	<b>DETECTOR FUNCTION</b>	Peak (PK)
<b>FREQUENCY RANGE</b>	1GHz ~ 40GHz		Average (AV)

**ANTENNA POLARITY & TEST DISTANCE: HORIZONTAL AT 3 M**

NO.	FREQ. (MHz)	EMISSION LEVEL (dBuV/m)	LIMIT (dBuV/m)	MARGIN (dB)	ANTENNA HEIGHT (m)	TABLE ANGLE (Degree)	RAW VALUE (dBuV)	CORRECTION FACTOR (dB/m)
1	*5240.00	115.5 PK			1.56 H	317	104.1	11.4
2	*5240.00	104.7 AV			1.56 H	317	93.3	11.4
3	5350.00	62.8 PK	74.0	-11.2	1.56 H	317	51.4	11.4
4	5350.00	50.9 AV	54.0	-3.1	1.56 H	317	39.5	11.4
5	#10480.00	51.7 PK	74.0	-22.3	1.56 H	334	34.6	17.1
6	#10480.00	39.0 AV	54.0	-15.0	1.56 H	334	21.9	17.1
7	15720.00	56.0 PK	74.0	-18.0	1.26 H	156	34.4	21.6
8	15720.00	43.9 AV	54.0	-10.1	1.26 H	156	22.3	21.6

**ANTENNA POLARITY & TEST DISTANCE: VERTICAL AT 3 M**

NO.	FREQ. (MHz)	EMISSION LEVEL (dBuV/m)	LIMIT (dBuV/m)	MARGIN (dB)	ANTENNA HEIGHT (m)	TABLE ANGLE (Degree)	RAW VALUE (dBuV)	CORRECTION FACTOR (dB/m)
1	*5240.00	112.3 PK			1.44 V	300	100.9	11.4
2	*5240.00	101.8 AV			1.44 V	300	90.4	11.4
3	5350.00	69.0 PK	74.0	-5.0	1.44 V	300	57.6	11.4
4	5350.00	47.6 AV	54.0	-6.4	1.44 V	300	36.2	11.4
5	#10480.00	50.9 PK	74.0	-23.1	1.58 V	154	33.8	17.1
6	#10480.00	39.0 AV	54.0	-15.0	1.58 V	154	21.9	17.1
7	15720.00	59.5 PK	74.0	-14.5	2.16 V	156	37.9	21.6
8	15720.00	47.7 AV	54.0	-6.3	2.16 V	156	26.1	21.6

**REMARKS:**

1. Emission Level(dBuV/m) = Raw Value(dBuV) + Correction Factor(dB/m)
2. Correction Factor(dB/m) = Antenna Factor(dB/m) + Cable Factor(dB) – Pre-Amplifier Factor(dB)
3. The other emission levels were very low against the limit.
4. Margin value = Emission Level – Limit value
5. " \* ": Fundamental frequency.
6. " # ": The radiated frequency is out of the restricted band.



<b>CHANNEL</b>	TX Channel 149	<b>DETECTOR FUNCTION</b>	Peak (PK)
<b>FREQUENCY RANGE</b>	1GHz ~ 40GHz		Average (AV)

**ANTENNA POLARITY & TEST DISTANCE: HORIZONTAL AT 3 M**

NO.	FREQ. (MHz)	EMISSION LEVEL (dBuV/m)	LIMIT (dBuV/m)	MARGIN (dB)	ANTENNA HEIGHT (m)	TABLE ANGLE (Degree)	RAW VALUE (dBuV)	CORRECTION FACTOR (dB/m)
1	#5578.98	65.4 PK	68.2	-2.8	1.28 H	68	53.7	11.7
2	*5745.00	117.7 PK			1.28 H	69	105.8	11.9
3	*5745.00	106.9 AV			1.28 H	69	95.0	11.9
4	#6011.23	65.1 PK	68.2	-3.1	1.28 H	68	53.1	12.0
5	11490.00	52.2 PK	74.0	-21.8	1.45 H	360	34.4	17.8
6	11490.00	39.1 AV	54.0	-14.9	1.45 H	360	21.3	17.8
7	#17235.00	55.9 PK	74.0	-18.1	1.23 H	212	29.5	26.4
8	#17235.00	44.1 AV	54.0	-9.9	1.23 H	212	17.7	26.4

**ANTENNA POLARITY & TEST DISTANCE: VERTICAL AT 3 M**

NO.	FREQ. (MHz)	EMISSION LEVEL (dBuV/m)	LIMIT (dBuV/m)	MARGIN (dB)	ANTENNA HEIGHT (m)	TABLE ANGLE (Degree)	RAW VALUE (dBuV)	CORRECTION FACTOR (dB/m)
1	#5622.20	65.6 PK	68.2	-2.6	2.56 V	360	53.9	11.7
2	*5745.00	116.7 PK			2.56 V	360	104.8	11.9
3	*5745.00	105.7 AV			2.56 V	360	93.8	11.9
4	#6006.48	66.4 PK	68.2	-1.8	2.56 V	360	54.4	12.0
5	11490.00	61.5 PK	74.0	-12.5	1.55 V	137	43.7	17.8
6	11490.00	41.4 AV	54.0	-12.6	1.55 V	137	23.6	17.8
7	#17235.00	59.6 PK	74.0	-14.4	1.66 V	235	33.2	26.4
8	#17235.00	45.7 AV	54.0	-8.3	1.66 V	235	19.3	26.4

**REMARKS:**

1. Emission Level(dBuV/m) = Raw Value(dBuV) + Correction Factor(dB/m)
2. Correction Factor(dB/m) = Antenna Factor(dB/m) + Cable Factor(dB) – Pre-Amplifier Factor(dB)
3. The other emission levels were very low against the limit.
4. Margin value = Emission Level – Limit value
5. " \* ": Fundamental frequency.
6. " # ": The radiated frequency is out of the restricted band.

<b>CHANNEL</b>	TX Channel 157	<b>DETECTOR FUNCTION</b>	Peak (PK)
<b>FREQUENCY RANGE</b>	1GHz ~ 40GHz		Average (AV)

**ANTENNA POLARITY & TEST DISTANCE: HORIZONTAL AT 3 M**

NO.	FREQ. (MHz)	EMISSION LEVEL (dBuV/m)	LIMIT (dBuV/m)	MARGIN (dB)	ANTENNA HEIGHT (m)	TABLE ANGLE (Degree)	RAW VALUE (dBuV)	CORRECTION FACTOR (dB/m)
1	#5628.37	65.2 PK	68.2	-3.0	1.17 H	67	53.5	11.7
2	*5785.00	117.2 PK			1.17 H	67	105.2	12.0
3	*5785.00	106.4 AV			1.17 H	67	94.4	12.0
4	#5932.85	65.9 PK	68.2	-2.3	1.17 H	67	54.3	11.6
5	11570.00	52.1 PK	74.0	-21.9	1.52 H	360	34.3	17.8
6	11570.00	38.8 AV	54.0	-15.2	1.52 H	360	21.0	17.8
7	#17355.00	55.2 PK	74.0	-18.8	1.30 H	194	28.7	26.5
8	#17355.00	43.4 AV	54.0	-10.6	1.30 H	194	16.9	26.5

**ANTENNA POLARITY & TEST DISTANCE: VERTICAL AT 3 M**

NO.	FREQ. (MHz)	EMISSION LEVEL (dBuV/m)	LIMIT (dBuV/m)	MARGIN (dB)	ANTENNA HEIGHT (m)	TABLE ANGLE (Degree)	RAW VALUE (dBuV)	CORRECTION FACTOR (dB/m)
1	#5626.95	66.0 PK	68.2	-2.2	2.60 V	360	54.3	11.7
2	*5785.00	115.6 PK			2.60 V	360	103.6	12.0
3	*5785.00	104.3 AV			2.60 V	360	92.3	12.0
4	#6017.40	65.4 PK	68.2	-2.8	2.60 V	360	53.4	12.0
5	11570.00	61.3 PK	74.0	-12.7	1.51 V	138	43.5	17.8
6	11570.00	41.4 AV	54.0	-12.6	1.51 V	138	23.6	17.8
7	#17355.00	59.5 PK	74.0	-14.5	1.68 V	223	33.0	26.5
8	#17355.00	45.8 AV	54.0	-8.2	1.68 V	223	19.3	26.5

**REMARKS:**

1. Emission Level(dBuV/m) = Raw Value(dBuV) + Correction Factor(dB/m)
2. Correction Factor(dB/m) = Antenna Factor(dB/m) + Cable Factor(dB) – Pre-Amplifier Factor(dB)
3. The other emission levels were very low against the limit.
4. Margin value = Emission Level – Limit value
5. " \* ": Fundamental frequency.
6. " # ": The radiated frequency is out of the restricted band.

<b>CHANNEL</b>	TX Channel 165	<b>DETECTOR FUNCTION</b>	Peak (PK)
<b>FREQUENCY RANGE</b>	1GHz ~ 40GHz		Average (AV)

**ANTENNA POLARITY & TEST DISTANCE: HORIZONTAL AT 3 M**

NO.	FREQ. (MHz)	EMISSION LEVEL (dBuV/m)	LIMIT (dBuV/m)	MARGIN (dB)	ANTENNA HEIGHT (m)	TABLE ANGLE (Degree)	RAW VALUE (dBuV)	CORRECTION FACTOR (dB/m)
1	#5583.73	66.6 PK	68.2	-1.6	1.38 H	71	54.9	11.7
2	*5825.00	117.4 PK			1.38 H	71	105.6	11.8
3	*5825.00	106.1 AV			1.38 H	71	94.3	11.8
4	#5975.60	66.7 PK	68.2	-1.5	1.38 H	71	54.9	11.8
5	11650.00	51.5 PK	74.0	-22.5	1.52 H	351	33.9	17.6
6	11650.00	38.5 AV	54.0	-15.5	1.52 H	351	20.9	17.6
7	#17475.00	54.9 PK	74.0	-19.1	1.24 H	216	28.3	26.6
8	#17475.00	43.3 AV	54.0	-10.7	1.24 H	216	16.7	26.6

**ANTENNA POLARITY & TEST DISTANCE: VERTICAL AT 3 M**

NO.	FREQ. (MHz)	EMISSION LEVEL (dBuV/m)	LIMIT (dBuV/m)	MARGIN (dB)	ANTENNA HEIGHT (m)	TABLE ANGLE (Degree)	RAW VALUE (dBuV)	CORRECTION FACTOR (dB/m)
1	#5600.35	65.8 PK	68.2	-2.4	2.31 V	360	54.1	11.7
2	*5825.00	114.1 PK			2.31 V	360	102.3	11.8
3	*5825.00	103.3 AV			2.31 V	360	91.5	11.8
4	#5990.32	66.2 PK	68.2	-2.0	2.31 V	360	54.3	11.9
5	11650.00	62.0 PK	74.0	-12.0	1.52 V	142	44.4	17.6
6	11650.00	42.1 AV	54.0	-11.9	1.52 V	142	24.5	17.6
7	#17475.00	59.6 PK	74.0	-14.4	1.66 V	213	33.0	26.6
8	#17475.00	45.9 AV	54.0	-8.1	1.66 V	213	19.3	26.6

**REMARKS:**

1. Emission Level(dBuV/m) = Raw Value(dBuV) + Correction Factor(dB/m)
2. Correction Factor(dB/m) = Antenna Factor(dB/m) + Cable Factor(dB) – Pre-Amplifier Factor(dB)
3. The other emission levels were very low against the limit.
4. Margin value = Emission Level – Limit value
5. " \* ": Fundamental frequency.
6. " # ": The radiated frequency is out of the restricted band.

**802.11ac (VHT40)**

<b>CHANNEL</b>	TX Channel 38	<b>DETECTOR FUNCTION</b>	Peak (PK)
<b>FREQUENCY RANGE</b>	1GHz ~ 40GHz		Average (AV)

**ANTENNA POLARITY & TEST DISTANCE: HORIZONTAL AT 3 M**

NO.	FREQ. (MHz)	EMISSION LEVEL (dBuV/m)	LIMIT (dBuV/m)	MARGIN (dB)	ANTENNA HEIGHT (m)	TABLE ANGLE (Degree)	RAW VALUE (dBuV)	CORRECTION FACTOR (dB/m)
1	5150.00	66.9 PK	74.0	-7.1	1.28 H	304	55.9	11.0
2	5150.00	52.6 AV	54.0	-1.4	1.28 H	304	41.6	11.0
3	*5190.00	104.9 PK			1.28 H	304	93.6	11.3
4	*5190.00	95.6 AV			1.28 H	304	84.3	11.3
5	5350.00	58.4 PK	74.0	-15.6	1.28 H	304	47.0	11.4
6	5350.00	46.1 AV	54.0	-7.9	1.28 H	304	34.7	11.4
7	#10380.00	51.8 PK	74.0	-22.2	1.54 H	331	34.5	17.3
8	#10380.00	39.0 AV	54.0	-15.0	1.54 H	331	21.7	17.3
9	15570.00	56.2 PK	74.0	-17.8	1.30 H	163	34.8	21.4
10	15570.00	44.1 AV	54.0	-9.9	1.30 H	163	22.7	21.4

**ANTENNA POLARITY & TEST DISTANCE: VERTICAL AT 3 M**

NO.	FREQ. (MHz)	EMISSION LEVEL (dBuV/m)	LIMIT (dBuV/m)	MARGIN (dB)	ANTENNA HEIGHT (m)	TABLE ANGLE (Degree)	RAW VALUE (dBuV)	CORRECTION FACTOR (dB/m)
1	5150.00	64.2 PK	74.0	-9.8	1.50 V	300	53.2	11.0
2	5150.00	48.7 AV	54.0	-5.3	1.50 V	300	37.7	11.0
3	*5190.00	101.2 PK			1.50 V	300	89.9	11.3
4	*5190.00	93.4 AV			1.50 V	300	82.1	11.3
5	5350.00	55.4 PK	74.0	-18.6	1.50 V	300	44.0	11.4
6	5350.00	44.2 AV	54.0	-9.8	1.50 V	300	32.8	11.4
7	#10380.00	51.1 PK	74.0	-22.9	1.55 V	157	33.8	17.3
8	#10380.00	39.3 AV	54.0	-14.7	1.55 V	157	22.0	17.3
9	15570.00	59.6 PK	74.0	-14.4	2.12 V	157	38.2	21.4
10	15570.00	47.8 AV	54.0	-6.2	2.12 V	157	26.4	21.4

**REMARKS:**

- Emission Level(dBuV/m) = Raw Value(dBuV) + Correction Factor(dB/m)
- Correction Factor(dB/m) = Antenna Factor(dB/m) + Cable Factor(dB) – Pre-Amplifier Factor(dB)
- The other emission levels were very low against the limit.
- Margin value = Emission Level – Limit value
- " \* ": Fundamental frequency.
- " # ": The radiated frequency is out of the restricted band.

<b>CHANNEL</b>	TX Channel 46	<b>DETECTOR FUNCTION</b>	Peak (PK)
<b>FREQUENCY RANGE</b>	1GHz ~ 40GHz		Average (AV)

**ANTENNA POLARITY & TEST DISTANCE: HORIZONTAL AT 3 M**

NO.	FREQ. (MHz)	EMISSION LEVEL (dBuV/m)	LIMIT (dBuV/m)	MARGIN (dB)	ANTENNA HEIGHT (m)	TABLE ANGLE (Degree)	RAW VALUE (dBuV)	CORRECTION FACTOR (dB/m)
1	*5230.00	116.4 PK			1.92 H	319	105.1	11.3
2	*5230.00	105.8 AV			1.92 H	319	94.5	11.3
3	5350.00	61.4 PK	74.0	-12.6	1.92 H	319	50.0	11.4
4	5350.00	49.2 AV	54.0	-4.8	1.92 H	319	37.8	11.4
5	#10460.00	51.5 PK	74.0	-22.5	1.47 H	321	34.4	17.1
6	#10460.00	38.8 AV	54.0	-15.2	1.47 H	321	21.7	17.1
7	15690.00	56.1 PK	74.0	-17.9	1.33 H	146	34.4	21.7
8	15690.00	44.1 AV	54.0	-9.9	1.33 H	146	22.4	21.7

**ANTENNA POLARITY & TEST DISTANCE: VERTICAL AT 3 M**

NO.	FREQ. (MHz)	EMISSION LEVEL (dBuV/m)	LIMIT (dBuV/m)	MARGIN (dB)	ANTENNA HEIGHT (m)	TABLE ANGLE (Degree)	RAW VALUE (dBuV)	CORRECTION FACTOR (dB/m)
1	*5230.00	113.0 PK			1.60 V	200	101.7	11.3
2	*5230.00	103.7 AV			1.60 V	200	92.4	11.3
3	5350.00	63.9 PK	74.0	-10.1	1.60 V	200	52.5	11.4
4	5350.00	48.3 AV	54.0	-5.7	1.60 V	200	36.9	11.4
5	#10460.00	51.5 PK	74.0	-22.5	1.58 V	156	34.4	17.1
6	#10460.00	39.8 AV	54.0	-14.2	1.58 V	156	22.7	17.1
7	15690.00	59.2 PK	74.0	-14.8	2.20 V	176	37.5	21.7
8	15690.00	47.1 AV	54.0	-6.9	2.20 V	176	25.4	21.7

**REMARKS:**

1. Emission Level(dBuV/m) = Raw Value(dBuV) + Correction Factor(dB/m)
2. Correction Factor(dB/m) = Antenna Factor(dB/m) + Cable Factor(dB) – Pre-Amplifier Factor(dB)
3. The other emission levels were very low against the limit.
4. Margin value = Emission Level – Limit value
5. " \* ": Fundamental frequency.
6. " # ": The radiated frequency is out of the restricted band.

<b>CHANNEL</b>	TX Channel 151	<b>DETECTOR FUNCTION</b>	Peak (PK)
<b>FREQUENCY RANGE</b>	1GHz ~ 40GHz		Average (AV)

**ANTENNA POLARITY & TEST DISTANCE: HORIZONTAL AT 3 M**

NO.	FREQ. (MHz)	EMISSION LEVEL (dBuV/m)	LIMIT (dBuV/m)	MARGIN (dB)	ANTENNA HEIGHT (m)	TABLE ANGLE (Degree)	RAW VALUE (dBuV)	CORRECTION FACTOR (dB/m)
1	#5646.26	66.5 PK	68.2	-1.7	1.96 H	65	54.8	11.7
2	*5755.00	113.5 PK			1.28 H	66	101.6	11.9
3	*5755.00	102.3 AV			1.28 H	66	90.4	11.9
4	#5989.81	65.0 PK	68.2	-3.2	1.96 H	65	53.1	11.9
5	11510.00	51.6 PK	74.0	-22.4	1.51 H	360	33.8	17.8
6	11510.00	38.8 AV	54.0	-15.2	1.51 H	360	21.0	17.8
7	#17265.00	55.1 PK	74.0	-18.9	1.20 H	216	28.6	26.5
8	#17265.00	43.4 AV	54.0	-10.6	1.20 H	216	16.9	26.5

**ANTENNA POLARITY & TEST DISTANCE: VERTICAL AT 3 M**

NO.	FREQ. (MHz)	EMISSION LEVEL (dBuV/m)	LIMIT (dBuV/m)	MARGIN (dB)	ANTENNA HEIGHT (m)	TABLE ANGLE (Degree)	RAW VALUE (dBuV)	CORRECTION FACTOR (dB/m)
1	#5578.50	65.9 PK	68.2	-2.3	1.21 V	343	54.2	11.7
2	*5755.00	108.2 PK			1.21 V	343	96.3	11.9
3	*5755.00	97.1 AV			1.21 V	343	85.2	11.9
4	#5993.65	66.5 PK	68.2	-1.7	1.21 V	343	54.6	11.9
5	11510.00	61.9 PK	74.0	-12.1	1.50 V	137	44.1	17.8
6	11510.00	41.8 AV	54.0	-12.2	1.50 V	137	24.0	17.8
7	#17265.00	60.0 PK	74.0	-14.0	1.62 V	218	33.5	26.5
8	#17265.00	46.1 AV	54.0	-7.9	1.62 V	218	19.6	26.5

**REMARKS:**

1. Emission Level(dBuV/m) = Raw Value(dBuV) + Correction Factor(dB/m)
2. Correction Factor(dB/m) = Antenna Factor(dB/m) + Cable Factor(dB) – Pre-Amplifier Factor(dB)
3. The other emission levels were very low against the limit.
4. Margin value = Emission Level – Limit value
5. " \* ": Fundamental frequency.
6. " # ": The radiated frequency is out of the restricted band.

<b>CHANNEL</b>	TX Channel 159	<b>DETECTOR FUNCTION</b>	Peak (PK)
<b>FREQUENCY RANGE</b>	1GHz ~ 40GHz		Average (AV)

**ANTENNA POLARITY & TEST DISTANCE: HORIZONTAL AT 3 M**

NO.	FREQ. (MHz)	EMISSION LEVEL (dBuV/m)	LIMIT (dBuV/m)	MARGIN (dB)	ANTENNA HEIGHT (m)	TABLE ANGLE (Degree)	RAW VALUE (dBuV)	CORRECTION FACTOR (dB/m)
1	#5643.10	66.4 PK	68.2	-1.8	1.95 H	62	54.7	11.7
2	*5795.00	115.5 PK			1.95 H	62	103.6	11.9
3	*5795.00	103.4 AV			1.95 H	62	91.5	11.9
4	#5930.18	65.2 PK	68.2	-3.0	1.95 H	62	53.6	11.6
5	11590.00	51.4 PK	74.0	-22.6	1.55 H	347	33.7	17.7
6	11590.00	38.5 AV	54.0	-15.5	1.55 H	347	20.8	17.7
7	#17385.00	54.5 PK	74.0	-19.5	1.22 H	217	27.8	26.7
8	#17385.00	43.2 AV	54.0	-10.8	1.22 H	217	16.5	26.7

**ANTENNA POLARITY & TEST DISTANCE: VERTICAL AT 3 M**

NO.	FREQ. (MHz)	EMISSION LEVEL (dBuV/m)	LIMIT (dBuV/m)	MARGIN (dB)	ANTENNA HEIGHT (m)	TABLE ANGLE (Degree)	RAW VALUE (dBuV)	CORRECTION FACTOR (dB/m)
1	#5559.68	65.4 PK	68.2	-2.8	1.36 V	334	53.8	11.6
2	*5795.00	112.5 PK			1.36 V	334	100.6	11.9
3	*5795.00	101.1 AV			1.36 V	334	89.2	11.9
4	#5925.31	64.5 PK	68.2	-3.7	1.36 V	334	53.0	11.5
5	11590.00	61.2 PK	74.0	-12.8	1.55 V	131	43.5	17.7
6	11590.00	41.6 AV	54.0	-12.4	1.55 V	131	23.9	17.7
7	#17385.00	60.0 PK	74.0	-14.0	1.69 V	214	33.3	26.7
8	#17385.00	46.1 AV	54.0	-7.9	1.69 V	214	19.4	26.7

**REMARKS:**

1. Emission Level(dBuV/m) = Raw Value(dBuV) + Correction Factor(dB/m)
2. Correction Factor(dB/m) = Antenna Factor(dB/m) + Cable Factor(dB) – Pre-Amplifier Factor(dB)
3. The other emission levels were very low against the limit.
4. Margin value = Emission Level – Limit value
5. " \* ": Fundamental frequency.
6. " # ": The radiated frequency is out of the restricted band.

802.11ac (VHT80)

<b>CHANNEL</b>	TX Channel 42	<b>DETECTOR FUNCTION</b>	Peak (PK)
<b>FREQUENCY RANGE</b>	1GHz ~ 40GHz		Average (AV)

**ANTENNA POLARITY & TEST DISTANCE: HORIZONTAL AT 3 M**

NO.	FREQ. (MHz)	EMISSION LEVEL (dBuV/m)	LIMIT (dBuV/m)	MARGIN (dB)	ANTENNA HEIGHT (m)	TABLE ANGLE (Degree)	RAW VALUE (dBuV)	CORRECTION FACTOR (dB/m)
1	5150.00	66.9 PK	74.0	-7.1	1.43 H	71	55.9	11.0
2	<b>5150.00</b>	<b>52.9 AV</b>	<b>54.0</b>	<b>-1.1</b>	<b>1.43 H</b>	<b>71</b>	<b>41.9</b>	<b>11.0</b>
3	*5210.00	104.5 PK			1.43 H	71	93.2	11.3
4	*5210.00	93.2 AV			1.43 H	71	81.9	11.3
5	5350.00	60.8 PK	74.0	-13.2	1.43 H	71	49.4	11.4
6	5350.00	48.5 AV	54.0	-5.5	1.43 H	71	37.1	11.4
7	#10420.00	51.0 PK	74.0	-23.0	1.52 H	344	33.7	17.3
8	#10420.00	38.5 AV	54.0	-15.5	1.52 H	344	21.2	17.3
9	15630.00	56.4 PK	74.0	-17.6	1.35 H	155	34.7	21.7
10	15630.00	44.3 AV	54.0	-9.7	1.35 H	155	22.6	21.7

**ANTENNA POLARITY & TEST DISTANCE: VERTICAL AT 3 M**

NO.	FREQ. (MHz)	EMISSION LEVEL (dBuV/m)	LIMIT (dBuV/m)	MARGIN (dB)	ANTENNA HEIGHT (m)	TABLE ANGLE (Degree)	RAW VALUE (dBuV)	CORRECTION FACTOR (dB/m)
1	5150.00	62.4 PK	74.0	-11.6	2.06 V	332	51.4	11.0
2	5150.00	50.7 AV	54.0	-3.3	2.06 V	332	39.7	11.0
3	*5210.00	101.4 PK			2.06 V	332	90.1	11.3
4	*5210.00	90.5 AV			2.06 V	332	79.2	11.3
5	5350.00	61.1 PK	74.0	-12.9	2.06 V	332	49.7	11.4
6	5350.00	47.8 AV	54.0	-6.2	2.06 V	332	36.4	11.4
7	#10420.00	50.9 PK	74.0	-23.1	1.61 V	159	33.6	17.3
8	#10420.00	39.0 AV	54.0	-15.0	1.61 V	159	21.7	17.3
9	15630.00	59.4 PK	74.0	-14.6	2.19 V	149	37.7	21.7
10	15630.00	47.2 AV	54.0	-6.8	2.19 V	149	25.5	21.7

**REMARKS:**

1. Emission Level(dBuV/m) = Raw Value(dBuV) + Correction Factor(dB/m)
2. Correction Factor(dB/m) = Antenna Factor(dB/m) + Cable Factor(dB) – Pre-Amplifier Factor(dB)
3. The other emission levels were very low against the limit.
4. Margin value = Emission Level – Limit value
5. " \* ": Fundamental frequency.
6. " # ": The radiated frequency is out of the restricted band.



<b>CHANNEL</b>	TX Channel 155	<b>DETECTOR FUNCTION</b>	Peak (PK)
<b>FREQUENCY RANGE</b>	1GHz ~ 40GHz		Average (AV)

**ANTENNA POLARITY & TEST DISTANCE: HORIZONTAL AT 3 M**

NO.	FREQ. (MHz)	EMISSION LEVEL (dBuV/m)	LIMIT (dBuV/m)	MARGIN (dB)	ANTENNA HEIGHT (m)	TABLE ANGLE (Degree)	RAW VALUE (dBuV)	CORRECTION FACTOR (dB/m)
1	#5646.90	67.1 PK	68.2	-1.1	1.39 H	66	55.4	11.7
2	*5775.00	107.9 PK			1.39 H	66	95.9	12.0
3	*5775.00	95.4 AV			1.39 H	66	83.4	12.0
4	#5956.60	65.9 PK	68.2	-2.3	1.39 H	66	54.2	11.7
5	11550.00	51.8 PK	74.0	-22.2	1.51 H	360	34.0	17.8
6	11550.00	38.6 AV	54.0	-15.4	1.51 H	360	20.8	17.8
7	#17325.00	55.3 PK	74.0	-18.7	1.27 H	208	28.8	26.5
8	#17325.00	43.7 AV	54.0	-10.3	1.27 H	208	17.2	26.5

**ANTENNA POLARITY & TEST DISTANCE: VERTICAL AT 3 M**

NO.	FREQ. (MHz)	EMISSION LEVEL (dBuV/m)	LIMIT (dBuV/m)	MARGIN (dB)	ANTENNA HEIGHT (m)	TABLE ANGLE (Degree)	RAW VALUE (dBuV)	CORRECTION FACTOR (dB/m)
1	#5571.37	66.5 PK	68.2	-1.7	1.21 V	343	54.8	11.7
2	*5775.00	103.4 PK			1.21 V	343	91.4	12.0
3	*5775.00	90.8 AV			1.21 V	343	78.8	12.0
4	#5982.73	66.5 PK	68.2	-1.7	1.21 V	343	54.7	11.8
5	11550.00	60.9 PK	74.0	-13.1	1.48 V	145	43.1	17.8
6	11550.00	41.0 AV	54.0	-13.0	1.48 V	145	23.2	17.8
7	#17325.00	59.1 PK	74.0	-14.9	1.63 V	230	32.6	26.5
8	#17325.00	45.6 AV	54.0	-8.4	1.63 V	230	19.1	26.5

**REMARKS:**

1. Emission Level(dBuV/m) = Raw Value(dBuV) + Correction Factor(dB/m)
2. Correction Factor(dB/m) = Antenna Factor(dB/m) + Cable Factor(dB) – Pre-Amplifier Factor(dB)
3. The other emission levels were very low against the limit.
4. Margin value = Emission Level – Limit value
5. " \* ": Fundamental frequency.
6. " # ": The radiated frequency is out of the restricted band.

**Below 1GHz Data:**

**802.11a**

<b>CHANNEL</b>	TX Channel 36	<b>DETECTOR FUNCTION</b>	Quasi-Peak (QP)
<b>FREQUENCY RANGE</b>	9kHz ~ 1GHz		

**ANTENNA POLARITY & TEST DISTANCE: HORIZONTAL AT 3 M**

NO.	FREQ. (MHz)	EMISSION LEVEL (dBuV/m)	LIMIT (dBuV/m)	MARGIN (dB)	ANTENNA HEIGHT (m)	TABLE ANGLE (Degree)	RAW VALUE (dBuV)	CORRECTION FACTOR (dB/m)
1	48.74	29.2 QP	40.0	-10.8	1.90 H	102	37.7	-8.5
2	149.96	24.0 QP	43.5	-19.5	1.00 H	287	31.7	-7.7
3	204.57	23.3 QP	43.5	-20.2	1.00 H	41	34.1	-10.8
4	517.43	31.7 QP	46.0	-14.3	1.02 H	275	32.9	-1.2
5	624.83	38.0 QP	46.0	-8.0	1.41 H	329	36.7	1.3
6	949.83	37.5 QP	46.0	-8.5	1.00 H	225	30.6	6.9

**ANTENNA POLARITY & TEST DISTANCE: VERTICAL AT 3 M**

NO.	FREQ. (MHz)	EMISSION LEVEL (dBuV/m)	LIMIT (dBuV/m)	MARGIN (dB)	ANTENNA HEIGHT (m)	TABLE ANGLE (Degree)	RAW VALUE (dBuV)	CORRECTION FACTOR (dB/m)
1	37.08	35.7 QP	40.0	-4.3	2.04 V	291	44.8	-9.1
2	93.65	30.0 QP	43.5	-13.5	1.44 V	67	43.4	-13.4
3	375.01	30.0 QP	46.0	-16.0	1.00 V	246	34.7	-4.7
4	624.89	38.1 QP	46.0	-7.9	1.02 V	188	36.8	1.3
5	875.06	36.6 QP	46.0	-9.4	1.00 V	300	31.4	5.2
6	1000.00	39.9 QP	54.0	-14.1	1.52 V	56	32.4	7.5

**REMARKS:**

1. Emission Level(dBuV/m) = Raw Value(dBuV) + Correction Factor(dB/m)
2. Correction Factor(dB/m) = Antenna Factor(dB/m) + Cable Factor(dB) – Pre-Amplifier Factor(dB)
3. The other emission levels were very low against the limit.
4. Margin value = Emission Level – Limit value

<b>CHANNEL</b>	TX Channel 40	<b>DETECTOR FUNCTION</b>	Quasi-Peak (QP)
<b>FREQUENCY RANGE</b>	9kHz ~ 1GHz		

**ANTENNA POLARITY & TEST DISTANCE: HORIZONTAL AT 3 M**

NO.	FREQ. (MHz)	EMISSION LEVEL (dBuV/m)	LIMIT (dBuV/m)	MARGIN (dB)	ANTENNA HEIGHT (m)	TABLE ANGLE (Degree)	RAW VALUE (dBuV)	CORRECTION FACTOR (dB/m)
1	48.80	29.3 QP	40.0	-10.7	2.06 H	120	37.8	-8.5
2	150.29	24.8 QP	43.5	-18.7	1.00 H	291	32.5	-7.7
3	204.90	23.9 QP	43.5	-19.6	1.00 H	65	34.7	-10.8
4	517.53	31.6 QP	46.0	-14.4	1.00 H	280	32.8	-1.2
5	624.99	38.3 QP	46.0	-7.7	1.51 H	318	37.0	1.3
6	949.55	37.3 QP	46.0	-8.7	1.00 H	246	30.4	6.9

**ANTENNA POLARITY & TEST DISTANCE: VERTICAL AT 3 M**

NO.	FREQ. (MHz)	EMISSION LEVEL (dBuV/m)	LIMIT (dBuV/m)	MARGIN (dB)	ANTENNA HEIGHT (m)	TABLE ANGLE (Degree)	RAW VALUE (dBuV)	CORRECTION FACTOR (dB/m)
1	37.24	35.9 QP	40.0	-4.1	1.95 V	319	44.9	-9.0
2	93.86	30.0 QP	43.5	-13.5	1.48 V	51	43.4	-13.4
3	375.02	30.5 QP	46.0	-15.5	1.00 V	214	35.2	-4.7
4	624.95	38.2 QP	46.0	-7.8	1.03 V	192	36.9	1.3
5	874.82	37.0 QP	46.0	-9.0	1.03 V	295	31.8	5.2
6	1000.00	39.8 QP	54.0	-14.2	1.48 V	44	32.3	7.5

**REMARKS:**

1. Emission Level(dBuV/m) = Raw Value(dBuV) + Correction Factor(dB/m)
2. Correction Factor(dB/m) = Antenna Factor(dB/m) + Cable Factor(dB) – Pre-Amplifier Factor(dB)
3. The other emission levels were very low against the limit.
4. Margin value = Emission Level – Limit value

<b>CHANNEL</b>	TX Channel 48	<b>DETECTOR FUNCTION</b>	Quasi-Peak (QP)
<b>FREQUENCY RANGE</b>	9kHz ~ 1GHz		

**ANTENNA POLARITY & TEST DISTANCE: HORIZONTAL AT 3 M**

NO.	FREQ. (MHz)	EMISSION LEVEL (dBuV/m)	LIMIT (dBuV/m)	MARGIN (dB)	ANTENNA HEIGHT (m)	TABLE ANGLE (Degree)	RAW VALUE (dBuV)	CORRECTION FACTOR (dB/m)
1	48.98	29.1 QP	40.0	-10.9	1.94 H	95	37.6	-8.5
2	150.49	24.5 QP	43.5	-19.0	1.00 H	291	32.2	-7.7
3	204.59	23.7 QP	43.5	-19.8	1.03 H	64	34.5	-10.8
4	517.63	31.5 QP	46.0	-14.5	1.00 H	289	32.7	-1.2
5	625.09	38.2 QP	46.0	-7.8	1.48 H	300	36.9	1.3
6	949.45	37.5 QP	46.0	-8.5	1.00 H	237	30.6	6.9

**ANTENNA POLARITY & TEST DISTANCE: VERTICAL AT 3 M**

NO.	FREQ. (MHz)	EMISSION LEVEL (dBuV/m)	LIMIT (dBuV/m)	MARGIN (dB)	ANTENNA HEIGHT (m)	TABLE ANGLE (Degree)	RAW VALUE (dBuV)	CORRECTION FACTOR (dB/m)
1	37.15	35.7 QP	40.0	-4.3	1.99 V	296	44.7	-9.0
2	93.46	30.6 QP	43.5	-12.9	1.46 V	49	44.0	-13.4
3	374.84	30.1 QP	46.0	-15.9	1.00 V	234	34.8	-4.7
4	624.93	37.9 QP	46.0	-8.1	1.00 V	190	36.6	1.3
5	875.01	36.6 QP	46.0	-9.4	1.06 V	318	31.4	5.2
6	1000.00	40.2 QP	54.0	-13.8	1.38 V	61	32.7	7.5

**REMARKS:**

1. Emission Level(dBuV/m) = Raw Value(dBuV) + Correction Factor(dB/m)
2. Correction Factor(dB/m) = Antenna Factor(dB/m) + Cable Factor(dB) – Pre-Amplifier Factor(dB)
3. The other emission levels were very low against the limit.
4. Margin value = Emission Level – Limit value

<b>CHANNEL</b>	TX Channel 149	<b>DETECTOR FUNCTION</b>	Quasi-Peak (QP)
<b>FREQUENCY RANGE</b>	9kHz ~ 1GHz		

**ANTENNA POLARITY & TEST DISTANCE: HORIZONTAL AT 3 M**

NO.	FREQ. (MHz)	EMISSION LEVEL (dBuV/m)	LIMIT (dBuV/m)	MARGIN (dB)	ANTENNA HEIGHT (m)	TABLE ANGLE (Degree)	RAW VALUE (dBuV)	CORRECTION FACTOR (dB/m)
1	49.07	29.4 QP	40.0	-10.6	1.97 H	96	37.9	-8.5
2	150.00	24.5 QP	43.5	-19.0	1.01 H	271	32.2	-7.7
3	204.53	24.1 QP	43.5	-19.4	1.05 H	56	34.9	-10.8
4	517.62	31.5 QP	46.0	-14.5	1.00 H	282	32.7	-1.2
5	624.93	38.0 QP	46.0	-8.0	1.45 H	309	36.7	1.3
6	949.88	37.6 QP	46.0	-8.4	1.00 H	243	30.7	6.9

**ANTENNA POLARITY & TEST DISTANCE: VERTICAL AT 3 M**

NO.	FREQ. (MHz)	EMISSION LEVEL (dBuV/m)	LIMIT (dBuV/m)	MARGIN (dB)	ANTENNA HEIGHT (m)	TABLE ANGLE (Degree)	RAW VALUE (dBuV)	CORRECTION FACTOR (dB/m)
<b>1</b>	<b>37.10</b>	<b>36.2 QP</b>	<b>40.0</b>	<b>-3.8</b>	<b>2.03 V</b>	<b>318</b>	<b>45.3</b>	<b>-9.1</b>
2	93.86	30.5 QP	43.5	-13.0	1.51 V	45	43.9	-13.4
3	375.03	30.4 QP	46.0	-15.6	1.00 V	251	35.1	-4.7
4	624.99	38.0 QP	46.0	-8.0	1.01 V	195	36.7	1.3
5	875.06	37.0 QP	46.0	-9.0	1.00 V	304	31.8	5.2
6	1000.00	39.9 QP	54.0	-14.1	1.51 V	51	32.4	7.5

**REMARKS:**

1. Emission Level(dBuV/m) = Raw Value(dBuV) + Correction Factor(dB/m)
2. Correction Factor(dB/m) = Antenna Factor(dB/m) + Cable Factor(dB) – Pre-Amplifier Factor(dB)
3. The other emission levels were very low against the limit.
4. Margin value = Emission Level – Limit value

<b>CHANNEL</b>	TX Channel 157	<b>DETECTOR FUNCTION</b>	Quasi-Peak (QP)
<b>FREQUENCY RANGE</b>	9kHz ~ 1GHz		

**ANTENNA POLARITY & TEST DISTANCE: HORIZONTAL AT 3 M**

NO.	FREQ. (MHz)	EMISSION LEVEL (dBuV/m)	LIMIT (dBuV/m)	MARGIN (dB)	ANTENNA HEIGHT (m)	TABLE ANGLE (Degree)	RAW VALUE (dBuV)	CORRECTION FACTOR (dB/m)
1	48.85	29.1 QP	40.0	-10.9	2.02 H	101	37.6	-8.5
2	150.37	24.8 QP	43.5	-18.7	1.00 H	298	32.5	-7.7
3	204.36	23.8 QP	43.5	-19.7	1.00 H	43	34.6	-10.8
4	517.69	31.4 QP	46.0	-14.6	1.00 H	278	32.6	-1.2
5	624.90	37.8 QP	46.0	-8.2	1.46 H	316	36.5	1.3
6	949.59	37.7 QP	46.0	-8.3	1.00 H	228	30.8	6.9

**ANTENNA POLARITY & TEST DISTANCE: VERTICAL AT 3 M**

NO.	FREQ. (MHz)	EMISSION LEVEL (dBuV/m)	LIMIT (dBuV/m)	MARGIN (dB)	ANTENNA HEIGHT (m)	TABLE ANGLE (Degree)	RAW VALUE (dBuV)	CORRECTION FACTOR (dB/m)
1	37.38	36.0 QP	40.0	-4.0	1.98 V	319	45.0	-9.0
2	93.28	30.4 QP	43.5	-13.1	1.52 V	47	43.9	-13.5
3	374.95	30.6 QP	46.0	-15.4	1.01 V	228	35.3	-4.7
4	624.94	37.8 QP	46.0	-8.2	1.00 V	189	36.5	1.3
5	875.07	36.4 QP	46.0	-9.6	1.00 V	304	31.2	5.2
6	1000.00	39.9 QP	54.0	-14.1	1.49 V	54	32.4	7.5

**REMARKS:**

1. Emission Level(dBuV/m) = Raw Value(dBuV) + Correction Factor(dB/m)
2. Correction Factor(dB/m) = Antenna Factor(dB/m) + Cable Factor(dB) – Pre-Amplifier Factor(dB)
3. The other emission levels were very low against the limit.
4. Margin value = Emission Level – Limit value

<b>CHANNEL</b>	TX Channel 165	<b>DETECTOR FUNCTION</b>	Quasi-Peak (QP)
<b>FREQUENCY RANGE</b>	9kHz ~ 1GHz		

**ANTENNA POLARITY & TEST DISTANCE: HORIZONTAL AT 3 M**

NO.	FREQ. (MHz)	EMISSION LEVEL (dBuV/m)	LIMIT (dBuV/m)	MARGIN (dB)	ANTENNA HEIGHT (m)	TABLE ANGLE (Degree)	RAW VALUE (dBuV)	CORRECTION FACTOR (dB/m)
1	48.96	29.2 QP	40.0	-10.8	1.87 H	112	37.7	-8.5
2	149.52	24.1 QP	43.5	-19.4	1.00 H	261	31.8	-7.7
3	204.86	23.9 QP	43.5	-19.6	1.00 H	22	34.7	-10.8
4	517.71	31.9 QP	46.0	-14.1	1.00 H	270	33.1	-1.2
5	624.88	37.6 QP	46.0	-8.4	1.56 H	310	36.3	1.3
6	949.24	37.3 QP	46.0	-8.7	1.01 H	248	30.4	6.9

**ANTENNA POLARITY & TEST DISTANCE: VERTICAL AT 3 M**

NO.	FREQ. (MHz)	EMISSION LEVEL (dBuV/m)	LIMIT (dBuV/m)	MARGIN (dB)	ANTENNA HEIGHT (m)	TABLE ANGLE (Degree)	RAW VALUE (dBuV)	CORRECTION FACTOR (dB/m)
1	37.13	35.4 QP	40.0	-4.6	2.00 V	299	44.4	-9.0
2	93.94	30.5 QP	43.5	-13.0	1.55 V	56	43.9	-13.4
3	374.89	30.2 QP	46.0	-15.8	1.00 V	242	34.9	-4.7
4	624.93	38.2 QP	46.0	-7.8	1.00 V	203	36.9	1.3
5	875.01	36.6 QP	46.0	-9.4	1.03 V	303	31.4	5.2
6	1000.00	39.7 QP	54.0	-14.3	1.50 V	39	32.2	7.5

**REMARKS:**

1. Emission Level(dBuV/m) = Raw Value(dBuV) + Correction Factor(dB/m)
2. Correction Factor(dB/m) = Antenna Factor(dB/m) + Cable Factor(dB) – Pre-Amplifier Factor(dB)
3. The other emission levels were very low against the limit.
4. Margin value = Emission Level – Limit value

**802.11ac (VHT20)**

<b>CHANNEL</b>	TX Channel 36	<b>DETECTOR FUNCTION</b>	Quasi-Peak (QP)
<b>FREQUENCY RANGE</b>	9kHz ~ 1GHz		

**ANTENNA POLARITY & TEST DISTANCE: HORIZONTAL AT 3 M**

NO.	FREQ. (MHz)	EMISSION LEVEL (dBuV/m)	LIMIT (dBuV/m)	MARGIN (dB)	ANTENNA HEIGHT (m)	TABLE ANGLE (Degree)	RAW VALUE (dBuV)	CORRECTION FACTOR (dB/m)
1	48.84	29.3 QP	40.0	-10.7	1.89 H	104	37.8	-8.5
2	149.91	24.7 QP	43.5	-18.8	1.02 H	293	32.4	-7.7
3	204.67	24.1 QP	43.5	-19.4	1.00 H	40	34.9	-10.8
4	517.61	31.3 QP	46.0	-14.7	1.04 H	299	32.5	-1.2
5	624.91	38.2 QP	46.0	-7.8	1.56 H	329	36.9	1.3
6	949.59	37.4 QP	46.0	-8.6	1.00 H	257	30.5	6.9

**ANTENNA POLARITY & TEST DISTANCE: VERTICAL AT 3 M**

NO.	FREQ. (MHz)	EMISSION LEVEL (dBuV/m)	LIMIT (dBuV/m)	MARGIN (dB)	ANTENNA HEIGHT (m)	TABLE ANGLE (Degree)	RAW VALUE (dBuV)	CORRECTION FACTOR (dB/m)
1	37.04	35.7 QP	40.0	-4.3	2.03 V	307	44.8	-9.1
2	93.71	30.7 QP	43.5	-12.8	1.49 V	42	44.1	-13.4
3	374.93	30.1 QP	46.0	-15.9	1.05 V	254	34.8	-4.7
4	624.91	38.2 QP	46.0	-7.8	1.01 V	187	36.9	1.3
5	874.86	36.8 QP	46.0	-9.2	1.00 V	281	31.6	5.2
6	1000.00	39.9 QP	54.0	-14.1	1.42 V	49	32.4	7.5

**REMARKS:**

1. Emission Level(dBuV/m) = Raw Value(dBuV) + Correction Factor(dB/m)
2. Correction Factor(dB/m) = Antenna Factor(dB/m) + Cable Factor(dB) – Pre-Amplifier Factor(dB)
3. The other emission levels were very low against the limit.
4. Margin value = Emission Level – Limit value



<b>CHANNEL</b>	TX Channel 40	<b>DETECTOR FUNCTION</b>	Quasi-Peak (QP)
<b>FREQUENCY RANGE</b>	9kHz ~ 1GHz		

**ANTENNA POLARITY & TEST DISTANCE: HORIZONTAL AT 3 M**

NO.	FREQ. (MHz)	EMISSION LEVEL (dBuV/m)	LIMIT (dBuV/m)	MARGIN (dB)	ANTENNA HEIGHT (m)	TABLE ANGLE (Degree)	RAW VALUE (dBuV)	CORRECTION FACTOR (dB/m)
1	48.91	29.1 QP	40.0	-10.9	2.04 H	79	37.6	-8.5
2	150.33	24.8 QP	43.5	-18.7	1.00 H	274	32.5	-7.7
3	204.76	24.2 QP	43.5	-19.3	1.00 H	58	35.0	-10.8
4	517.72	31.6 QP	46.0	-14.4	1.04 H	272	32.8	-1.2
5	625.09	38.0 QP	46.0	-8.0	1.38 H	316	36.7	1.3
6	949.34	37.3 QP	46.0	-8.7	1.05 H	200	30.4	6.9

**ANTENNA POLARITY & TEST DISTANCE: VERTICAL AT 3 M**

NO.	FREQ. (MHz)	EMISSION LEVEL (dBuV/m)	LIMIT (dBuV/m)	MARGIN (dB)	ANTENNA HEIGHT (m)	TABLE ANGLE (Degree)	RAW VALUE (dBuV)	CORRECTION FACTOR (dB/m)
1	36.94	35.7 QP	40.0	-4.3	1.99 V	293	44.8	-9.1
2	93.65	30.5 QP	43.5	-13.0	1.53 V	43	43.9	-13.4
3	374.91	29.9 QP	46.0	-16.1	1.00 V	241	34.6	-4.7
4	625.06	38.1 QP	46.0	-7.9	1.00 V	169	36.8	1.3
5	874.92	36.9 QP	46.0	-9.1	1.00 V	303	31.7	5.2
6	1000.00	39.7 QP	54.0	-14.3	1.49 V	39	32.2	7.5

**REMARKS:**

1. Emission Level(dBuV/m) = Raw Value(dBuV) + Correction Factor(dB/m)
2. Correction Factor(dB/m) = Antenna Factor(dB/m) + Cable Factor(dB) – Pre-Amplifier Factor(dB)
3. The other emission levels were very low against the limit.
4. Margin value = Emission Level – Limit value

<b>CHANNEL</b>	TX Channel 48	<b>DETECTOR FUNCTION</b>	Quasi-Peak (QP)
<b>FREQUENCY RANGE</b>	9kHz ~ 1GHz		

**ANTENNA POLARITY & TEST DISTANCE: HORIZONTAL AT 3 M**

NO.	FREQ. (MHz)	EMISSION LEVEL (dBuV/m)	LIMIT (dBuV/m)	MARGIN (dB)	ANTENNA HEIGHT (m)	TABLE ANGLE (Degree)	RAW VALUE (dBuV)	CORRECTION FACTOR (dB/m)
1	49.01	28.8 QP	40.0	-11.2	1.93 H	120	37.3	-8.5
2	150.02	24.8 QP	43.5	-18.7	1.00 H	289	32.5	-7.7
3	204.21	23.8 QP	43.5	-19.7	1.00 H	65	34.6	-10.8
4	517.81	31.6 QP	46.0	-14.4	1.00 H	293	32.8	-1.2
5	624.93	38.0 QP	46.0	-8.0	1.53 H	316	36.7	1.3
6	949.29	37.6 QP	46.0	-8.4	1.01 H	248	30.7	6.9

**ANTENNA POLARITY & TEST DISTANCE: VERTICAL AT 3 M**

NO.	FREQ. (MHz)	EMISSION LEVEL (dBuV/m)	LIMIT (dBuV/m)	MARGIN (dB)	ANTENNA HEIGHT (m)	TABLE ANGLE (Degree)	RAW VALUE (dBuV)	CORRECTION FACTOR (dB/m)
1	37.24	36.1 QP	40.0	-3.9	2.04 V	309	45.1	-9.0
2	93.13	30.2 QP	43.5	-13.3	1.49 V	44	43.7	-13.5
3	374.97	29.9 QP	46.0	-16.1	1.00 V	245	34.6	-4.7
4	624.94	37.7 QP	46.0	-8.3	1.00 V	179	36.4	1.3
5	874.97	37.0 QP	46.0	-9.0	1.01 V	284	31.8	5.2
6	1000.00	39.7 QP	54.0	-14.3	1.48 V	66	32.2	7.5

**REMARKS:**

1. Emission Level(dBuV/m) = Raw Value(dBuV) + Correction Factor(dB/m)
2. Correction Factor(dB/m) = Antenna Factor(dB/m) + Cable Factor(dB) – Pre-Amplifier Factor(dB)
3. The other emission levels were very low against the limit.
4. Margin value = Emission Level – Limit value

<b>CHANNEL</b>	TX Channel 149	<b>DETECTOR FUNCTION</b>	Quasi-Peak (QP)
<b>FREQUENCY RANGE</b>	9kHz ~ 1GHz		

**ANTENNA POLARITY & TEST DISTANCE: HORIZONTAL AT 3 M**

NO.	FREQ. (MHz)	EMISSION LEVEL (dBuV/m)	LIMIT (dBuV/m)	MARGIN (dB)	ANTENNA HEIGHT (m)	TABLE ANGLE (Degree)	RAW VALUE (dBuV)	CORRECTION FACTOR (dB/m)
1	48.74	29.3 QP	40.0	-10.7	2.04 H	90	37.8	-8.5
2	150.48	24.9 QP	43.5	-18.6	1.00 H	281	32.6	-7.7
3	204.25	23.8 QP	43.5	-19.7	1.00 H	26	34.6	-10.8
4	517.67	31.8 QP	46.0	-14.2	1.00 H	272	33.0	-1.2
5	624.97	37.9 QP	46.0	-8.1	1.44 H	322	36.6	1.3
6	949.52	37.6 QP	46.0	-8.4	1.00 H	238	30.7	6.9

**ANTENNA POLARITY & TEST DISTANCE: VERTICAL AT 3 M**

NO.	FREQ. (MHz)	EMISSION LEVEL (dBuV/m)	LIMIT (dBuV/m)	MARGIN (dB)	ANTENNA HEIGHT (m)	TABLE ANGLE (Degree)	RAW VALUE (dBuV)	CORRECTION FACTOR (dB/m)
1	37.29	35.7 QP	40.0	-4.3	2.03 V	315	44.7	-9.0
2	93.91	29.9 QP	43.5	-13.6	1.41 V	53	43.3	-13.4
3	375.00	30.0 QP	46.0	-16.0	1.03 V	233	34.7	-4.7
4	624.97	37.7 QP	46.0	-8.3	1.00 V	190	36.4	1.3
5	875.09	36.7 QP	46.0	-9.3	1.05 V	293	31.5	5.2
6	1000.00	40.0 QP	54.0	-14.0	1.51 V	55	32.5	7.5

**REMARKS:**

1. Emission Level(dBuV/m) = Raw Value(dBuV) + Correction Factor(dB/m)
2. Correction Factor(dB/m) = Antenna Factor(dB/m) + Cable Factor(dB) – Pre-Amplifier Factor(dB)
3. The other emission levels were very low against the limit.
4. Margin value = Emission Level – Limit value

<b>CHANNEL</b>	TX Channel 157	<b>DETECTOR FUNCTION</b>	Quasi-Peak (QP)
<b>FREQUENCY RANGE</b>	9kHz ~ 1GHz		

**ANTENNA POLARITY & TEST DISTANCE: HORIZONTAL AT 3 M**

NO.	FREQ. (MHz)	EMISSION LEVEL (dBuV/m)	LIMIT (dBuV/m)	MARGIN (dB)	ANTENNA HEIGHT (m)	TABLE ANGLE (Degree)	RAW VALUE (dBuV)	CORRECTION FACTOR (dB/m)
1	48.51	29.3 QP	40.0	-10.7	1.98 H	109	37.8	-8.5
2	149.95	24.5 QP	43.5	-19.0	1.04 H	277	32.2	-7.7
3	204.65	23.7 QP	43.5	-19.8	1.01 H	68	34.5	-10.8
4	517.68	31.7 QP	46.0	-14.3	1.02 H	262	32.9	-1.2
5	624.93	37.9 QP	46.0	-8.1	1.44 H	297	36.6	1.3
6	949.78	37.6 QP	46.0	-8.4	1.00 H	226	30.7	6.9

**ANTENNA POLARITY & TEST DISTANCE: VERTICAL AT 3 M**

NO.	FREQ. (MHz)	EMISSION LEVEL (dBuV/m)	LIMIT (dBuV/m)	MARGIN (dB)	ANTENNA HEIGHT (m)	TABLE ANGLE (Degree)	RAW VALUE (dBuV)	CORRECTION FACTOR (dB/m)
1	37.00	35.6 QP	40.0	-4.4	1.93 V	285	44.7	-9.1
2	94.08	29.8 QP	43.5	-13.7	1.44 V	68	43.2	-13.4
3	374.99	30.4 QP	46.0	-15.6	1.00 V	235	35.1	-4.7
4	624.97	37.8 QP	46.0	-8.2	1.00 V	187	36.5	1.3
5	874.96	36.6 QP	46.0	-9.4	1.00 V	295	31.4	5.2
6	1000.00	39.8 QP	54.0	-14.2	1.51 V	68	32.3	7.5

**REMARKS:**

1. Emission Level(dBuV/m) = Raw Value(dBuV) + Correction Factor(dB/m)
2. Correction Factor(dB/m) = Antenna Factor(dB/m) + Cable Factor(dB) – Pre-Amplifier Factor(dB)
3. The other emission levels were very low against the limit.
4. Margin value = Emission Level – Limit value

<b>CHANNEL</b>	TX Channel 165	<b>DETECTOR FUNCTION</b>	Quasi-Peak (QP)
<b>FREQUENCY RANGE</b>	9kHz ~ 1GHz		

**ANTENNA POLARITY & TEST DISTANCE: HORIZONTAL AT 3 M**

NO.	FREQ. (MHz)	EMISSION LEVEL (dBuV/m)	LIMIT (dBuV/m)	MARGIN (dB)	ANTENNA HEIGHT (m)	TABLE ANGLE (Degree)	RAW VALUE (dBuV)	CORRECTION FACTOR (dB/m)
1	48.59	29.1 QP	40.0	-10.9	1.96 H	116	37.6	-8.5
2	150.23	24.8 QP	43.5	-18.7	1.00 H	282	32.5	-7.7
3	204.77	24.2 QP	43.5	-19.3	1.00 H	27	35.0	-10.8
4	518.01	31.2 QP	46.0	-14.8	1.00 H	292	32.4	-1.2
5	624.83	37.8 QP	46.0	-8.2	1.55 H	311	36.5	1.3
6	949.46	37.4 QP	46.0	-8.6	1.00 H	239	30.5	6.9

**ANTENNA POLARITY & TEST DISTANCE: VERTICAL AT 3 M**

NO.	FREQ. (MHz)	EMISSION LEVEL (dBuV/m)	LIMIT (dBuV/m)	MARGIN (dB)	ANTENNA HEIGHT (m)	TABLE ANGLE (Degree)	RAW VALUE (dBuV)	CORRECTION FACTOR (dB/m)
1	37.31	35.7 QP	40.0	-4.3	1.95 V	318	44.7	-9.0
2	93.71	30.0 QP	43.5	-13.5	1.45 V	59	43.4	-13.4
3	375.05	30.3 QP	46.0	-15.7	1.00 V	218	35.0	-4.7
4	625.07	37.6 QP	46.0	-8.4	1.00 V	172	36.3	1.3
5	875.03	36.7 QP	46.0	-9.3	1.00 V	299	31.5	5.2
6	1000.00	39.7 QP	54.0	-14.3	1.47 V	16	32.2	7.5

**REMARKS:**

1. Emission Level(dBuV/m) = Raw Value(dBuV) + Correction Factor(dB/m)
2. Correction Factor(dB/m) = Antenna Factor(dB/m) + Cable Factor(dB) – Pre-Amplifier Factor(dB)
3. The other emission levels were very low against the limit.
4. Margin value = Emission Level – Limit value

**802.11ac (VHT40)**

<b>CHANNEL</b>	TX Channel 38	<b>DETECTOR FUNCTION</b>	Quasi-Peak (QP)
<b>FREQUENCY RANGE</b>	9kHz ~ 1GHz		

**ANTENNA POLARITY & TEST DISTANCE: HORIZONTAL AT 3 M**

NO.	FREQ. (MHz)	EMISSION LEVEL (dBuV/m)	LIMIT (dBuV/m)	MARGIN (dB)	ANTENNA HEIGHT (m)	TABLE ANGLE (Degree)	RAW VALUE (dBuV)	CORRECTION FACTOR (dB/m)
1	48.41	29.1 QP	40.0	-10.9	1.99 H	112	37.6	-8.5
2	150.31	24.7 QP	43.5	-18.8	1.05 H	274	32.4	-7.7
3	204.61	24.0 QP	43.5	-19.5	1.00 H	52	34.8	-10.8
4	517.84	31.5 QP	46.0	-14.5	1.00 H	290	32.7	-1.2
5	625.03	37.9 QP	46.0	-8.1	1.45 H	327	36.6	1.3
6	949.37	37.4 QP	46.0	-8.6	1.00 H	255	30.5	6.9

**ANTENNA POLARITY & TEST DISTANCE: VERTICAL AT 3 M**

NO.	FREQ. (MHz)	EMISSION LEVEL (dBuV/m)	LIMIT (dBuV/m)	MARGIN (dB)	ANTENNA HEIGHT (m)	TABLE ANGLE (Degree)	RAW VALUE (dBuV)	CORRECTION FACTOR (dB/m)
1	37.46	35.8 QP	40.0	-4.2	1.98 V	308	44.8	-9.0
2	93.88	30.2 QP	43.5	-13.3	1.45 V	44	43.6	-13.4
3	374.97	30.4 QP	46.0	-15.6	1.00 V	251	35.1	-4.7
4	625.07	37.9 QP	46.0	-8.1	1.01 V	169	36.6	1.3
5	875.07	36.8 QP	46.0	-9.2	1.00 V	295	31.6	5.2
6	1000.00	39.6 QP	54.0	-14.4	1.46 V	71	32.1	7.5

**REMARKS:**

1. Emission Level(dBuV/m) = Raw Value(dBuV) + Correction Factor(dB/m)
2. Correction Factor(dB/m) = Antenna Factor(dB/m) + Cable Factor(dB) – Pre-Amplifier Factor(dB)
3. The other emission levels were very low against the limit.
4. Margin value = Emission Level – Limit value

<b>CHANNEL</b>	TX Channel 46	<b>DETECTOR FUNCTION</b>	Quasi-Peak (QP)
<b>FREQUENCY RANGE</b>	9kHz ~ 1GHz		

**ANTENNA POLARITY & TEST DISTANCE: HORIZONTAL AT 3 M**

NO.	FREQ. (MHz)	EMISSION LEVEL (dBuV/m)	LIMIT (dBuV/m)	MARGIN (dB)	ANTENNA HEIGHT (m)	TABLE ANGLE (Degree)	RAW VALUE (dBuV)	CORRECTION FACTOR (dB/m)
1	48.76	29.5 QP	40.0	-10.5	1.91 H	111	38.0	-8.5
2	149.82	24.5 QP	43.5	-19.0	1.04 H	281	32.2	-7.7
3	204.49	24.2 QP	43.5	-19.3	1.03 H	55	35.0	-10.8
4	517.66	31.6 QP	46.0	-14.4	1.00 H	284	32.8	-1.2
5	625.03	37.8 QP	46.0	-8.2	1.48 H	309	36.5	1.3
6	949.80	37.6 QP	46.0	-8.4	1.00 H	237	30.7	6.9

**ANTENNA POLARITY & TEST DISTANCE: VERTICAL AT 3 M**

NO.	FREQ. (MHz)	EMISSION LEVEL (dBuV/m)	LIMIT (dBuV/m)	MARGIN (dB)	ANTENNA HEIGHT (m)	TABLE ANGLE (Degree)	RAW VALUE (dBuV)	CORRECTION FACTOR (dB/m)
1	37.10	35.4 QP	40.0	-4.6	1.99 V	313	44.5	-9.1
2	94.03	30.4 QP	43.5	-13.1	1.44 V	47	43.8	-13.4
3	374.88	30.1 QP	46.0	-15.9	1.04 V	236	34.8	-4.7
4	625.06	38.0 QP	46.0	-8.0	1.00 V	176	36.7	1.3
5	874.96	36.7 QP	46.0	-9.3	1.00 V	308	31.5	5.2
6	1000.00	40.0 QP	54.0	-14.0	1.40 V	52	32.5	7.5

**REMARKS:**

1. Emission Level(dBuV/m) = Raw Value(dBuV) + Correction Factor(dB/m)
2. Correction Factor(dB/m) = Antenna Factor(dB/m) + Cable Factor(dB) – Pre-Amplifier Factor(dB)
3. The other emission levels were very low against the limit.
4. Margin value = Emission Level – Limit value

<b>CHANNEL</b>	TX Channel 151	<b>DETECTOR FUNCTION</b>	Quasi-Peak (QP)
<b>FREQUENCY RANGE</b>	9kHz ~ 1GHz		

**ANTENNA POLARITY & TEST DISTANCE: HORIZONTAL AT 3 M**

NO.	FREQ. (MHz)	EMISSION LEVEL (dBuV/m)	LIMIT (dBuV/m)	MARGIN (dB)	ANTENNA HEIGHT (m)	TABLE ANGLE (Degree)	RAW VALUE (dBuV)	CORRECTION FACTOR (dB/m)
1	49.21	29.3 QP	40.0	-10.7	1.94 H	101	37.8	-8.5
2	150.28	24.5 QP	43.5	-19.0	1.00 H	282	32.2	-7.7
3	204.39	24.2 QP	43.5	-19.3	1.00 H	47	35.0	-10.8
4	517.65	31.6 QP	46.0	-14.4	1.00 H	276	32.8	-1.2
5	624.84	38.2 QP	46.0	-7.8	1.51 H	302	36.9	1.3
6	949.46	37.6 QP	46.0	-8.4	1.00 H	229	30.7	6.9

**ANTENNA POLARITY & TEST DISTANCE: VERTICAL AT 3 M**

NO.	FREQ. (MHz)	EMISSION LEVEL (dBuV/m)	LIMIT (dBuV/m)	MARGIN (dB)	ANTENNA HEIGHT (m)	TABLE ANGLE (Degree)	RAW VALUE (dBuV)	CORRECTION FACTOR (dB/m)
1	37.29	35.9 QP	40.0	-4.1	2.02 V	318	44.9	-9.0
2	94.02	30.6 QP	43.5	-12.9	1.39 V	46	44.0	-13.4
3	374.93	30.6 QP	46.0	-15.4	1.00 V	243	35.3	-4.7
4	624.85	37.3 QP	46.0	-8.7	1.05 V	189	36.0	1.3
5	875.04	36.8 QP	46.0	-9.2	1.00 V	311	31.6	5.2
6	1000.00	39.7 QP	54.0	-14.3	1.49 V	17	32.2	7.5

**REMARKS:**

1. Emission Level(dBuV/m) = Raw Value(dBuV) + Correction Factor(dB/m)
2. Correction Factor(dB/m) = Antenna Factor(dB/m) + Cable Factor(dB) – Pre-Amplifier Factor(dB)
3. The other emission levels were very low against the limit.
4. Margin value = Emission Level – Limit value



<b>CHANNEL</b>	TX Channel 159	<b>DETECTOR FUNCTION</b>	Quasi-Peak (QP)
<b>FREQUENCY RANGE</b>	9kHz ~ 1GHz		

**ANTENNA POLARITY & TEST DISTANCE: HORIZONTAL AT 3 M**

NO.	FREQ. (MHz)	EMISSION LEVEL (dBuV/m)	LIMIT (dBuV/m)	MARGIN (dB)	ANTENNA HEIGHT (m)	TABLE ANGLE (Degree)	RAW VALUE (dBuV)	CORRECTION FACTOR (dB/m)
1	48.55	29.0 QP	40.0	-11.0	2.01 H	110	37.5	-8.5
2	149.75	24.7 QP	43.5	-18.8	1.01 H	268	32.4	-7.7
3	204.50	24.0 QP	43.5	-19.5	1.00 H	39	34.8	-10.8
4	517.48	31.1 QP	46.0	-14.9	1.00 H	274	32.3	-1.2
5	624.88	37.8 QP	46.0	-8.2	1.44 H	318	36.5	1.3
6	949.69	37.3 QP	46.0	-8.7	1.00 H	250	30.4	6.9

**ANTENNA POLARITY & TEST DISTANCE: VERTICAL AT 3 M**

NO.	FREQ. (MHz)	EMISSION LEVEL (dBuV/m)	LIMIT (dBuV/m)	MARGIN (dB)	ANTENNA HEIGHT (m)	TABLE ANGLE (Degree)	RAW VALUE (dBuV)	CORRECTION FACTOR (dB/m)
1	37.25	35.8 QP	40.0	-4.2	2.04 V	296	44.8	-9.0
2	93.83	30.5 QP	43.5	-13.0	1.51 V	48	43.9	-13.4
3	375.00	30.2 QP	46.0	-15.8	1.00 V	223	34.9	-4.7
4	625.01	38.2 QP	46.0	-7.8	1.00 V	197	36.9	1.3
5	874.92	37.0 QP	46.0	-9.0	1.00 V	311	31.8	5.2
6	1000.00	39.7 QP	54.0	-14.3	1.45 V	46	32.2	7.5

**REMARKS:**

1. Emission Level(dBuV/m) = Raw Value(dBuV) + Correction Factor(dB/m)
2. Correction Factor(dB/m) = Antenna Factor(dB/m) + Cable Factor(dB) – Pre-Amplifier Factor(dB)
3. The other emission levels were very low against the limit.
4. Margin value = Emission Level – Limit value

**802.11ac (VHT80)**

<b>CHANNEL</b>	TX Channel 42	<b>DETECTOR FUNCTION</b>	Quasi-Peak (QP)
<b>FREQUENCY RANGE</b>	9kHz ~ 1GHz		

**ANTENNA POLARITY & TEST DISTANCE: HORIZONTAL AT 3 M**

NO.	FREQ. (MHz)	EMISSION LEVEL (dBuV/m)	LIMIT (dBuV/m)	MARGIN (dB)	ANTENNA HEIGHT (m)	TABLE ANGLE (Degree)	RAW VALUE (dBuV)	CORRECTION FACTOR (dB/m)
1	48.93	29.0 QP	40.0	-11.0	1.99 H	105	37.5	-8.5
2	150.40	24.9 QP	43.5	-18.6	1.00 H	290	32.6	-7.7
3	204.59	24.1 QP	43.5	-19.4	1.00 H	47	34.9	-10.8
4	517.57	32.0 QP	46.0	-14.0	1.00 H	296	33.2	-1.2
5	625.00	38.0 QP	46.0	-8.0	1.45 H	316	36.7	1.3
6	949.37	37.1 QP	46.0	-8.9	1.00 H	235	30.2	6.9

**ANTENNA POLARITY & TEST DISTANCE: VERTICAL AT 3 M**

NO.	FREQ. (MHz)	EMISSION LEVEL (dBuV/m)	LIMIT (dBuV/m)	MARGIN (dB)	ANTENNA HEIGHT (m)	TABLE ANGLE (Degree)	RAW VALUE (dBuV)	CORRECTION FACTOR (dB/m)
1	37.52	36.2 QP	40.0	-3.8	2.05 V	306	45.2	-9.0
2	93.53	30.1 QP	43.5	-13.4	1.49 V	57	43.5	-13.4
3	374.98	29.8 QP	46.0	-16.2	1.00 V	230	34.5	-4.7
4	624.88	37.8 QP	46.0	-8.2	1.00 V	151	36.5	1.3
5	874.93	37.1 QP	46.0	-8.9	1.00 V	289	31.9	5.2
6	1000.00	40.0 QP	54.0	-14.0	1.49 V	71	32.5	7.5

**REMARKS:**

1. Emission Level(dBuV/m) = Raw Value(dBuV) + Correction Factor(dB/m)
2. Correction Factor(dB/m) = Antenna Factor(dB/m) + Cable Factor(dB) – Pre-Amplifier Factor(dB)
3. The other emission levels were very low against the limit.
4. Margin value = Emission Level – Limit value

<b>CHANNEL</b>	TX Channel 155	<b>DETECTOR FUNCTION</b>	Quasi-Peak (QP)
<b>FREQUENCY RANGE</b>	9kHz ~ 1GHz		

**ANTENNA POLARITY & TEST DISTANCE: HORIZONTAL AT 3 M**

NO.	FREQ. (MHz)	EMISSION LEVEL (dBuV/m)	LIMIT (dBuV/m)	MARGIN (dB)	ANTENNA HEIGHT (m)	TABLE ANGLE (Degree)	RAW VALUE (dBuV)	CORRECTION FACTOR (dB/m)
1	49.24	29.4 QP	40.0	-10.6	1.99 H	103	37.9	-8.5
2	149.94	24.7 QP	43.5	-18.8	1.01 H	298	32.4	-7.7
3	204.74	23.6 QP	43.5	-19.9	1.00 H	49	34.4	-10.8
4	517.27	31.7 QP	46.0	-14.3	1.00 H	265	32.9	-1.2
5	624.93	38.2 QP	46.0	-7.8	1.44 H	299	36.9	1.3
6	949.54	37.2 QP	46.0	-8.8	1.00 H	231	30.3	6.9

**ANTENNA POLARITY & TEST DISTANCE: VERTICAL AT 3 M**

NO.	FREQ. (MHz)	EMISSION LEVEL (dBuV/m)	LIMIT (dBuV/m)	MARGIN (dB)	ANTENNA HEIGHT (m)	TABLE ANGLE (Degree)	RAW VALUE (dBuV)	CORRECTION FACTOR (dB/m)
1	37.30	35.7 QP	40.0	-4.3	1.93 V	310	44.7	-9.0
2	93.53	30.2 QP	43.5	-13.3	1.51 V	59	43.6	-13.4
3	375.08	30.4 QP	46.0	-15.6	1.06 V	255	35.1	-4.7
4	625.02	37.4 QP	46.0	-8.6	1.00 V	195	36.1	1.3
5	874.98	36.4 QP	46.0	-9.6	1.05 V	274	31.2	5.2
6	1000.00	40.2 QP	54.0	-13.8	1.55 V	74	32.7	7.5

**REMARKS:**

1. Emission Level(dBuV/m) = Raw Value(dBuV) + Correction Factor(dB/m)
2. Correction Factor(dB/m) = Antenna Factor(dB/m) + Cable Factor(dB) – Pre-Amplifier Factor(dB)
3. The other emission levels were very low against the limit.
4. Margin value = Emission Level – Limit value

## 4.1.8 Test Results (Mode 2)

## Below 1GHz Data:

## 802.11a

<b>CHANNEL</b>	TX Channel 36	<b>DETECTOR FUNCTION</b>	Quasi-Peak (QP)
<b>FREQUENCY RANGE</b>	9kHz ~ 1GHz		

**ANTENNA POLARITY & TEST DISTANCE: HORIZONTAL AT 3 M**

NO.	FREQ. (MHz)	EMISSION LEVEL (dBuV/m)	LIMIT (dBuV/m)	MARGIN (dB)	ANTENNA HEIGHT (m)	TABLE ANGLE (Degree)	RAW VALUE (dBuV)	CORRECTION FACTOR (dB/m)
1	49.09	30.3 QP	40.0	-9.7	1.45 H	223	38.8	-8.5
2	150.12	26.3 QP	43.5	-17.2	1.02 H	156	34.0	-7.7
3	204.49	25.8 QP	43.5	-17.7	1.48 H	233	36.6	-10.8
4	517.66	32.3 QP	46.0	-13.7	1.45 H	228	33.5	-1.2
5	625.02	38.7 QP	46.0	-7.3	1.47 H	218	37.4	1.3
6	949.38	38.5 QP	46.0	-7.5	1.51 H	138	31.6	6.9

**ANTENNA POLARITY & TEST DISTANCE: VERTICAL AT 3 M**

NO.	FREQ. (MHz)	EMISSION LEVEL (dBuV/m)	LIMIT (dBuV/m)	MARGIN (dB)	ANTENNA HEIGHT (m)	TABLE ANGLE (Degree)	RAW VALUE (dBuV)	CORRECTION FACTOR (dB/m)
1	36.82	33.5 QP	40.0	-6.5	1.39 V	271	42.6	-9.1
2	93.64	33.3 QP	43.5	-10.2	1.06 V	232	46.7	-13.4
3	375.07	31.6 QP	46.0	-14.4	1.45 V	192	36.3	-4.7
4	517.58	29.8 QP	46.0	-16.2	1.50 V	296	31.0	-1.2
5	624.99	40.3 QP	46.0	-5.7	1.42 V	220	39.0	1.3
6	875.01	38.9 QP	46.0	-7.1	1.00 V	238	33.7	5.2

**REMARKS:**

1. Emission Level(dBuV/m) = Raw Value(dBuV) + Correction Factor(dB/m)
2. Correction Factor(dB/m) = Antenna Factor(dB/m) + Cable Factor(dB) – Pre-Amplifier Factor(dB)
3. The other emission levels were very low against the limit.
4. Margin value = Emission Level – Limit value

<b>CHANNEL</b>	TX Channel 40	<b>DETECTOR FUNCTION</b>	Quasi-Peak (QP)
<b>FREQUENCY RANGE</b>	9kHz ~ 1GHz		

**ANTENNA POLARITY & TEST DISTANCE: HORIZONTAL AT 3 M**

NO.	FREQ. (MHz)	EMISSION LEVEL (dBuV/m)	LIMIT (dBuV/m)	MARGIN (dB)	ANTENNA HEIGHT (m)	TABLE ANGLE (Degree)	RAW VALUE (dBuV)	CORRECTION FACTOR (dB/m)
1	48.82	30.2 QP	40.0	-9.8	1.49 H	224	38.7	-8.5
2	149.90	26.5 QP	43.5	-17.0	1.00 H	121	34.2	-7.7
3	204.24	25.5 QP	43.5	-18.0	1.46 H	211	36.3	-10.8
4	517.45	32.4 QP	46.0	-13.6	1.49 H	244	33.6	-1.2
5	624.95	38.8 QP	46.0	-7.2	1.44 H	222	37.5	1.3
6	949.43	38.3 QP	46.0	-7.7	1.43 H	118	31.4	6.9

**ANTENNA POLARITY & TEST DISTANCE: VERTICAL AT 3 M**

NO.	FREQ. (MHz)	EMISSION LEVEL (dBuV/m)	LIMIT (dBuV/m)	MARGIN (dB)	ANTENNA HEIGHT (m)	TABLE ANGLE (Degree)	RAW VALUE (dBuV)	CORRECTION FACTOR (dB/m)
1	36.75	33.2 QP	40.0	-6.8	1.44 V	250	42.3	-9.1
2	93.57	33.7 QP	43.5	-9.8	1.00 V	266	47.1	-13.4
3	374.93	32.5 QP	46.0	-13.5	1.41 V	198	37.2	-4.7
4	517.37	30.2 QP	46.0	-15.8	1.48 V	316	31.4	-1.2
5	624.88	39.7 QP	46.0	-6.3	1.37 V	243	38.4	1.3
6	874.84	39.2 QP	46.0	-6.8	1.00 V	270	34.0	5.2

**REMARKS:**

1. Emission Level(dBuV/m) = Raw Value(dBuV) + Correction Factor(dB/m)
2. Correction Factor(dB/m) = Antenna Factor(dB/m) + Cable Factor(dB) – Pre-Amplifier Factor(dB)
3. The other emission levels were very low against the limit.
4. Margin value = Emission Level – Limit value

<b>CHANNEL</b>	TX Channel 48	<b>DETECTOR FUNCTION</b>	Quasi-Peak (QP)
<b>FREQUENCY RANGE</b>	9kHz ~ 1GHz		

**ANTENNA POLARITY & TEST DISTANCE: HORIZONTAL AT 3 M**

NO.	FREQ. (MHz)	EMISSION LEVEL (dBuV/m)	LIMIT (dBuV/m)	MARGIN (dB)	ANTENNA HEIGHT (m)	TABLE ANGLE (Degree)	RAW VALUE (dBuV)	CORRECTION FACTOR (dB/m)
1	48.93	30.1 QP	40.0	-9.9	1.42 H	214	38.6	-8.5
2	150.18	26.5 QP	43.5	-17.0	1.00 H	119	34.2	-7.7
3	204.97	25.8 QP	43.5	-17.7	1.45 H	219	36.6	-10.8
4	517.54	32.8 QP	46.0	-13.2	1.54 H	208	34.0	-1.2
5	625.01	39.2 QP	46.0	-6.8	1.48 H	210	37.9	1.3
6	949.40	38.6 QP	46.0	-7.4	1.46 H	124	31.7	6.9

**ANTENNA POLARITY & TEST DISTANCE: VERTICAL AT 3 M**

NO.	FREQ. (MHz)	EMISSION LEVEL (dBuV/m)	LIMIT (dBuV/m)	MARGIN (dB)	ANTENNA HEIGHT (m)	TABLE ANGLE (Degree)	RAW VALUE (dBuV)	CORRECTION FACTOR (dB/m)
1	37.06	33.5 QP	40.0	-6.5	1.52 V	257	42.6	-9.1
2	93.74	33.5 QP	43.5	-10.0	1.04 V	239	46.9	-13.4
3	375.01	32.0 QP	46.0	-14.0	1.45 V	212	36.7	-4.7
4	517.34	29.7 QP	46.0	-16.3	1.47 V	298	30.9	-1.2
5	624.91	40.1 QP	46.0	-5.9	1.25 V	214	38.8	1.3
6	874.87	38.5 QP	46.0	-7.5	1.03 V	263	33.3	5.2

**REMARKS:**

1. Emission Level(dBuV/m) = Raw Value(dBuV) + Correction Factor(dB/m)
2. Correction Factor(dB/m) = Antenna Factor(dB/m) + Cable Factor(dB) – Pre-Amplifier Factor(dB)
3. The other emission levels were very low against the limit.
4. Margin value = Emission Level – Limit value

<b>CHANNEL</b>	TX Channel 149	<b>DETECTOR FUNCTION</b>	Quasi-Peak (QP)
<b>FREQUENCY RANGE</b>	9kHz ~ 1GHz		

**ANTENNA POLARITY & TEST DISTANCE: HORIZONTAL AT 3 M**

NO.	FREQ. (MHz)	EMISSION LEVEL (dBuV/m)	LIMIT (dBuV/m)	MARGIN (dB)	ANTENNA HEIGHT (m)	TABLE ANGLE (Degree)	RAW VALUE (dBuV)	CORRECTION FACTOR (dB/m)
1	49.01	30.2 QP	40.0	-9.8	1.49 H	213	38.7	-8.5
2	150.27	26.5 QP	43.5	-17.0	1.05 H	119	34.2	-7.7
3	204.94	25.8 QP	43.5	-17.7	1.47 H	213	36.6	-10.8
4	517.66	32.4 QP	46.0	-13.6	1.49 H	208	33.6	-1.2
5	625.02	39.2 QP	46.0	-6.8	1.43 H	234	37.9	1.3
6	949.61	38.5 QP	46.0	-7.5	1.48 H	120	31.6	6.9

**ANTENNA POLARITY & TEST DISTANCE: VERTICAL AT 3 M**

NO.	FREQ. (MHz)	EMISSION LEVEL (dBuV/m)	LIMIT (dBuV/m)	MARGIN (dB)	ANTENNA HEIGHT (m)	TABLE ANGLE (Degree)	RAW VALUE (dBuV)	CORRECTION FACTOR (dB/m)
1	37.04	33.7 QP	40.0	-6.3	1.55 V	260	42.8	-9.1
2	93.65	33.0 QP	43.5	-10.5	1.00 V	261	46.4	-13.4
3	374.88	32.3 QP	46.0	-13.7	1.47 V	236	37.0	-4.7
4	517.24	29.9 QP	46.0	-16.1	1.55 V	305	31.1	-1.2
5	625.03	40.1 QP	46.0	-5.9	1.40 V	217	38.8	1.3
6	874.99	39.0 QP	46.0	-7.0	1.05 V	273	33.8	5.2

**REMARKS:**

1. Emission Level(dBuV/m) = Raw Value(dBuV) + Correction Factor(dB/m)
2. Correction Factor(dB/m) = Antenna Factor(dB/m) + Cable Factor(dB) – Pre-Amplifier Factor(dB)
3. The other emission levels were very low against the limit.
4. Margin value = Emission Level – Limit value

<b>CHANNEL</b>	TX Channel 157	<b>DETECTOR FUNCTION</b>	Quasi-Peak (QP)
<b>FREQUENCY RANGE</b>	9kHz ~ 1GHz		

**ANTENNA POLARITY & TEST DISTANCE: HORIZONTAL AT 3 M**

NO.	FREQ. (MHz)	EMISSION LEVEL (dBuV/m)	LIMIT (dBuV/m)	MARGIN (dB)	ANTENNA HEIGHT (m)	TABLE ANGLE (Degree)	RAW VALUE (dBuV)	CORRECTION FACTOR (dB/m)
1	48.68	30.8 QP	40.0	-9.2	1.54 H	223	39.3	-8.5
2	150.11	26.5 QP	43.5	-17.0	1.00 H	134	34.2	-7.7
3	204.51	26.1 QP	43.5	-17.4	1.49 H	223	36.9	-10.8
4	517.37	32.8 QP	46.0	-13.2	1.50 H	245	34.0	-1.2
5	624.86	39.3 QP	46.0	-6.7	1.53 H	219	38.0	1.3
6	949.63	38.6 QP	46.0	-7.4	1.46 H	146	31.7	6.9

**ANTENNA POLARITY & TEST DISTANCE: VERTICAL AT 3 M**

NO.	FREQ. (MHz)	EMISSION LEVEL (dBuV/m)	LIMIT (dBuV/m)	MARGIN (dB)	ANTENNA HEIGHT (m)	TABLE ANGLE (Degree)	RAW VALUE (dBuV)	CORRECTION FACTOR (dB/m)
1	37.11	33.3 QP	40.0	-6.7	1.40 V	275	42.4	-9.1
2	93.61	33.0 QP	43.5	-10.5	1.00 V	265	46.4	-13.4
3	375.06	32.1 QP	46.0	-13.9	1.55 V	238	36.8	-4.7
4	517.23	29.4 QP	46.0	-16.6	1.54 V	300	30.6	-1.2
5	625.04	40.0 QP	46.0	-6.0	1.31 V	242	38.7	1.3
6	875.02	38.8 QP	46.0	-7.2	1.00 V	237	33.6	5.2

**REMARKS:**

1. Emission Level(dBuV/m) = Raw Value(dBuV) + Correction Factor(dB/m)
2. Correction Factor(dB/m) = Antenna Factor(dB/m) + Cable Factor(dB) – Pre-Amplifier Factor(dB)
3. The other emission levels were very low against the limit.
4. Margin value = Emission Level – Limit value



<b>CHANNEL</b>	TX Channel 165	<b>DETECTOR FUNCTION</b>	Quasi-Peak (QP)
<b>FREQUENCY RANGE</b>	9kHz ~ 1GHz		

**ANTENNA POLARITY & TEST DISTANCE: HORIZONTAL AT 3 M**

NO.	FREQ. (MHz)	EMISSION LEVEL (dBuV/m)	LIMIT (dBuV/m)	MARGIN (dB)	ANTENNA HEIGHT (m)	TABLE ANGLE (Degree)	RAW VALUE (dBuV)	CORRECTION FACTOR (dB/m)
1	48.44	30.5 QP	40.0	-9.5	1.42 H	233	39.0	-8.5
2	150.42	26.6 QP	43.5	-16.9	1.00 H	134	34.3	-7.7
3	204.59	25.9 QP	43.5	-17.6	1.46 H	232	36.7	-10.8
4	517.93	32.4 QP	46.0	-13.6	1.50 H	239	33.6	-1.2
5	624.91	39.0 QP	46.0	-7.0	1.54 H	235	37.7	1.3
6	949.42	38.6 QP	46.0	-7.4	1.48 H	106	31.7	6.9

**ANTENNA POLARITY & TEST DISTANCE: VERTICAL AT 3 M**

NO.	FREQ. (MHz)	EMISSION LEVEL (dBuV/m)	LIMIT (dBuV/m)	MARGIN (dB)	ANTENNA HEIGHT (m)	TABLE ANGLE (Degree)	RAW VALUE (dBuV)	CORRECTION FACTOR (dB/m)
1	37.02	33.9 QP	40.0	-6.1	1.48 V	267	43.0	-9.1
2	93.50	33.2 QP	43.5	-10.3	1.02 V	271	46.6	-13.4
3	374.93	32.3 QP	46.0	-13.7	1.54 V	224	37.0	-4.7
4	517.28	29.9 QP	46.0	-16.1	1.45 V	308	31.1	-1.2
5	625.06	39.9 QP	46.0	-6.1	1.41 V	231	38.6	1.3
6	874.84	39.1 QP	46.0	-6.9	1.05 V	260	33.9	5.2

**REMARKS:**

1. Emission Level(dBuV/m) = Raw Value(dBuV) + Correction Factor(dB/m)
2. Correction Factor(dB/m) = Antenna Factor(dB/m) + Cable Factor(dB) – Pre-Amplifier Factor(dB)
3. The other emission levels were very low against the limit.
4. Margin value = Emission Level – Limit value

802.11ac (VHT20)

<b>CHANNEL</b>	TX Channel 36	<b>DETECTOR FUNCTION</b>	Quasi-Peak (QP)
<b>FREQUENCY RANGE</b>	9kHz ~ 1GHz		

ANTENNA POLARITY & TEST DISTANCE: HORIZONTAL AT 3 M								
NO.	FREQ. (MHz)	EMISSION LEVEL (dBuV/m)	LIMIT (dBuV/m)	MARGIN (dB)	ANTENNA HEIGHT (m)	TABLE ANGLE (Degree)	RAW VALUE (dBuV)	CORRECTION FACTOR (dB/m)
1	48.67	30.7 QP	40.0	-9.3	1.46 H	203	39.2	-8.5
2	150.24	26.7 QP	43.5	-16.8	1.00 H	137	34.4	-7.7
3	204.63	26.0 QP	43.5	-17.5	1.45 H	207	36.8	-10.8
4	517.92	32.5 QP	46.0	-13.5	1.50 H	245	33.7	-1.2
5	625.00	39.4 QP	46.0	-6.6	1.46 H	225	38.1	1.3
6	949.48	38.2 QP	46.0	-7.8	1.51 H	119	31.3	6.9

ANTENNA POLARITY & TEST DISTANCE: VERTICAL AT 3 M								
NO.	FREQ. (MHz)	EMISSION LEVEL (dBuV/m)	LIMIT (dBuV/m)	MARGIN (dB)	ANTENNA HEIGHT (m)	TABLE ANGLE (Degree)	RAW VALUE (dBuV)	CORRECTION FACTOR (dB/m)
1	37.33	33.4 QP	40.0	-6.6	1.51 V	268	42.4	-9.0
2	93.90	33.4 QP	43.5	-10.1	1.05 V	252	46.8	-13.4
3	374.88	32.1 QP	46.0	-13.9	1.47 V	218	36.8	-4.7
4	517.32	29.9 QP	46.0	-16.1	1.53 V	285	31.1	-1.2
5	624.89	40.3 QP	46.0	-5.7	1.37 V	225	39.0	1.3
6	874.92	38.7 QP	46.0	-7.3	1.00 V	274	33.5	5.2

**REMARKS:**

1. Emission Level(dBuV/m) = Raw Value(dBuV) + Correction Factor(dB/m)
2. Correction Factor(dB/m) = Antenna Factor(dB/m) + Cable Factor(dB) – Pre-Amplifier Factor(dB)
3. The other emission levels were very low against the limit.
4. Margin value = Emission Level – Limit value

<b>CHANNEL</b>	TX Channel 40	<b>DETECTOR FUNCTION</b>	Quasi-Peak (QP)
<b>FREQUENCY RANGE</b>	9kHz ~ 1GHz		

**ANTENNA POLARITY & TEST DISTANCE: HORIZONTAL AT 3 M**

NO.	FREQ. (MHz)	EMISSION LEVEL (dBuV/m)	LIMIT (dBuV/m)	MARGIN (dB)	ANTENNA HEIGHT (m)	TABLE ANGLE (Degree)	RAW VALUE (dBuV)	CORRECTION FACTOR (dB/m)
1	48.90	30.8 QP	40.0	-9.2	1.51 H	232	39.3	-8.5
2	150.11	26.7 QP	43.5	-16.8	1.02 H	150	34.4	-7.7
3	204.66	26.1 QP	43.5	-17.4	1.48 H	231	36.9	-10.8
4	517.25	32.8 QP	46.0	-13.2	1.50 H	242	34.0	-1.2
5	625.00	39.0 QP	46.0	-7.0	1.46 H	214	37.7	1.3
6	949.50	38.5 QP	46.0	-7.5	1.41 H	119	31.6	6.9

**ANTENNA POLARITY & TEST DISTANCE: VERTICAL AT 3 M**

NO.	FREQ. (MHz)	EMISSION LEVEL (dBuV/m)	LIMIT (dBuV/m)	MARGIN (dB)	ANTENNA HEIGHT (m)	TABLE ANGLE (Degree)	RAW VALUE (dBuV)	CORRECTION FACTOR (dB/m)
1	36.58	33.4 QP	40.0	-6.6	1.47 V	267	42.5	-9.1
2	93.55	33.3 QP	43.5	-10.2	1.00 V	260	46.7	-13.4
3	374.91	32.2 QP	46.0	-13.8	1.53 V	242	36.9	-4.7
4	517.38	29.9 QP	46.0	-16.1	1.53 V	295	31.1	-1.2
5	624.88	40.4 QP	46.0	-5.6	1.37 V	214	39.1	1.3
6	874.86	38.9 QP	46.0	-7.1	1.04 V	277	33.7	5.2

**REMARKS:**

1. Emission Level(dBuV/m) = Raw Value(dBuV) + Correction Factor(dB/m)
2. Correction Factor(dB/m) = Antenna Factor(dB/m) + Cable Factor(dB) – Pre-Amplifier Factor(dB)
3. The other emission levels were very low against the limit.
4. Margin value = Emission Level – Limit value

<b>CHANNEL</b>	TX Channel 48	<b>DETECTOR FUNCTION</b>	Quasi-Peak (QP)
<b>FREQUENCY RANGE</b>	9kHz ~ 1GHz		

**ANTENNA POLARITY & TEST DISTANCE: HORIZONTAL AT 3 M**

NO.	FREQ. (MHz)	EMISSION LEVEL (dBuV/m)	LIMIT (dBuV/m)	MARGIN (dB)	ANTENNA HEIGHT (m)	TABLE ANGLE (Degree)	RAW VALUE (dBuV)	CORRECTION FACTOR (dB/m)
1	48.72	30.6 QP	40.0	-9.4	1.46 H	230	39.1	-8.5
2	150.12	26.1 QP	43.5	-17.4	1.04 H	158	33.8	-7.7
3	204.62	25.5 QP	43.5	-18.0	1.46 H	213	36.3	-10.8
4	517.46	32.1 QP	46.0	-13.9	1.50 H	234	33.3	-1.2
5	624.92	39.0 QP	46.0	-7.0	1.42 H	230	37.7	1.3
6	949.56	38.5 QP	46.0	-7.5	1.52 H	114	31.6	6.9

**ANTENNA POLARITY & TEST DISTANCE: VERTICAL AT 3 M**

NO.	FREQ. (MHz)	EMISSION LEVEL (dBuV/m)	LIMIT (dBuV/m)	MARGIN (dB)	ANTENNA HEIGHT (m)	TABLE ANGLE (Degree)	RAW VALUE (dBuV)	CORRECTION FACTOR (dB/m)
1	37.27	32.9 QP	40.0	-7.1	1.36 V	252	41.9	-9.0
2	93.97	33.1 QP	43.5	-10.4	1.00 V	266	46.5	-13.4
3	374.96	32.2 QP	46.0	-13.8	1.37 V	242	36.9	-4.7
4	517.29	29.5 QP	46.0	-16.5	1.42 V	290	30.7	-1.2
5	625.00	40.1 QP	46.0	-5.9	1.26 V	212	38.8	1.3
6	875.06	38.7 QP	46.0	-7.3	1.03 V	267	33.5	5.2

**REMARKS:**

1. Emission Level(dBuV/m) = Raw Value(dBuV) + Correction Factor(dB/m)
2. Correction Factor(dB/m) = Antenna Factor(dB/m) + Cable Factor(dB) – Pre-Amplifier Factor(dB)
3. The other emission levels were very low against the limit.
4. Margin value = Emission Level – Limit value

<b>CHANNEL</b>	TX Channel 149	<b>DETECTOR FUNCTION</b>	Quasi-Peak (QP)
<b>FREQUENCY RANGE</b>	9kHz ~ 1GHz		

**ANTENNA POLARITY & TEST DISTANCE: HORIZONTAL AT 3 M**

NO.	FREQ. (MHz)	EMISSION LEVEL (dBuV/m)	LIMIT (dBuV/m)	MARGIN (dB)	ANTENNA HEIGHT (m)	TABLE ANGLE (Degree)	RAW VALUE (dBuV)	CORRECTION FACTOR (dB/m)
1	48.74	30.3 QP	40.0	-9.7	1.49 H	216	38.8	-8.5
2	149.92	26.0 QP	43.5	-17.5	1.00 H	136	33.7	-7.7
3	204.46	25.8 QP	43.5	-17.7	1.52 H	221	36.6	-10.8
4	517.12	32.7 QP	46.0	-13.3	1.48 H	227	33.9	-1.2
5	625.01	39.5 QP	46.0	-6.5	1.53 H	205	38.2	1.3
6	949.30	38.5 QP	46.0	-7.5	1.47 H	108	31.6	6.9

**ANTENNA POLARITY & TEST DISTANCE: VERTICAL AT 3 M**

NO.	FREQ. (MHz)	EMISSION LEVEL (dBuV/m)	LIMIT (dBuV/m)	MARGIN (dB)	ANTENNA HEIGHT (m)	TABLE ANGLE (Degree)	RAW VALUE (dBuV)	CORRECTION FACTOR (dB/m)
1	37.23	32.8 QP	40.0	-7.2	1.45 V	280	41.8	-9.0
2	93.55	33.2 QP	43.5	-10.3	1.00 V	251	46.6	-13.4
3	375.07	32.0 QP	46.0	-14.0	1.50 V	221	36.7	-4.7
4	517.76	30.2 QP	46.0	-15.8	1.45 V	317	31.4	-1.2
5	624.94	40.4 QP	46.0	-5.6	1.24 V	230	39.1	1.3
6	875.00	38.7 QP	46.0	-7.3	1.00 V	258	33.5	5.2

**REMARKS:**

1. Emission Level(dBuV/m) = Raw Value(dBuV) + Correction Factor(dB/m)
2. Correction Factor(dB/m) = Antenna Factor(dB/m) + Cable Factor(dB) – Pre-Amplifier Factor(dB)
3. The other emission levels were very low against the limit.
4. Margin value = Emission Level – Limit value

<b>CHANNEL</b>	TX Channel 157	<b>DETECTOR FUNCTION</b>	Quasi-Peak (QP)
<b>FREQUENCY RANGE</b>	9kHz ~ 1GHz		

**ANTENNA POLARITY & TEST DISTANCE: HORIZONTAL AT 3 M**

NO.	FREQ. (MHz)	EMISSION LEVEL (dBuV/m)	LIMIT (dBuV/m)	MARGIN (dB)	ANTENNA HEIGHT (m)	TABLE ANGLE (Degree)	RAW VALUE (dBuV)	CORRECTION FACTOR (dB/m)
1	48.46	30.2 QP	40.0	-9.8	1.50 H	217	38.7	-8.5
2	150.10	26.9 QP	43.5	-16.6	1.05 H	137	34.6	-7.7
3	204.73	25.9 QP	43.5	-17.6	1.43 H	199	36.7	-10.8
4	517.16	32.2 QP	46.0	-13.8	1.35 H	227	33.4	-1.2
5	624.90	39.1 QP	46.0	-6.9	1.44 H	216	37.8	1.3
6	949.87	38.4 QP	46.0	-7.6	1.55 H	142	31.5	6.9

**ANTENNA POLARITY & TEST DISTANCE: VERTICAL AT 3 M**

NO.	FREQ. (MHz)	EMISSION LEVEL (dBuV/m)	LIMIT (dBuV/m)	MARGIN (dB)	ANTENNA HEIGHT (m)	TABLE ANGLE (Degree)	RAW VALUE (dBuV)	CORRECTION FACTOR (dB/m)
1	37.25	33.8 QP	40.0	-6.2	1.45 V	249	42.8	-9.0
2	93.35	33.7 QP	43.5	-9.8	1.00 V	257	47.1	-13.4
3	375.01	31.6 QP	46.0	-14.4	1.46 V	216	36.3	-4.7
4	517.15	29.9 QP	46.0	-16.1	1.44 V	276	31.1	-1.2
<b>5</b>	<b>624.93</b>	<b>40.5 QP</b>	<b>46.0</b>	<b>-5.5</b>	<b>1.36 V</b>	<b>213</b>	<b>39.2</b>	<b>1.3</b>
6	875.03	38.8 QP	46.0	-7.2	1.06 V	252	33.6	5.2

**REMARKS:**

1. Emission Level(dBuV/m) = Raw Value(dBuV) + Correction Factor(dB/m)
2. Correction Factor(dB/m) = Antenna Factor(dB/m) + Cable Factor(dB) – Pre-Amplifier Factor(dB)
3. The other emission levels were very low against the limit.
4. Margin value = Emission Level – Limit value

<b>CHANNEL</b>	TX Channel 165	<b>DETECTOR FUNCTION</b>	Quasi-Peak (QP)
<b>FREQUENCY RANGE</b>	9kHz ~ 1GHz		

**ANTENNA POLARITY & TEST DISTANCE: HORIZONTAL AT 3 M**

NO.	FREQ. (MHz)	EMISSION LEVEL (dBuV/m)	LIMIT (dBuV/m)	MARGIN (dB)	ANTENNA HEIGHT (m)	TABLE ANGLE (Degree)	RAW VALUE (dBuV)	CORRECTION FACTOR (dB/m)
1	48.99	30.3 QP	40.0	-9.7	1.51 H	224	38.8	-8.5
2	150.44	26.6 QP	43.5	-16.9	1.01 H	127	34.3	-7.7
3	204.54	25.8 QP	43.5	-17.7	1.43 H	212	36.6	-10.8
4	517.98	32.2 QP	46.0	-13.8	1.53 H	233	33.4	-1.2
5	624.91	39.0 QP	46.0	-7.0	1.45 H	234	37.7	1.3
6	949.40	38.3 QP	46.0	-7.7	1.52 H	135	31.4	6.9

**ANTENNA POLARITY & TEST DISTANCE: VERTICAL AT 3 M**

NO.	FREQ. (MHz)	EMISSION LEVEL (dBuV/m)	LIMIT (dBuV/m)	MARGIN (dB)	ANTENNA HEIGHT (m)	TABLE ANGLE (Degree)	RAW VALUE (dBuV)	CORRECTION FACTOR (dB/m)
1	36.85	33.9 QP	40.0	-6.1	1.54 V	246	43.0	-9.1
2	93.38	33.4 QP	43.5	-10.1	1.00 V	277	46.8	-13.4
3	374.97	32.2 QP	46.0	-13.8	1.53 V	226	36.9	-4.7
4	517.33	29.8 QP	46.0	-16.2	1.45 V	284	31.0	-1.2
5	624.93	40.0 QP	46.0	-6.0	1.27 V	212	38.7	1.3
6	874.99	38.9 QP	46.0	-7.1	1.00 V	240	33.7	5.2

**REMARKS:**

1. Emission Level(dBuV/m) = Raw Value(dBuV) + Correction Factor(dB/m)
2. Correction Factor(dB/m) = Antenna Factor(dB/m) + Cable Factor(dB) – Pre-Amplifier Factor(dB)
3. The other emission levels were very low against the limit.
4. Margin value = Emission Level – Limit value

**802.11ac (VHT40)**

<b>CHANNEL</b>	TX Channel 38	<b>DETECTOR FUNCTION</b>	Quasi-Peak (QP)
<b>FREQUENCY RANGE</b>	9kHz ~ 1GHz		

**ANTENNA POLARITY & TEST DISTANCE: HORIZONTAL AT 3 M**

NO.	FREQ. (MHz)	EMISSION LEVEL (dBuV/m)	LIMIT (dBuV/m)	MARGIN (dB)	ANTENNA HEIGHT (m)	TABLE ANGLE (Degree)	RAW VALUE (dBuV)	CORRECTION FACTOR (dB/m)
1	48.48	30.5 QP	40.0	-9.5	1.52 H	226	39.0	-8.5
2	150.23	26.6 QP	43.5	-16.9	1.00 H	130	34.3	-7.7
3	204.66	25.9 QP	43.5	-17.6	1.53 H	214	36.7	-10.8
4	517.45	32.3 QP	46.0	-13.7	1.55 H	243	33.5	-1.2
5	624.93	38.8 QP	46.0	-7.2	1.48 H	193	37.5	1.3
6	949.77	38.2 QP	46.0	-7.8	1.39 H	122	31.3	6.9

**ANTENNA POLARITY & TEST DISTANCE: VERTICAL AT 3 M**

NO.	FREQ. (MHz)	EMISSION LEVEL (dBuV/m)	LIMIT (dBuV/m)	MARGIN (dB)	ANTENNA HEIGHT (m)	TABLE ANGLE (Degree)	RAW VALUE (dBuV)	CORRECTION FACTOR (dB/m)
1	36.87	33.7 QP	40.0	-6.3	1.53 V	262	42.8	-9.1
2	93.65	33.5 QP	43.5	-10.0	1.01 V	247	46.9	-13.4
3	374.94	32.2 QP	46.0	-13.8	1.55 V	211	36.9	-4.7
4	517.16	29.7 QP	46.0	-16.3	1.48 V	315	30.9	-1.2
5	624.91	40.2 QP	46.0	-5.8	1.26 V	229	38.9	1.3
6	874.98	38.5 QP	46.0	-7.5	1.00 V	274	33.3	5.2

**REMARKS:**

1. Emission Level(dBuV/m) = Raw Value(dBuV) + Correction Factor(dB/m)
2. Correction Factor(dB/m) = Antenna Factor(dB/m) + Cable Factor(dB) – Pre-Amplifier Factor(dB)
3. The other emission levels were very low against the limit.
4. Margin value = Emission Level – Limit value



<b>CHANNEL</b>	TX Channel 46	<b>DETECTOR FUNCTION</b>	Quasi-Peak (QP)
<b>FREQUENCY RANGE</b>	9kHz ~ 1GHz		

**ANTENNA POLARITY & TEST DISTANCE: HORIZONTAL AT 3 M**

NO.	FREQ. (MHz)	EMISSION LEVEL (dBuV/m)	LIMIT (dBuV/m)	MARGIN (dB)	ANTENNA HEIGHT (m)	TABLE ANGLE (Degree)	RAW VALUE (dBuV)	CORRECTION FACTOR (dB/m)
1	49.13	30.3 QP	40.0	-9.7	1.52 H	221	38.8	-8.5
2	149.94	26.3 QP	43.5	-17.2	1.00 H	114	34.0	-7.7
3	204.46	25.8 QP	43.5	-17.7	1.44 H	236	36.6	-10.8
4	517.93	32.2 QP	46.0	-13.8	1.51 H	246	33.4	-1.2
5	625.05	39.3 QP	46.0	-6.7	1.51 H	233	38.0	1.3
6	949.48	38.0 QP	46.0	-8.0	1.37 H	128	31.1	6.9

**ANTENNA POLARITY & TEST DISTANCE: VERTICAL AT 3 M**

NO.	FREQ. (MHz)	EMISSION LEVEL (dBuV/m)	LIMIT (dBuV/m)	MARGIN (dB)	ANTENNA HEIGHT (m)	TABLE ANGLE (Degree)	RAW VALUE (dBuV)	CORRECTION FACTOR (dB/m)
1	36.91	33.6 QP	40.0	-6.4	1.47 V	255	42.7	-9.1
2	93.64	33.6 QP	43.5	-9.9	1.01 V	279	47.0	-13.4
3	374.95	32.0 QP	46.0	-14.0	1.51 V	230	36.7	-4.7
4	517.70	30.2 QP	46.0	-15.8	1.54 V	281	31.4	-1.2
5	624.92	40.5 QP	46.0	-5.5	1.31 V	235	39.2	1.3
6	874.91	39.1 QP	46.0	-6.9	1.00 V	278	33.9	5.2

**REMARKS:**

1. Emission Level(dBuV/m) = Raw Value(dBuV) + Correction Factor(dB/m)
2. Correction Factor(dB/m) = Antenna Factor(dB/m) + Cable Factor(dB) – Pre-Amplifier Factor(dB)
3. The other emission levels were very low against the limit.
4. Margin value = Emission Level – Limit value

<b>CHANNEL</b>	TX Channel 151	<b>DETECTOR FUNCTION</b>	Quasi-Peak (QP)
<b>FREQUENCY RANGE</b>	9kHz ~ 1GHz		

**ANTENNA POLARITY & TEST DISTANCE: HORIZONTAL AT 3 M**

NO.	FREQ. (MHz)	EMISSION LEVEL (dBuV/m)	LIMIT (dBuV/m)	MARGIN (dB)	ANTENNA HEIGHT (m)	TABLE ANGLE (Degree)	RAW VALUE (dBuV)	CORRECTION FACTOR (dB/m)
1	48.85	30.1 QP	40.0	-9.9	1.44 H	201	38.6	-8.5
2	150.14	26.4 QP	43.5	-17.1	1.02 H	145	34.1	-7.7
3	204.76	26.1 QP	43.5	-17.4	1.44 H	233	36.9	-10.8
4	517.69	32.8 QP	46.0	-13.2	1.45 H	235	34.0	-1.2
5	625.08	39.0 QP	46.0	-7.0	1.45 H	235	37.7	1.3
6	949.31	38.3 QP	46.0	-7.7	1.49 H	134	31.4	6.9

**ANTENNA POLARITY & TEST DISTANCE: VERTICAL AT 3 M**

NO.	FREQ. (MHz)	EMISSION LEVEL (dBuV/m)	LIMIT (dBuV/m)	MARGIN (dB)	ANTENNA HEIGHT (m)	TABLE ANGLE (Degree)	RAW VALUE (dBuV)	CORRECTION FACTOR (dB/m)
1	37.22	33.2 QP	40.0	-6.8	1.42 V	264	42.2	-9.0
2	93.66	32.7 QP	43.5	-10.8	1.01 V	254	46.1	-13.4
3	374.91	32.2 QP	46.0	-13.8	1.45 V	205	36.9	-4.7
4	517.63	29.7 QP	46.0	-16.3	1.39 V	299	30.9	-1.2
5	624.94	40.3 QP	46.0	-5.7	1.38 V	224	39.0	1.3
6	874.74	38.8 QP	46.0	-7.2	1.05 V	274	33.6	5.2

**REMARKS:**

1. Emission Level(dBuV/m) = Raw Value(dBuV) + Correction Factor(dB/m)
2. Correction Factor(dB/m) = Antenna Factor(dB/m) + Cable Factor(dB) – Pre-Amplifier Factor(dB)
3. The other emission levels were very low against the limit.
4. Margin value = Emission Level – Limit value

<b>CHANNEL</b>	TX Channel 159	<b>DETECTOR FUNCTION</b>	Quasi-Peak (QP)
<b>FREQUENCY RANGE</b>	9kHz ~ 1GHz		

**ANTENNA POLARITY & TEST DISTANCE: HORIZONTAL AT 3 M**

NO.	FREQ. (MHz)	EMISSION LEVEL (dBuV/m)	LIMIT (dBuV/m)	MARGIN (dB)	ANTENNA HEIGHT (m)	TABLE ANGLE (Degree)	RAW VALUE (dBuV)	CORRECTION FACTOR (dB/m)
1	49.19	30.6 QP	40.0	-9.4	1.46 H	231	39.1	-8.5
2	150.28	26.9 QP	43.5	-16.6	1.00 H	135	34.6	-7.7
3	204.30	25.8 QP	43.5	-17.7	1.53 H	212	36.6	-10.8
4	517.26	32.8 QP	46.0	-13.2	1.54 H	213	34.0	-1.2
5	624.92	39.5 QP	46.0	-6.5	1.43 H	214	38.2	1.3
6	949.81	38.1 QP	46.0	-7.9	1.48 H	127	31.2	6.9

**ANTENNA POLARITY & TEST DISTANCE: VERTICAL AT 3 M**

NO.	FREQ. (MHz)	EMISSION LEVEL (dBuV/m)	LIMIT (dBuV/m)	MARGIN (dB)	ANTENNA HEIGHT (m)	TABLE ANGLE (Degree)	RAW VALUE (dBuV)	CORRECTION FACTOR (dB/m)
1	36.66	33.8 QP	40.0	-6.2	1.44 V	259	42.9	-9.1
2	93.54	33.6 QP	43.5	-9.9	1.04 V	261	47.0	-13.4
3	374.85	31.9 QP	46.0	-14.1	1.43 V	225	36.6	-4.7
4	517.85	29.9 QP	46.0	-16.1	1.54 V	305	31.1	-1.2
5	624.92	40.3 QP	46.0	-5.7	1.31 V	213	39.0	1.3
6	874.89	39.1 QP	46.0	-6.9	1.00 V	248	33.9	5.2

**REMARKS:**

1. Emission Level(dBuV/m) = Raw Value(dBuV) + Correction Factor(dB/m)
2. Correction Factor(dB/m) = Antenna Factor(dB/m) + Cable Factor(dB) – Pre-Amplifier Factor(dB)
3. The other emission levels were very low against the limit.
4. Margin value = Emission Level – Limit value

**802.11ac (VHT80)**

<b>CHANNEL</b>	TX Channel 42	<b>DETECTOR FUNCTION</b>	Quasi-Peak (QP)
<b>FREQUENCY RANGE</b>	9kHz ~ 1GHz		

**ANTENNA POLARITY & TEST DISTANCE: HORIZONTAL AT 3 M**

NO.	FREQ. (MHz)	EMISSION LEVEL (dBuV/m)	LIMIT (dBuV/m)	MARGIN (dB)	ANTENNA HEIGHT (m)	TABLE ANGLE (Degree)	RAW VALUE (dBuV)	CORRECTION FACTOR (dB/m)
1	48.54	30.0 QP	40.0	-10.0	1.50 H	227	38.5	-8.5
2	149.97	26.7 QP	43.5	-16.8	1.00 H	136	34.4	-7.7
3	204.66	25.4 QP	43.5	-18.1	1.53 H	221	36.2	-10.8
4	517.43	32.5 QP	46.0	-13.5	1.47 H	232	33.7	-1.2
5	624.96	39.1 QP	46.0	-6.9	1.55 H	204	37.8	1.3
6	949.22	38.5 QP	46.0	-7.5	1.53 H	109	31.6	6.9

**ANTENNA POLARITY & TEST DISTANCE: VERTICAL AT 3 M**

NO.	FREQ. (MHz)	EMISSION LEVEL (dBuV/m)	LIMIT (dBuV/m)	MARGIN (dB)	ANTENNA HEIGHT (m)	TABLE ANGLE (Degree)	RAW VALUE (dBuV)	CORRECTION FACTOR (dB/m)
1	37.02	33.8 QP	40.0	-6.2	1.53 V	274	42.9	-9.1
2	93.18	33.5 QP	43.5	-10.0	1.02 V	251	47.0	-13.5
3	374.98	32.6 QP	46.0	-13.4	1.55 V	207	37.3	-4.7
4	517.43	29.8 QP	46.0	-16.2	1.50 V	295	31.0	-1.2
5	624.91	40.2 QP	46.0	-5.8	1.25 V	201	38.9	1.3
6	875.02	38.8 QP	46.0	-7.2	1.01 V	242	33.6	5.2

**REMARKS:**

1. Emission Level(dBuV/m) = Raw Value(dBuV) + Correction Factor(dB/m)
2. Correction Factor(dB/m) = Antenna Factor(dB/m) + Cable Factor(dB) – Pre-Amplifier Factor(dB)
3. The other emission levels were very low against the limit.
4. Margin value = Emission Level – Limit value

<b>CHANNEL</b>	TX Channel 155	<b>DETECTOR FUNCTION</b>	Quasi-Peak (QP)
<b>FREQUENCY RANGE</b>	9kHz ~ 1GHz		

**ANTENNA POLARITY & TEST DISTANCE: HORIZONTAL AT 3 M**

NO.	FREQ. (MHz)	EMISSION LEVEL (dBuV/m)	LIMIT (dBuV/m)	MARGIN (dB)	ANTENNA HEIGHT (m)	TABLE ANGLE (Degree)	RAW VALUE (dBuV)	CORRECTION FACTOR (dB/m)
1	49.11	30.1 QP	40.0	-9.9	1.47 H	231	38.6	-8.5
2	149.73	26.2 QP	43.5	-17.3	1.00 H	153	33.9	-7.7
3	204.21	25.9 QP	43.5	-17.6	1.51 H	231	36.7	-10.8
4	517.55	32.8 QP	46.0	-13.2	1.47 H	237	34.0	-1.2
5	624.83	39.1 QP	46.0	-6.9	1.49 H	211	37.8	1.3
6	949.41	38.5 QP	46.0	-7.5	1.45 H	140	31.6	6.9

**ANTENNA POLARITY & TEST DISTANCE: VERTICAL AT 3 M**

NO.	FREQ. (MHz)	EMISSION LEVEL (dBuV/m)	LIMIT (dBuV/m)	MARGIN (dB)	ANTENNA HEIGHT (m)	TABLE ANGLE (Degree)	RAW VALUE (dBuV)	CORRECTION FACTOR (dB/m)
1	37.07	33.7 QP	40.0	-6.3	1.42 V	246	42.8	-9.1
2	94.06	33.1 QP	43.5	-10.4	1.00 V	254	46.5	-13.4
3	375.00	32.4 QP	46.0	-13.6	1.35 V	225	37.1	-4.7
4	517.67	29.6 QP	46.0	-16.4	1.52 V	290	30.8	-1.2
5	625.01	40.1 QP	46.0	-5.9	1.38 V	236	38.8	1.3
6	874.96	38.9 QP	46.0	-7.1	1.00 V	241	33.7	5.2

**REMARKS:**

1. Emission Level(dBuV/m) = Raw Value(dBuV) + Correction Factor(dB/m)
2. Correction Factor(dB/m) = Antenna Factor(dB/m) + Cable Factor(dB) – Pre-Amplifier Factor(dB)
3. The other emission levels were very low against the limit.
4. Margin value = Emission Level – Limit value

## 4.2 Conducted Emission Measurement

### 4.2.1 Limits of Conducted Emission Measurement

Frequency (MHz)	Conducted Limit (dBuV)	
	Quasi-peak	Average
0.15 - 0.5	66 - 56	56 - 46
0.50 - 5.0	56	46
5.0 - 30.0	60	50

Note: 1. The lower limit shall apply at the transition frequencies.

2. The limit decreases in line with the logarithm of the frequency in the range of 0.15 to 0.50MHz.

### 4.2.2 Test Instruments

DESCRIPTION & MANUFACTURER	MODEL NO.	SERIAL NO.	CALIBRATED DATE	CALIBRATED UNTIL
Test Receiver R&S	ESCS 30	100375	May 09, 2016	May 08, 2017
Line-Impedance Stabilization Network (for EUT) SCHWARZBECK	NSLK-8127	8127-522	Aug. 31, 2016	Aug. 30, 2017
Line-Impedance Stabilization Network (for Peripheral ) R&S	ENV216	100072	June 13, 2016	June 12, 2017
RF Cable	5D-FB	COACAB-002	Mar. 04, 2016	Mar. 03, 2017
10 dB PAD Mini-Circuits	HAT-10+	CONATT-003	Sep. 13, 2016	Sep. 12, 2017
50 ohms Terminator	N/A	04	Nov. 18, 2015	Nov. 17, 2016
50 ohms Terminator	N/A	EMC-02	Oct. 01, 2015	Sep. 30, 2016
Software BVADT	BVADT_Cond_ V7.3.7.4	NA	NA	NA

**Note:**

1. The calibration interval of the above test instruments are 12 months and the calibrations are traceable to NML/ROC and NIST/USA.
2. The test was performed in Shielded Room No. C.
3. The VCCI Con C Registration No. is C-3611.
4. Tested Date: Sep. 13, 2016

#### 4.2.3 Test Procedure

- The EUT was placed 0.4 meters from the conducting wall of the shielded room with EUT being connected to the power mains through a line impedance stabilization network (LISN). Other support units were connected to the power mains through another LISN. The two LISNs provide 50 ohm/ 50uH of coupling impedance for the measuring instrument.
- Both lines of the power mains connected to the EUT were checked for maximum conducted interference.
- The frequency range from 150kHz to 30MHz was searched. Emission levels under (Limit - 20dB) was not recorded.

**NOTE:** All modes of operation were investigated and the worst-case emissions are reported.

#### 4.2.4 Deviation from Test Standard

No deviation.

#### 4.2.5 Test Setup

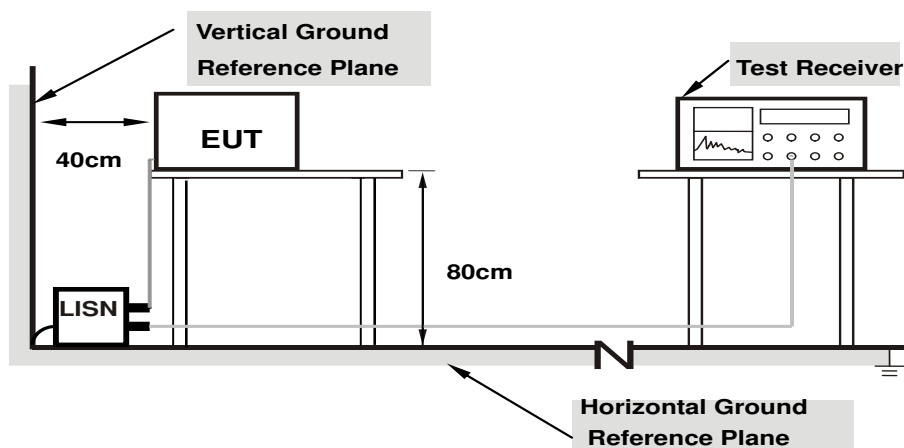

**Note: 1.Support units were connected to second LISN.**

For the actual test configuration, please refer to the attached file (Test Setup Photo).

#### 4.2.6 EUT Operating Condition

Same as 4.1.6.

#### 4.2.7 Test Results (Mode 1)

Phase	Line (L)	Detector Function	Quasi-Peak (QP) / Average (AV)
-------	----------	-------------------	--------------------------------

No	Freq. [MHz]	Corr.	Reading Value		Emission Level		Limit		Margin	
		Factor (dB)	[dB (uV)]		[dB (uV)]		[dB (uV)]		(dB)	
			Q.P.	AV.	Q.P.	AV.	Q.P.	AV.	Q.P.	AV.
1	0.15000	10.31	34.74	22.15	45.05	32.46	66.00	56.00	-20.95	-23.54
2	0.18906	10.26	27.22	12.71	37.48	22.97	64.08	54.08	-26.60	-31.11
3	0.26328	10.24	20.81	11.69	31.05	21.93	61.33	51.33	-30.28	-29.40
4	0.41172	10.25	29.18	22.10	39.43	32.35	57.61	47.61	-18.18	-15.26
5	0.76328	10.17	13.82	8.71	23.99	18.88	56.00	46.00	-32.01	-27.12
6	23.12891	11.04	28.26	25.92	39.30	36.96	60.00	50.00	-20.70	-13.04

#### REMARKS:

1. Q.P. and AV. are abbreviations of quasi-peak and average individually.
2. The emission levels of other frequencies were very low against the limit.
3. Margin value = Emission level - Limit value
4. Correction factor = Insertion loss + Cable loss
5. Emission Level = Correction Factor + Reading Value.

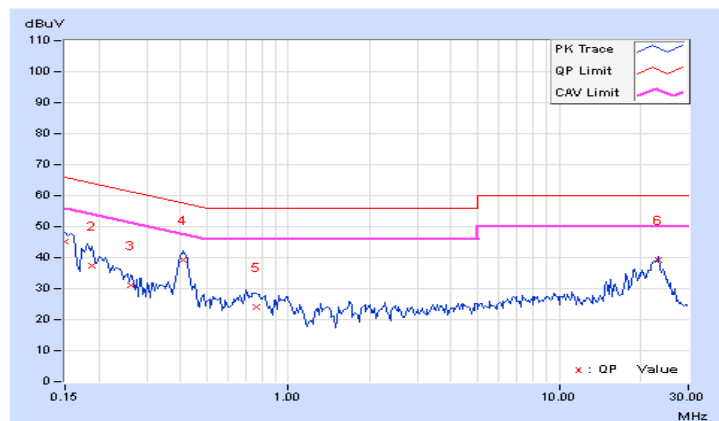



Phase	Neutral (N)	Detector Function	Quasi-Peak (QP) / Average (AV)
-------	-------------	-------------------	--------------------------------

No	Freq. [MHz]	Corr. Factor	Reading Value [dB (uV)]		Emission Level [dB (uV)]		Limit [dB (uV)]		Margin (dB)	
		(dB)	Q.P.	AV.	Q.P.	AV.	Q.P.	AV.	Q.P.	AV.
	1	0.15391	10.35	35.28	26.61	45.63	36.96	65.79	55.79	-20.16
2	0.17734	10.27	31.34	20.37	41.61	30.64	64.61	54.61	-23.00	-23.97
3	0.40781	10.23	30.88	23.68	41.11	33.91	57.69	47.69	-16.58	-13.78
4	0.69688	10.22	14.11	8.32	24.33	18.54	56.00	46.00	-31.67	-27.46
5	15.20703	10.82	19.68	13.52	30.50	24.34	60.00	50.00	-29.50	-25.66
6	<b>23.12891</b>	<b>11.06</b>	<b>28.16</b>	<b>26.00</b>	<b>39.22</b>	<b>37.06</b>	<b>60.00</b>	<b>50.00</b>	<b>-20.78</b>	<b>-12.94</b>

#### REMARKS:

1. Q.P. and AV. are abbreviations of quasi-peak and average individually.
2. The emission levels of other frequencies were very low against the limit.
3. Margin value = Emission level - Limit value
4. Correction factor = Insertion loss + Cable loss
5. Emission Level = Correction Factor + Reading Value.

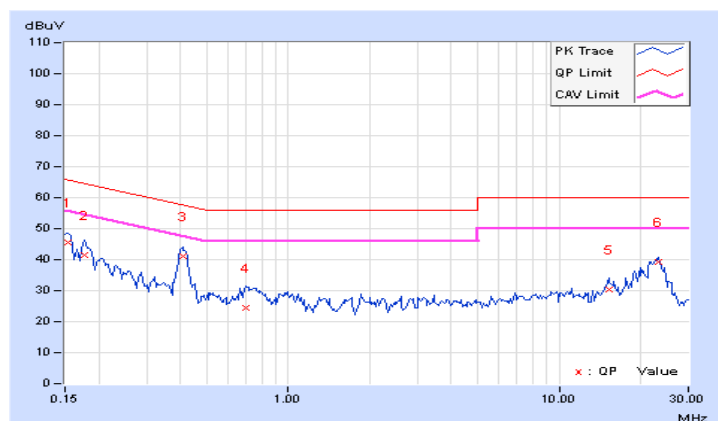

#### 4.2.8 Test Results (Mode 2)

Phase	Line (L)	Detector Function	Quasi-Peak (QP) / Average (AV)
-------	----------	-------------------	--------------------------------

No	Freq. [MHz]	Corr. Factor	Reading Value [dB (uV)]		Emission Level [dB (uV)]		Limit [dB (uV)]		Margin (dB)	
		(dB)	Q.P.	AV.	Q.P.	AV.	Q.P.	AV.	Q.P.	AV.
	1	0.15000	10.31	37.76	22.24	48.07	32.55	66.00	56.00	-17.93
2	0.18516	10.26	32.97	18.47	43.23	28.73	64.25	54.25	-21.02	-25.52
3	0.40391	10.25	20.74	14.16	30.99	24.41	57.77	47.77	-26.78	-23.36
4	0.55234	10.22	8.29	-3.78	18.51	6.44	56.00	46.00	-37.49	-39.56
5	4.16406	10.47	3.94	-3.45	14.41	7.02	56.00	46.00	-41.59	-38.98
6	15.14063	10.78	16.55	10.31	27.33	21.09	60.00	50.00	-32.67	-28.91

#### REMARKS:

1. Q.P. and AV. are abbreviations of quasi-peak and average individually.
2. The emission levels of other frequencies were very low against the limit.
3. Margin value = Emission level - Limit value
4. Correction factor = Insertion loss + Cable loss
5. Emission Level = Correction Factor + Reading Value.

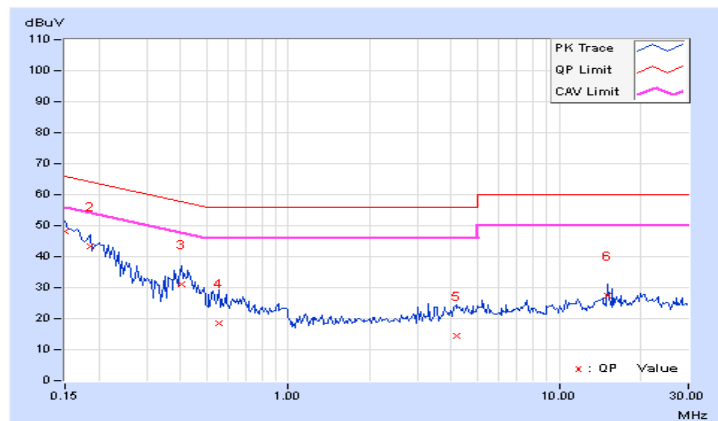

Phase	Neutral (N)	Detector Function	Quasi-Peak (QP) / Average (AV)
-------	-------------	-------------------	--------------------------------

No	Freq. [MHz]	Corr. Factor	Reading Value [dB (uV)]		Emission Level [dB (uV)]		Limit [dB (uV)]		Margin (dB)	
		(dB)	Q.P.	AV.	Q.P.	AV.	Q.P.	AV.	Q.P.	AV.
	1	0.15781	10.34	36.80	22.15	47.14	32.49	65.58	55.58	-18.44
2	0.18516	10.24	32.71	18.96	42.95	29.20	64.25	54.25	-21.30	-25.05
3	0.23594	10.20	26.21	12.89	36.41	23.09	62.24	52.24	-25.83	-29.15
4	0.43125	10.23	24.04	18.83	34.27	29.06	57.23	47.23	-22.96	-18.17
5	15.20313	10.82	16.88	10.15	27.70	20.97	60.00	50.00	-32.30	-29.03
6	19.71094	10.96	16.66	14.26	27.62	25.22	60.00	50.00	-32.38	-24.78

#### REMARKS:

1. Q.P. and AV. are abbreviations of quasi-peak and average individually.
2. The emission levels of other frequencies were very low against the limit.
3. Margin value = Emission level - Limit value
4. Correction factor = Insertion loss + Cable loss
5. Emission Level = Correction Factor + Reading Value.

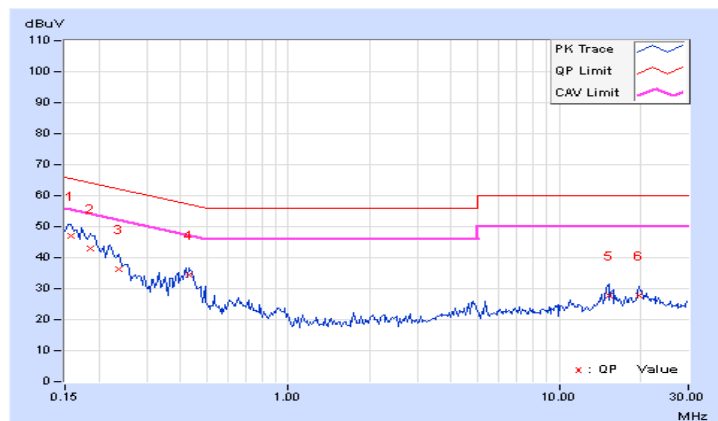

### 4.3 Transmit Power Measurement

#### 4.3.1 Limits of Transmit Power Measurement

Operation Band	EUT Category		Limit
U-NII-1		Outdoor Access Point	1 Watt (30 dBm) (Max. e.i.r.p $\leq$ 125mW(21 dBm) at any elevation angle above 30 degrees as measured from the horizon)
		Fixed point-to-point Access Point	1 Watt (30 dBm)
	√	Indoor Access Point	1 Watt (30 dBm)
		Mobile and Portable client device	250mW (24 dBm)
U-NII-2A			250mW (24 dBm) or 11 dBm+10 log B*
U-NII-2C			250mW (24 dBm) or 11 dBm+10 log B*
U-NII-3		√	1 Watt (30 dBm)

\*B is the 26 dB emission bandwidth in megahertz

Per KDB 662911 Method of conducted output power measurement on IEEE 802.11 devices,

Array Gain = 0 dB (i.e., no array gain) for  $N_{ANT} \leq 4$ ;

Array Gain = 0 dB (i.e., no array gain) for channel widths  $\geq 40$  MHz for any  $N_{ANT}$ ;

Array Gain =  $5 \log(N_{ANT}/N_{SS})$  dB or 3 dB, whichever is less for 20-MHz channel widths with  $N_{ANT} \geq 5$ .

For power measurements on all other devices: Array Gain =  $10 \log(N_{ANT}/N_{SS})$  dB.

#### 4.3.2 Test Setup

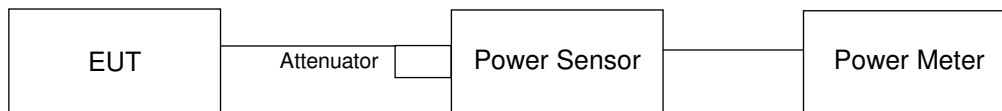

#### 4.3.3 Test Instruments

Refer to section 4.1.2 to get information of above instrument.

#### 4.3.4 Test Procedure

Method PM is used to perform output power measurement, trigger and gating function of wide band power meter is enabled to measure max output power of TX on burst. Duty factor is not added to measured value.

#### 4.3.5 Deviation from Test Standard

No deviation.

#### 4.3.6 EUT Operating Condition

The software provided by client to enable the EUT under transmission condition continuously at lowest, middle and highest channel frequencies individually.

#### 4.3.7 Test Result

#### CDD Mode

#### 802.11a

Chan.	Chan. Freq. (MHz)	Maximum Conducted Power (dBm)		Total Power (mW)	Total Power (dBm)	Limit (dBm)	Pass / Fail
		Chain 0	Chain 1				
36	5180	14.35	14.97	58.632	17.68	30	Pass
40	5200	16.21	16.93	91.1	19.60	30	Pass
48	5240	19.69	20.50	205.313	23.12	30	Pass
149	5745	21.15	21.84	283.074	24.52	30	Pass
157	5785	20.86	21.53	264.132	24.22	30	Pass
165	5825	20.51	21.39	250.181	23.98	30	Pass

#### 802.11ac (VHT20)

Chan.	Chan. Freq. (MHz)	Maximum Conducted Power (dBm)		Total Power (mW)	Total Power (dBm)	Limit (dBm)	Pass / Fail
		Chain 0	Chain 1				
36	5180	13.54	14.73	52.311	17.19	30	Pass
40	5200	15.12	16.43	76.463	18.83	30	Pass
48	5240	18.36	19.37	155.046	21.90	30	Pass
149	5745	21.20	21.85	284.935	24.55	30	Pass
157	5785	21.43	21.90	293.877	24.68	30	Pass
165	5825	21.13	21.75	279.342	24.46	30	Pass

#### 802.11ac (VHT40)

Chan.	Chan. Freq. (MHz)	Maximum Conducted Power (dBm)		Total Power (mW)	Total Power (dBm)	Limit (dBm)	Pass / Fail
		Chain 0	Chain 0				
38	5190	10.13	10.29	20.995	13.22	30	Pass
46	5230	17.82	18.33	128.611	21.09	30	Pass
151	5755	17.86	18.11	125.808	21.00	30	Pass
159	5795	19.99	20.64	215.648	23.34	30	Pass

**802.11ac (VHT80)**

Chan.	Chan. Freq. (MHz)	Maximum Conducted Power (dBm)		Total Power (mW)	Total Power (dBm)	Limit (dBm)	Pass / Fail
		Chain 0	Chain 1				
42	5210	11.75	12.10	31.18	14.94	30	Pass
155	5775	15.12	14.78	62.57	17.96	30	Pass

## Beamforming Mode

### 802.11ac (VHT20)

Chan.	Chan. Freq. (MHz)	Maximum Conducted Power (dBm)		Total Power (mW)	Total Power (dBm)	Limit (dBm)	Pass / Fail
		Chain 0	Chain 1				
36	5180	13.54	14.73	52.311	17.19	28.67	Pass
40	5200	15.12	16.43	76.463	18.83	28.67	Pass
48	5240	18.36	19.37	155.046	21.90	28.67	Pass
149	5745	21.20	21.85	284.935	24.55	28.17	Pass
157	5785	21.43	21.90	293.877	24.68	28.17	Pass
165	5825	21.13	21.75	279.342	24.46	28.17	Pass

Note: 1. For UNII-1: Directional gain =  $10 \log[(10^{G1/20} + 10^{G2/20})^2 / 2] = 7.33\text{dBi} > 6\text{dBi}$ , so the power limit shall be reduced to  $24 - (7.33 - 6) = 28.67\text{dBm}$ .

2. For UNII-3: Directional gain =  $10 \log[(10^{G1/20} + 10^{G2/20})^2 / 2] = 7.83\text{dBi} > 6\text{dBi}$ , so the power limit shall be reduced to  $24 - (7.83 - 6) = 28.17\text{dBm}$ .

### 802.11ac (VHT40)

Chan.	Chan. Freq. (MHz)	Maximum Conducted Power (dBm)		Total Power (mW)	Total Power (dBm)	Limit (dBm)	Pass / Fail
		Chain 0	Chain 0				
38	5190	10.13	10.29	20.995	13.22	28.67	Pass
46	5230	17.82	18.33	128.611	21.09	28.67	Pass
151	5755	17.86	18.11	125.808	21.00	28.17	Pass
159	5795	19.99	20.64	215.648	23.34	28.17	Pass

Note: 1. For UNII-1: Directional gain =  $10 \log[(10^{G1/20} + 10^{G2/20})^2 / 2] = 7.33\text{dBi} > 6\text{dBi}$ , so the power limit shall be reduced to  $24 - (7.33 - 6) = 28.67\text{dBm}$ .

2. For UNII-3: Directional gain =  $10 \log[(10^{G1/20} + 10^{G2/20})^2 / 2] = 7.83\text{dBi} > 6\text{dBi}$ , so the power limit shall be reduced to  $24 - (7.83 - 6) = 28.17\text{dBm}$ .

**802.11ac (VHT80)**

Chan.	Chan. Freq. (MHz)	Maximum Conducted Power (dBm)		Total Power (mW)	Total Power (dBm)	Limit (dBm)	Pass / Fail
		Chain 0	Chain 1				
42	5210	11.75	12.10	31.18	14.94	28.67	Pass
155	5775	15.12	14.78	62.57	17.96	28.17	Pass

Note: 1. For UNII-1: Directional gain =  $10 \log[(10^{G1/20} + 10^{G2/20})^2 / 2] = 7.33\text{dBi} > 6\text{dBi}$  , so the power limit shall be reduced to  $24-(7.33-6) = 28.67\text{dBm}$ .

2. For UNII-3: Directional gain =  $10 \log[(10^{G1/20} + 10^{G2/20})^2 / 2] = 7.83\text{dBi} > 6\text{dBi}$  , so the power limit shall be reduced to  $24-(7.83-6) = 28.17\text{dBm}$ .



※Add test for each data rate output power (require by manufacturer):

802.11a

CHANNEL	FREQUENCY (MHz)	AVERAGE POWER (dBm)							
		Data rate							
		6Mbps	9Mbps	12Mbps	18Mbps	24Mbps	36Mbps	48Mbps	54Mbps
36	5180	17.68	17.67	17.66	17.67	17.59	17.53	17.36	17.52
40	5200	19.60	19.54	19.59	19.46	19.57	19.57	19.42	19.51
48	5240	23.12	23.04	22.89	23.07	22.88	22.92	22.84	23.06
149	5745	24.52	24.46	24.35	24.17	24.32	24.17	24.06	24.22
157	5785	24.22	24.15	24.14	23.92	24.14	23.98	24.04	24.2
165	5825	23.98	23.87	23.80	23.90	23.8	23.85	23.75	23.65

802.11ac (VHT20)

Nss=1

CHANNEL	FREQUENCY (MHz)	AVERAGE POWER (dBm)								
		Data rate								
		MCS0	MCS1	MCS2	MCS3	MCS4	MCS5	MCS6	MCS7	MCS8
36	5180	17.19	17.13	17.13	17.02	16.95	16.81	16.59	16.62	16.80
40	5200	18.83	18.68	18.61	18.79	18.64	18.43	18.26	18.34	18.46
48	5240	21.90	21.89	21.75	21.70	21.61	21.77	21.82	21.82	21.63
149	5745	24.55	24.54	24.44	24.41	24.45	24.25	24.33	24.16	24.11
157	5785	24.68	24.48	24.34	24.53	24.45	24.4	24.56	24.41	24.62
165	5825	24.46	24.41	24.19	24.14	24.23	24.39	24.45	24.23	24.37

Nss=2

CHANNEL	FREQUENCY (MHz)	AVERAGE POWER (dBm)								
		Data rate								
		MCS0	MCS1	MCS2	MCS3	MCS4	MCS5	MCS6	MCS7	MCS8
36	5180	17.13	17.06	17.09	17.12	17.06	17.12	17.06	17.00	17.06
40	5200	18.78	18.57	18.37	18.22	18.13	18.22	18.17	18.11	18
48	5240	21.86	21.76	21.80	21.64	21.82	21.74	21.53	21.52	21.7
149	5745	24.49	24.33	24.36	24.29	24.35	24.18	23.99	24.11	23.89
157	5785	24.62	24.58	24.49	24.31	24.39	24.21	24	24.05	24.23
165	5825	24.42	24.35	24.23	24.08	24.09	24.19	24.05	24.17	24.2

**802.11ac (VHT40)**
**Nss=1**

CHANNEL	FREQUENCY (MHz)	AVERAGE POWER (dBm)									
		Data rate									
		MCS0	MCS1	MCS2	MCS3	MCS4	MCS5	MCS6	MCS7	MCS8	MCS9
38	5190	13.22	13.03	13.21	13.01	13.06	12.99	13.02	13.13	13.21	13.19
46	5230	21.09	21.05	20.90	20.90	20.99	21.08	20.98	21.03	20.97	20.84
151	5755	21.00	20.79	20.86	20.96	20.76	20.59	20.68	20.83	20.74	20.52
159	5795	23.34	23.25	23.29	23.16	23.31	23.33	23.33	23.13	23.15	23.12

**Nss=2**

CHANNEL	FREQUENCY (MHz)	AVERAGE POWER (dBm)									
		Data rate									
		MCS0	MCS1	MCS2	MCS3	MCS4	MCS5	MCS6	MCS7	MCS8	MCS9
38	5190	13.15	13.06	13.06	13.13	13.13	12.91	12.80	12.74	12.84	13.05
46	5230	21.05	20.96	20.92	20.89	21.03	20.85	20.7	20.52	20.36	20.51
151	5755	21.00	20.88	20.81	20.71	20.88	20.83	20.83	20.69	20.61	20.70
159	5795	23.29	23.17	23.07	23.12	22.92	22.97	23.08	23.07	23.26	23.15

**802.11ac (VHT80)**
**Nss=1**

CHANNEL	FREQUENCY (MHz)	AVERAGE POWER (dBm)									
		Data rate									
		MCS0	MCS1	MCS2	MCS3	MCS4	MCS5	MCS6	MCS7	MCS8	MCS9
42	5210	14.94	14.84	14.76	14.90	14.93	14.75	14.85	14.73	14.83	14.90
155	5775	17.96	17.85	17.76	17.57	17.4	17.44	17.45	17.33	17.19	17.40

**Nss=2**

CHANNEL	FREQUENCY (MHz)	AVERAGE POWER (dBm)									
		Data rate									
		MCS0	MCS1	MCS2	MCS3	MCS4	MCS5	MCS6	MCS7	MCS8	MCS9
42	5210	14.91	14.75	14.63	14.61	14.73	14.70	14.77	14.80	14.80	14.76
155	5775	17.90	17.87	17.79	17.67	17.68	17.71	17.83	17.61	17.67	17.51

## 4.4 Occupied Bandwidth Measurement

### 4.4.1 Test Setup

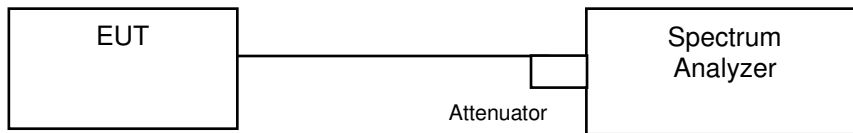

### 4.4.2 Test Instruments

Refer to section 4.1.2 to get information of above instrument.

### 4.4.3 Test Procedure

The transmitter output was connected to the spectrum analyzer through an attenuator. The bandwidth of the fundamental frequency was measured by spectrum analyzer with resolution bandwidth in the range of 1% to 5% of the anticipated emission bandwidth, and a video bandwidth at least 3x the resolution bandwidth and set the detector to SAMPLE. The width of a frequency band such that, below the lower and above the upper frequency limits, the mean powers emitted are each equal to a specified percentage 0.5 %of the total mean power of a given emission.

#### 4.4.4 Test Results

##### 802.11a

Channel	Channel Frequency (MHz)	Occupied Bandwidth (MHz)	
		CHAIN 0	CHAIN 1
36	5180	17.04	16.92
40	5200	17.16	17.16
48	5240	19.20	18.48
149	5745	26.04	29.40
157	5785	26.16	26.28
165	5825	27.60	26.52

##### 802.11ac (VHT20)

Channel	Channel Frequency (MHz)	Occupied Bandwidth (MHz)	
		CHAIN 0	CHAIN 1
36	5180	18.00	18.24
40	5200	18.12	18.12
48	5240	19.32	19.32
149	5745	29.76	30.84
157	5785	27.12	28.68
165	5825	28.92	27.60

##### 802.11ac (VHT40)

Channel	Channel Frequency (MHz)	Occupied Bandwidth (MHz)	
		CHAIN 0	CHAIN 1
38	5190	36.48	36.72
46	5230	37.44	37.68
151	5755	37.20	42.00
159	5795	53.52	57.36

##### 802.11ac (VHT80)

Channel	Channel Frequency (MHz)	Occupied Bandwidth (MHz)	
		CHAIN 0	CHAIN 1
42	5210	76.32	75.84
155	5775	76.80	76.32

### Spectrum Plot of Worst Value

**802.11a\_Chain1 / CH149**

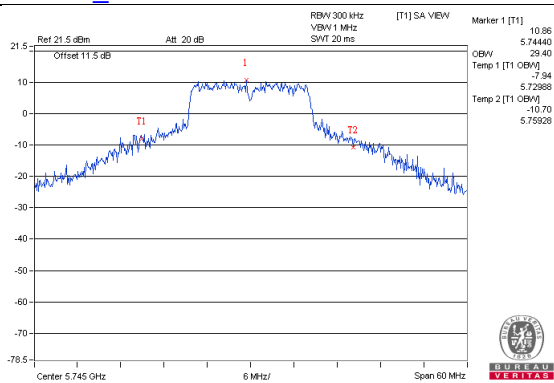

**802.11ac (VHT20)\_Chain1 / CH149**

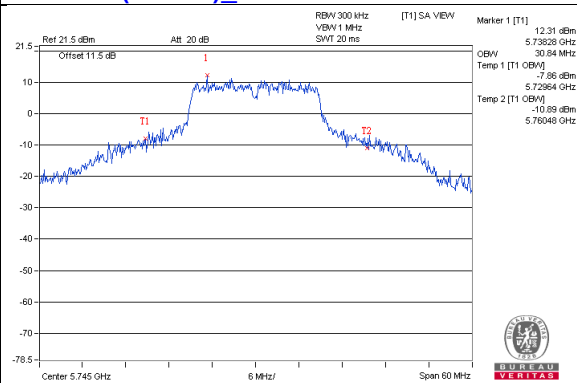

**802.11ac (VHT40)\_Chain1 / CH159**

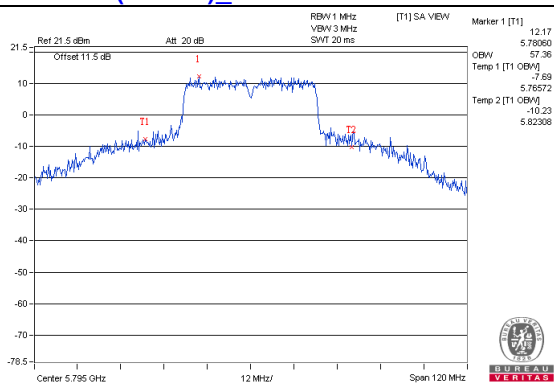

**802.11ac (VHT80)\_Chain0 / CH155**

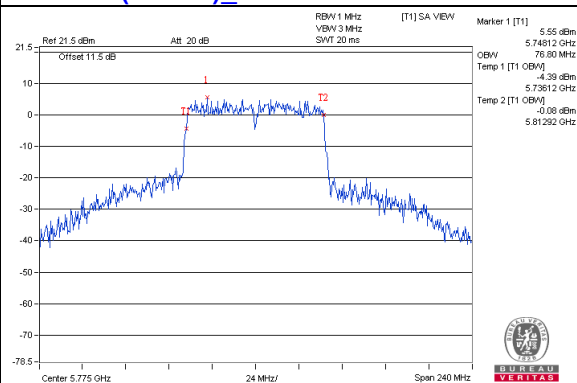

**Spectrum Plot for near by DFS band  
(DFS is required, if 99% OCP straddle into U-NII-2A band)**

**802.11a\_Chain0 / CH48**

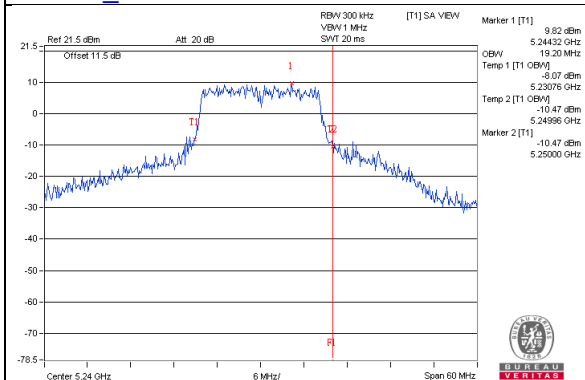

**802.11a\_Chain1 / CH48**

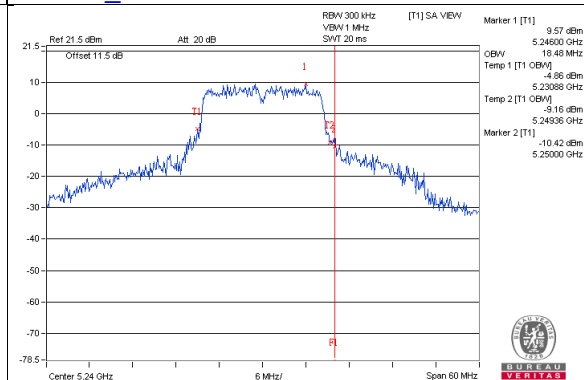

**802.11ac(VHT20)\_Chain0 / CH48**

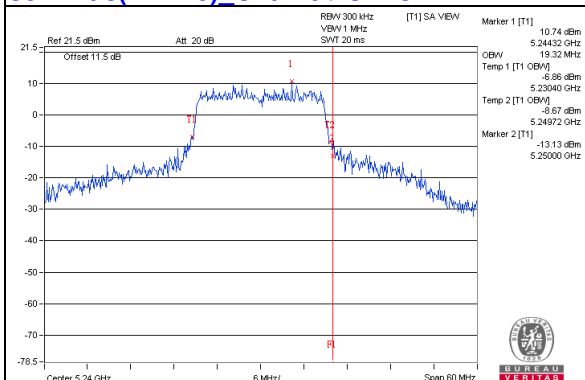

**802.11ac(VHT20)\_Chain1 / CH48**

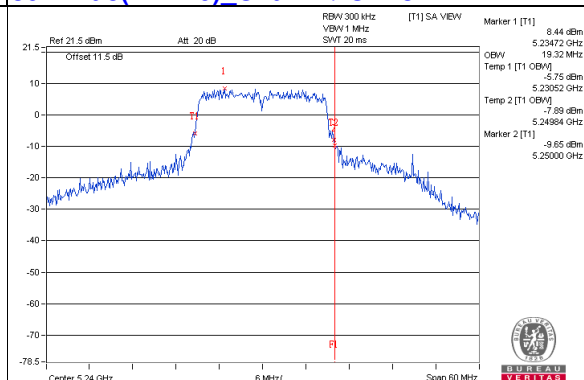

**802.11ac(VHT40)\_Chain0 / CH46**

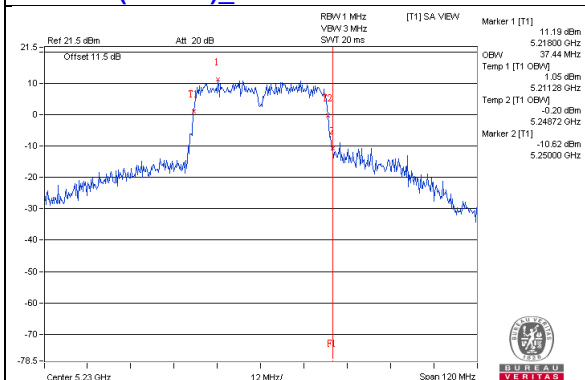

**802.11ac(VHT40)\_Chain1 / CH46**

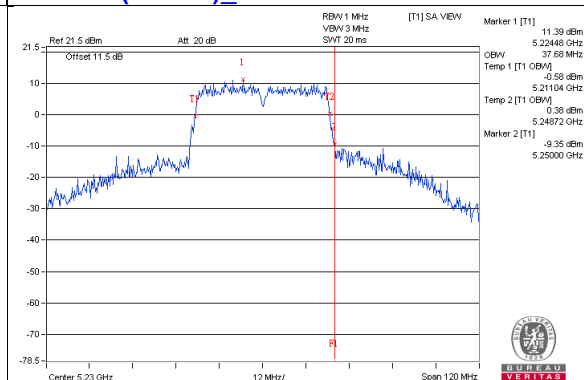

**802.11ac(VHT80)\_Chain0 / CH42**

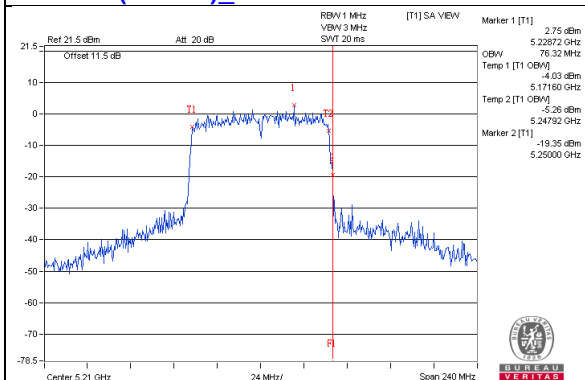

**802.11ac(VHT80)\_Chain1 / CH42**

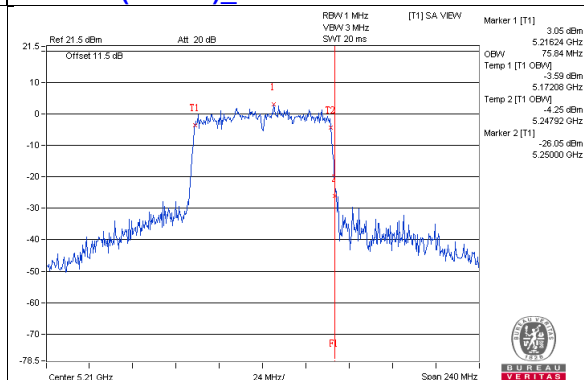

### Spectrum Plot for near by DFS band (DFS is required, if 99% OCP straddle into U-NII-2C band)

**802.11a\_Chain0 / CH149**

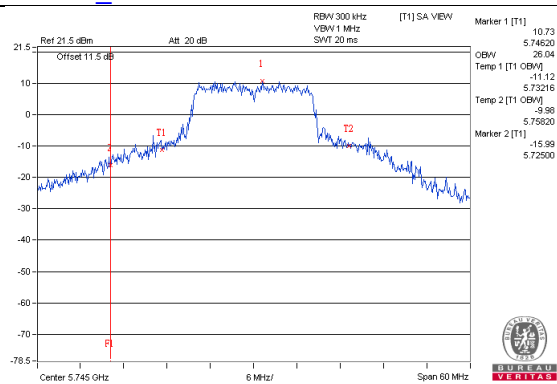

**802.11a\_Chain1 / CH149**

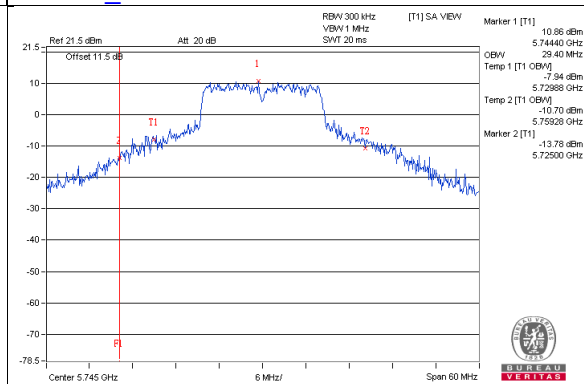

**802.11ac(VHT20)\_Chain0 / CH149**

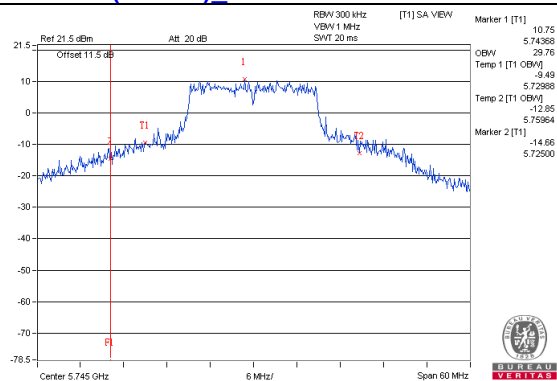

**802.11ac(VHT20)\_Chain1 / CH149**

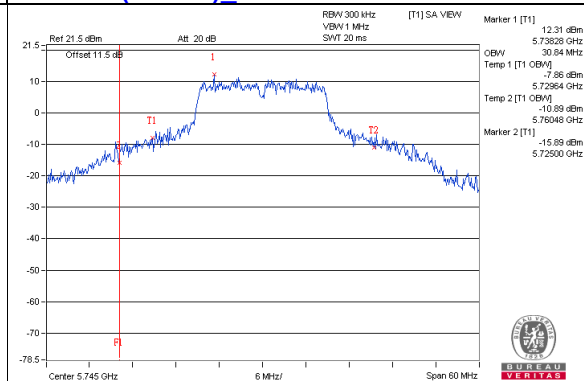

**802.11ac(VHT40)\_Chain0 / CH151**

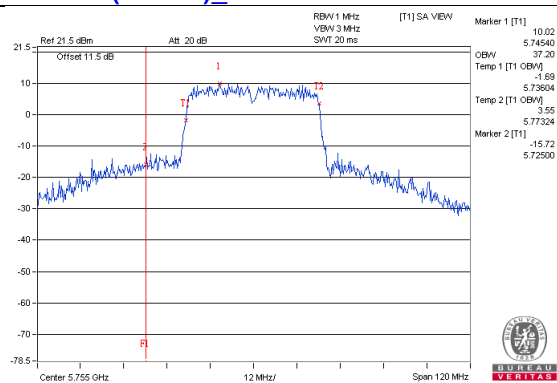

**802.11ac(VHT40)\_Chain1 / CH151**

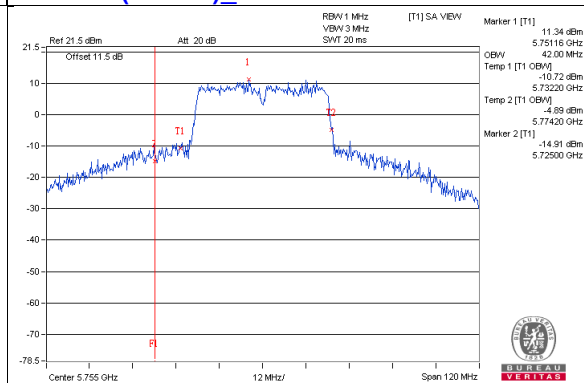

**802.11ac(VHT80)\_Chain0 / CH155**

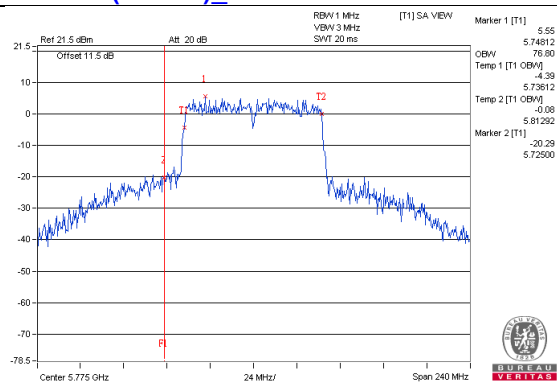

**802.11ac(VHT80)\_Chain1 / CH155**

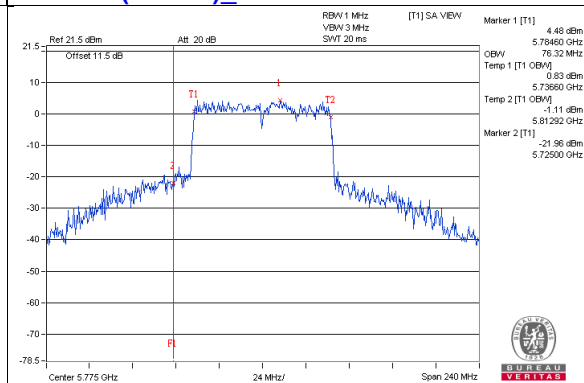

## 4.5 Peak Power Spectral Density Measurement

### 4.5.1 Limits of Peak Power Spectral Density Measurement

Operation Band	EUT Category		Limit
U-NII-1		Outdoor Access Point	17dBm/ MHz
		Fixed point-to-point Access Point	
	√	Indoor Access Point	
		Mobile and Portable client device	11dBm/ MHz
U-NII-2A			11dBm/ MHz
U-NII-2C			11dBm/ MHz
U-NII-3	√		30dBm/ 500kHz

### 4.5.2 Test Setup

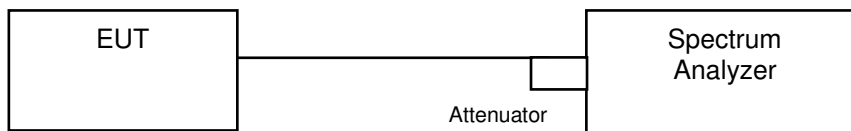

### 4.5.3 Test Instruments

Refer to section 4.1.2 to get information of above instrument.



#### 4.5.4 Test Procedure

##### **802.11a, 802.11ac (VHT20), 802.11ac (VHT40)**

###### **For U-NII-1:**

Using method SA-1

1. Set span to encompass the entire emission bandwidth (EBW) of the signal.
2. Set RBW = 1 MHz, Set VBW  $\geq$  3 MHz, Detector = RMS
3. Sweep time = auto, trigger set to "free run".
4. Trace average at least 100 traces in power averaging mode.
5. Record the max value

###### **For U-NII-3:**

1. Set span to encompass the entire emission bandwidth (EBW) of the signal.
2. Set RBW = 300 kHz, Set VBW  $\geq$  1 MHz, Detector = RMS
3. Use the peak marker function to determine the maximum power level in any 300 kHz band segment within the fundamental EBW.
4. Scale the observed power level to an equivalent value in 500 kHz by adjusting (reducing) the measured power by a bandwidth correction factor (BWCF) where  $BWCF = 10\log(500 \text{ kHz}/300\text{kHz})$
5. Sweep time = auto, trigger set to "free run".
6. Trace average at least 100 traces in power averaging mode.
7. Record the max value

##### **802.11ac (VHT80)**

###### **For U-NII-1:**

Using method SA-2

1. Set span to encompass the entire emission bandwidth (EBW) of the signal.
2. Set RBW = 1 MHz, Set VBW  $\geq$  3 MHz, Detector = RMS
3. Sweep time = auto, trigger set to "free run".
4. Trace average at least 100 traces in power averaging mode.
5. Record the max value and add  $10 \log (1/\text{duty cycle})$

###### **For U-NII-3:**

1. Set span to encompass the entire emission bandwidth (EBW) of the signal.
2. Set RBW = 300 kHz, Set VBW  $\geq$  1 MHz, Detector = RMS
3. Use the peak marker function to determine the maximum power level in any 300 kHz band segment within the fundamental EBW.
4. Scale the observed power level to an equivalent value in 500 kHz by adjusting (reducing) the measured power by a bandwidth correction factor (BWCF) where  $BWCF = 10\log(500 \text{ kHz}/300\text{kHz})$
5. Sweep time = auto, trigger set to "free run".
6. Trace average at least 100 traces in power averaging mode.
7. Record the max value and add  $10 \log (1/\text{duty cycle})$

#### 4.5.5 Deviation from Test Standard

No deviation.

#### 4.5.6 EUT Operating Condition

Same as Item 4.3.6.

#### 4.5.7 Test Results

##### For U-NII-1:

##### 802.11a

Chan.	Chan. Freq. (MHz)	PSD (dBm/MHz)		Total Power Density (dBm/MHz)	MAX. Limit (dBm/MHz)	Pass / Fail
		Chain 0	Chain 1			
36	5180	0.58	1.04	3.83	15.67	Pass
40	5200	2.56	2.38	5.48	15.67	Pass
48	5240	5.19	4.96	8.09	15.67	Pass

- Note:** 1. Method a) of power density measurement of KDB 662911 is using for calculating total power density. Total power density is summing entire spectra across corresponding frequency bins on the various outputs by computer.
2. Directional gain =  $10 \log[(10^{G1/20} + 10^{G2/20})^2 / 2] = 7.33\text{dBi} > 6\text{dBi}$ , so the power density limit shall be reduced to  $17 - (7.33 - 6) = 15.67\text{dBm}$ .

##### 802.11ac (VHT20)

Chan.	Chan. Freq. (MHz)	PSD (dBm/MHz)		Total Power Density (dBm/MHz)	MAX. Limit (dBm/MHz)	Pass / Fail
		Chain 0	Chain 1			
36	5180	-1.27	0.18	2.53	15.67	Pass
40	5200	0.96	2.30	4.69	15.67	Pass
48	5240	4.35	4.45	7.41	15.67	Pass

- Note:** 1. Method a) of power density measurement of KDB 662911 is using for calculating total power density. Total power density is summing entire spectra across corresponding frequency bins on the various outputs by computer.
2. Directional gain =  $10 \log[(10^{G1/20} + 10^{G2/20})^2 / 2] = 7.33\text{dBi} > 6\text{dBi}$ , so the power density limit shall be reduced to  $17 - (7.33 - 6) = 15.67\text{dBm}$ .

##### 802.11ac (VHT40)

Chan.	Chan. Freq. (MHz)	PSD (dBm/MHz)		Total Power Density (dBm/MHz)	MAX. Limit (dBm/MHz)	Pass / Fail
		Chain 0	Chain 1			
38	5190	-7.31	-6.55	-3.90	15.67	Pass
46	5230	0.38	0.55	3.48	15.67	Pass

- Note:** 1. Method a) of power density measurement of KDB 662911 is using for calculating total power density. Total power density is summing entire spectra across corresponding frequency bins on the various outputs by computer.
2. Directional gain =  $10 \log[(10^{G1/20} + 10^{G2/20})^2 / 2] = 7.33\text{dBi} > 6\text{dBi}$ , so the power density limit shall be reduced to  $17 - (7.33 - 6) = 15.67\text{dBm}$ .

### 802.11ac (VHT80)

Chan.	Chan. Freq. (MHz)	PSD W/O Duty Factor (dBm/MHz)		Duty Factor (dB)	Total PSD With Duty Factor (dBm/MHz)	MAX. Limit (dBm/MHz)	Pass / Fail
		Chain 0	Chain 1				
42	5210	-8.36	-7.51	0.19	-4.72	15.67	Pass

- Note:**
- Method a) of power density measurement of KDB 662911 is using for calculating total power density. Total power density is summing entire spectra across corresponding frequency bins on the various outputs by computer.
  - Directional gain =  $10 \log[(10^{G1/20} + 10^{G2/20})^2 / 2] = 7.33\text{dBi} > 6\text{dBi}$ , so the power density limit shall be reduced to  $17 - (7.33 - 6) = 15.67\text{dBm}$ .

Spectrum Plot of Worst Value

802.11a\_Chain 0 / CH48

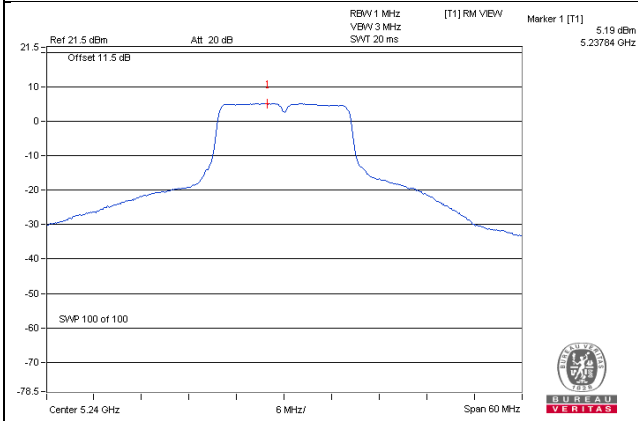

802.11ac (VHT20)\_Chain 1 / CH48

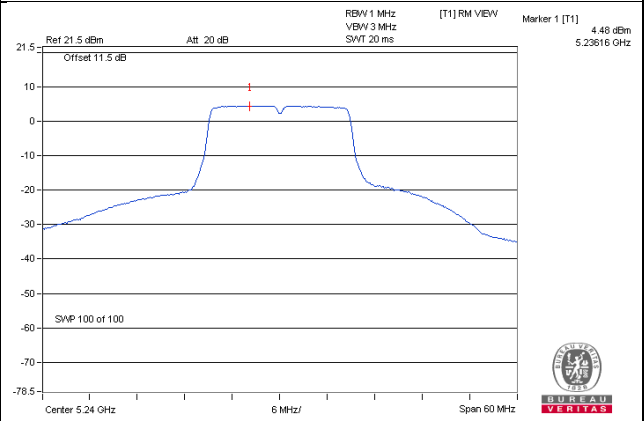

802.11ac (VHT40)\_Chain 1 / CH46

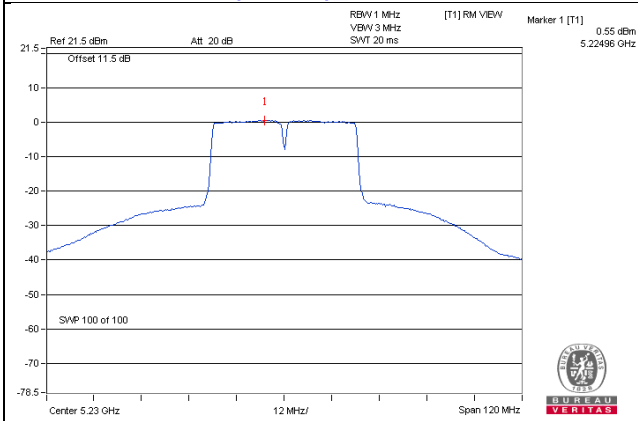

802.11ac (VHT80)\_Chain 1 / CH42

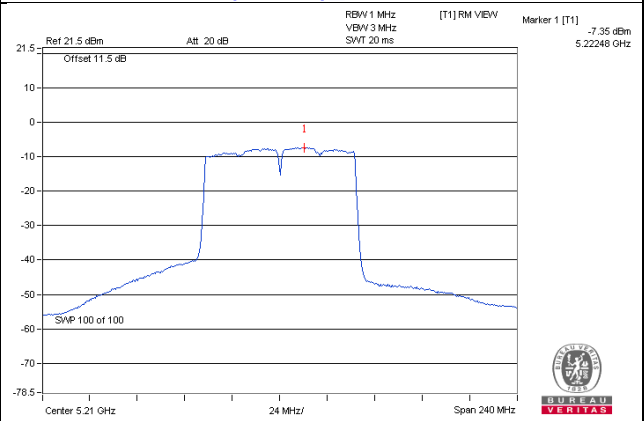

**For U-NII-3:**
**802.11a**

TX chain	Channel	Freq. (MHz)	PSD (dBm/300kHz)	PSD (dBm/500kHz)	10 log (N=2) dB	Total PSD (dBm/500kHz)	Limit (dBm/500kHz)	Pass /Fail
0	149	5745	-1.31	0.91	3.01	3.92	28.17	Pass
	157	5785	-1.48	0.74	3.01	3.75	28.17	Pass
	165	5825	-1.58	0.64	3.01	3.65	28.17	Pass
1	149	5745	-0.88	1.34	3.01	4.35	28.17	Pass
	157	5785	-1.28	0.94	3.01	3.95	28.17	Pass
	165	5825	-1.41	0.81	3.01	3.82	28.17	Pass

Note: 1. Directional gain =  $10 \log[(10^{G1/20} + 10^{G2/20})^2 / 2] = 7.83\text{dBi} > 6\text{dBi}$  , so the power density limit shall be reduced to  $30-(7.83-6) = 28.17\text{dBm}$ .

**802.11ac (VHT20)**

TX chain	Channel	Freq. (MHz)	PSD (dBm/300kHz)	PSD (dBm/500kHz)	10 log (N=2) dB	Total PSD (dBm/500kHz)	Limit (dBm/500kHz)	Pass /Fail
0	149	5745	-1.62	0.60	3.01	3.61	28.17	Pass
	157	5785	-1.87	0.35	3.01	3.36	28.17	Pass
	165	5825	-2.06	0.16	3.01	3.17	28.17	Pass
1	149	5745	-1.33	0.89	3.01	3.90	28.17	Pass
	157	5785	-1.64	0.58	3.01	3.59	28.17	Pass
	165	5825	-1.65	0.57	3.01	3.58	28.17	Pass

Note: 1. Directional gain =  $10 \log[(10^{G1/20} + 10^{G2/20})^2 / 2] = 7.83\text{dBi} > 6\text{dBi}$  , so the power density limit shall be reduced to  $30-(7.83-6) = 28.17\text{dBm}$ .

**802.11ac (VHT40)**

TX chain	Channel	Freq. (MHz)	PSD (dBm/300kHz)	PSD (dBm/500kHz)	10 log (N=2) dB	Total PSD (dBm/500kHz)	Limit (dBm/500kHz)	Pass /Fail
0	151	5755	-8.19	-5.97	3.01	-2.96	28.17	Pass
	159	5795	-5.74	-3.52	3.01	-0.51	28.17	Pass
1	151	5755	-7.27	-5.05	3.01	-2.04	28.17	Pass
	159	5795	-5.53	-3.31	3.01	-0.30	28.17	Pass

Note: 1. Directional gain =  $10 \log[(10^{G1/20} + 10^{G2/20})^2 / 2] = 7.83\text{dBi} > 6\text{dBi}$  , so the power density limit shall be reduced to  $30-(7.83-6) = 28.17\text{dBm}$ .

### 802.11ac (VHT80)

TX chain	Chan.	Chan. Freq. (MHz)	PSD W/O Duty Factor		10 log (N=2) dB	Duty Factor (dB)	Total PSD With Duty Factor (dBm/500kHz)	Limit (dBm/500kHz)	Pass /Fail
			(dBm/300kHz)	(dBm/500kHz)					
0	155	5775	-13.20	-10.98	3.01	0.19	-7.78	28.17	Pass
1	155	5775	-13.25	-11.03	3.01	0.19	-7.83	28.17	Pass

Note: 1. Directional gain =  $10 \log[(10^{G1/20} + 10^{G2/20})^2 / 2] = 7.83\text{dBi} > 6\text{dBi}$  , so the power density limit shall be reduced to  $30 - (7.83 - 6) = 28.17\text{dBm}$ .

2. Refer to section 3.3 for duty cycle spectrum plot.

Spectrum Plot of Worst Value

802.11a – Chain 1: CH 149

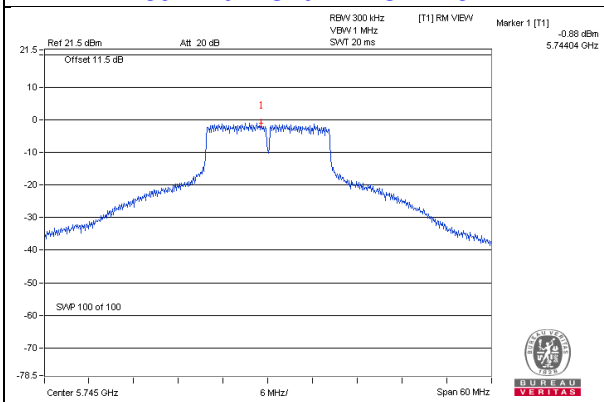

802.11ac (VHT20) – Chain 1: CH 149

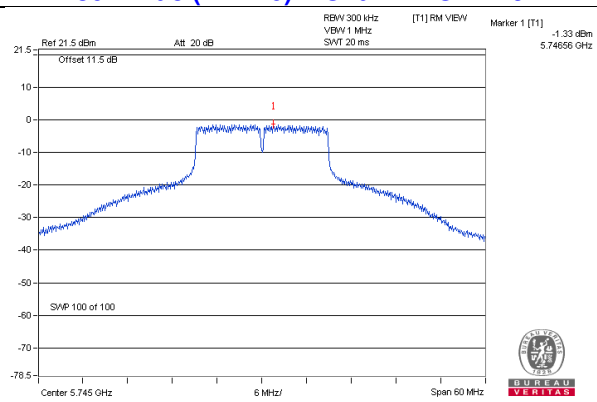

802.11ac (VHT40) – Chain 1: CH 159

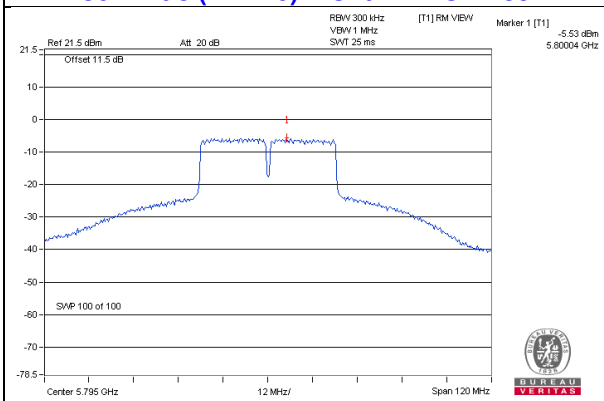

802.11ac (VHT80) – Chain 0: CH 155

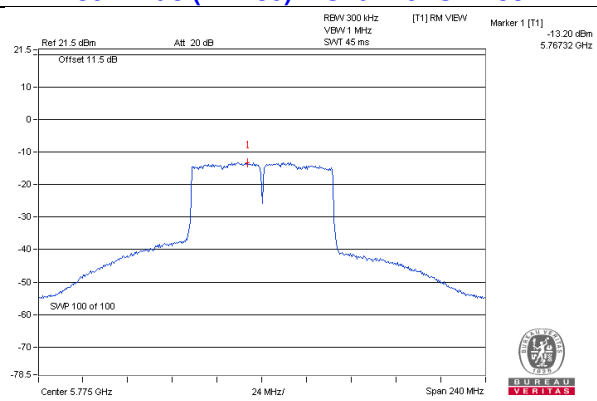

## 4.6 Frequency Stability Measurement

### 4.6.1 Limits of Frequency Stability Measurement

The frequency of the carrier signal shall be maintained within band of operation

### 4.6.2 Test Setup

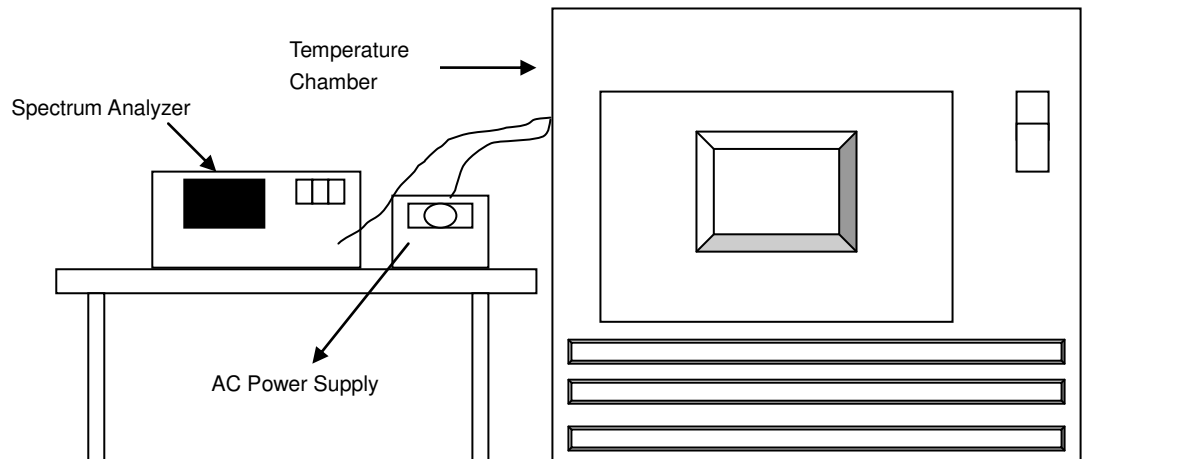

### 4.6.3 Test Instruments

Refer to section 4.1.2 to get information of above instrument.

### 4.6.4 Test Procedure

- The EUT was placed inside the environmental test chamber and powered by nominal AC voltage.
- Turn the EUT on and couple its output to a spectrum analyzer.
- Turn the EUT off and set the chamber to the highest temperature specified.
- Allow sufficient time (approximately 30 min) for the temperature of the chamber to stabilize, turn the EUT on and measure the operating frequency after 2, 5, and 10 Minutes.
- Repeat step 2 and 3 with the temperature chamber set to the lowest temperature.
- The test chamber was allowed to stabilize at +20 degree C for a minimum of 30 Minutes. The supply voltage was then adjusted on the EUT from 85% to 115% and the frequency record.

### 4.6.5 Deviation from Test Standard

No deviation.

### 4.6.6 EUT Operating Condition

Set the EUT transmit at un-modulation mode to test frequency stability.



## 4.6.7 Test Results

Frequency Stability Versus Temp.									
Operating Frequency: 5180 MHz									
TEMP. (°C)	Power Supply (Vac)	0 Minute		2 Minute		5 Minute		10 Minute	
		Measured Frequency (MHz)	Pass/Fail	Measured Frequency (MHz)	Pass/Fail	Measured Frequency (MHz)	Pass/Fail	Measured Frequency (MHz)	Pass/Fail
50	120	5179.9947	Pass	5179.9954	Pass	5179.9935	Pass	5179.9918	Pass
40	120	5179.9974	Pass	5179.9961	Pass	5179.9985	Pass	5179.9952	Pass
30	120	5180.021	Pass	5180.0219	Pass	5180.0192	Pass	5180.0184	Pass
20	120	5179.9885	Pass	5179.9882	Pass	5179.9859	Pass	5179.9889	Pass
10	120	5180.0117	Pass	5180.0106	Pass	5180.0118	Pass	5180.008	Pass
0	120	5179.9904	Pass	5179.9941	Pass	5179.9941	Pass	5179.9916	Pass
-10	120	5179.9931	Pass	5179.9954	Pass	5179.9956	Pass	5179.9953	Pass
-20	120	5179.9843	Pass	5179.9838	Pass	5179.9854	Pass	5179.9822	Pass
-30	120	5180.0233	Pass	5180.0228	Pass	5180.0273	Pass	5180.0242	Pass

Frequency Stability Versus Voltage									
Operating Frequency: 5180 MHz									
TEMP. (°C)	Power Supply (Vac)	0 Minute		2 Minute		5 Minute		10 Minute	
		Measured Frequency (MHz)	Pass/Fail	Measured Frequency (MHz)	Pass/Fail	Measured Frequency (MHz)	Pass/Fail	Measured Frequency (MHz)	Pass/Fail
20	138	5179.9875	Pass	5179.9877	Pass	5179.986	Pass	5179.9897	Pass
	120	5179.9885	Pass	5179.9882	Pass	5179.9859	Pass	5179.9889	Pass
	102	5179.9882	Pass	5179.9883	Pass	5179.9868	Pass	5179.9892	Pass

## 4.7 6dB Bandwidth Measurement

### 4.7.1 Limits of 6dB Bandwidth Measurement

The minimum of 6dB Bandwidth Measurement is 0.5MHz.

### 4.7.2 Test Setup

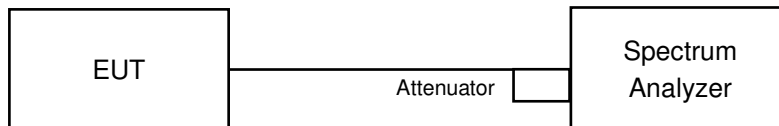

### 4.7.3 Test Instruments

Refer to section 4.1.2 to get information of above instrument.

### 4.7.4 Test Procedure

#### MEASUREMENT PROCEDURE REF

- Set resolution bandwidth (RBW) = 100kHz
- Set the video bandwidth (VBW)  $\geq 3 \times$  RBW, Detector = Peak.
- Trace mode = max hold.
- Sweep = auto couple.
- Measure the maximum width of the emission that is constrained by the frequencies associated with the two amplitude points (upper and lower) that are attenuated by 6 dB relative to the maximum level measured in the fundamental emission

### 4.7.5 Deviation from Test Standard

No deviation.

### 4.7.6 EUT Operating Condition

The software provided by client to enable the EUT under transmission condition continuously at lowest, middle and highest channel frequencies individually.

#### 4.7.7 Test Results

##### 802.11a

Channel	Frequency (MHz)	6dB Bandwidth (MHz)		Minimum Limit (MHz)	Pass / Fail
		Chain 0	Chain 1		
149	5745	16.41	16.37	0.5	PASS
157	5785	16.41	16.38	0.5	PASS
165	5825	16.40	16.39	0.5	PASS

##### 802.11ac (VHT20)

Channel	Frequency (MHz)	6dB Bandwidth (MHz)		Minimum Limit (MHz)	Pass / Fail
		Chain 0	Chain 1		
149	5745	17.65	17.62	0.5	PASS
157	5785	17.63	17.62	0.5	PASS
165	5825	17.63	17.62	0.5	PASS

##### 802.11ac (VHT40)

Channel	Frequency (MHz)	6dB Bandwidth (MHz)		Minimum Limit (MHz)	Pass / Fail
		Chain 0	Chain 1		
151	5755	36.48	36.43	0.5	PASS
159	5795	36.47	36.42	0.5	PASS

##### 802.11ac (VHT80)

Channel	Frequency (MHz)	6dB Bandwidth (MHz)		Minimum Limit (MHz)	Pass / Fail
		Chain 0	Chain 1		
155	5775	75.86	76.06	0.5	PASS

Spectrum Plot of Worst Value

802.11a\_Chain 1 / CH149

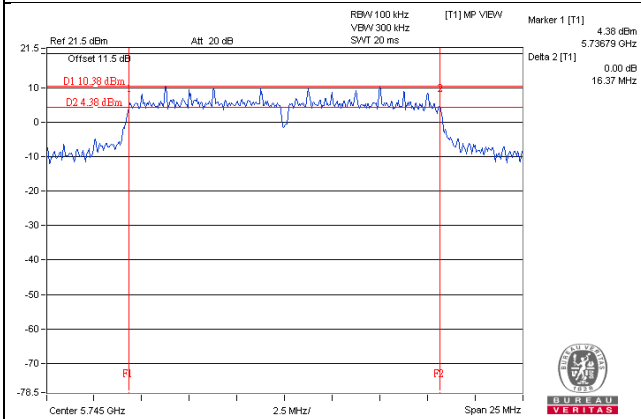

802.11ac (VHT20)\_Chain 1 / CH165

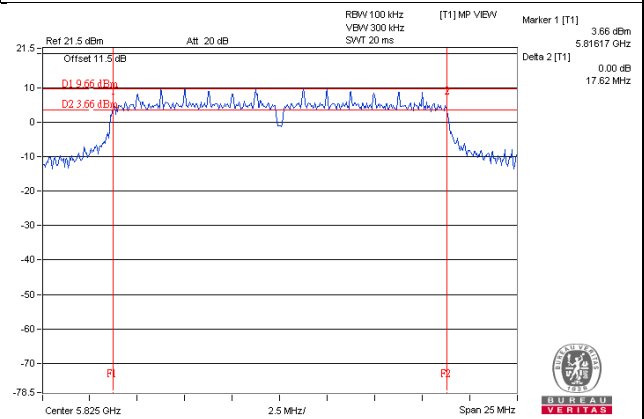

802.11ac (VHT40)\_Chain 1 / CH159

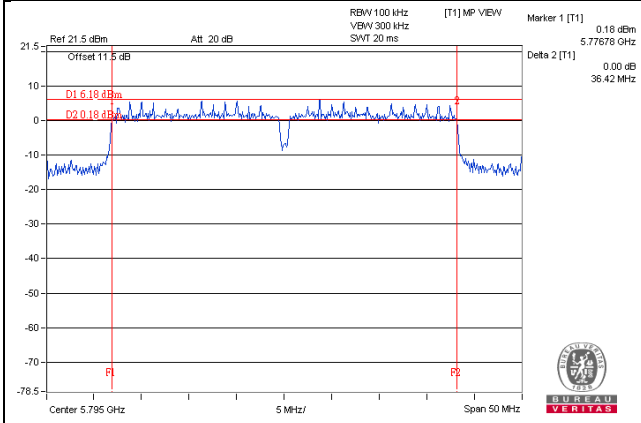

802.11ac (VHT80)\_Chain 0 / CH155

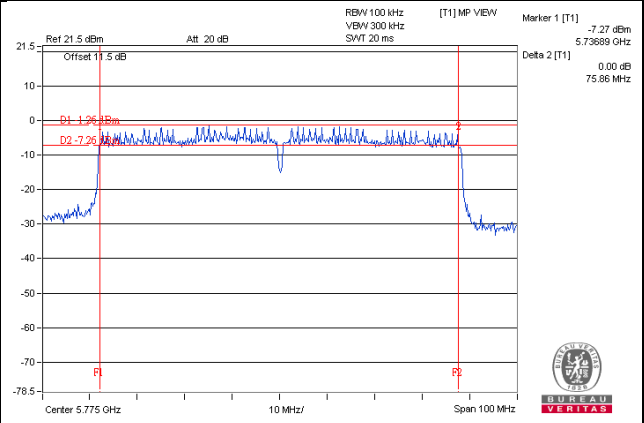

## 5 Pictures of Test Arrangements

Please refer to the attached file (Test Setup Photo).

### Annex A- Radiated Out of Band Emission (OOBE) Measurement (For U-NII-3 band)

802.11a

**CH 149 5745 MHz**

**Horizontal**

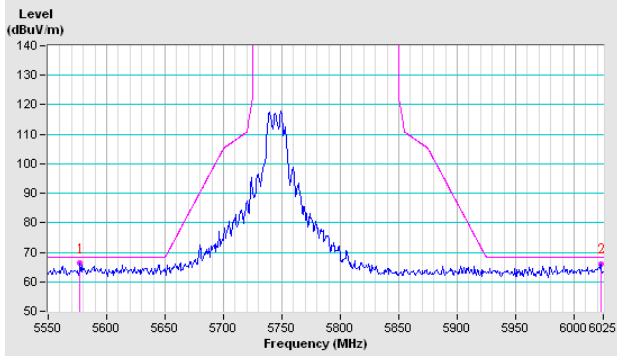

**Vertical**

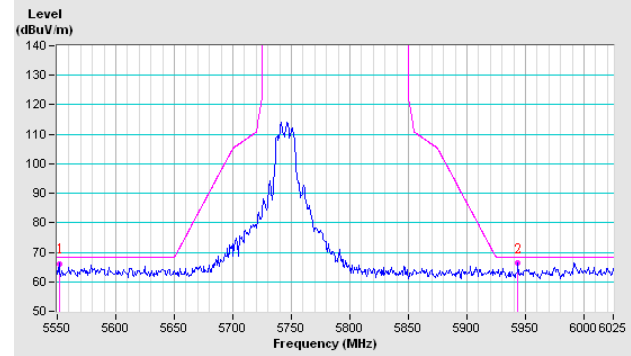

**CH 157 5785 MHz**

**Horizontal**

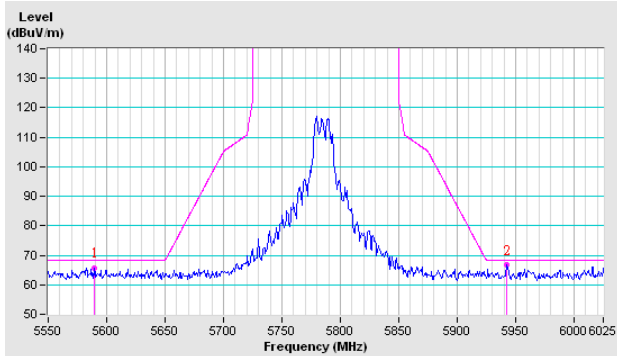

**Vertical**

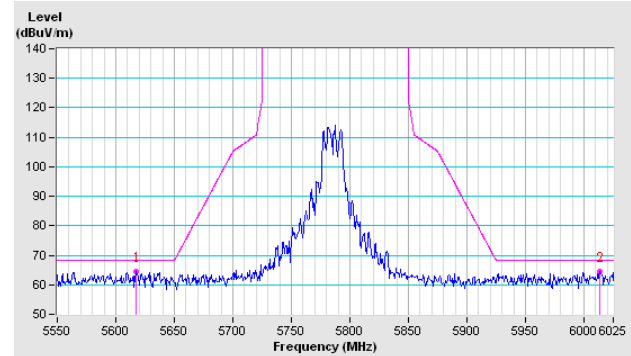

**CH 165 5825 MHz**

**Horizontal**

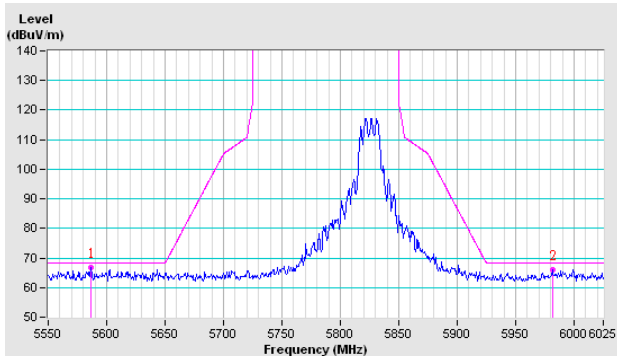

**Vertical**

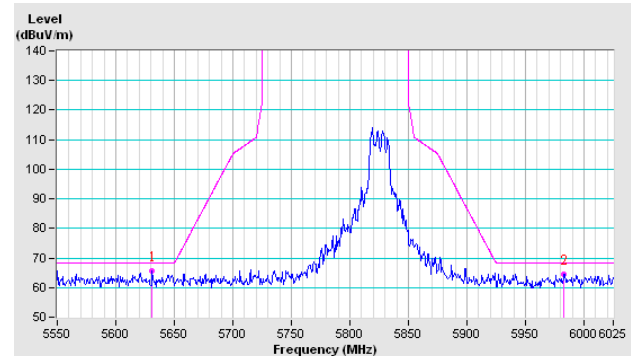

### 802.11ac (VHT20)

#### CH 149 5745 MHz

**Horizontal**

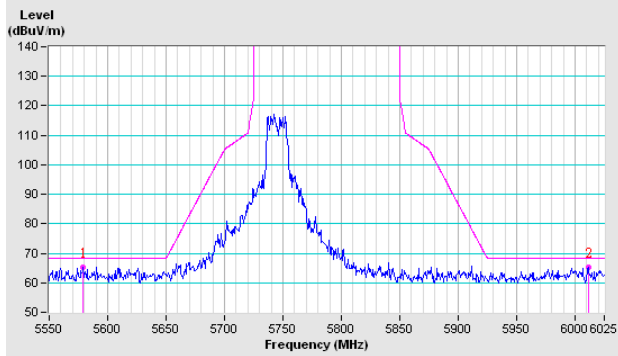

**Vertical**

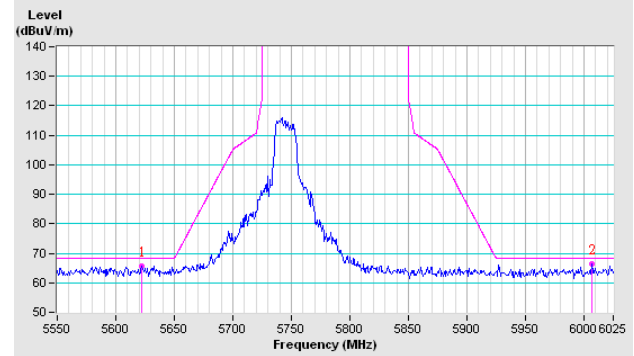

#### CH 157 5785 MHz

**Horizontal**

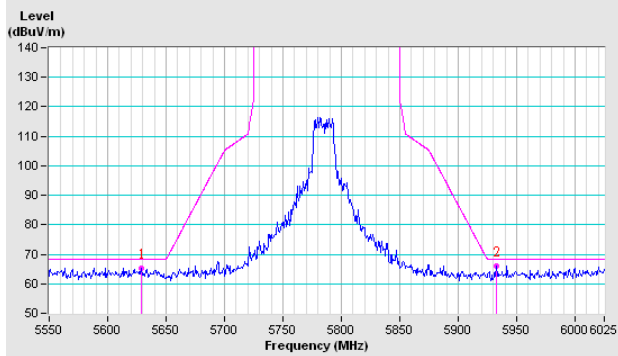

**Vertical**

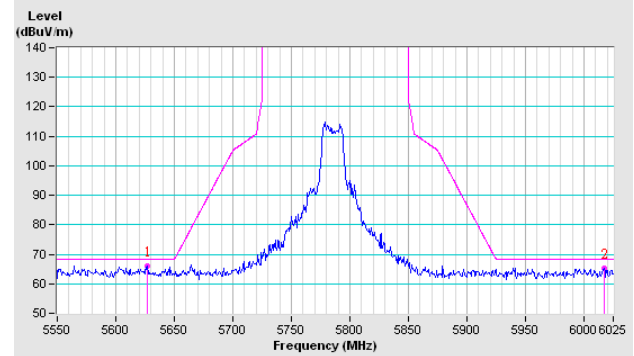

#### CH 165 5825 MHz

**Horizontal**

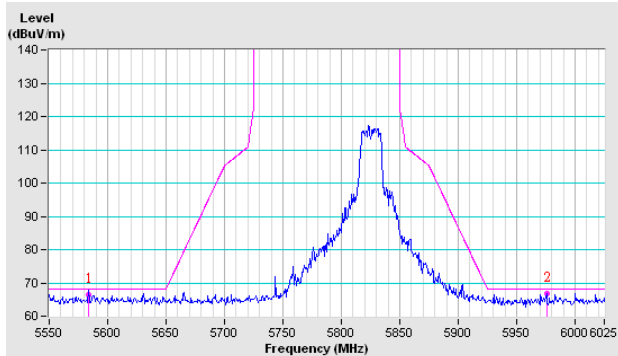

**Vertical**

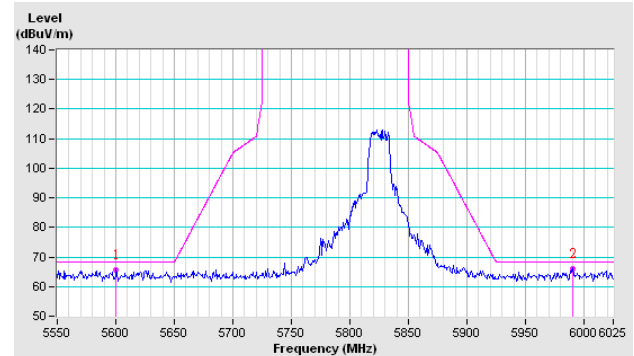

### 802.11ac (VHT40)

CH 151 5755 MHz

Horizontal

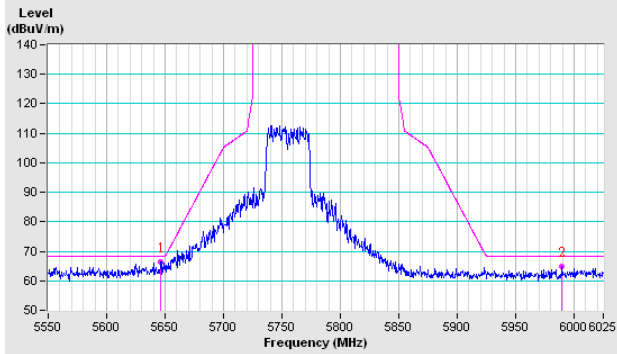

Vertical

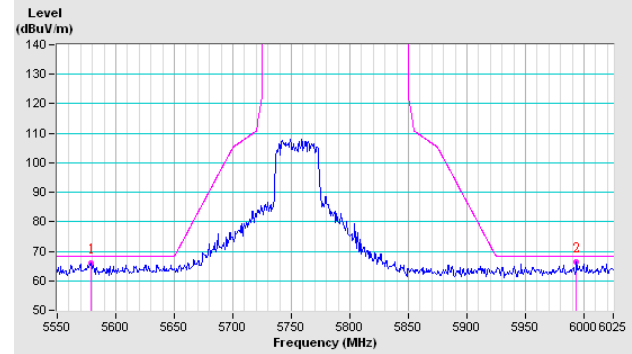

CH 159 5795 MHz

Horizontal

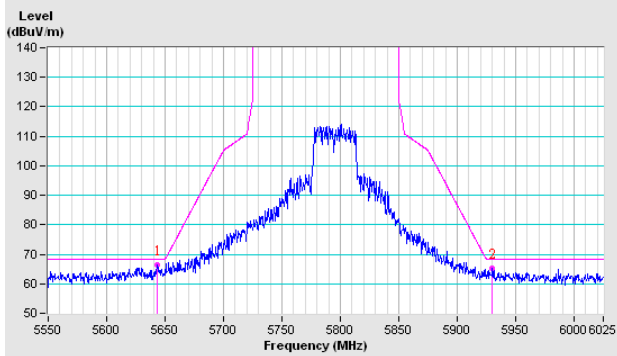

Vertical

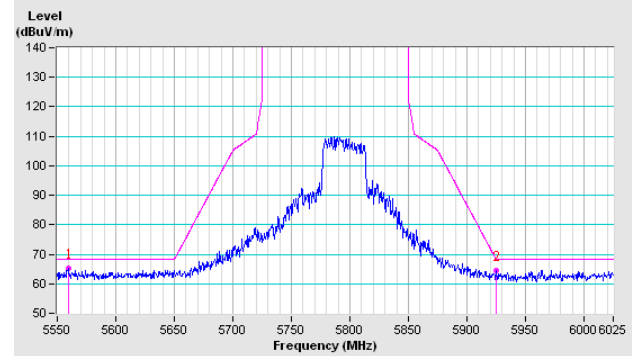

### 802.11ac (VHT80)

CH 155 5775 MHz

Horizontal

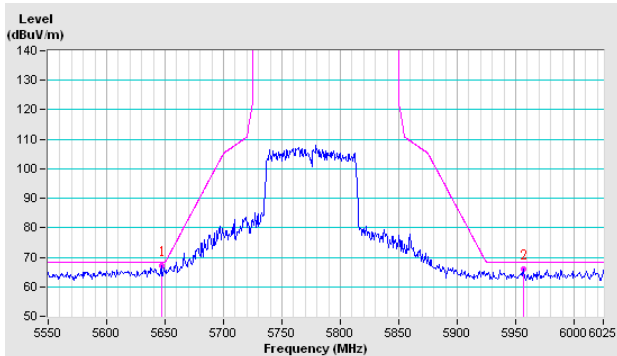

Vertical

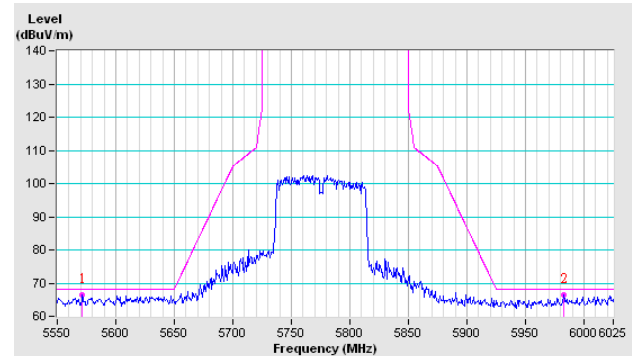



## Appendix – Information on the Testing Laboratories

We, Bureau Veritas Consumer Products Services (H.K.) Ltd., Taoyuan Branch, were founded in 1988 to provide our best service in EMC, Radio, Telecom and Safety consultation. Our laboratories are accredited and approved according to ISO/IEC 17025.

If you have any comments, please feel free to contact us at the following:

**Linko EMC/RF Lab**

Tel: 886-2-26052180

Fax: 886-2-26051924

**Hsin Chu EMC/RF/Telecom Lab**

Tel: 886-3-6668565

Fax: 886-3-6668323

**Hwa Ya EMC/RF/Safety Lab**

Tel: 886-3-3183232

Fax: 886-3-3270892

**Email:** [service.adt@tw.bureauveritas.com](mailto:service.adt@tw.bureauveritas.com)

**Web Site:** [www.bureauveritas-adt.com](http://www.bureauveritas-adt.com)

The address and road map of all our labs can be found in our web site also.

--- END ---