

FCC Test Report (WLAN)

Report No.: RF160922E02-1

FCC ID: UZ7AP7602

Test Model: AP-7602

Received Date: Sep. 22, 2016

Test Date: Nov. 05 to 16, 2016

Issued Date: Dec. 02, 2016

Applicant: Zebra Technologies Corporation

Address: One Zebra Plaza, Holtsville, NY,11742, USA

Manufacturer: Zebra Technologies Corporation

Address: One Zebra Plaza, Holtsville, NY,11742, USA

Issued By: Bureau Veritas Consumer Products Services (H.K.) Ltd., Taoyuan Branch
Hsin Chu Laboratory

Lab Address: E-2, No.1, Li Hsin 1st Road, Hsinchu Science Park, Hsinchu City 300,
Taiwan R.O.C.

Test Location (1): E-2, No.1, Li Hsin 1st Road, Hsinchu Science Park, Hsinchu City 300,
Taiwan R.O.C.

Test Location (2): No. 49, Ln. 206, Wende Rd., Shangshan Tsuen, Chiung Lin Hsiang, Hsin
Chu Hsien 307, Taiwan R.O.C.



This report is for your exclusive use. Any copying or replication of this report to or for any other person or entity, or use of our name or trademark, is permitted only with our prior written permission. This report sets forth our findings solely with respect to the test samples identified herein. The results set forth in this report are not indicative or representative of the quality or characteristics of the lot from which a test sample was taken or any similar or identical product unless specifically and expressly noted. Our report includes all of the tests requested by you and the results thereof based upon the information that you provided to us. You have 60 days from date of issuance of this report to notify us of any material error or omission caused by our negligence, provided, however, that such notice shall be in writing and shall specifically address the issue you wish to raise. A failure to raise such issue within the prescribed time shall constitute your unqualified acceptance of the completeness of this report, the tests conducted and the correctness of the report contents. Unless specific mention, the uncertainty of measurement has been explicitly taken into account to declare the compliance or non-compliance to the specification. The report must not be used by the client to claim product certification, approval, or endorsement by TAF or any government agencies.

Table of Contents

Release Control Record	4
1 Certificate of Conformity	5
2 Summary of Test Results	6
2.1 Measurement Uncertainty	6
2.2 Modification Record	6
3 General Information	7
3.1 General Description of EUT (WLAN)	7
3.2 Description of Test Modes	10
3.2.1 Test Mode Applicability and Tested Channel Detail	11
3.3 Duty Cycle of Test Signal	13
3.4 Description of Support Units	14
3.4.1 Configuration of System under Test	15
3.5 General Description of Applied Standard	17
4 Test Types and Results	18
4.1 Radiated Emission and Bandedge Measurement	18
4.1.1 Limits of Radiated Emission and Bandedge Measurement	18
4.1.2 Test Instruments	19
4.1.3 Test Procedure	21
4.1.4 Deviation from Test Standard	21
4.1.5 Test Setup	22
4.1.6 EUT Operating Condition	23
4.1.7 Test Results	24
4.2 Conducted Emission Measurement	60
4.2.1 Limits of Conducted Emission Measurement	60
4.2.2 Test Instruments	60
4.2.3 Test Procedure	61
4.2.4 Deviation from Test Standard	61
4.2.5 Test Setup	61
4.2.6 EUT Operating Condition	61
4.2.7 Test Results (Mode 1)	62
4.2.8 Test Results (Mode 2)	64
4.3 Transmit Power Measurement	66
4.3.1 Limits of Transmit Power Measurement	66
4.3.2 Test Setup	66
4.3.3 Test Instruments	66
4.3.4 Test Procedure	66
4.3.5 Deviation from Test Standard	66
4.3.6 EUT Operating Condition	66
4.3.7 Test Result	67
4.4 Occupied Bandwidth Measurement	75
4.4.1 Test Setup	75
4.4.2 Test Instruments	75
4.4.3 Test Procedure	75
4.4.4 Test Results	76
4.5 Peak Power Spectral Density Measurement	80
4.5.1 Limits of Peak Power Spectral Density Measurement	80
4.5.2 Test Setup	80
4.5.3 Test Instruments	80
4.5.4 Test Procedure	81
4.5.5 Deviation from Test Standard	81
4.5.6 EUT Operating Condition	81
4.5.7 Test Results	82
4.6 Frequency Stability Measurement	88

4.6.1	Limits of Frequency Stability Measurement	88
4.6.2	Test Setup.....	88
4.6.3	Test Instruments	88
4.6.4	Test Procedure	88
4.6.5	Deviation from Test Standard	88
4.6.6	EUT Operating Condition	88
4.6.7	Test Results	89
4.7	6dB Bandwidth Measurement	90
4.7.1	Limits of 6dB Bandwidth Measurement.....	90
4.7.2	Test Setup.....	90
4.7.3	Test Instruments	90
4.7.4	Test Procedure	90
4.7.5	Deviation from Test Standard	90
4.7.6	EUT Operating Condition	90
4.7.7	Test Results	91
5	Pictures of Test Arrangements.....	93
	Annex A- Radiated Out of Band Emission (OOBE) Measurement (For U-NII-3 band)	94
	Appendix – Information on the Testing Laboratories	97

Release Control Record

Issue No.	Description	Date Issued
RF160922E02-1	Original release.	Dec. 02, 2016

1 Certificate of Conformity

Product: Access Point

Brand: ZEBRA

Test Model: AP-7602

Sample Status: ENGINEERING SAMPLE

Applicant: Zebra Technologies Corporation

Test Date: Nov. 05 to 16, 2016

Standard: 47 CFR FCC Part 15, Subpart E (Section 15.407)
ANSI C63.10: 2013

The above equipment has been tested by **Bureau Veritas Consumer Products Services (H.K.) Ltd., Taoyuan Branch**, and found compliance with the requirement of the above standards. The test record, data evaluation & Equipment Under Test (EUT) configurations represented herein are true and accurate accounts of the measurements of the sample's EMC characteristics under the conditions specified in this report.

Prepared by : Wendy Wu , **Date:** Dec. 02, 2016
Wendy Wu / Specialist

Approved by : May Chen , **Date:** Dec. 02, 2016
May Chen / Manager

2 Summary of Test Results

47 CFR FCC Part 15, Subpart E (Section 15.407)			
FCC Clause	Test Item	Result	Remarks
15.407(b)(6)	AC Power Conducted Emissions	Pass	Meet the requirement of limit. Minimum passing margin is -13.46dB at 0.40781MHz.
15.407(b) (1/2/3/4(i/ii)/6)	Radiated Emissions & Band Edge Measurement*	Pass	Meet the requirement of limit. Minimum passing margin is -1.1dB at 5150.00MHz, 5635.98MHz.
15.407(a)(1/2/3)	Max Average Transmit Power	Pass	Meet the requirement of limit.
---	Occupied Bandwidth Measurement	-	Reference only.
15.407(a)(1/2/3)	Peak Power Spectral Density	Pass	Meet the requirement of limit.
15.407(e)	6dB bandwidth	Pass	Meet the requirement of limit. (U-NII-3 Band only)
15.407(g)	Frequency Stability	Pass	Meet the requirement of limit.
15.203	Antenna Requirement	Pass	Antenna connector is i-pex(MHF) not a standard connector.

*For U-NII-3 band compliance with rule part 15.407(b)(4)(i), the OOB test plots were recorded in Annex A.

2.1 Measurement Uncertainty

Where relevant, the following measurement uncertainty levels have been estimated for tests performed on the EUT as specified in CISPR 16-4-2:

Measurement	Frequency	Expanded Uncertainty (k=2) (\pm)
Conducted Emissions at mains ports	150kHz ~ 30MHz	1.83 dB
Radiated Emissions up to 1 GHz	30MHz ~ 1GHz	5.43 dB
Radiated Emissions above 1 GHz	1GHz ~ 6GHz	3.41 dB
	6GHz ~ 18GHz	4.49 dB
	18GHz ~ 40GHz	3.30 dB

2.2 Modification Record

There were no modifications required for compliance.

3 General Information

3.1 General Description of EUT (WLAN)

Product	Access Point
Brand	ZEBRA
Test Model	AP-7602
Status of EUT	ENGINEERING SAMPLE
SW Version	esdk 5.0.9.1
HW Version	ZEBRA_ASPEN-W_BCM47452_v21_d2_20160803_Sandy.brd
Power Supply Rating	12Vdc from power adapter or 55Vdc from POE
Modulation Type	CCK, DQPSK, DBPSK for DSSS 64QAM, 16QAM, QPSK, BPSK for OFDM 256QAM for OFDM in 11ac mode and VHT20/40 mode in 2.4GHz band
Modulation Technology	DSSS, OFDM
Transfer Rate	802.11b: up to 11Mbps 802.11a/g: up to 54Mbps 802.11n: up to 300Mbps 802.11ac: up to 866.7Mbps
Operating Frequency	2.4GHz: 2.412 ~ 2.462GHz 5GHz: 5.18 ~ 5.24GHz, 5.745 ~ 5.825GHz
Number of Channel	2.4GHz: 802.11b, 802.11g, 802.11n (HT20), VHT20: 11 802.11n (HT40), VHT40: 7 5GHz: 802.11a, 802.11n (HT20), 802.11ac (VHT20): 9 802.11n (HT40), 802.11ac (VHT40): 4 802.11ac (VHT80): 2
Output Power	2.4GHz: CDD Mode: 183.039mW Beamforming Mode: 105.547mW 5GHz: 5.18GHz ~ 5.24GHz: CDD Mode: 194.249mW Beamforming Mode: 189.641mW 5.745GHz ~ 5.825GHz: CDD Mode: 260.394mW Beamforming Mode: 260.394mW
Antenna Type	Refer to Note
Antenna Connector	Refer to Note
Accessory Device	NA
Data Cable Supplied	NA

Note:

1. There are WLAN, BT technology used for the EUT.
2. Simultaneously transmission condition.

Condition	Technology		
1	WLAN (2.4GHz-Chain0)	WLAN (5GHz-Chain1)	BT
2	WLAN (2.4GHz-Chain1)	WLAN (5GHz-Chain0)	BT
3	WLAN (2.4GHz-Chain0)	WLAN (2.4GHz-Chain1)	BT
4	WLAN (5GHz-Chain0)	WLAN (5GHz-Chain1)	BT

Note: The emission of the simultaneous operation has been evaluated and no non-compliance was found.

3. The EUT must be supplied with a power adapter and POE as following table:

Adapter (Only for test not for sale)		
Brand	Model No.	Spec.
HIPRO	HP-A0502R3D	Input: 100-240Vac, 50-60Hz, 2.4A Output: 12Vdc, 4.16A DC output cable (Unshielded, 1.8m with one core)
POE(Only for test not for sale)		
Brand	Model No.	Spec.
Symbol	PD-9001GR/AT/AC	Input: 100-240Vac, 50/60Hz, 0.67A Output: 55Vdc, 0.6A P/N : AP-PSBIAS-2P3-ATR

From above adapters and POE, the radiated emission worst case was found in **POE**. Therefore only the test data of the modes were recorded in this report individually.

4. The antennas provided to the EUT, please refer to the following table:

No.	PCB Chain No	Brand	Model	Antenna Gain(dBi) Including cable loss	Frequency range	Antenna Type	Connector type	Cable Length (mm)
1	Chain 0	NA	NA	2.61	2.4~2.4835GHz	Dipole	i-pex(MHF)	155
				4.39	5.15~5.25GHz			
				4.2	5.25~5.35GHz			
				4.28	5.47~5.725GHz			
				5.61	5.725~5.85GHz			
2	Chain 1	NA	NA	3.76	2.4~2.4835GHz	Dipole	i-pex(MHF)	182
				5.18	5.15~5.25GHz			
				5.22	5.25~5.35GHz			
				4.44	5.47~5.725GHz			
				5.95	5.725~5.85GHz			
3	BT	NA	NA	1.8	2.4~2.483GHz	Dipole	i-pex(MHF)	88

5. The EUT incorporates a MIMO function:

2.4GHz Band			
MODULATION MODE	DATA RATE (MCS)	TX & RX CONFIGURATION	
802.11b	1 ~ 11Mbps	2TX/1TX diversity	2RX
802.11g	6 ~ 54Mbps	2TX/1TX diversity	2RX
802.11n (HT20)	MCS 0~7	2TX/1TX diversity	2RX
	MCS 8~15	2TX	2RX
802.11n (HT40)	MCS 0~7	2TX/1TX diversity	2RX
	MCS 8~15	2TX	2RX
VHT20	MCS 0~8, Nss=1	2TX/1TX diversity	2RX
	MCS 0~8, Nss=2	2TX	2RX
VHT40	MCS 0~9, Nss=1	2TX/1TX diversity	2RX
	MCS 0~9, Nss=2	2TX	2RX
5GHz Band			
MODULATION MODE	DATA RATE (MCS)	TX & RX CONFIGURATION	
802.11a	6 ~ 54Mbps	2TX/1TX diversity	2RX
802.11n (HT20)	MCS 0~7	2TX/1TX diversity	2RX
	MCS 8~15	2TX	2RX
802.11n (HT40)	MCS 0~7	2TX/1TX diversity	2RX
	MCS 8~15	2TX	2RX
802.11ac (VHT20)	MCS 0~8, Nss=1	2TX/1TX diversity	2RX
	MCS 0~8, Nss=2	2TX	2RX
802.11ac (VHT40)	MCS 0~9, Nss=1	2TX/1TX diversity	2RX
	MCS 0~9, Nss=2	2TX	2RX
802.11ac (VHT80)	MCS 0~9, Nss=1	2TX/1TX diversity	2RX
	MCS 0~9, Nss=2	2TX	2RX

Note:

1. All of modulation mode support beamforming function except 802.11a/b/g modulation mode.
2. The modulation and bandwidth are similar for 802.11n mode for 20MHz (40MHz) and 802.11ac mode for 20MHz (40MHz), therefore investigated worst case to representative mode in test report. (Final test mode refer section 3.2.1)
3. The EUT support diversity parameter for 1TX mode, the 1TX output power will remain the same as per chain of 2TX parameter, and all test items were performed by 2TX mode.

6. The above EUT information is declared by manufacturer and for more detailed features description, please refer to the manufacturer's specifications or user's manual.

3.2 Description of Test Modes

FOR 5180 ~ 5240MHz

4 channels are provided for 802.11a, 802.11n (HT20), 802.11ac (VHT20):

Channel	Frequency	Channel	Frequency
36	5180 MHz	44	5220 MHz
40	5200 MHz	48	5240 MHz

2 channels are provided for 802.11n (HT40), 802.11ac (VHT40):

Channel	Frequency	Channel	Frequency
38	5190 MHz	46	5230 MHz

1 channel is provided for 802.11ac (VHT80):

Channel	Frequency
42	5210MHz

FOR 5745 ~ 5825MHz:

5 channels are provided for 802.11a, 802.11n (HT20), 802.11ac (VHT20):

Channel	Frequency	Channel	Frequency
149	5745MHz	161	5805MHz
153	5765MHz	165	5825MHz
157	5785MHz		

2 channels are provided for 802.11n (HT40), 802.11ac (VHT40):

Channel	Frequency	Channel	Frequency
151	5755MHz	159	5795MHz

1 channel is provided for 802.11ac (VHT80):

Channel	Frequency
155	5775MHz

3.2.1 Test Mode Applicability and Tested Channel Detail

EUT Configure Mode	Applicable To				Description
	RE \geq 1G	RE<1G	PLC	APCM	
1	√	√	√	√	Power from adapter
2	-	-	√	-	Power from POE

Where **RE \geq 1G**: Radiated Emission above 1GHz **RE<1G**: Radiated Emission below 1GHz
PLC: Power Line Conducted Emission **APCM**: Antenna Port Conducted Measurement

NOTE:

1. The EUT had been pre-tested on the positioned of each 2 axis. The worst case was found when positioned on **Y-plane**.
2. "-" means no effect.

Radiated Emission Test (Above 1GHz):

- Pre-Scan has been conducted to determine the worst-case mode from all possible combinations between available modulations, data rates and antenna ports (if EUT with antenna diversity architecture).
- Following channel(s) was (were) selected for the final test as listed below.

CDD Mode						
Mode	FREQ. Band (MHz)	Available Channel	Tested Channel	Modulation Technology	Modulation Type	Data Rate (Mbps)
802.11a	5180-5240	36 to 48	36, 40, 48	OFDM	BPSK	6
802.11ac (VHT20)		36 to 48	36, 40, 48	OFDM	BPSK	6.5
802.11ac (VHT40)		38 to 46	38, 46	OFDM	BPSK	13.5
802.11ac (VHT80)		42	42	OFDM	BPSK	29.3
802.11a	5745-5825	149 to 165	149, 157, 165	OFDM	BPSK	6
802.11ac (VHT20)		149 to 165	149, 157, 165	OFDM	BPSK	6.5
802.11ac (VHT40)		151 to 159	151, 159	OFDM	BPSK	13.5
802.11ac (VHT80)		155	155	OFDM	BPSK	29.3

Radiated Emission Test (Below 1GHz):

- Pre-Scan has been conducted to determine the worst-case mode from all possible combinations between available modulations, data rates and antenna ports (if EUT with antenna diversity architecture).
- Following channel(s) was (were) selected for the final test as listed below.

CDD Mode						
Mode	FREQ. Band (MHz)	Available Channel	Tested Channel	Modulation Technology	Modulation Type	Data Rate (Mbps)
802.11a	5180-5240	36 to 48	36, 40, 48	OFDM	BPSK	6
802.11ac (VHT20)		36 to 48	36, 40, 48	OFDM	BPSK	6.5
802.11ac (VHT40)		38 to 46	38, 46	OFDM	BPSK	13.5
802.11ac (VHT80)		42	42	OFDM	BPSK	29.3
802.11a	5745-5825	149 to 165	149, 157, 165	OFDM	BPSK	6
802.11ac (VHT20)		149 to 165	149, 157, 165	OFDM	BPSK	6.5
802.11ac (VHT40)		151 to 159	151, 159	OFDM	BPSK	13.5
802.11ac (VHT80)		155	155	OFDM	BPSK	29.3

Power Line Conducted Emission Test:

- Pre-Scan has been conducted to determine the worst-case mode from all possible combinations between available modulations, data rates and antenna ports (if EUT with antenna diversity architecture).
- Following channel(s) was (were) selected for the final test as listed below.

CDD Mode						
Mode	FREQ. Band (MHz)	Available Channel	Tested Channel	Modulation Technology	Modulation Type	Data Rate (Mbps)
802.11ac (VHT20)	5745-5825	149 to 165	157	OFDM	BPSK	6.5

Antenna Port Conducted Measurement:

- This item includes all test value of each mode, but only includes spectrum plot of worst value of each mode.
- Pre-Scan has been conducted to determine the worst-case mode from all possible combinations between available modulations, data rates and antenna ports (if EUT with antenna diversity architecture).
- Following channel(s) was (were) selected for the final test as listed below.

CDD Mode						
Mode	FREQ. Band (MHz)	Available Channel	Tested Channel	Modulation Technology	Modulation Type	Data Rate (Mbps)
802.11a	5180-5240	36 to 48	36, 40, 48	OFDM	BPSK	6
802.11ac (VHT20)		36 to 48	36, 40, 48	OFDM	BPSK	6.5
802.11ac (VHT40)		38 to 46	38, 46	OFDM	BPSK	13.5
802.11ac (VHT80)		42	42	OFDM	BPSK	29.3
802.11a	5745-5825	149 to 165	149, 157, 165	OFDM	BPSK	6
802.11ac (VHT20)		149 to 165	149, 157, 165	OFDM	BPSK	6.5
802.11ac (VHT40)		151 to 159	151, 159	OFDM	BPSK	13.5
802.11ac (VHT80)		155	155	OFDM	BPSK	29.3
Beamforming Mode (Output power only)						
Mode	FREQ. Band (MHz)	Available Channel	Tested Channel	Modulation Technology	Modulation Type	Data Rate (Mbps)
802.11ac (VHT20)	5180-5240	36 to 48	36, 40, 48	OFDM	BPSK	6.5
802.11ac (VHT40)		38 to 46	38, 46	OFDM	BPSK	13.5
802.11ac (VHT80)		42	42	OFDM	BPSK	29.3
802.11ac (VHT20)	5745-5825	149 to 165	149, 157, 165	OFDM	BPSK	6.5
802.11ac (VHT40)		151 to 159	151, 159	OFDM	BPSK	13.5
802.11ac (VHT80)		155	155	OFDM	BPSK	29.3

Test Condition:

Applicable To	Environmental Conditions	Input Power	Tested By
RE \geq 1G	23deg. C, 73%RH	120Vac, 60Hz	Jyunchun Lin
RE $<$ 1G	24deg. C, 66%RH	120Vac, 60Hz	Jyunchun Lin
PLC	25deg. C, 60%RH	120Vac, 60Hz	Eagle Chen
APCM	25deg. C, 60%RH	120Vac, 60Hz	Gary Cheng

3.3 Duty Cycle of Test Signal

If duty cycle of test signal is $\geq 98\%$, duty factor is not required.

If duty cycle of test signal is $< 98\%$, duty factor is required

802.11a: Duty cycle = $2.064/2.084 = 0.99$

802.11ac (VHT20): Duty cycle = $1.927/1.947 = 0.99$

802.11ac (VHT40): Duty cycle = $0.953/0.954 = 0.999$

802.11ac (VHT80): Duty cycle = $0.46/0.48 = 0.958$, Duty factor = $10 * \log(1/0.958) = 0.18$

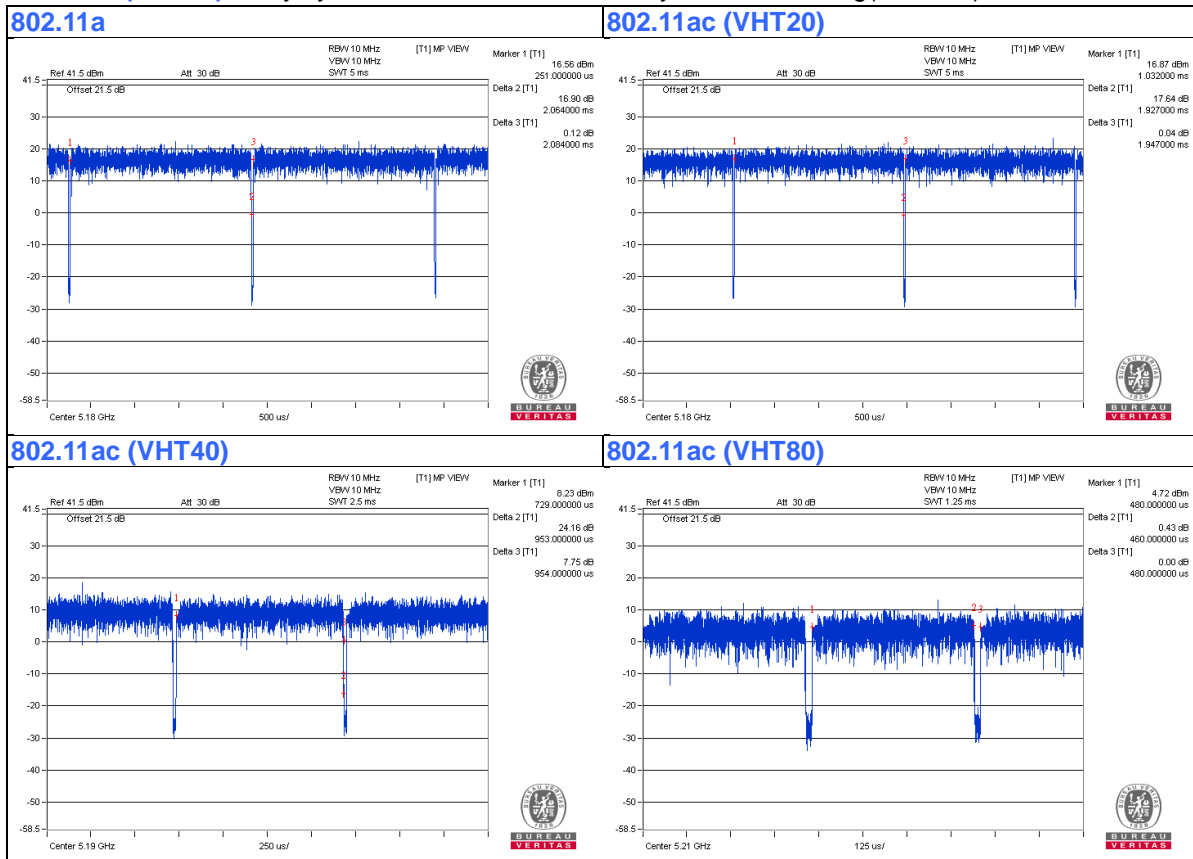

3.4 Description of Support Units

The EUT has been tested as an independent unit together with other necessary accessories or support units. The following support units or accessories were used to form a representative test configuration during the tests.

ID	Product	Brand	Model No.	Serial No.	FCC ID	Remarks
A.	Laptop	DELL	E5430	HYV4VY1	FCC DoC	Provided by Lab
B.	POE	Symbol	PD-9001GR/AT/AC	NA	NA	Supplied by client
C.	HUB	ZyXEL	ES-116P	S060H02000215	FCC DoC	Provided by Lab
D.	Adapter	HIPRO	HP-A0502R3D	NA	NA	Supplied by client

Note:

1. All power cords of the above support units are non-shielded (1.8m).

ID	Descriptions	Qty.	Length (m)	Shielding (Yes/No)	Cores (Qty.)	Remarks
1.	RJ-45 Cable	1	10	No	0	Provided by Lab
2.	RJ-45 Cable	1	10	No	0	Provided by Lab
3.	RJ-45 Cable	1	1	No	0	Provided by Lab
4.	DC Cable	1	1.8	No	1	Supplied by client
5.	AC Cable	1	1.8	No	0	Provided by Lab

Note: The core(s) is(are) originally attached to the cable(s).

3.4.1 Configuration of System under Test

Adapter Mode:

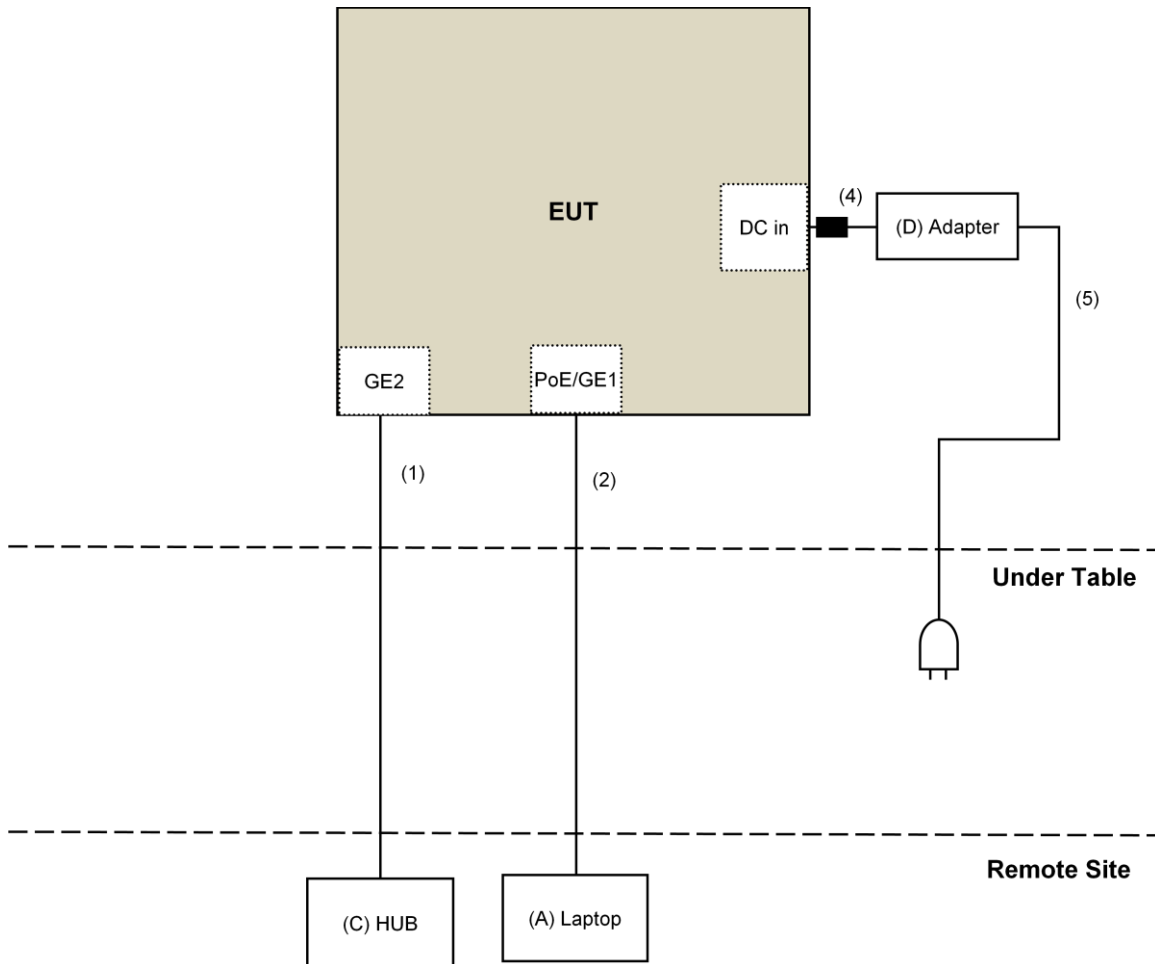

POE Mode

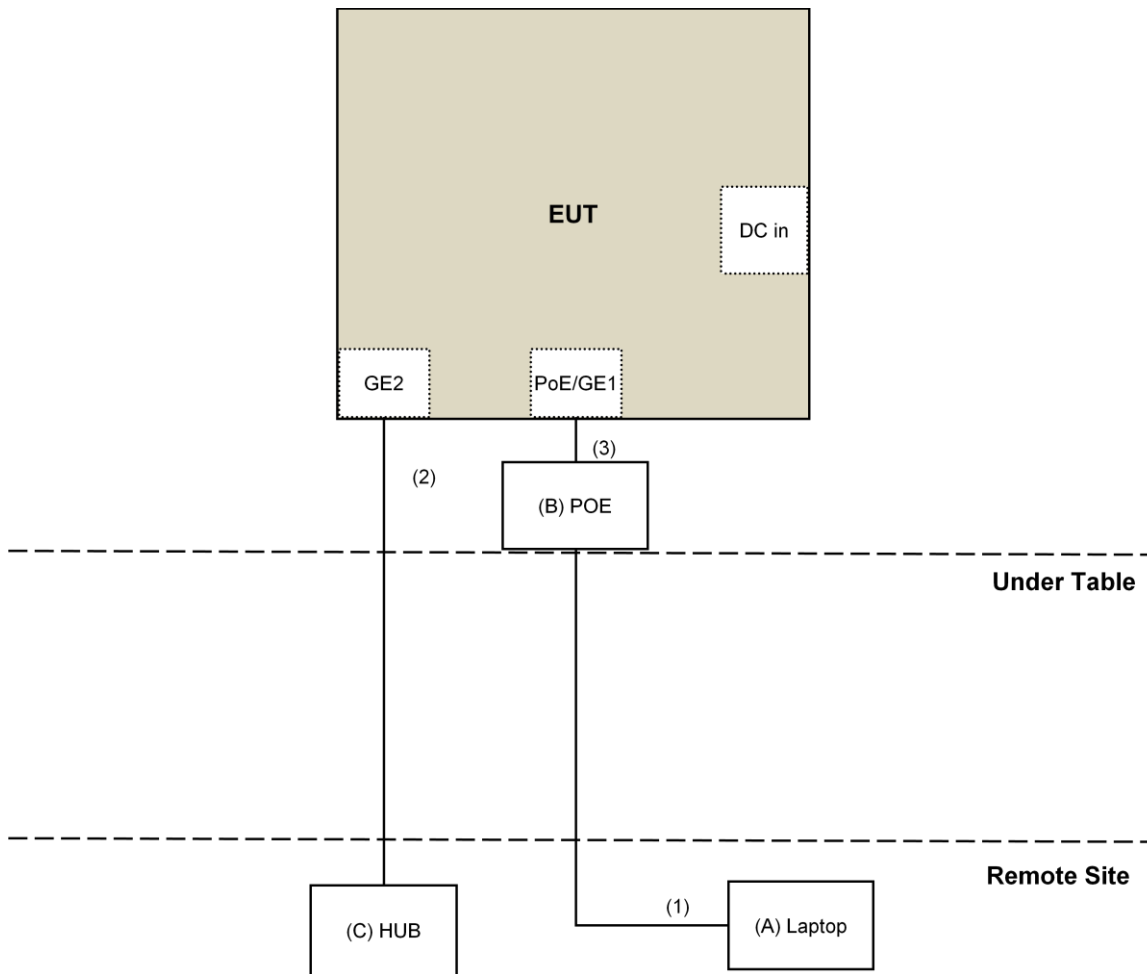

3.5 General Description of Applied Standard

The EUT is a RF Product. According to the specifications of the manufacturer, it must comply with the requirements of the following standards:

FCC Part 15, Subpart E (15.407)
KDB 789033 D02 General UNII Test Procedure New Rules v01r03
KDB 662911 D01 Multiple Transmitter Output v02r01
ANSI C63.10-2013

All test items have been performed and recorded as per the above standards.

NOTE: The EUT has been verified to comply with the requirements of FCC Part 15, Subpart B, Class B (DoC). The test report has been issued separately.

4 Test Types and Results

4.1 Radiated Emission and Bandedge Measurement

4.1.1 Limits of Radiated Emission and Bandedge Measurement

Radiated emissions which fall in the restricted bands must comply with the radiated emission limits specified as below table.

Frequencies (MHz)	Field Strength (microvolts/meter)	Measurement Distance (meters)
0.009 ~ 0.490	2400/F(kHz)	300
0.490 ~ 1.705	24000/F(kHz)	30
1.705 ~ 30.0	30	30
30 ~ 88	100	3
88 ~ 216	150	3
216 ~ 960	200	3
Above 960	500	3

NOTE:

1. The lower limit shall apply at the transition frequencies.
2. Emission level (dBuV/m) = 20 log Emission level (uV/m).
3. For frequencies above 1000MHz, the field strength limits are based on average detector, however, the peak field strength of any emission shall not exceed the maximum permitted average limits, specified above by more than 20dB under any condition of modulation.

Limits of unwanted emission out of the restricted bands

Applicable To		Limit	
789033 D02 General UNII Test Procedure New Rules v01r03		Field Strength at 3m	
		PK:74 (dBµV/m)	AV:54 (dBµV/m)
Frequency Band	Applicable To	EIRP Limit	Equivalent Field Strength at 3m
5150~5250 MHz	15.407(b)(1)	PK:-27 (dBm/MHz)	PK:68.2(dBµV/m)
5250~5350 MHz	15.407(b)(2)		
5470~5725 MHz	15.407(b)(3)		
5725~5850 MHz	<input checked="" type="checkbox"/> 15.407(b)(4)(i)	PK:-27 (dBm/MHz) ^{*1} PK:10 (dBm/MHz) ^{*2} PK:15.6 (dBm/MHz) ^{*3} PK:27 (dBm/MHz) ^{*4}	PK: 68.2(dBµV/m) ^{*1} PK:105.2 (dBµV/m) ^{*2} PK: 110.8(dBµV/m) ^{*3} PK:122.2 (dBµV/m) ^{*4}
	<input type="checkbox"/> 15.407(b)(4)(ii)	Emission limits in section 15.247(d)	
^{*1} beyond 75 MHz or more above of the band edge.		^{*2} below the band edge increasing linearly to 10 dBm/MHz at 25 MHz above.	
^{*3} below the band edge increasing linearly to a level of 15.6 dBm/MHz at 5 MHz above.		^{*4} from 5 MHz above or below the band edge increasing linearly to a level of 27 dBm/MHz at the band edge.	

Note:

The following formula is used to convert the equipment isotropic radiated power (eirp) to field strength:

$$E = \frac{1000000\sqrt{30P}}{3} \mu\text{V/m, where } P \text{ is the eirp (Watts).}$$

4.1.2 Test Instruments

For Radiated Emission above 1GHz test:

DESCRIPTION & MANUFACTURER	MODEL NO.	SERIAL NO.	CALIBRATED DATE	CALIBRATED UNTIL
Test Receiver Keysight	N9038A	MY54450088	July 20, 2016	July 19, 2017
Horn_Antenna SCHWARZBECK	BBHA 9120D	9120D-783	Jan. 19, 2016	Jan. 18, 2017
Pre-Amplifier Agilent	8449B	3008A01922	Sep. 18, 2016	Sep. 17, 2017
RF Cable	EMC104-SM-SM-2000 EMC104-SM-SM-5000 EMC104-SM-SM-5000	150318 150323 150324	Mar. 30, 2016	Mar. 29, 2017
Pre-Amplifier EMCI	EMC184045	980143	Jan. 15, 2016	Jan. 14, 2017
Horn_Antenna SCHWARZBECK	BBHA 9170	BBHA9170608	Jan. 08, 2016	Jan. 07, 2017
RF Cable	SUCOFLEX 102	36432/2 36441/2	Jan. 16, 2016	Jan. 15, 2017
Software	ADT_Radiated_V8.7.08	NA	NA	NA
Antenna Tower & Turn Table Max-Full	MF-7802	MF780208410	NA	NA
Boresight Antenna Fixture	FBA-01	FBA-SIP02	NA	NA

Note:

1. The calibration interval of the above test instruments is 12 months and the calibrations are traceable to NML/ROC and NIST/USA.
2. *The calibration interval of the above test instruments is 24 months and the calibrations are traceable to NML/ROC and NIST/USA.
3. The test was performed in 966 Chamber No. 4.
4. The FCC Site Registration No. is 292998
5. The CANADA Site Registration No. is 20331-2
6. Tested Date: Nov. 05, 2016

For other test:

DESCRIPTION & MANUFACTURER	MODEL NO.	SERIAL NO.	CALIBRATED DATE	CALIBRATED UNTIL
Test Receiver Keysight	N9038A	MY54450088	July 20, 2016	July 19, 2017
Pre-Amplifier ^(*) EMCI	EMC001340	980142	Jan. 20, 2016	Jan. 19, 2018
Loop Antenna ^(*) Electro-Metrics	EM-6879	264	Dec. 16, 2014	Dec. 15, 2016
RF Cable	NA	LOOPCAB-001 LOOPCAB-002	Jan. 18, 2016	Jan. 17, 2017
Pre-Amplifier Mini-Circuits	ZFL-1000VH2B	AMP-ZFL-01	Nov. 10, 2016	Nov. 09, 2017
Trilog Broadband Antenna SCHWARZBECK	VULB 9168	9168-406	Jan. 04, 2016	Jan. 03, 2017
RF Cable	8D	966-4-1 966-4-2 966-4-3	Apr. 02, 2016	Apr. 01, 2017
Fixed attenuator Mini-Circuits	UNAT-5+	PAD-3m-4-01	Oct. 05, 2016	Oct. 04, 2017
Software	ADT_Radiated_V8.7.08	NA	NA	NA
Antenna Tower & Turn Table Max-Full	MF-7802	MF780208410	NA	NA
Boresight Antenna Fixture	FBA-01	FBA-SIP02	NA	NA
Spectrum Analyzer R&S	FSV40	100964	June 28, 2016	June 27, 2017
Power meter Anritsu	ML2495A	0824006	May 26, 2016	May 25, 2017
Power sensor Anritsu	MA2411B	0738172	May 26, 2016	May 25, 2017
AC Power Source Extech Electronics	6205	1440452	NA	NA
Temperature & Humidity Chamber Giant Force	GTH-150-40-SP-AR	MAA0812-008	Jan. 15, 2016	Jan. 14, 2017
Digital Multimeter FLUKE	87III	73680266	Nov. 10, 2016	Nov. 09, 2017

Note:

1. The calibration interval of the above test instruments is 12 months and the calibrations are traceable to NML/ROC and NIST/USA.
2. *The calibration interval of the above test instruments is 24 months and the calibrations are traceable to NML/ROC and NIST/USA.
3. The test was performed in 966 Chamber No. 4.
4. The FCC Site Registration No. is 292998
5. The CANADA Site Registration No. is 20331-2
6. Loop antenna was used for all emissions below 30 MHz.
7. Tested Date: Nov. 12 to 16, 2016

4.1.3 Test Procedure

For Radiated emission below 30MHz

- a. The EUT was placed on the top of a rotating table 0.8 meters above the ground at a 3 meter chamber room. The table was rotated 360 degrees to determine the position of the highest radiation.
- b. The EUT was set 3 meters away from the interference-receiving antenna, which was mounted on the top of a variable-height antenna tower.
- c. Both X and Y axes of the antenna are set to make the measurement.
- d. For each suspected emission, the EUT was arranged to its worst case and the rotatable table was turned from 0 degrees to 360 degrees to find the maximum reading.
- e. The test-receiver system was set to Quasi-Peak Detect Function and Specified Bandwidth with Maximum Hold Mode.

NOTE:

1. The resolution bandwidth and video bandwidth of test receiver/spectrum analyzer is 9kHz at frequency below 30MHz.

For Radiated emission above 30MHz

- a. The EUT was placed on the top of a rotating table 0.8 meters (for 30MHz ~ 1GHz) / 1.5 meters (for above 1GHz) above the ground at 3 meter chamber room for test. The table was rotated 360 degrees to determine the position of the highest radiation.
- b. The EUT was set 3 meters away from the interference-receiving antenna, which was mounted on the top of a variable-height antenna tower.
- c. The height of antenna is varied from one meter to four meters above the ground to determine the maximum value of the field strength. Both horizontal and vertical polarizations of the antenna are set to make the measurement.
- d. For each suspected emission, the EUT was arranged to its worst case and then the antenna was tuned to heights from 1 meter to 4 meters and the rotatable table was turned from 0 degrees to 360 degrees to find the maximum reading.
- e. The test-receiver system was set to quasi-peak detect function and specified bandwidth with maximum hold mode when the test frequency is below 1 GHz.
- f. The test-receiver system was set to peak and average detect function and specified bandwidth with maximum hold mode when the test frequency is above 1 GHz. If the peak reading value also meets average limit, measurement with the average detector is unnecessary.

Note:

1. The resolution bandwidth and video bandwidth of test receiver/spectrum analyzer is 120kHz for Quasi-peak detection (QP) at frequency below 1GHz.
2. The resolution bandwidth of test receiver/spectrum analyzer is 1 MHz and the video bandwidth is 3 MHz for Peak detection (PK) at frequency above 1GHz.
3. The resolution bandwidth of test receiver/spectrum analyzer is 1MHz and the video bandwidth is $\geq 1/T$ (Duty cycle < 98%) or 10Hz (Duty cycle $\geq 98\%$) for Average detection (AV) at frequency above 1GHz.
4. All modes of operation were investigated and the worst-case emissions are reported.

4.1.4 Deviation from Test Standard

No deviation.

4.1.5 Test Setup

For Radiated emission below 30MHz

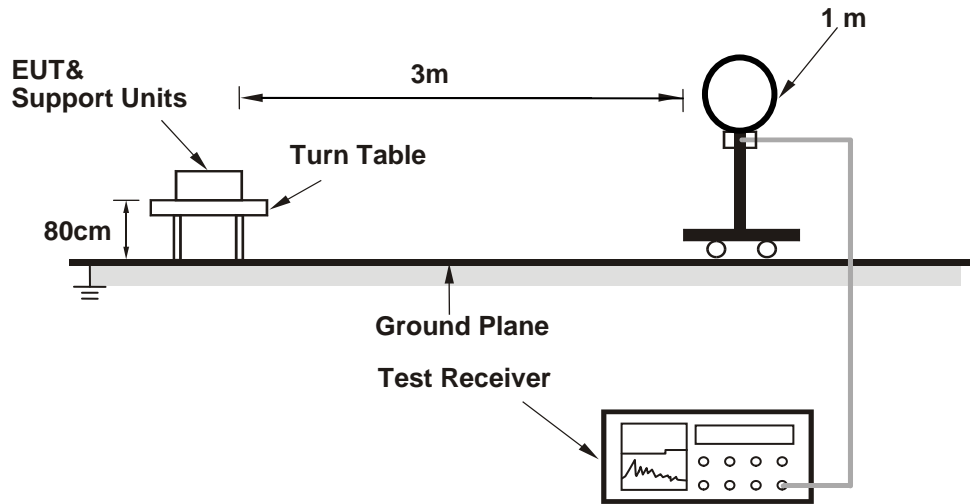

For Radiated emission 30MHz to 1GHz

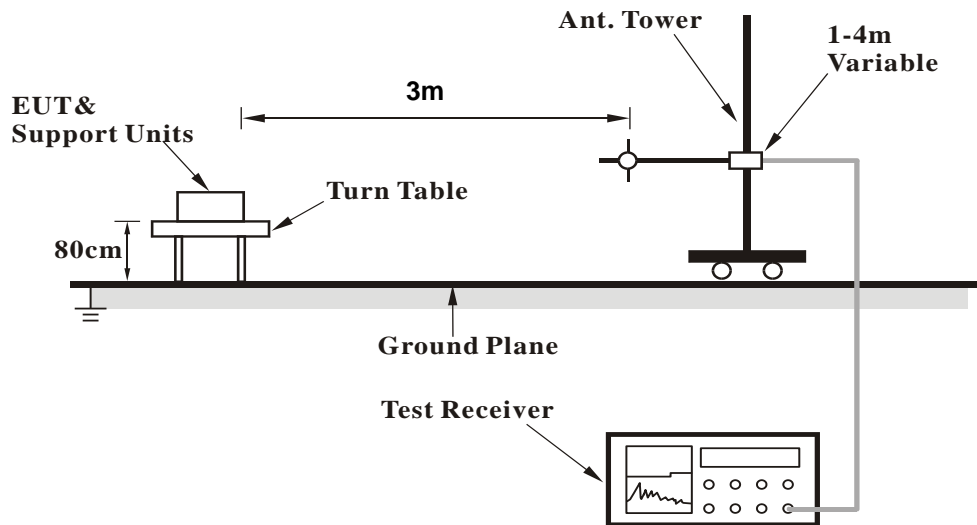

For Radiated emission above 1GHz

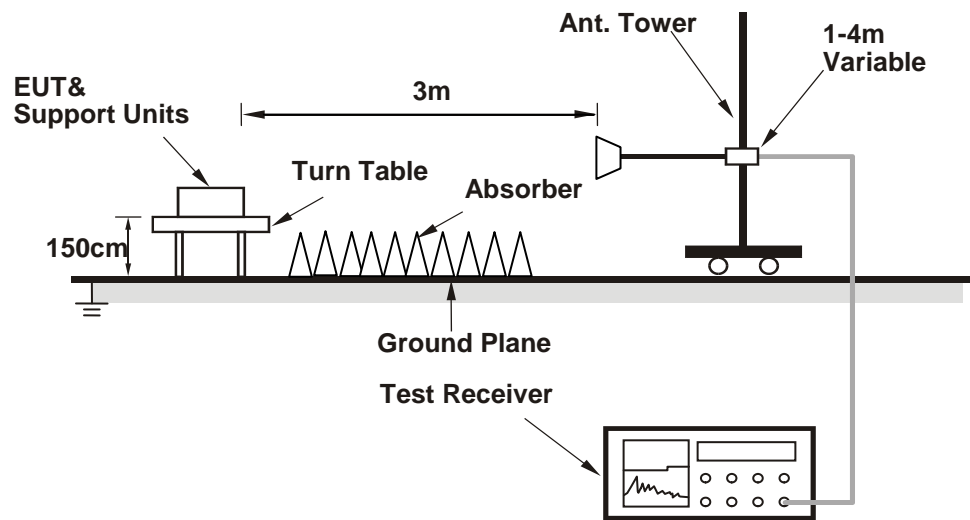

For the actual test configuration, please refer to the attached file (Test Setup Photo).

4.1.6 EUT Operating Condition

- a. Connected the EUT with the Laptop which is placed on remote site.
- b. Controlling software (MTool.exe Ver.2.0.2.7) has been activated to set the EUT on specific status.

4.1.7 Test Results

Above 1GHz Data:

802.11a

CHANNEL	TX Channel 36	DETECTOR FUNCTION	Peak (PK)
FREQUENCY RANGE	1GHz ~ 40GHz		Average (AV)

ANTENNA POLARITY & TEST DISTANCE: HORIZONTAL AT 3 M								
NO.	FREQ. (MHz)	EMISSION LEVEL (dBuV/m)	LIMIT (dBuV/m)	MARGIN (dB)	ANTENNA HEIGHT (m)	TABLE ANGLE (Degree)	RAW VALUE (dBuV)	CORRECTION FACTOR (dB/m)
1	5150.00	65.6 PK	74.0	-8.4	1.46 H	50	64.1	1.5
2	5150.00	46.6 AV	54.0	-7.4	1.46 H	50	45.1	1.5
3	*5180.00	102.0 PK			1.46 H	31	100.4	1.6
4	*5180.00	92.2 AV			1.46 H	31	90.6	1.6
5	#10360.00	56.4 PK	74.0	-17.6	1.50 H	32	44.9	11.5
6	#10360.00	44.5 AV	54.0	-9.5	1.50 H	32	33.0	11.5
7	15540.00	51.1 PK	74.0	-22.9	1.66 H	71	38.0	13.1
8	15540.00	38.9 AV	54.0	-15.1	1.66 H	71	25.8	13.1
ANTENNA POLARITY & TEST DISTANCE: VERTICAL AT 3 M								
NO.	FREQ. (MHz)	EMISSION LEVEL (dBuV/m)	LIMIT (dBuV/m)	MARGIN (dB)	ANTENNA HEIGHT (m)	TABLE ANGLE (Degree)	RAW VALUE (dBuV)	CORRECTION FACTOR (dB/m)
1	5150.00	72.8 PK	74.0	-1.2	1.50 V	325	71.3	1.5
2	5150.00	51.8 AV	54.0	-2.2	1.50 V	325	50.3	1.5
3	*5180.00	112.3 PK			1.50 V	325	110.7	1.6
4	*5180.00	102.4 AV			1.50 V	325	100.8	1.6
5	#10360.00	61.5 PK	74.0	-12.5	2.67 V	53	50.0	11.5
6	#10360.00	50.1 AV	54.0	-3.9	2.67 V	53	38.6	11.5
7	15540.00	51.2 PK	74.0	-22.8	1.50 V	60	38.1	13.1
8	15540.00	39.0 AV	54.0	-15.0	1.50 V	60	25.9	13.1

REMARKS:

1. Emission Level(dBuV/m) = Raw Value(dBuV) + Correction Factor(dB/m)
2. Correction Factor(dB/m) = Antenna Factor(dB/m) + Cable Factor(dB) – Pre-Amplifier Factor(dB)
3. The other emission levels were very low against the limit.
4. Margin value = Emission Level – Limit value
5. " * ": Fundamental frequency.
6. " # ": The radiated frequency is out of the restricted band.

CHANNEL	TX Channel 40	DETECTOR FUNCTION	Peak (PK)
FREQUENCY RANGE	1GHz ~ 40GHz		Average (AV)

ANTENNA POLARITY & TEST DISTANCE: HORIZONTAL AT 3 M

NO.	FREQ. (MHz)	EMISSION LEVEL (dBuV/m)	LIMIT (dBuV/m)	MARGIN (dB)	ANTENNA HEIGHT (m)	TABLE ANGLE (Degree)	RAW VALUE (dBuV)	CORRECTION FACTOR (dB/m)
1	5150.00	58.6 PK	74.0	-15.4	1.46 H	24	57.1	1.5
2	5150.00	43.3 AV	54.0	-10.7	1.46 H	24	41.8	1.5
3	*5200.00	104.6 PK			1.46 H	24	102.9	1.7
4	*5200.00	94.4 AV			1.46 H	24	92.7	1.7
5	#10400.00	56.1 PK	74.0	-17.9	1.66 H	34	44.5	11.6
6	#10400.00	43.6 AV	54.0	-10.4	1.66 H	34	32.0	11.6
7	15600.00	51.2 PK	74.0	-22.8	1.67 H	63	38.1	13.1
8	15600.00	39.0 AV	54.0	-15.0	1.67 H	63	25.9	13.1

ANTENNA POLARITY & TEST DISTANCE: VERTICAL AT 3 M

NO.	FREQ. (MHz)	EMISSION LEVEL (dBuV/m)	LIMIT (dBuV/m)	MARGIN (dB)	ANTENNA HEIGHT (m)	TABLE ANGLE (Degree)	RAW VALUE (dBuV)	CORRECTION FACTOR (dB/m)
1	5150.00	70.5 PK	74.0	-3.5	1.50 V	324	69.0	1.5
2	5150.00	52.6 AV	54.0	-1.4	1.50 V	324	51.1	1.5
3	*5200.00	114.0 PK			1.50 V	324	112.3	1.7
4	*5200.00	104.3 AV			1.50 V	324	102.6	1.7
5	#10400.00	63.0 PK	74.0	-11.0	2.69 V	64	51.4	11.6
6	#10400.00	49.8 AV	54.0	-4.2	2.69 V	64	38.2	11.6
7	15600.00	51.3 PK	74.0	-22.7	1.48 V	67	38.2	13.1
8	15600.00	39.0 AV	54.0	-15.0	1.48 V	67	25.9	13.1

REMARKS:

1. Emission Level(dBuV/m) = Raw Value(dBuV) + Correction Factor(dB/m)
2. Correction Factor(dB/m) = Antenna Factor(dB/m) + Cable Factor(dB) – Pre-Amplifier Factor(dB)
3. The other emission levels were very low against the limit.
4. Margin value = Emission Level – Limit value
5. " * ": Fundamental frequency.
6. " # ": The radiated frequency is out of the restricted band.

CHANNEL	TX Channel 48	DETECTOR FUNCTION	Peak (PK)
FREQUENCY RANGE	1GHz ~ 40GHz		Average (AV)

ANTENNA POLARITY & TEST DISTANCE: HORIZONTAL AT 3 M

NO.	FREQ. (MHz)	EMISSION LEVEL (dBuV/m)	LIMIT (dBuV/m)	MARGIN (dB)	ANTENNA HEIGHT (m)	TABLE ANGLE (Degree)	RAW VALUE (dBuV)	CORRECTION FACTOR (dB/m)
1	5150.00	52.8 PK	74.0	-21.2	1.46 H	31	51.3	1.5
2	5150.00	39.9 AV	54.0	-14.1	1.46 H	31	38.4	1.5
3	*5240.00	107.0 PK			1.46 H	31	105.4	1.6
4	*5240.00	97.3 AV			1.46 H	31	95.7	1.6
5	5350.00	51.7 PK	74.0	-22.3	1.46 H	31	49.8	1.9
6	5350.00	38.6 AV	54.0	-15.4	1.46 H	31	36.7	1.9
7	#10480.00	55.1 PK	74.0	-18.9	1.72 H	62	43.1	12.0
8	#10480.00	44.3 AV	54.0	-9.7	1.72 H	62	32.3	12.0
9	15720.00	51.1 PK	74.0	-22.9	1.65 H	67	37.9	13.2
10	15720.00	38.6 AV	54.0	-15.4	1.65 H	67	25.4	13.2

ANTENNA POLARITY & TEST DISTANCE: VERTICAL AT 3 M

NO.	FREQ. (MHz)	EMISSION LEVEL (dBuV/m)	LIMIT (dBuV/m)	MARGIN (dB)	ANTENNA HEIGHT (m)	TABLE ANGLE (Degree)	RAW VALUE (dBuV)	CORRECTION FACTOR (dB/m)
1	5150.00	58.2 PK	74.0	-15.8	1.50 V	325	56.7	1.5
2	5150.00	45.5 AV	54.0	-8.5	1.50 V	325	44.0	1.5
3	*5240.00	116.6 PK			1.50 V	325	115.0	1.6
4	*5240.00	106.9 AV			1.50 V	325	105.3	1.6
5	5350.00	60.6 PK	74.0	-13.4	1.50 V	325	58.7	1.9
6	5350.00	46.1 AV	54.0	-7.9	1.50 V	325	44.2	1.9
7	#10480.00	63.0 PK	74.0	-11.0	2.67 V	55	51.0	12.0
8	#10480.00	50.3 AV	54.0	-3.7	2.67 V	55	38.3	12.0
9	15720.00	51.0 PK	74.0	-23.0	1.47 V	52	37.8	13.2
10	15720.00	38.9 AV	54.0	-15.1	1.47 V	52	25.7	13.2

REMARKS:

1. Emission Level(dBuV/m) = Raw Value(dBuV) + Correction Factor(dB/m)
2. Correction Factor(dB/m) = Antenna Factor(dB/m) + Cable Factor(dB) – Pre-Amplifier Factor(dB)
3. The other emission levels were very low against the limit.
4. Margin value = Emission Level – Limit value
5. " * ": Fundamental frequency.
6. " # ": The radiated frequency is out of the restricted band.

CHANNEL	TX Channel 149	DETECTOR FUNCTION	Peak (PK)
FREQUENCY RANGE	1GHz ~ 40GHz		Average (AV)

ANTENNA POLARITY & TEST DISTANCE: HORIZONTAL AT 3 M

NO.	FREQ. (MHz)	EMISSION LEVEL (dBuV/m)	LIMIT (dBuV/m)	MARGIN (dB)	ANTENNA HEIGHT (m)	TABLE ANGLE (Degree)	RAW VALUE (dBuV)	CORRECTION FACTOR (dB/m)
1	#5646.76	57.0 PK	68.2	-11.2	1.51 H	33	54.5	2.5
2	*5745.00	108.1 PK			1.51 H	33	105.4	2.7
3	*5745.00	98.0 AV			1.51 H	33	95.3	2.7
4	#5974.34	57.1 PK	68.2	-11.1	1.51 H	33	54.1	3.0
5	11490.00	50.8 PK	74.0	-23.2	1.51 H	360	37.4	13.4
6	11490.00	39.6 AV	54.0	-14.4	1.51 H	360	26.2	13.4
7	#17235.00	55.6 PK	74.0	-18.4	1.75 H	58	37.3	18.3
8	#17235.00	42.2 AV	54.0	-11.8	1.75 H	58	23.9	18.3

ANTENNA POLARITY & TEST DISTANCE: VERTICAL AT 3 M

NO.	FREQ. (MHz)	EMISSION LEVEL (dBuV/m)	LIMIT (dBuV/m)	MARGIN (dB)	ANTENNA HEIGHT (m)	TABLE ANGLE (Degree)	RAW VALUE (dBuV)	CORRECTION FACTOR (dB/m)
1	#5649.75	63.0 PK	68.2	-5.2	1.58 V	333	60.5	2.5
2	*5745.00	118.3 PK			1.58 V	333	115.6	2.7
3	*5745.00	107.4 AV			1.58 V	333	104.7	2.7
4	#5976.55	56.3 PK	68.2	-11.9	1.58 V	333	53.2	3.1
5	11490.00	51.4 PK	74.0	-22.6	2.67 V	53	38.0	13.4
6	11490.00	39.8 AV	54.0	-14.2	2.67 V	53	26.4	13.4
7	#17235.00	55.0 PK	74.0	-19.0	1.43 V	52	36.7	18.3
8	#17235.00	41.5 AV	54.0	-12.5	1.43 V	52	23.2	18.3

REMARKS:

1. Emission Level(dBuV/m) = Raw Value(dBuV) + Correction Factor(dB/m)
2. Correction Factor(dB/m) = Antenna Factor(dB/m) + Cable Factor(dB) – Pre-Amplifier Factor(dB)
3. The other emission levels were very low against the limit.
4. Margin value = Emission Level – Limit value
5. " * ": Fundamental frequency.
6. " # ": The radiated frequency is out of the restricted band.

CHANNEL	TX Channel 157	DETECTOR FUNCTION	Peak (PK)
FREQUENCY RANGE	1GHz ~ 40GHz		Average (AV)

ANTENNA POLARITY & TEST DISTANCE: HORIZONTAL AT 3 M

NO.	FREQ. (MHz)	EMISSION LEVEL (dBuV/m)	LIMIT (dBuV/m)	MARGIN (dB)	ANTENNA HEIGHT (m)	TABLE ANGLE (Degree)	RAW VALUE (dBuV)	CORRECTION FACTOR (dB/m)
1	#5611.94	55.4 PK	68.2	-12.8	1.52 H	34	52.9	2.5
2	*5785.00	107.2 PK			1.52 H	34	104.5	2.7
3	*5785.00	97.3 AV			1.52 H	34	94.6	2.7
4	#5927.92	57.3 PK	68.2	-10.9	1.52 H	34	54.4	2.9
5	11570.00	50.5 PK	74.0	-23.5	1.48 H	360	37.4	13.1
6	11570.00	38.7 AV	54.0	-15.3	1.48 H	360	25.6	13.1
7	#17355.00	56.2 PK	74.0	-17.8	1.66 H	54	37.4	18.8
8	#17355.00	42.6 AV	54.0	-11.4	1.66 H	54	23.8	18.8

ANTENNA POLARITY & TEST DISTANCE: VERTICAL AT 3 M

NO.	FREQ. (MHz)	EMISSION LEVEL (dBuV/m)	LIMIT (dBuV/m)	MARGIN (dB)	ANTENNA HEIGHT (m)	TABLE ANGLE (Degree)	RAW VALUE (dBuV)	CORRECTION FACTOR (dB/m)
1	#5600.82	57.0 PK	68.2	-11.2	1.58 V	330	54.6	2.4
2	*5785.00	118.5 PK			1.58 V	330	115.8	2.7
3	*5785.00	108.0 AV			1.58 V	330	105.3	2.7
4	#5931.43	57.0 PK	68.2	-11.2	1.58 V	330	54.1	2.9
5	11570.00	51.5 PK	74.0	-22.5	2.70 V	73	38.4	13.1
6	11570.00	39.8 AV	54.0	-14.2	2.70 V	73	26.7	13.1
7	#17355.00	55.2 PK	74.0	-18.8	1.42 V	41	36.4	18.8
8	#17355.00	41.8 AV	54.0	-12.2	1.42 V	41	23.0	18.8

REMARKS:

1. Emission Level(dBuV/m) = Raw Value(dBuV) + Correction Factor(dB/m)
2. Correction Factor(dB/m) = Antenna Factor(dB/m) + Cable Factor(dB) – Pre-Amplifier Factor(dB)
3. The other emission levels were very low against the limit.
4. Margin value = Emission Level – Limit value
5. " * ": Fundamental frequency.
6. " # ": The radiated frequency is out of the restricted band.

CHANNEL	TX Channel 165	DETECTOR FUNCTION	Peak (PK)
FREQUENCY RANGE	1GHz ~ 40GHz		Average (AV)

ANTENNA POLARITY & TEST DISTANCE: HORIZONTAL AT 3 M

NO.	FREQ. (MHz)	EMISSION LEVEL (dBuV/m)	LIMIT (dBuV/m)	MARGIN (dB)	ANTENNA HEIGHT (m)	TABLE ANGLE (Degree)	RAW VALUE (dBuV)	CORRECTION FACTOR (dB/m)
1	#5634.85	54.8 PK	68.2	-13.4	1.52 H	31	52.3	2.5
2	*5825.00	107.5 PK			1.52 H	31	104.8	2.7
3	*5825.00	96.7 AV			1.52 H	31	94.0	2.7
4	#5961.06	55.8 PK	68.2	-12.4	1.52 H	31	52.8	3.0
5	11650.00	50.7 PK	74.0	-23.3	1.48 H	360	37.6	13.1
6	11650.00	38.9 AV	54.0	-15.1	1.48 H	360	25.8	13.1
7	#17475.00	56.1 PK	74.0	-17.9	1.73 H	35	36.9	19.2
8	#17475.00	42.7 AV	54.0	-11.3	1.73 H	35	23.5	19.2

ANTENNA POLARITY & TEST DISTANCE: VERTICAL AT 3 M

NO.	FREQ. (MHz)	EMISSION LEVEL (dBuV/m)	LIMIT (dBuV/m)	MARGIN (dB)	ANTENNA HEIGHT (m)	TABLE ANGLE (Degree)	RAW VALUE (dBuV)	CORRECTION FACTOR (dB/m)
1	#5613.18	56.5 PK	68.2	-11.7	1.58 V	329	54.0	2.5
2	*5825.00	118.0 PK			1.58 V	329	115.3	2.7
3	*5825.00	107.5 AV			1.58 V	329	104.8	2.7
4	#5936.18	61.4 PK	68.2	-6.8	1.58 V	329	58.5	2.9
5	11650.00	51.2 PK	74.0	-22.8	2.65 V	61	38.1	13.1
6	11650.00	39.7 AV	54.0	-14.3	2.65 V	61	26.6	13.1
7	#17475.00	55.7 PK	74.0	-18.3	1.43 V	42	36.5	19.2
8	#17475.00	42.0 AV	54.0	-12.0	1.43 V	42	22.8	19.2

REMARKS:

1. Emission Level(dBuV/m) = Raw Value(dBuV) + Correction Factor(dB/m)
2. Correction Factor(dB/m) = Antenna Factor(dB/m) + Cable Factor(dB) – Pre-Amplifier Factor(dB)
3. The other emission levels were very low against the limit.
4. Margin value = Emission Level – Limit value
5. " * ": Fundamental frequency.
6. " # ": The radiated frequency is out of the restricted band.

802.11ac (VHT20)

CHANNEL	TX Channel 36	DETECTOR FUNCTION	Peak (PK)
FREQUENCY RANGE	1GHz ~ 40GHz		Average (AV)

ANTENNA POLARITY & TEST DISTANCE: HORIZONTAL AT 3 M

NO.	FREQ. (MHz)	EMISSION LEVEL (dBuV/m)	LIMIT (dBuV/m)	MARGIN (dB)	ANTENNA HEIGHT (m)	TABLE ANGLE (Degree)	RAW VALUE (dBuV)	CORRECTION FACTOR (dB/m)
1	5150.00	64.2 PK	74.0	-9.8	1.18 H	33	62.7	1.5
2	5150.00	42.6 AV	54.0	-11.4	1.18 H	33	41.1	1.5
3	*5180.00	100.4 PK			1.18 H	33	98.8	1.6
4	*5180.00	90.4 AV			1.18 H	33	88.8	1.6
5	#10360.00	56.5 PK	74.0	-17.5	1.53 H	47	45.0	11.5
6	#10360.00	44.8 AV	54.0	-9.2	1.53 H	47	33.3	11.5
7	15540.00	51.3 PK	74.0	-22.7	1.71 H	55	38.2	13.1
8	15540.00	38.8 AV	54.0	-15.2	1.71 H	55	25.7	13.1

ANTENNA POLARITY & TEST DISTANCE: VERTICAL AT 3 M

NO.	FREQ. (MHz)	EMISSION LEVEL (dBuV/m)	LIMIT (dBuV/m)	MARGIN (dB)	ANTENNA HEIGHT (m)	TABLE ANGLE (Degree)	RAW VALUE (dBuV)	CORRECTION FACTOR (dB/m)
1	5150.00	72.8 PK	74.0	-1.2	1.49 V	324	71.3	1.5
2	5150.00	51.4 AV	54.0	-2.6	1.49 V	324	49.9	1.5
3	*5180.00	111.5 PK			1.49 V	324	109.9	1.6
4	*5180.00	101.2 AV			1.49 V	324	99.6	1.6
5	#10360.00	61.1 PK	74.0	-12.9	2.72 V	69	49.6	11.5
6	#10360.00	49.7 AV	54.0	-4.3	2.72 V	69	38.2	11.5
7	15540.00	50.9 PK	74.0	-23.1	1.47 V	50	37.8	13.1
8	15540.00	38.5 AV	54.0	-15.5	1.47 V	50	25.4	13.1

REMARKS:

- Emission Level(dBuV/m) = Raw Value(dBuV) + Correction Factor(dB/m)
- Correction Factor(dB/m) = Antenna Factor(dB/m) + Cable Factor(dB) – Pre-Amplifier Factor(dB)
- The other emission levels were very low against the limit.
- Margin value = Emission Level – Limit value
- " * ": Fundamental frequency.
- " # ": The radiated frequency is out of the restricted band.

CHANNEL	TX Channel 40	DETECTOR FUNCTION	Peak (PK)
FREQUENCY RANGE	1GHz ~ 40GHz		Average (AV)

ANTENNA POLARITY & TEST DISTANCE: HORIZONTAL AT 3 M

NO.	FREQ. (MHz)	EMISSION LEVEL (dBuV/m)	LIMIT (dBuV/m)	MARGIN (dB)	ANTENNA HEIGHT (m)	TABLE ANGLE (Degree)	RAW VALUE (dBuV)	CORRECTION FACTOR (dB/m)
1	5150.00	59.8 PK	74.0	-14.2	1.18 H	32	58.3	1.5
2	5150.00	43.3 AV	54.0	-10.7	1.18 H	32	41.8	1.5
3	*5200.00	102.0 PK			1.18 H	32	100.3	1.7
4	*5200.00	92.4 AV			1.18 H	32	90.7	1.7
5	#10400.00	57.0 PK	74.0	-17.0	1.49 H	30	45.4	11.6
6	#10400.00	44.8 AV	54.0	-9.2	1.49 H	30	33.2	11.6
7	15600.00	50.7 PK	74.0	-23.3	1.68 H	83	37.6	13.1
8	15600.00	38.4 AV	54.0	-15.6	1.68 H	83	25.3	13.1

ANTENNA POLARITY & TEST DISTANCE: VERTICAL AT 3 M

NO.	FREQ. (MHz)	EMISSION LEVEL (dBuV/m)	LIMIT (dBuV/m)	MARGIN (dB)	ANTENNA HEIGHT (m)	TABLE ANGLE (Degree)	RAW VALUE (dBuV)	CORRECTION FACTOR (dB/m)
1	5150.00	71.5 PK	74.0	-2.5	1.49 V	325	70.0	1.5
2	5150.00	52.9 AV	54.0	-1.1	1.49 V	325	51.4	1.5
3	*5200.00	113.2 PK			1.49 V	325	111.5	1.7
4	*5200.00	103.1 AV			1.49 V	325	101.4	1.7
5	#10400.00	62.9 PK	74.0	-11.1	2.70 V	67	51.3	11.6
6	#10400.00	49.9 AV	54.0	-4.1	2.70 V	67	38.3	11.6
7	15600.00	51.7 PK	74.0	-22.3	1.49 V	54	38.6	13.1
8	15600.00	39.2 AV	54.0	-14.8	1.49 V	54	26.1	13.1

REMARKS:

- Emission Level(dBuV/m) = Raw Value(dBuV) + Correction Factor(dB/m)
- Correction Factor(dB/m) = Antenna Factor(dB/m) + Cable Factor(dB) – Pre-Amplifier Factor(dB)
- The other emission levels were very low against the limit.
- Margin value = Emission Level – Limit value
- " * ": Fundamental frequency.
- " # ": The radiated frequency is out of the restricted band.

CHANNEL	TX Channel 48	DETECTOR FUNCTION	Peak (PK)
FREQUENCY RANGE	1GHz ~ 40GHz		Average (AV)

ANTENNA POLARITY & TEST DISTANCE: HORIZONTAL AT 3 M

NO.	FREQ. (MHz)	EMISSION LEVEL (dBuV/m)	LIMIT (dBuV/m)	MARGIN (dB)	ANTENNA HEIGHT (m)	TABLE ANGLE (Degree)	RAW VALUE (dBuV)	CORRECTION FACTOR (dB/m)
1	*5240.00	104.9 PK			1.12 H	32	103.3	1.6
2	*5240.00	94.8 AV			1.12 H	32	93.2	1.6
3	5350.00	51.2 PK	74.0	-22.8	1.12 H	32	49.3	1.9
4	5350.00	38.1 AV	54.0	-15.9	1.12 H	32	36.2	1.9
5	#10480.00	56.5 PK	74.0	-17.5	1.52 H	37	44.5	12.0
6	#10480.00	44.5 AV	54.0	-9.5	1.52 H	37	32.5	12.0
7	15720.00	51.1 PK	74.0	-22.9	1.64 H	65	37.9	13.2
8	15720.00	38.8 AV	54.0	-15.2	1.64 H	65	25.6	13.2

ANTENNA POLARITY & TEST DISTANCE: VERTICAL AT 3 M

NO.	FREQ. (MHz)	EMISSION LEVEL (dBuV/m)	LIMIT (dBuV/m)	MARGIN (dB)	ANTENNA HEIGHT (m)	TABLE ANGLE (Degree)	RAW VALUE (dBuV)	CORRECTION FACTOR (dB/m)
1	*5240.00	116.6 PK			1.49 V	325	115.0	1.6
2	*5240.00	105.8 AV			1.49 V	325	104.2	1.6
3	5350.00	60.7 PK	74.0	-13.3	1.49 V	325	58.8	1.9
4	5350.00	46.0 AV	54.0	-8.0	1.49 V	325	44.1	1.9
5	#10480.00	63.2 PK	74.0	-10.8	2.63 V	51	51.2	12.0
6	#10480.00	50.4 AV	54.0	-3.6	2.63 V	51	38.4	12.0
7	15720.00	51.4 PK	74.0	-22.6	1.52 V	57	38.2	13.2
8	15720.00	39.2 AV	54.0	-14.8	1.52 V	57	26.0	13.2

REMARKS:

1. Emission Level(dBuV/m) = Raw Value(dBuV) + Correction Factor(dB/m)
2. Correction Factor(dB/m) = Antenna Factor(dB/m) + Cable Factor(dB) – Pre-Amplifier Factor(dB)
3. The other emission levels were very low against the limit.
4. Margin value = Emission Level – Limit value
5. " * ": Fundamental frequency.
6. " # ": The radiated frequency is out of the restricted band.

CHANNEL	TX Channel 149	DETECTOR FUNCTION	Peak (PK)
FREQUENCY RANGE	1GHz ~ 40GHz		Average (AV)

ANTENNA POLARITY & TEST DISTANCE: HORIZONTAL AT 3 M

NO.	FREQ. (MHz)	EMISSION LEVEL (dBuV/m)	LIMIT (dBuV/m)	MARGIN (dB)	ANTENNA HEIGHT (m)	TABLE ANGLE (Degree)	RAW VALUE (dBuV)	CORRECTION FACTOR (dB/m)
1	#5618.09	56.8 PK	68.2	-11.4	1.52 H	32	54.3	2.5
2	*5745.00	107.1 PK			1.52 H	32	104.4	2.7
3	*5745.00	96.3 AV			1.52 H	32	93.6	2.7
4	#5958.07	57.5 PK	68.2	-10.7	1.52 H	32	54.5	3.0
5	11490.00	50.8 PK	74.0	-23.2	1.51 H	360	37.4	13.4
6	11490.00	39.9 AV	54.0	-14.1	1.51 H	360	26.5	13.4
7	#17235.00	55.7 PK	74.0	-18.3	1.70 H	57	37.4	18.3
8	#17235.00	42.0 AV	54.0	-12.0	1.70 H	57	23.7	18.3

ANTENNA POLARITY & TEST DISTANCE: VERTICAL AT 3 M

NO.	FREQ. (MHz)	EMISSION LEVEL (dBuV/m)	LIMIT (dBuV/m)	MARGIN (dB)	ANTENNA HEIGHT (m)	TABLE ANGLE (Degree)	RAW VALUE (dBuV)	CORRECTION FACTOR (dB/m)
1	#5645.00	64.4 PK	68.2	-3.8	1.58 V	331	61.9	2.5
2	*5745.00	117.0 PK			1.58 V	331	114.3	2.7
3	*5745.00	106.5 AV			1.58 V	331	103.8	2.7
4	#5952.32	56.1 PK	68.2	-12.1	1.58 V	331	53.1	3.0
5	11490.00	51.7 PK	74.0	-22.3	2.67 V	39	38.3	13.4
6	11490.00	39.8 AV	54.0	-14.2	2.67 V	39	26.4	13.4
7	#17235.00	55.0 PK	74.0	-19.0	1.45 V	53	36.7	18.3
8	#17235.00	41.7 AV	54.0	-12.3	1.45 V	53	23.4	18.3

REMARKS:

1. Emission Level(dBuV/m) = Raw Value(dBuV) + Correction Factor(dB/m)
2. Correction Factor(dB/m) = Antenna Factor(dB/m) + Cable Factor(dB) – Pre-Amplifier Factor(dB)
3. The other emission levels were very low against the limit.
4. Margin value = Emission Level – Limit value
5. " * ": Fundamental frequency.
6. " # ": The radiated frequency is out of the restricted band.

CHANNEL	TX Channel 157	DETECTOR FUNCTION	Peak (PK)
FREQUENCY RANGE	1GHz ~ 40GHz		Average (AV)

ANTENNA POLARITY & TEST DISTANCE: HORIZONTAL AT 3 M

NO.	FREQ. (MHz)	EMISSION LEVEL (dBuV/m)	LIMIT (dBuV/m)	MARGIN (dB)	ANTENNA HEIGHT (m)	TABLE ANGLE (Degree)	RAW VALUE (dBuV)	CORRECTION FACTOR (dB/m)
1	#5571.85	55.3 PK	68.2	-12.9	1.55 H	32	53.0	2.3
2	*5785.00	107.0 PK			1.55 H	32	104.3	2.7
3	*5785.00	96.1 AV			1.55 H	32	93.4	2.7
4	#5958.75	55.6 PK	68.2	-12.6	1.55 H	32	52.6	3.0
5	11570.00	51.3 PK	74.0	-22.7	1.48 H	360	38.2	13.1
6	11570.00	40.1 AV	54.0	-13.9	1.48 H	360	27.0	13.1
7	#17355.00	55.6 PK	74.0	-18.4	1.76 H	34	36.8	18.8
8	#17355.00	42.2 AV	54.0	-11.8	1.76 H	34	23.4	18.8

ANTENNA POLARITY & TEST DISTANCE: VERTICAL AT 3 M

NO.	FREQ. (MHz)	EMISSION LEVEL (dBuV/m)	LIMIT (dBuV/m)	MARGIN (dB)	ANTENNA HEIGHT (m)	TABLE ANGLE (Degree)	RAW VALUE (dBuV)	CORRECTION FACTOR (dB/m)
1	#5640.25	56.9 PK	68.2	-11.3	1.58 V	331	54.4	2.5
2	*5785.00	117.3 PK			1.58 V	331	114.6	2.7
3	*5785.00	106.7 AV			1.58 V	331	104.0	2.7
4	#5934.27	57.2 PK	68.2	-11.0	1.58 V	331	54.3	2.9
5	11570.00	51.6 PK	74.0	-22.4	2.70 V	65	38.5	13.1
6	11570.00	40.1 AV	54.0	-13.9	2.70 V	65	27.0	13.1
7	#17355.00	55.5 PK	74.0	-18.5	1.48 V	67	36.7	18.8
8	#17355.00	41.8 AV	54.0	-12.2	1.48 V	67	23.0	18.8

REMARKS:

1. Emission Level(dBuV/m) = Raw Value(dBuV) + Correction Factor(dB/m)
2. Correction Factor(dB/m) = Antenna Factor(dB/m) + Cable Factor(dB) – Pre-Amplifier Factor(dB)
3. The other emission levels were very low against the limit.
4. Margin value = Emission Level – Limit value
5. " * ": Fundamental frequency.
6. " # ": The radiated frequency is out of the restricted band.

CHANNEL	TX Channel 165	DETECTOR FUNCTION	Peak (PK)
FREQUENCY RANGE	1GHz ~ 40GHz		Average (AV)

ANTENNA POLARITY & TEST DISTANCE: HORIZONTAL AT 3 M

NO.	FREQ. (MHz)	EMISSION LEVEL (dBuV/m)	LIMIT (dBuV/m)	MARGIN (dB)	ANTENNA HEIGHT (m)	TABLE ANGLE (Degree)	RAW VALUE (dBuV)	CORRECTION FACTOR (dB/m)
1	#5636.13	56.1 PK	68.2	-12.1	1.55 H	30	53.6	2.5
2	*5825.00	106.3 PK			1.55 H	30	103.6	2.7
3	*5825.00	95.5 AV			1.55 H	30	92.8	2.7
4	#5983.45	57.5 PK	68.2	-10.7	1.55 H	30	54.3	3.2
5	11650.00	50.6 PK	74.0	-23.4	1.52 H	360	37.5	13.1
6	11650.00	39.3 AV	54.0	-14.7	1.52 H	360	26.2	13.1
7	#17475.00	55.5 PK	74.0	-18.5	1.69 H	39	36.3	19.2
8	#17475.00	42.1 AV	54.0	-11.9	1.69 H	39	22.9	19.2

ANTENNA POLARITY & TEST DISTANCE: VERTICAL AT 3 M

NO.	FREQ. (MHz)	EMISSION LEVEL (dBuV/m)	LIMIT (dBuV/m)	MARGIN (dB)	ANTENNA HEIGHT (m)	TABLE ANGLE (Degree)	RAW VALUE (dBuV)	CORRECTION FACTOR (dB/m)
1	#5596.55	56.2 PK	68.2	-12.0	1.58 V	330	53.9	2.3
2	*5825.00	116.9 PK			1.58 V	330	114.2	2.7
3	*5825.00	106.4 AV			1.58 V	330	103.7	2.7
4	#5925.73	62.3 PK	68.2	-5.9	1.58 V	330	59.4	2.9
5	11650.00	51.6 PK	74.0	-22.4	2.68 V	52	38.5	13.1
6	11650.00	39.7 AV	54.0	-14.3	2.68 V	52	26.6	13.1
7	#17475.00	55.2 PK	74.0	-18.8	1.49 V	55	36.0	19.2
8	#17475.00	41.9 AV	54.0	-12.1	1.49 V	55	22.7	19.2

REMARKS:

1. Emission Level(dBuV/m) = Raw Value(dBuV) + Correction Factor(dB/m)
2. Correction Factor(dB/m) = Antenna Factor(dB/m) + Cable Factor(dB) – Pre-Amplifier Factor(dB)
3. The other emission levels were very low against the limit.
4. Margin value = Emission Level – Limit value
5. " * ": Fundamental frequency.
6. " # ": The radiated frequency is out of the restricted band.

802.11ac (VHT40)

CHANNEL	TX Channel 38	DETECTOR FUNCTION	Peak (PK)
FREQUENCY RANGE	1GHz ~ 40GHz		Average (AV)

ANTENNA POLARITY & TEST DISTANCE: HORIZONTAL AT 3 M

NO.	FREQ. (MHz)	EMISSION LEVEL (dBuV/m)	LIMIT (dBuV/m)	MARGIN (dB)	ANTENNA HEIGHT (m)	TABLE ANGLE (Degree)	RAW VALUE (dBuV)	CORRECTION FACTOR (dB/m)
1	5150.00	61.3 PK	74.0	-12.7	1.12 H	39	59.8	1.5
2	5150.00	43.8 AV	54.0	-10.2	1.12 H	39	42.3	1.5
3	*5190.00	94.2 PK			1.12 H	39	92.5	1.7
4	*5190.00	84.0 AV			1.12 H	39	82.3	1.7
5	#10380.00	50.5 PK	74.0	-23.5	1.58 H	27	39.0	11.5
6	#10380.00	37.0 AV	54.0	-17.0	1.58 H	27	25.5	11.5
7	15570.00	50.6 PK	74.0	-23.4	1.66 H	62	37.5	13.1
8	15570.00	38.5 AV	54.0	-15.5	1.66 H	62	25.4	13.1

ANTENNA POLARITY & TEST DISTANCE: VERTICAL AT 3 M

NO.	FREQ. (MHz)	EMISSION LEVEL (dBuV/m)	LIMIT (dBuV/m)	MARGIN (dB)	ANTENNA HEIGHT (m)	TABLE ANGLE (Degree)	RAW VALUE (dBuV)	CORRECTION FACTOR (dB/m)
1	5150.00	70.0 PK	74.0	-4.0	1.49 V	322	68.5	1.5
2	5150.00	52.9 AV	54.0	-1.1	1.49 V	322	51.4	1.5
3	*5190.00	107.0 PK			1.49 V	322	105.3	1.7
4	*5190.00	95.0 AV			1.49 V	322	93.3	1.7
5	#10380.00	54.6 PK	74.0	-19.4	2.62 V	59	43.1	11.5
6	#10380.00	41.4 AV	54.0	-12.6	2.62 V	59	29.9	11.5
7	15570.00	51.7 PK	74.0	-22.3	1.54 V	63	38.6	13.1
8	15570.00	39.2 AV	54.0	-14.8	1.54 V	63	26.1	13.1

REMARKS:

- Emission Level(dBuV/m) = Raw Value(dBuV) + Correction Factor(dB/m)
- Correction Factor(dB/m) = Antenna Factor(dB/m) + Cable Factor(dB) – Pre-Amplifier Factor(dB)
- The other emission levels were very low against the limit.
- Margin value = Emission Level – Limit value
- " * ": Fundamental frequency.
- " # ": The radiated frequency is out of the restricted band.

CHANNEL	TX Channel 46	DETECTOR FUNCTION	Peak (PK)
FREQUENCY RANGE	1GHz ~ 40GHz		Average (AV)

ANTENNA POLARITY & TEST DISTANCE: HORIZONTAL AT 3 M

NO.	FREQ. (MHz)	EMISSION LEVEL (dBuV/m)	LIMIT (dBuV/m)	MARGIN (dB)	ANTENNA HEIGHT (m)	TABLE ANGLE (Degree)	RAW VALUE (dBuV)	CORRECTION FACTOR (dB/m)
1	5150.00	60.8 PK	74.0	-13.2	1.12 H	33	59.3	1.5
2	5150.00	44.6 AV	54.0	-9.4	1.12 H	33	43.1	1.5
3	*5230.00	100.3 PK			1.12 H	33	98.7	1.6
4	*5230.00	89.2 AV			1.12 H	33	87.6	1.6
5	5350.00	50.9 PK	74.0	-23.1	1.12 H	33	49.0	1.9
6	5350.00	37.8 AV	54.0	-16.2	1.12 H	33	35.9	1.9
7	#10460.00	55.4 PK	74.0	-18.6	1.49 H	43	43.5	11.9
8	#10460.00	42.5 AV	54.0	-11.5	1.49 H	43	30.6	11.9
9	15690.00	50.8 PK	74.0	-23.2	1.64 H	62	37.5	13.3
10	15690.00	38.3 AV	54.0	-15.7	1.64 H	62	25.0	13.3

ANTENNA POLARITY & TEST DISTANCE: VERTICAL AT 3 M

NO.	FREQ. (MHz)	EMISSION LEVEL (dBuV/m)	LIMIT (dBuV/m)	MARGIN (dB)	ANTENNA HEIGHT (m)	TABLE ANGLE (Degree)	RAW VALUE (dBuV)	CORRECTION FACTOR (dB/m)
1	5150.00	68.6 PK	74.0	-5.4	1.63 V	320	67.1	1.5
2	5150.00	52.9 AV	54.0	-1.1	1.63 V	320	51.4	1.5
3	*5230.00	112.1 PK			1.63 V	320	110.5	1.6
4	*5230.00	100.5 AV			1.63 V	320	98.9	1.6
5	5350.00	60.3 PK	74.0	-13.7	1.63 V	320	58.4	1.9
6	5350.00	45.7 AV	54.0	-8.3	1.63 V	320	43.8	1.9
7	#10460.00	60.2 PK	74.0	-13.8	2.62 V	59	48.3	11.9
8	#10460.00	47.3 AV	54.0	-6.7	2.62 V	59	35.4	11.9
9	15690.00	51.1 PK	74.0	-22.9	1.42 V	58	37.8	13.3
10	15690.00	38.6 AV	54.0	-15.4	1.42 V	58	25.3	13.3

REMARKS:

- Emission Level(dBuV/m) = Raw Value(dBuV) + Correction Factor(dB/m)
- Correction Factor(dB/m) = Antenna Factor(dB/m) + Cable Factor(dB) – Pre-Amplifier Factor(dB)
- The other emission levels were very low against the limit.
- Margin value = Emission Level – Limit value
- " * ": Fundamental frequency.
- " # ": The radiated frequency is out of the restricted band.

CHANNEL	TX Channel 151	DETECTOR FUNCTION	Peak (PK)
FREQUENCY RANGE	1GHz ~ 40GHz		Average (AV)

ANTENNA POLARITY & TEST DISTANCE: HORIZONTAL AT 3 M

NO.	FREQ. (MHz)	EMISSION LEVEL (dBuV/m)	LIMIT (dBuV/m)	MARGIN (dB)	ANTENNA HEIGHT (m)	TABLE ANGLE (Degree)	RAW VALUE (dBuV)	CORRECTION FACTOR (dB/m)
1	#5648.02	60.9 PK	68.2	-7.3	1.58 H	30	58.4	2.5
2	*5755.00	101.2 PK			1.58 H	30	98.5	2.7
3	*5755.00	90.8 AV			1.58 H	30	88.1	2.7
4	#6014.94	55.6 PK	68.2	-12.6	1.58 H	30	52.3	3.3
5	11510.00	50.5 PK	74.0	-23.5	1.55 H	360	37.1	13.4
6	11510.00	38.9 AV	54.0	-15.1	1.55 H	360	25.5	13.4
7	#17265.00	56.0 PK	74.0	-18.0	1.72 H	44	37.7	18.3
8	#17265.00	42.5 AV	54.0	-11.5	1.72 H	44	24.2	18.3

ANTENNA POLARITY & TEST DISTANCE: VERTICAL AT 3 M

NO.	FREQ. (MHz)	EMISSION LEVEL (dBuV/m)	LIMIT (dBuV/m)	MARGIN (dB)	ANTENNA HEIGHT (m)	TABLE ANGLE (Degree)	RAW VALUE (dBuV)	CORRECTION FACTOR (dB/m)
1	#5647.85	66.6 PK	68.2	-1.6	1.58 V	330	64.1	2.5
2	*5755.00	112.1 PK			1.58 V	330	109.4	2.7
3	*5755.00	100.9 AV			1.58 V	330	98.2	2.7
4	#5937.12	56.7 PK	68.2	-11.5	1.58 V	330	53.8	2.9
5	11510.00	51.3 PK	74.0	-22.7	2.65 V	64	37.9	13.4
6	11510.00	38.0 AV	54.0	-16.0	2.65 V	64	24.6	13.4
7	#17265.00	55.0 PK	74.0	-19.0	1.52 V	80	36.7	18.3
8	#17265.00	41.4 AV	54.0	-12.6	1.52 V	80	23.1	18.3

REMARKS:

1. Emission Level(dBuV/m) = Raw Value(dBuV) + Correction Factor(dB/m)
2. Correction Factor(dB/m) = Antenna Factor(dB/m) + Cable Factor(dB) – Pre-Amplifier Factor(dB)
3. The other emission levels were very low against the limit.
4. Margin value = Emission Level – Limit value
5. " * ": Fundamental frequency.
6. " # ": The radiated frequency is out of the restricted band.

CHANNEL	TX Channel 159	DETECTOR FUNCTION	Peak (PK)
FREQUENCY RANGE	1GHz ~ 40GHz		Average (AV)

ANTENNA POLARITY & TEST DISTANCE: HORIZONTAL AT 3 M

NO.	FREQ. (MHz)	EMISSION LEVEL (dBuV/m)	LIMIT (dBuV/m)	MARGIN (dB)	ANTENNA HEIGHT (m)	TABLE ANGLE (Degree)	RAW VALUE (dBuV)	CORRECTION FACTOR (dB/m)
1	#5648.76	58.2 PK	68.2	-10.0	1.52 H	31	55.7	2.5
2	*5795.00	103.6 PK			1.52 H	31	100.9	2.7
3	*5795.00	92.6 AV			1.52 H	31	89.9	2.7
4	#5931.33	57.0 PK	68.2	-11.2	1.52 H	31	54.1	2.9
5	11590.00	50.9 PK	74.0	-23.1	1.47 H	360	37.9	13.0
6	11590.00	39.4 AV	54.0	-14.6	1.47 H	360	26.4	13.0
7	#17385.00	55.3 PK	74.0	-18.7	1.80 H	65	36.3	19.0
8	#17385.00	41.7 AV	54.0	-12.3	1.80 H	65	22.7	19.0

ANTENNA POLARITY & TEST DISTANCE: VERTICAL AT 3 M

NO.	FREQ. (MHz)	EMISSION LEVEL (dBuV/m)	LIMIT (dBuV/m)	MARGIN (dB)	ANTENNA HEIGHT (m)	TABLE ANGLE (Degree)	RAW VALUE (dBuV)	CORRECTION FACTOR (dB/m)
1	#5635.98	62.3 PK	68.2	-5.9	1.58 V	330	59.8	2.5
2	*5795.00	113.5 PK			1.58 V	330	110.8	2.7
3	*5795.00	103.1 AV			1.58 V	330	100.4	2.7
4	#5922.40	68.6 PK	70.1	-1.5	1.58 V	330	65.7	2.9
5	11590.00	51.8 PK	74.0	-22.2	2.69 V	75	38.8	13.0
6	11590.00	38.4 AV	54.0	-15.6	2.69 V	75	25.4	13.0
7	#17385.00	55.2 PK	74.0	-18.8	1.47 V	74	36.2	19.0
8	#17385.00	41.9 AV	54.0	-12.1	1.47 V	74	22.9	19.0

REMARKS:

1. Emission Level(dBuV/m) = Raw Value(dBuV) + Correction Factor(dB/m)
2. Correction Factor(dB/m) = Antenna Factor(dB/m) + Cable Factor(dB) – Pre-Amplifier Factor(dB)
3. The other emission levels were very low against the limit.
4. Margin value = Emission Level – Limit value
5. " * ": Fundamental frequency.
6. " # ": The radiated frequency is out of the restricted band.

802.11ac (VHT80)

CHANNEL	TX Channel 42	DETECTOR FUNCTION	Peak (PK)
FREQUENCY RANGE	1GHz ~ 40GHz		Average (AV)

ANTENNA POLARITY & TEST DISTANCE: HORIZONTAL AT 3 M

NO.	FREQ. (MHz)	EMISSION LEVEL (dBuV/m)	LIMIT (dBuV/m)	MARGIN (dB)	ANTENNA HEIGHT (m)	TABLE ANGLE (Degree)	RAW VALUE (dBuV)	CORRECTION FACTOR (dB/m)
1	5150.00	56.7 PK	74.0	-17.3	1.12 H	32	55.2	1.5
2	5150.00	43.8 AV	54.0	-10.2	1.12 H	32	42.3	1.5
3	*5210.00	90.3 PK			1.12 H	32	88.6	1.7
4	*5210.00	81.4 AV			1.12 H	32	79.7	1.7
5	5350.00	50.3 PK	74.0	-23.7	1.12 H	32	48.4	1.9
6	5350.00	37.4 AV	54.0	-16.6	1.12 H	32	35.5	1.9
7	#10420.00	50.4 PK	74.0	-23.6	1.58 H	29	38.7	11.7
8	#10420.00	37.0 AV	54.0	-17.0	1.58 H	29	25.3	11.7
9	15630.00	50.2 PK	74.0	-23.8	1.63 H	52	37.0	13.2
10	15630.00	38.3 AV	54.0	-15.7	1.63 H	52	25.1	13.2

ANTENNA POLARITY & TEST DISTANCE: VERTICAL AT 3 M

NO.	FREQ. (MHz)	EMISSION LEVEL (dBuV/m)	LIMIT (dBuV/m)	MARGIN (dB)	ANTENNA HEIGHT (m)	TABLE ANGLE (Degree)	RAW VALUE (dBuV)	CORRECTION FACTOR (dB/m)
1	5150.00	67.6 PK	74.0	-6.4	1.63 V	320	66.1	1.5
2	5150.00	52.4 AV	54.0	-1.6	1.63 V	320	50.9	1.5
3	*5210.00	102.3 PK			1.63 V	320	100.6	1.7
4	*5210.00	92.0 AV			1.63 V	320	90.3	1.7
5	5350.00	60.2 PK	74.0	-13.8	1.63 V	320	58.3	1.9
6	5350.00	45.6 AV	54.0	-8.4	1.63 V	320	43.7	1.9
7	#10420.00	51.8 PK	74.0	-22.2	2.58 V	74	40.1	11.7
8	#10420.00	38.1 AV	54.0	-15.9	2.58 V	74	26.4	11.7
9	15630.00	51.7 PK	74.0	-22.3	1.58 V	56	38.5	13.2
10	15630.00	39.2 AV	54.0	-14.8	1.58 V	56	26.0	13.2

REMARKS:

- Emission Level(dBuV/m) = Raw Value(dBuV) + Correction Factor(dB/m)
- Correction Factor(dB/m) = Antenna Factor(dB/m) + Cable Factor(dB) – Pre-Amplifier Factor(dB)
- The other emission levels were very low against the limit.
- Margin value = Emission Level – Limit value
- " * ": Fundamental frequency.
- " # ": The radiated frequency is out of the restricted band.

CHANNEL	TX Channel 155	DETECTOR FUNCTION	Peak (PK)
FREQUENCY RANGE	1GHz ~ 40GHz		Average (AV)

ANTENNA POLARITY & TEST DISTANCE: HORIZONTAL AT 3 M

NO.	FREQ. (MHz)	EMISSION LEVEL (dBuV/m)	LIMIT (dBuV/m)	MARGIN (dB)	ANTENNA HEIGHT (m)	TABLE ANGLE (Degree)	RAW VALUE (dBuV)	CORRECTION FACTOR (dB/m)
1	#5649.48	61.9 PK	68.2	-6.3	1.52 H	31	59.4	2.5
2	*5775.00	97.3 PK			1.52 H	31	94.6	2.7
3	*5775.00	87.8 AV			1.52 H	31	85.1	2.7
4	#5947.78	57.4 PK	68.2	-10.8	1.52 H	31	54.5	2.9
5	11550.00	50.4 PK	74.0	-23.6	1.50 H	360	37.2	13.2
6	11550.00	39.2 AV	54.0	-14.8	1.50 H	360	26.0	13.2
7	#17325.00	55.4 PK	74.0	-18.6	1.74 H	54	36.8	18.6
8	#17325.00	42.0 AV	54.0	-12.0	1.74 H	54	23.4	18.6

ANTENNA POLARITY & TEST DISTANCE: VERTICAL AT 3 M

NO.	FREQ. (MHz)	EMISSION LEVEL (dBuV/m)	LIMIT (dBuV/m)	MARGIN (dB)	ANTENNA HEIGHT (m)	TABLE ANGLE (Degree)	RAW VALUE (dBuV)	CORRECTION FACTOR (dB/m)
1	#5635.98	67.1 PK	68.2	-1.1	1.58 V	330	64.6	2.5
2	*5775.00	107.1 PK			1.58 V	330	104.4	2.7
3	*5775.00	98.8 AV			1.58 V	330	96.1	2.7
4	#5933.32	62.0 PK	68.2	-6.2	1.58 V	330	59.1	2.9
5	11550.00	51.3 PK	74.0	-22.7	2.63 V	70	38.1	13.2
6	11550.00	37.6 AV	54.0	-16.4	2.63 V	70	24.4	13.2
7	#17325.00	55.3 PK	74.0	-18.7	1.51 V	65	36.7	18.6
8	#17325.00	42.2 AV	54.0	-11.8	1.51 V	65	23.6	18.6

REMARKS:

1. Emission Level(dBuV/m) = Raw Value(dBuV) + Correction Factor(dB/m)
2. Correction Factor(dB/m) = Antenna Factor(dB/m) + Cable Factor(dB) – Pre-Amplifier Factor(dB)
3. The other emission levels were very low against the limit.
4. Margin value = Emission Level – Limit value
5. " * ": Fundamental frequency.
6. " # ": The radiated frequency is out of the restricted band.

Below 1GHz Data:

802.11a

CHANNEL	TX Channel 36	DETECTOR FUNCTION	Quasi-Peak (QP)
FREQUENCY RANGE	9kHz ~ 1GHz		

ANTENNA POLARITY & TEST DISTANCE: HORIZONTAL AT 3 M

NO.	FREQ. (MHz)	EMISSION LEVEL (dBuV/m)	LIMIT (dBuV/m)	MARGIN (dB)	ANTENNA HEIGHT (m)	TABLE ANGLE (Degree)	RAW VALUE (dBuV)	CORRECTION FACTOR (dB/m)
1	30.64	30.7 QP	40.0	-9.3	1.99 H	238	40.7	-10.0
2	114.19	25.4 QP	43.5	-18.1	1.51 H	62	36.5	-11.1
3	249.82	34.2 QP	46.0	-11.8	1.00 H	61	44.2	-10.0
4	321.00	33.5 QP	46.0	-12.5	1.00 H	50	40.9	-7.4
5	497.94	27.6 QP	46.0	-18.4	1.49 H	58	30.4	-2.8
6	920.61	31.0 QP	46.0	-15.0	2.55 H	79	26.8	4.2

ANTENNA POLARITY & TEST DISTANCE: VERTICAL AT 3 M

NO.	FREQ. (MHz)	EMISSION LEVEL (dBuV/m)	LIMIT (dBuV/m)	MARGIN (dB)	ANTENNA HEIGHT (m)	TABLE ANGLE (Degree)	RAW VALUE (dBuV)	CORRECTION FACTOR (dB/m)
1	30.63	32.9 QP	40.0	-7.1	1.97 V	326	42.9	-10.0
2	42.79	29.7 QP	40.0	-10.3	1.06 V	360	38.5	-8.8
3	249.76	27.5 QP	46.0	-18.5	1.51 V	350	37.5	-10.0
4	320.96	26.7 QP	46.0	-19.3	1.55 V	360	34.1	-7.4
5	497.26	26.0 QP	46.0	-20.0	1.00 V	274	28.8	-2.8
6	926.01	30.2 QP	46.0	-15.8	2.55 V	49	25.9	4.3

REMARKS:

1. Emission Level(dBuV/m) = Raw Value(dBuV) + Correction Factor(dB/m)
2. Correction Factor(dB/m) = Antenna Factor(dB/m) + Cable Factor(dB) – Pre-Amplifier Factor(dB)
3. The other emission levels were very low against the limit.
4. Margin value = Emission Level – Limit value

CHANNEL	TX Channel 40	DETECTOR FUNCTION	Quasi-Peak (QP)
FREQUENCY RANGE	9kHz ~ 1GHz		

ANTENNA POLARITY & TEST DISTANCE: HORIZONTAL AT 3 M

NO.	FREQ. (MHz)	EMISSION LEVEL (dBuV/m)	LIMIT (dBuV/m)	MARGIN (dB)	ANTENNA HEIGHT (m)	TABLE ANGLE (Degree)	RAW VALUE (dBuV)	CORRECTION FACTOR (dB/m)
1	30.85	30.8 QP	40.0	-9.2	2.03 H	258	40.8	-10.0
2	114.28	25.4 QP	43.5	-18.1	1.46 H	58	36.5	-11.1
3	249.77	33.9 QP	46.0	-12.1	1.01 H	78	43.9	-10.0
4	320.72	34.0 QP	46.0	-12.0	1.01 H	33	41.4	-7.4
5	497.75	27.8 QP	46.0	-18.2	1.47 H	62	30.6	-2.8
6	920.61	30.7 QP	46.0	-15.3	2.49 H	83	26.5	4.2

ANTENNA POLARITY & TEST DISTANCE: VERTICAL AT 3 M

NO.	FREQ. (MHz)	EMISSION LEVEL (dBuV/m)	LIMIT (dBuV/m)	MARGIN (dB)	ANTENNA HEIGHT (m)	TABLE ANGLE (Degree)	RAW VALUE (dBuV)	CORRECTION FACTOR (dB/m)
1	30.92	32.8 QP	40.0	-7.2	2.04 V	334	42.8	-10.0
2	42.74	29.8 QP	40.0	-10.2	1.03 V	346	38.6	-8.8
3	250.27	27.8 QP	46.0	-18.2	1.52 V	359	37.8	-10.0
4	320.90	26.6 QP	46.0	-19.4	1.55 V	348	34.0	-7.4
5	497.52	26.2 QP	46.0	-19.8	1.02 V	305	29.0	-2.8
6	926.01	29.6 QP	46.0	-16.4	2.51 V	58	25.3	4.3

REMARKS:

1. Emission Level(dBuV/m) = Raw Value(dBuV) + Correction Factor(dB/m)
2. Correction Factor(dB/m) = Antenna Factor(dB/m) + Cable Factor(dB) – Pre-Amplifier Factor(dB)
3. The other emission levels were very low against the limit.
4. Margin value = Emission Level – Limit value

CHANNEL	TX Channel 48	DETECTOR FUNCTION	Quasi-Peak (QP)
FREQUENCY RANGE	9kHz ~ 1GHz		

ANTENNA POLARITY & TEST DISTANCE: HORIZONTAL AT 3 M

NO.	FREQ. (MHz)	EMISSION LEVEL (dBuV/m)	LIMIT (dBuV/m)	MARGIN (dB)	ANTENNA HEIGHT (m)	TABLE ANGLE (Degree)	RAW VALUE (dBuV)	CORRECTION FACTOR (dB/m)
1	30.61	30.9 QP	40.0	-9.1	2.00 H	250	40.9	-10.0
2	114.43	25.7 QP	43.5	-17.8	1.45 H	57	36.8	-11.1
3	249.76	34.1 QP	46.0	-11.9	1.05 H	62	44.1	-10.0
4	320.57	34.0 QP	46.0	-12.0	1.05 H	42	41.4	-7.4
5	497.81	27.9 QP	46.0	-18.1	1.49 H	50	30.7	-2.8
6	920.61	30.8 QP	46.0	-15.2	2.51 H	84	26.6	4.2

ANTENNA POLARITY & TEST DISTANCE: VERTICAL AT 3 M

NO.	FREQ. (MHz)	EMISSION LEVEL (dBuV/m)	LIMIT (dBuV/m)	MARGIN (dB)	ANTENNA HEIGHT (m)	TABLE ANGLE (Degree)	RAW VALUE (dBuV)	CORRECTION FACTOR (dB/m)
1	30.71	32.6 QP	40.0	-7.4	1.95 V	330	42.6	-10.0
2	42.60	30.0 QP	40.0	-10.0	1.01 V	348	38.9	-8.9
3	249.79	27.7 QP	46.0	-18.3	1.53 V	360	37.7	-10.0
4	320.55	26.5 QP	46.0	-19.5	1.56 V	355	33.9	-7.4
5	497.55	26.1 QP	46.0	-19.9	1.05 V	283	28.9	-2.8
6	926.01	29.8 QP	46.0	-16.2	2.51 V	66	25.5	4.3

REMARKS:

1. Emission Level(dBuV/m) = Raw Value(dBuV) + Correction Factor(dB/m)
2. Correction Factor(dB/m) = Antenna Factor(dB/m) + Cable Factor(dB) – Pre-Amplifier Factor(dB)
3. The other emission levels were very low against the limit.
4. Margin value = Emission Level – Limit value

CHANNEL	TX Channel 149	DETECTOR FUNCTION	Quasi-Peak (QP)
FREQUENCY RANGE	9kHz ~ 1GHz		

ANTENNA POLARITY & TEST DISTANCE: HORIZONTAL AT 3 M

NO.	FREQ. (MHz)	EMISSION LEVEL (dBuV/m)	LIMIT (dBuV/m)	MARGIN (dB)	ANTENNA HEIGHT (m)	TABLE ANGLE (Degree)	RAW VALUE (dBuV)	CORRECTION FACTOR (dB/m)
1	30.97	31.1 QP	40.0	-8.9	2.05 H	241	41.1	-10.0
2	114.51	25.6 QP	43.5	-17.9	1.53 H	67	36.7	-11.1
3	249.90	33.9 QP	46.0	-12.1	1.05 H	79	43.9	-10.0
4	320.78	33.6 QP	46.0	-12.4	1.00 H	58	41.0	-7.4
5	497.82	27.8 QP	46.0	-18.2	1.51 H	55	30.6	-2.8
6	920.61	30.7 QP	46.0	-15.3	2.51 H	80	26.5	4.2

ANTENNA POLARITY & TEST DISTANCE: VERTICAL AT 3 M

NO.	FREQ. (MHz)	EMISSION LEVEL (dBuV/m)	LIMIT (dBuV/m)	MARGIN (dB)	ANTENNA HEIGHT (m)	TABLE ANGLE (Degree)	RAW VALUE (dBuV)	CORRECTION FACTOR (dB/m)
1	30.46	32.6 QP	40.0	-7.4	1.96 V	333	42.5	-9.9
2	42.58	30.0 QP	40.0	-10.0	1.06 V	356	38.9	-8.9
3	250.04	27.8 QP	46.0	-18.2	1.52 V	360	37.8	-10.0
4	320.49	26.8 QP	46.0	-19.2	1.50 V	346	34.2	-7.4
5	497.14	26.2 QP	46.0	-19.8	1.00 V	283	29.0	-2.8
6	926.01	30.1 QP	46.0	-15.9	2.54 V	64	25.8	4.3

REMARKS:

1. Emission Level(dBuV/m) = Raw Value(dBuV) + Correction Factor(dB/m)
2. Correction Factor(dB/m) = Antenna Factor(dB/m) + Cable Factor(dB) – Pre-Amplifier Factor(dB)
3. The other emission levels were very low against the limit.
4. Margin value = Emission Level – Limit value

CHANNEL	TX Channel 157	DETECTOR FUNCTION	Quasi-Peak (QP)
FREQUENCY RANGE	9kHz ~ 1GHz		

ANTENNA POLARITY & TEST DISTANCE: HORIZONTAL AT 3 M

NO.	FREQ. (MHz)	EMISSION LEVEL (dBuV/m)	LIMIT (dBuV/m)	MARGIN (dB)	ANTENNA HEIGHT (m)	TABLE ANGLE (Degree)	RAW VALUE (dBuV)	CORRECTION FACTOR (dB/m)
1	30.94	30.8 QP	40.0	-9.2	2.03 H	261	40.8	-10.0
2	114.19	25.8 QP	43.5	-17.7	1.56 H	61	36.9	-11.1
3	249.71	34.2 QP	46.0	-11.8	1.00 H	89	44.2	-10.0
4	320.65	33.7 QP	46.0	-12.3	1.00 H	46	41.1	-7.4
5	497.82	27.7 QP	46.0	-18.3	1.54 H	65	30.5	-2.8
6	920.61	31.0 QP	46.0	-15.0	2.53 H	92	26.8	4.2

ANTENNA POLARITY & TEST DISTANCE: VERTICAL AT 3 M

NO.	FREQ. (MHz)	EMISSION LEVEL (dBuV/m)	LIMIT (dBuV/m)	MARGIN (dB)	ANTENNA HEIGHT (m)	TABLE ANGLE (Degree)	RAW VALUE (dBuV)	CORRECTION FACTOR (dB/m)
1	30.57	32.9 QP	40.0	-7.1	1.97 V	325	42.8	-9.9
2	42.71	29.8 QP	40.0	-10.2	1.00 V	359	38.6	-8.8
3	250.14	27.9 QP	46.0	-18.1	1.50 V	357	37.9	-10.0
4	320.89	26.8 QP	46.0	-19.2	1.48 V	350	34.2	-7.4
5	497.15	26.2 QP	46.0	-19.8	1.00 V	280	29.0	-2.8
6	926.01	29.7 QP	46.0	-16.3	2.46 V	63	25.4	4.3

REMARKS:

1. Emission Level(dBuV/m) = Raw Value(dBuV) + Correction Factor(dB/m)
2. Correction Factor(dB/m) = Antenna Factor(dB/m) + Cable Factor(dB) – Pre-Amplifier Factor(dB)
3. The other emission levels were very low against the limit.
4. Margin value = Emission Level – Limit value

CHANNEL	TX Channel 165	DETECTOR FUNCTION	Quasi-Peak (QP)
FREQUENCY RANGE	9kHz ~ 1GHz		

ANTENNA POLARITY & TEST DISTANCE: HORIZONTAL AT 3 M

NO.	FREQ. (MHz)	EMISSION LEVEL (dBuV/m)	LIMIT (dBuV/m)	MARGIN (dB)	ANTENNA HEIGHT (m)	TABLE ANGLE (Degree)	RAW VALUE (dBuV)	CORRECTION FACTOR (dB/m)
1	30.91	31.0 QP	40.0	-9.0	1.99 H	242	41.0	-10.0
2	114.34	25.4 QP	43.5	-18.1	1.53 H	71	36.5	-11.1
3	249.93	34.0 QP	46.0	-12.0	1.00 H	84	44.0	-10.0
4	320.53	33.9 QP	46.0	-12.1	1.00 H	31	41.3	-7.4
5	497.73	27.6 QP	46.0	-18.4	1.49 H	60	30.4	-2.8
6	920.61	31.1 QP	46.0	-14.9	2.48 H	85	26.9	4.2

ANTENNA POLARITY & TEST DISTANCE: VERTICAL AT 3 M

NO.	FREQ. (MHz)	EMISSION LEVEL (dBuV/m)	LIMIT (dBuV/m)	MARGIN (dB)	ANTENNA HEIGHT (m)	TABLE ANGLE (Degree)	RAW VALUE (dBuV)	CORRECTION FACTOR (dB/m)
1	30.52	32.7 QP	40.0	-7.3	1.98 V	333	42.6	-9.9
2	42.61	29.8 QP	40.0	-10.2	1.00 V	355	38.7	-8.9
3	250.23	27.6 QP	46.0	-18.4	1.49 V	360	37.6	-10.0
4	320.84	26.6 QP	46.0	-19.4	1.54 V	346	34.0	-7.4
5	497.53	26.3 QP	46.0	-19.7	1.01 V	295	29.1	-2.8
6	926.01	30.0 QP	46.0	-16.0	2.54 V	62	25.7	4.3

REMARKS:

1. Emission Level(dBuV/m) = Raw Value(dBuV) + Correction Factor(dB/m)
2. Correction Factor(dB/m) = Antenna Factor(dB/m) + Cable Factor(dB) – Pre-Amplifier Factor(dB)
3. The other emission levels were very low against the limit.
4. Margin value = Emission Level – Limit value

802.11ac (VHT20)

CHANNEL	TX Channel 36	DETECTOR FUNCTION	Quasi-Peak (QP)
FREQUENCY RANGE	9kHz ~ 1GHz		

ANTENNA POLARITY & TEST DISTANCE: HORIZONTAL AT 3 M

NO.	FREQ. (MHz)	EMISSION LEVEL (dBuV/m)	LIMIT (dBuV/m)	MARGIN (dB)	ANTENNA HEIGHT (m)	TABLE ANGLE (Degree)	RAW VALUE (dBuV)	CORRECTION FACTOR (dB/m)
1	30.54	31.0 QP	40.0	-9.0	2.00 H	259	40.9	-9.9
2	114.55	25.5 QP	43.5	-18.0	1.54 H	80	36.6	-11.1
3	249.70	34.0 QP	46.0	-12.0	1.03 H	73	44.0	-10.0
4	320.81	33.7 QP	46.0	-12.3	1.00 H	45	41.1	-7.4
5	497.64	27.9 QP	46.0	-18.1	1.46 H	42	30.7	-2.8
6	920.61	30.7 QP	46.0	-15.3	2.52 H	82	26.5	4.2

ANTENNA POLARITY & TEST DISTANCE: VERTICAL AT 3 M

NO.	FREQ. (MHz)	EMISSION LEVEL (dBuV/m)	LIMIT (dBuV/m)	MARGIN (dB)	ANTENNA HEIGHT (m)	TABLE ANGLE (Degree)	RAW VALUE (dBuV)	CORRECTION FACTOR (dB/m)
1	30.63	32.9 QP	40.0	-7.1	1.97 V	316	42.9	-10.0
2	42.49	29.8 QP	40.0	-10.2	1.05 V	360	38.7	-8.9
3	250.16	27.9 QP	46.0	-18.1	1.54 V	346	37.9	-10.0
4	320.98	26.8 QP	46.0	-19.2	1.52 V	360	34.2	-7.4
5	497.20	26.1 QP	46.0	-19.9	1.00 V	303	28.9	-2.8
6	926.01	29.9 QP	46.0	-16.1	2.47 V	72	25.6	4.3

REMARKS:

1. Emission Level(dBuV/m) = Raw Value(dBuV) + Correction Factor(dB/m)
2. Correction Factor(dB/m) = Antenna Factor(dB/m) + Cable Factor(dB) – Pre-Amplifier Factor(dB)
3. The other emission levels were very low against the limit.
4. Margin value = Emission Level – Limit value

CHANNEL	TX Channel 40	DETECTOR FUNCTION	Quasi-Peak (QP)
FREQUENCY RANGE	9kHz ~ 1GHz		

ANTENNA POLARITY & TEST DISTANCE: HORIZONTAL AT 3 M

NO.	FREQ. (MHz)	EMISSION LEVEL (dBuV/m)	LIMIT (dBuV/m)	MARGIN (dB)	ANTENNA HEIGHT (m)	TABLE ANGLE (Degree)	RAW VALUE (dBuV)	CORRECTION FACTOR (dB/m)
1	30.55	31.1 QP	40.0	-8.9	2.02 H	255	41.0	-9.9
2	114.45	25.7 QP	43.5	-17.8	1.50 H	57	36.8	-11.1
3	249.81	34.3 QP	46.0	-11.7	1.00 H	81	44.3	-10.0
4	320.74	33.8 QP	46.0	-12.2	1.00 H	35	41.2	-7.4
5	497.91	27.5 QP	46.0	-18.5	1.52 H	56	30.3	-2.8
6	920.61	30.7 QP	46.0	-15.3	2.46 H	79	26.5	4.2

ANTENNA POLARITY & TEST DISTANCE: VERTICAL AT 3 M

NO.	FREQ. (MHz)	EMISSION LEVEL (dBuV/m)	LIMIT (dBuV/m)	MARGIN (dB)	ANTENNA HEIGHT (m)	TABLE ANGLE (Degree)	RAW VALUE (dBuV)	CORRECTION FACTOR (dB/m)
1	30.47	32.6 QP	40.0	-7.4	1.94 V	320	42.5	-9.9
2	42.65	30.1 QP	40.0	-9.9	1.03 V	360	39.0	-8.9
3	250.02	27.6 QP	46.0	-18.4	1.55 V	360	37.6	-10.0
4	320.41	26.4 QP	46.0	-19.6	1.54 V	349	33.8	-7.4
5	497.45	26.4 QP	46.0	-19.6	1.00 V	299	29.2	-2.8
6	926.01	30.2 QP	46.0	-15.8	2.51 V	76	25.9	4.3

REMARKS:

1. Emission Level(dBuV/m) = Raw Value(dBuV) + Correction Factor(dB/m)
2. Correction Factor(dB/m) = Antenna Factor(dB/m) + Cable Factor(dB) – Pre-Amplifier Factor(dB)
3. The other emission levels were very low against the limit.
4. Margin value = Emission Level – Limit value

CHANNEL	TX Channel 48	DETECTOR FUNCTION	Quasi-Peak (QP)
FREQUENCY RANGE	9kHz ~ 1GHz		

ANTENNA POLARITY & TEST DISTANCE: HORIZONTAL AT 3 M

NO.	FREQ. (MHz)	EMISSION LEVEL (dBuV/m)	LIMIT (dBuV/m)	MARGIN (dB)	ANTENNA HEIGHT (m)	TABLE ANGLE (Degree)	RAW VALUE (dBuV)	CORRECTION FACTOR (dB/m)
1	30.58	31.0 QP	40.0	-9.0	2.02 H	242	41.0	-10.0
2	114.08	25.6 QP	43.5	-17.9	1.47 H	85	36.7	-11.1
3	249.81	33.8 QP	46.0	-12.2	1.06 H	65	43.8	-10.0
4	320.81	33.4 QP	46.0	-12.6	1.00 H	58	40.8	-7.4
5	497.83	27.4 QP	46.0	-18.6	1.46 H	52	30.2	-2.8
6	920.61	30.8 QP	46.0	-15.2	2.55 H	104	26.6	4.2

ANTENNA POLARITY & TEST DISTANCE: VERTICAL AT 3 M

NO.	FREQ. (MHz)	EMISSION LEVEL (dBuV/m)	LIMIT (dBuV/m)	MARGIN (dB)	ANTENNA HEIGHT (m)	TABLE ANGLE (Degree)	RAW VALUE (dBuV)	CORRECTION FACTOR (dB/m)
1	30.71	32.7 QP	40.0	-7.3	2.02 V	321	42.7	-10.0
2	42.86	30.0 QP	40.0	-10.0	1.05 V	347	38.8	-8.8
3	250.11	27.5 QP	46.0	-18.5	1.46 V	360	37.5	-10.0
4	320.55	26.7 QP	46.0	-19.3	1.52 V	360	34.1	-7.4
5	497.32	26.0 QP	46.0	-20.0	1.05 V	284	28.8	-2.8
6	926.01	30.1 QP	46.0	-15.9	2.46 V	63	25.8	4.3

REMARKS:

1. Emission Level(dBuV/m) = Raw Value(dBuV) + Correction Factor(dB/m)
2. Correction Factor(dB/m) = Antenna Factor(dB/m) + Cable Factor(dB) – Pre-Amplifier Factor(dB)
3. The other emission levels were very low against the limit.
4. Margin value = Emission Level – Limit value

CHANNEL	TX Channel 149	DETECTOR FUNCTION	Quasi-Peak (QP)
FREQUENCY RANGE	9kHz ~ 1GHz		

ANTENNA POLARITY & TEST DISTANCE: HORIZONTAL AT 3 M

NO.	FREQ. (MHz)	EMISSION LEVEL (dBuV/m)	LIMIT (dBuV/m)	MARGIN (dB)	ANTENNA HEIGHT (m)	TABLE ANGLE (Degree)	RAW VALUE (dBuV)	CORRECTION FACTOR (dB/m)
1	30.72	30.8 QP	40.0	-9.2	1.95 H	262	40.8	-10.0
2	114.16	25.6 QP	43.5	-17.9	1.48 H	66	36.7	-11.1
3	250.15	34.4 QP	46.0	-11.6	1.04 H	67	44.4	-10.0
4	320.98	33.5 QP	46.0	-12.5	1.03 H	56	40.9	-7.4
5	497.87	28.0 QP	46.0	-18.0	1.54 H	39	30.8	-2.8
6	920.61	31.0 QP	46.0	-15.0	2.54 H	89	26.8	4.2

ANTENNA POLARITY & TEST DISTANCE: VERTICAL AT 3 M

NO.	FREQ. (MHz)	EMISSION LEVEL (dBuV/m)	LIMIT (dBuV/m)	MARGIN (dB)	ANTENNA HEIGHT (m)	TABLE ANGLE (Degree)	RAW VALUE (dBuV)	CORRECTION FACTOR (dB/m)
1	30.58	32.8 QP	40.0	-7.2	2.04 V	324	42.8	-10.0
2	42.53	29.6 QP	40.0	-10.4	1.05 V	347	38.5	-8.9
3	250.03	27.7 QP	46.0	-18.3	1.51 V	360	37.7	-10.0
4	320.92	26.6 QP	46.0	-19.4	1.46 V	360	34.0	-7.4
5	497.40	26.0 QP	46.0	-20.0	1.00 V	297	28.8	-2.8
6	926.01	30.0 QP	46.0	-16.0	2.51 V	58	25.7	4.3

REMARKS:

1. Emission Level(dBuV/m) = Raw Value(dBuV) + Correction Factor(dB/m)
2. Correction Factor(dB/m) = Antenna Factor(dB/m) + Cable Factor(dB) – Pre-Amplifier Factor(dB)
3. The other emission levels were very low against the limit.
4. Margin value = Emission Level – Limit value

CHANNEL	TX Channel 157	DETECTOR FUNCTION	Quasi-Peak (QP)
FREQUENCY RANGE	9kHz ~ 1GHz		

ANTENNA POLARITY & TEST DISTANCE: HORIZONTAL AT 3 M

NO.	FREQ. (MHz)	EMISSION LEVEL (dBuV/m)	LIMIT (dBuV/m)	MARGIN (dB)	ANTENNA HEIGHT (m)	TABLE ANGLE (Degree)	RAW VALUE (dBuV)	CORRECTION FACTOR (dB/m)
1	30.79	30.9 QP	40.0	-9.1	1.95 H	268	40.9	-10.0
2	114.30	25.5 QP	43.5	-18.0	1.50 H	54	36.6	-11.1
3	250.05	34.3 QP	46.0	-11.7	1.06 H	74	44.3	-10.0
4	320.65	33.4 QP	46.0	-12.6	1.00 H	49	40.8	-7.4
5	497.85	27.8 QP	46.0	-18.2	1.47 H	39	30.6	-2.8
6	920.61	30.7 QP	46.0	-15.3	2.53 H	105	26.5	4.2

ANTENNA POLARITY & TEST DISTANCE: VERTICAL AT 3 M

NO.	FREQ. (MHz)	EMISSION LEVEL (dBuV/m)	LIMIT (dBuV/m)	MARGIN (dB)	ANTENNA HEIGHT (m)	TABLE ANGLE (Degree)	RAW VALUE (dBuV)	CORRECTION FACTOR (dB/m)
1	30.38	32.9 QP	40.0	-7.1	2.06 V	331	42.8	-9.9
2	42.33	29.7 QP	40.0	-10.3	1.00 V	345	38.6	-8.9
3	249.95	27.6 QP	46.0	-18.4	1.45 V	351	37.6	-10.0
4	320.71	26.5 QP	46.0	-19.5	1.48 V	360	33.9	-7.4
5	497.54	25.9 QP	46.0	-20.1	1.00 V	290	28.7	-2.8
6	926.01	30.0 QP	46.0	-16.0	2.50 V	61	25.7	4.3

REMARKS:

1. Emission Level(dBuV/m) = Raw Value(dBuV) + Correction Factor(dB/m)
2. Correction Factor(dB/m) = Antenna Factor(dB/m) + Cable Factor(dB) – Pre-Amplifier Factor(dB)
3. The other emission levels were very low against the limit.
4. Margin value = Emission Level – Limit value

CHANNEL	TX Channel 165	DETECTOR FUNCTION	Quasi-Peak (QP)
FREQUENCY RANGE	9kHz ~ 1GHz		

ANTENNA POLARITY & TEST DISTANCE: HORIZONTAL AT 3 M

NO.	FREQ. (MHz)	EMISSION LEVEL (dBuV/m)	LIMIT (dBuV/m)	MARGIN (dB)	ANTENNA HEIGHT (m)	TABLE ANGLE (Degree)	RAW VALUE (dBuV)	CORRECTION FACTOR (dB/m)
1	30.67	31.0 QP	40.0	-9.0	1.98 H	244	41.0	-10.0
2	114.33	25.6 QP	43.5	-17.9	1.46 H	84	36.7	-11.1
3	250.21	34.1 QP	46.0	-11.9	1.00 H	86	44.1	-10.0
4	320.45	33.6 QP	46.0	-12.4	1.00 H	41	41.0	-7.4
5	497.90	27.4 QP	46.0	-18.6	1.44 H	67	30.2	-2.8
6	920.61	30.6 QP	46.0	-15.4	2.46 H	92	26.4	4.2

ANTENNA POLARITY & TEST DISTANCE: VERTICAL AT 3 M

NO.	FREQ. (MHz)	EMISSION LEVEL (dBuV/m)	LIMIT (dBuV/m)	MARGIN (dB)	ANTENNA HEIGHT (m)	TABLE ANGLE (Degree)	RAW VALUE (dBuV)	CORRECTION FACTOR (dB/m)
1	30.59	32.6 QP	40.0	-7.4	2.06 V	336	42.6	-10.0
2	42.84	29.5 QP	40.0	-10.5	1.00 V	360	38.3	-8.8
3	249.95	27.5 QP	46.0	-18.5	1.50 V	349	37.5	-10.0
4	320.62	26.8 QP	46.0	-19.2	1.48 V	360	34.2	-7.4
5	497.18	25.9 QP	46.0	-20.1	1.00 V	292	28.7	-2.8
6	926.01	30.2 QP	46.0	-15.8	2.47 V	49	25.9	4.3

REMARKS:

1. Emission Level(dBuV/m) = Raw Value(dBuV) + Correction Factor(dB/m)
2. Correction Factor(dB/m) = Antenna Factor(dB/m) + Cable Factor(dB) – Pre-Amplifier Factor(dB)
3. The other emission levels were very low against the limit.
4. Margin value = Emission Level – Limit value

802.11ac (VHT40)

CHANNEL	TX Channel 38	DETECTOR FUNCTION	Quasi-Peak (QP)
FREQUENCY RANGE	9kHz ~ 1GHz		

ANTENNA POLARITY & TEST DISTANCE: HORIZONTAL AT 3 M

NO.	FREQ. (MHz)	EMISSION LEVEL (dBuV/m)	LIMIT (dBuV/m)	MARGIN (dB)	ANTENNA HEIGHT (m)	TABLE ANGLE (Degree)	RAW VALUE (dBuV)	CORRECTION FACTOR (dB/m)
1	30.96	30.8 QP	40.0	-9.2	2.04 H	268	40.8	-10.0
2	114.16	25.6 QP	43.5	-17.9	1.50 H	78	36.7	-11.1
3	250.24	34.0 QP	46.0	-12.0	1.00 H	88	44.0	-10.0
4	320.41	33.9 QP	46.0	-12.1	1.00 H	40	41.3	-7.4
5	497.95	27.7 QP	46.0	-18.3	1.47 H	62	30.5	-2.8
6	920.61	30.8 QP	46.0	-15.2	2.45 H	99	26.6	4.2

ANTENNA POLARITY & TEST DISTANCE: VERTICAL AT 3 M

NO.	FREQ. (MHz)	EMISSION LEVEL (dBuV/m)	LIMIT (dBuV/m)	MARGIN (dB)	ANTENNA HEIGHT (m)	TABLE ANGLE (Degree)	RAW VALUE (dBuV)	CORRECTION FACTOR (dB/m)
1	30.78	32.6 QP	40.0	-7.4	1.95 V	315	42.6	-10.0
2	42.62	29.7 QP	40.0	-10.3	1.00 V	359	38.6	-8.9
3	249.78	27.7 QP	46.0	-18.3	1.53 V	346	37.7	-10.0
4	320.60	26.9 QP	46.0	-19.1	1.52 V	360	34.3	-7.4
5	497.30	26.1 QP	46.0	-19.9	1.00 V	304	28.9	-2.8
6	926.01	29.8 QP	46.0	-16.2	2.50 V	62	25.5	4.3

REMARKS:

1. Emission Level(dBuV/m) = Raw Value(dBuV) + Correction Factor(dB/m)
2. Correction Factor(dB/m) = Antenna Factor(dB/m) + Cable Factor(dB) – Pre-Amplifier Factor(dB)
3. The other emission levels were very low against the limit.
4. Margin value = Emission Level – Limit value

CHANNEL	TX Channel 46	DETECTOR FUNCTION	Quasi-Peak (QP)
FREQUENCY RANGE	9kHz ~ 1GHz		

ANTENNA POLARITY & TEST DISTANCE: HORIZONTAL AT 3 M

NO.	FREQ. (MHz)	EMISSION LEVEL (dBuV/m)	LIMIT (dBuV/m)	MARGIN (dB)	ANTENNA HEIGHT (m)	TABLE ANGLE (Degree)	RAW VALUE (dBuV)	CORRECTION FACTOR (dB/m)
1	30.83	30.9 QP	40.0	-9.1	2.03 H	259	40.9	-10.0
2	114.15	25.5 QP	43.5	-18.0	1.55 H	60	36.6	-11.1
3	249.82	34.3 QP	46.0	-11.7	1.06 H	65	44.3	-10.0
4	320.75	33.6 QP	46.0	-12.4	1.00 H	35	41.0	-7.4
5	497.57	27.6 QP	46.0	-18.4	1.55 H	49	30.4	-2.8
6	920.61	30.7 QP	46.0	-15.3	2.54 H	108	26.5	4.2

ANTENNA POLARITY & TEST DISTANCE: VERTICAL AT 3 M

NO.	FREQ. (MHz)	EMISSION LEVEL (dBuV/m)	LIMIT (dBuV/m)	MARGIN (dB)	ANTENNA HEIGHT (m)	TABLE ANGLE (Degree)	RAW VALUE (dBuV)	CORRECTION FACTOR (dB/m)
1	30.65	32.8 QP	40.0	-7.2	2.01 V	332	42.8	-10.0
2	42.89	29.6 QP	40.0	-10.4	1.01 V	355	38.4	-8.8
3	250.26	27.6 QP	46.0	-18.4	1.50 V	351	37.6	-10.0
4	320.59	26.9 QP	46.0	-19.1	1.54 V	360	34.3	-7.4
5	497.42	26.1 QP	46.0	-19.9	1.03 V	297	28.9	-2.8
6	926.01	30.2 QP	46.0	-15.8	2.45 V	53	25.9	4.3

REMARKS:

1. Emission Level(dBuV/m) = Raw Value(dBuV) + Correction Factor(dB/m)
2. Correction Factor(dB/m) = Antenna Factor(dB/m) + Cable Factor(dB) – Pre-Amplifier Factor(dB)
3. The other emission levels were very low against the limit.
4. Margin value = Emission Level – Limit value

CHANNEL	TX Channel 151	DETECTOR FUNCTION	Quasi-Peak (QP)
FREQUENCY RANGE	9kHz ~ 1GHz		

ANTENNA POLARITY & TEST DISTANCE: HORIZONTAL AT 3 M

NO.	FREQ. (MHz)	EMISSION LEVEL (dBuV/m)	LIMIT (dBuV/m)	MARGIN (dB)	ANTENNA HEIGHT (m)	TABLE ANGLE (Degree)	RAW VALUE (dBuV)	CORRECTION FACTOR (dB/m)
1	30.71	30.7 QP	40.0	-9.3	1.95 H	268	40.7	-10.0
2	114.37	25.5 QP	43.5	-18.0	1.50 H	58	36.6	-11.1
3	249.72	34.1 QP	46.0	-11.9	1.05 H	64	44.1	-10.0
4	320.73	33.9 QP	46.0	-12.1	1.01 H	32	41.3	-7.4
5	497.87	27.7 QP	46.0	-18.3	1.48 H	69	30.5	-2.8
6	920.61	30.5 QP	46.0	-15.5	2.53 H	79	26.3	4.2

ANTENNA POLARITY & TEST DISTANCE: VERTICAL AT 3 M

NO.	FREQ. (MHz)	EMISSION LEVEL (dBuV/m)	LIMIT (dBuV/m)	MARGIN (dB)	ANTENNA HEIGHT (m)	TABLE ANGLE (Degree)	RAW VALUE (dBuV)	CORRECTION FACTOR (dB/m)
1	30.70	32.7 QP	40.0	-7.3	2.00 V	328	42.7	-10.0
2	42.89	29.9 QP	40.0	-10.1	1.01 V	360	38.7	-8.8
3	249.91	27.5 QP	46.0	-18.5	1.48 V	360	37.5	-10.0
4	320.57	26.5 QP	46.0	-19.5	1.45 V	360	33.9	-7.4
5	497.41	26.0 QP	46.0	-20.0	1.05 V	297	28.8	-2.8
6	926.01	29.8 QP	46.0	-16.2	2.44 V	51	25.5	4.3

REMARKS:

1. Emission Level(dBuV/m) = Raw Value(dBuV) + Correction Factor(dB/m)
2. Correction Factor(dB/m) = Antenna Factor(dB/m) + Cable Factor(dB) – Pre-Amplifier Factor(dB)
3. The other emission levels were very low against the limit.
4. Margin value = Emission Level – Limit value

CHANNEL	TX Channel 159	DETECTOR FUNCTION	Quasi-Peak (QP)
FREQUENCY RANGE	9kHz ~ 1GHz		

ANTENNA POLARITY & TEST DISTANCE: HORIZONTAL AT 3 M

NO.	FREQ. (MHz)	EMISSION LEVEL (dBuV/m)	LIMIT (dBuV/m)	MARGIN (dB)	ANTENNA HEIGHT (m)	TABLE ANGLE (Degree)	RAW VALUE (dBuV)	CORRECTION FACTOR (dB/m)
1	30.51	30.8 QP	40.0	-9.2	2.02 H	262	40.7	-9.9
2	114.29	25.6 QP	43.5	-17.9	1.47 H	85	36.7	-11.1
3	249.81	34.1 QP	46.0	-11.9	1.05 H	62	44.1	-10.0
4	320.45	33.8 QP	46.0	-12.2	1.00 H	41	41.2	-7.4
5	497.67	27.4 QP	46.0	-18.6	1.52 H	44	30.2	-2.8
6	920.61	31.0 QP	46.0	-15.0	2.45 H	79	26.8	4.2

ANTENNA POLARITY & TEST DISTANCE: VERTICAL AT 3 M

NO.	FREQ. (MHz)	EMISSION LEVEL (dBuV/m)	LIMIT (dBuV/m)	MARGIN (dB)	ANTENNA HEIGHT (m)	TABLE ANGLE (Degree)	RAW VALUE (dBuV)	CORRECTION FACTOR (dB/m)
1	30.94	32.7 QP	40.0	-7.3	2.01 V	316	42.7	-10.0
2	42.70	29.6 QP	40.0	-10.4	1.00 V	360	38.5	-8.9
3	249.96	27.7 QP	46.0	-18.3	1.48 V	360	37.7	-10.0
4	320.95	26.7 QP	46.0	-19.3	1.50 V	354	34.1	-7.4
5	497.03	26.2 QP	46.0	-19.8	1.00 V	278	29.0	-2.8
6	926.01	29.9 QP	46.0	-16.1	2.50 V	55	25.6	4.3

REMARKS:

1. Emission Level(dBuV/m) = Raw Value(dBuV) + Correction Factor(dB/m)
2. Correction Factor(dB/m) = Antenna Factor(dB/m) + Cable Factor(dB) – Pre-Amplifier Factor(dB)
3. The other emission levels were very low against the limit.
4. Margin value = Emission Level – Limit value

802.11ac (VHT80)

CHANNEL	TX Channel 42	DETECTOR FUNCTION	Quasi-Peak (QP)
FREQUENCY RANGE	9kHz ~ 1GHz		

ANTENNA POLARITY & TEST DISTANCE: HORIZONTAL AT 3 M								
NO.	FREQ. (MHz)	EMISSION LEVEL (dBuV/m)	LIMIT (dBuV/m)	MARGIN (dB)	ANTENNA HEIGHT (m)	TABLE ANGLE (Degree)	RAW VALUE (dBuV)	CORRECTION FACTOR (dB/m)
1	30.71	30.6 QP	40.0	-9.4	1.95 H	241	40.6	-10.0
2	114.57	25.6 QP	43.5	-17.9	1.52 H	84	36.7	-11.1
3	249.94	34.1 QP	46.0	-11.9	1.03 H	82	44.1	-10.0
4	320.84	33.6 QP	46.0	-12.4	1.02 H	52	41.0	-7.4
5	497.86	27.6 QP	46.0	-18.4	1.46 H	65	30.4	-2.8
6	920.61	30.8 QP	46.0	-15.2	2.48 H	90	26.6	4.2

ANTENNA POLARITY & TEST DISTANCE: VERTICAL AT 3 M								
NO.	FREQ. (MHz)	EMISSION LEVEL (dBuV/m)	LIMIT (dBuV/m)	MARGIN (dB)	ANTENNA HEIGHT (m)	TABLE ANGLE (Degree)	RAW VALUE (dBuV)	CORRECTION FACTOR (dB/m)
1	30.67	32.9 QP	40.0	-7.1	1.94 V	334	42.9	-10.0
2	42.70	29.9 QP	40.0	-10.1	1.00 V	354	38.8	-8.9
3	249.84	28.0 QP	46.0	-18.0	1.46 V	346	38.0	-10.0
4	320.84	26.7 QP	46.0	-19.3	1.52 V	360	34.1	-7.4
5	497.29	26.2 QP	46.0	-19.8	1.05 V	283	29.0	-2.8
6	926.01	29.8 QP	46.0	-16.2	2.51 V	56	25.5	4.3

REMARKS:

1. Emission Level(dBuV/m) = Raw Value(dBuV) + Correction Factor(dB/m)
2. Correction Factor(dB/m) = Antenna Factor(dB/m) + Cable Factor(dB) – Pre-Amplifier Factor(dB)
3. The other emission levels were very low against the limit.
4. Margin value = Emission Level – Limit value

CHANNEL	TX Channel 155	DETECTOR FUNCTION	Quasi-Peak (QP)
FREQUENCY RANGE	9kHz ~ 1GHz		

ANTENNA POLARITY & TEST DISTANCE: HORIZONTAL AT 3 M

NO.	FREQ. (MHz)	EMISSION LEVEL (dBuV/m)	LIMIT (dBuV/m)	MARGIN (dB)	ANTENNA HEIGHT (m)	TABLE ANGLE (Degree)	RAW VALUE (dBuV)	CORRECTION FACTOR (dB/m)
1	30.47	30.6 QP	40.0	-9.4	1.98 H	261	40.5	-9.9
2	114.38	25.6 QP	43.5	-17.9	1.55 H	77	36.7	-11.1
3	249.94	34.0 QP	46.0	-12.0	1.00 H	87	44.0	-10.0
4	320.55	33.8 QP	46.0	-12.2	1.05 H	43	41.2	-7.4
5	497.54	27.6 QP	46.0	-18.4	1.47 H	53	30.4	-2.8
6	920.61	30.9 QP	46.0	-15.1	2.52 H	104	26.7	4.2

ANTENNA POLARITY & TEST DISTANCE: VERTICAL AT 3 M

NO.	FREQ. (MHz)	EMISSION LEVEL (dBuV/m)	LIMIT (dBuV/m)	MARGIN (dB)	ANTENNA HEIGHT (m)	TABLE ANGLE (Degree)	RAW VALUE (dBuV)	CORRECTION FACTOR (dB/m)
1	30.49	32.4 QP	40.0	-7.6	2.03 V	311	42.3	-9.9
2	42.39	29.7 QP	40.0	-10.3	1.04 V	360	38.6	-8.9
3	250.10	27.7 QP	46.0	-18.3	1.49 V	360	37.7	-10.0
4	320.87	26.7 QP	46.0	-19.3	1.50 V	344	34.1	-7.4
5	497.26	25.9 QP	46.0	-20.1	1.00 V	286	28.7	-2.8
6	926.01	29.8 QP	46.0	-16.2	2.56 V	74	25.5	4.3

REMARKS:

1. Emission Level(dBuV/m) = Raw Value(dBuV) + Correction Factor(dB/m)
2. Correction Factor(dB/m) = Antenna Factor(dB/m) + Cable Factor(dB) – Pre-Amplifier Factor(dB)
3. The other emission levels were very low against the limit.
4. Margin value = Emission Level – Limit value

4.2 Conducted Emission Measurement

4.2.1 Limits of Conducted Emission Measurement

Frequency (MHz)	Conducted Limit (dBuV)	
	Quasi-peak	Average
0.15 - 0.5	66 - 56	56 - 46
0.50 - 5.0	56	46
5.0 - 30.0	60	50

Note: 1. The lower limit shall apply at the transition frequencies.

2. The limit decreases in line with the logarithm of the frequency in the range of 0.15 to 0.50MHz.

4.2.2 Test Instruments

DESCRIPTION & MANUFACTURER	MODEL NO.	SERIAL NO.	CALIBRATED DATE	CALIBRATED UNTIL
Test Receiver R&S	ESCS 30	100287	Apr. 16, 2016	Apr. 15, 2017
Line-Impedance Stabilization Network (for EUT) SCHWARZBECK	NSLK-8127	8127-523	Oct. 11, 2016	Oct. 10, 2017
Line-Impedance Stabilization Network (for Peripheral) R&S	ESH3-Z5	848773/004	Oct. 26, 2016	Oct. 25, 2017
RF Cable	5D-FB	COACAB-001	May 24, 2016	May 23, 2017
10 dB PAD Mini-Circuits	HAT-10+	CONATT-001	Sep. 13, 2016	Sep. 12, 2017
50 ohms Terminator	50	3	Oct. 26, 2016	Oct. 25, 2017
50 ohms Terminator	N/A	EMC-04	Nov. 02, 2016	Nov. 01, 2017
Software BVADT	BVADT_Cond_ V7.3.7.4	NA	NA	NA

Note:

1. The calibration interval of the above test instruments are 12 months and the calibrations are traceable to NML/ROC and NIST/USA.
2. The test was performed in Shielded Room No. A.
3. Tested Date: Nov. 09, 2016

4.2.3 Test Procedure

- The EUT was placed 0.4 meters from the conducting wall of the shielded room with EUT being connected to the power mains through a line impedance stabilization network (LISN). Other support units were connected to the power mains through another LISN. The two LISNs provide 50 ohm/ 50uH of coupling impedance for the measuring instrument.
- Both lines of the power mains connected to the EUT were checked for maximum conducted interference.
- The frequency range from 150kHz to 30MHz was searched. Emission levels under (Limit - 20dB) was not recorded.

NOTE: All modes of operation were investigated and the worst-case emissions are reported.

4.2.4 Deviation from Test Standard

No deviation.

4.2.5 Test Setup

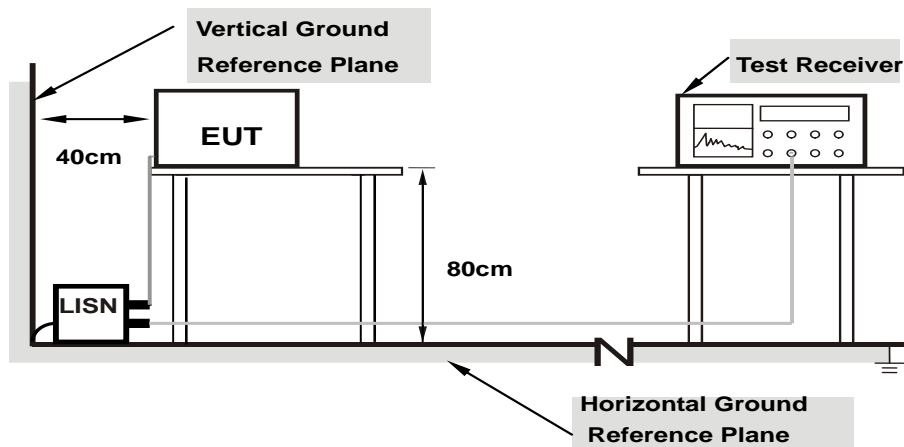

Note: 1.Support units were connected to second LISN.

For the actual test configuration, please refer to the attached file (Test Setup Photo).

4.2.6 EUT Operating Condition

Same as 4.1.6.

4.2.7 Test Results (Mode 1)

Phase	Line (L)	Detector Function	Quasi-Peak (QP) / Average (AV)
-------	----------	-------------------	--------------------------------

Phase Of Power : Line (L)										
No	Frequency (MHz)	Correction Factor (dB)	Reading Value (dBuV)		Emission Level (dBuV)		Limit (dBuV)		Margin (dB)	
			Q.P.	AV.	Q.P.	AV.	Q.P.	AV.	Q.P.	AV.
1	0.15391	10.14	37.08	22.72	47.22	32.86	65.79	55.79	-18.57	-22.93
2	0.16953	10.13	34.52	18.79	44.65	28.92	64.98	54.98	-20.33	-26.06
3	0.19687	10.12	29.89	14.53	40.01	24.65	63.74	53.74	-23.73	-29.09
4	0.41953	10.11	23.10	17.58	33.21	27.69	57.46	47.46	-24.25	-19.77
5	12.56250	10.54	9.35	3.97	19.89	14.51	60.00	50.00	-40.11	-35.49
6	21.55469	10.87	16.43	12.07	27.30	22.94	60.00	50.00	-32.70	-27.06
7	28.18750	11.11	14.75	9.76	25.86	20.87	60.00	50.00	-34.14	-29.13

Remarks:

1. Q.P. and AV. are abbreviations of quasi-peak and average individually.
2. The emission levels of other frequencies were very low against the limit.
3. Margin value = Emission level – Limit value
4. Correction factor = Insertion loss + Cable loss
5. Emission Level = Correction Factor + Reading Value

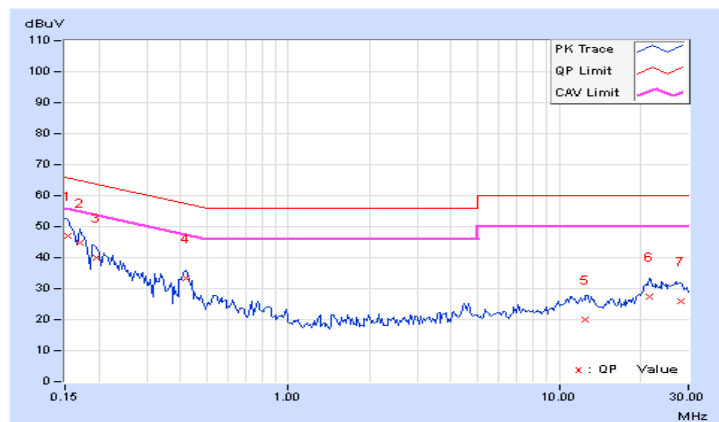

Phase	Neutral (N)	Detector Function	Quasi-Peak (QP) / Average (AV)
-------	-------------	-------------------	--------------------------------

Phase Of Power : Neutral (N)										
No	Frequency (MHz)	Correction Factor (dB)	Reading Value (dBuV)		Emission Level (dBuV)		Limit (dBuV)		Margin (dB)	
			Q.P.	AV.	Q.P.	AV.	Q.P.	AV.	Q.P.	AV.
1	0.16172	10.16	34.72	17.43	44.88	27.59	65.38	55.38	-20.50	-27.79
2	0.17734	10.12	33.59	19.09	43.71	29.21	64.61	54.61	-20.90	-25.40
3	0.19297	10.09	30.72	16.03	40.81	26.12	63.91	53.91	-23.10	-27.79
4	0.20859	10.07	27.65	11.55	37.72	21.62	63.26	53.26	-25.54	-31.64
5	0.41172	10.09	24.56	17.83	34.65	27.92	57.61	47.61	-22.96	-19.69
6	21.97266	10.91	15.02	10.24	25.93	21.15	60.00	50.00	-34.07	-28.85
7	27.53516	11.10	15.64	11.10	26.74	22.20	60.00	50.00	-33.26	-27.80

Remarks:

1. Q.P. and AV. are abbreviations of quasi-peak and average individually.
2. The emission levels of other frequencies were very low against the limit.
3. Margin value = Emission level – Limit value
4. Correction factor = Insertion loss + Cable loss
5. Emission Level = Correction Factor + Reading Value

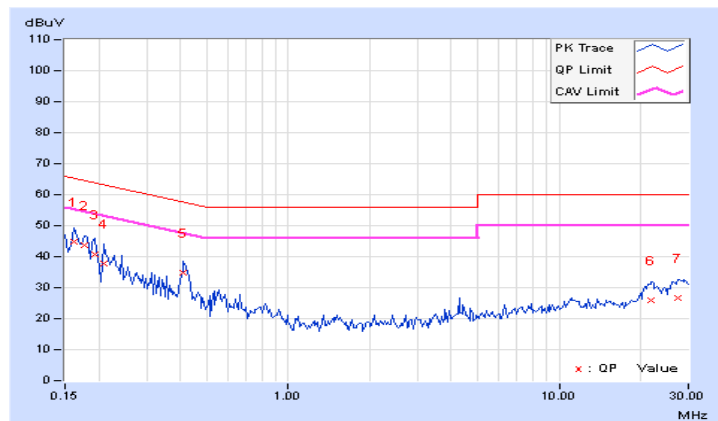

4.2.8 Test Results (Mode 2)

Phase	Line (L)	Detector Function	Quasi-Peak (QP) / Average (AV)
-------	----------	-------------------	--------------------------------

Phase Of Power : Line (L)										
No	Frequency (MHz)	Correction Factor (dB)	Reading Value (dBuV)		Emission Level (dBuV)		Limit (dBuV)		Margin (dB)	
			Q.P.	AV.	Q.P.	AV.	Q.P.	AV.	Q.P.	AV.
1	0.15000	10.14	39.40	30.07	49.54	40.21	66.00	56.00	-16.46	-15.79
2	0.17344	10.13	33.02	21.05	43.15	31.18	64.79	54.79	-21.64	-23.61
3	0.20469	10.12	30.01	20.64	40.13	30.76	63.42	53.42	-23.29	-22.66
4	0.23594	10.12	27.29	20.05	37.41	30.17	62.24	52.24	-24.83	-22.07
5	0.40781	10.11	30.33	22.41	40.44	32.52	57.69	47.69	-17.25	-15.17
6	24.82813	10.99	23.04	18.12	34.03	29.11	60.00	50.00	-25.97	-20.89
7	27.48438	11.08	24.23	19.35	35.31	30.43	60.00	50.00	-24.69	-19.57

Remarks:

1. Q.P. and AV. are abbreviations of quasi-peak and average individually.
2. The emission levels of other frequencies were very low against the limit.
3. Margin value = Emission level – Limit value
4. Correction factor = Insertion loss + Cable loss
5. Emission Level = Correction Factor + Reading Value

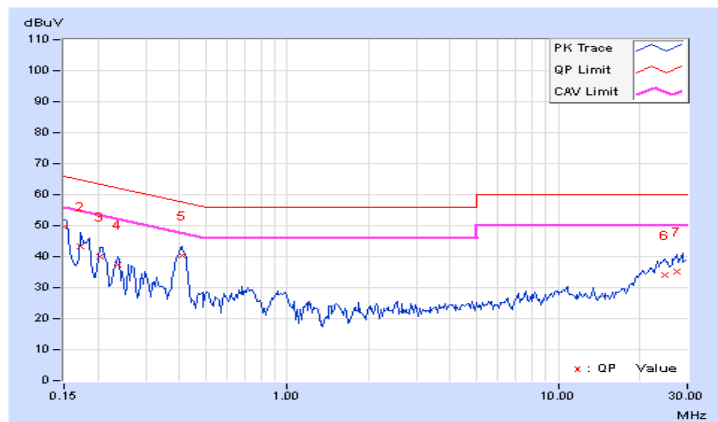

Phase	Neutral (N)	Detector Function	Quasi-Peak (QP) / Average (AV)
-------	-------------	-------------------	--------------------------------

Phase Of Power : Neutral (N)										
No	Frequency (MHz)	Correction Factor (dB)	Reading Value (dBuV)		Emission Level (dBuV)		Limit (dBuV)		Margin (dB)	
			Q.P.	AV.	Q.P.	AV.	Q.P.	AV.	Q.P.	AV.
1	0.15000	10.19	39.50	30.90	49.69	41.09	66.00	56.00	-16.31	-14.91
2	0.16172	10.16	31.48	9.70	41.64	19.86	65.38	55.38	-23.74	-35.52
3	0.18125	10.12	34.19	24.58	44.31	34.70	64.43	54.43	-20.12	-19.73
4	0.21250	10.07	29.99	20.81	40.06	30.88	63.11	53.11	-23.05	-22.23
5	0.40781	10.09	31.94	24.14	42.03	34.23	57.69	47.69	-15.66	-13.46
6	21.26953	10.88	20.73	15.96	31.61	26.84	60.00	50.00	-28.39	-23.16
7	27.83203	11.11	25.78	20.64	36.89	31.75	60.00	50.00	-23.11	-18.25

Remarks:

1. Q.P. and AV. are abbreviations of quasi-peak and average individually.
2. The emission levels of other frequencies were very low against the limit.
3. Margin value = Emission level – Limit value
4. Correction factor = Insertion loss + Cable loss
5. Emission Level = Correction Factor + Reading Value

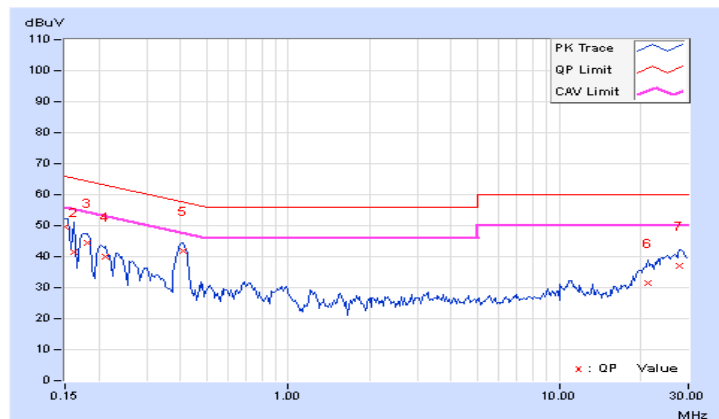

4.3 Transmit Power Measurement

4.3.1 Limits of Transmit Power Measurement

Operation Band	EUT Category		Limit
U-NII-1		Outdoor Access Point	1 Watt (30 dBm) (Max. e.i.r.p \leq 125mW(21 dBm) at any elevation angle above 30 degrees as measured from the horizon)
		Fixed point-to-point Access Point	1 Watt (30 dBm)
	√	Indoor Access Point	1 Watt (30 dBm)
		Mobile and Portable client device	250mW (24 dBm)
U-NII-2A			250mW (24 dBm) or 11 dBm+10 log B*
U-NII-2C			250mW (24 dBm) or 11 dBm+10 log B*
U-NII-3		√	1 Watt (30 dBm)

*B is the 26 dB emission bandwidth in megahertz

Per KDB 662911 Method of conducted output power measurement on IEEE 802.11 devices,

Array Gain = 0 dB (i.e., no array gain) for $N_{ANT} \leq 4$;

Array Gain = 0 dB (i.e., no array gain) for channel widths ≥ 40 MHz for any N_{ANT} ;

Array Gain = $5 \log(N_{ANT}/N_{SS})$ dB or 3 dB, whichever is less for 20-MHz channel widths with $N_{ANT} \geq 5$.

For power measurements on all other devices: Array Gain = $10 \log(N_{ANT}/N_{SS})$ dB.

4.3.2 Test Setup

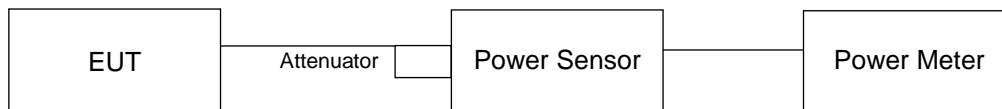

4.3.3 Test Instruments

Refer to section 4.1.2 to get information of above instrument.

4.3.4 Test Procedure

Method PM is used to perform output power measurement, trigger and gating function of wide band power meter is enabled to measure max output power of TX on burst. Duty factor is not added to measured value.

4.3.5 Deviation from Test Standard

No deviation.

4.3.6 EUT Operating Condition

The software provided by client to enable the EUT under transmission condition continuously at lowest, middle and highest channel frequencies individually.

4.3.7 Test Result

CDD Mode

802.11a

Chan.	Chan. Freq. (MHz)	Maximum Conducted Power (dBm)		Total Power (mW)	Total Power (dBm)	Limit (dBm)	Pass / Fail
		Chain 0	Chain 1				
36	5180	15.36	15.89	73.171	18.64	30	Pass
40	5200	17.20	17.54	109.235	20.38	30	Pass
48	5240	19.52	20.20	194.249	22.88	30	Pass
149	5745	20.65	21.52	258.051	24.12	30	Pass
157	5785	20.67	21.57	260.23	24.15	30	Pass
165	5825	20.59	21.55	257.44	24.11	30	Pass

802.11ac (VHT20)

Chan.	Chan. Freq. (MHz)	Maximum Conducted Power (dBm)		Total Power (mW)	Total Power (dBm)	Limit (dBm)	Pass / Fail
		Chain 0	Chain 1				
36	5180	14.53	15.06	60.442	17.81	30	Pass
40	5200	17.10	17.50	107.52	20.31	30	Pass
48	5240	19.48	20.04	189.641	22.78	30	Pass
149	5745	20.67	21.51	258.26	24.12	30	Pass
157	5785	20.55	21.67	260.394	24.16	30	Pass
165	5825	20.53	21.66	259.535	24.14	30	Pass

802.11ac (VHT40)

Chan.	Chan. Freq. (MHz)	Maximum Conducted Power (dBm)		Total Power (mW)	Total Power (dBm)	Limit (dBm)	Pass / Fail
		Chain 0	Chain 0				
38	5190	12.08	12.17	32.626	15.14	30	Pass
46	5230	17.33	17.70	112.959	20.53	30	Pass
151	5755	17.44	19.30	140.577	21.48	30	Pass
159	5795	19.40	21.26	220.756	23.44	30	Pass

802.11ac (VHT80)

Chan.	Chan. Freq. (MHz)	Maximum Conducted Power (dBm)		Total Power (mW)	Total Power (dBm)	Limit (dBm)	Pass / Fail
		Chain 0	Chain 1				
42	5210	10.83	11.17	25.198	14.01	30	Pass
155	5775	16.19	17.89	103.109	20.13	30	Pass

Beamforming Mode

802.11ac (VHT20)

Chan.	Chan. Freq. (MHz)	Maximum Conducted Power (dBm)		Total Power (mW)	Total Power (dBm)	Limit (dBm)	Pass / Fail
		Chain 0	Chain 1				
36	5180	14.53	15.06	60.442	17.81	28.20	Pass
40	5200	17.10	17.50	107.52	20.31	28.20	Pass
48	5240	19.48	20.04	189.641	22.78	28.20	Pass
149	5745	20.67	21.51	258.26	24.12	27.21	Pass
157	5785	20.55	21.67	260.394	24.16	27.21	Pass
165	5825	20.53	21.66	259.535	24.14	27.21	Pass

Note: 1. For UNII-1: Directional gain = $10 \log[(10^{G1/20} + 10^{G2/20})^2 / 2] = 7.8\text{dBi} > 6\text{dBi}$, so the power limit shall be reduced to $30 - (7.8 - 6) = 28.20\text{dBm}$.

2. For UNII-3: Directional gain = $10 \log[(10^{G1/20} + 10^{G2/20})^2 / 2] = 8.79\text{dBi} > 6\text{dBi}$, so the power limit shall be reduced to $30 - (8.79 - 6) = 27.21\text{dBm}$.

802.11ac (VHT40)

Chan.	Chan. Freq. (MHz)	Maximum Conducted Power (dBm)		Total Power (mW)	Total Power (dBm)	Limit (dBm)	Pass / Fail
		Chain 0	Chain 0				
38	5190	12.08	12.17	32.626	15.14	28.20	Pass
46	5230	17.33	17.70	112.959	20.53	28.20	Pass
151	5755	17.44	19.30	140.577	21.48	27.21	Pass
159	5795	19.40	21.26	220.756	23.44	27.21	Pass

Note: 1. For UNII-1: Directional gain = $10 \log[(10^{G1/20} + 10^{G2/20})^2 / 2] = 7.8\text{dBi} > 6\text{dBi}$, so the power limit shall be reduced to $30 - (7.8 - 6) = 28.20\text{dBm}$.

2. For UNII-3: Directional gain = $10 \log[(10^{G1/20} + 10^{G2/20})^2 / 2] = 8.79\text{dBi} > 6\text{dBi}$, so the power limit shall be reduced to $30 - (8.79 - 6) = 27.21\text{dBm}$.

802.11ac (VHT80)

Chan.	Chan. Freq. (MHz)	Maximum Conducted Power (dBm)		Total Power (mW)	Total Power (dBm)	Limit (dBm)	Pass / Fail
		Chain 0	Chain 1				
42	5210	10.83	11.17	25.198	14.01	28.20	Pass
155	5775	16.19	17.89	103.109	20.13	27.21	Pass

Note: 1. For UNII-1: Directional gain = $10 \log[(10^{G1/20} + 10^{G2/20})^2 / 2] = 7.8\text{dBi} > 6\text{dBi}$, so the power limit shall be reduced to $30-(7.8-6) = 28.20\text{dBm}$.

2. For UNII-3: Directional gain = $10 \log[(10^{G1/20} + 10^{G2/20})^2 / 2] = 8.79\text{dBi} > 6\text{dBi}$, so the power limit shall be reduced to $30-(8.79-6) = 27.21\text{dBm}$.

※Add test for each data rate output power (require by manufacturer):

CDD Mode

802.11a

CHANNEL	FREQUENCY (MHz)	AVERAGE POWER (dBm)							
		Data rate							
		6Mbps	9Mbps	12Mbps	18Mbps	24Mbps	36Mbps	48Mbps	54Mbps
36	5180	18.64	18.55	18.53	18.63	18.48	18.58	18.55	18.40
40	5200	20.38	20.33	20.29	20.12	20.02	19.81	19.71	19.63
48	5240	22.88	22.79	22.62	22.47	22.61	22.41	22.54	22.56
149	5745	24.12	23.95	23.76	23.82	23.83	23.68	23.81	24.03
157	5785	24.15	23.96	23.80	23.76	23.86	23.8	24	23.85
165	5825	24.11	24.10	23.89	23.89	24.03	23.88	24.1	24.09

802.11ac (VHT20)

Nss=1

CHANNEL	FREQUENCY (MHz)	AVERAGE POWER (dBm)								
		Data rate								
		MCS0	MCS1	MCS2	MCS3	MCS4	MCS5	MCS6	MCS7	MCS8
36	5180	17.81	17.66	17.74	17.59	17.65	17.74	17.73	17.75	17.57
40	5200	20.31	20.11	19.94	20.13	20.26	20.15	19.99	20.04	19.94
48	5240	22.78	22.69	22.59	22.37	22.43	22.33	22.17	22.3	22.09
149	5745	24.12	23.92	24.01	23.97	24.1	23.91	23.85	23.7	23.91
157	5785	24.16	24.07	24.11	24.03	23.85	23.72	23.93	23.74	23.71
165	5825	24.14	23.97	23.90	24.05	23.83	23.63	23.84	23.65	23.57

Nss=2

CHANNEL	FREQUENCY (MHz)	AVERAGE POWER (dBm)								
		Data rate								
		MCS0	MCS1	MCS2	MCS3	MCS4	MCS5	MCS6	MCS7	MCS8
36	5180	17.71	17.67	17.79	17.77	17.61	17.67	17.77	17.79	17.72
40	5200	20.20	20.28	20.07	20.24	20.2	20.22	20.1	20.04	20.01
48	5240	22.57	22.61	22.68	22.48	22.43	22.58	22.53	22.5	22.65
149	5745	24.06	23.99	23.93	23.78	24	23.85	23.98	23.79	23.97
157	5785	24.01	24.14	24.10	24.06	23.92	23.79	23.98	24.04	23.99
165	5825	24.04	23.97	24.10	24.00	23.87	24.05	24.02	23.99	23.96

802.11ac (VHT40)
Nss=1

CHANNEL	FREQUENCY (MHz)	AVERAGE POWER (dBm)									
		Data rate									
		MCS0	MCS1	MCS2	MCS3	MCS4	MCS5	MCS6	MCS7	MCS8	MCS9
38	5190	15.14	15.03	15.01	14.95	15.00	15.06	15.08	15.02	14.99	14.95
46	5230	20.53	20.52	20.51	20.46	20.44	20.3	20.12	20.28	20.29	20.25
151	5755	21.48	21.27	21.30	21.11	21.29	21.2	21.31	21.22	21.16	21.35
159	5795	23.44	23.38	23.35	23.16	23.3	23.08	23.23	23.04	22.99	23.11

Nss=2

CHANNEL	FREQUENCY (MHz)	AVERAGE POWER (dBm)									
		Data rate									
		MCS0	MCS1	MCS2	MCS3	MCS4	MCS5	MCS6	MCS7	MCS8	MCS9
38	5190	15.13	15.11	15.09	14.91	14.95	14.80	14.61	14.70	14.59	14.81
46	5230	20.42	20.52	20.39	20.38	20.24	20.36	20.21	20.09	20.01	19.94
151	5755	21.39	21.37	21.31	21.17	21.37	21.35	21.44	21.47	21.31	21.44
159	5795	23.27	23.23	23.26	23.18	23.35	23.15	23.12	23.02	23.1	23.23

802.11ac (VHT80)
Nss=1

CHANNEL	FREQUENCY (MHz)	AVERAGE POWER (dBm)									
		Data rate									
		MCS0	MCS1	MCS2	MCS3	MCS4	MCS5	MCS6	MCS7	MCS8	MCS9
42	5210	14.01	13.90	13.85	13.84	13.87	13.81	13.72	13.61	13.42	13.52
155	5775	20.13	19.97	19.87	19.68	19.79	19.82	19.94	19.97	20.09	20.00

Nss=2

CHANNEL	FREQUENCY (MHz)	AVERAGE POWER (dBm)									
		Data rate									
		MCS0	MCS1	MCS2	MCS3	MCS4	MCS5	MCS6	MCS7	MCS8	MCS9
42	5210	13.95	13.86	13.68	13.70	13.50	13.72	13.51	13.65	13.61	13.67
155	5775	19.99	19.97	19.94	20.08	19.97	19.87	19.67	19.6	19.4	19.18

Beamforming Mode

802.11ac (VHT20)

Nss=1

CHANNEL	FREQUENCY (MHz)	AVERAGE POWER (dBm)								
		Data rate								
		MCS0	MCS1	MCS2	MCS3	MCS4	MCS5	MCS6	MCS7	MCS8
36	5180	17.81	17.66	17.74	17.59	17.65	17.74	17.73	17.75	17.57
40	5200	20.31	20.11	19.94	20.13	20.26	20.15	19.99	20.04	19.94
48	5240	22.78	22.69	22.59	22.37	22.43	22.33	22.17	22.3	22.09
149	5745	24.12	23.92	24.01	23.97	24.1	23.91	23.85	23.7	23.91
157	5785	24.16	24.07	24.11	24.03	23.85	23.72	23.93	23.74	23.71
165	5825	24.14	23.97	23.90	24.05	23.83	23.63	23.84	23.65	23.57

Nss=2

CHANNEL	FREQUENCY (MHz)	AVERAGE POWER (dBm)								
		Data rate								
		MCS0	MCS1	MCS2	MCS3	MCS4	MCS5	MCS6	MCS7	MCS8
36	5180	17.71	17.67	17.79	17.77	17.61	17.67	17.77	17.79	17.72
40	5200	20.20	20.28	20.07	20.24	20.2	20.22	20.1	20.04	20.01
48	5240	22.57	22.61	22.68	22.48	22.43	22.58	22.53	22.5	22.65
149	5745	24.06	23.99	23.93	23.78	24	23.85	23.98	23.79	23.97
157	5785	24.01	24.14	24.10	24.06	23.92	23.79	23.98	24.04	23.99
165	5825	24.04	23.97	24.10	24.00	23.87	24.05	24.02	23.99	23.96

802.11ac (VHT40)
Nss=1

CHANNEL	FREQUENCY (MHz)	AVERAGE POWER (dBm)									
		Data rate									
		MCS0	MCS1	MCS2	MCS3	MCS4	MCS5	MCS6	MCS7	MCS8	MCS9
38	5190	15.14	15.03	15.01	14.95	15.00	15.06	15.08	15.02	14.99	14.95
46	5230	20.53	20.52	20.51	20.46	20.44	20.3	20.12	20.28	20.29	20.25
151	5755	21.48	21.27	21.30	21.11	21.29	21.2	21.31	21.22	21.16	21.35
159	5795	23.44	23.38	23.35	23.16	23.3	23.08	23.23	23.04	22.99	23.11

Nss=2

CHANNEL	FREQUENCY (MHz)	AVERAGE POWER (dBm)									
		Data rate									
		MCS0	MCS1	MCS2	MCS3	MCS4	MCS5	MCS6	MCS7	MCS8	MCS9
38	5190	15.13	15.11	15.09	14.91	14.95	14.80	14.61	14.70	14.59	14.81
46	5230	20.42	20.52	20.39	20.38	20.24	20.36	20.21	20.09	20.01	19.94
151	5755	21.39	21.37	21.31	21.17	21.37	21.35	21.44	21.47	21.31	21.44
159	5795	23.27	23.23	23.26	23.18	23.35	23.15	23.12	23.02	23.1	23.23

802.11ac (VHT80)
Nss=1

CHANNEL	FREQUENCY (MHz)	AVERAGE POWER (dBm)									
		Data rate									
		MCS0	MCS1	MCS2	MCS3	MCS4	MCS5	MCS6	MCS7	MCS8	MCS9
42	5210	14.01	13.90	13.85	13.84	13.87	13.81	13.72	13.61	13.42	13.52
155	5775	20.13	19.97	19.87	19.68	19.79	19.82	19.94	19.97	20.09	20.00

Nss=2

CHANNEL	FREQUENCY (MHz)	AVERAGE POWER (dBm)									
		Data rate									
		MCS0	MCS1	MCS2	MCS3	MCS4	MCS5	MCS6	MCS7	MCS8	MCS9
42	5210	13.95	13.86	13.68	13.70	13.50	13.72	13.51	13.65	13.61	13.67
155	5775	19.99	19.97	19.94	20.08	19.97	19.87	19.67	19.6	19.4	19.18

4.4 Occupied Bandwidth Measurement

4.4.1 Test Setup

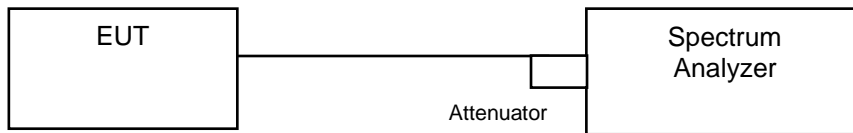

4.4.2 Test Instruments

Refer to section 4.1.2 to get information of above instrument.

4.4.3 Test Procedure

The transmitter output was connected to the spectrum analyzer through an attenuator. The bandwidth of the fundamental frequency was measured by spectrum analyzer with resolution bandwidth in the range of 1% to 5% of the anticipated emission bandwidth, and a video bandwidth at least 3x the resolution bandwidth and set the detector to SAMPLE. The width of a frequency band such that, below the lower and above the upper frequency limits, the mean powers emitted are each equal to a specified percentage 0.5 %of the total mean power of a given emission.

4.4.4 Test Results

802.11a

Channel	Channel Frequency (MHz)	Occupied Bandwidth (MHz)	
		CHAIN 0	CHAIN 1
36	5180	17.04	16.92
40	5200	17.16	17.04
48	5240	20.04	17.88
149	5745	27.84	33.12
157	5785	30.00	31.68
165	5825	27.96	30.84

802.11ac (VHT20)

Channel	Channel Frequency (MHz)	Occupied Bandwidth (MHz)	
		CHAIN 0	CHAIN 1
36	5180	18.12	18.12
40	5200	18.24	18.24
48	5240	19.68	18.96
149	5745	29.88	34.56
157	5785	30.96	33.72
165	5825	31.68	33.96

802.11ac (VHT40)

Channel	Channel Frequency (MHz)	Occupied Bandwidth (MHz)	
		CHAIN 0	CHAIN 1
38	5190	36.72	36.72
46	5230	37.68	37.44
151	5755	48.00	44.16
159	5795	66.24	66.96

802.11ac (VHT80)

Channel	Channel Frequency (MHz)	Occupied Bandwidth (MHz)	
		CHAIN 0	CHAIN 1
42	5210	75.36	76.32
155	5775	77.28	77.28

Spectrum Plot of Worst Value

802.11a_Chain1 / CH149

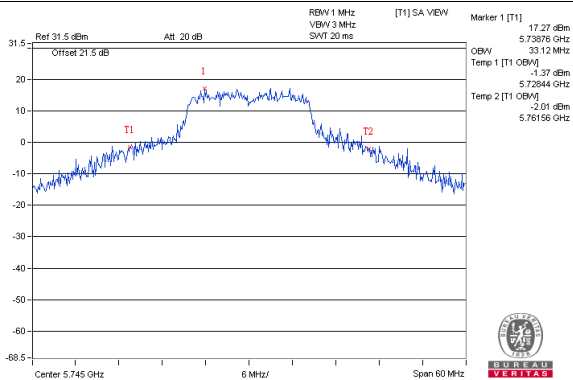

802.11ac (VHT20)_Chain1 / CH149

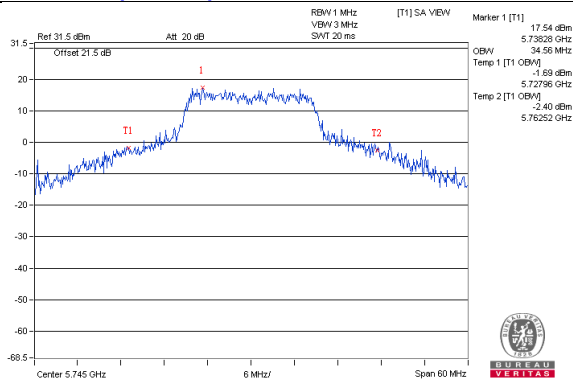

802.11ac (VHT40)_Chain1 / CH159

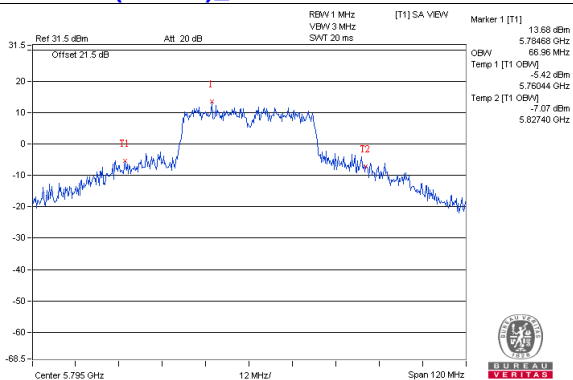

802.11ac (VHT80)_Chain0 / CH155

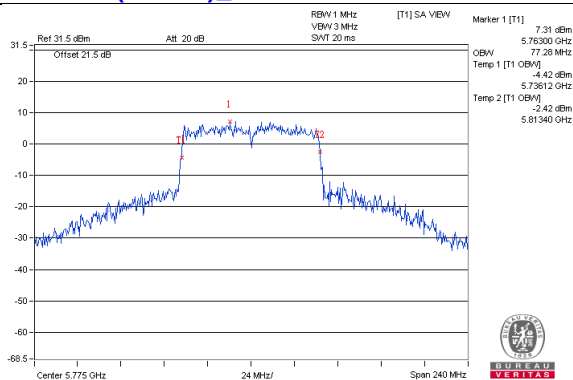

**Spectrum Plot for near by DFS band
(DFS is required, if 99% OCP straddle into U-NII-2A band)**

802.11a_Chain0 / CH48

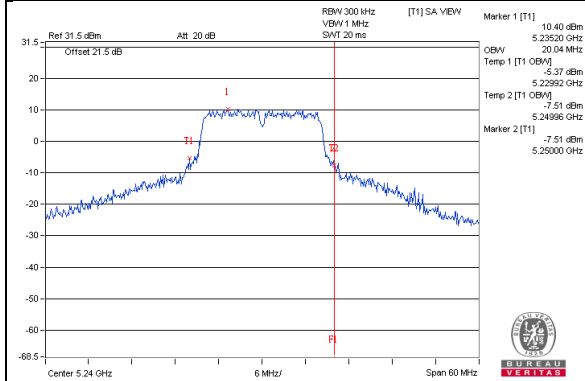

802.11a_Chain1 / CH48

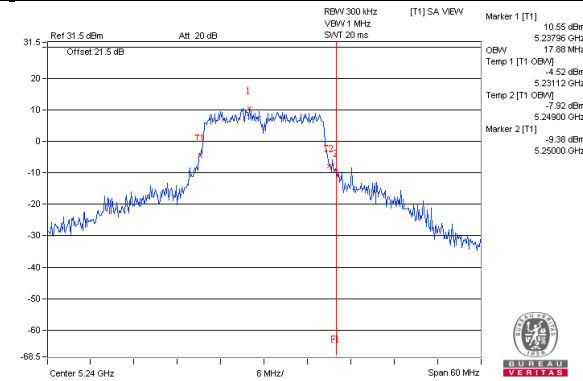

802.11ac(VHT20)_Chain0 / CH48

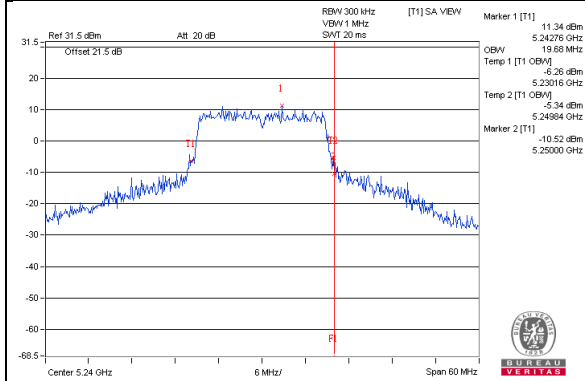

802.11ac(VHT20)_Chain1 / CH48

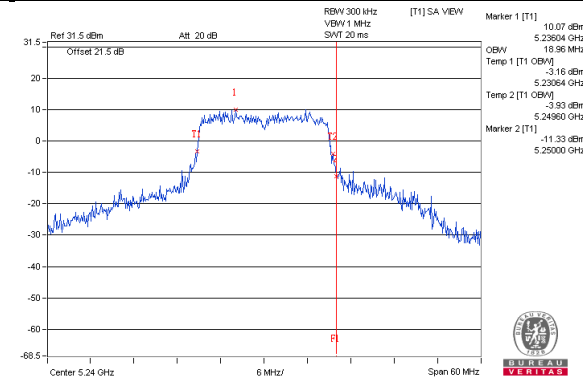

802.11ac(VHT40)_Chain0 / CH46

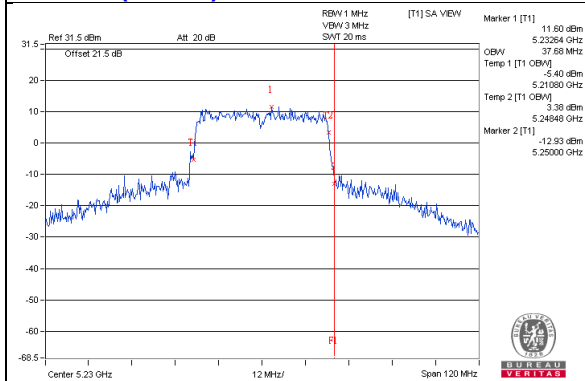

802.11ac(VHT40)_Chain1 / CH46

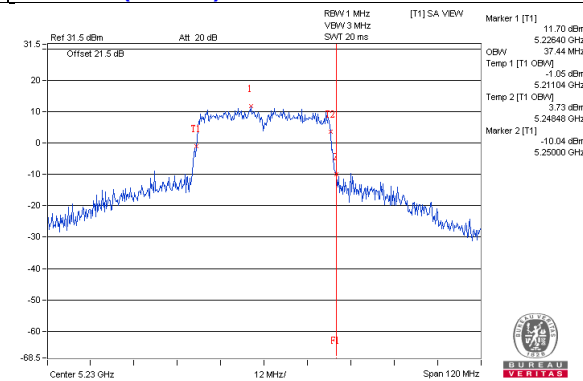

802.11ac(VHT80)_Chain0 / CH42

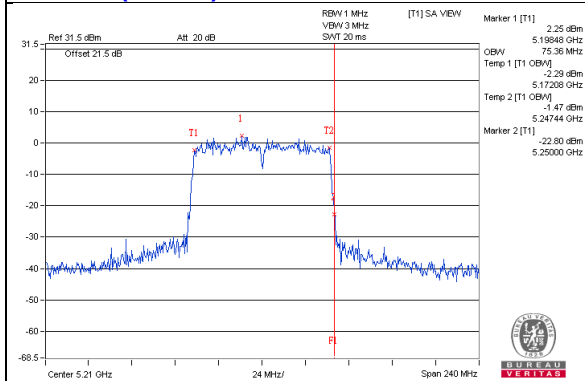

802.11ac(VHT80)_Chain1 / CH42

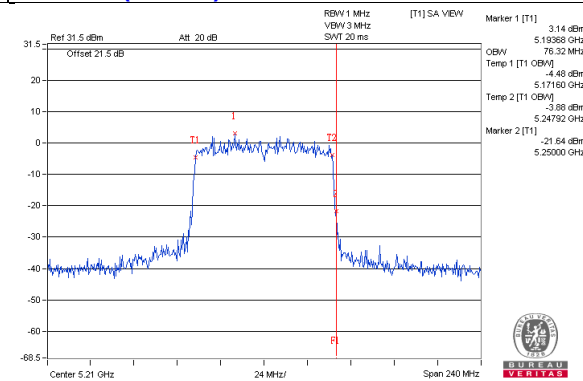

Spectrum Plot for near by DFS band (DFS is required, if 99% OCP straddle into U-NII-2C band)

802.11a_Chain0 / CH149

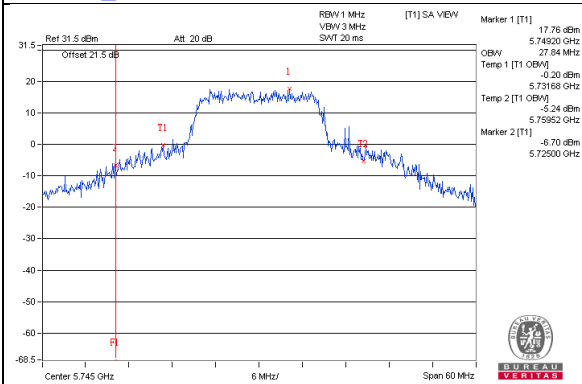

802.11a_Chain1 / CH149

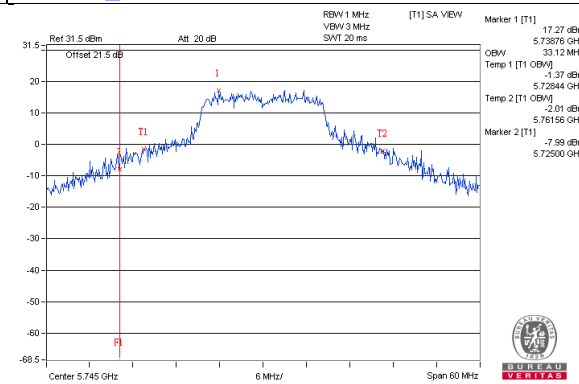

802.11ac(VHT20)_Chain0 / CH149

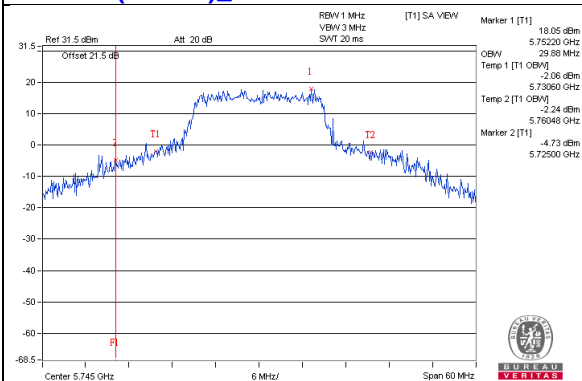

802.11ac(VHT20)_Chain1 / CH149

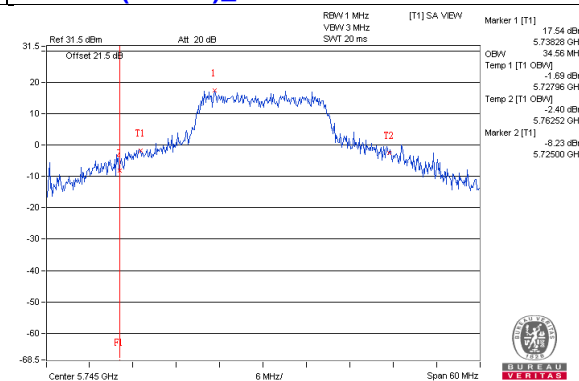

802.11ac(VHT40)_Chain0 / CH151

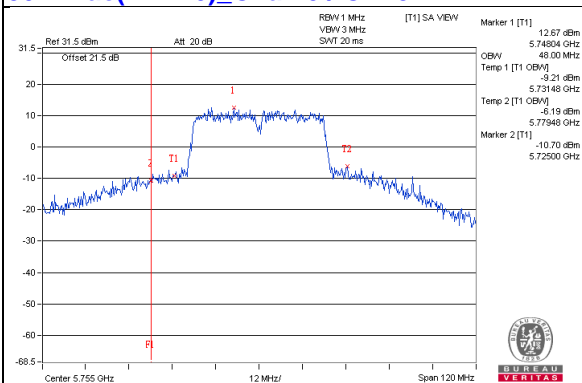

802.11ac(VHT40)_Chain1 / CH151

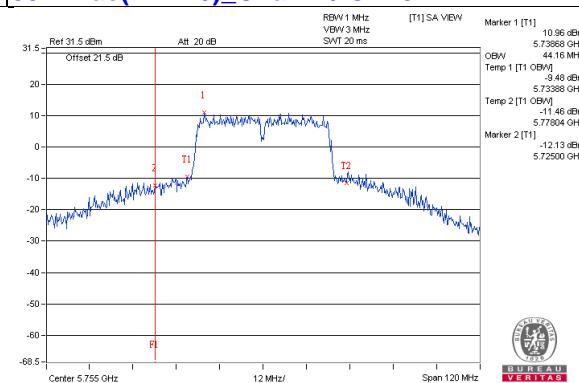

802.11ac(VHT80)_Chain0 / CH155

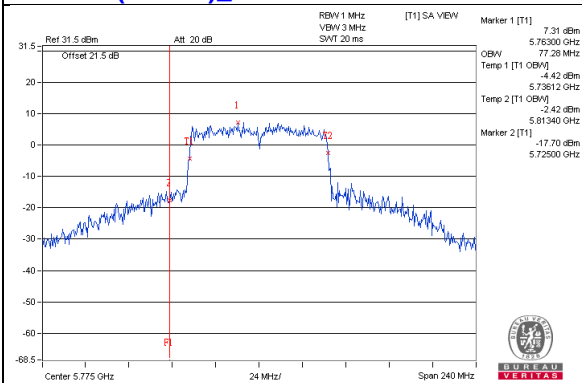

802.11ac(VHT80)_Chain1 / CH155

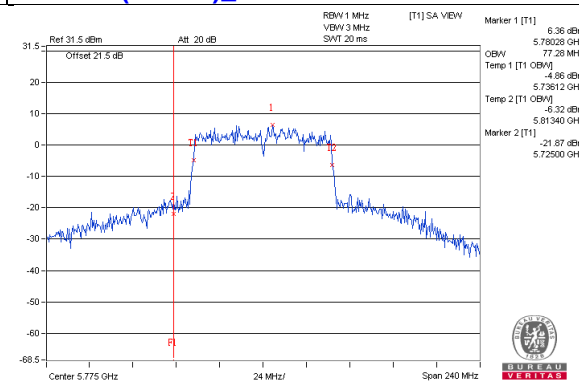

4.5 Peak Power Spectral Density Measurement

4.5.1 Limits of Peak Power Spectral Density Measurement

Operation Band	EUT Category		Limit
U-NII-1		Outdoor Access Point	17dBm/ MHz
		Fixed point-to-point Access Point	
	√	Indoor Access Point	
		Mobile and Portable client device	11dBm/ MHz
U-NII-2A			11dBm/ MHz
U-NII-2C			11dBm/ MHz
U-NII-3	√		30dBm/ 500kHz

4.5.2 Test Setup

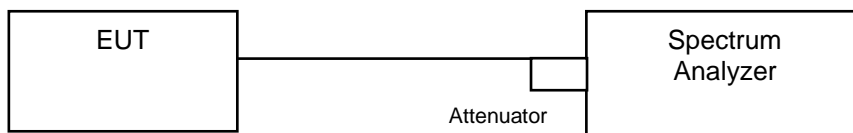

4.5.3 Test Instruments

Refer to section 4.1.2 to get information of above instrument.

4.5.4 Test Procedure

802.11a, 802.11ac (VHT20), 802.11ac (VHT40)

For U-NII-1:

Using method SA-1

1. Set span to encompass the entire emission bandwidth (EBW) of the signal.
2. Set RBW = 1 MHz, Set VBW \geq 3 MHz, Detector = RMS
3. Sweep time = auto, trigger set to "free run".
4. Trace average at least 100 traces in power averaging mode.
5. Record the max value

For U-NII-3:

1. Set span to encompass the entire emission bandwidth (EBW) of the signal.
2. Set RBW = 300 kHz, Set VBW \geq 1 MHz, Detector = RMS
3. Use the peak marker function to determine the maximum power level in any 300 kHz band segment within the fundamental EBW.
4. Scale the observed power level to an equivalent value in 500 kHz by adjusting (reducing) the measured power by a bandwidth correction factor (BWCF) where $BWCF = 10\log(500 \text{ kHz}/300\text{kHz})$
5. Sweep time = auto, trigger set to "free run".
6. Trace average at least 100 traces in power averaging mode.
7. Record the max value

802.11ac (VHT80)

For U-NII-1:

Using method SA-2

1. Set span to encompass the entire emission bandwidth (EBW) of the signal.
2. Set RBW = 1 MHz, Set VBW \geq 3 MHz, Detector = RMS
3. Sweep time = auto, trigger set to "free run".
4. Trace average at least 100 traces in power averaging mode.
5. Record the max value and add $10 \log (1/\text{duty cycle})$

For U-NII-3:

1. Set span to encompass the entire emission bandwidth (EBW) of the signal.
2. Set RBW = 300 kHz, Set VBW \geq 1 MHz, Detector = RMS
3. Use the peak marker function to determine the maximum power level in any 300 kHz band segment within the fundamental EBW.
4. Scale the observed power level to an equivalent value in 500 kHz by adjusting (reducing) the measured power by a bandwidth correction factor (BWCF) where $BWCF = 10\log(500 \text{ kHz}/300\text{kHz})$
5. Sweep time = auto, trigger set to "free run".
6. Trace average at least 100 traces in power averaging mode.
7. Record the max value and add $10 \log (1/\text{duty cycle})$

4.5.5 Deviation from Test Standard

No deviation.

4.5.6 EUT Operating Condition

Same as Item 4.3.6.

4.5.7 Test Results

For U-NII-1:

802.11a

Chan.	Chan. Freq. (MHz)	PSD (dBm/MHz)		Total Power Density (dBm/MHz)	MAX. Limit (dBm/MHz)	Pass / Fail
		Chain 0	Chain 1			
36	5180	2.06	1.84	4.96	15.20	Pass
40	5200	4.08	3.75	6.93	15.20	Pass
48	5240	6.64	6.30	9.48	15.20	Pass

- Note:** 1. Method a) of power density measurement of KDB 662911 is using for calculating total power density. Total power density is summing entire spectra across corresponding frequency bins on the various outputs by computer.
2. Directional gain = $10 \log[(10^{G1/20} + 10^{G2/20})^2 / 2] = 7.8\text{dBi} > 6\text{dBi}$, so the power density limit shall be reduced to $17-(7.8-6) = 15.20\text{dBm}$.

802.11ac (VHT20)

Chan.	Chan. Freq. (MHz)	PSD (dBm/MHz)		Total Power Density (dBm/MHz)	MAX. Limit (dBm/MHz)	Pass / Fail
		Chain 0	Chain 1			
36	5180	1.44	0.94	4.21	15.20	Pass
40	5200	3.73	3.49	6.62	15.20	Pass
48	5240	6.40	6.02	9.22	15.20	Pass

- Note:** 1. Method a) of power density measurement of KDB 662911 is using for calculating total power density. Total power density is summing entire spectra across corresponding frequency bins on the various outputs by computer.
2. Directional gain = $10 \log[(10^{G1/20} + 10^{G2/20})^2 / 2] = 7.8\text{dBi} > 6\text{dBi}$, so the power density limit shall be reduced to $17-(7.8-6) = 15.20\text{dBm}$.

802.11ac (VHT40)

Chan.	Chan. Freq. (MHz)	PSD (dBm/MHz)		Total Power Density (dBm/MHz)	MAX. Limit (dBm/MHz)	Pass / Fail
		Chain 0	Chain 1			
38	5190	-4.33	-4.19	-1.25	15.20	Pass
46	5230	1.52	1.11	4.33	15.20	Pass

- Note:** 1. Method a) of power density measurement of KDB 662911 is using for calculating total power density. Total power density is summing entire spectra across corresponding frequency bins on the various outputs by computer.
2. Directional gain = $10 \log[(10^{G1/20} + 10^{G2/20})^2 / 2] = 7.8\text{dBi} > 6\text{dBi}$, so the power density limit shall be reduced to $17-(7.8-6) = 15.20\text{dBm}$.

802.11ac (VHT80)

Chan.	Chan. Freq. (MHz)	PSD W/O Duty Factor (dBm/MHz)		Duty Factor (dB)	Total PSD With Duty Factor (dBm/MHz)	MAX. Limit (dBm/MHz)	Pass / Fail
		Chain 0	Chain 1				
42	5210	-8.26	-8.44	0.18	-5.15	15.20	Pass

- Note:**
- Method a) of power density measurement of KDB 662911 is using for calculating total power density. Total power density is summing entire spectra across corresponding frequency bins on the various outputs by computer.
 - Directional gain = $10 \log[(10^{G1/20} + 10^{G2/20})^2 / 2] = 7.8\text{dBi} > 6\text{dBi}$, so the power density limit shall be reduced to $17-(7.8-6) = 15.20\text{dBm}$.
 - Refer to section 3.3 for duty cycle spectrum plot.

Spectrum Plot of Worst Value

802.11a_Chain 0 / CH48

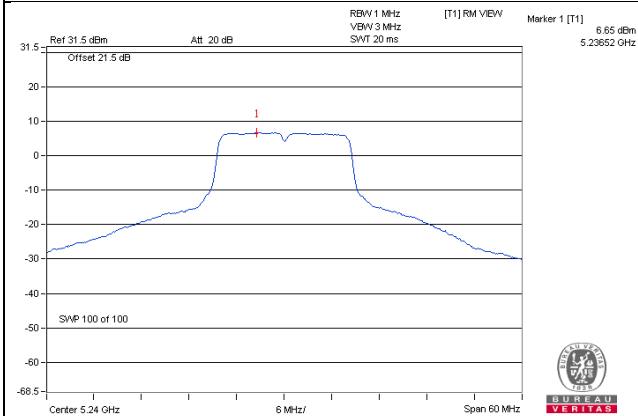

802.11ac (VHT20)_Chain 0 / CH48

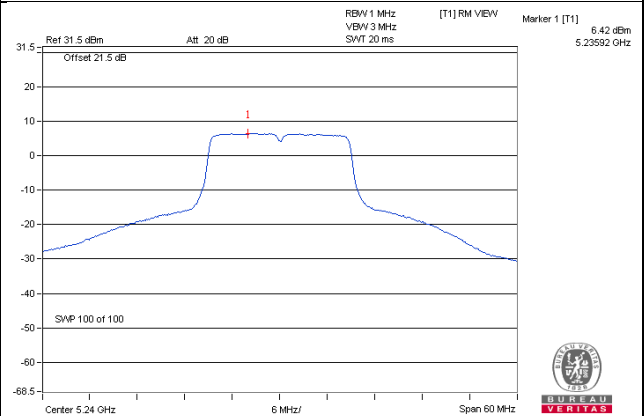

802.11ac (VHT40)_Chain 0 / CH46

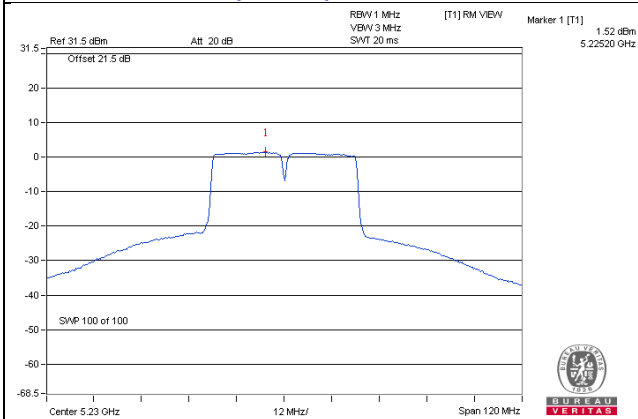

802.11ac (VHT80)_Chain 0 / CH42

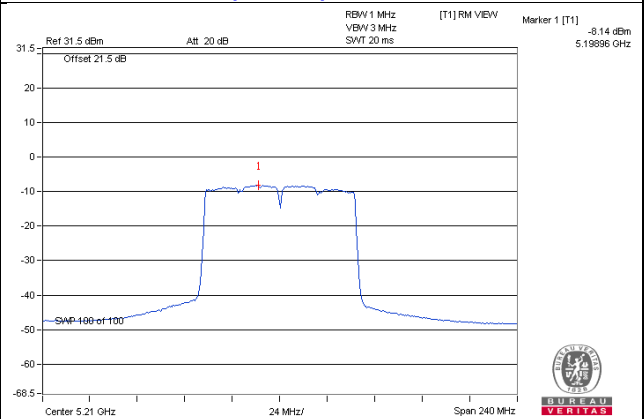

For U-NII-3:
802.11a

TX chain	Channel	Freq. (MHz)	PSD (dBm/300kHz)	PSD (dBm/500kHz)	10 log (N=2) dB	Total PSD (dBm/500kHz)	Limit (dBm/500kHz)	Pass /Fail
0	149	5745	-1.33	0.89	3.01	3.90	27.21	Pass
	157	5785	-0.98	1.24	3.01	4.25	27.21	Pass
	165	5825	-1.40	0.82	3.01	3.83	27.21	Pass
1	149	5745	-1.37	0.85	3.01	3.86	27.21	Pass
	157	5785	-1.64	0.58	3.01	3.59	27.21	Pass
	165	5825	-2.29	-0.07	3.01	2.94	27.21	Pass

Note: 1. Directional gain = $10 \log[(10^{G1/20} + 10^{G2/20})^2 / 2] = 8.79\text{dBi} > 6\text{dBi}$, so the power density limit shall be reduced to $30-(8.79-6) = 27.21\text{dBm}$.

802.11ac (VHT20)

TX chain	Channel	Freq. (MHz)	PSD (dBm/300kHz)	PSD (dBm/500kHz)	10 log (N=2) dB	Total PSD (dBm/500kHz)	Limit (dBm/500kHz)	Pass /Fail
0	149	5745	-1.44	0.78	3.01	3.79	27.21	Pass
	157	5785	-1.16	1.06	3.01	4.07	27.21	Pass
	165	5825	-1.68	0.54	3.01	3.55	27.21	Pass
1	149	5745	-14.56	-12.34	3.01	-9.33	27.21	Pass
	157	5785	-2.19	0.03	3.01	3.04	27.21	Pass
	165	5825	-2.41	-0.19	3.01	2.82	27.21	Pass

Note: 1. Directional gain = $10 \log[(10^{G1/20} + 10^{G2/20})^2 / 2] = 8.79\text{dBi} > 6\text{dBi}$, so the power density limit shall be reduced to $30-(8.79-6) = 27.21\text{dBm}$.

802.11ac (VHT40)

TX chain	Channel	Freq. (MHz)	PSD (dBm/300kHz)	PSD (dBm/500kHz)	10 log (N=2) dB	Total PSD (dBm/500kHz)	Limit (dBm/500kHz)	Pass /Fail
0	151	5755	-5.70	-3.48	3.01	-0.47	27.21	Pass
	159	5795	-4.37	-2.15	3.01	0.86	27.21	Pass
1	151	5755	-7.56	-5.34	3.01	-2.33	27.21	Pass
	159	5795	-6.19	-3.97	3.01	-0.96	27.21	Pass

Note: 1. Directional gain = $10 \log[(10^{G1/20} + 10^{G2/20})^2 / 2] = 8.79\text{dBi} > 6\text{dBi}$, so the power density limit shall be reduced to $30-(8.79-6) = 27.21\text{dBm}$.

802.11ac (VHT80)

TX chain	Chan.	Chan. Freq. (MHz)	PSD W/O Duty Factor		10 log (N=2) dB	Duty Factor (dB)	Total PSD With Duty Factor (dBm/500kHz)	Limit (dBm/500kHz)	Pass /Fail
			(dBm/300kHz)	(dBm/500kHz)					
0	155	5775	-10.78	-8.56	3.01	0.18	-5.37	27.21	Pass
1	155	5775	-12.37	-10.15	3.01	0.18	-6.96	27.21	Pass

Note: 1. Directional gain = $10 \log[(10^{G1/20} + 10^{G2/20})^2 / 2] = 8.79\text{dBi} > 6\text{dBi}$, so the power density limit shall be reduced to $30-(8.79-6) = 27.21\text{dBm}$.

2. Refer to section 3.3 for duty cycle spectrum plot.

Spectrum Plot of Worst Value

802.11a – Chain 0: CH 157

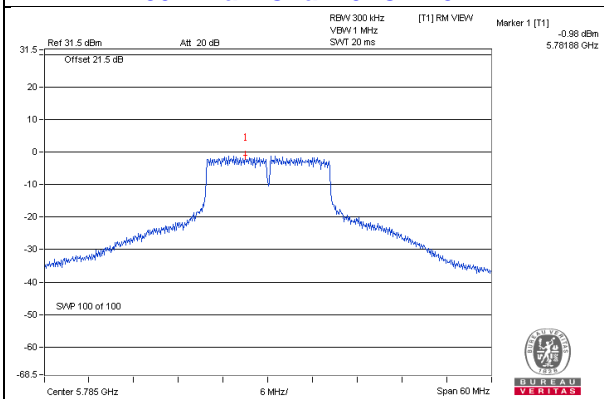

802.11ac (VHT20) – Chain 0: CH 157

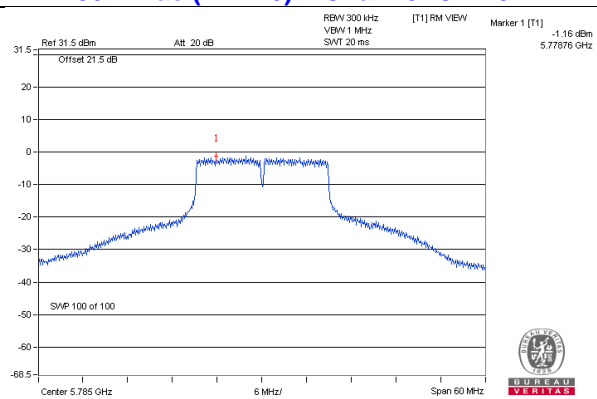

802.11ac (VHT40) – Chain 0: CH 159

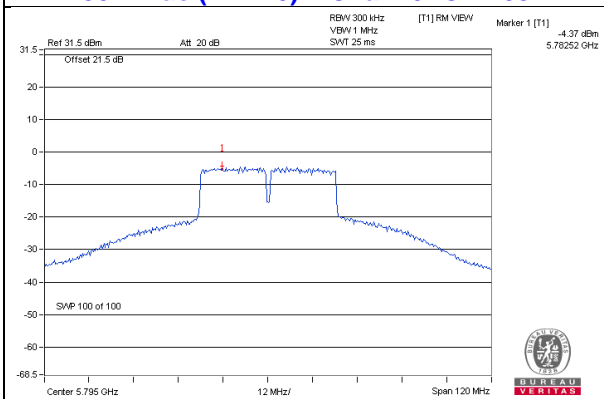

802.11ac (VHT80) – Chain 0: CH 155

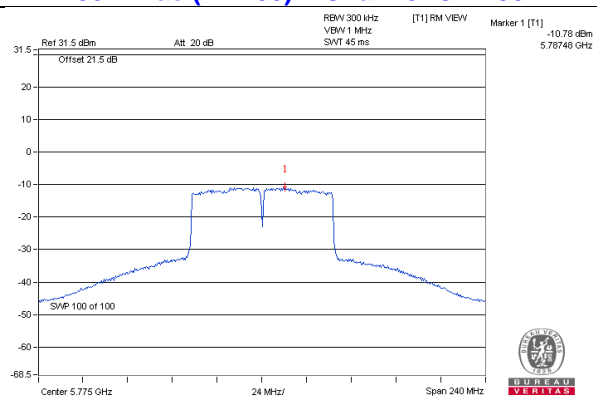

4.6 Frequency Stability Measurement

4.6.1 Limits of Frequency Stability Measurement

The frequency of the carrier signal shall be maintained within band of operation

4.6.2 Test Setup

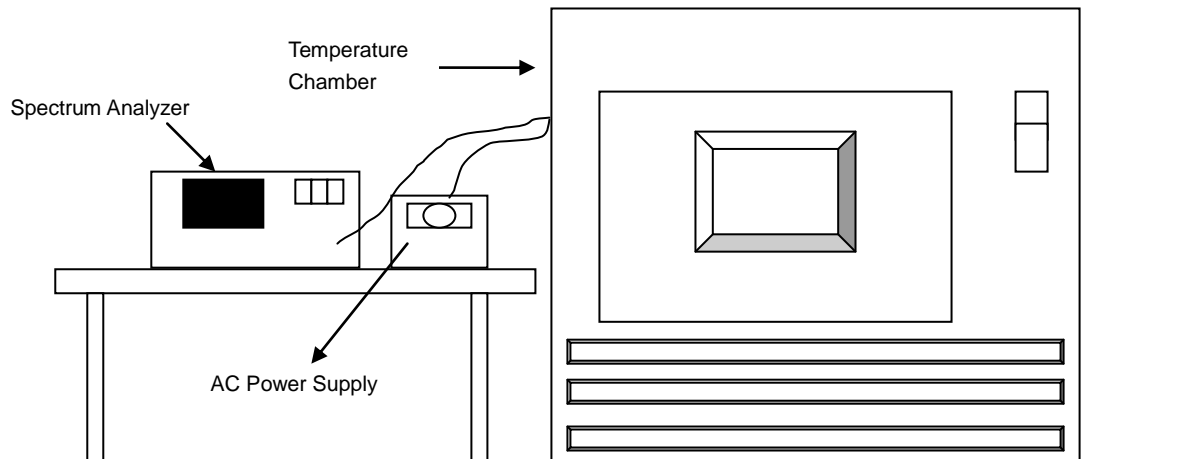

4.6.3 Test Instruments

Refer to section 4.1.2 to get information of above instrument.

4.6.4 Test Procedure

- The EUT was placed inside the environmental test chamber and powered by nominal AC voltage.
- Turn the EUT on and couple its output to a spectrum analyzer.
- Turn the EUT off and set the chamber to the highest temperature specified.
- Allow sufficient time (approximately 30 min) for the temperature of the chamber to stabilize, turn the EUT on and measure the operating frequency after 2, 5, and 10 Minutes.
- Repeat step 2 and 3 with the temperature chamber set to the lowest temperature.
- The test chamber was allowed to stabilize at +20 degree C for a minimum of 30 Minutes. The supply voltage was then adjusted on the EUT from 85% to 115% and the frequency record.

4.6.5 Deviation from Test Standard

No deviation.

4.6.6 EUT Operating Condition

Set the EUT transmit at un-modulation mode to test frequency stability.

4.6.7 Test Results

Frequency Stability Versus Temp.									
Operating Frequency: 5180 MHz									
TEMP. (°C)	Power Supply (Vac)	0 Minute		2 Minute		5 Minute		10 Minute	
		Measured Frequency (MHz)	Pass/Fail	Measured Frequency (MHz)	Pass/Fail	Measured Frequency (MHz)	Pass/Fail	Measured Frequency (MHz)	Pass/Fail
50	120	5179.9894	Pass	5179.988	Pass	5179.9873	Pass	5179.9872	Pass
40	120	5179.9908	Pass	5179.9905	Pass	5179.9899	Pass	5179.9904	Pass
30	120	5180.017	Pass	5180.0179	Pass	5180.015	Pass	5180.0149	Pass
20	120	5180.009	Pass	5180.007	Pass	5180.0046	Pass	5180.0081	Pass
10	120	5180.0056	Pass	5180.0061	Pass	5180.0076	Pass	5180.0028	Pass
0	120	5180.0247	Pass	5180.0207	Pass	5180.0228	Pass	5180.0246	Pass
-10	120	5179.9956	Pass	5179.9952	Pass	5179.9931	Pass	5179.9945	Pass
-20	120	5179.9764	Pass	5179.9748	Pass	5179.9747	Pass	5179.9764	Pass
-30	120	5179.9975	Pass	5179.9997	Pass	5180.0012	Pass	5180.002	Pass

Frequency Stability Versus Voltage									
Operating Frequency: 5180 MHz									
TEMP. (°C)	Power Supply (Vac)	0 Minute		2 Minute		5 Minute		10 Minute	
		Measured Frequency (MHz)	Pass/Fail	Measured Frequency (MHz)	Pass/Fail	Measured Frequency (MHz)	Pass/Fail	Measured Frequency (MHz)	Pass/Fail
20	138	5180.0088	Pass	5180.0078	Pass	5180.0046	Pass	5180.0079	Pass
	120	5180.009	Pass	5180.007	Pass	5180.0046	Pass	5180.0081	Pass
	102	5180.0092	Pass	5180.0061	Pass	5180.0048	Pass	5180.0083	Pass

4.7 6dB Bandwidth Measurement

4.7.1 Limits of 6dB Bandwidth Measurement

The minimum of 6dB Bandwidth Measurement is 0.5MHz.

4.7.2 Test Setup

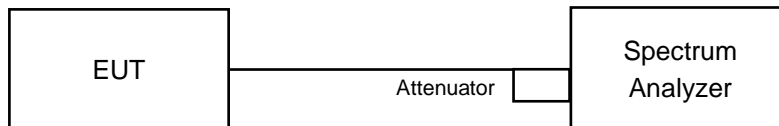

4.7.3 Test Instruments

Refer to section 4.1.2 to get information of above instrument.

4.7.4 Test Procedure

MEASUREMENT PROCEDURE REF

- Set resolution bandwidth (RBW) = 100kHz
- Set the video bandwidth (VBW) $\geq 3 \times$ RBW, Detector = Peak.
- Trace mode = max hold.
- Sweep = auto couple.
- Measure the maximum width of the emission that is constrained by the frequencies associated with the two amplitude points (upper and lower) that are attenuated by 6 dB relative to the maximum level measured in the fundamental emission

4.7.5 Deviation from Test Standard

No deviation.

4.7.6 EUT Operating Condition

The software provided by client to enable the EUT under transmission condition continuously at lowest, middle and highest channel frequencies individually.

4.7.7 Test Results

802.11a

Channel	Frequency (MHz)	6dB Bandwidth (MHz)		Minimum Limit (MHz)	Pass / Fail
		Chain 0	Chain 1		
149	5745	16.32	16.39	0.5	PASS
157	5785	16.39	16.37	0.5	PASS
165	5825	16.40	16.37	0.5	PASS

802.11ac (VHT20)

Channel	Frequency (MHz)	6dB Bandwidth (MHz)		Minimum Limit (MHz)	Pass / Fail
		Chain 0	Chain 1		
149	5745	16.97	17.62	0.5	PASS
157	5785	17.61	17.66	0.5	PASS
165	5825	17.64	17.65	0.5	PASS

802.11ac (VHT40)

Channel	Frequency (MHz)	6dB Bandwidth (MHz)		Minimum Limit (MHz)	Pass / Fail
		Chain 0	Chain 1		
151	5755	36.32	36.46	0.5	PASS
159	5795	36.45	36.48	0.5	PASS

802.11ac (VHT80)

Channel	Frequency (MHz)	6dB Bandwidth (MHz)		Minimum Limit (MHz)	Pass / Fail
		Chain 0	Chain 1		
155	5775	75.75	75.95	0.5	PASS

Spectrum Plot of Worst Value

802.11a_Chain 0 / CH149

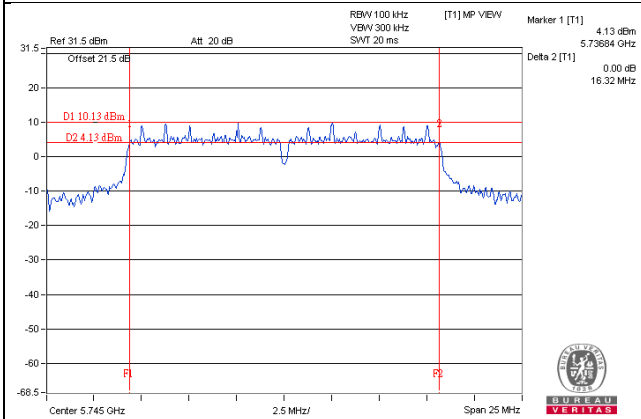

802.11ac (VHT20)_Chain 0 / CH149

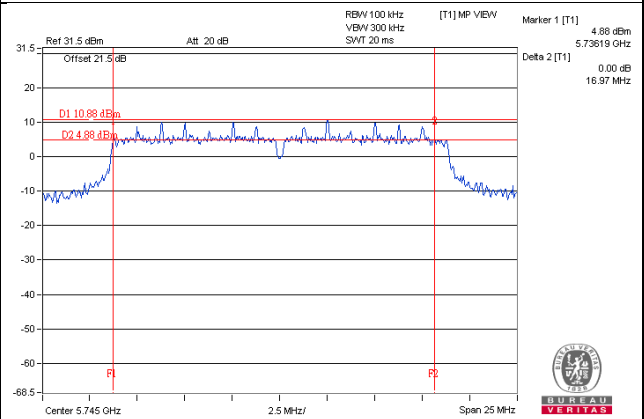

802.11ac (VHT40)_Chain 0 / CH151

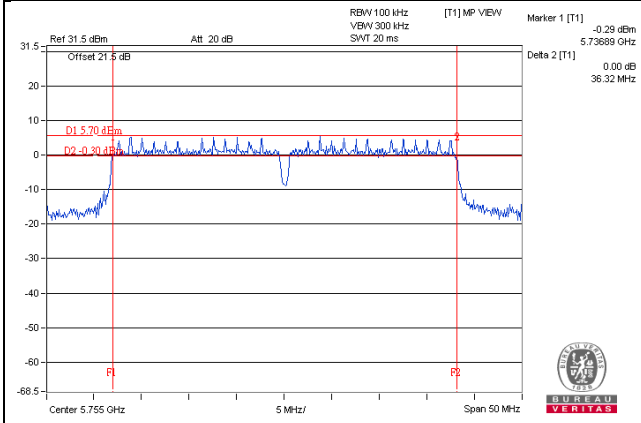

802.11ac (VHT80)_Chain 0 / CH155

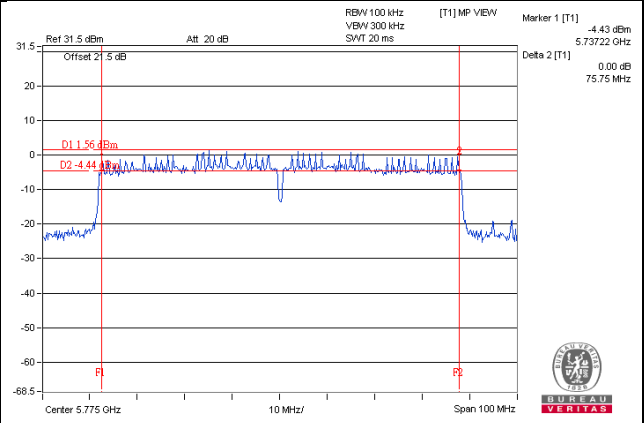

5 Pictures of Test Arrangements

Please refer to the attached file (Test Setup Photo).

Annex A- Radiated Out of Band Emission (OOBE) Measurement (For U-NII-3 band)

802.11a

CH 149 5745 MHz

Horizontal

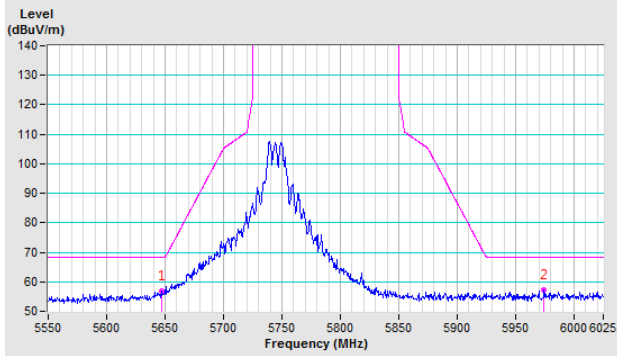

Vertical

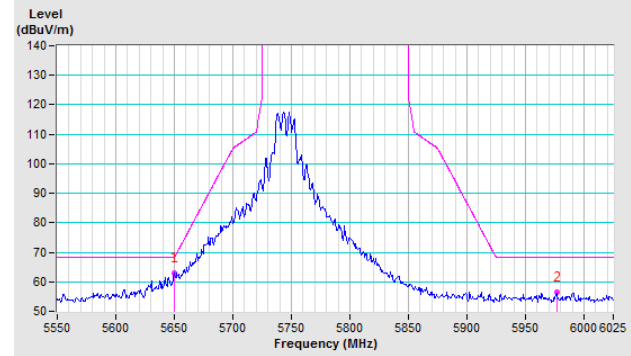

CH 157 5785 MHz

Horizontal

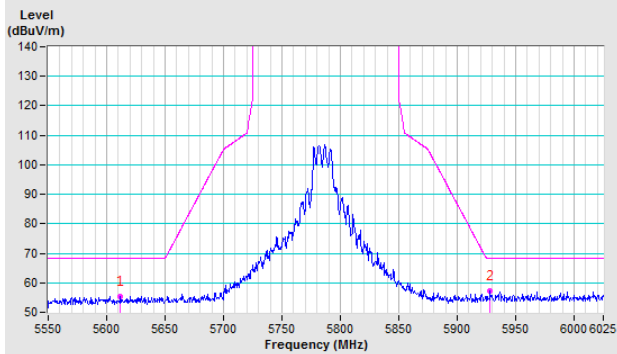

Vertical

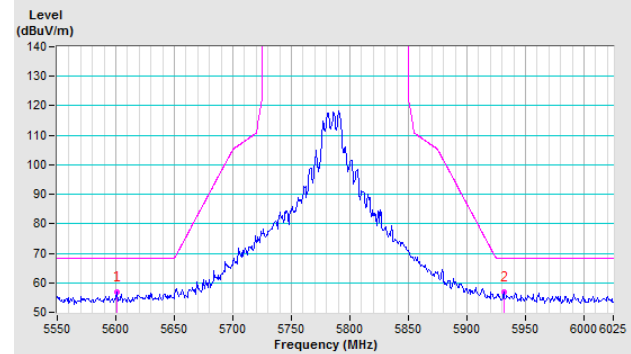

CH 165 5825 MHz

Horizontal

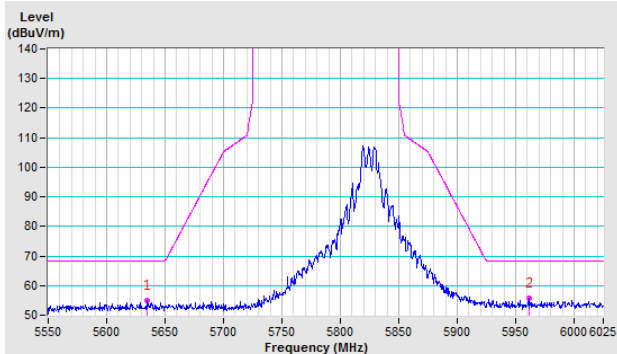

Vertical

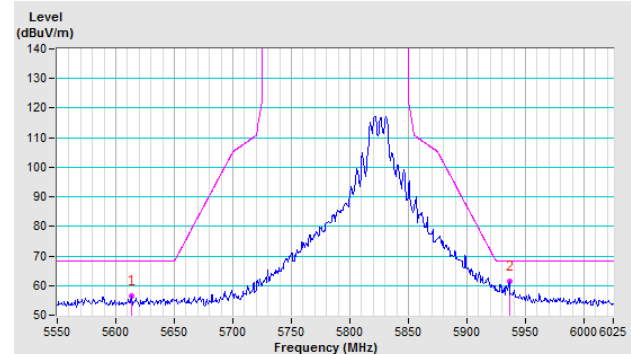

802.11ac (VHT20)

CH 149 5745 MHz

Horizontal

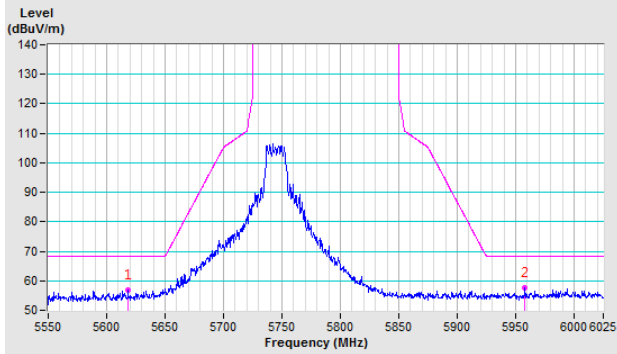

Vertical

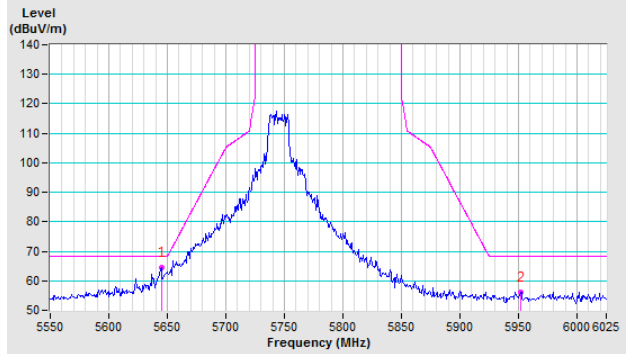

CH 157 5785 MHz

Horizontal

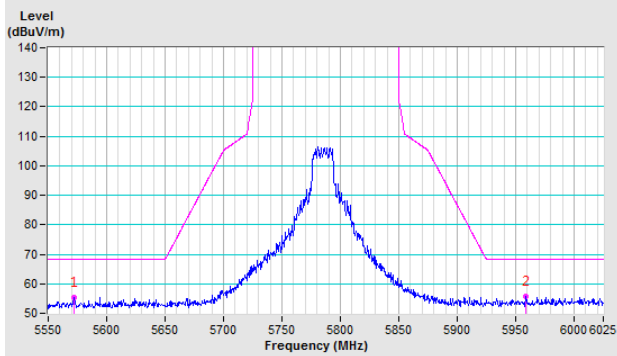

Vertical

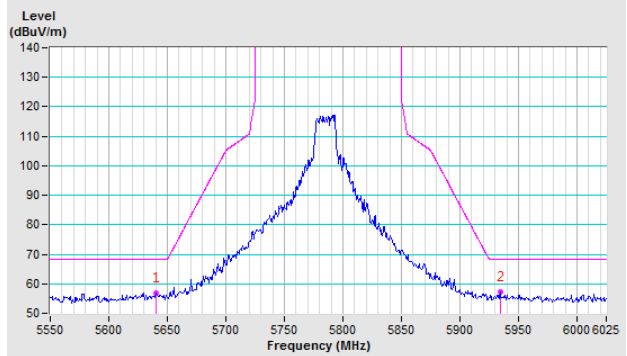

CH 165 5825 MHz

Horizontal

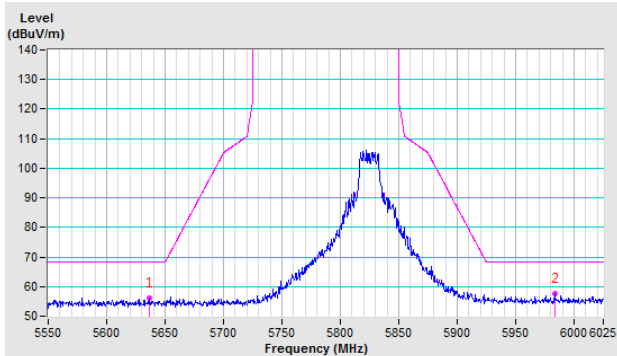

Vertical

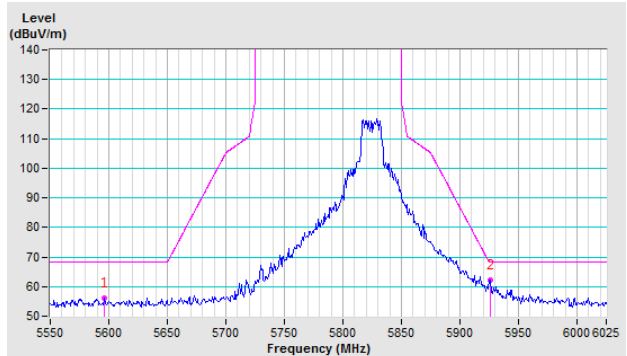

802.11ac (VHT40)

CH 151 5755 MHz

Horizontal

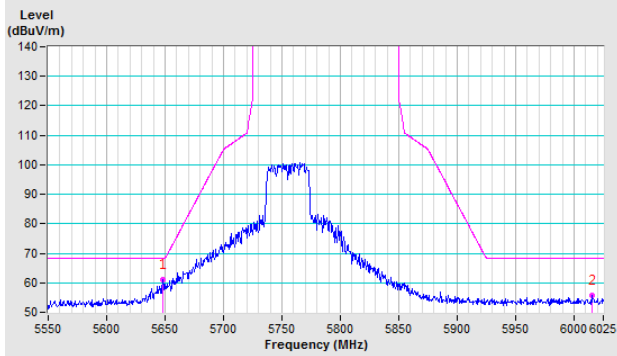

Vertical

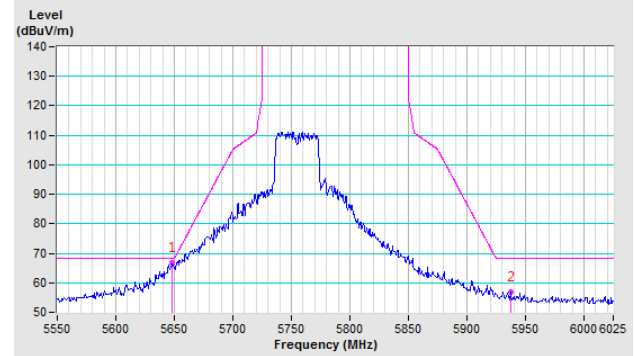

CH 159 5795 MHz

Horizontal

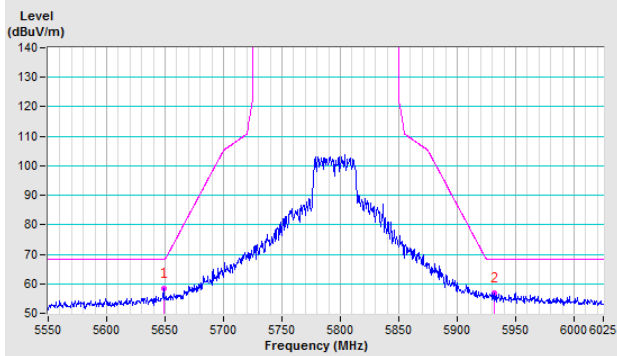

Vertical

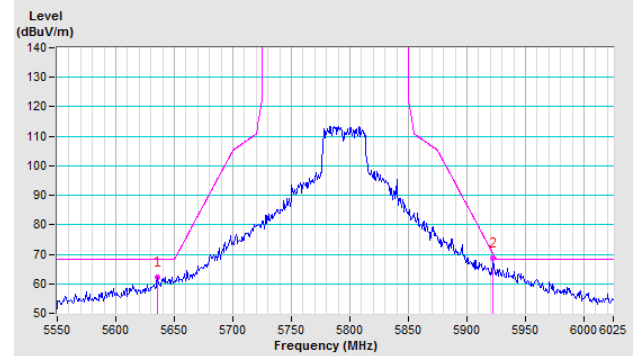

802.11ac (VHT80)

CH 155 5775 MHz

Horizontal

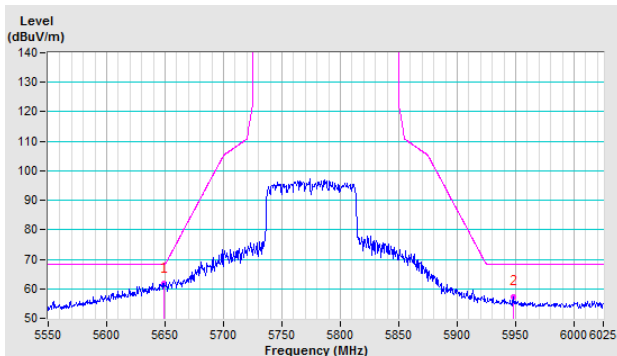

Vertical

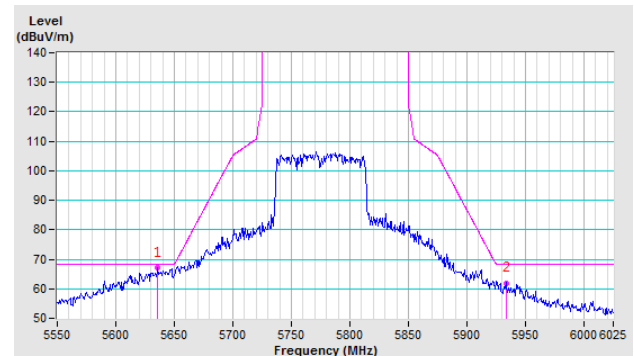

Appendix – Information on the Testing Laboratories

We, Bureau Veritas Consumer Products Services (H.K.) Ltd., Taoyuan Branch, were founded in 1988 to provide our best service in EMC, Radio, Telecom and Safety consultation. Our laboratories are accredited and approved according to ISO/IEC 17025.

If you have any comments, please feel free to contact us at the following:

Linko EMC/RF Lab

Tel: 886-2-26052180

Fax: 886-2-26051924

Hsin Chu EMC/RF/Telecom Lab

Tel: 886-3-6668565

Fax: 886-3-6668323

Hwa Ya EMC/RF/Safety Lab

Tel: 886-3-3183232

Fax: 886-3-3270892

Email: service.adt@tw.bureauveritas.com

Web Site: www.bureauveritas-adt.com

The address and road map of all our labs can be found in our web site also.

--- END ---