



SPORTON International Inc.

No. 52, Hwa Ya 1st Rd., Kwei-Shan Hsiang, TaoYuan Hsien, Taiwan, R.O.C.
Ph: 886-3-327-3456 / FAX: 886-3-327-0973 / www.sporton.com.tw

FCC RADIO TEST REPORT

Applicant's company	Motorola, Inc.
Applicant Address	One Motorola Plaza Holtsville, NY 11742 USA
FCC ID	UZ7AP7131
Manufacturer's company	Joy Technology(ShenZhen) Corporation
Manufacturer Address	Hengkeng Ind., Shanpai, shangwu, Aiqun Rd., Shiyao Town, Shenzhen, 518108, China

Product Name	11 a/b/g/n Access Point Module
Brand Name	Motorola
Model Name	AP-7131-MB82
Test Rule Part(s)	47 CFR FCC Part 15 Subpart E § 15.407
Test Freq. Range	5150 ~ 5250MHz
Received Date	Feb. 15, 2008
Final Test Date	Apr. 2, 2008
Submission Type	Original Equipment
Operating Mode	Master

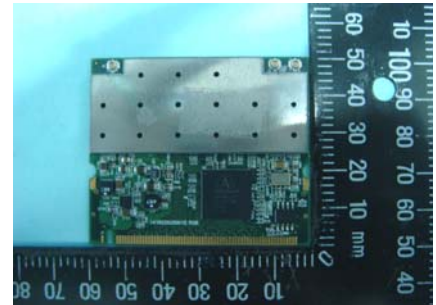

Statement

Test result included is only for the Draft n (5150 ~ 5250MHz) of the product.

The test result in this report refers exclusively to the presented test model / sample.

Without written approval of SPORTON International Inc., the test report shall not be reproduced except in full.

The measurements and test results shown in this test report were made in accordance with the procedures and found in compliance with the limit given in **ANSI C63.4-2003** and **47 CFR FCC Part 15 Subpart E**.

The test equipment used to perform the test is calibrated and traceable to NML/ROC.





Table of Contents

1. CERTIFICATE OF COMPLIANCE	1
2. SUMMARY OF THE TEST RESULT	2
3. GENERAL INFORMATION	3
3.1. Product Details.....	3
3.2. Accessories.....	5
3.3. Table for Filed Antenna.....	5
3.4. Table for Carrier Frequencies	6
3.5. Table for Test Modes.....	6
3.6. Table for Testing Locations.....	7
3.7. Table for Supporting Units	7
3.8. Table for Parameters of Test Software Setting	7
3.9. Test Configurations	10
4. TEST RESULT	16
4.1. AC Power Line Conducted Emissions Measurement.....	16
4.2. 99% Occupied Bandwidth Measurement	26
4.3. Maximum Conducted Output Power Measurement.....	41
4.4. Power Spectral Density Measurement	82
4.5. Peak Excursion Measurement.....	97
4.6. Radiated Emissions Measurement	113
4.7. Band Edge Emissions Measurement	171
4.8. Frequency Stability Measurement	188
4.9. Antenna Requirements	193
5. LIST OF MEASURING EQUIPMENTS	194
6. TEST LOCATION.....	195
7. TAF CERTIFICATE OF ACCREDITATION	196
APPENDIX A. PHOTOGRAPHS OF EUT.....	A1 ~ A20
APPENDIX B. TEST PHOTOS.....	B1 ~ B37
APPENDIX C. MAXIMUM PERMISSIBLE EXPOSURE.....	C1 ~ C3



History of This Test Report

Original Issue Date: May 22, 2008

Report No.: FR821502AB

No additional attachment.

Additional attachment were issued as following record:

Attachment No.	Issue Date	Description

1. CERTIFICATE OF COMPLIANCE

Product Name : 11 a/b/g/n Access Point Module
Brand Name : Motorola
Model Name : AP-7131-MB82
Applicant : Motorola, Inc.
Test Rule Part(s) : 47 CFR FCC Part 15 Subpart E § 15.407

Sporton International as requested by the applicant to evaluate the EMC performance of the product sample received on Feb. 15, 2008 would like to declare that the tested sample has been evaluated and found to be in compliance with the tested rule parts. The data recorded as well as the test configuration specified is true and accurate for showing the sample's EMC nature.



Wayne Hsu

SPORTON INTERNATIONAL INC.

2. SUMMARY OF THE TEST RESULT

Applied Standard: 47 CFR FCC Part 15 Subpart E				
Part	Rule Section	Description of Test	Result	Under Limit
4.1	15.207	AC Power Line Conducted Emissions	Complies	12.50 dB
4.2	15.407(a)	26dB Spectrum Bandwidth	Complies	-
4.3	15.407(a)	Maximum Conducted Output Power	Complies	0.16 dB
4.4	15.407(a)	Power Spectral Density	Complies	0.99 dB
4.5	15.407(a)	Peak Excursion	Complies	6.39 dB
4.6	15.407(b)	Radiated Emissions	Complies	0.59 dB
4.7	15.407(b)	Band Edge Emissions	Complies	0.10 dB
4.8	15.407(g)	Frequency Stability	Complies	-
4.9	15.203	Antenna Requirements	Complies	-

Test Items	Uncertainty	Remark
AC Power Line Conducted Emissions	±2.3dB	Confidence levels of 95%
Maximum Conducted Output Power	±0.5dB	Confidence levels of 95%
Power Spectral Density	±0.5dB	Confidence levels of 95%
Peak Excursion	±0.5dB	Confidence levels of 95%
26dB Spectrum Bandwidth / Frequency Stability	±8.5×10 ⁻⁸	Confidence levels of 95%
Radiated Emissions (9kHz~30MHz)	±0.8dB	Confidence levels of 95%
Radiated Emissions (30MHz~1000MHz)	±1.9dB	Confidence levels of 95%
Radiated / Band Edge Emissions (1GHz~18GHz)	±1.9dB	Confidence levels of 95%
Radiated Emissions (18GHz~40GHz)	±1.9dB	Confidence levels of 95%
Temperature	±0.7°C	Confidence levels of 95%
Humidity	±3.2%	Confidence levels of 95%
DC / AC Power Source	±1.4%	Confidence levels of 95%

3. GENERAL INFORMATION

3.1. Product Details

Items	Description
Product Type	WLAN (3TX, 3RX)
Radio Type	Intentional Transceiver
Power Type	From Host System
Modulation	see the below table for draft n
Data Modulation	OFDM (BPSK / QPSK / 16QAM / 64QAM)
Data Rate (Mbps)	see the below table for Draft n
Frequency Range	5150 ~ 5250MHz
Channel Number	4 for 20MHz bandwidth ; 2 for 40MHz bandwidth
Channel Band Width (99%)	MCS8 (20MHz) : 17.94 MHz ; MCS8 (40MHz) : 36.41 MHz
Conducted Output Power	Band 1: MCS8 (20MHz) : 16.60 dBm MCS8 (40MHz) : 16.84 dBm
Carrier Frequencies	Please refer to section 3.4
Antenna	Please refer to section 3.3

Antenna & Band width

Antenna	Three (TX)	
Band width Mode	20 MHz	40 MHz
11a Draft n	V	V

Draft n spec

MCS Index	Nss	Modulation	R	NBPSC	NCBPS		NDBPS		Data rate(Mbps)	
									800nsGI	
					20MHz	40MHz	20MHz	40MHz	20MHz	40MHz
0	1	BPSK	1/2	1	52	108	26	54	6.5	13.5
1	1	QPSK	1/2	2	104	216	52	108	13.0	27.0
2	1	QPSK	3/4	2	104	216	78	162	19.5	40.5
3	1	16-QAM	1/2	4	208	432	104	216	26.0	54.0
4	1	16-QAM	3/4	4	208	432	156	324	39.0	81.0
5	1	64-QAM	2/3	6	312	648	208	432	52.0	108.0
6	1	64-QAM	3/4	6	312	648	234	486	58.5	121.5
7	1	64-QAM	5/6	6	312	648	260	540	65.0	135.0
8	2	BPSK	1/2	1	104	216	52	108	13.0	27.0
9	2	QPSK	1/2	2	208	432	104	216	26.0	54.0
10	2	QPSK	3/4	2	208	432	156	324	39.0	81.0
11	2	16-QAM	1/2	4	416	864	208	432	52.0	108.0
12	2	16-QAM	3/4	4	416	864	312	648	78.0	162.0
13	2	64-QAM	2/3	6	624	1296	416	864	104.0	216.0
14	2	64-QAM	3/4	6	624	1296	468	972	117.0	243.0
15	2	64-QAM	5/6	6	624	1296	520	1080	130.0	270.0
16	3	BPSK	1/2	1	156	324	78	162	19.5	40.5
17	3	QPSK	1/2	2	312	648	156	324	39	81
18	3	QPSK	3/4	2	312	648	234	486	58.5	121.5
19	3	16-QAM	1/2	4	624	1296	312	648	78	162
20	3	16-QAM	3/4	4	624	1296	468	972	117	243
21	3	64-QAM	2/3	6	936	1944	624	1296	156	324
22	3	64-QAM	3/4	6	936	1944	702	1458	175.5	364.5
23	3	64-QAM	5/6	6	936	1944	780	1620	195	4055

Symbol	Explanation
NSS	Number of spatial streams
R	Code rate
NBPSC	Number of coded bits per single carrier
NCBPS	Number of coded bits per symbol
NDBPS	Number of data bits per symbol
GI	guard interval

3.2. Accessories

N/A

3.3. Table for Filed Antenna

For 5GHz Band

Ant.	Brand	Model Name	Antenna Type	Connector	Gain (dBi)
1	SYMBOL	ML-2452-APA2-01R	Dipole Antenna	Reversed-SMA	4
5	SYMBOL	ML-2452-APA2-FAC	embedded Antenna	Reversed-SMA	4.5
6	SYMBOL	ML-5299-WPNA1-01	Patch Antenna	Reversed-SMA	13
7	SYMBOL	ML-5299-HPA1-01	Omni Antenna	Reversed-SMA	5

Note : The EUT has four antennas.

Connector (J2) & Connector (J3) & Connector (J4) could Receiver / Transmitter simultaneously.

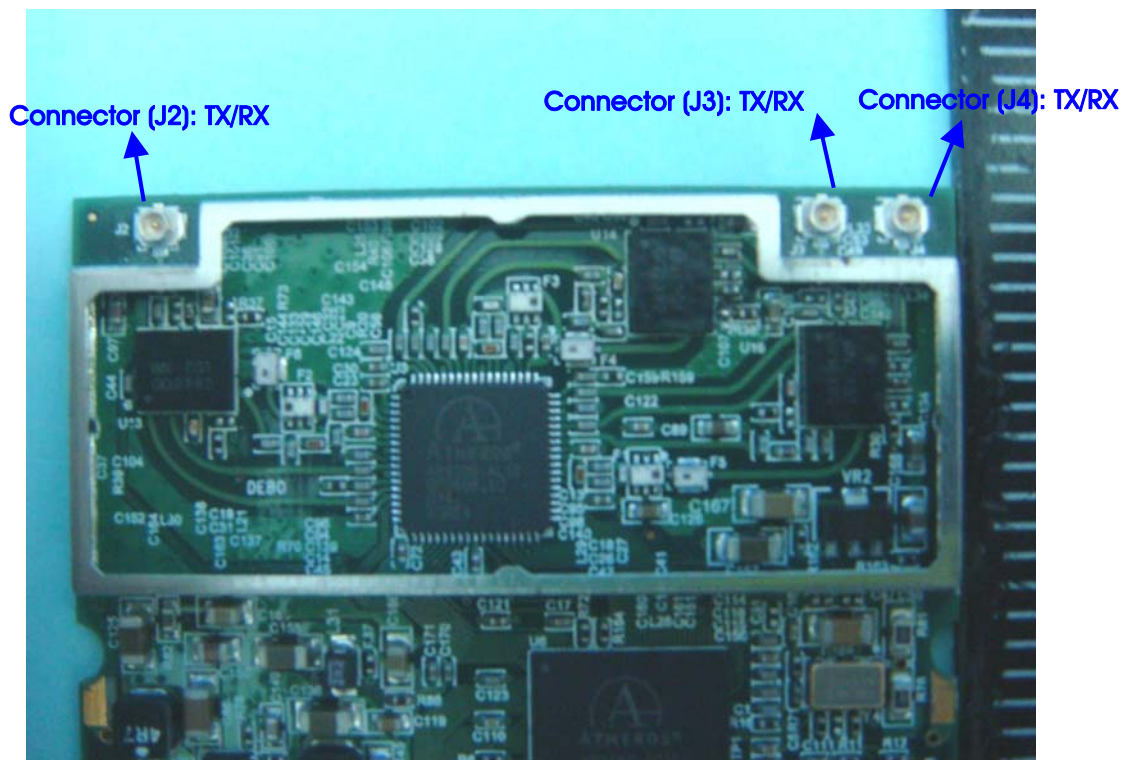

3.4. Table for Carrier Frequencies

There are two bandwidth systems for draft n.

For both 20MHz bandwidth systems, use Channel 36, 40, 44, 48.

For both 40MHz bandwidth systems, use Channel 38, 46.

Frequency Band	Channel No.	Frequency	Channel No.	Frequency
5150~5250 MHz (USA/Canada) Band 1	36	5180 MHz	44	5220 MHz
	38	5190 MHz	46	5230 MHz
	40	5200 MHz	48	5240 MHz

3.5. Table for Test Modes

Preliminary tests were performed in different data rate to find the worst radiated emission. The data rate shown in the table below is the worst-case rate with respect to the specific test item. Investigation has been done on all the possible configurations for searching the worst cases. The following table is a list of the test modes shown in this test report.

Test Items	Mode		Data Rate	Channel	Antenna
AC Power Conducted Emission	Normal Link		Auto	-	1, 5, 6, 7
Max. Conducted Output Power	MCS8/20MHz	Band 1	13Mbps	36/40/48	1, 5, 6, 7
	MCS8/40MHz	Band 1	27Mbps	38/46	1, 5, 6, 7
26dB Spectrum Bandwidth 99% Occupied Bandwidth Measurement	MCS8/20MHz	Band 1	13Mbps	36/40/48	1, 5, 6, 7
	MCS8/40MHz	Band 1	27Mbps	38/46	1, 5, 6, 7
Power Spectral Density Peak Excursion					
Radiated Emission Below 1GHz	Normal Link		Auto	-	1, 5, 6, 7
Radiated Emission Above 1GHz	MCS8/20MHz	Band 1	13Mbps	36/40/48	1, 5, 6, 7
	MCS8/40MHz	Band 1	27Mbps	38/46	1, 5, 6, 7
Band Edge Emission	MCS8/20MHz	Band 1	13Mbps	36/40/48	1, 5, 6, 7
	MCS8/40MHz	Band 1	27Mbps	38/46	1, 5, 6, 7
Frequency Stability	Un-modulation		-	40	1, 5, 6, 7

3.6. Table for Testing Locations

Test Site No.	Site Category	Location	FCC Reg. No.	IC File No.	VCCI Reg. No
03CH03-HY	SAC	Hwa Ya	101377	IC 4088	-
CO04-HY	Conduction	Hwa Ya	101377	IC 4088	-
TH01-HY	OVEN Room	Hwa Ya	-	-	-

Open Area Test Site (OATS); Semi Anechoic Chamber (SAC); Fully Anechoic Chamber (FAC).

Please refer section 6 for Test Site Address.

3.7. Table for Supporting Units

Support Unit	Brand	Model	FCC ID
Notebook	DELL	D400	E2K24GBRL
Notebook	DELL	D505	E2K24GBRL
Modem	ACEEX	DM1414	IFAXDM1414
Mouse	QSKY	Lx-619B	DOC
Printer	EPSON	LQ-300+	DOC

3.8. Table for Parameters of Test Software Setting

During testing, Channel & Power Controlling Software provided by the customer was used to control the operating channel as well as the output power level. The RF output power selection is for the setting of RF output power expected by the customer and is going to be fixed on the firmware of the final end product.

For Antenna 1

Power Parameters of Draft n MCS8 20MHz

Test Software Version	ART		
Frequency	5180 MHz	5200 MHz	5240 MHz
Draft n	11	11.5	11.5

Power Parameters of Draft n MCS8 40MHz

Test Software Version	ART	
Frequency	5190 MHz	5230 MHz
Draft n	9	11

For Antenna 5
Power Parameters of Draft n MCS8 20MHz

Test Software Version	ART		
Frequency	5180 MHz	5200 MHz	5240 MHz
Draft n	11	11.5	11.5

Power Parameters of Draft n MCS8 40MHz

Test Software Version	ART	
Frequency	5190 MHz	5230 MHz
Draft n	10.5	11

For Antenna 6
Power Parameters of Draft n MCS8 20MHz

Test Software Version	ART		
Frequency	5180 MHz	5200 MHz	5240 MHz
Draft n	5	5	5

Power Parameters of Draft n MCS8 40MHz

Test Software Version	ART	
Frequency	5190 MHz	5230 MHz
Draft n	4.5	4.5

For Antenna 7
Power Parameters of Draft n MCS8 20MHz

Test Software Version	ART		
Frequency	5180 MHz	5200 MHz	5240 MHz
Draft n	11	11.5	11.5

Power Parameters of Draft n MCS8 40MHz

Test Software Version	ART	
Frequency	5190 MHz	5230 MHz
Draft n	11	11

An executive program, EMCTEST.EXE under WIN XP, which generates a complete line of continuously repeating “ H “ pattern was used as the test software.

The program was executed as follows :

- a. Turn on the power of all equipment.
- b. The NB sends “ H “ messages to the panel, and the panel displays “ H “ patterns on the screen.
- c. The NB sends “ H “ messages to the printer, then the printer prints them on the paper.
- d. The NB sends “ H “ messages to the modem.
- e. Repeat the steps from b to d.

At the same time, “ART” was executed to control the EUT continuously transmit RF signal.

3.9. Test Configurations

3.9.1. Radiation Emissions Test Configuration

Antenna 1

Test configuration: 9kHz ~ 1GHz

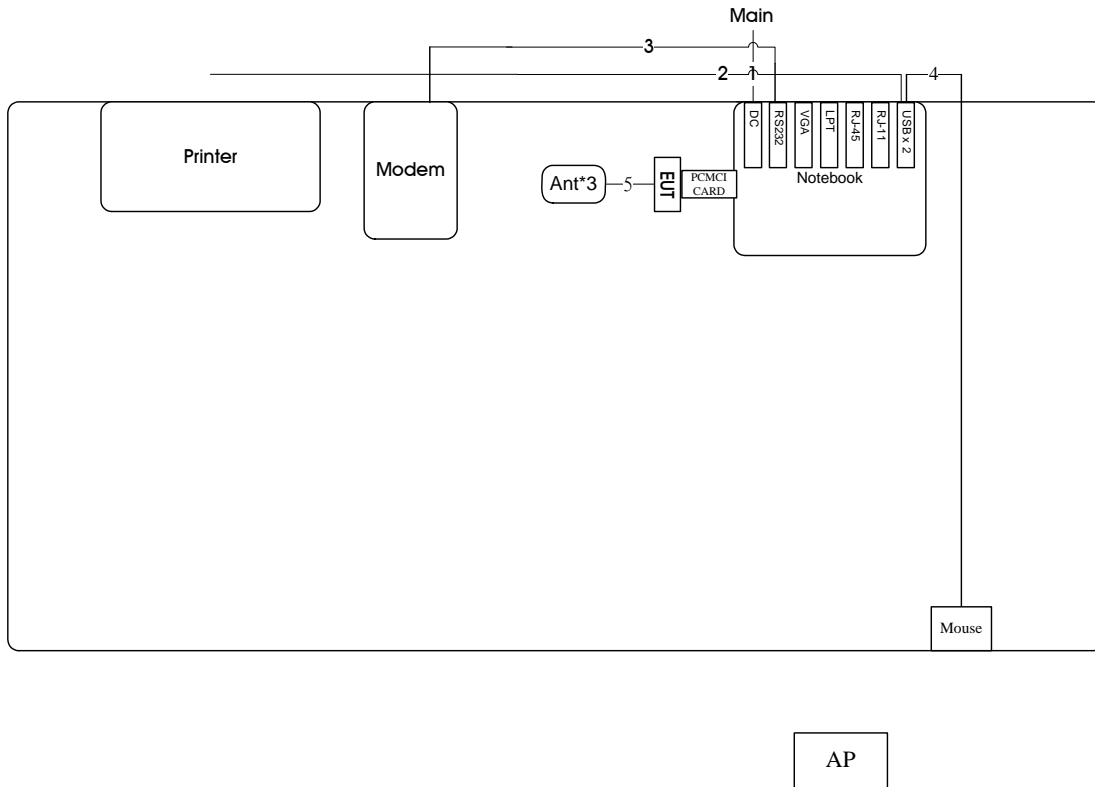

Test configuration: Above 1GHz

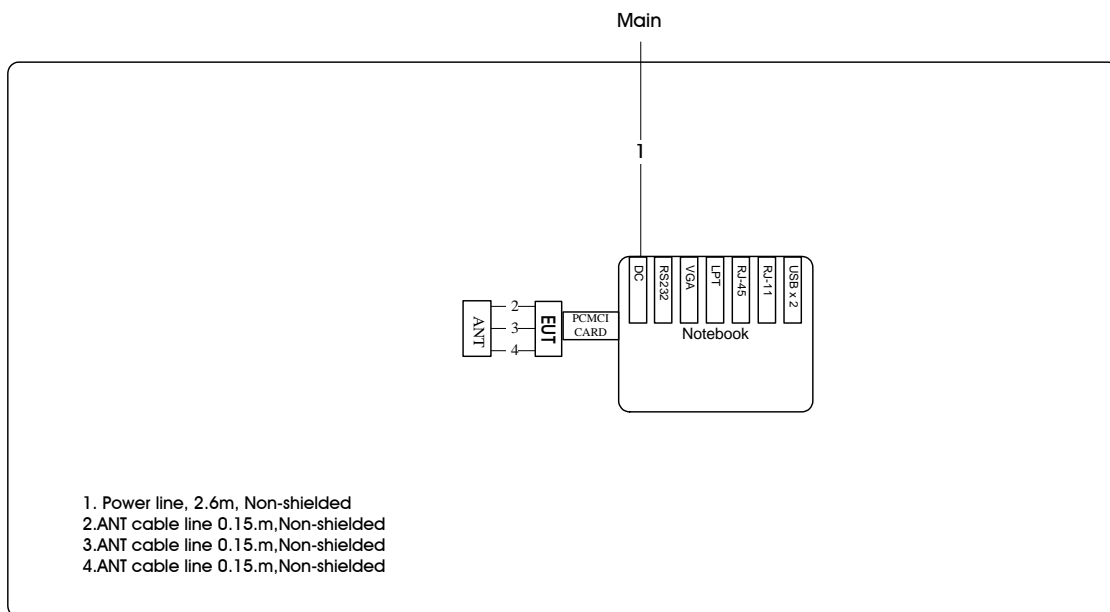

Antenna 5

Test configuration: 9kHz ~1GHz

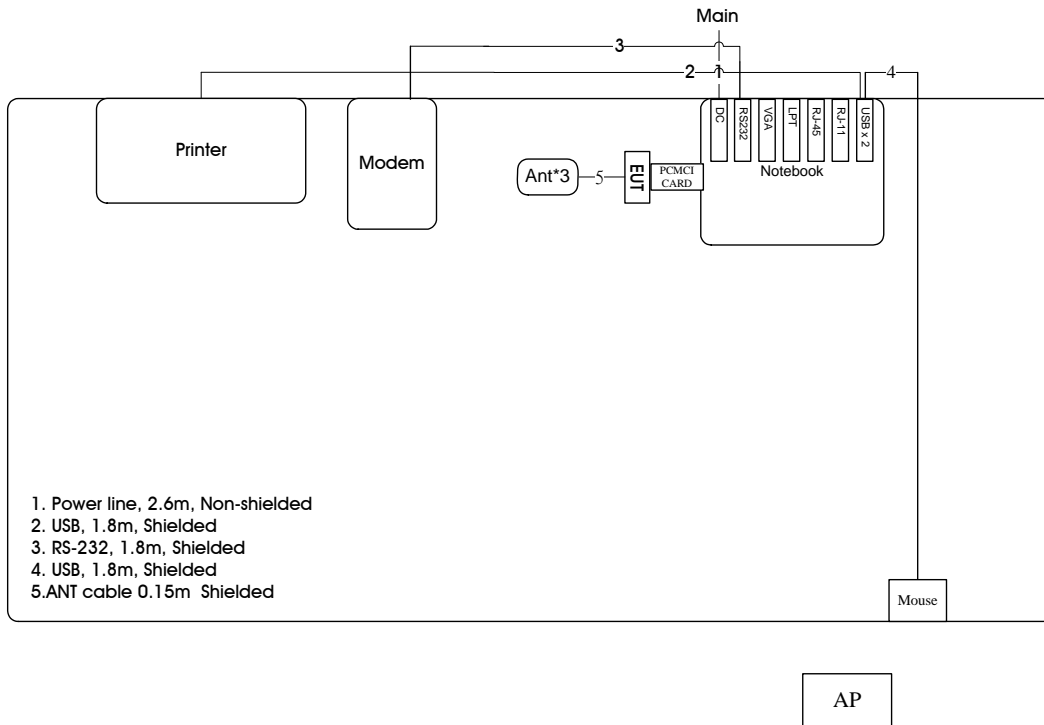

Test configuration: Above 1GHz

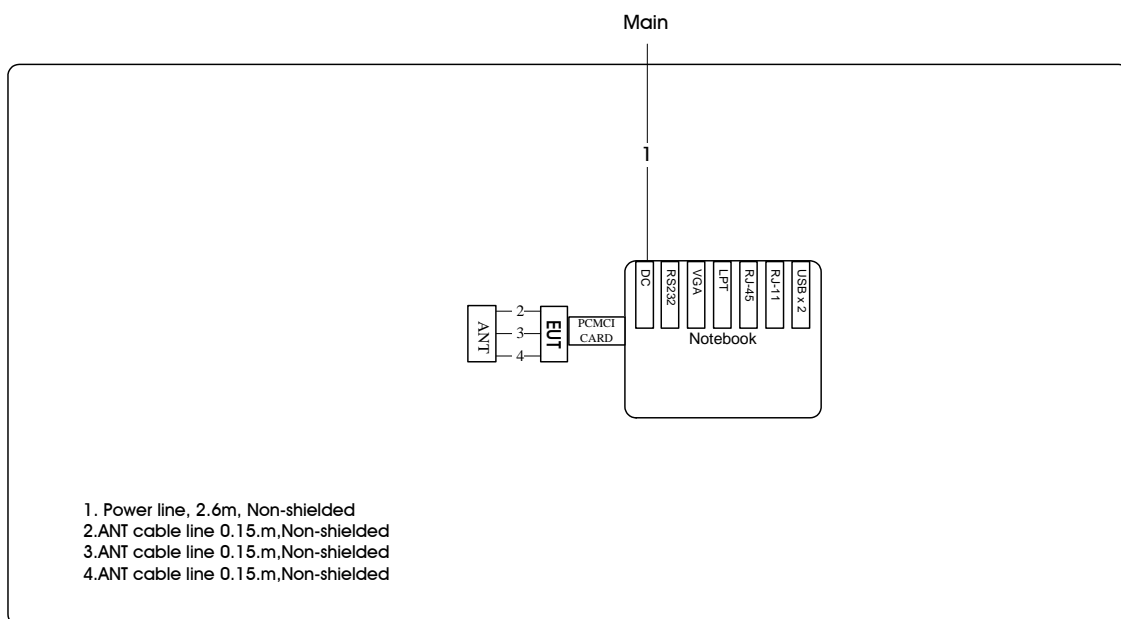

Antenna 6

Test configuration: 9kHz ~1GHz

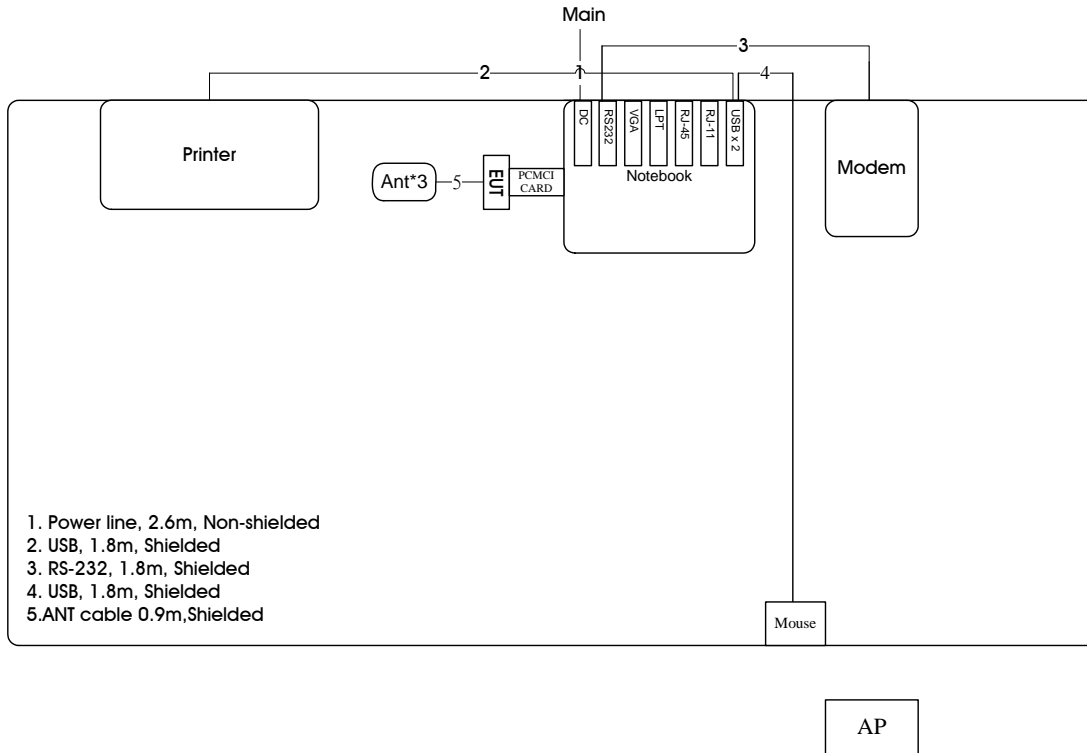

Test configuration: Above 1GHz

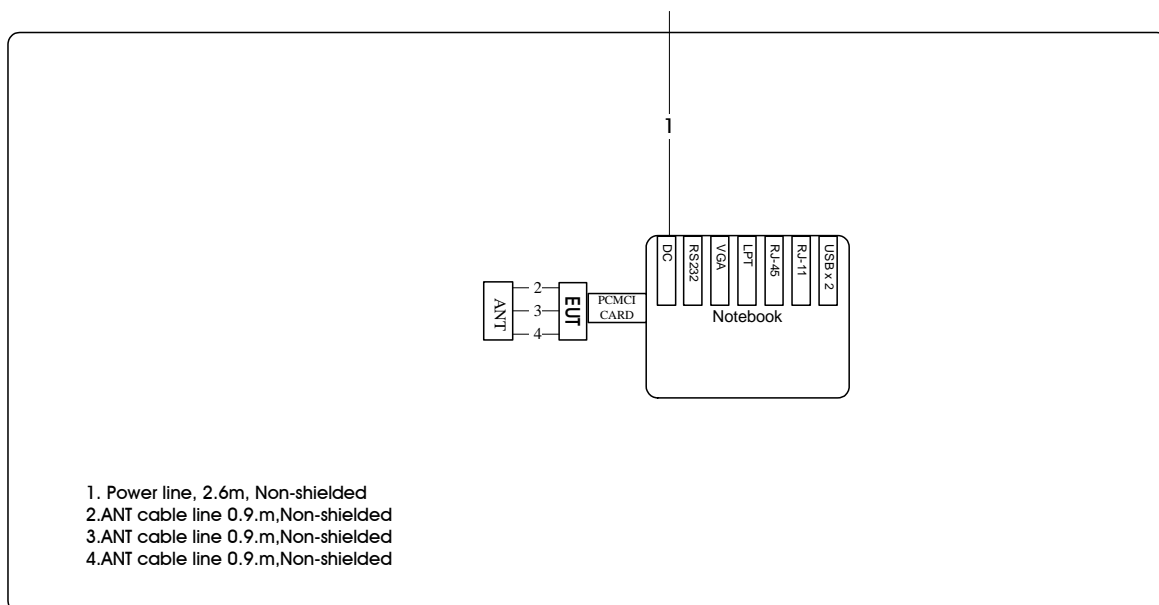

Antenna 7

Test configuration: 9kHz ~1GHz

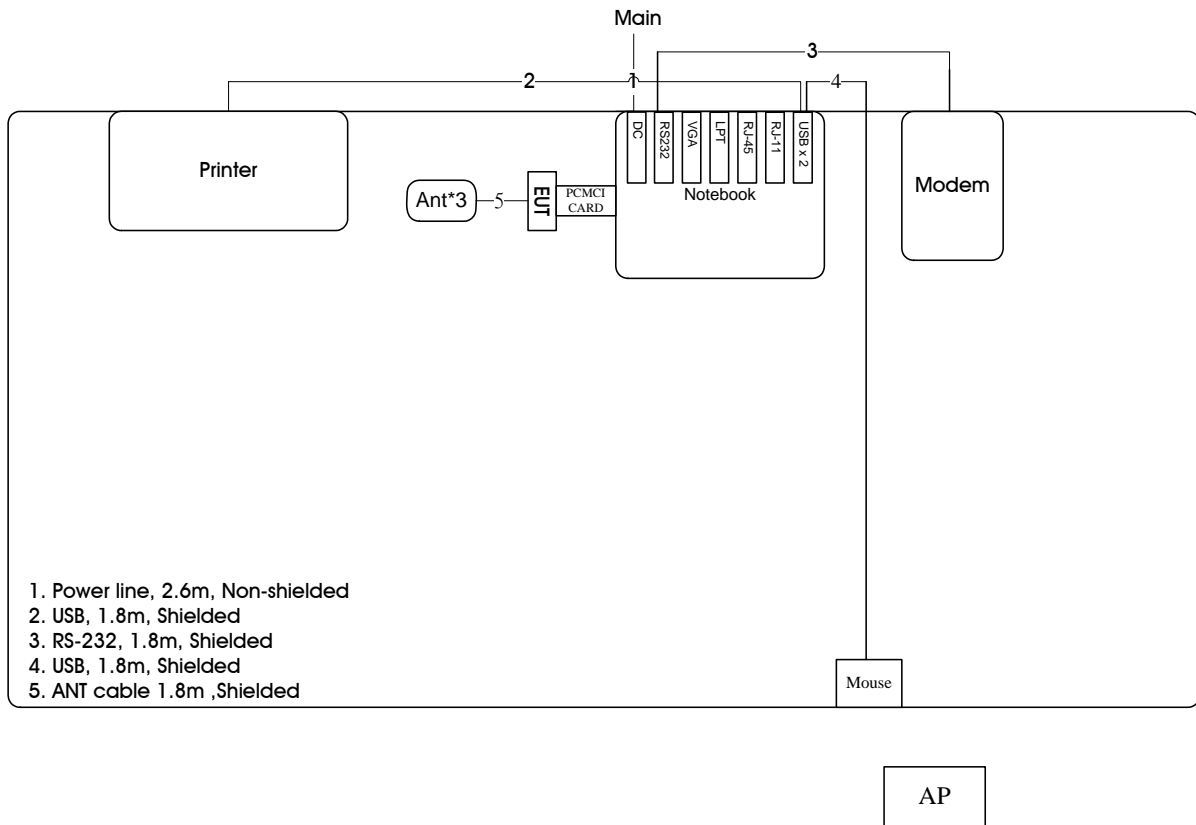

Test configuration: Above 1GHz

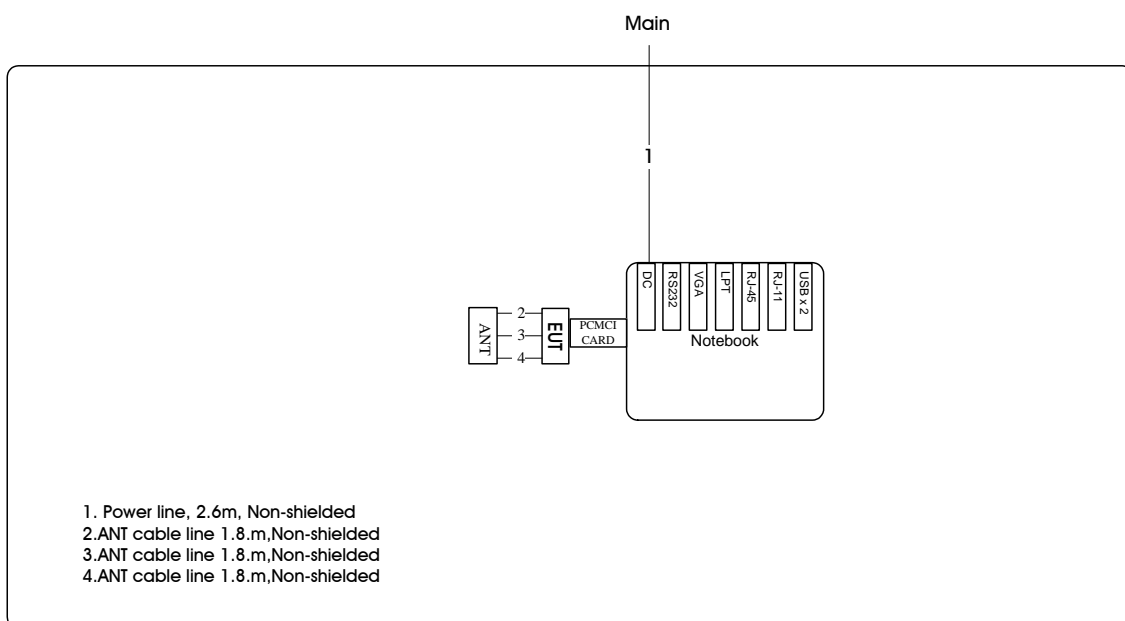

3.9.2. AC Power Line Conduction Emissions Test Configuration

Antenna 1

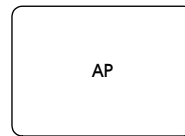
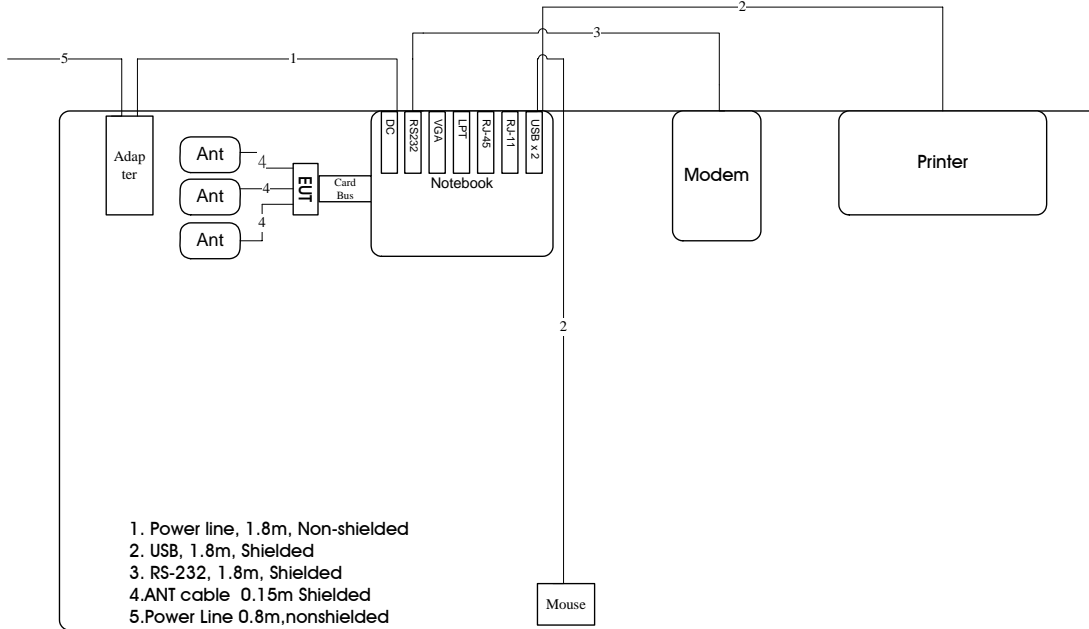

Antenna 5

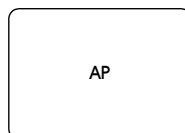
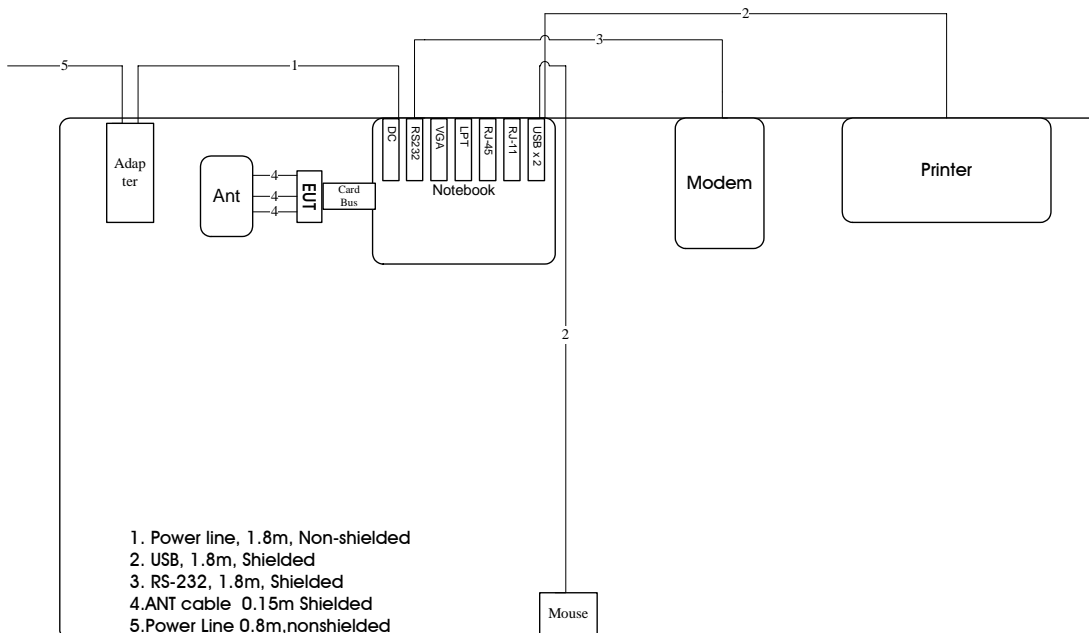

Antenna 6

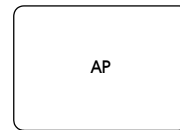
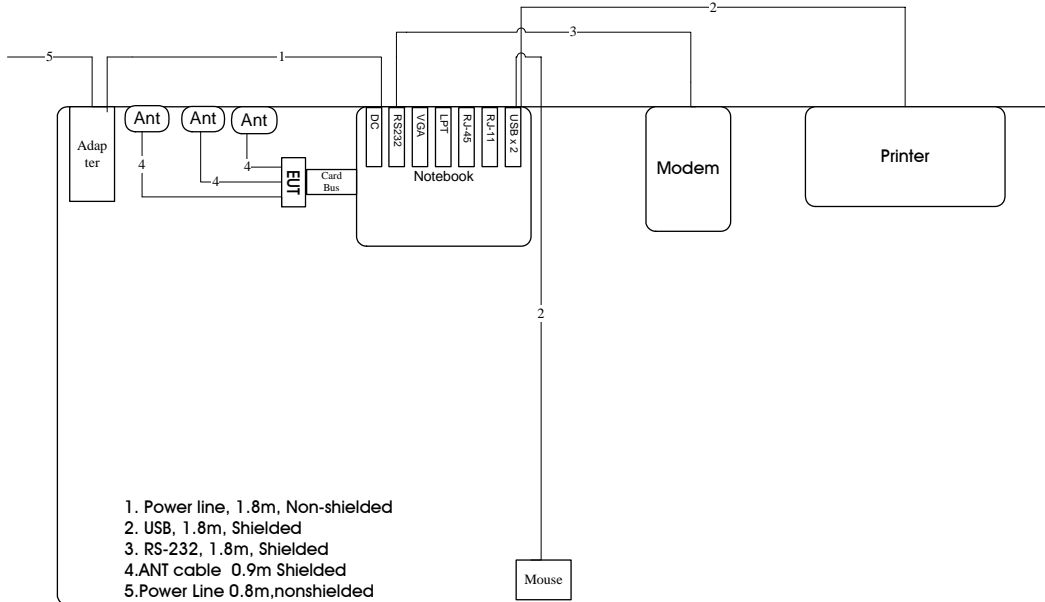

Antenna 7

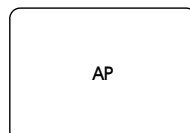
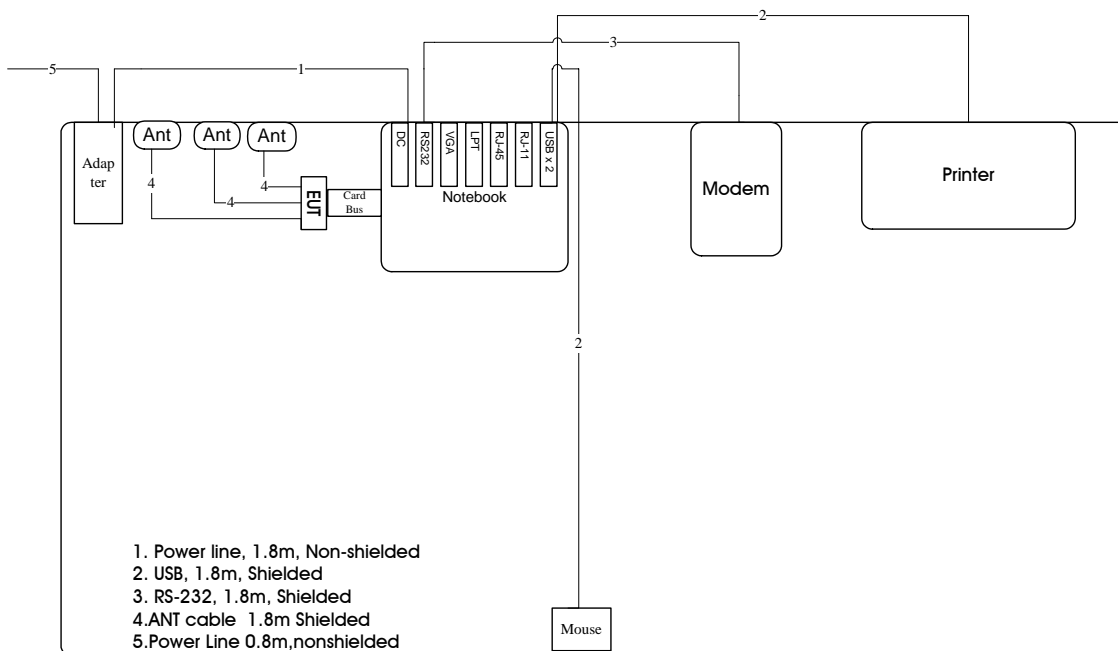

4. TEST RESULT

4.1. AC Power Line Conducted Emissions Measurement

4.1.1. Limit

For this product that is designed to connect to the AC power line, the radio frequency voltage that is conducted back onto the AC power line on any frequency or frequencies within the band 150 kHz to 30 MHz shall not exceed below limits table.

Frequency (MHz)	QP Limit (dBuV)	AV Limit (dBuV)
0.15~0.5	66~56	56~46
0.5~5	56	46
5~30	60	50

4.1.2. Measuring Instruments and Setting

Please refer to section 5 of equipments list in this report. The following table is the setting of the receiver.

Receiver Parameters	Setting
Attenuation	10 dB
Start Frequency	0.15 MHz
Stop Frequency	30 MHz
IF Bandwidth	9 KHz

4.1.3. Test Procedures

1. Configure the EUT according to ANSI C63.4. The EUT or host of EUT has to be placed 0.4 meter far from the conducting wall of the shielding room and at least 80 centimeters from any other grounded conducting surface.
2. Connect EUT or host of EUT to the power mains through a line impedance stabilization network (LISN).
3. All the support units are connected to the other LISNs. The LISN should provide 50uH/50ohms coupling impedance.
4. The frequency range from 150 KHz to 30 MHz was searched.
5. Set the test-receiver system to Peak Detect Function and Specified Bandwidth with Maximum Hold Mode.
6. The measurement has to be done between each power line and ground at the power terminal.

4.1.4. Test Setup Layout

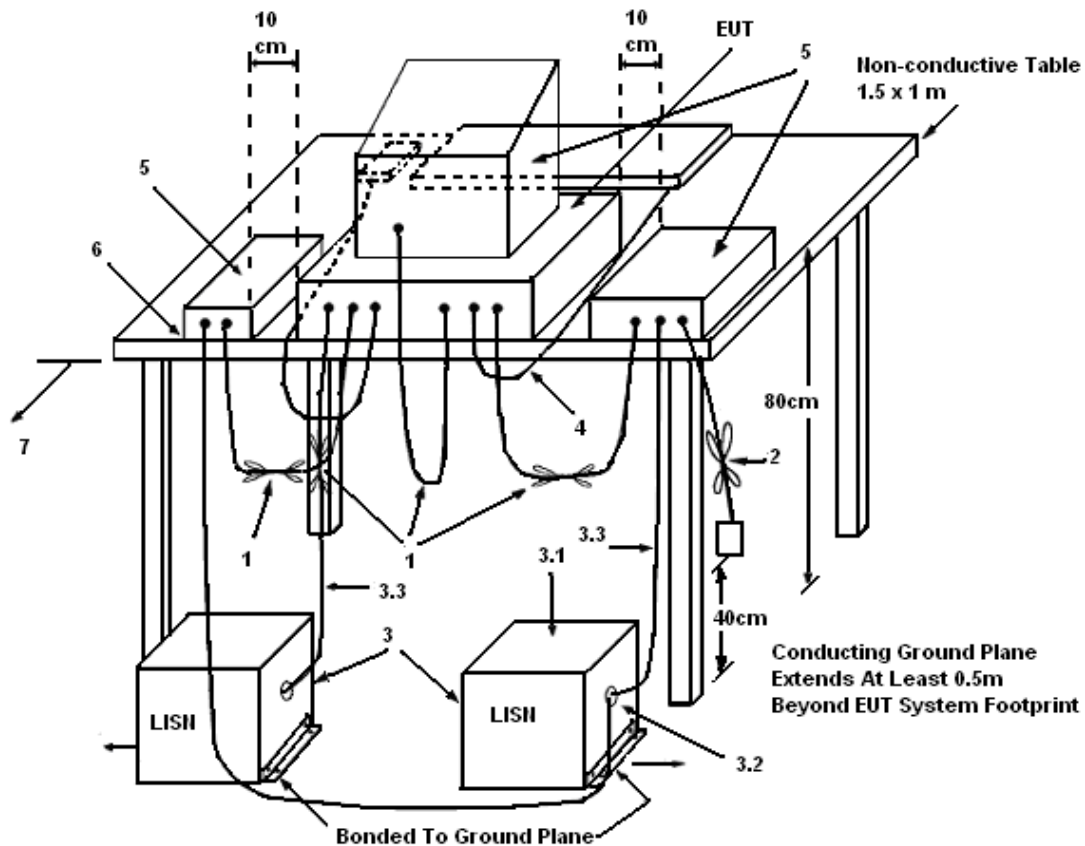

LEGEND:

- (1) Interconnecting cables that hang closer than 40 cm to the ground plane shall be folded back and forth in the center forming a bundle 30 to 40 cm long.
- (2) I/O cables that are not connected to a peripheral shall be bundled in the center. The end of the cable may be terminated, if required, using the correct terminating impedance. The overall length shall not exceed 1 m.
- (3) EUT connected to one LISN. Unused LISN measuring port connectors shall be terminated in 50Ω . LISN can be placed on top of, or immediately beneath, reference ground plane.
 - (3.1) All other equipment powered from additional LISN(s).
 - (3.2) Multiple outlet strip can be used for multiple power cords of non-EUT equipment.
 - (3.3) LISN at least 80 cm from nearest part of EUT chassis.
- (4) Cables of hand-operated devices, such as keyboards, mice, etc., shall be placed as for normal use.
- (5) Non-EUT components of EUT system being tested.
- (6) Rear of EUT, including peripherals, shall all be aligned and flush with rear of tabletop.
- (7) Rear of tabletop shall be 40 cm removed from a vertical conducting plane that is bonded to the ground plane.

4.1.5. Test Deviation

There is no deviation with the original standard.

4.1.6. EUT Operation during Test

The EUT was placed on the test table and programmed in normal function.

4.1.7. Results of AC Power Line Conducted Emissions Measurement

Temperature	25°C	Humidity	43%
Test Engineer	Cloud Peng	Phase	Line
Configuration	Antenna 1		

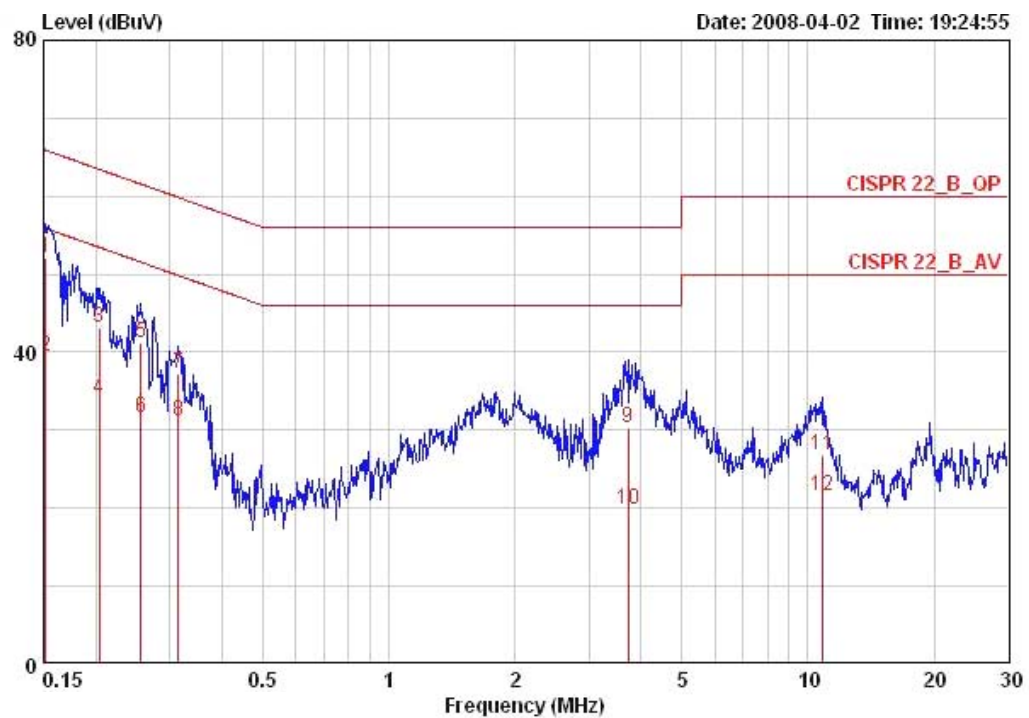

	Freq	Level	Over Limit	Limit Line	Read Level	LISN Factor	Cable Loss	Remark
	MHz	dBuV	dB	dBuV	dBuV	dB	dB	
1	0.15160	52.13	-13.78	65.91	51.73	0.20	0.20	QP
2	0.15160	39.50	-16.41	55.91	39.10	0.20	0.20	AVERAGE
3	0.20396	43.15	-20.30	63.45	42.85	0.10	0.20	QP
4	0.20396	33.91	-19.54	53.45	33.61	0.10	0.20	AVERAGE
5	0.25615	41.14	-20.42	61.56	40.84	0.10	0.20	QP
6	0.25615	31.69	-19.87	51.56	31.39	0.10	0.20	AVERAGE
7	0.31495	37.28	-22.56	59.84	36.98	0.10	0.20	QP
8	0.31495	31.09	-18.75	49.84	30.79	0.10	0.20	AVERAGE
9	3.720	30.26	-25.74	56.00	29.96	0.00	0.30	QP
10	3.720	19.94	-26.06	46.00	19.64	0.00	0.30	AVERAGE
11	10.847	26.82	-33.18	60.00	26.32	0.10	0.40	QP
12	10.847	21.61	-28.39	50.00	21.11	0.10	0.40	AVERAGE

Temperature	25°C	Humidity	43%
Test Engineer	Cloud Peng	Phase	Neutral
Configuration	Antenna 1		

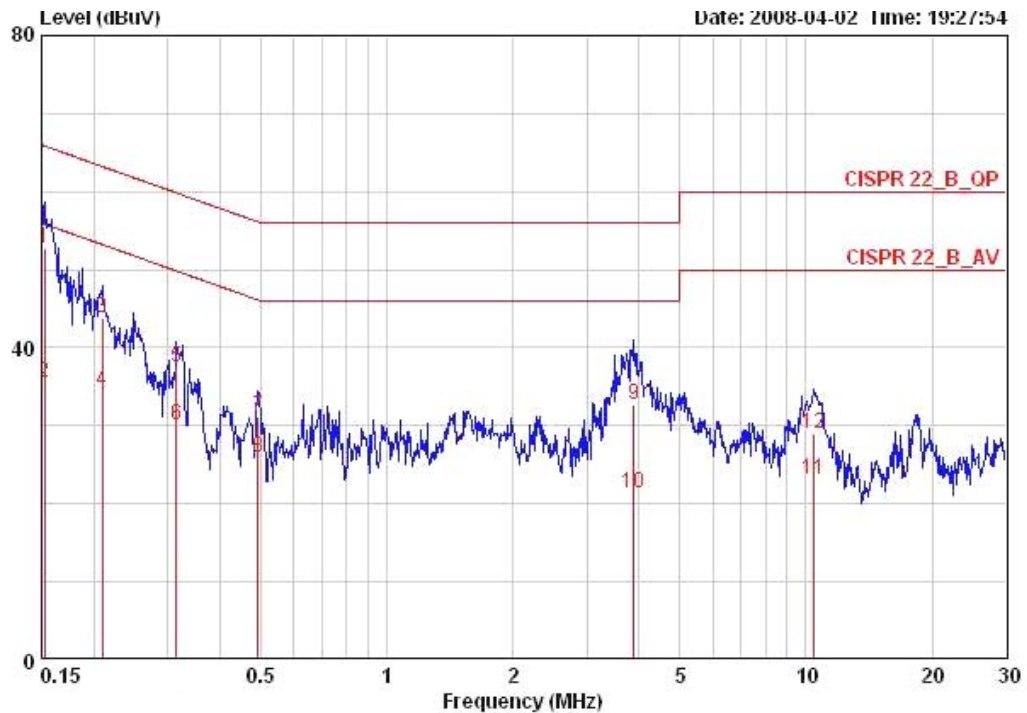

	Freq	Level	Over	Limit	Read	LISN	Cable	Remark
	MHz	dBuV	Limit	Line	Level	Factor	Loss	
			dB	dBuV	dBuV	dB	dB	
1	0.15240	52.77	-13.10	65.87	52.27	0.30	0.20	QP
2	0.15240	35.45	-20.42	55.87	34.95	0.30	0.20	AVERAGE
3	0.20944	43.71	-19.52	63.23	43.31	0.20	0.20	QP
4	0.20944	34.46	-18.77	53.23	34.06	0.20	0.20	AVERAGE
5	0.31495	37.45	-22.39	59.84	37.12	0.13	0.20	QP
6	0.31495	30.13	-19.71	49.84	29.80	0.13	0.20	AVERAGE
7	0.49150	31.09	-25.06	56.14	30.86	0.10	0.13	QP
8	0.49150	25.87	-20.28	46.14	25.64	0.10	0.13	AVERAGE
9	3.881	32.69	-23.31	56.00	32.29	0.10	0.30	QP
10	3.881	21.32	-24.68	46.00	20.92	0.10	0.30	AVERAGE
11	10.397	23.08	-26.92	50.00	22.60	0.10	0.38	AVERAGE
12	10.397	29.10	-30.90	60.00	28.62	0.10	0.38	QP

Note:

Level = Read Level + LISN Factor + Cable Loss.

Temperature	25°C	Humidity	43%
Test Engineer	Cloud Peng	Phase	Line
Configuration	Antenna 5		

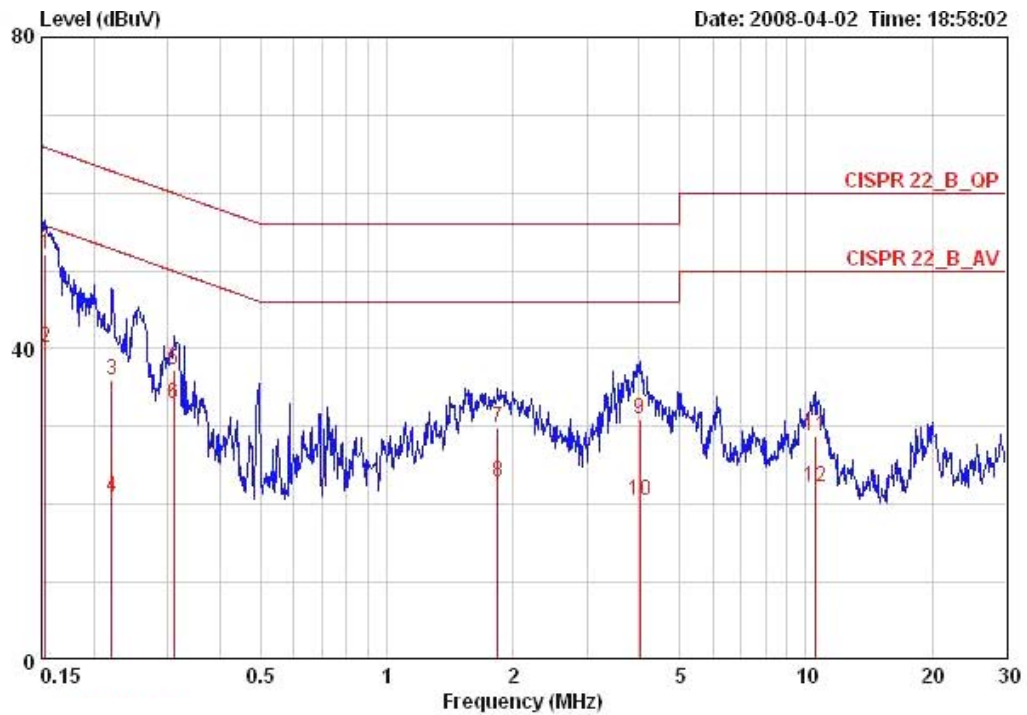

	Freq	Level	Over	Limit	Read	LISN	Cable	Remark
	MHz	dBuV	Limit	Line	Level	Factor	Loss	
			dB	dBuV	dBuV	dB	dB	
1	0.15321	52.12	-13.70	65.82	51.72	0.20	0.20	QP
2	0.15321	40.19	-15.63	55.82	39.79	0.20	0.20	AVERAGE
3	0.22083	36.04	-26.75	62.79	35.74	0.10	0.20	QP
4	0.22083	20.88	-31.91	52.79	20.58	0.10	0.20	AVERAGE
5	0.30998	37.25	-22.72	59.97	36.95	0.10	0.20	QP
6	0.30998	32.90	-17.07	49.97	32.60	0.10	0.20	AVERAGE
7	1.839	29.86	-26.14	56.00	29.69	0.00	0.17	QP
8	1.839	22.96	-23.04	46.00	22.79	0.00	0.17	AVERAGE
9	4.006	30.90	-25.10	56.00	30.60	0.00	0.30	QP
10	4.006	20.40	-25.60	46.00	20.10	0.00	0.30	AVERAGE
11	10.564	28.67	-31.33	60.00	28.17	0.10	0.40	QP
12	10.564	22.30	-27.70	50.00	21.80	0.10	0.40	AVERAGE

Temperature	25°C	Humidity	43%
Test Engineer	Cloud Peng	Phase	Neutral
Configuration	Antenna 5		

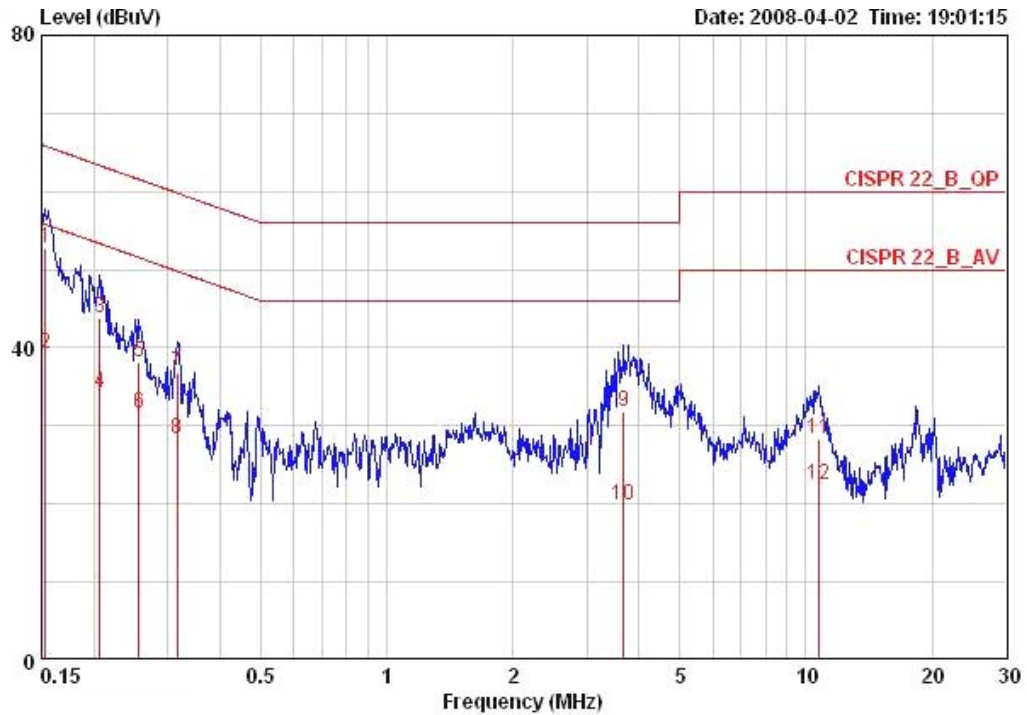

	Freq	Level	Over	Limit	Read	LISN	Cable	Remark
	MHz	dBuV	Limit	Line	Level	Factor	Loss	
			dB	dBuV	dBuV	dB	dB	
1	0.15321	52.82	-13.00	65.82	52.32	0.30	0.20	QP
2	0.15321	39.24	-16.58	55.82	38.74	0.30	0.20	AVERAGE
3	0.20614	43.81	-19.55	63.36	43.41	0.20	0.20	QP
4	0.20614	34.31	-19.05	53.36	33.91	0.20	0.20	AVERAGE
5	0.25615	38.12	-23.44	61.56	37.75	0.17	0.20	QP
6	0.25615	31.71	-19.85	51.56	31.34	0.17	0.20	AVERAGE
7	0.31662	36.74	-23.05	59.80	36.41	0.13	0.20	QP
8	0.31662	28.37	-21.42	49.80	28.04	0.13	0.20	AVERAGE
9	3.681	31.77	-24.23	56.00	31.37	0.10	0.30	QP
10	3.681	19.89	-26.11	46.00	19.49	0.10	0.30	AVERAGE
11	10.733	28.23	-31.77	60.00	27.73	0.10	0.40	QP
12	10.733	22.45	-27.55	50.00	21.95	0.10	0.40	AVERAGE

Note:

Level = Read Level + LISN Factor + Cable Loss.

Temperature	25°C	Humidity	43%
Test Engineer	Cloud Peng	Phase	Line
Configuration	Antenna 6		

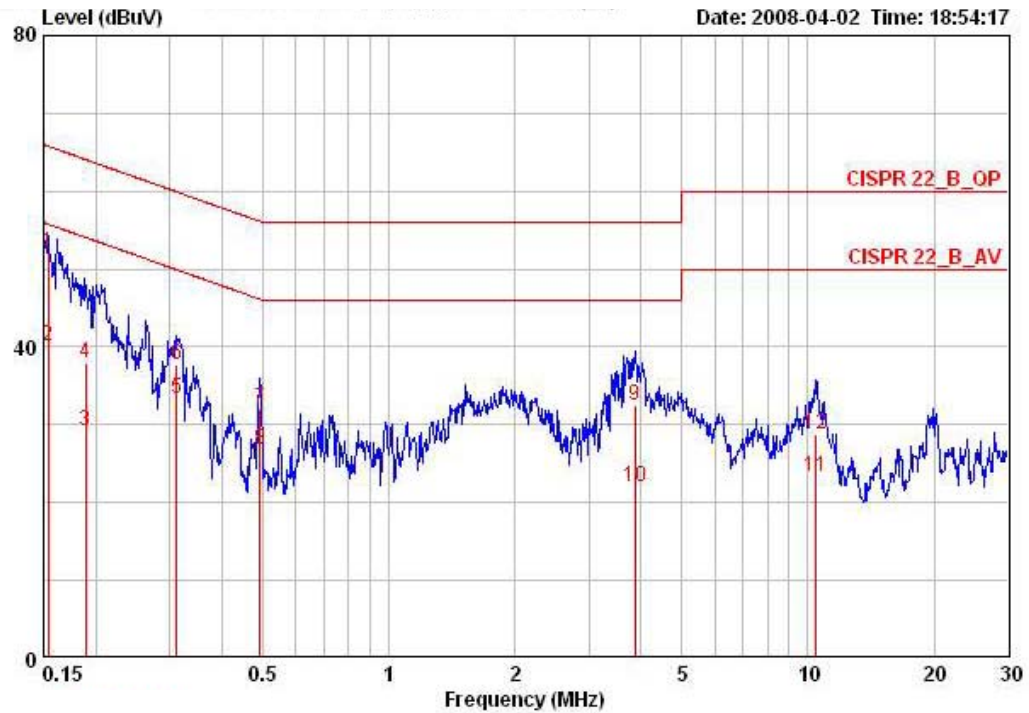

	Freq	Level	Over	Limit	Read	LISN	Cable	
	MHz	dBuV	Limit	Line	Level	Factor	Loss	Remark
			dB	dBuV	dBuV	dB	dB	
1	0.15403	52.10	-13.68	65.78	51.70	0.20	0.20	QP
2	0.15403	40.19	-15.59	55.78	39.79	0.20	0.20	AVERAGE
3	0.18938	29.12	-24.94	54.06	28.77	0.15	0.20	AVERAGE
4	0.18938	37.97	-26.09	64.06	37.62	0.15	0.20	QP
5	0.31163	33.42	-16.51	49.93	33.12	0.10	0.20	AVERAGE
6	0.31163	37.74	-22.19	59.93	37.44	0.10	0.20	QP
7	0.49150	31.94	-24.20	56.14	31.73	0.09	0.13	QP
8	0.49150	26.78	-19.36	46.14	26.57	0.09	0.13	AVERAGE
9	3.860	32.46	-23.54	56.00	32.16	0.00	0.30	QP
10	3.860	21.96	-24.04	46.00	21.66	0.00	0.30	AVERAGE
11	10.397	23.25	-26.75	50.00	22.77	0.10	0.38	AVERAGE
12	10.397	28.88	-31.12	60.00	28.40	0.10	0.38	QP

Temperature	25°C	Humidity	43%
Test Engineer	Cloud Peng	Phase	Neutral
Configuration	Antenna 6		

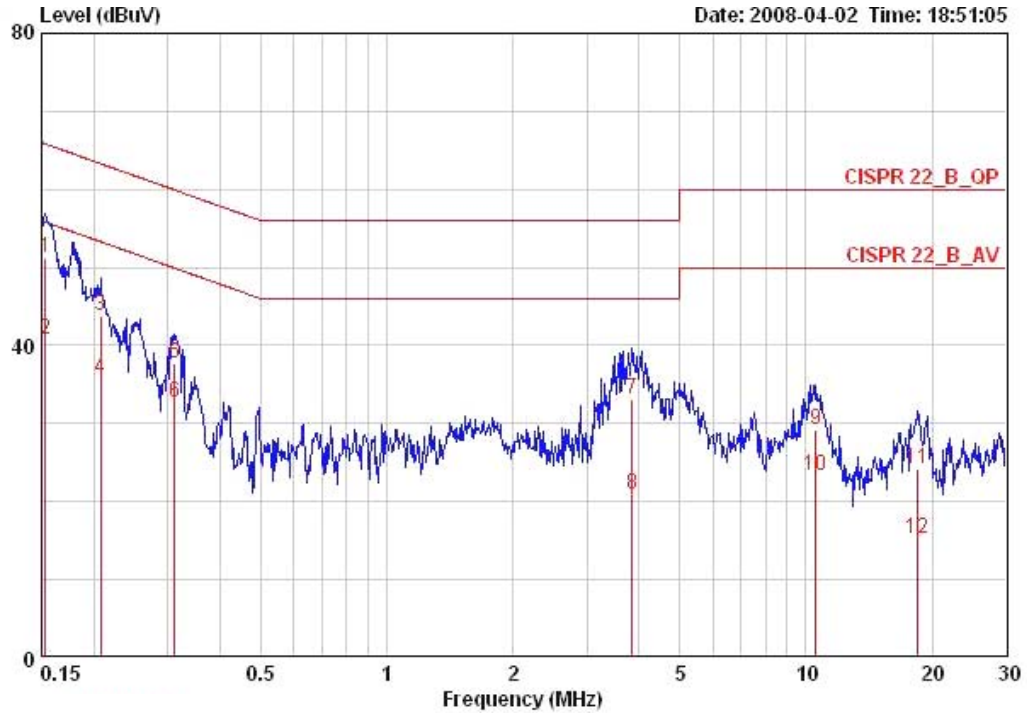

	Freq	Level	Over Limit	Limit Line	Read Level	LISN Factor	Cable Loss	Remark
	MHz	dBuV	dB	dBuV	dBuV	dB	dB	
1	0.15321	51.27	-14.55	65.82	50.77	0.30	0.20	QP
2	0.15321	40.82	-15.00	55.82	40.32	0.30	0.20	AVERAGE
3	0.20723	43.81	-19.51	63.32	43.41	0.20	0.20	QP
4	0.20723	35.82	-17.50	53.32	35.42	0.20	0.20	AVERAGE
5	0.31163	37.73	-22.20	59.93	37.38	0.15	0.20	QP
6	0.31163	32.77	-17.16	49.93	32.42	0.15	0.20	AVERAGE
7	3.840	33.09	-22.91	56.00	32.69	0.10	0.30	QP
8	3.840	20.99	-25.01	46.00	20.59	0.10	0.30	AVERAGE
9	10.564	29.27	-30.73	60.00	28.77	0.10	0.40	QP
10	10.564	23.28	-26.72	50.00	22.78	0.10	0.40	AVERAGE
11	18.524	24.20	-35.80	60.00	23.60	0.10	0.50	QP
12	18.524	15.31	-34.69	50.00	14.71	0.10	0.50	AVERAGE

Note:

Level = Read Level + LISN Factor + Cable Loss.

Temperature	25°C	Humidity	43%
Test Engineer	Cloud Peng	Phase	Line
Configuration	Antenna 7		

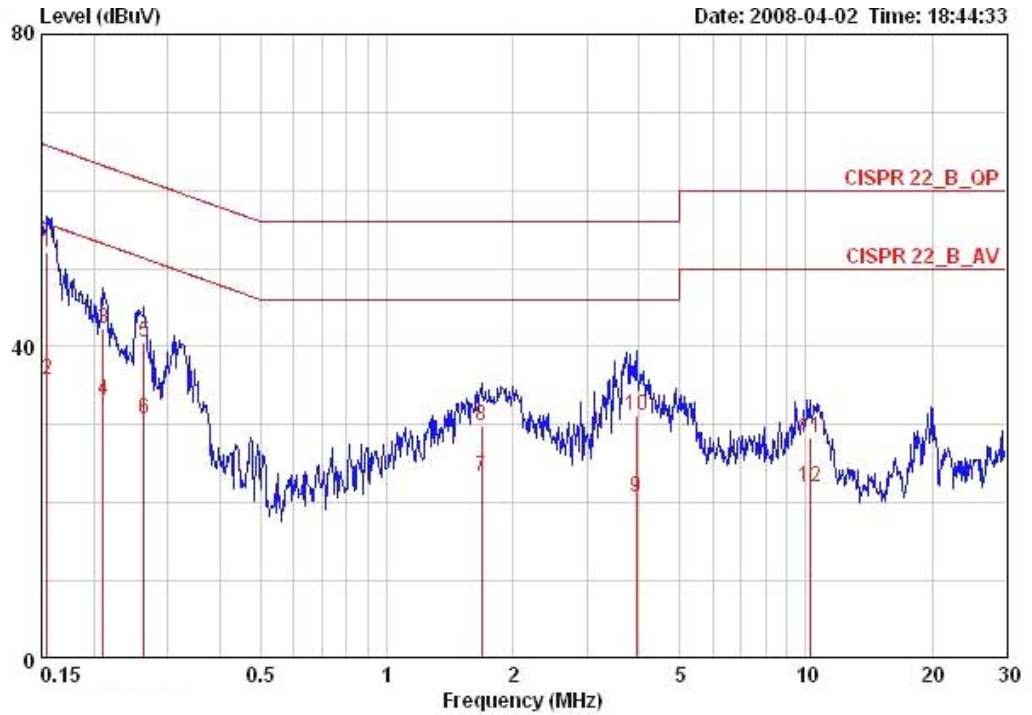

	Freq	Level	Over	Limit	Read	LISN	Cable	
	MHz	dBuV	Limit	Line	Level	Factor	Loss	Remark
			dB	dBuV	dBuV	dB	dB	
1	0.15485	52.18	-13.56	65.74	51.78	0.20	0.20	QP
2	0.15485	35.66	-20.08	55.74	35.26	0.20	0.20	AVERAGE
3	0.21055	42.30	-20.88	63.18	42.00	0.10	0.20	QP
4	0.21055	33.05	-20.13	53.18	32.75	0.10	0.20	AVERAGE
5	0.26303	40.46	-20.88	61.34	40.16	0.10	0.20	QP
6	0.26303	30.64	-20.70	51.34	30.34	0.10	0.20	AVERAGE
7	1.680	23.33	-22.67	46.00	23.19	0.00	0.14	AVERAGE
8	1.680	29.93	-26.07	56.00	29.79	0.00	0.14	QP
9	3.943	20.76	-25.24	46.00	20.46	0.00	0.30	AVERAGE
10	3.943	31.19	-24.81	56.00	30.89	0.00	0.30	QP
11	10.233	28.23	-31.77	60.00	27.79	0.10	0.34	QP
12	10.233	22.02	-27.98	50.00	21.58	0.10	0.34	AVERAGE

Temperature	25°C	Humidity	43%
Test Engineer	Cloud Peng	Phase	Neutral
Configuration	Antenna 7		

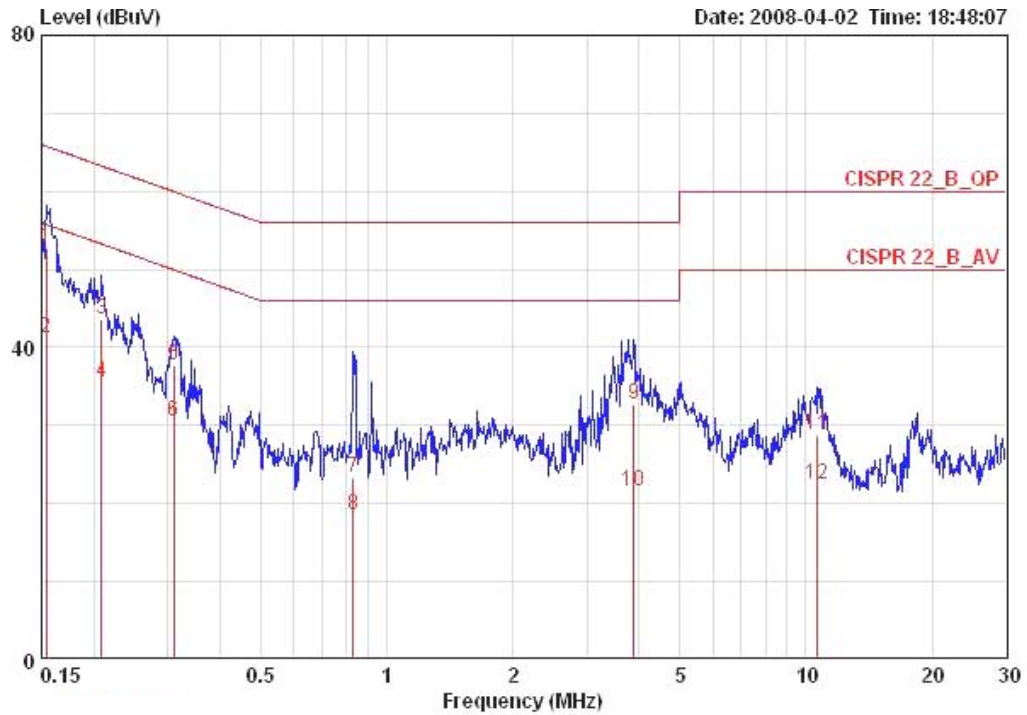

	Freq	Level	Over	Limit	Read	LISN	Cable	Remark
	MHz	dBuV	Limit	Line	Level	Factor	Loss	
			dB	dBuV	dBuV	dB	dB	
1 @	0.15403	52.72	-13.06	65.78	52.22	0.30	0.20	QP
2	0.15403	41.17	-14.61	55.78	40.67	0.30	0.20	AVERAGE
3	0.20833	43.59	-19.68	63.27	43.19	0.20	0.20	QP
4	0.20833	35.61	-17.66	53.27	35.21	0.20	0.20	AVERAGE
5	0.30998	37.64	-22.33	59.97	37.29	0.15	0.20	QP
6	0.30998	30.54	-19.43	49.97	30.19	0.15	0.20	AVERAGE
7	0.83047	23.42	-32.58	56.00	23.12	0.10	0.20	QP
8	0.83047	18.61	-27.39	46.00	18.31	0.10	0.20	AVERAGE
9	3.881	32.63	-23.37	56.00	32.23	0.10	0.30	QP
10	3.881	21.58	-24.42	46.00	21.18	0.10	0.30	AVERAGE
11	10.676	28.88	-31.12	60.00	28.38	0.10	0.40	QP
12	10.676	22.49	-27.51	50.00	21.99	0.10	0.40	AVERAGE

Note:

Level = Read Level + LISN Factor + Cable Loss.

4.2. 99% Occupied Bandwidth Measurement

4.2.1. Limit

No restriction limits. But resolution bandwidth within band edge measurement is 1% of the 99% occupied bandwidth.

4.2.2. Measuring Instruments and Setting

Please refer to section 5 of equipments list in this report. The following table is the setting of the spectrum analyzer.

Spectrum Parameters	Setting
Attenuation	Auto
Span Frequency	> 26dB Bandwidth
RB	300 kHz
VB	1000 kHz
Detector	RMS
Trace	Max Hold
Sweep Time	Auto

4.2.3. Test Procedures

1. The transmitter output (antenna port) was connected to the spectrum analyzer in peak hold mode.
2. The resolution bandwidth of 300 kHz and the video bandwidth of 1000 kHz were used.
3. Measured the spectrum width with power higher than 26dB below carrier.
4. Measuring multiple antennas, the connector is required to link with spectrum analyzer through a combiner.

4.2.4. Test Setup Layout

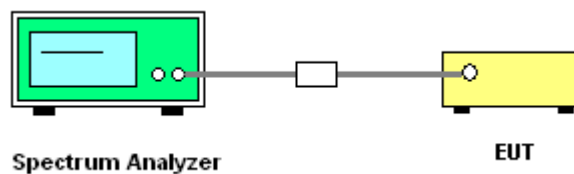

4.2.5. Test Deviation

There is no deviation with the original standard.

4.2.6. EUT Operation during Test

The EUT was programmed to be in continuously transmitting mode.

4.2.7. Test Result of 99% Occupied Bandwidth

Temperature	22°C	Humidity	61%
Test Engineer	Sam Chen	Configurations	Draft n / Antenna 1

Configuration Draft n MCS8 20MHz Ant. 1

Channel	Frequency	26dB Bandwidth (MHz)	99% Occupied Bandwidth (MHz)
36	5180 MHz	22.43	16.79
40	5200 MHz	21.92	16.79
48	5240 MHz	22.69	16.79

Configuration Draft n MCS8 40MHz Ant. 1

Channel	Frequency	26dB Bandwidth (MHz)	99% Occupied Bandwidth (MHz)
38	5190 MHz	43.58	36.41
46	5230 MHz	43.58	36.41

Temperature	22°C	Humidity	61%
Test Engineer	Sam Chen	Configurations	Draft n / Antenna 5

Configuration Draft n MCS8 20MHz Ant. 5

Channel	Frequency	26dB Bandwidth (MHz)	99% Occupied Bandwidth (MHz)
36	5180 MHz	22.43	16.79
40	5200 MHz	21.92	16.79
48	5240 MHz	22.69	16.79

Configuration Draft n MCS8 40MHz Ant. 5

Channel	Frequency	26dB Bandwidth (MHz)	99% Occupied Bandwidth (MHz)
38	5190 MHz	43.07	36.41
46	5230 MHz	43.58	36.41

Temperature	22°C	Humidity	61%
Test Engineer	Sam Chen	Configurations	Draft n / Antenna 6

Configuration Draft n MCS8 20MHz Ant. 6

Channel	Frequency	26dB Bandwidth (MHz)	99% Occupied Bandwidth (MHz)
36	5180 MHz	22.82	17.94
40	5200 MHz	22.94	17.94
48	5240 MHz	22.69	17.94

Configuration Draft n MCS8 40MHz Ant. 6

Channel	Frequency	26dB Bandwidth (MHz)	99% Occupied Bandwidth (MHz)
38	5190 MHz	42.82	36.41
46	5230 MHz	43.97	36.41

Temperature	22°C	Humidity	61%
Test Engineer	Sam Chen	Configurations	Draft n / Antenna 7

Configuration Draft n MCS8 20MHz Ant. 7

Channel	Frequency	26dB Bandwidth (MHz)	99% Occupied Bandwidth (MHz)
36	5180 MHz	22.43	16.79
40	5200 MHz	21.92	16.79
48	5240 MHz	22.69	16.79

Configuration Draft n MCS8 40MHz Ant. 7

Channel	Frequency	26dB Bandwidth (MHz)	99% Occupied Bandwidth (MHz)
38	5190 MHz	43.58	36.41
46	5230 MHz	43.58	36.41

26 dB Bandwidth Plot on Configuration Drafft n MCS8 20MHz Ant. 1 / 5180 MHz

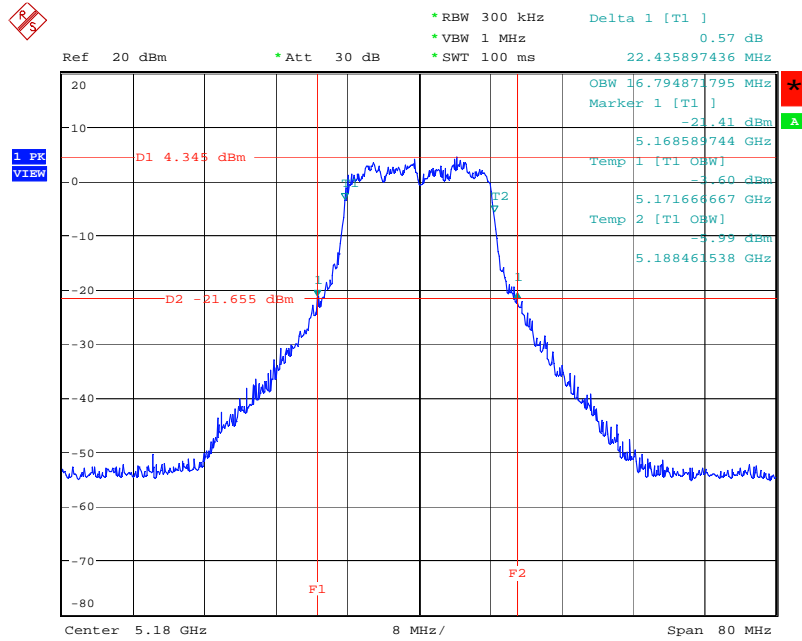

Date: 20.MAR.2008 20:04:30

26 dB Bandwidth Plot on Configuration Drafft n MCS8 20MHz Ant. 1 / 5200 MHz

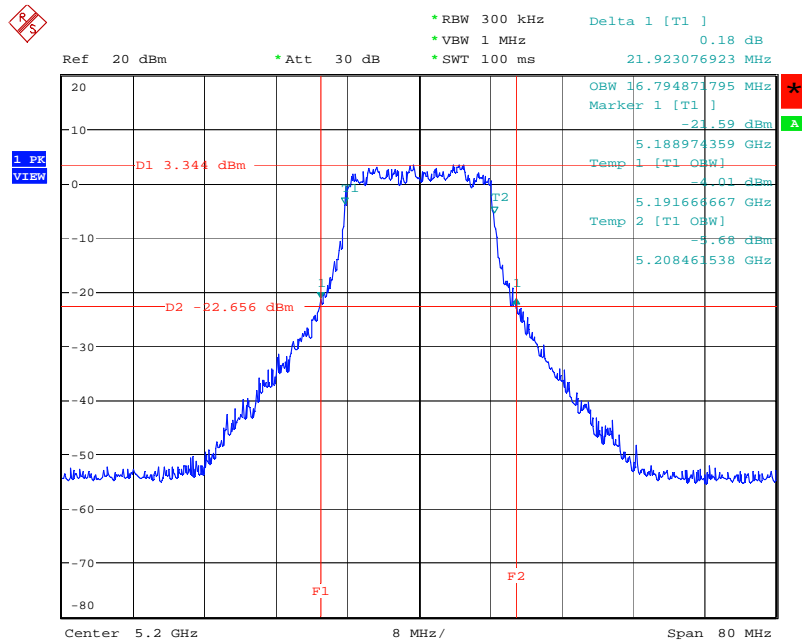

Date: 20.MAR.2008 20:05:52

26 dB Bandwidth Plot on Configuration Drafft n MCS8 20MHz Ant. 1 / 5240 MHz

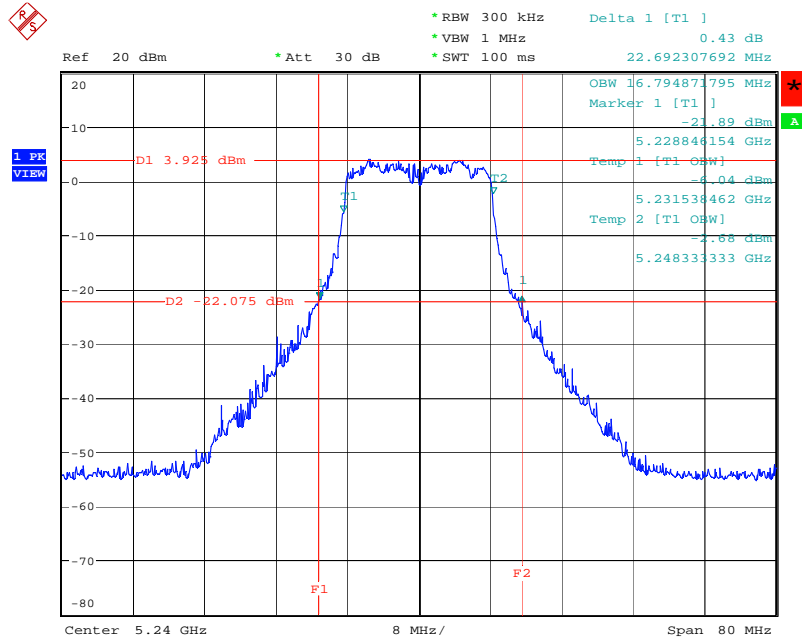

Date: 20.MAR.2008 20:07:31

26 dB Bandwidth Plot on Configuration Drafft n MCS8 40MHz Ant. 1 / 5190 MHz

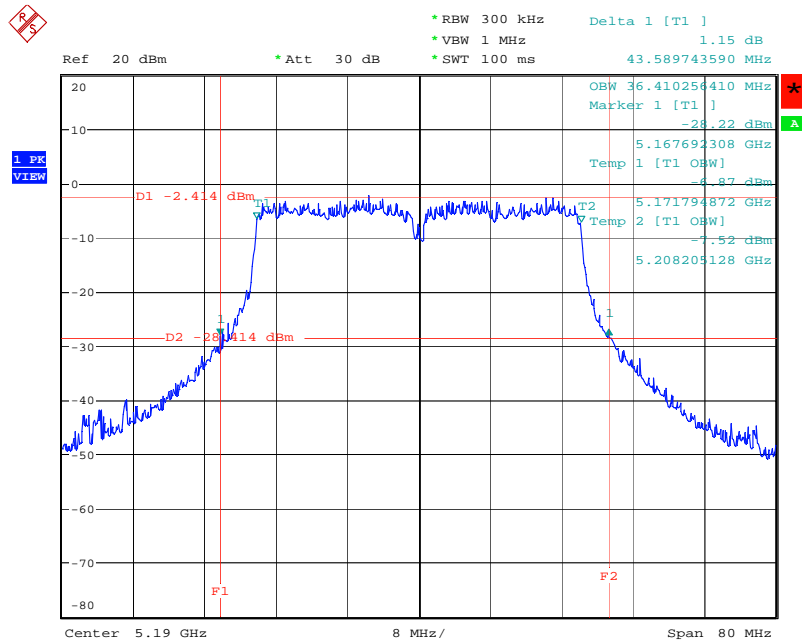

Date: 20.MAR.2008 19:36:26

26 dB Bandwidth Plot on Configuration Draft n MCS8 40MHz Ant. 1 / 5230 MHz

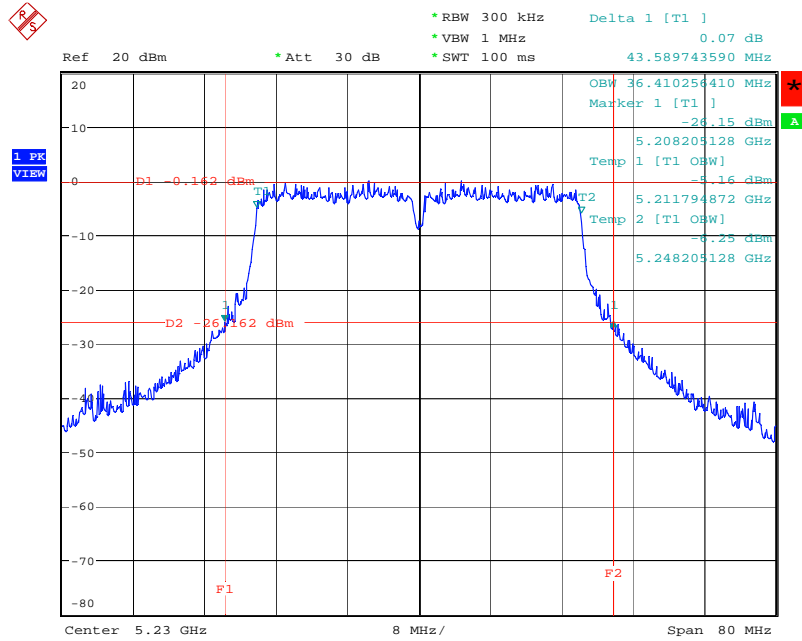

Date: 20.MAR.2008 19:31:49

26 dB Bandwidth Plot on Configuration Drafft n MCS8 20MHz Ant. 5 / 5180 MHz

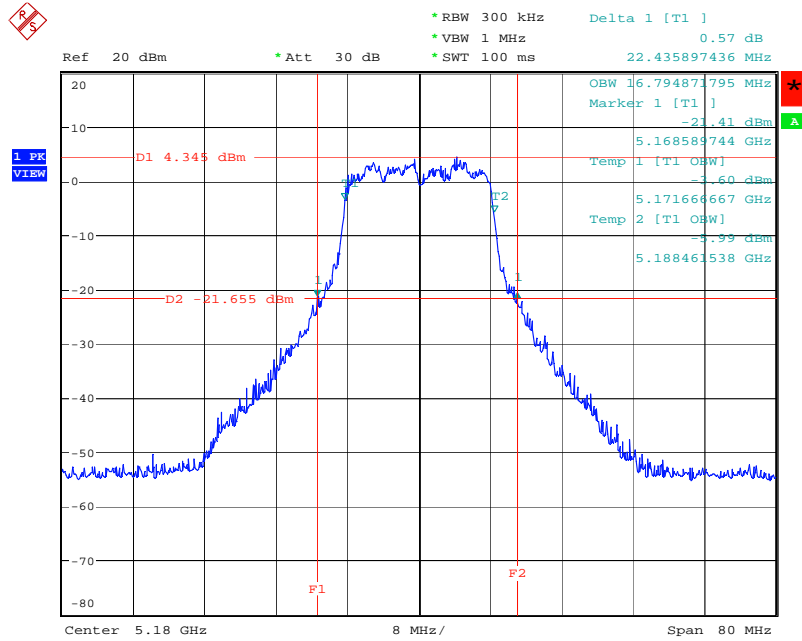

Date: 20.MAR.2008 20:04:30

26 dB Bandwidth Plot on Configuration Drafft n MCS8 20MHz Ant. 5 / 5200 MHz

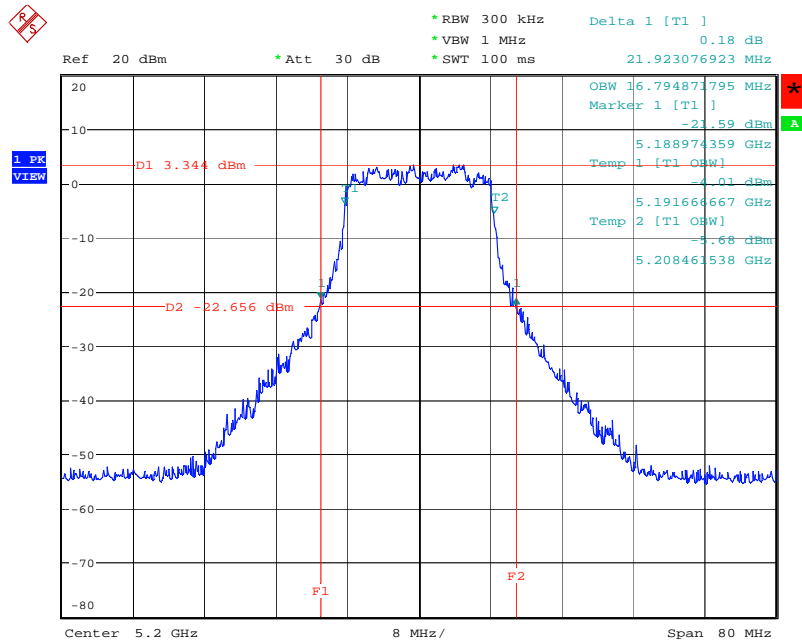

Date: 20.MAR.2008 20:05:52

26 dB Bandwidth Plot on Configuration Drafft n MCS8 20MHz Ant. 5 / 5240 MHz

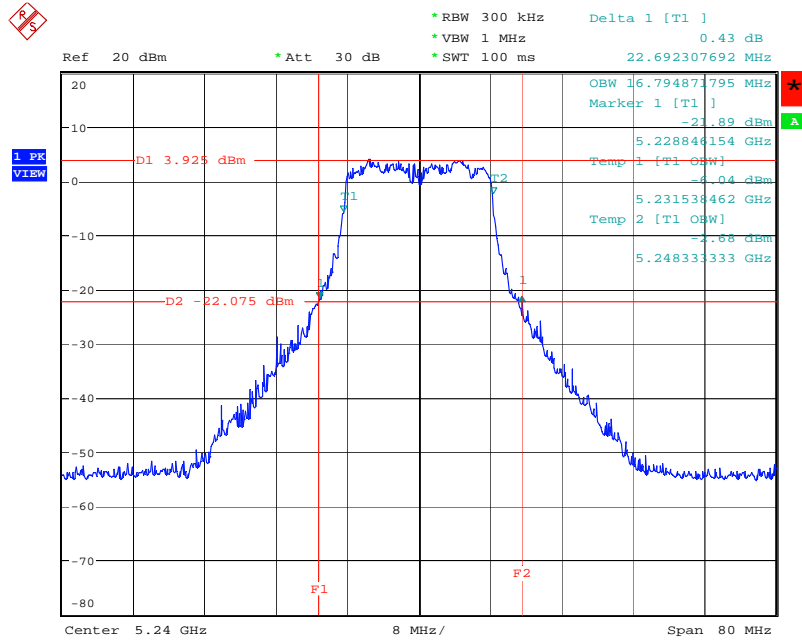

Date: 20.MAR.2008 20:07:31

26 dB Bandwidth Plot on Configuration Drafft n MCS8 40MHz Ant. 5 / 5190 MHz

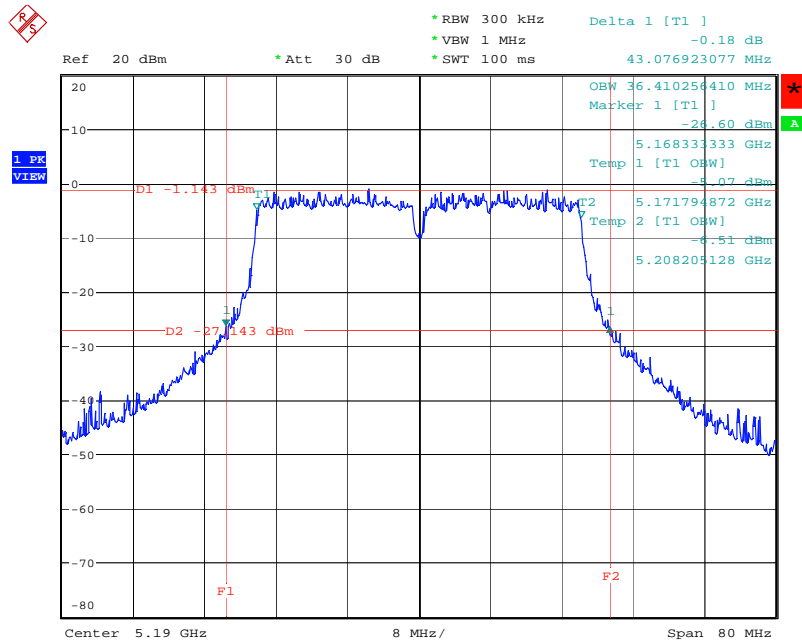

Date: 21.MAR.2008 16:52:47

26 dB Bandwidth Plot on Configuration Draft n MCS8 40MHz Ant. 5 / 5230 MHz

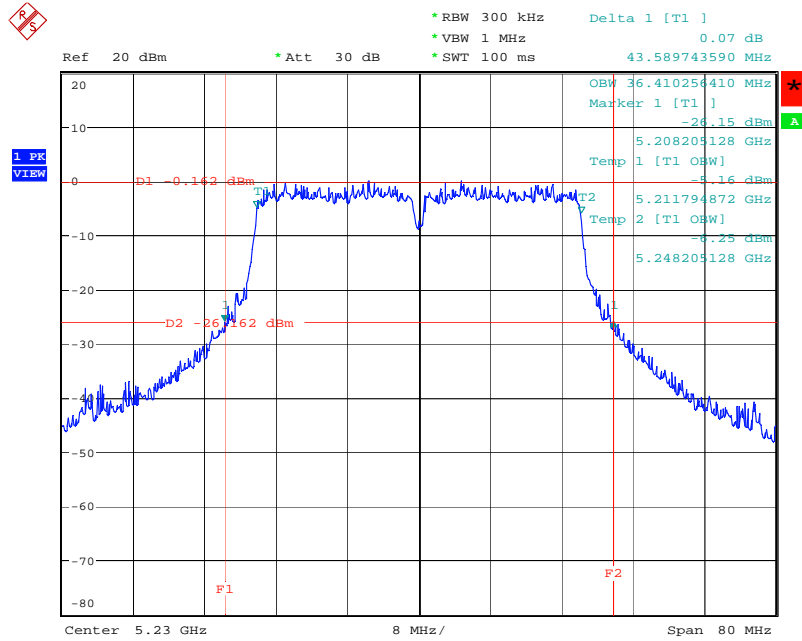

Date: 20.MAR.2008 19:31:49

26 dB Bandwidth Plot on Configuration Drafft n MCS8 20MHz Ant. 6 / 5180 MHz

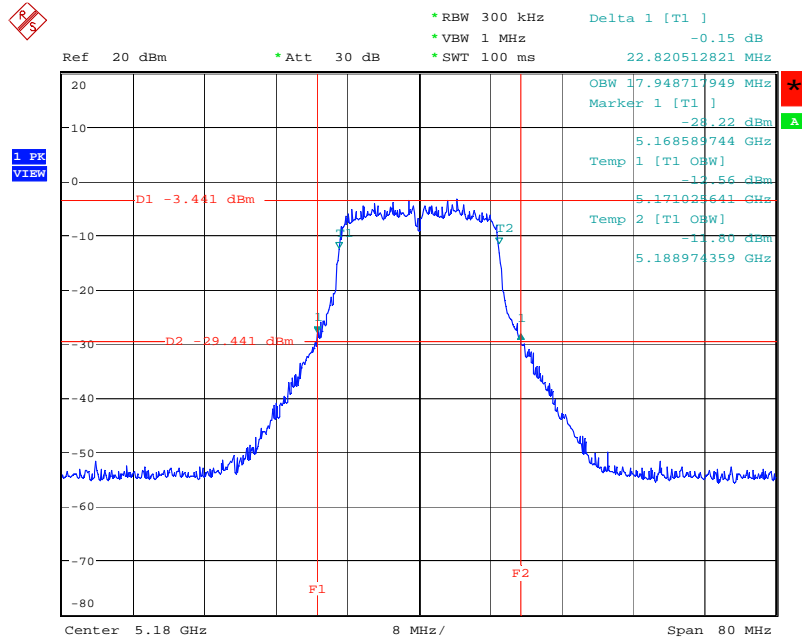

Date: 25.MAR.2008 14:43:08

26 dB Bandwidth Plot on Configuration Drafft n MCS8 20MHz Ant. 6 / 5200 MHz

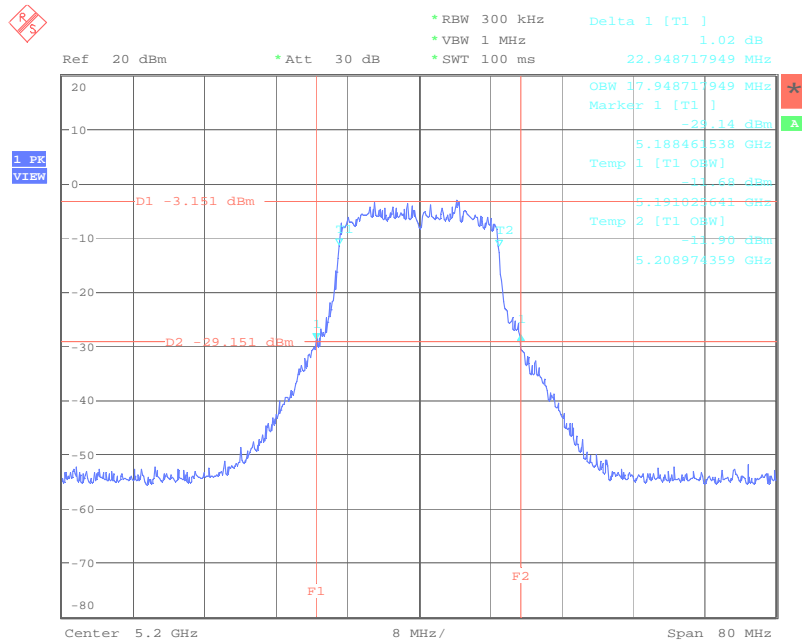

Date: 25.MAR.2008 14:42:27

26 dB Bandwidth Plot on Configuration Drafft n MCS8 20MHz Ant. 6 / 5240 MHz

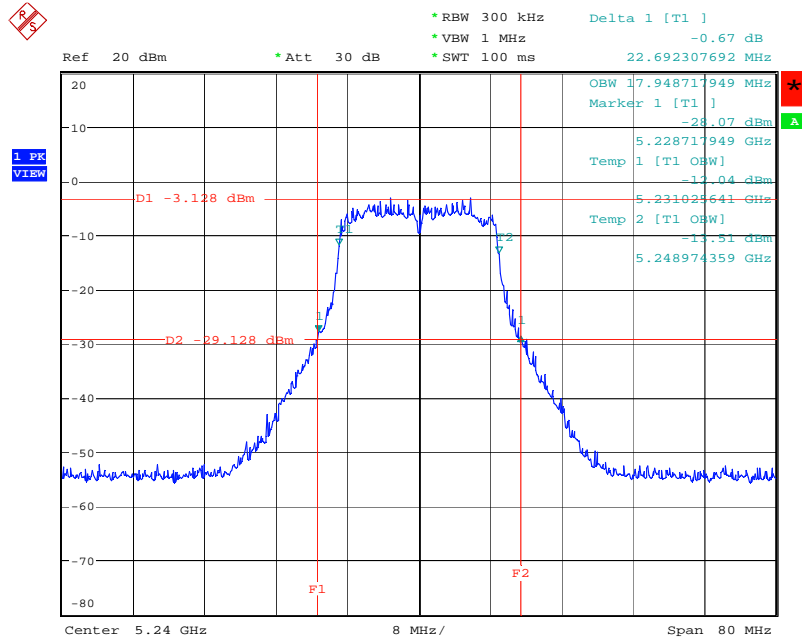

Date: 25.MAR.2008 14:41:39

26 dB Bandwidth Plot on Configuration Drafft n MCS8 40MHz Ant. 6 / 5190 MHz

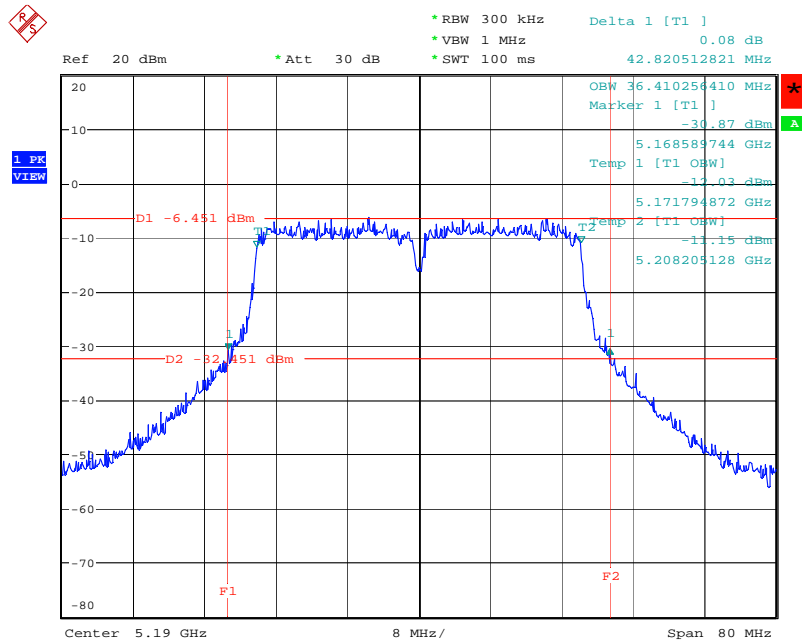

Date: 25.MAR.2008 14:44:06

26 dB Bandwidth Plot on Configuration Drafft n MCS8 40MHz Ant. 6 / 5230 MHz

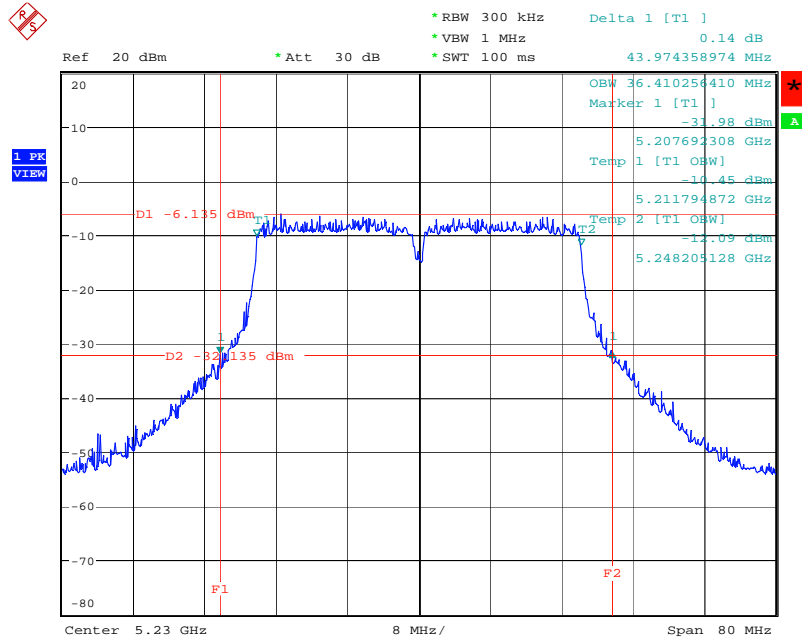

Date: 25.MAR.2008 14:44:52

26 dB Bandwidth Plot on Configuration Drafft n MCS8 20MHz Ant. 7 / 5180 MHz

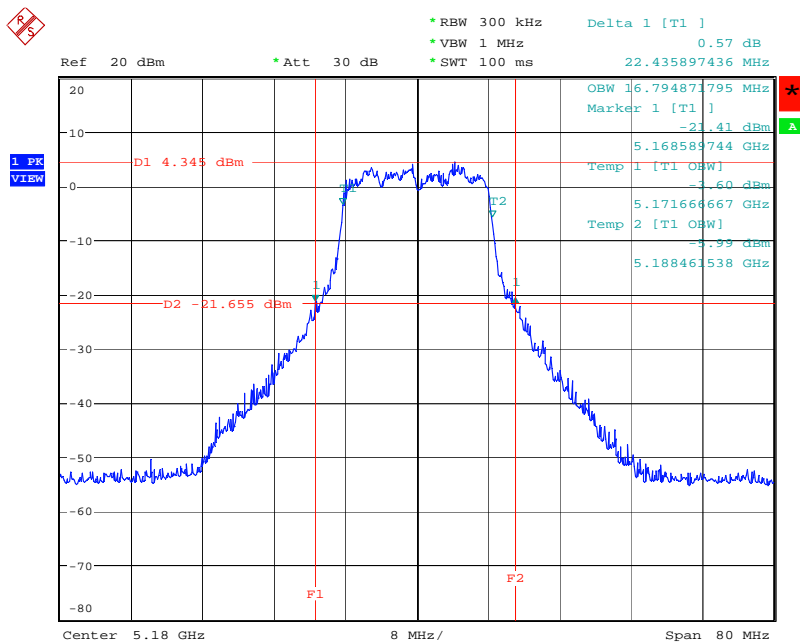

Date: 20.MAR.2008 20:04:30

26 dB Bandwidth Plot on Configuration Drafft n MCS8 20MHz Ant. 7 / 5200 MHz

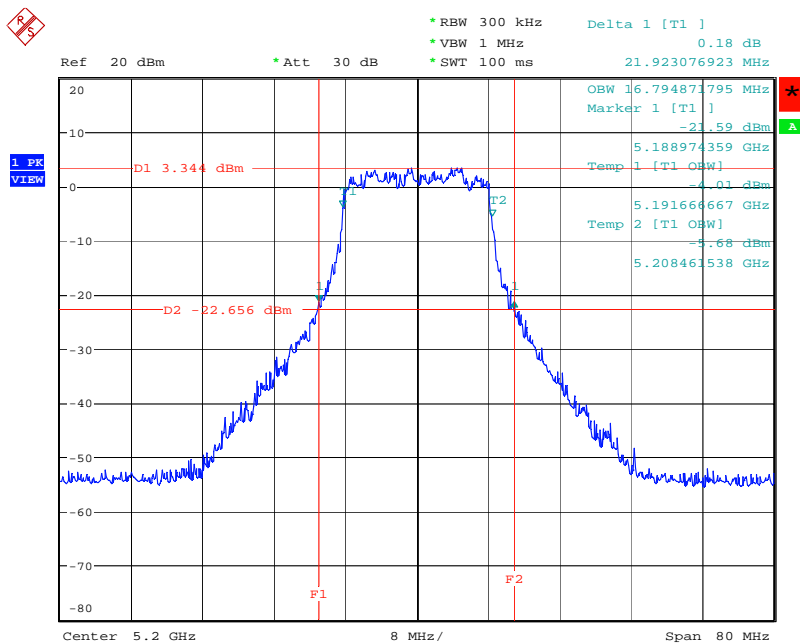

Date: 20.MAR.2008 20:05:52

26 dB Bandwidth Plot on Configuration Drafft n MCS8 20MHz Ant. 7 / 5240 MHz

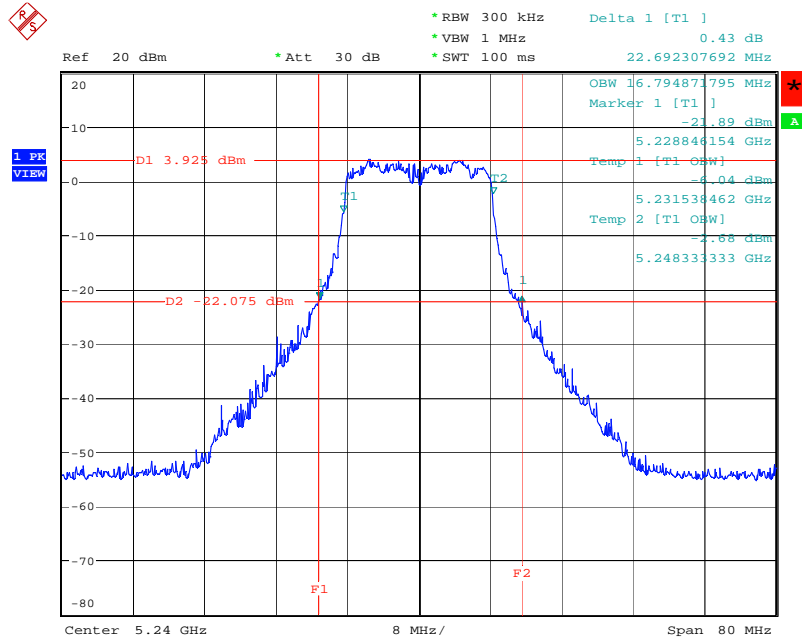

Date: 20.MAR.2008 20:07:31

26 dB Bandwidth Plot on Configuration Drafft n MCS8 40MHz Ant. 7 / 5190 MHz

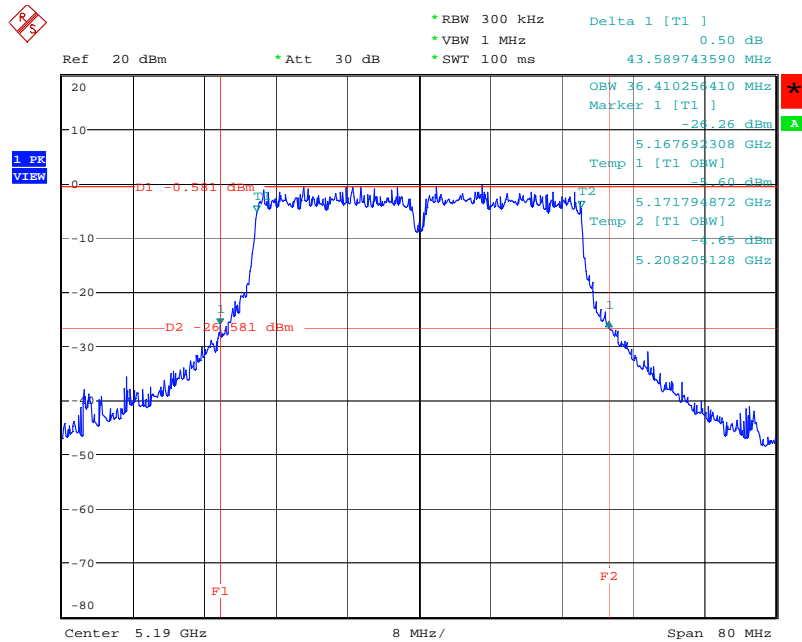

Date: 26.MAR.2008 17:45:36

26 dB Bandwidth Plot on Configuration Draft n MCS8 40MHz Ant. 7 / 5230 MHz

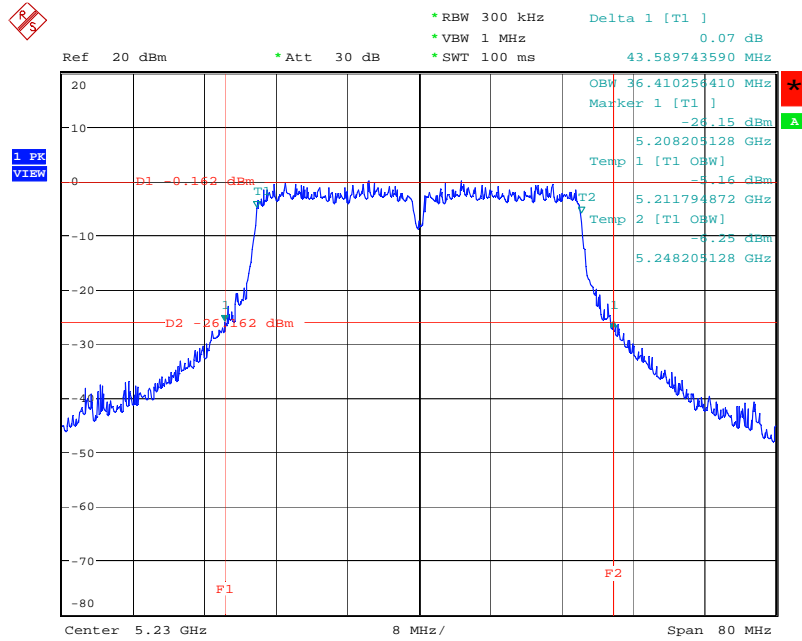

Date: 20.MAR.2008 19:31:49

4.3. Maximum Conducted Output Power Measurement

4.3.1. Limit

For the band 5.15~5.25 GHz, the maximum conducted output power over the frequency band of operation shall not exceed the lesser of 50 mW (17dBm) or $4 \text{ dBm} + 10 \log B$, where B is the 26 dB emissions bandwidth in MHz. If transmitting antennas of directional gain greater than 6 dBi are used, the peak output power and power density from the intentional radiator shall be reduced by the amount in dB that the directional gain of the antenna exceeds 6 dBi.

However, fixed point-to-point U-NII devices operating in this band may employ transmitting antennas with directional gain up to 23 dBi without any corresponding reduction in the transmitter peak output power and peak power spectral density. For fixed, point-to-point U-NII transmitters that employ a directional antenna gain greater than 23 dBi, a 1 dB reduction in peak transmitter power and peak power spectral density for each 1 dB of antenna gain in excess of 23 dBi would be required.

4.3.2. Measuring Instruments and Setting

Please refer to section 5 of equipments list in this report. The following table is the setting of the spectrum analyzer.

Spectrum Parameter	Setting
Attenuation	Auto
Span Frequency	Encompass the entire emissions bandwidth (EBW) of the signal
RB	1000 kHz
VB	3000 kHz
Detector	PEAK
Trace	MAX HOLD
Sweep Time	Auto

4.3.3. Test Procedures

1. The transmitter output (antenna port) was connected to the spectrum analyzer.
2. Test was performed in accordance with FCC Public Notice DA 02-2138, August 30, 2002.
3. When measuring maximum conducted output power with multiple antenna systems, add every result of the values by mathematic formula.

4.3.4. Test Setup Layout

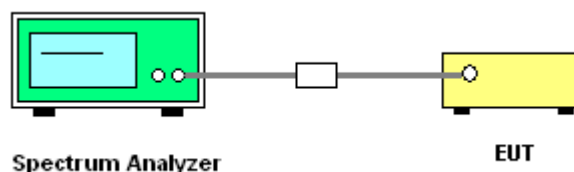

4.3.5. Test Deviation

There is no deviation with the original standard.

4.3.6. EUT Operation during Test

The EUT was programmed to be in continuously transmitting mode.

4.3.7. Test Result of Maximum Conducted Output Power

Temperature	22°C	Humidity	61%
Test Engineer	Sam Chen	Configurations	Draft n / Antenna 1

Configuration Draft n MCS0 20MHz Ant. 1-1

Channel	Frequency	Conducted Power (dBm)	Max. Limit (dBm)	Result
36	5180 MHz	12.95	17.00	Complies
40	5200 MHz	12.48	17.00	Complies
48	5240 MHz	11.70	17.00	Complies

Configuration Draft n MCS0 20MHz Ant. 1-2

Channel	Frequency	Conducted Power (dBm)	Max. Limit (dBm)	Result
36	5180 MHz	11.05	17.00	Complies
40	5200 MHz	11.16	17.00	Complies
48	5240 MHz	10.91	17.00	Complies

Configuration Draft n MCS0 20MHz Ant. 1-3

Channel	Frequency	Conducted Power (dBm)	Max. Limit (dBm)	Result
36	5180 MHz	11.22	17.00	Complies
40	5200 MHz	11.66	17.00	Complies
48	5240 MHz	12.56	17.00	Complies

Configuration Draft n MCS0 20MHz Ant. 1-1 +Ant. 1-2 + Ant. 1-3

Channel	Frequency	Conducted Power (dBm)	Max. Limit (dBm)	Result
36	5180 MHz	16.60	17.00	Complies
40	5200 MHz	16.57	17.00	Complies
48	5240 MHz	16.55	17.00	Complies

Configuration Draft n MCS0 40MHz Ant. 1-1

Channel	Frequency	Conducted Power (dBm)	Max. Limit (dBm)	Result
38	5190 MHz	9.07	17.00	Complies
46	5230 MHz	12.41	17.00	Complies

Configuration Draft n MCS0 40MHz Ant. 1-2

Channel	Frequency	Conducted Power (dBm)	Max. Limit (dBm)	Result
38	5190 MHz	7.61	17.00	Complies
46	5230 MHz	11.52	17.00	Complies

Configuration Draft n MCS0 40MHz Ant. 1-3

Channel	Frequency	Conducted Power (dBm)	Max. Limit (dBm)	Result
38	5190 MHz	7.44	17.00	Complies
46	5230 MHz	12.25	17.00	Complies

Configuration Draft n MCS0 40MHz Ant. 1-1 +Ant. 1-2 + Ant. 1-3

Channel	Frequency	Conducted Power (dBm)	Max. Limit (dBm)	Result
38	5190 MHz	13.57	17.00	Complies
46	5230 MHz	16.84	17.00	Complies

Temperature	22°C	Humidity	61%
Test Engineer	Sam Chen	Configurations	Draft n / Antenna 5

Configuration Draft n MCS0 20MHz Ant. 5-1

Channel	Frequency	Conducted Power (dBm)	Max. Limit (dBm)	Result
36	5180 MHz	12.95	17.00	Complies
40	5200 MHz	12.48	17.00	Complies
48	5240 MHz	11.70	17.00	Complies

Configuration Draft n MCS0 20MHz Ant. 5-2

Channel	Frequency	Conducted Power (dBm)	Max. Limit (dBm)	Result
36	5180 MHz	11.05	17.00	Complies
40	5200 MHz	11.16	17.00	Complies
48	5240 MHz	10.91	17.00	Complies

Configuration Draft n MCS0 20MHz Ant. 5-3

Channel	Frequency	Conducted Power (dBm)	Max. Limit (dBm)	Result
36	5180 MHz	11.22	17.00	Complies
40	5200 MHz	11.66	17.00	Complies
48	5240 MHz	12.56	17.00	Complies

Configuration Draft n MCS0 20MHz Ant. 5-1 + Ant. 5-2 + Ant. 5-3

Channel	Frequency	Conducted Power (dBm)	Max. Limit (dBm)	Result
36	5180 MHz	16.60	17.00	Complies
40	5200 MHz	16.57	17.00	Complies
48	5240 MHz	16.55	17.00	Complies

Configuration Draft n MCS0 40MHz Ant. 5-1

Channel	Frequency	Conducted Power (dBm)	Max. Limit (dBm)	Result
38	5190 MHz	11.89	17.00	Complies
46	5230 MHz	12.41	17.00	Complies

Configuration Draft n MCS0 40MHz Ant. 5-2

Channel	Frequency	Conducted Power (dBm)	Max. Limit (dBm)	Result
38	5190 MHz	10.14	17.00	Complies
46	5230 MHz	11.52	17.00	Complies

Configuration Draft n MCS0 40MHz Ant. 5-3

Channel	Frequency	Conducted Power (dBm)	Max. Limit (dBm)	Result
38	5190 MHz	10.87	17.00	Complies
46	5230 MHz	12.25	17.00	Complies

Configuration Draft n MCS0 40MHz Ant. 5-1 +Ant. 5-2 + Ant. 5-3

Channel	Frequency	Conducted Power (dBm)	Max. Limit (dBm)	Result
38	5190 MHz	15.80	17.00	Complies
46	5230 MHz	16.84	17.00	Complies

Temperature	22°C	Humidity	61%
Test Engineer	Sam Chen	Configurations	Draft n / Antenna 6

Configuration Draft n MCS0 20MHz Ant. 6-1

Channel	Frequency	Conducted Power (dBm)	Max. Limit (dBm)	Result
36	5180 MHz	6.21	10.00	Complies
40	5200 MHz	6.09	10.00	Complies
48	5240 MHz	5.39	10.00	Complies

Configuration Draft n MCS0 20MHz Ant. 6-2

Channel	Frequency	Conducted Power (dBm)	Max. Limit (dBm)	Result
36	5180 MHz	3.67	10.00	Complies
40	5200 MHz	3.53	10.00	Complies
48	5240 MHz	3.30	10.00	Complies

Configuration Draft n MCS0 20MHz Ant. 6-3

Channel	Frequency	Conducted Power (dBm)	Max. Limit (dBm)	Result
36	5180 MHz	5.27	10.00	Complies
40	5200 MHz	5.20	10.00	Complies
48	5240 MHz	5.69	10.00	Complies

Configuration Draft n MCS0 20MHz Ant. 6-1 + Ant. 6-2 + Ant. 6-3

Channel	Frequency	Conducted Power (dBm)	Max. Limit (dBm)	Result
36	5180 MHz	9.94	10.00	Complies
40	5200 MHz	9.84	10.00	Complies
48	5240 MHz	9.69	10.00	Complies

Configuration Draft n MCS0 40MHz Ant. 6-1

Channel	Frequency	Conducted Power (dBm)	Max. Limit (dBm)	Result
38	5190 MHz	5.98	10.00	Complies
46	5230 MHz	5.58	10.00	Complies

Configuration Draft n MCS0 40MHz Ant. 6-2

Channel	Frequency	Conducted Power (dBm)	Max. Limit (dBm)	Result
38	5190 MHz	3.47	10.00	Complies
46	5230 MHz	3.67	10.00	Complies

Configuration Draft n MCS0 40MHz Ant. 6-3

Channel	Frequency	Conducted Power (dBm)	Max. Limit (dBm)	Result
38	5190 MHz	4.59	10.00	Complies
46	5230 MHz	5.03	10.00	Complies

Configuration Draft n MCS0 40MHz Ant. 6-1 +Ant. 6-2 + Ant. 6-3

Channel	Frequency	Conducted Power (dBm)	Max. Limit (dBm)	Result
38	5190 MHz	9.57	10.00	Complies
46	5230 MHz	9.60	10.00	Complies

Temperature	22°C	Humidity	61%
Test Engineer	Sam Chen	Configurations	Draft n / Antenna 7

Configuration Draft n MCS0 20MHz Ant. 7-1

Channel	Frequency	Conducted Power (dBm)	Max. Limit (dBm)	Result
36	5180 MHz	12.95	17.00	Complies
40	5200 MHz	12.48	17.00	Complies
48	5240 MHz	11.70	17.00	Complies

Configuration Draft n MCS0 20MHz Ant. 7-2

Channel	Frequency	Conducted Power (dBm)	Max. Limit (dBm)	Result
36	5180 MHz	11.05	17.00	Complies
40	5200 MHz	11.16	17.00	Complies
48	5240 MHz	10.91	17.00	Complies

Configuration Draft n MCS0 20MHz Ant. 7-3

Channel	Frequency	Conducted Power (dBm)	Max. Limit (dBm)	Result
36	5180 MHz	11.22	17.00	Complies
40	5200 MHz	11.66	17.00	Complies
48	5240 MHz	12.56	17.00	Complies

Configuration Draft n MCS0 20MHz Ant. 7-1 + Ant. 7-2 + Ant. 7-3

Channel	Frequency	Conducted Power (dBm)	Max. Limit (dBm)	Result
36	5180 MHz	16.60	17.00	Complies
40	5200 MHz	16.57	17.00	Complies
48	5240 MHz	16.55	17.00	Complies

Configuration Draft n MCS0 40MHz Ant. 7-1

Channel	Frequency	Conducted Power (dBm)	Max. Limit (dBm)	Result
38	5190 MHz	12.50	17.00	Complies
46	5230 MHz	12.41	17.00	Complies

Configuration Draft n MCS0 40MHz Ant. 7-2

Channel	Frequency	Conducted Power (dBm)	Max. Limit (dBm)	Result
38	5190 MHz	10.86	17.00	Complies
46	5230 MHz	11.52	17.00	Complies

Configuration Draft n MCS0 40MHz Ant. 7-3

Channel	Frequency	Conducted Power (dBm)	Max. Limit (dBm)	Result
38	5190 MHz	11.47	17.00	Complies
46	5230 MHz	12.25	17.00	Complies

Configuration Draft n MCS0 40MHz Ant. 7-1 +Ant. 7-2 + Ant. 7-3

Channel	Frequency	Conducted Power (dBm)	Max. Limit (dBm)	Result
38	5190 MHz	16.43	17.00	Complies
46	5230 MHz	16.84	17.00	Complies

Conducted Output Power Plot on Configuration Draft n MCS0 20MHz Ant. 1-1 / 5180 MHz

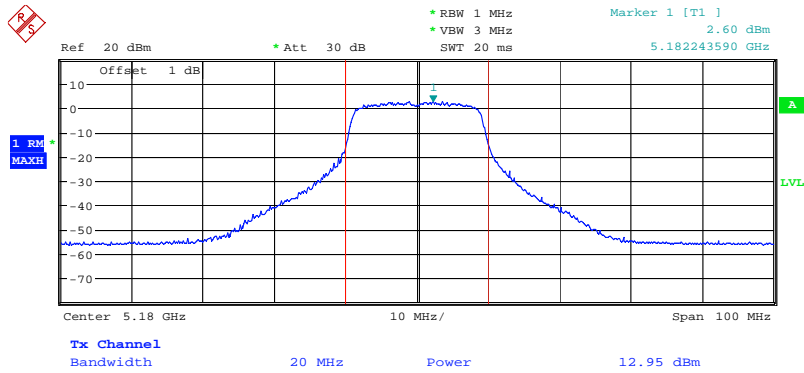

Date: 20.MAR.2008 19:21:59

Conducted Output Power Plot on Configuration Draft n MCS0 20MHz Ant. 1-2 / 5180 MHz

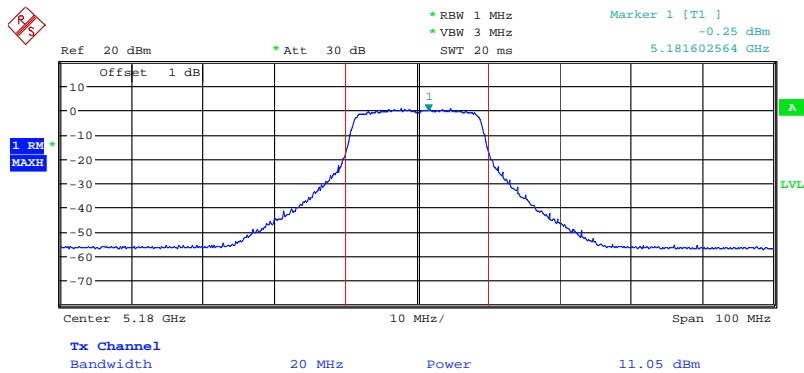

Date: 20.MAR.2008 19:22:34

Conducted Output Power Plot on Configuration Draft n MCS0 20MHz Ant. 1-3 / 5180 MHz

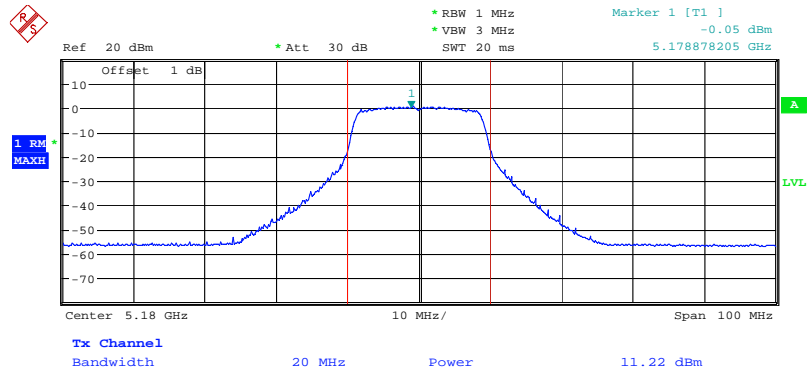

Date: 20.MAR.2008 19:23:17

Conducted Output Power Plot on Configuration Draft n MCS0 20MHz Ant. 1-1 / 5200 MHz

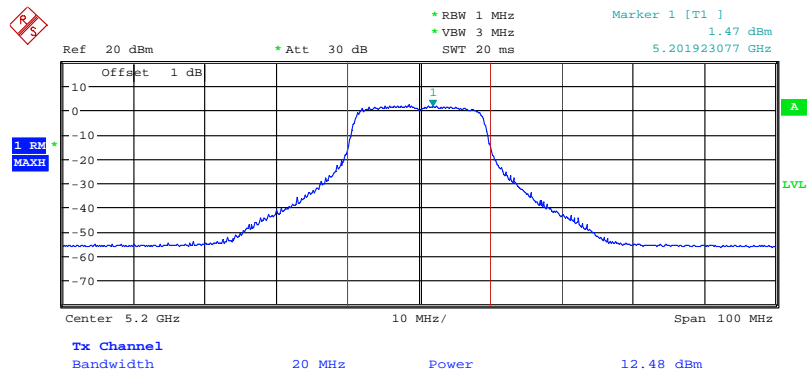

Date: 20.MAR.2008 19:15:53

Conducted Output Power Plot on Configuration Draft n MCS0 20MHz Ant. 1-2 / 5200 MHz

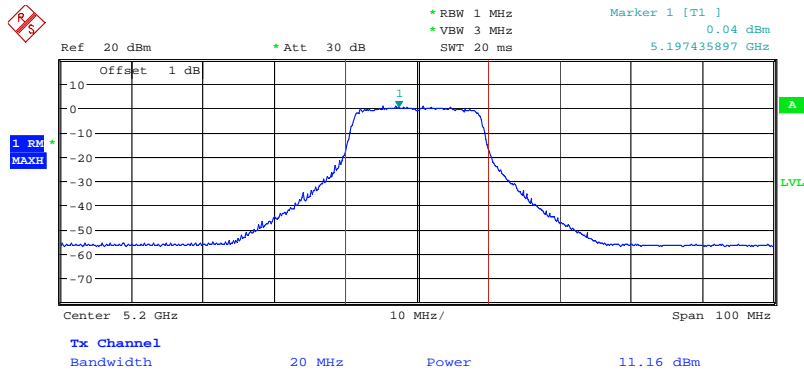

Date: 20.MAR.2008 19:15:12

Conducted Output Power Plot on Configuration Draft n MCS0 20MHz Ant. 1-3 / 5200 MHz

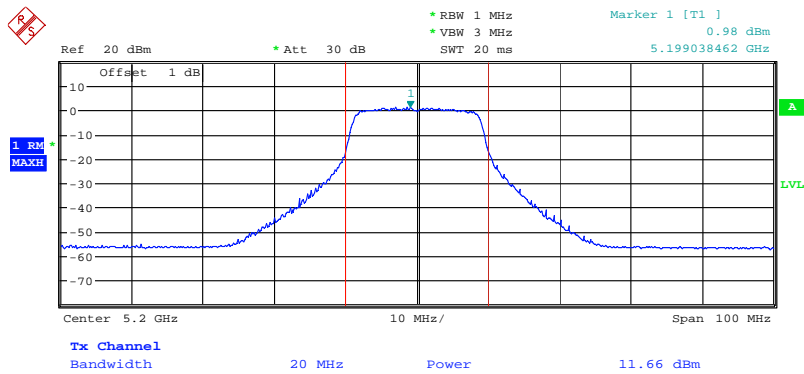

Date: 20.MAR.2008 19:14:07

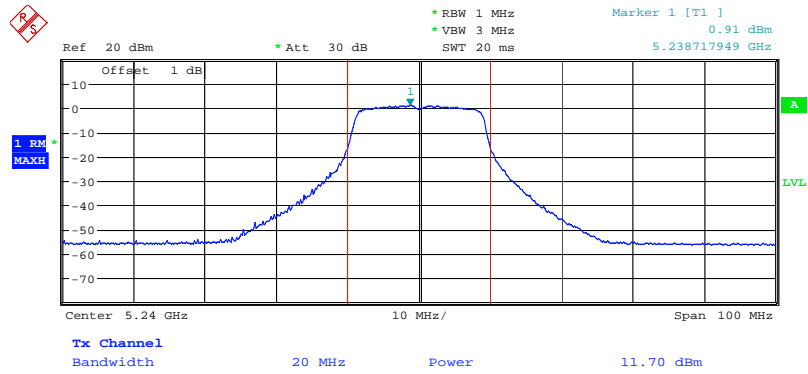
Conducted Output Power Plot on Configuration Draft n MCS0 20MHz Ant. 1-1 / 5240 MHz

Date: 20.MAR.2008 19:10:12

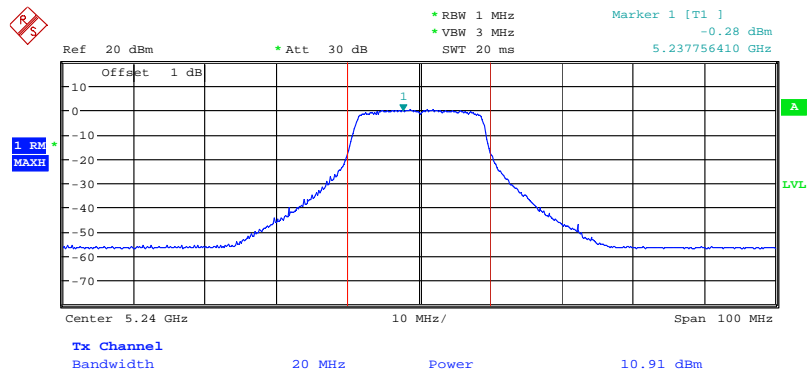
Conducted Output Power Plot on Configuration Draft n MCS0 20MHz Ant. 1-2 / 5240 MHz

Date: 20.MAR.2008 19:11:26

Conducted Output Power Plot on Configuration Draft n MCS0 40MHz Ant. 1-1 / 5190 MHz

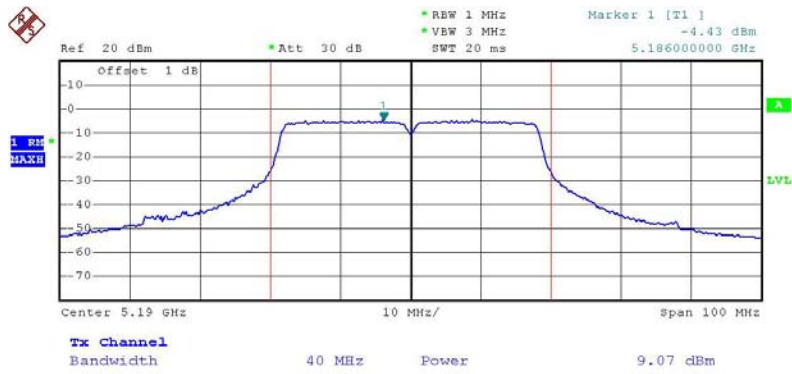

Date: 17.MAR.2008 18:08:40

Conducted Output Power Plot on Configuration Draft n MCS0 40MHz Ant. 1-2 / 5190 MHz

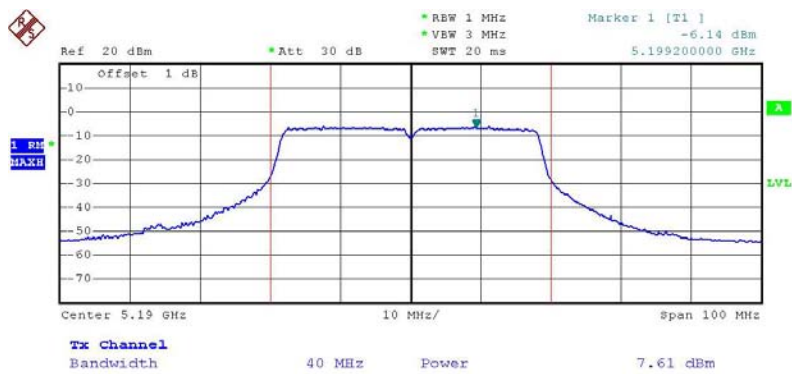

Date: 17.MAR.2008 18:07:49

Conducted Output Power Plot on Configuration Drafft n MCS0 40MHz Ant. 1-3 / 5190 MHz

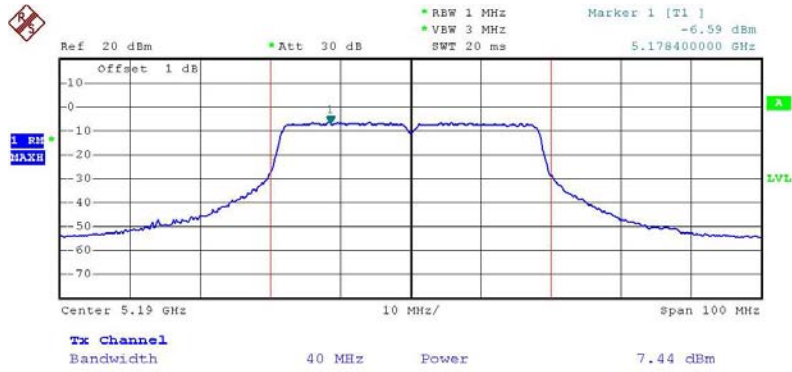

Date: 17.MAR.2008 18:06:56

Conducted Output Power Plot on Configuration Drafft n MCS0 40MHz Ant. 1-1 / 5230 MHz

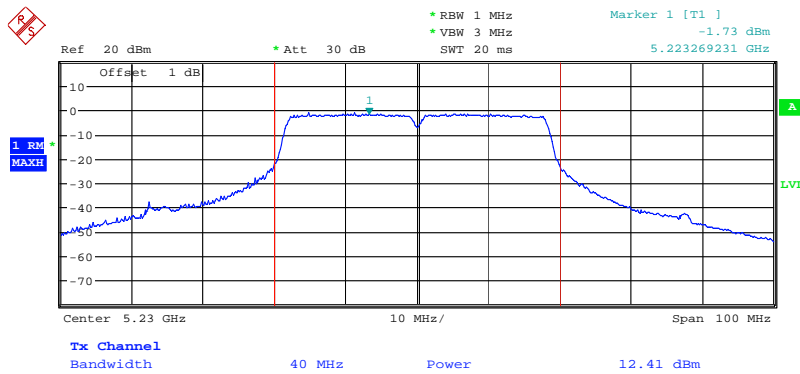

Date: 20.MAR.2008 19:27:55

Conducted Output Power Plot on Configuration Drafft n MCS0 40MHz Ant. 1-2 / 5230 MHz

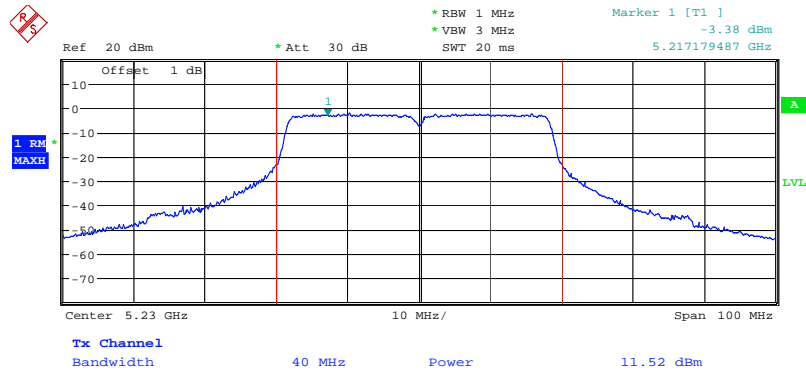

Date: 20.MAR.2008 19:26:38

Conducted Output Power Plot on Configuration Drafft n MCS0 40MHz Ant. 1-3 / 5230 MHz

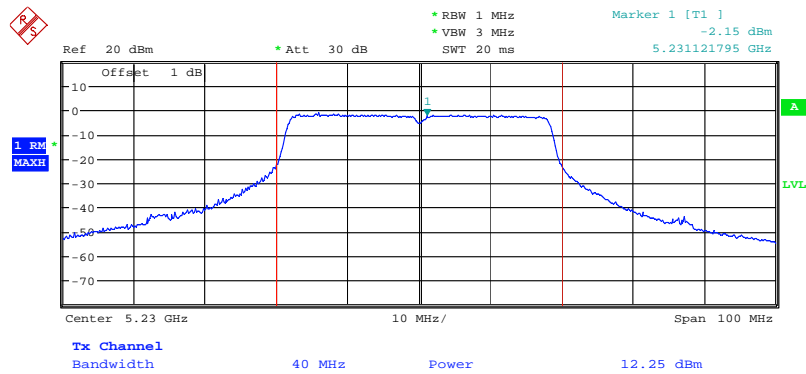

Date: 20.MAR.2008 19:25:31

Conducted Output Power Plot on Configuration Draft n MCS0 20MHz Ant. 5-2 / 5200 MHz

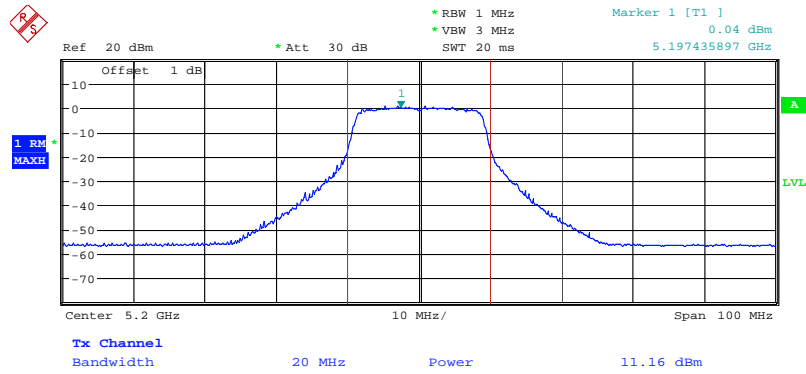

Date: 20.MAR.2008 19:15:12

Conducted Output Power Plot on Configuration Draft n MCS0 20MHz Ant. 5-3 / 5200 MHz

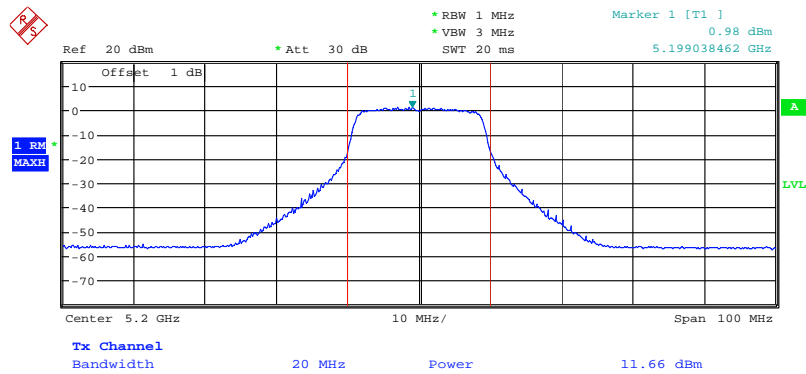

Date: 20.MAR.2008 19:14:07

Conducted Output Power Plot on Configuration Draft n MCS0 20MHz Ant. 5-1 / 5240 MHz

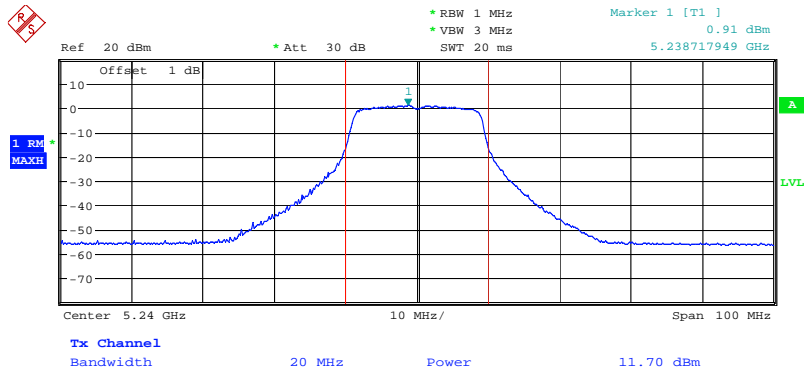

Date: 20.MAR.2008 19:10:12

Conducted Output Power Plot on Configuration Draft n MCS0 20MHz Ant. 5-2 / 5240 MHz

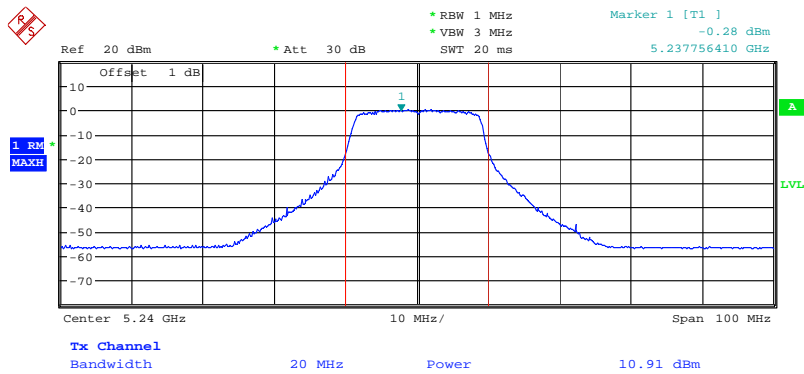

Date: 20.MAR.2008 19:11:26

Conducted Output Power Plot on Configuration Draft n MCS0 20MHz Ant. 5-3 / 5240 MHz

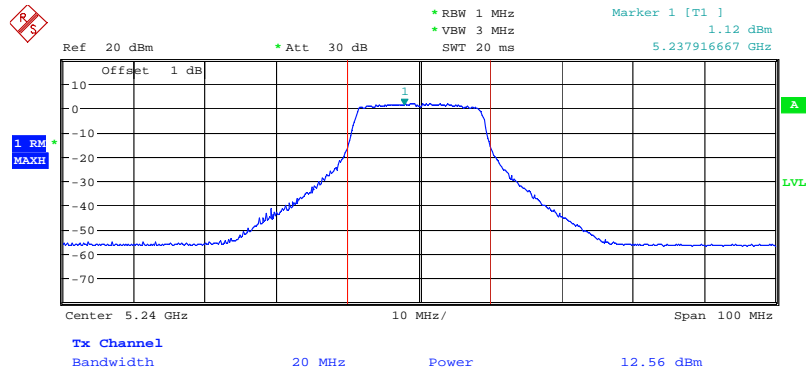

Date: 20.MAR.2008 19:13:07

Conducted Output Power Plot on Configuration Draft n MCS0 40MHz Ant. 5-1 / 5190 MHz

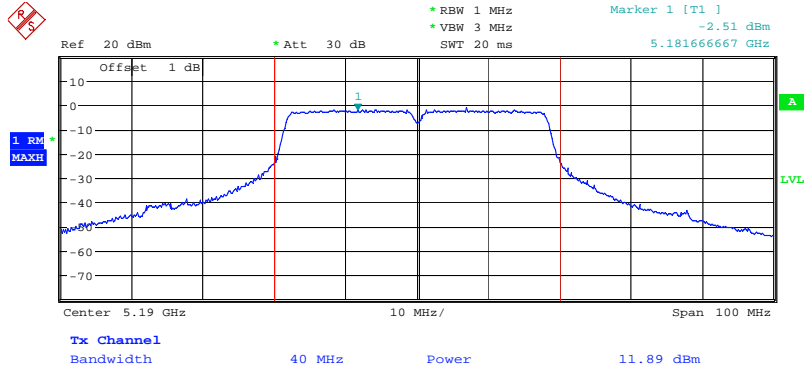

Date: 21.MAR.2008 14:23:49

Conducted Output Power Plot on Configuration Draft n MCS0 40MHz Ant. 5-2 / 5190 MHz

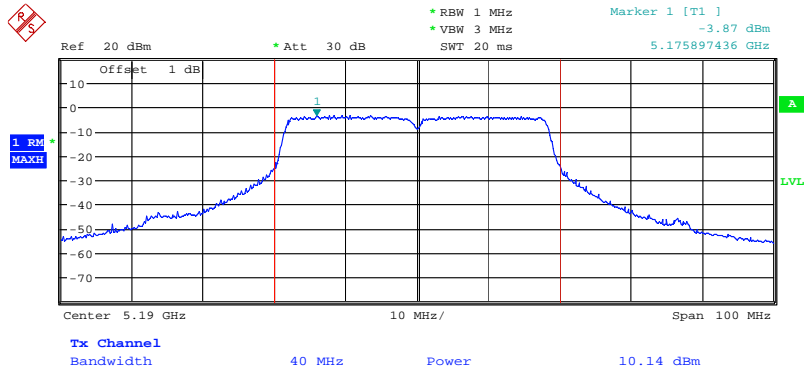

Date: 21.MAR.2008 14:22:08

Conducted Output Power Plot on Configuration Draft n MCS0 40MHz Ant. 5-3 / 5190 MHz

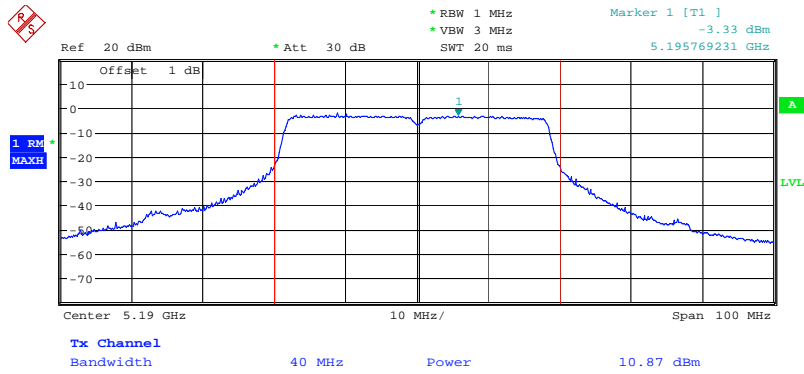

Date: 21.MAR.2008 14:20:05

Conducted Output Power Plot on Configuration Draft n MCS0 40MHz Ant. 5-1 / 5230 MHz

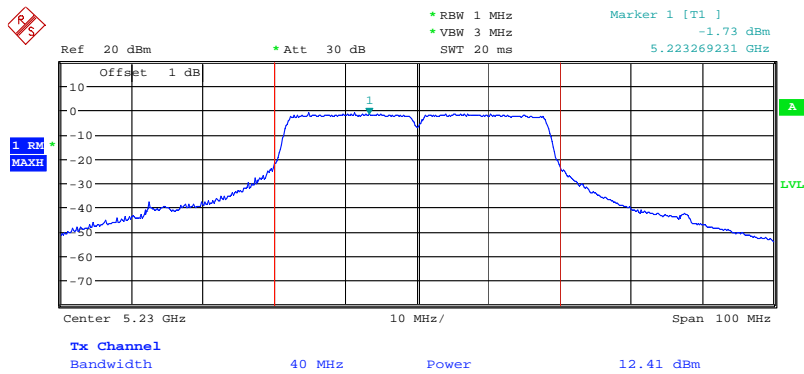

Date: 20.MAR.2008 19:27:55

Conducted Output Power Plot on Configuration Drafft n MCS0 40MHz Ant. 5-2 / 5230 MHz

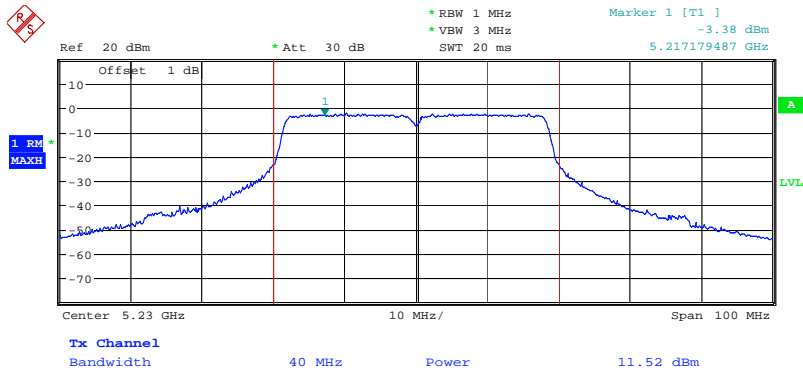

Date: 20.MAR.2008 19:26:38

Conducted Output Power Plot on Configuration Drafft n MCS0 40MHz Ant. 5-3 / 5230 MHz

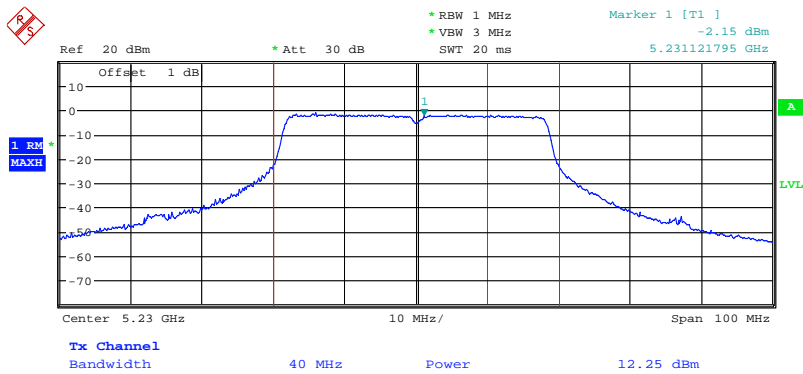

Date: 20.MAR.2008 19:25:31

Conducted Output Power Plot on Configuration Drafft n MCS0 20MHz Ant. 6-1 / 5180 MHz

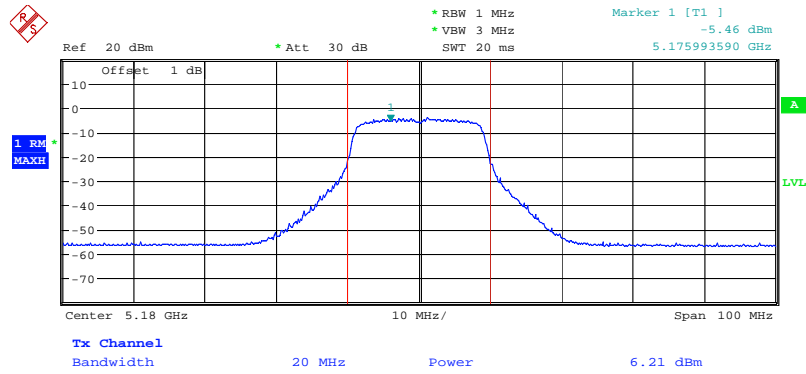

Date: 25.MAR.2008 10:08:30

Conducted Output Power Plot on Configuration Drafft n MCS0 20MHz Ant. 6-2 / 5180 MHz

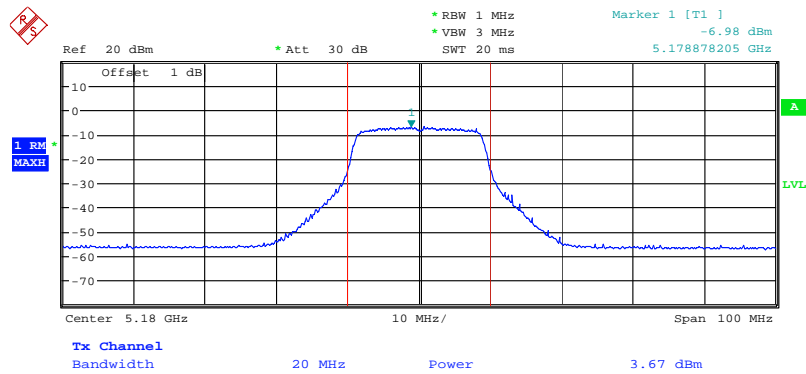

Date: 25.MAR.2008 10:09:07

Conducted Output Power Plot on Configuration Drafft n MCS0 20MHz Ant. 6-3 / 5180 MHz

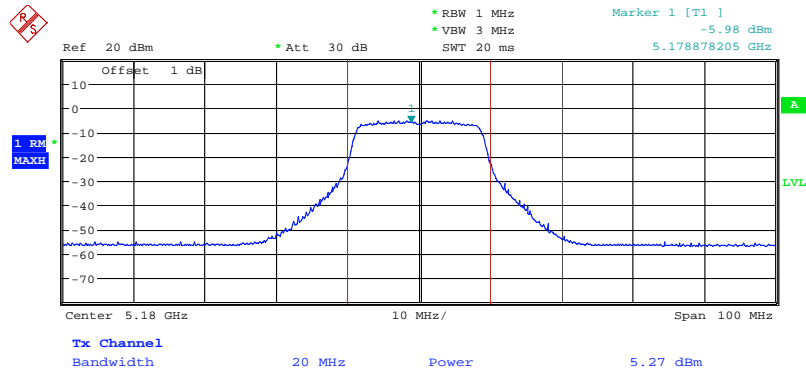

Date: 25.MAR.2008 10:07:28

Conducted Output Power Plot on Configuration Drafft n MCS0 20MHz Ant. 6-1 / 5200 MHz

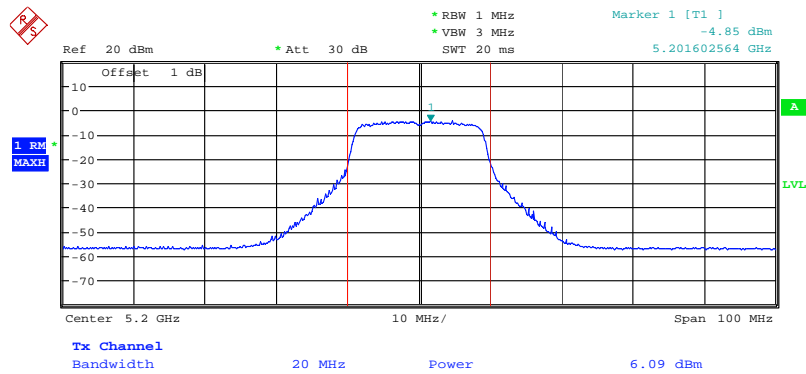

Date: 25.MAR.2008 10:11:09

Conducted Output Power Plot on Configuration Drafft n MCS0 20MHz Ant. 6-2 / 5200 MHz

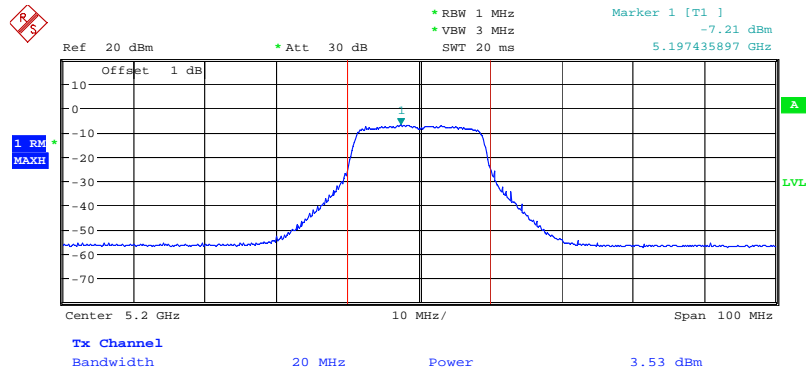

Date: 25.MAR.2008 10:10:42

Conducted Output Power Plot on Configuration Drafft n MCS0 20MHz Ant. 6-3 / 5200 MHz

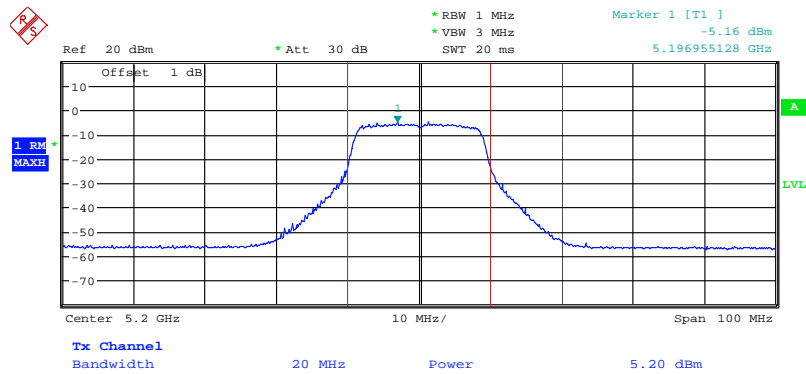

Date: 25.MAR.2008 10:11:46

Conducted Output Power Plot on Configuration Draft n MCS0 20MHz Ant. 6-1 / 5240 MHz

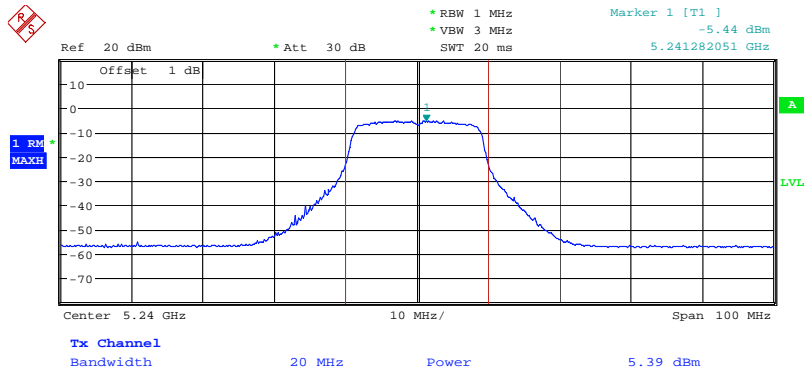

Date: 25.MAR.2008 10:13:19

Conducted Output Power Plot on Configuration Draft n MCS0 20MHz Ant. 6-2 / 5240 MHz

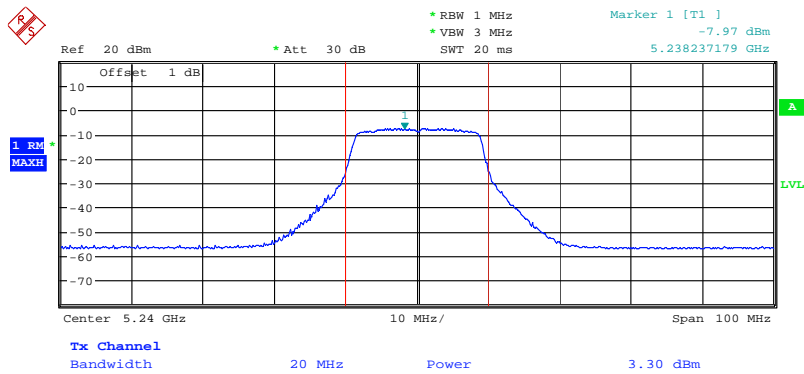

Date: 25.MAR.2008 10:14:04

Conducted Output Power Plot on Configuration Draft n MCS0 20MHz Ant. 6-3 / 5240 MHz

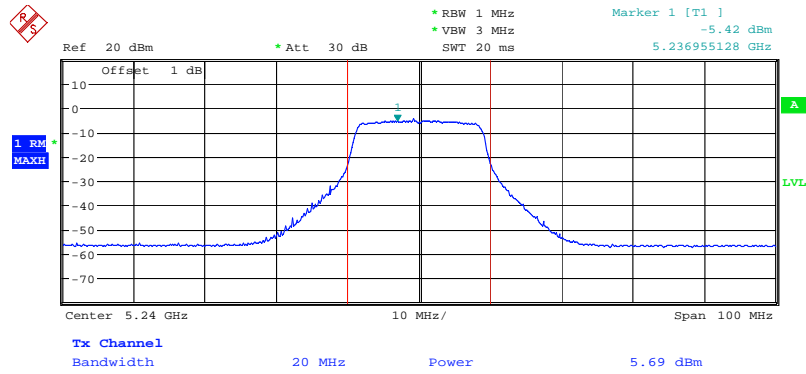

Date: 25.MAR.2008 10:14:36

Conducted Output Power Plot on Configuration Draft n MCS0 40MHz Ant. 6-1 / 5190 MHz

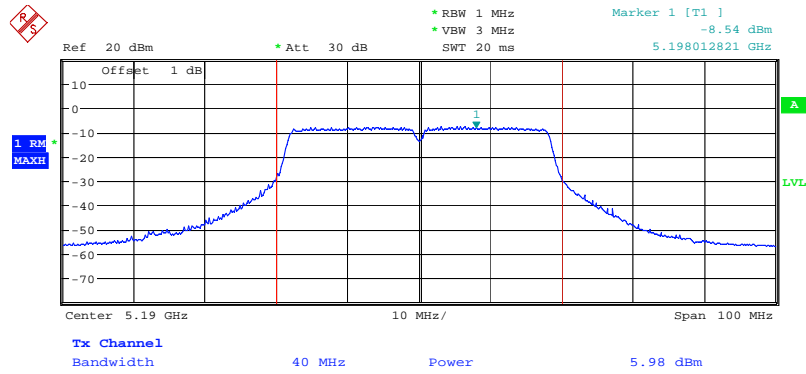

Date: 25.MAR.2008 13:14:34

Conducted Output Power Plot on Configuration Draft n MCS0 40MHz Ant. 6-2 / 5190 MHz

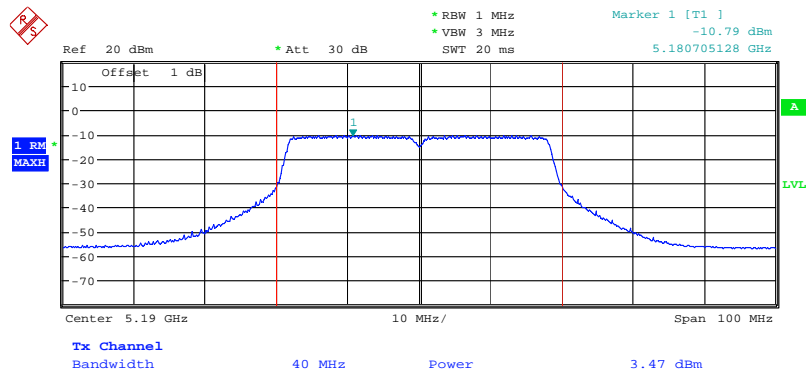

Date: 25.MAR.2008 13:13:39

Conducted Output Power Plot on Configuration Draft n MCS0 40MHz Ant. 6-3 / 5190 MHz

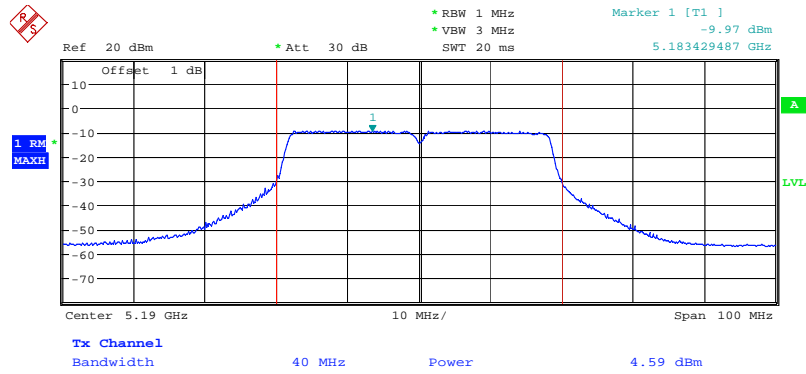

Date: 25.MAR.2008 13:12:40

Conducted Output Power Plot on Configuration Draft n MCS0 40MHz Ant. 6-1 / 5230 MHz

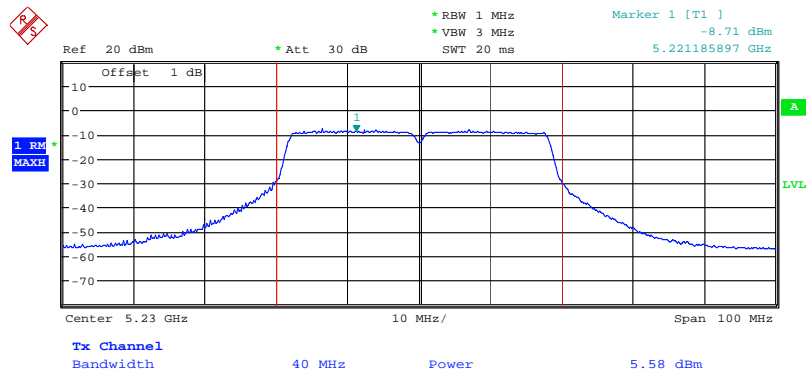

Date: 25.MAR.2008 13:15:58

Conducted Output Power Plot on Configuration Draft n MCS0 40MHz Ant. 6-2 / 5230 MHz

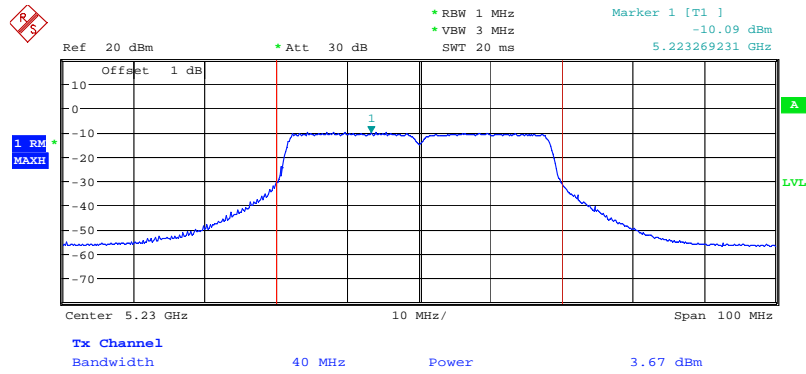

Date: 25.MAR.2008 13:17:10

Conducted Output Power Plot on Configuration Draft n MCS0 40MHz Ant. 6-3 / 5230 MHz

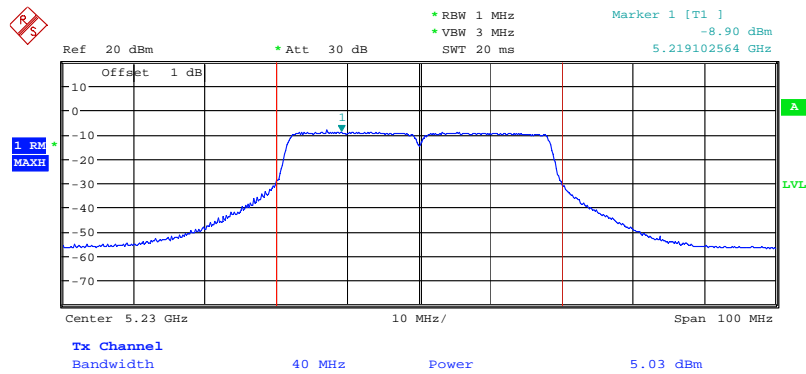

Date: 25.MAR.2008 13:17:50

Conducted Output Power Plot on Configuration Draft n MCS0 20MHz Ant. 7-1 / 5180 MHz

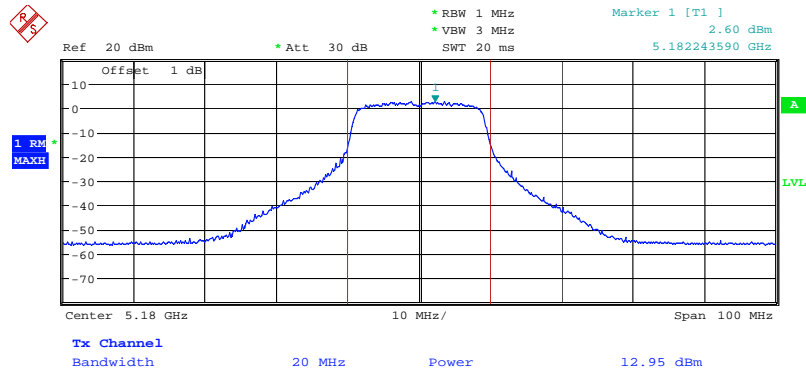

Date: 20.MAR.2008 19:21:59

Conducted Output Power Plot on Configuration Draft n MCS0 20MHz Ant. 7-2 / 5180 MHz

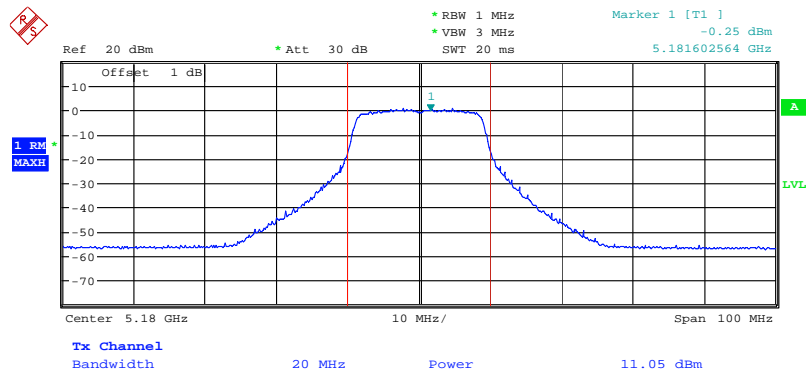

Date: 20.MAR.2008 19:22:34

Conducted Output Power Plot on Configuration Draft n MCS0 20MHz Ant. 7-3 / 5180 MHz

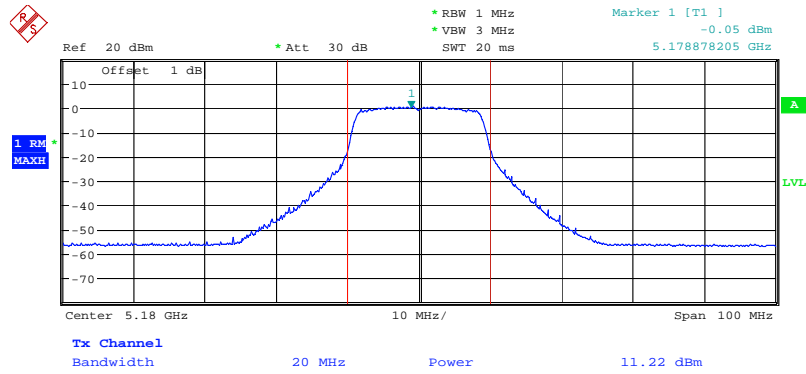

Date: 20.MAR.2008 19:23:17

Conducted Output Power Plot on Configuration Draft n MCS0 20MHz Ant. 7-1 / 5200 MHz

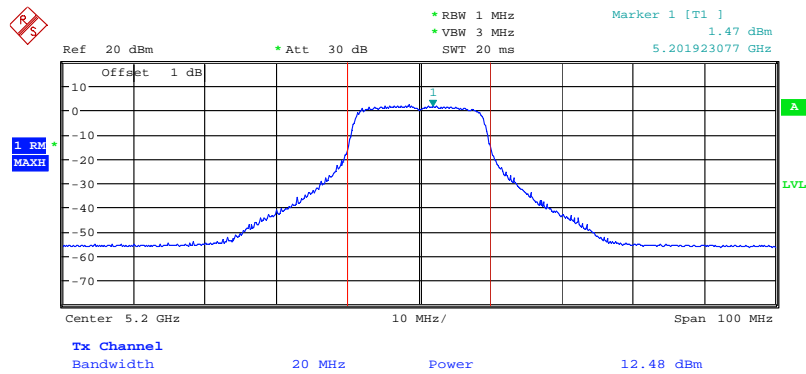

Date: 20.MAR.2008 19:15:53

Conducted Output Power Plot on Configuration Draft n MCS0 20MHz Ant. 7-2 / 5200 MHz

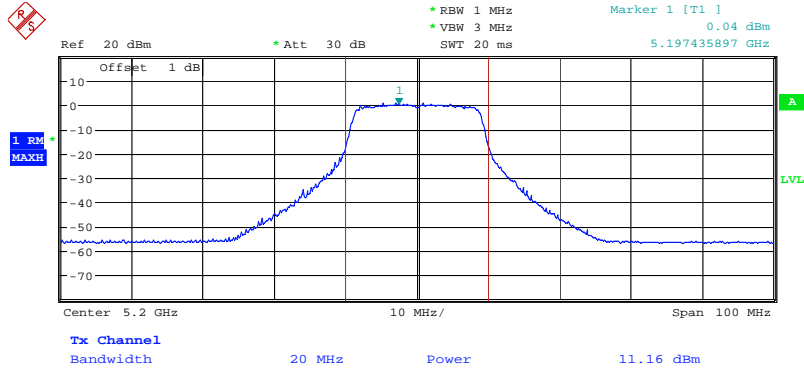

Date: 20.MAR.2008 19:15:12

Conducted Output Power Plot on Configuration Draft n MCS0 20MHz Ant. 7-3 / 5200 MHz

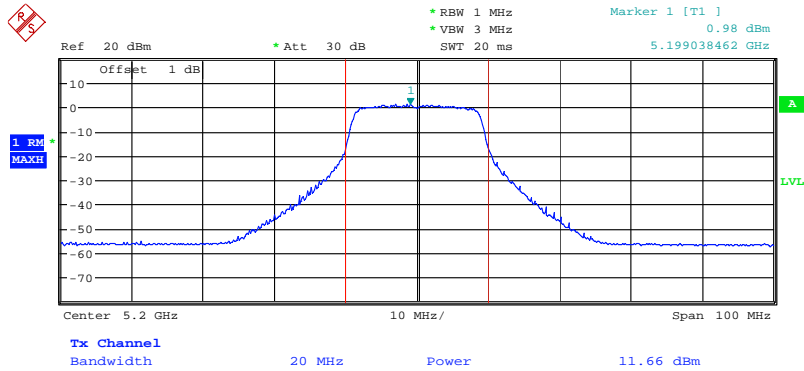

Date: 20.MAR.2008 19:14:07

Conducted Output Power Plot on Configuration Draft n MCS0 20MHz Ant. 7-1 / 5240 MHz

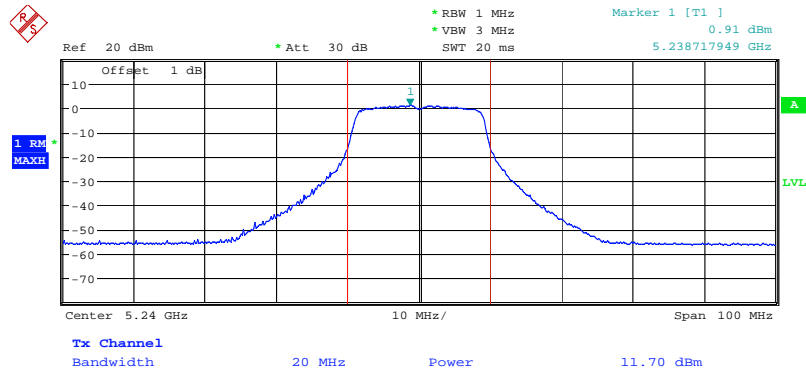

Date: 20.MAR.2008 19:10:12

Conducted Output Power Plot on Configuration Draft n MCS0 20MHz Ant. 7-2 / 5240 MHz

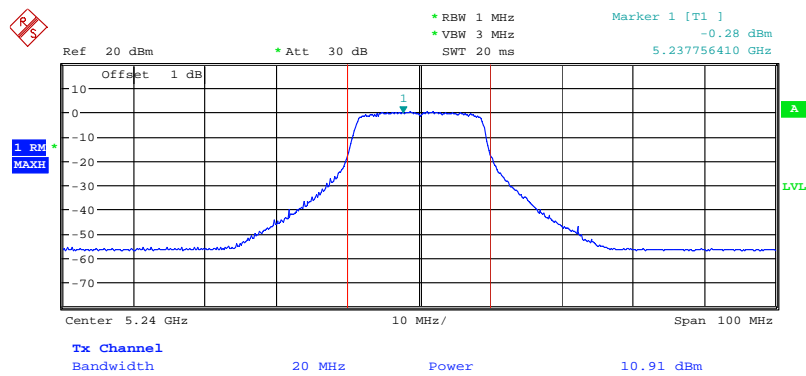

Date: 20.MAR.2008 19:11:26

Conducted Output Power Plot on Configuration Draft n MCS0 20MHz Ant. 7-3 / 5240 MHz

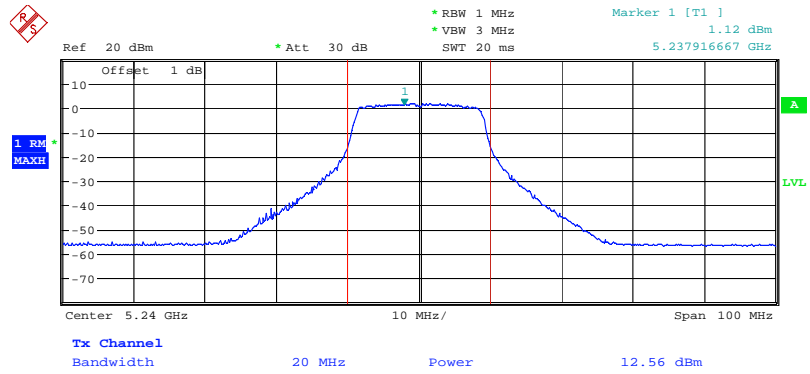

Date: 20.MAR.2008 19:13:07

Conducted Output Power Plot on Configuration Draft n MCS0 40MHz Ant. 7-3 / 5190 MHz

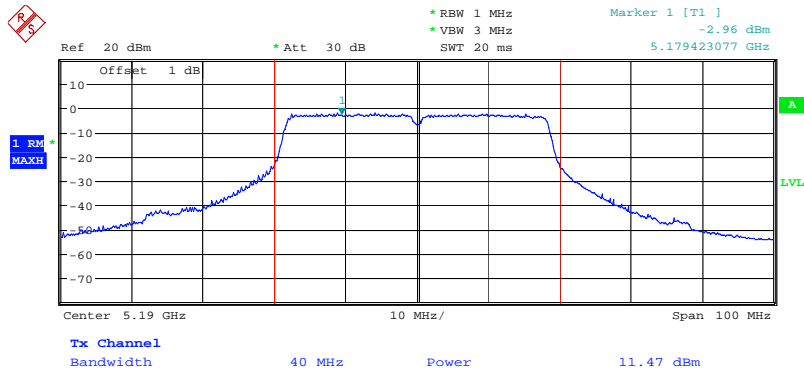

Date: 26.MAR.2008 16:58:27

Conducted Output Power Plot on Configuration Draft n MCS0 40MHz Ant. 7-1 / 5230 MHz

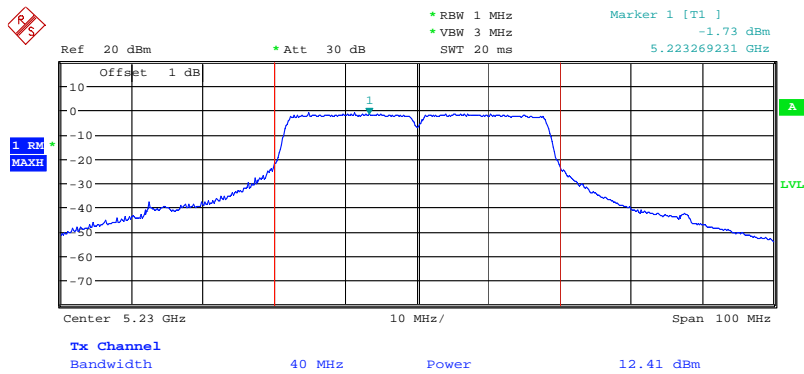

Date: 20.MAR.2008 19:27:55

Conducted Output Power Plot on Configuration Draft n MCS0 40MHz Ant. 7-2 / 5230 MHz

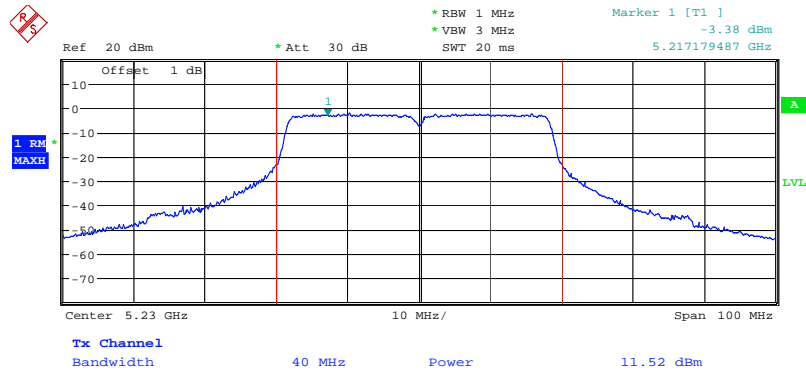

Date: 20.MAR.2008 19:26:38

Conducted Output Power Plot on Configuration Draft n MCS0 40MHz Ant. 7-3 / 5230 MHz

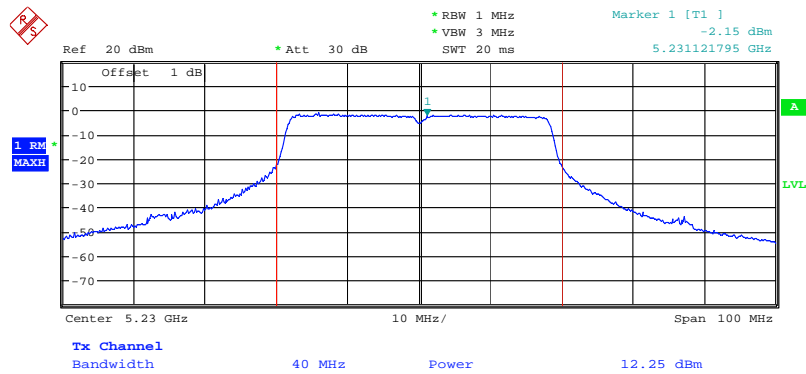

Date: 20.MAR.2008 19:25:31

4.4. Power Spectral Density Measurement

4.4.1. Limit

The power spectral density is defined as the highest level of power in dBm per MHz generated by the transmitter within the power envelope. The following table is power spectral density limits and decrease power density limit rule refer to section 4.3.1.

Frequency Range	Power Spectral Density limit (dBm/MHz)
5.15~5.25 GHz	4

4.4.2. Measuring Instruments and Setting

Please refer to section 5 of equipments list in this report. The following table is the setting of the spectrum analyzer.

Spectrum Parameter	Setting
Attenuation	Auto
Span Frequency	Encompass the entire emissions bandwidth (EBW) of the signal
RB	1000 kHz
VB	3000 kHz
Detector	Peak
Trace	Max Hold
Sweep Time	Auto

4.4.3. Test Procedures

1. The transmitter output (antenna port) was connected to the spectrum analyzer.
2. Set RBW of spectrum analyzer to 1000kHz and VBW to 3000kHz. Set Detector to Peak, Trace to Max Hold. Mark the frequency with maximum peak power as the center of the display of the spectrum.
3. Measuring multiple antennas, the connector is required to link with spectrum analyzer through a combiner.

4.4.4. Test Setup Layout

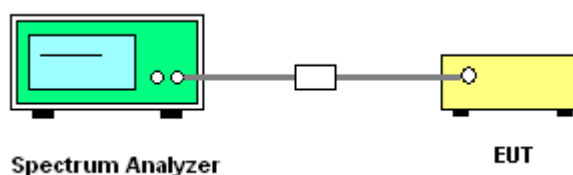

4.4.5. Test Deviation

There is no deviation with the original standard.

4.4.6. EUT Operation during Test

The EUT was programmed to be in continuously transmitting mode.

4.4.7. Test Result of Power Spectral Density

Temperature	22°C	Humidity	61%
Test Engineer	Sam Chen	Configurations	Draft n / Antenna 1

Configuration Draft n MCS8 20MHz Ant. 1

Channel	Frequency	Power Density (dBm)	Max. Limit (dBm)	Result
36	5180 MHz	1.85	4.00	Complies
40	5200 MHz	1.30	4.00	Complies
48	5240 MHz	3.01	4.00	Complies

Configuration Draft n MCS8 40MHz Ant. 1

Channel	Frequency	Power Density (dBm)	Max. Limit (dBm)	Result
38	5190 MHz	-3.66	4.00	Complies
46	5230 MHz	-1.26	4.00	Complies

Temperature	22°C	Humidity	61%
Test Engineer	Sam Chen	Configurations	Draft n / Antenna 5

Configuration Draft n MCS8 20MHz Ant. 5

Channel	Frequency	Power Density (dBm)	Max. Limit (dBm)	Result
36	5180 MHz	1.85	4.00	Complies
40	5200 MHz	1.30	4.00	Complies
48	5240 MHz	3.01	4.00	Complies

Configuration Draft n MCS8 40MHz Ant. 5

Channel	Frequency	Power Density (dBm)	Max. Limit (dBm)	Result
38	5190 MHz	-2.36	4.00	Complies
46	5230 MHz	-1.26	4.00	Complies

Temperature	22°C	Humidity	61%
Test Engineer	Sam Chen	Configurations	Draft n / Antenna 6

Configuration Draft n MCS8 20MHz Ant. 6

Channel	Frequency	Power Density (dBm)	Max. Limit (dBm)	Result
36	5180 MHz	-4.96	-3.00	Complies
40	5200 MHz	-4.35	-3.00	Complies
48	5240 MHz	-4.83	-3.00	Complies

Configuration Draft n MCS8 40MHz Ant. 6

Channel	Frequency	Power Density (dBm)	Max. Limit (dBm)	Result
38	5190 MHz	-8.58	-3.00	Complies
46	5230 MHz	-7.54	-3.00	Complies

Temperature	22°C	Humidity	61%
Test Engineer	Sam Chen	Configurations	Draft n / Antenna 7

Configuration Draft n MCS8 20MHz Ant. 7

Channel	Frequency	Power Density (dBm)	Max. Limit (dBm)	Result
36	5180 MHz	1.85	4.00	Complies
40	5200 MHz	1.30	4.00	Complies
48	5240 MHz	3.01	4.00	Complies

Configuration Draft n MCS8 40MHz Ant. 7

Channel	Frequency	Power Density (dBm)	Max. Limit (dBm)	Result
38	5190 MHz	-2.40	4.00	Complies
46	5230 MHz	-1.26	4.00	Complies

Power Density Plot on Configuration Drafft n MCS8 20MHz Ant. 1 / 5180 MHz

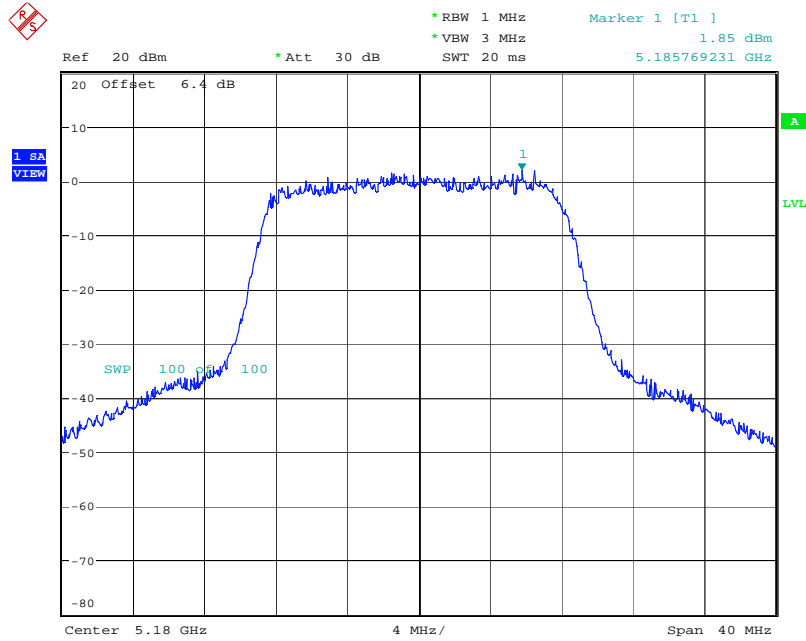

Date: 20.MAR.2008 20:04:38

Power Density Plot on Configuration Drafft n MCS8 20MHz Ant. 1 / 5200 MHz

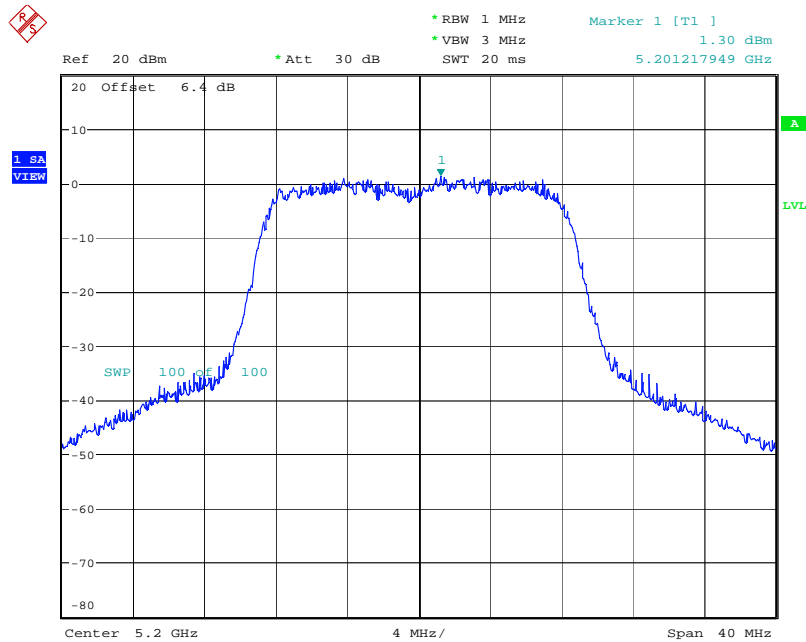

Date: 20.MAR.2008 20:05:59

Power Density Plot on Configuration Drafft n MCS8 20MHz Ant. 1 / 5240 MHz

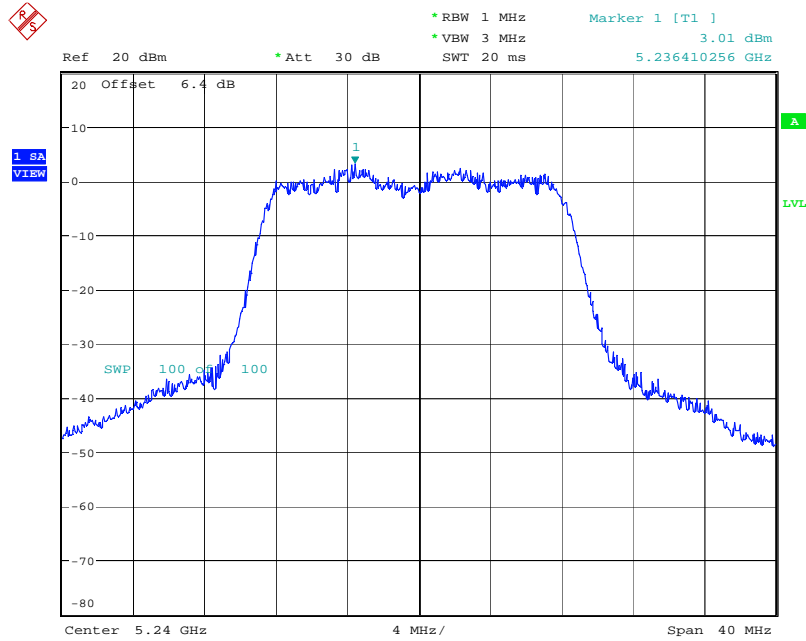

Date: 20.MAR.2008 20:07:39

Power Density Plot on Configuration Drafft n MCS8 40MHz Ant. 1 / 5190 MHz

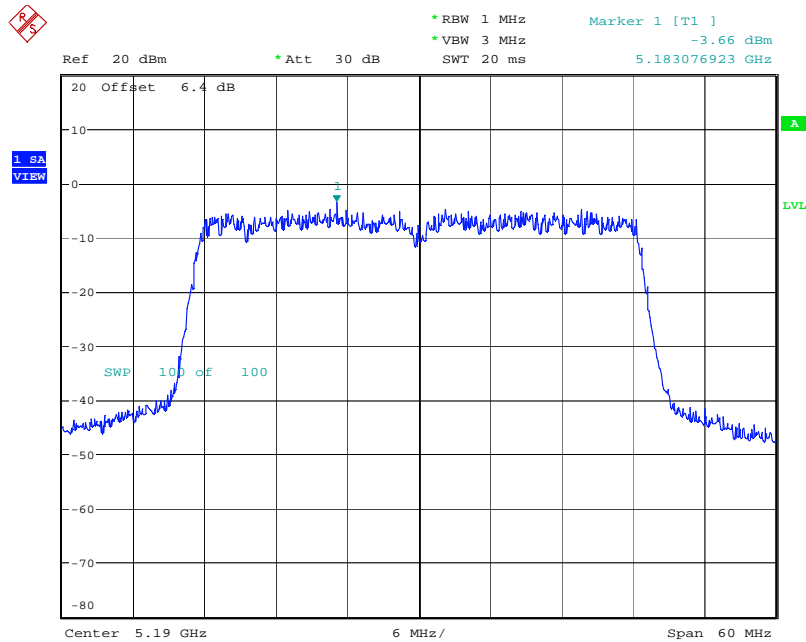

Date: 20.MAR.2008 19:36:33

Power Density Plot on Configuration Draft n MCS8 40MHz Ant. 1 / 5230 MHz

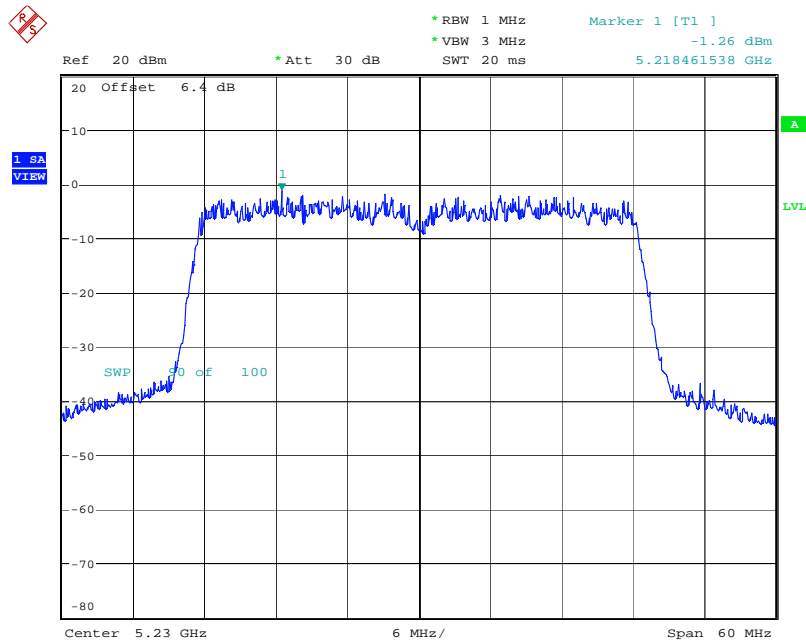

Date: 20.MAR.2008 19:31:56

Power Density Plot on Configuration Drafft n MCS8 20MHz Ant. 5 / 5180 MHz

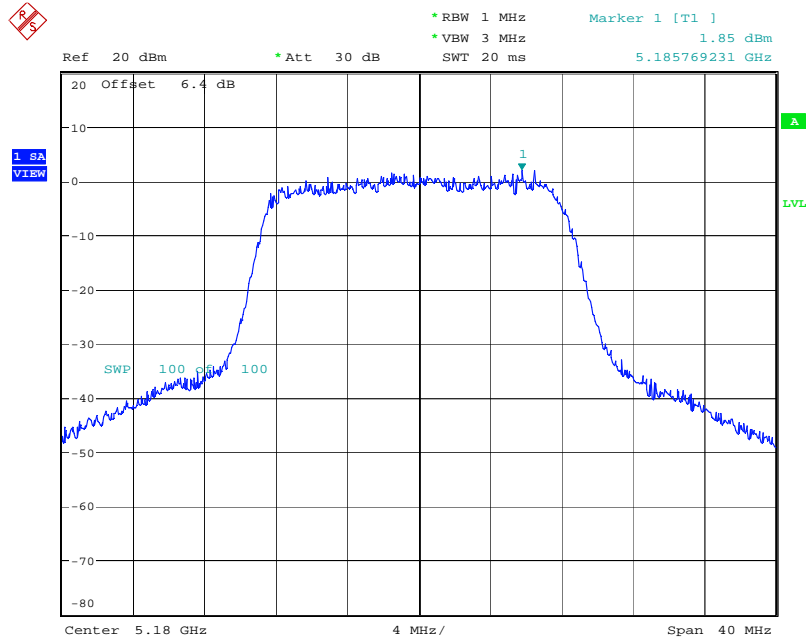

Date: 20.MAR.2008 20:04:38

Power Density Plot on Configuration Drafft n MCS8 20MHz Ant. 5 / 5200 MHz

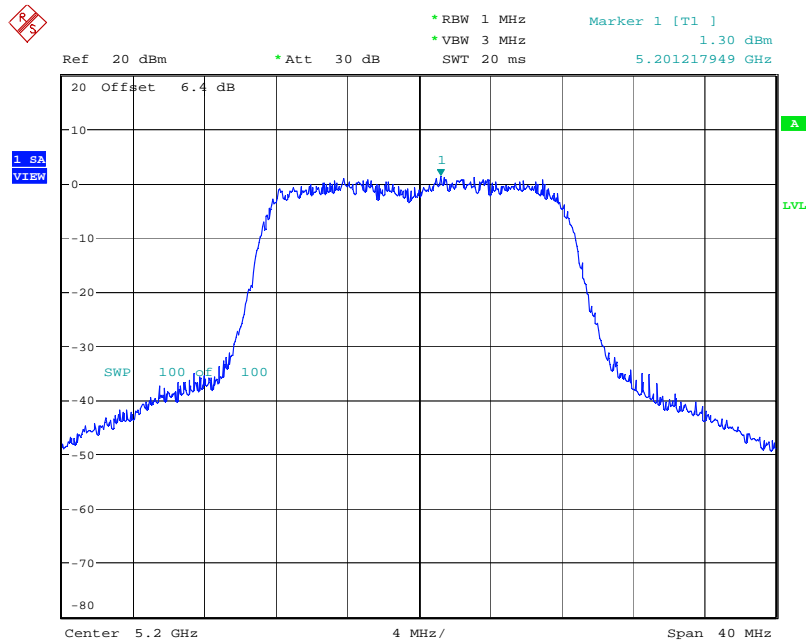

Date: 20.MAR.2008 20:05:59

Power Density Plot on Configuration Drafft n MCS8 20MHz Ant. 5 / 5240 MHz

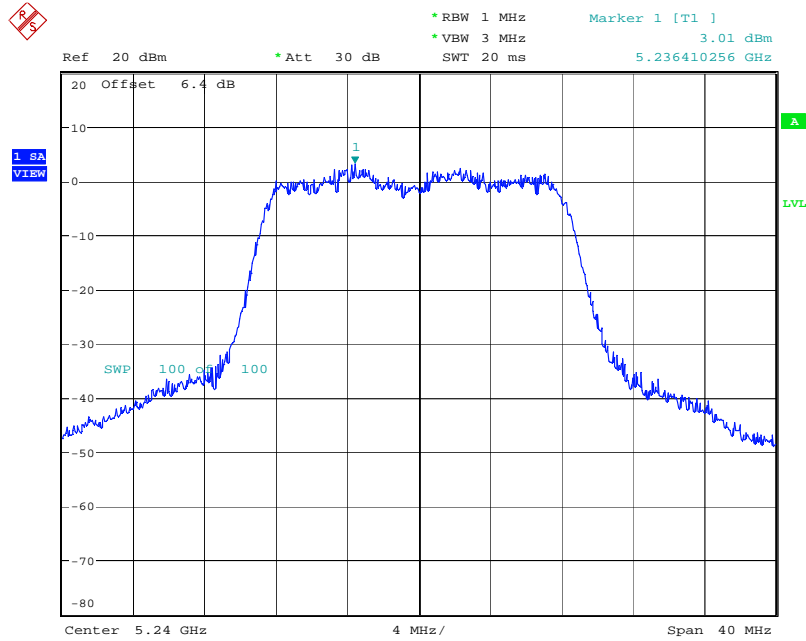

Date: 20.MAR.2008 20:07:39

Power Density Plot on Configuration Drafft n MCS8 40MHz Ant. 5 / 5190 MHz

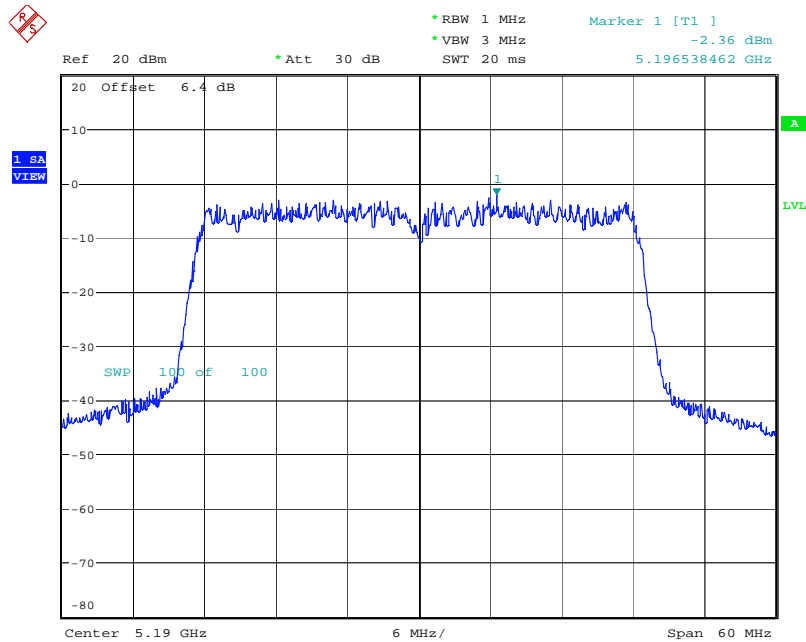

Date: 21.MAR.2008 16:52:54

Power Density Plot on Configuration Draft n MCS8 40MHz Ant. 5 / 5230 MHz

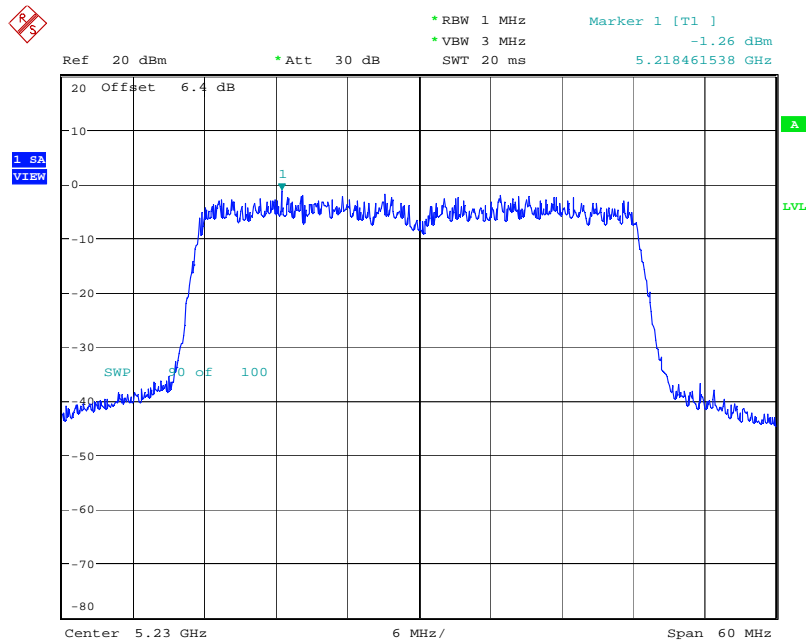

Date: 20.MAR.2008 19:31:56

Power Density Plot on Configuration Drafft n MCS8 20MHz Ant. 6 / 5180 MHz

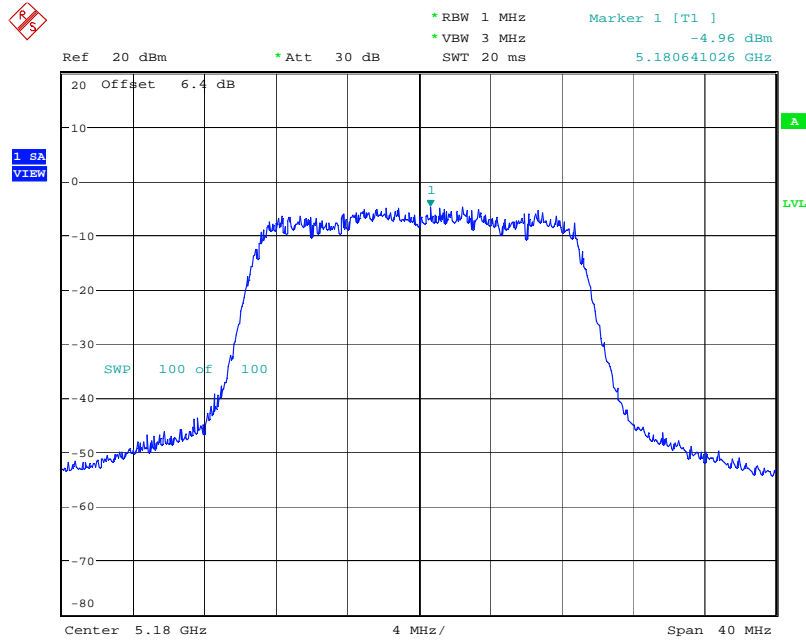

Date: 25.MAR.2008 14:43:15

Power Density Plot on Configuration Drafft n MCS8 20MHz Ant. 6 / 5200 MHz

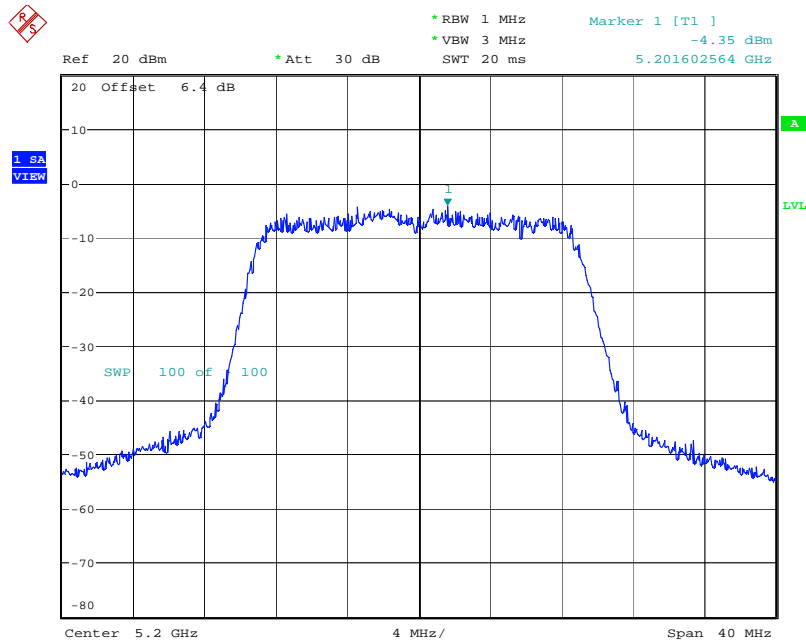

Date: 25.MAR.2008 14:42:35

Power Density Plot on Configuration Drafft n MCS8 20MHz Ant. 6 / 5240 MHz

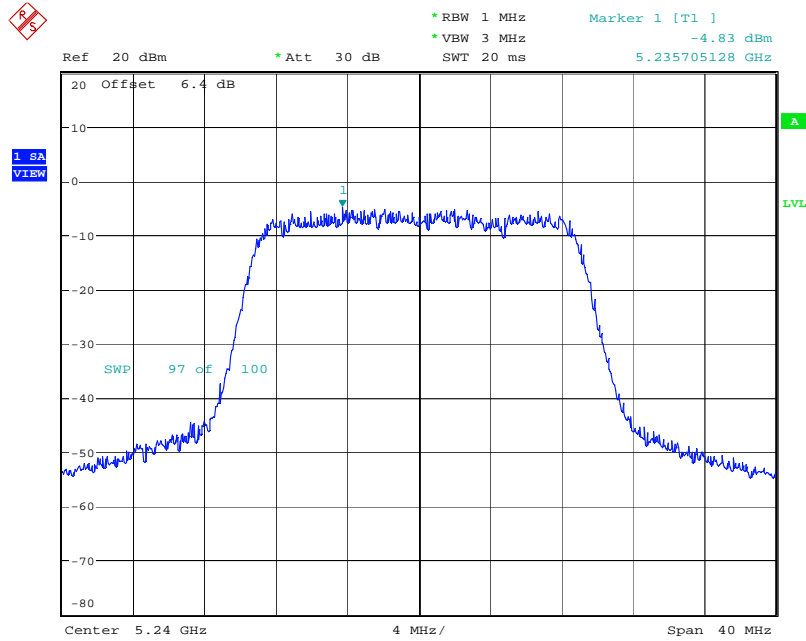

Date: 25.MAR.2008 14:41:47

Power Density Plot on Configuration Drafft n MCS8 40MHz Ant. 6 / 5190 MHz

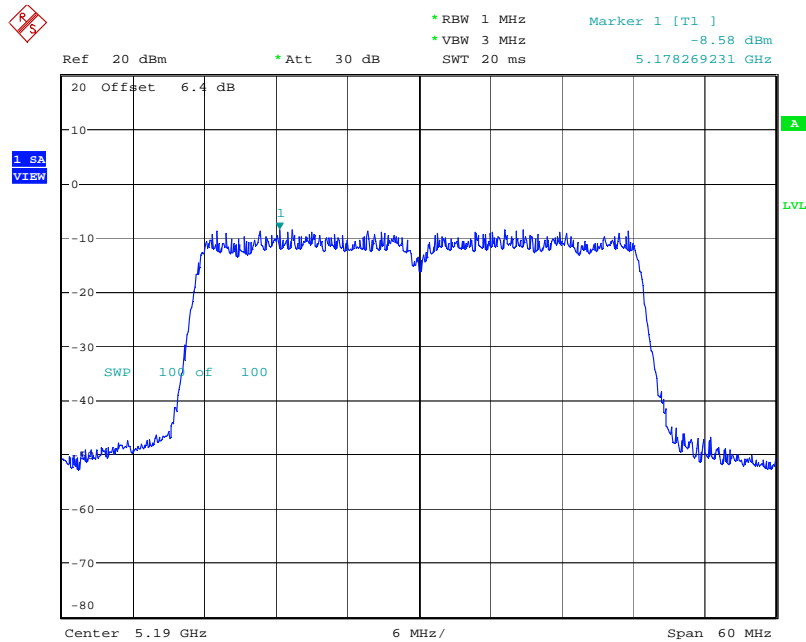

Date: 25.MAR.2008 14:44:13

Power Density Plot on Configuration Draft n MCS8 40MHz Ant. 6 / 5230 MHz

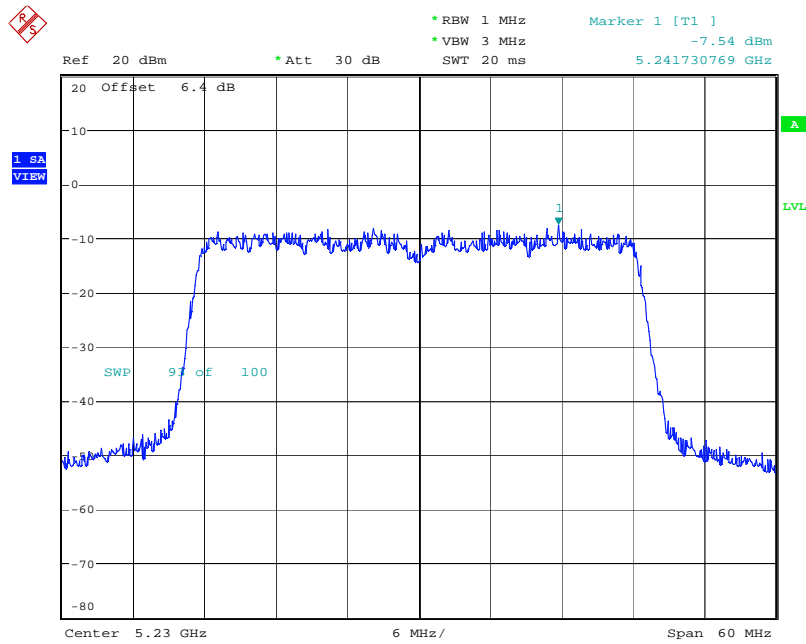

Date: 25.MAR.2008 14:45:00

Power Density Plot on Configuration Drafft n MCS8 20MHz Ant. 7 / 5180 MHz

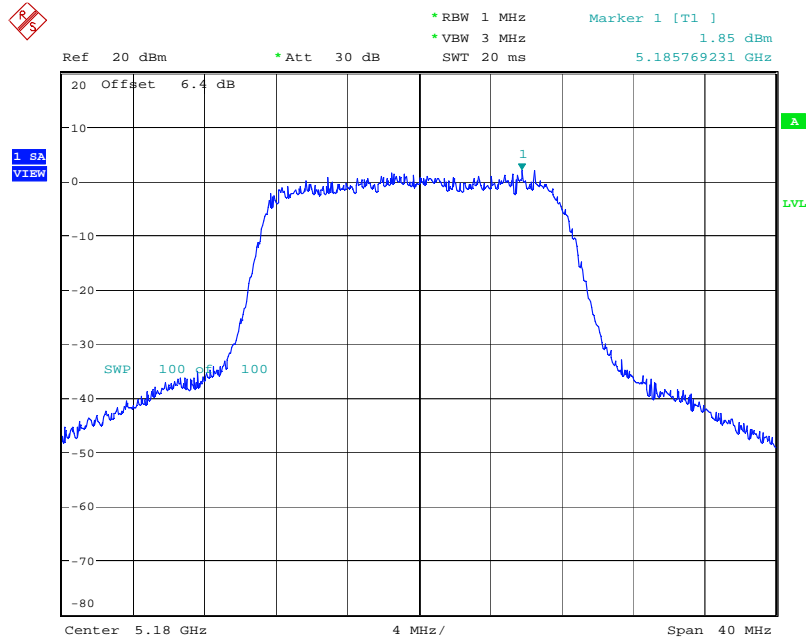

Date: 20.MAR.2008 20:04:38

Power Density Plot on Configuration Drafft n MCS8 20MHz Ant. 7 / 5200 MHz

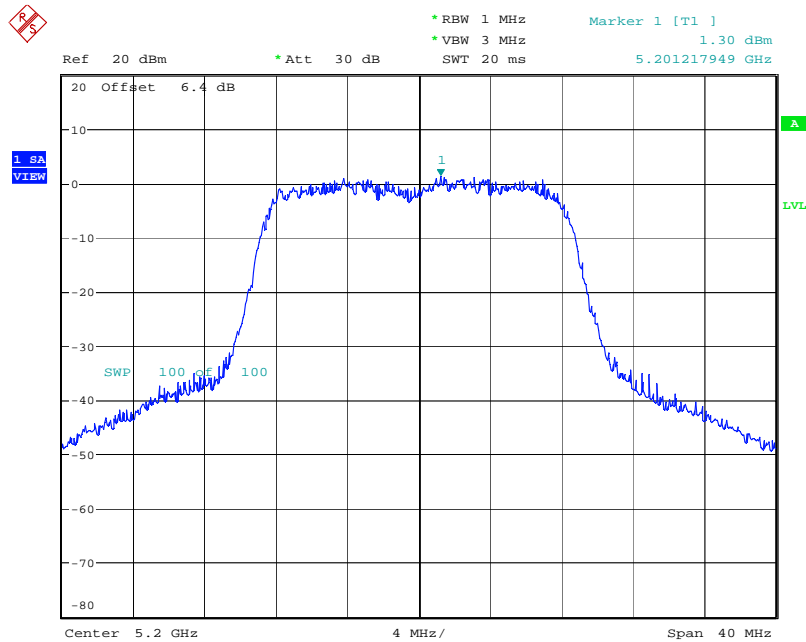

Date: 20.MAR.2008 20:05:59

Power Density Plot on Configuration Drafft n MCS8 20MHz Ant. 7 / 5240 MHz

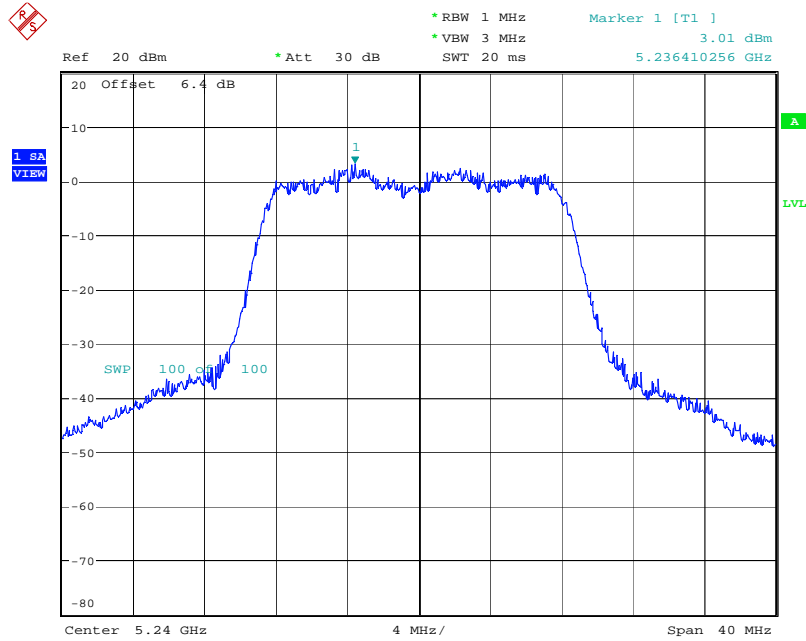

Date: 20.MAR.2008 20:07:39

Power Density Plot on Configuration Drafft n MCS8 40MHz Ant. 7 / 5190 MHz

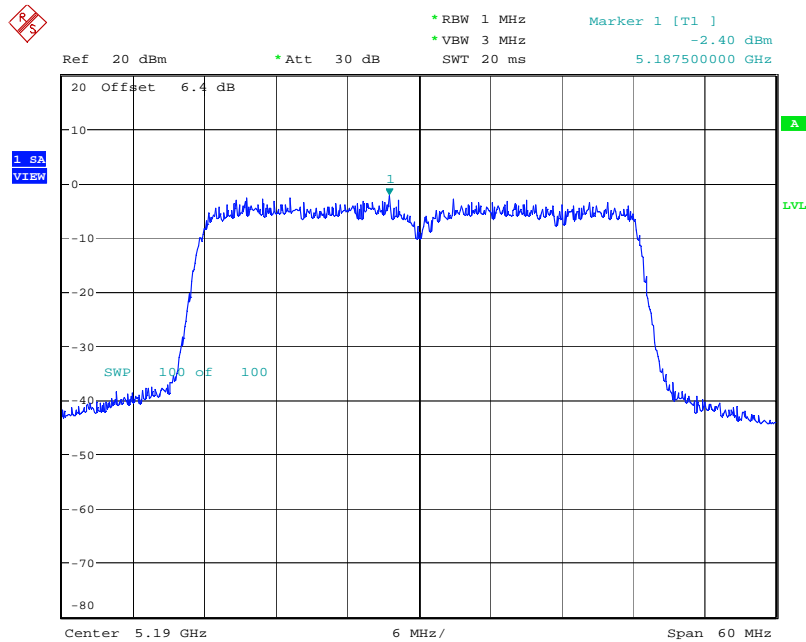

Date: 26.MAR.2008 17:45:44

Power Density Plot on Configuration Draft n MCS8 40MHz Ant. 7 / 5230 MHz

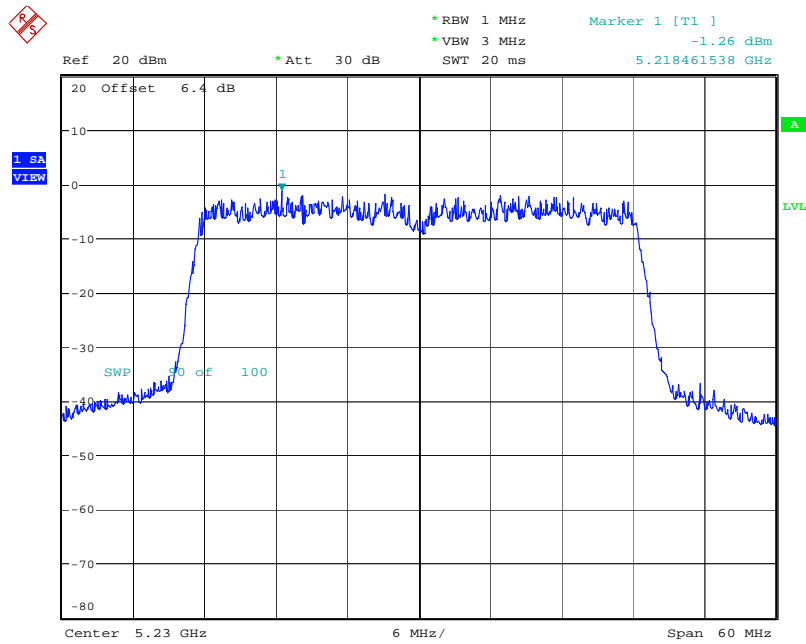

Date: 20.MAR.2008 19:31:56

4.5. Peak Excursion Measurement

4.5.1. Limit

The ratio of the peak excursion of the modulation envelope (measured using a peak hold function) to the maximum conducted output power (measured as specified above) shall not exceed 13 dB across any 1 MHz bandwidth or the emissions bandwidth whichever is less.

4.5.2. Measuring Instruments and Setting

Please refer to section 5 of equipments list in this report. The following table is the setting of the spectrum analyzer.

Spectrum Parameter	Setting
Attenuation	Auto
Span Frequency	Encompass the entire emissions bandwidth (EBW) of the signal
RB	1000 kHz (Peak Trace) / 1000 kHz (Average Trace)
VB	3000 kHz (Peak Trace) / 300 kHz (Average Trace)
Detector	Peak (Peak Trace) / Sample (Average Trace)
Trace	Max Hold
Sweep Time	60s

4.5.3. Test Procedures

1. The transmitter output (antenna port) was connected to the spectrum analyzer.
2. Set the spectrum analyzer span to view the entire emissions bandwidth. The largest difference between the following two traces (Peak Trace and Average Trace) must be ≤ 13 dB for all frequencies across the emissions bandwidth. Submit a plot.
3. Peak Trace: Set RBW = 1 MHz, VBW ≥ 3 MHz with peak detector and max-hold settings.
4. Average Trace: Method #3—video averaging with max hold--and sum power across the band. Set span to encompass the entire emissions bandwidth (EBW) of the signal. Set sweep trigger to "free run". Set RBW = 1 MHz. Set VBW $\geq 1/T$ (Draft n VBW = 300kHz $\geq 1/4 \mu$ s). Use sample detector mode if bin width (i.e., span/number of points in spectrum) < 0.5 RBW. Otherwise use peak detector mode . Set max hold. Allow max hold to run for 60 seconds.
5. Measuring multiple antennas, the connector is required to link with spectrum analyzer through a combiner.

4.5.4. Test Setup Layout

