



SPORTON International Inc.

No. 52, Hwa Ya 1st Rd., Kwei-Shan Hsiang, TaoYuan Hsien, Taiwan, R.O.C.
Ph: 886-3-327-3456 / FAX: 886-3-327-0973 / www.sporton.com.tw

FCC RADIO TEST REPORT

Applicant's company	Motorola, Inc.
Applicant Address	One Motorola Plaza Holtsville, NY 11742 USA
FCC ID	UZ7AP7131
Manufacturer's company	Accton Technology Corporation
Manufacturer Address	No. 1 Creation Rd., III, Science-based Industrial Park, Hsinchu 300, Taiwan, R.O.C.

Product Name	11 a/b/g/n Access Point Module
Brand Name	Motorola
Model Name	AP-7131-MB82
Test Rule	47 CFR FCC Part 15 Subpart C § 15.247
Test Freq. Range	2400 ~ 2483.5MHz / 5725 ~ 5850MHz
Received Date	Feb. 15, 2008
Final Test Date	Apr. 2, 2008
Submission Type	Original Equipment

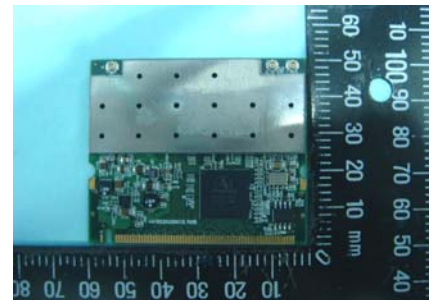

Statement

Test result included is only for the Draft n part of the product.

The test result in this report refers exclusively to the presented test model / sample.

Without written approval of SPORTON International Inc., the test report shall not be reproduced except in full.

The measurements and test results shown in this test report were made in accordance with the procedures and found in compliance with the limit given in **ANSI C63.4-2003** and **47 CFR FCC Part 15 Subpart C**.

The test equipment used to perform the test is calibrated and traceable to NML/ROC.



Table of Contents

1. CERTIFICATE OF COMPLIANCE	1
2. SUMMARY OF THE TEST RESULT	2
3. GENERAL INFORMATION	3
3.1. Product Details.....	3
3.2. Accessories.....	5
3.3. Table for Filed Antenna.....	5
3.4. Table for Carrier Frequencies	6
3.5. Table for Test Modes	7
3.6. Table for Testing Locations.....	8
3.7. Table for Supporting Units	8
3.8. Table for Parameters of Test Software Setting	8
3.9. Test Configurations	12
4. TEST RESULT	23
4.1. AC Power Line Conducted Emissions Measurement.....	23
4.2. Maximum Conducted Output Power Measurement.....	39
4.3. Power Spectral Density Measurement	135
4.4. 6dB Spectrum Bandwidth Measurement	168
4.5. Radiated Emissions Measurement	201
4.6. Band Edge Emissions Measurement	319
4.7. Antenna Requirements	356
5. LIST OF MEASURING EQUIPMENTS	357
6. TEST LOCATION.....	358
7. TAF CERTIFICATE OF ACCREDITATION	359
APPENDIX A. PHOTOGRAPHS OF EUT.....	A1 ~ A20
APPENDIX B. TEST PHOTOS.....	B1 ~ B37
APPENDIX C. MAXIMUM PERMISSIBLE EXPOSURE.....	C1 ~C3



History of This Test Report

Original Issue Date: May 22, 2008

Report No.: FR821205AD

No additional attachment.

Additional attachment were issued as following record:

Attachment No.	Issue Date	Description

1. CERTIFICATE OF COMPLIANCE

Product Name : 11 a/b/g/n Access Point Module
Brand Name : Motorola
Model Name : AP-7131-MB82
Applicant : Motorola, Inc.
Test Rule Part(s) : 47 CFR FCC Part 15 Subpart C § 15.247

Sporton International as requested by the applicant to evaluate the EMC performance of the product sample received on Feb. 15, 2008 would like to declare that the tested sample has been evaluated and found to be in compliance with the tested rule parts. The data recorded as well as the test configuration specified is true and accurate for showing the sample's EMC nature.



Wayne Hsu

SPORTON INTERNATIONAL INC.

2. SUMMARY OF THE TEST RESULT

Applied Standard: 47 CFR FCC Part 15 Subpart C				
Part	Rule Section	Description of Test	Result	Under Limit
4.1	15.207	AC Power Line Conducted Emissions	Complies	12.50 dB
4.2	15.247(b)(3)	Maximum Conducted Output Power	Complies	0.16 dB
4.3	15.247(e)	Power Spectral Density	Complies	3.32 dB
4.4	15.247(a)(2)	6dB Spectrum Bandwidth	Complies	-
4.5	15.247(d)	Radiated Emissions	Complies	0.31 dB
4.6	15.247(d)	Band Edge Emissions	Complies	0.04 dB
4.7	15.203	Antenna Requirements	Complies	-

Test Items	Uncertainty	Remark
AC Power Line Conducted Emissions	±2.3dB	Confidence levels of 95%
Maximum Conducted Output Power	±0.8dB	Confidence levels of 95%
Power Spectral Density	±0.5dB	Confidence levels of 95%
6dB Spectrum Bandwidth	±8.5×10 ⁻⁸	Confidence levels of 95%
Radiated Emissions (9kHz~30MHz)	±0.8dB	Confidence levels of 95%
Radiated Emissions (30MHz~1000MHz)	±1.9dB	Confidence levels of 95%
Radiated / Band Edge Emissions (1GHz~18GHz)	±1.9dB	Confidence levels of 95%
Radiated Emissions (18GHz~40GHz)	±1.9dB	Confidence levels of 95%
Temperature	±0.7°C	Confidence levels of 95%
Humidity	±3.2%	Confidence levels of 95%
DC / AC Power Source	±1.4%	Confidence levels of 95%

3. GENERAL INFORMATION

3.1. Product Details

Items	Description
Product Type	WLAN (3TX, 3RX)
Radio Type	Intentional Transceiver
Power Type	From Host System
Modulation	see the below table for draft n
Data Modulation	OFDM (BPSK / QPSK / 16QAM / 64QAM)
Data Rate (Mbps)	see the below table for Draft n
Frequency Range	2400 ~ 2483.5MHz / 5725 ~ 5850MHz
Channel Number	11 for MCS8 20MHz bandwidth ; 7 for MCS8 40MHz bandwidth Band 4: 5 for 11a MCS8 20MHz bandwidth ; Band 4: 2 for 11a MCS8 40MHz bandwidth
Channel Band Width (99%)	MCS8 (20MHz) : 17.62 MHz ; MCS8 (40MHz) : 36.28 MHz Band 4: 11a MCS8 (20MHz) : 17.91 MHz ; Band 4: 11a MCS8 (40MHz) : 36.41 MHz
Conducted Output Power	MCS8 (20MHz) : 27.72 dBm ; MCS8 (40MHz) : 21.94 dBm Band 4: 11a MCS8 (20MHz) : 28.78 MHz ; Band 4: 11a MCS8 (40MHz) : 28.12 MHz
Carrier Frequencies	Please refer to section 3.4
Antenna	Please refer to section 3.3

Antenna & Band width

Antenna	Three (TX)	
Band width Mode	20 MHz	40 MHz
Draft n	V	V

Draft n spec

MCS Index	Nss	Modulation	R	NBPSC	NCBPS		NDBPS		Data rate(Mbps)			
					800nsGI		20MHz	40MHz	20MHz	40MHz	20MHz	40MHz
					20MHz	40MHz						
0	1	BPSK	1/2	1	52	108	26	54	6.5	13.5		
1	1	QPSK	1/2	2	104	216	52	108	13.0	27.0		
2	1	QPSK	3/4	2	104	216	78	162	19.5	40.5		
3	1	16-QAM	1/2	4	208	432	104	216	26.0	54.0		
4	1	16-QAM	3/4	4	208	432	156	324	39.0	81.0		
5	1	64-QAM	2/3	6	312	648	208	432	52.0	108.0		
6	1	64-QAM	3/4	6	312	648	234	486	58.5	121.5		
7	1	64-QAM	5/6	6	312	648	260	540	65.0	135.0		
8	2	BPSK	1/2	1	104	216	52	108	13.0	27.0		
9	2	QPSK	1/2	2	208	432	104	216	26.0	54.0		
10	2	QPSK	3/4	2	208	432	156	324	39.0	81.0		
11	2	16-QAM	1/2	4	416	864	208	432	52.0	108.0		
12	2	16-QAM	3/4	4	416	864	312	648	78.0	162.0		
13	2	64-QAM	2/3	6	624	1296	416	864	104.0	216.0		
14	2	64-QAM	3/4	6	624	1296	468	972	117.0	243.0		
15	2	64-QAM	5/6	6	624	1296	520	1080	130.0	270.0		
16	3	BPSK	1/2	1	156	324	78	162	19.5	40.5		
17	3	QPSK	1/2	2	312	648	156	324	39	81		
18	3	QPSK	3/4	2	312	648	234	486	58.5	121.5		
19	3	16-QAM	1/2	4	624	1296	312	648	78	162		
20	3	16-QAM	3/4	4	624	1296	468	972	117	243		
21	3	64-QAM	2/3	6	936	1944	624	1296	156	324		
22	3	64-QAM	3/4	6	936	1944	702	1458	175.5	364.5		
23	3	64-QAM	5/6	6	936	1944	780	1620	195	405.5		

Symbol	Explanation
NSS	Number of spatial streams
R	Code rate
NBPSC	Number of coded bits per single carrier
NCBPS	Number of coded bits per symbol
NDBPS	Number of data bits per symbol
GI	guard interval

3.2. Accessories

N/A

3.3. Table for Filed Antenna

For 2.4GHz Band

Ant.	Brand	Model Name	Antenna Type	Connector	Gain (dBi)
1	SYMBOL	ML-2452-APA2-01R	Dipole Antenna	Reversed-SMA	3
2	SYMBOL	ML-2499-11PNA2-01	Panel Antenna	RP-BNC-Female	8.5
3	SYMBOL	ML-2499-HPA3-01	Dipole Antenna	RP-BNC-Female	3.3
4	SYMBOL	ML-2499-BYGA2-01	Yagi	N Type	13.9
5	SYMBOL	ML-2452-APA2-FAC	embedded	Reversed-SMA	2.5

For 5GHz Band

Ant.	Brand	Model Name	Antenna Type	Connector	Gain (dBi)
1	SYMBOL	ML-2452-APA2-01R	Dipole Antenna	Reversed-SMA	4
5	SYMBOL	ML-2452-APA2-FAC	embedded Antenna	Reversed-SMA	4.5
6	SYMBOL	ML-5299-WPNA1-01	Patch Antenna	Reversed-SMA	13
7	SYMBOL	ML-5299-HPA1-01	Omni Antenna	Reversed-SMA	5

Note : The EUT has four antennas.

Connector (J2) & Connector (J3) & Connector (J4) could Receiver / Transmitter simultaneously.

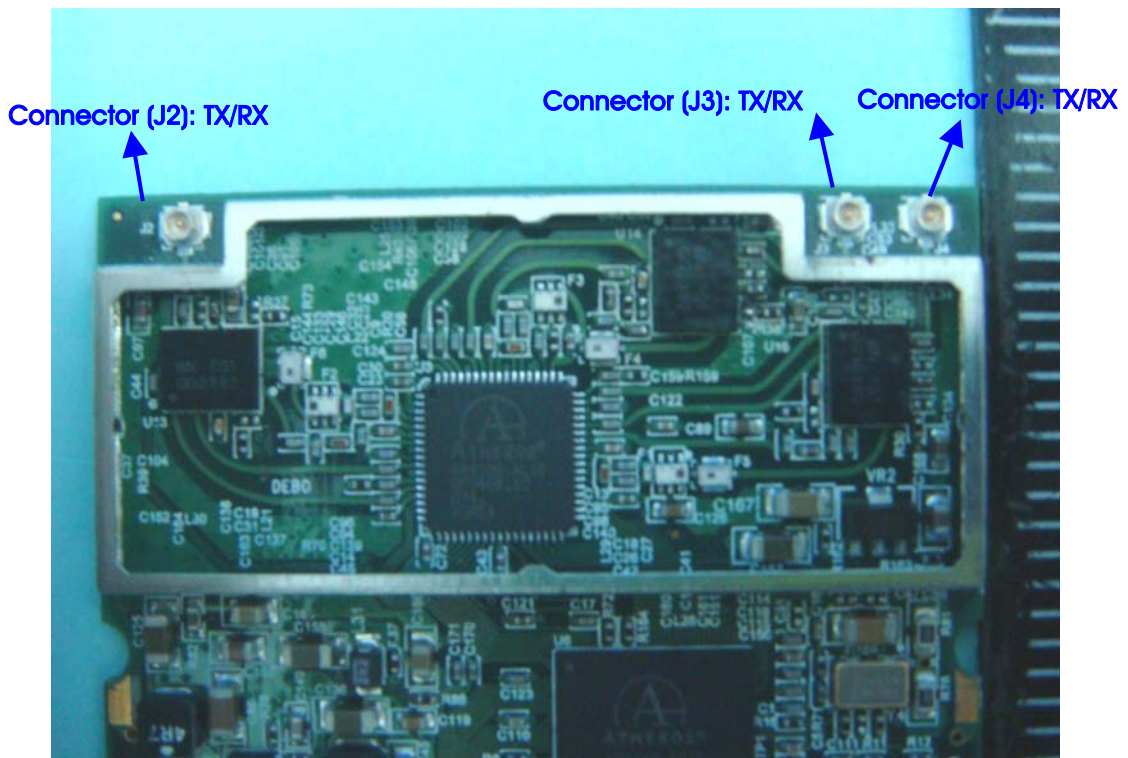

3.4. Table for Carrier Frequencies

There are two bandwidth systems for draft n.

For 2.4GHz Band

Frequency Allocation for 802.11b/g

For 20MHz bandwidth systems, use Channel 1~Channel 11.

For 40MHz bandwidth systems, use Channel 3~Channel 9.

Frequency Band	Channel No.	Frequency	Channel No.	Frequency
2400~2483.5MHz	1	2412 MHz	7	2442 MHz
	2	2417 MHz	8	2447 MHz
	3	2422 MHz	9	2452 MHz
	4	2427 MHz	10	2457 MHz
	5	2432 MHz	11	2462 MHz
	6	2437 MHz		

For 5GHz Band

Frequency Allocation for 802.11a

For 20MHz bandwidth systems, use Channel 149, 153, 157, 161, 165.

For 40MHz bandwidth systems, use Channel 151, 159.

Frequency Band	Channel No.	Frequency	Channel No.	Frequency
5725~5850 MHz	149	5745 MHz	159	5795 MHz
	151	5755 MHz	161	5805 MHz
	153	5765 MHz	165	5825 MHz
	157	5785 MHz		

3.5. Table for Test Modes

Preliminary tests were performed in different data rate to find the worst radiated emission. The data rate shown in the table below is the worst-case rate with respect to the specific test item. Investigation has been done on all the possible configurations for searching the worst cases. The following table is a list of the test modes shown in this test report.

For 2.4GHz Band

Test Items	Mode	Data Rate	Channel	Antenna
AC Power Line Conducted Emissions	Normal Link	-	-	1, 2, 3, 4, 5
Maximum Peak Conducted Output Power	MCS8/20MHz	13 Mbps	1/6/11	1, 2, 3, 4, 5
	MCS8/40MHz	27 Mbps	3/6/9	1, 2, 3, 4, 5
Power Spectral Density 6dB Spectrum Bandwidth	MCS8/20MHz	13 Mbps	1/6/11	1, 2, 3, 4, 5
	MCS8/40MHz	27 Mbps	3/6/9	1, 2, 3, 4, 5
Radiated Emissions 9kHz~1GHz	Normal Link	-	-	-
Radiated Emissions 1GHz~10 th Harmonic	MCS8/20MHz	13 Mbps	1/6/11	1, 2, 3, 4, 5
	MCS8/40MHz	27 Mbps	3/6/9	1, 2, 3, 4, 5
Band Edge Emissions	MCS8/20MHz	13 Mbps	1/11	1, 2, 3, 4, 5
	MCS8/40MHz	27 Mbps	3/9	1, 2, 3, 4, 5

For 5GHz Band

Test Items	Mode	Data Rate	Channel	Antenna
AC Power Line Conducted Emissions	Normal Link	-	-	1, 5, 6, 7
Maximum Peak Conducted Output Power	MCS8/20MHz	13 Mbps	149/157/165	1, 5, 6, 7
	MCS8/40MHz	27 Mbps	151/159	1, 5, 6, 7
Power Spectral Density 6dB Spectrum Bandwidth	MCS8/20MHz	13 Mbps	149/157/165	1, 5, 6, 7
	MCS8/40MHz	27 Mbps	151/159	1, 5, 6, 7
Radiated Emissions 9kHz~1GHz	Normal Link	-	-	-
Radiated Emissions 1GHz~10 th Harmonic	MCS8/20MHz	13 Mbps	149/157/165	1, 5, 6, 7
	MCS8/40MHz	27 Mbps	151/159	1, 5, 6, 7
Band Edge Emissions	MCS8/20MHz	13 Mbps	149/157/165	1, 5, 6, 7
	MCS8/40MHz	27 Mbps	151/159	1, 5, 6, 7

3.6. Table for Testing Locations

Test Site No.	Site Category	Location	FCC Reg. No.	IC File No.	VCCI Reg. No
03CH03-HY	SAC	Hwa Ya	101377	IC 4088	-
CO04-HY	Conduction	Hwa Ya	101377	IC 4088	-
TH01-HY	OVEN Room	Hwa Ya	-	-	-

Open Area Test Site (OATS); Semi Anechoic Chamber (SAC); Fully Anechoic Chamber (FAC).

Please refer section 6 for Test Site Address.

3.7. Table for Supporting Units

Support Unit	Brand	Model	FCC ID
Notebook	DELL	D400	E2K24GBRL
Notebook	DELL	D505	E2K24GBRL
Modem	ACEEX	DM1414	IFAXDM1414
Mouse	QSKY	Lx-619B	DOC
Printer	EPSON	LQ-300+	DOC

3.8. Table for Parameters of Test Software Setting

During testing, Channel & Power Controlling Software provided by the customer was used to control the operating channel as well as the output power level. The RF output power selection is for the setting of RF output power expected by the customer and is going to be fixed on the firmware of the final end product.

For Antenna 1

Power Parameters of Draft n MCS8 20MHz

Test Software Version	ART		
Frequency	2412 MHz	2437 MHz	2462 MHz
Draft n	14.5	18	14

Power Parameters of Draft n MCS8 40MHz

Test Software Version	ART		
Frequency	2422 MHz	2437 MHz	2452 MHz
Draft n	11	14.5	12

Power Parameters of 11a Draft n MCS8 20MHz

Test Software Version	ART		
Frequency	5745 MHz	5785 MHz	5825 MHz
Draft n	21	22	22

Power Parameters of 11a Draft n MCS8 40MHz

Test Software Version	ART	
Frequency	5755 MHz	5795 MHz
Draft n	19.5	22

For Antenna 2
Power Parameters of Draft n MCS8 20MHz

Test Software Version	ART		
Frequency	2412 MHz	2437 MHz	2462 MHz
Draft n	10	12.5	10.5

Power Parameters of Draft n MCS8 40MHz

Test Software Version	ART		
Frequency	2422 MHz	2437 MHz	2452 MHz
Draft n	6	9.5	6.5

For Antenna 3
Power Parameters of Draft n MCS8 20MHz

Test Software Version	ART		
Frequency	2412 MHz	2437 MHz	2462 MHz
Draft n	11	16.5	13

Power Parameters of Draft n MCS8 40MHz

Test Software Version	ART		
Frequency	2422 MHz	2437 MHz	2452 MHz
Draft n	9	12	10

For Antenna 4
Power Parameters of Draft n MCS8 20MHz

Test Software Version	ART		
Frequency	2412 MHz	2437 MHz	2462 MHz
Draft n	14	14	14.5

Power Parameters of Draft n MCS8 40MHz

Test Software Version	ART		
Frequency	2422 MHz	2437 MHz	2452 MHz
Draft n	13.5	14	13

For Antenna 5
Power Parameters of Draft n MCS8 20MHz

Test Software Version	ART		
Frequency	2412 MHz	2437 MHz	2462 MHz
Draft n	13	20	13

Power Parameters of Draft n MCS8 40MHz

Test Software Version	ART		
Frequency	2422 MHz	2437 MHz	2452 MHz
Draft n	10.5	14.5	10.5

Power Parameters of 11a Draft n MCS8 20MHz

Test Software Version	ART		
Frequency	5745 MHz	5785 MHz	5825 MHz
Draft n	21	21	21

Power Parameters of 11a Draft n MCS8 40MHz

Test Software Version	ART	
Frequency	5755 MHz	5795 MHz
Draft n	19.5	22

For Antenna 6
Power Parameters of 11a Draft n MCS8 20MHz

Test Software Version	ART		
Frequency	5745 MHz	5785 MHz	5825 MHz
Draft n	18	18	18

Power Parameters of 11a Draft n MCS8 40MHz

Test Software Version	ART	
Frequency	5755 MHz	5795 MHz
Draft n	17	17

For Antenna 7
Power Parameters of 11a Draft n MCS8 20MHz

Test Software Version	ART		
Frequency	5745 MHz	5785 MHz	5825 MHz
Draft n	21	22	22

Power Parameters of 11a Draft n MCS8 40MHz

Test Software Version	ART	
Frequency	5755 MHz	5795 MHz
Draft n	19.5	22

An executive program, EMCTEST.EXE under WIN XP, which generates a complete line of continuously repeating “ H “ pattern was used as the test software.

The program was executed as follows :

- a. Turn on the power of all equipment.
- b. The NB sends “ H “ messages to the panel, and the panel displays “ H “ patterns on the screen.
- c. The NB sends “ H “ messages to the printer, then the printer prints them on the paper.
- d. The NB sends “ H “ messages to the modem.
- e. Repeat the steps from b to d.

At the same time, “ART” was executed to control the EUT continuously transmit RF signal.

3.9. Test Configurations

3.9.1. Radiation Emissions Test Configuration

Antenna 1

Test configuration: 9kHz ~ 1GHz

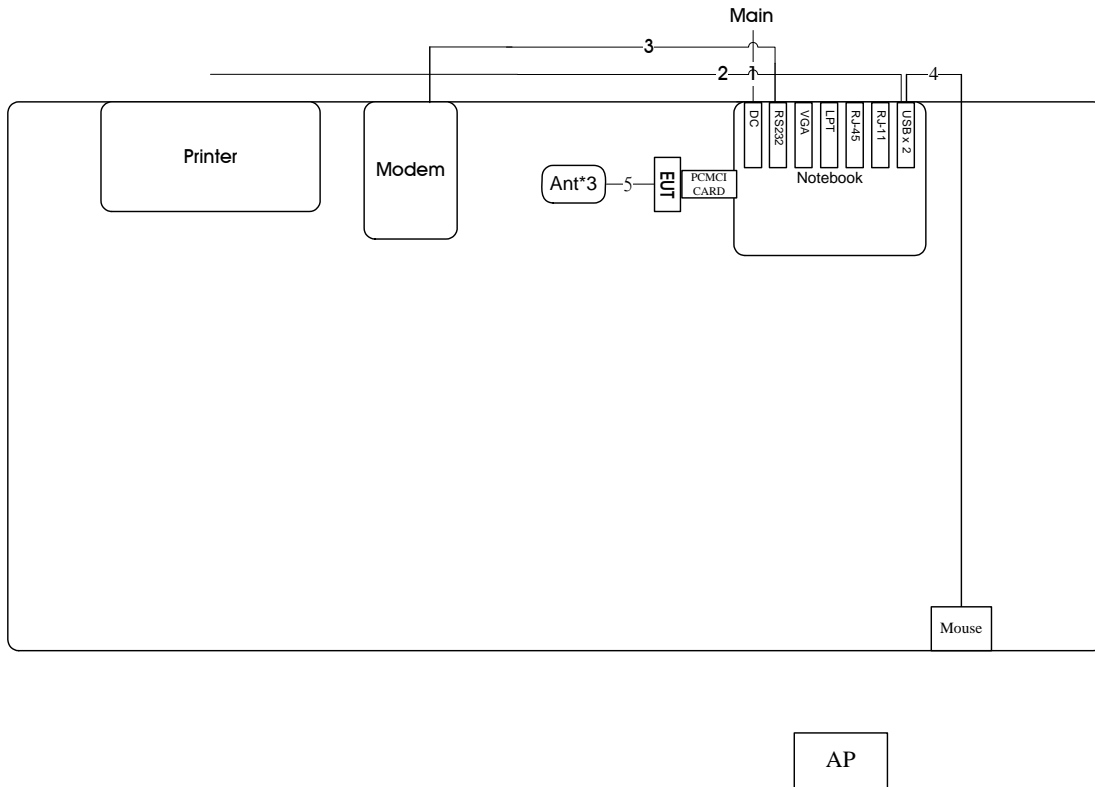

Test configuration: Above 1GHz

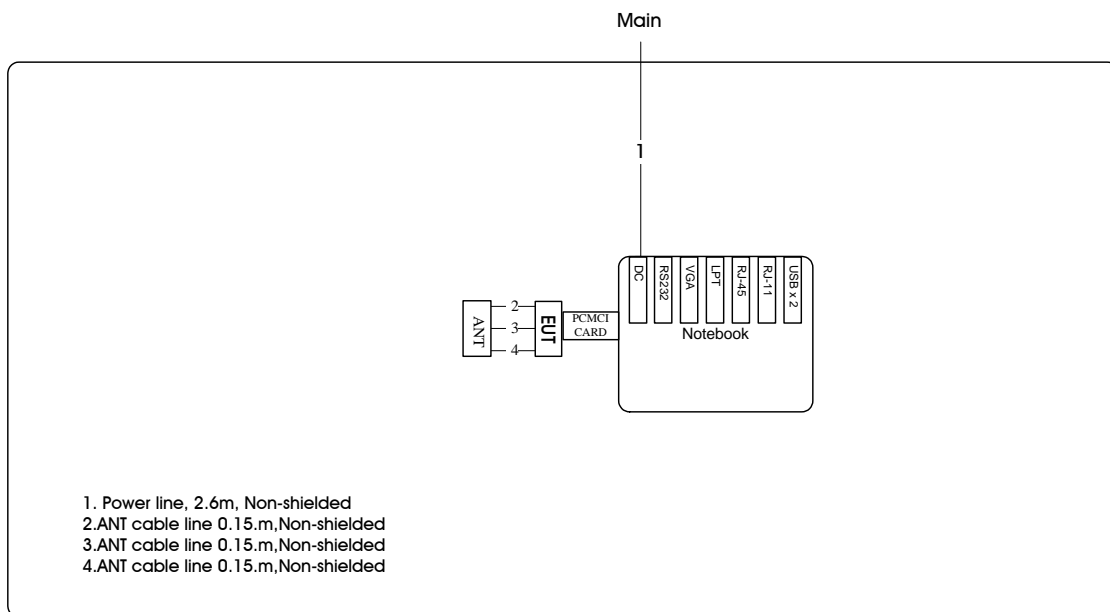

Antenna 2

Test configuration: 9kHz ~1GHz

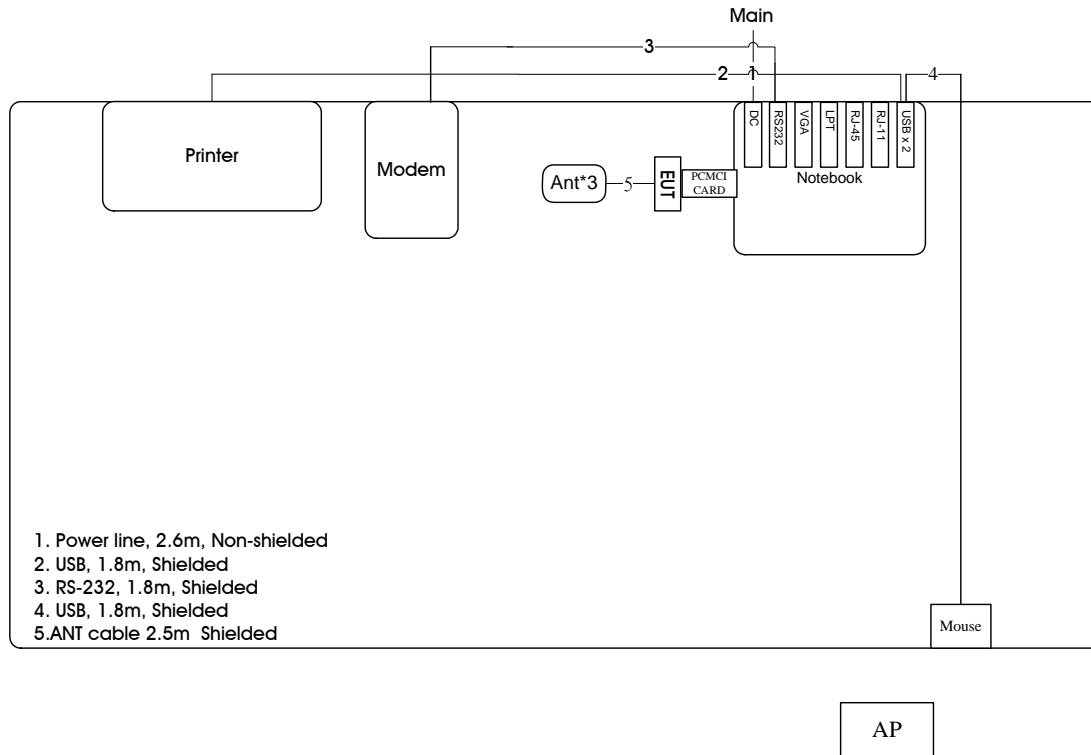

Test configuration: Above 1GHz

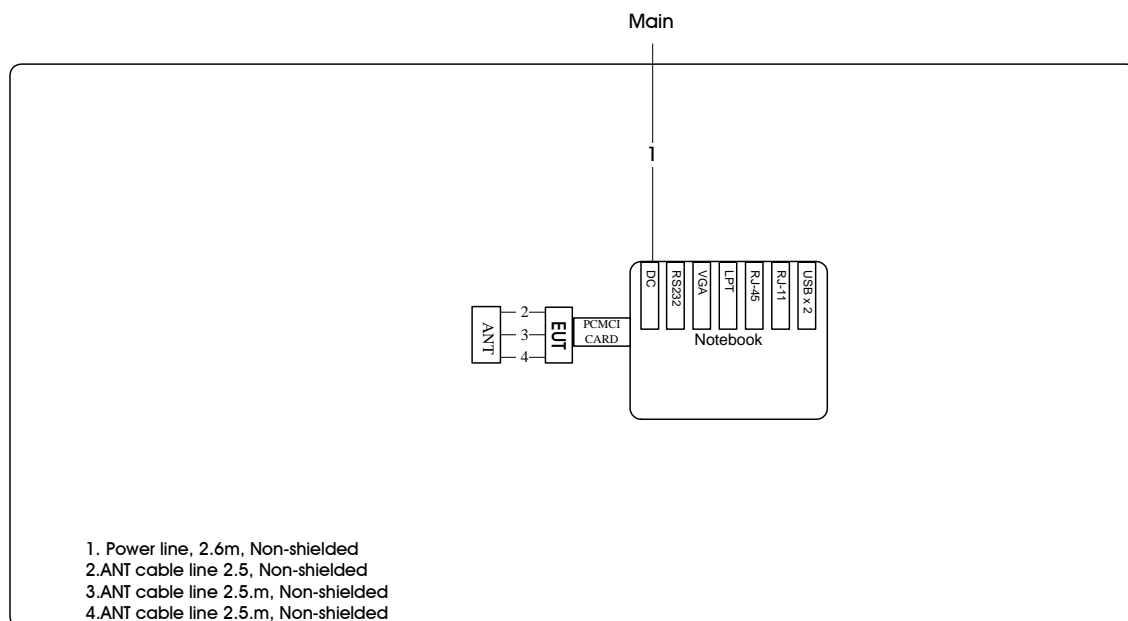

Antenna 3

Test configuration: 9kHz ~ 1GHz

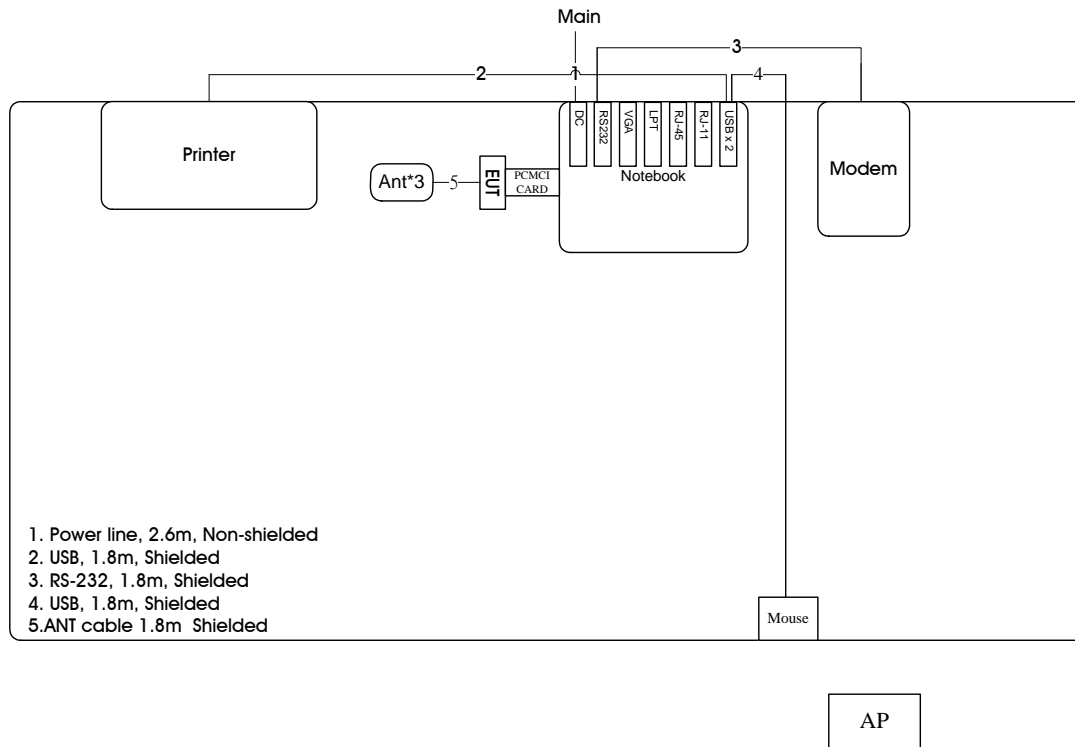

Test configuration: Above 1GHz

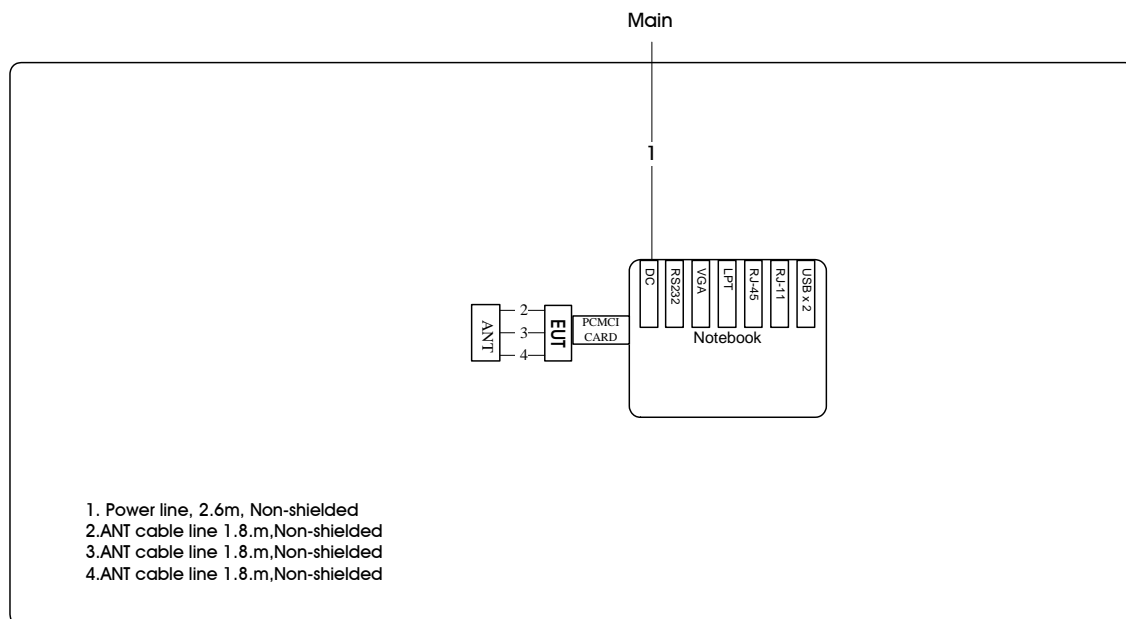

Antenna 4

Test configuration: 9kHz ~1GHz

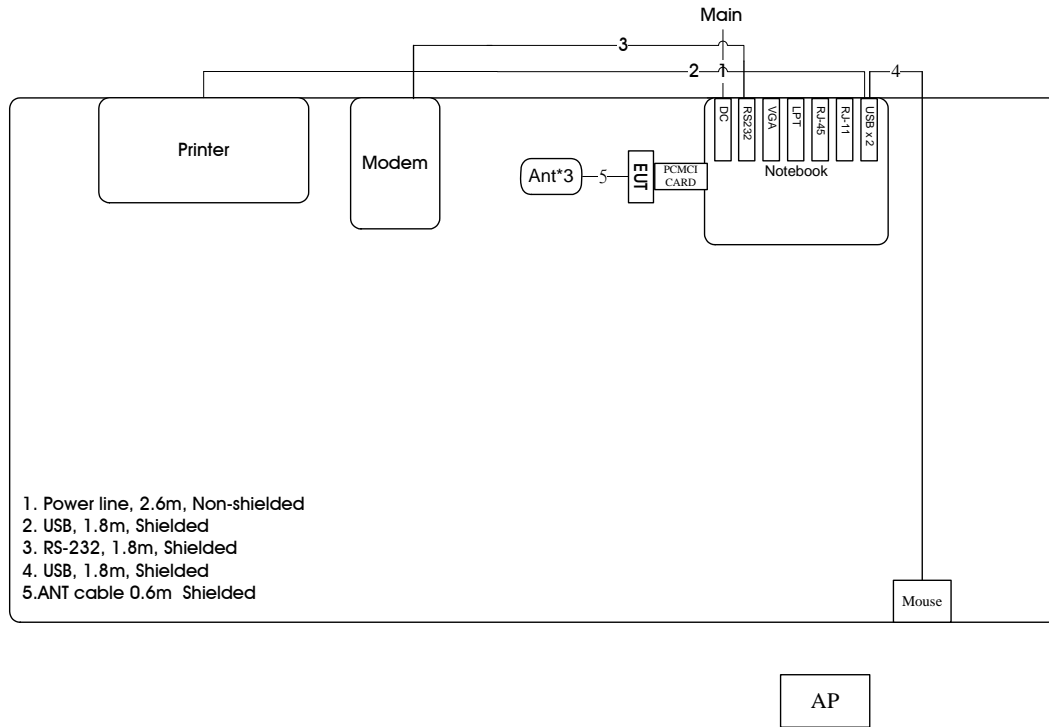

Test configuration: Above 1GHz

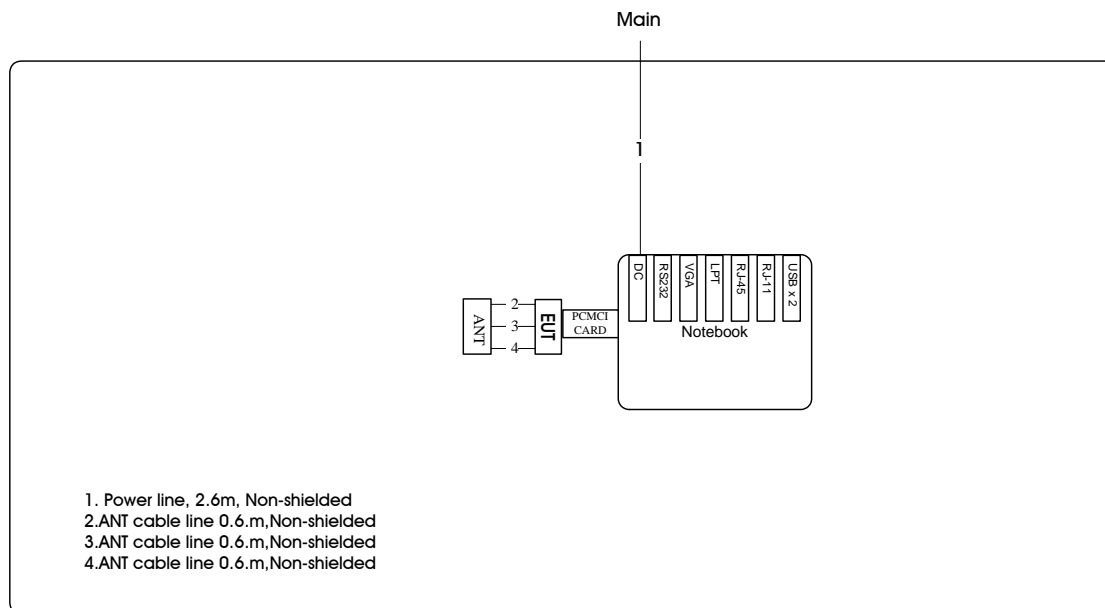

Antenna 5

Test configuration: 9kHz ~1GHz

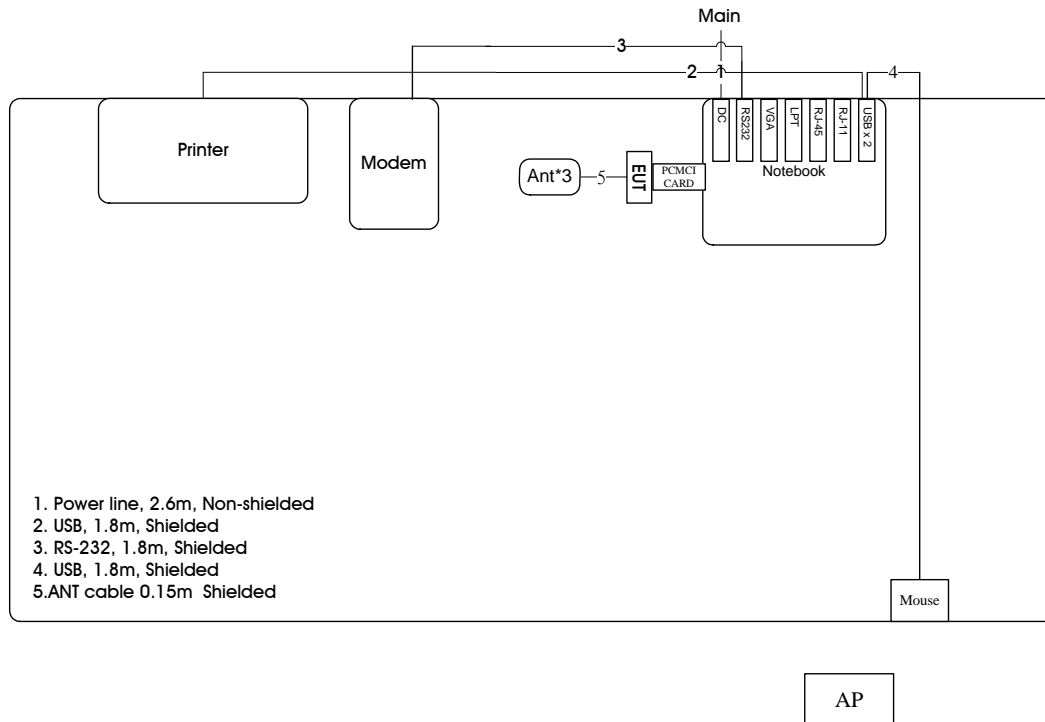

Test configuration: Above 1GHz

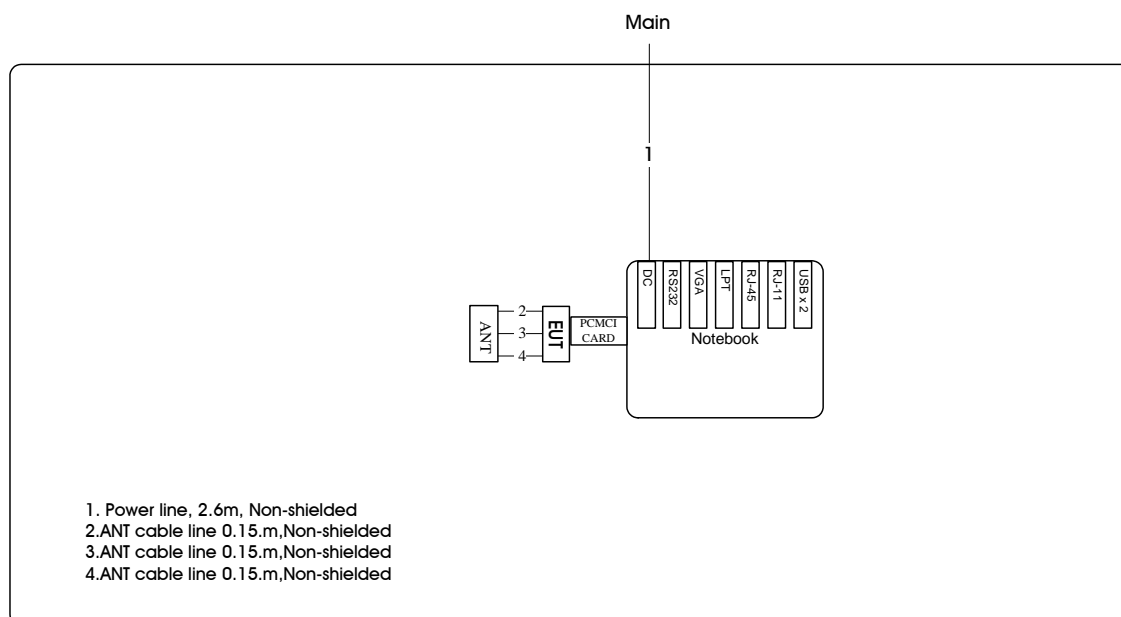

Antenna 6

Test configuration: 9kHz ~ 1GHz

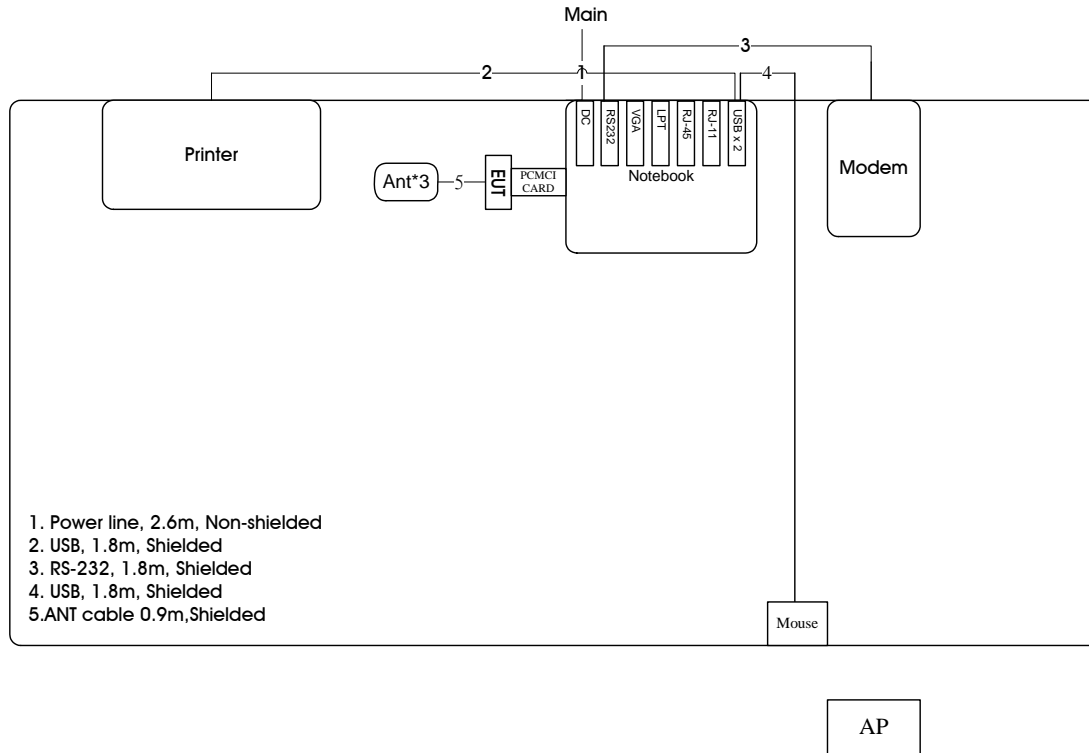

Test configuration: Above 1GHz

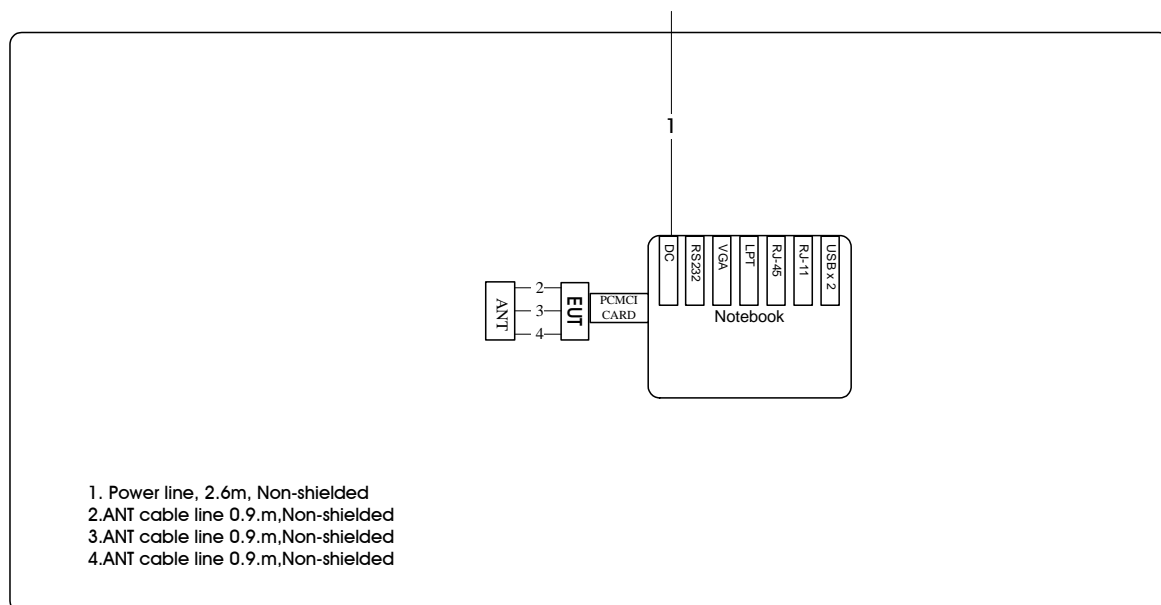

Antenna 7

Test configuration: 9kHz ~1GHz

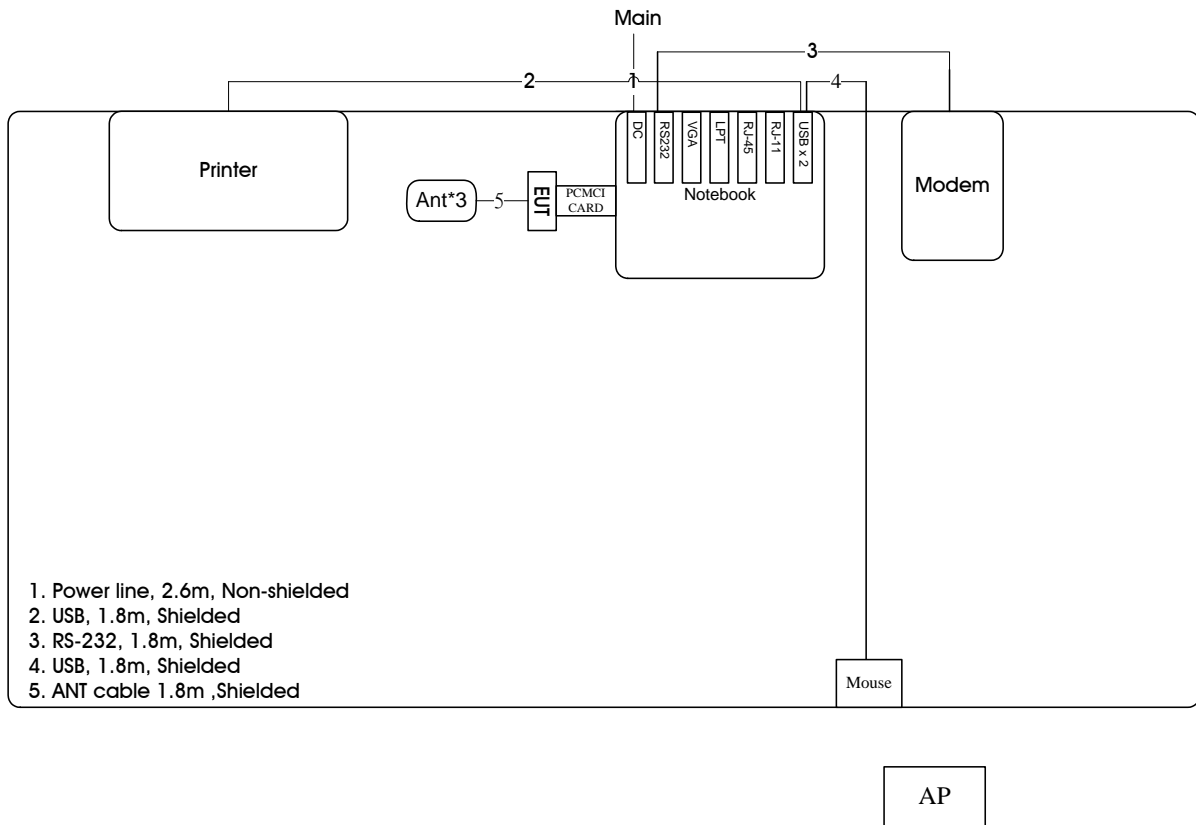

Test configuration: Above 1GHz

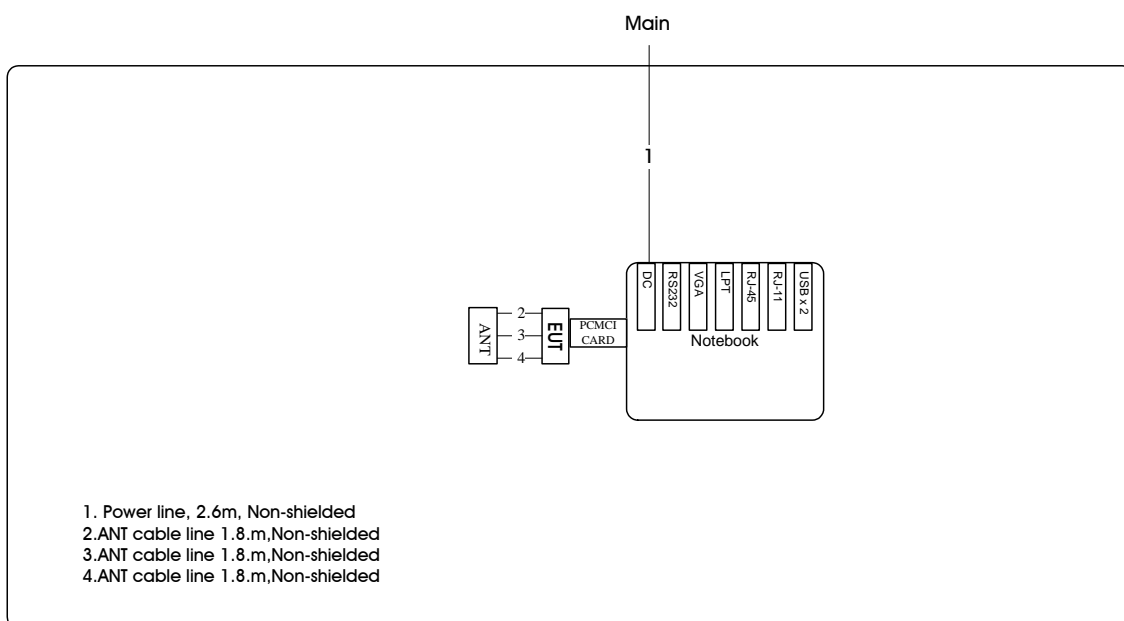

3.9.2. AC Power Line Conduction Emissions Test Configuration

Antenna 1

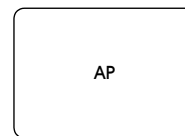
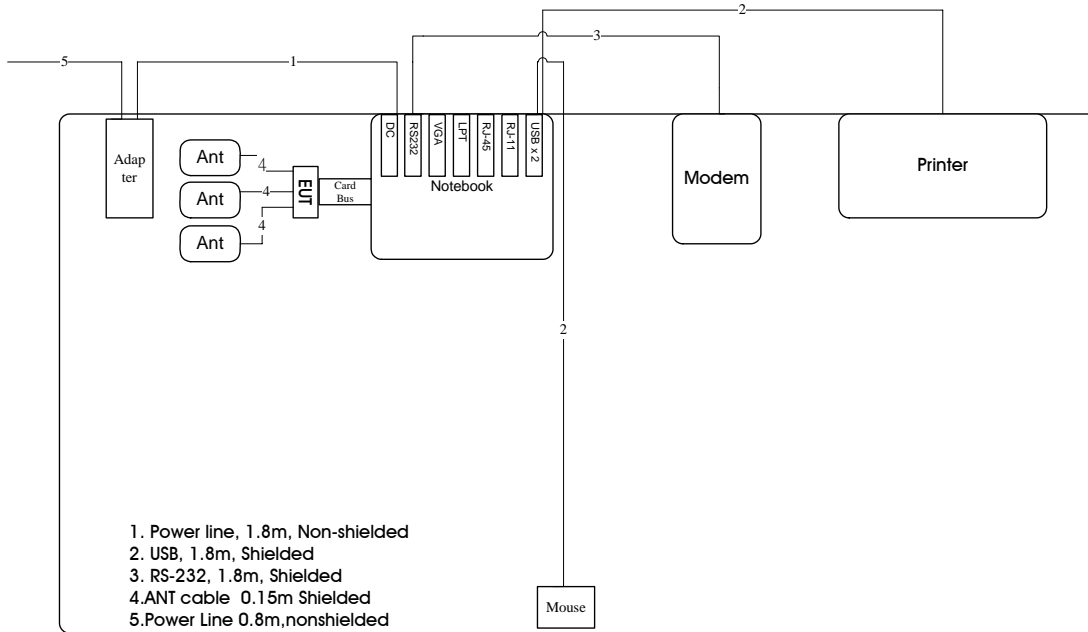

Antenna 2

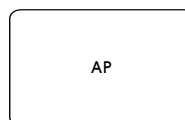
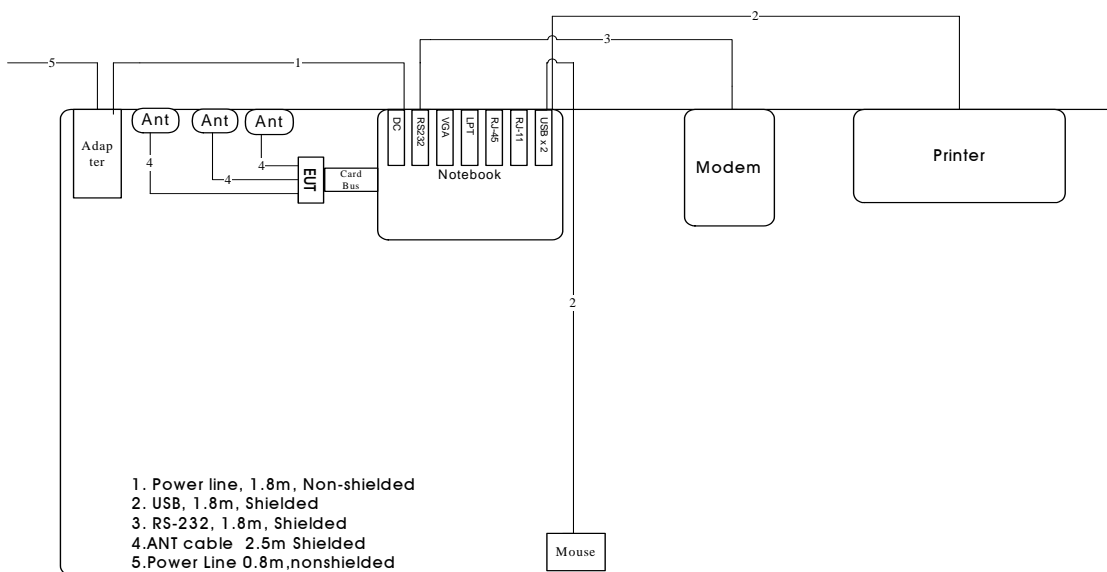

Antenna 3

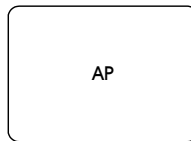
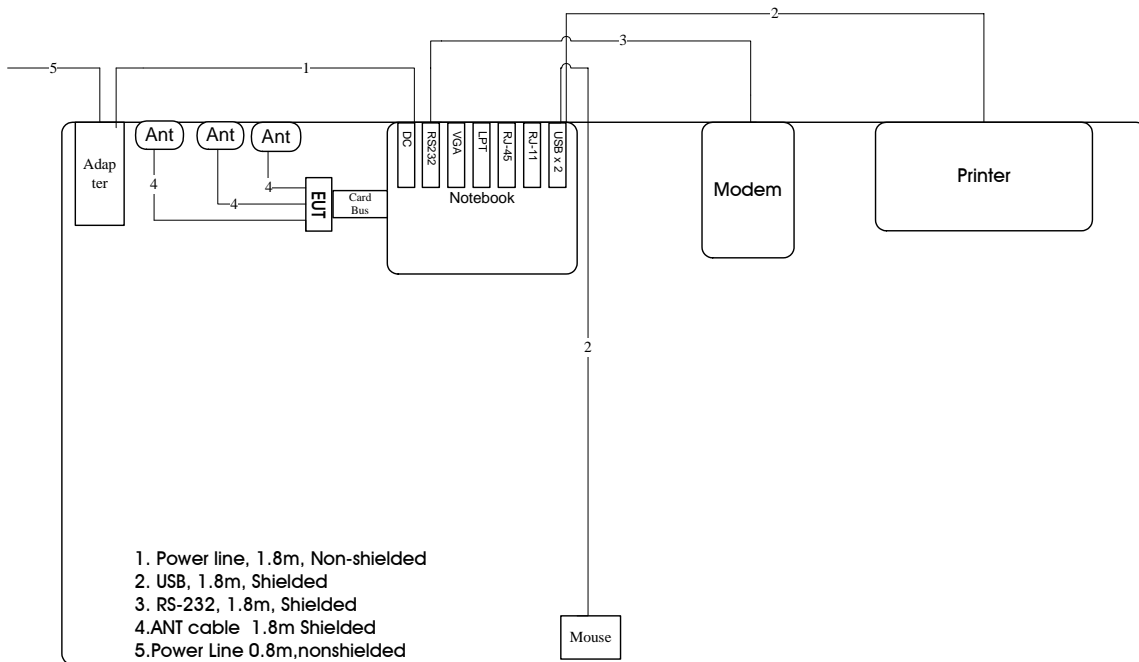

Antenna 4

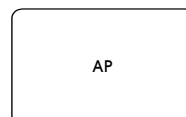
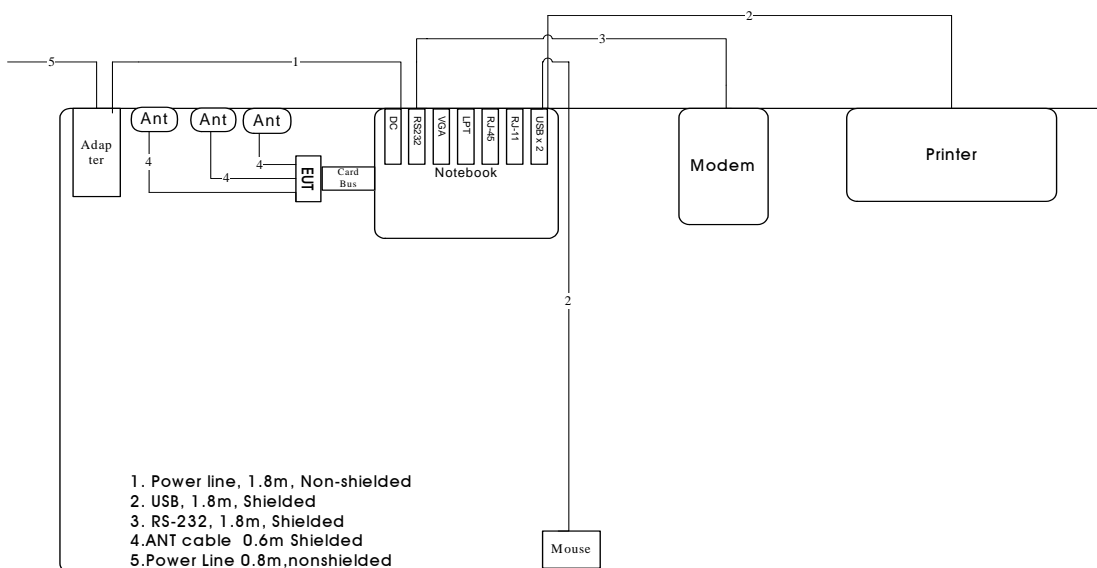

Antenna 5

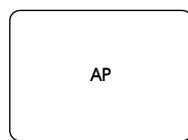
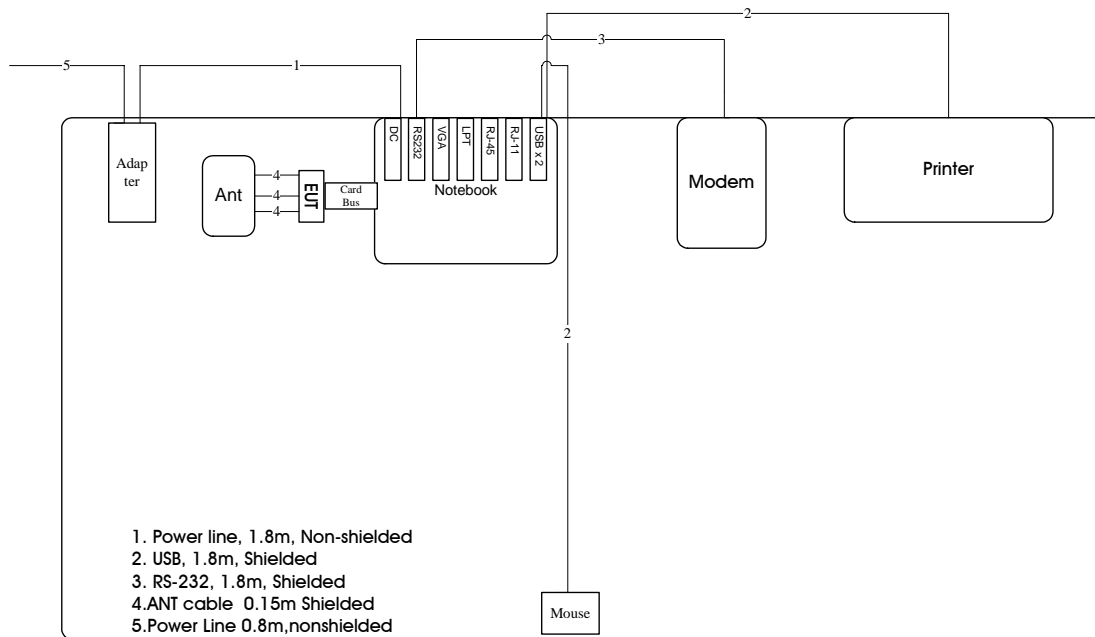

Antenna 6

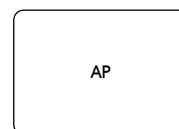
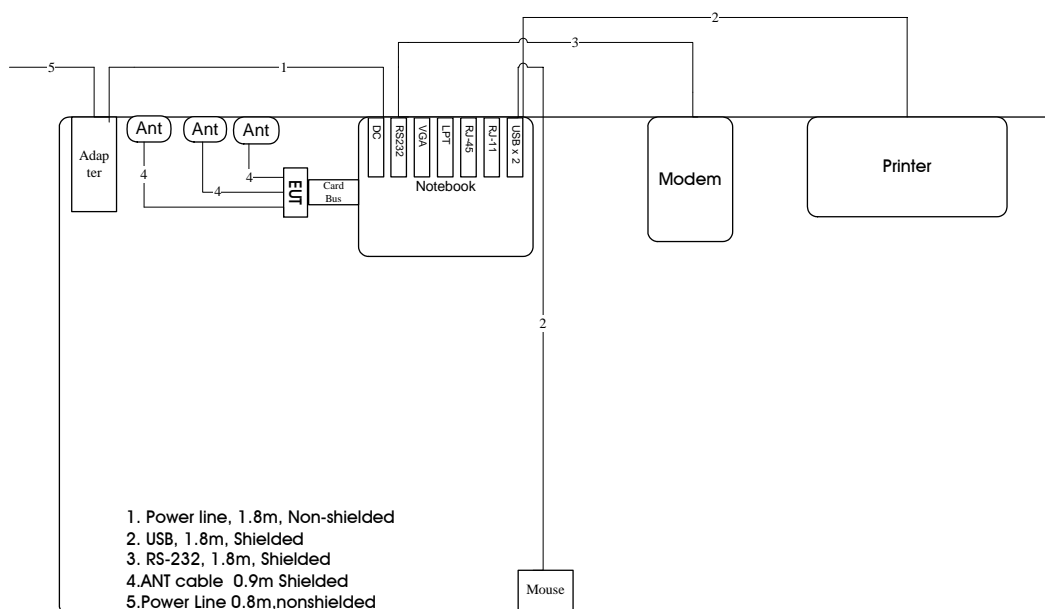

Antenna 7

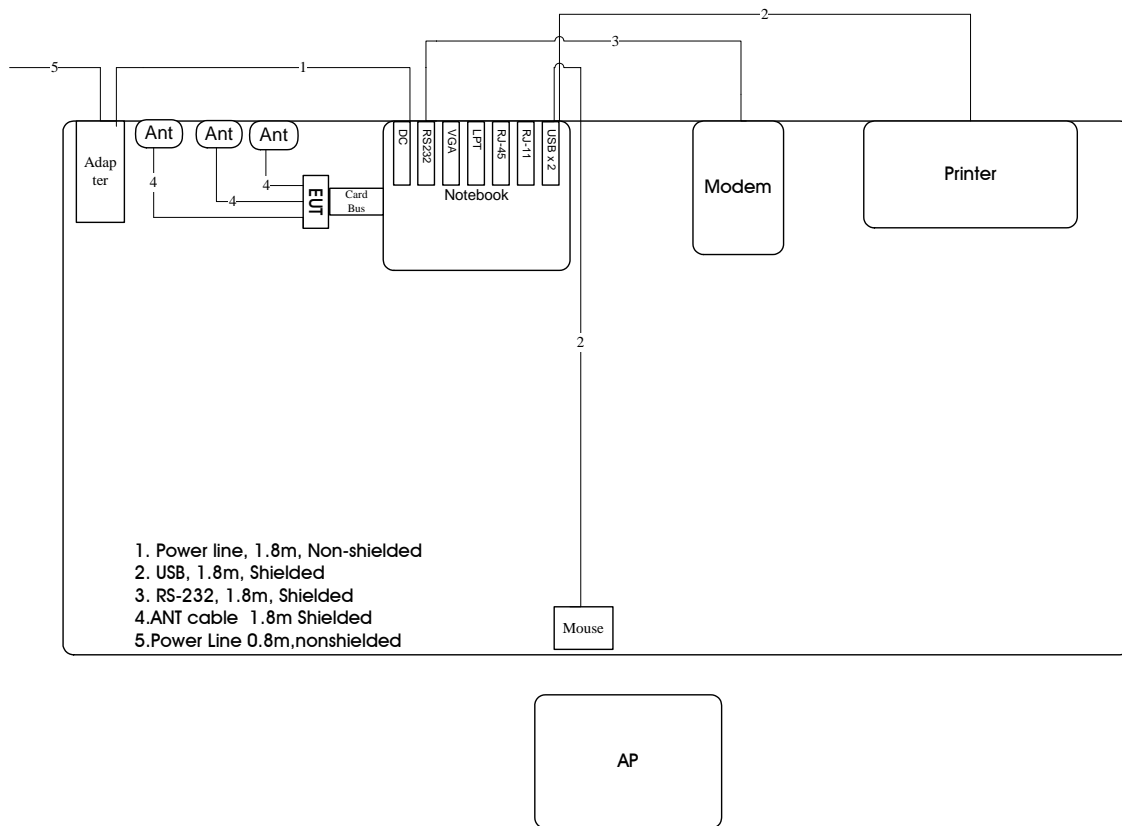

4. TEST RESULT

4.1. AC Power Line Conducted Emissions Measurement

4.1.1. Limit

For this product which is designed to be connected to the AC power line, the radio frequency voltage that is conducted back onto the AC power line on any frequency or frequencies within the band 150 kHz to 30 MHz shall not exceed below limits table.

Frequency (MHz)	QP Limit (dBuV)	AV Limit (dBuV)
0.15~0.5	66~56	56~46
0.5~5	56	46
5~30	60	50

4.1.2. Measuring Instruments and Setting

Please refer to section 5 of equipments list in this report. The following table is the setting of the receiver.

Receiver Parameters	Setting
Attenuation	10 dB
Start Frequency	0.15 MHz
Stop Frequency	30 MHz
IF Bandwidth	9 KHz

4.1.3. Test Procedures

1. Configure the EUT according to ANSI C63.4. The EUT or host of EUT has to be placed 0.4 meter far from the conducting wall of the shielding room and at least 80 centimeters from any other grounded conducting surface.
2. Connect EUT or host of EUT to the power mains through a line impedance stabilization network (LISN).
3. All the support units are connected to the other LISNs. The LISN should provide 50uH/50ohms coupling impedance.
4. The frequency range from 150 KHz to 30 MHz was searched.
5. Set the test-receiver system to Peak Detect Function and Specified Bandwidth with Maximum Hold Mode.
6. The measurement has to be done between each power line and ground at the power terminal.

4.1.4. Test Setup Layout

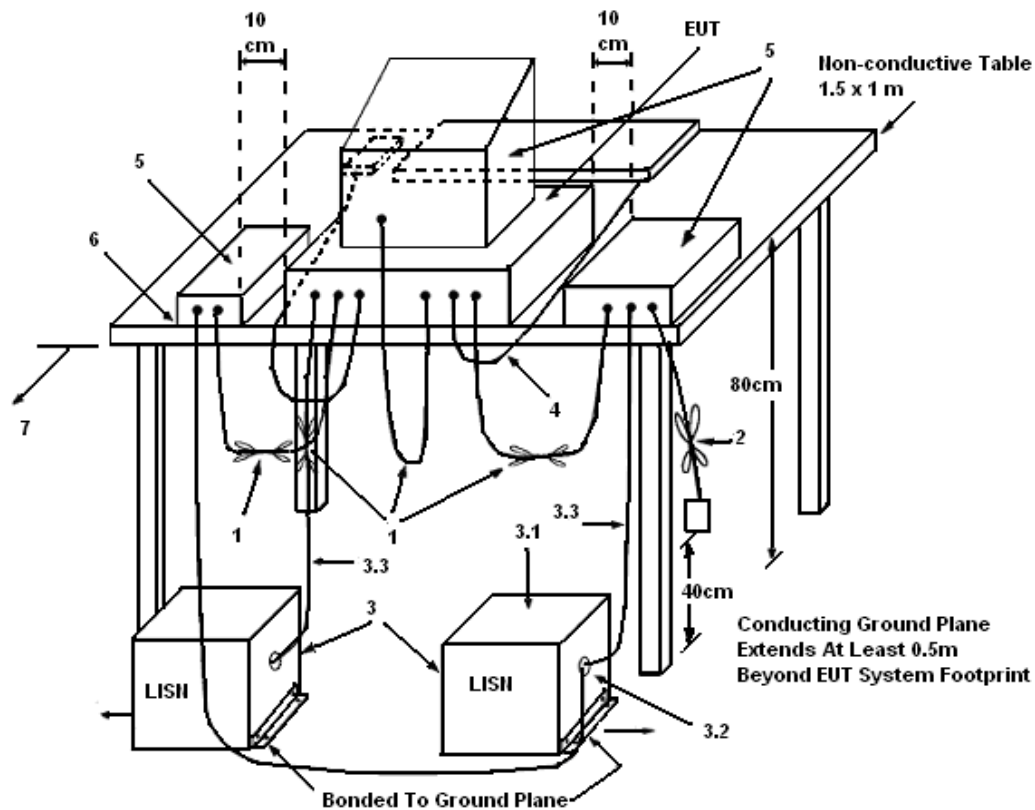

LEGEND:

- (1) Interconnecting cables that hang closer than 40 cm to the ground plane shall be folded back and forth in the center forming a bundle 30 to 40 cm long.
- (2) I/O cables that are not connected to a peripheral shall be bundled in the center. The end of the cable may be terminated, if required, using the correct terminating impedance. The overall length shall not exceed 1 m.
- (3) EUT connected to one LISN. Unused LISN measuring port connectors shall be terminated in 50 Ω. LISN can be placed on top of, or immediately beneath, reference ground plane.
 - (3.1) All other equipment powered from additional LISN(s).
 - (3.2) Multiple outlet strip can be used for multiple power cords of non-EUT equipment.
 - (3.3) LISN at least 80 cm from nearest part of EUT chassis.
- (4) Cables of hand-operated devices, such as keyboards, mice, etc., shall be placed as for normal use.
- (5) Non-EUT components of EUT system being tested.
- (6) Rear of EUT, including peripherals, shall all be aligned and flush with rear of tabletop.
- (7) Rear of tabletop shall be 40 cm removed from a vertical conducting plane that is bonded to the ground plane.

4.1.5. Test Deviation

There is no deviation with the original standard.

4.1.6. EUT Operation during Test

The EUT was placed on the test table and programmed in normal function.

4.1.7. Results of AC Power Line Conducted Emissions Measurement

Temperature	25°C	Humidity	43%
Test Engineer	Cloud Peng	Phase	Line
Configuration	Antenna 1		

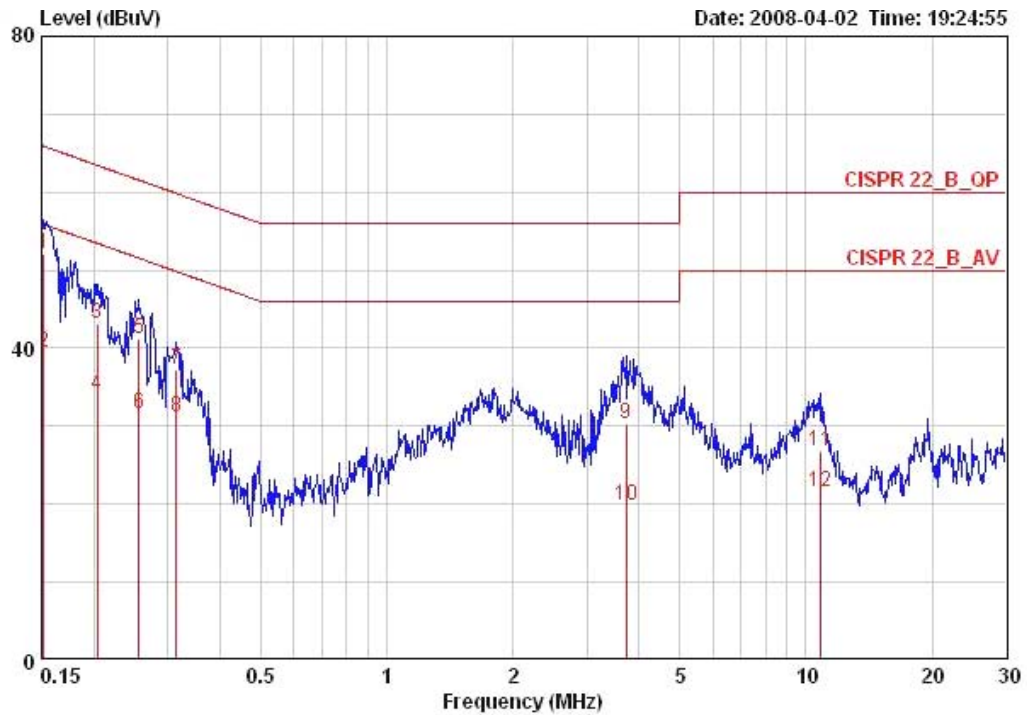

	Freq	Level	Over	Limit	Read	LISN	Cable	
	MHz	dBuV	Limit	Line	Level	Factor	Loss	Remark
			dB	dBuV	dBuV	dB	dB	
1	0.15160	52.13	-13.78	65.91	51.73	0.20	0.20	QP
2	0.15160	39.50	-16.41	55.91	39.10	0.20	0.20	AVERAGE
3	0.20396	43.15	-20.30	63.45	42.85	0.10	0.20	QP
4	0.20396	33.91	-19.54	53.45	33.61	0.10	0.20	AVERAGE
5	0.25615	41.14	-20.42	61.56	40.84	0.10	0.20	QP
6	0.25615	31.69	-19.87	51.56	31.39	0.10	0.20	AVERAGE
7	0.31495	37.28	-22.56	59.84	36.98	0.10	0.20	QP
8	0.31495	31.09	-18.75	49.84	30.79	0.10	0.20	AVERAGE
9	3.720	30.26	-25.74	56.00	29.96	0.00	0.30	QP
10	3.720	19.94	-26.06	46.00	19.64	0.00	0.30	AVERAGE
11	10.847	26.82	-33.18	60.00	26.32	0.10	0.40	QP
12	10.847	21.61	-28.39	50.00	21.11	0.10	0.40	AVERAGE

Temperature	25°C	Humidity	43%
Test Engineer	Cloud Peng	Phase	Neutral
Configuration	Antenna 1		

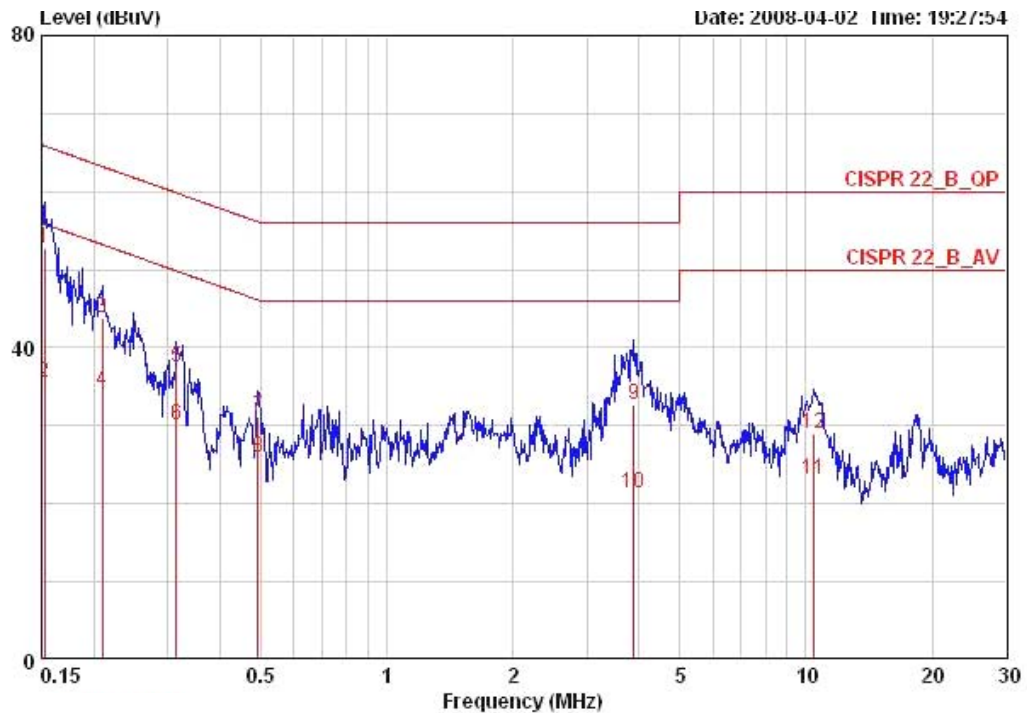

	Freq	Level	Over	Limit	Read	LISN	Cable	Remark
	MHz	dBuV	Limit	Line	Level	Factor	Loss	
			dB	dBuV	dBuV	dB	dB	
1	0.15240	52.77	-13.10	65.87	52.27	0.30	0.20	QP
2	0.15240	35.45	-20.42	55.87	34.95	0.30	0.20	AVERAGE
3	0.20944	43.71	-19.52	63.23	43.31	0.20	0.20	QP
4	0.20944	34.46	-18.77	53.23	34.06	0.20	0.20	AVERAGE
5	0.31495	37.45	-22.39	59.84	37.12	0.13	0.20	QP
6	0.31495	30.13	-19.71	49.84	29.80	0.13	0.20	AVERAGE
7	0.49150	31.09	-25.06	56.14	30.86	0.10	0.13	QP
8	0.49150	25.87	-20.28	46.14	25.64	0.10	0.13	AVERAGE
9	3.881	32.69	-23.31	56.00	32.29	0.10	0.30	QP
10	3.881	21.32	-24.68	46.00	20.92	0.10	0.30	AVERAGE
11	10.397	23.08	-26.92	50.00	22.60	0.10	0.38	AVERAGE
12	10.397	29.10	-30.90	60.00	28.62	0.10	0.38	QP

Note:

Level = Read Level + LISN Factor + Cable Loss.

Temperature	25°C	Humidity	43%
Test Engineer	Cloud Peng	Phase	Line
Configuration	Antenna 2		

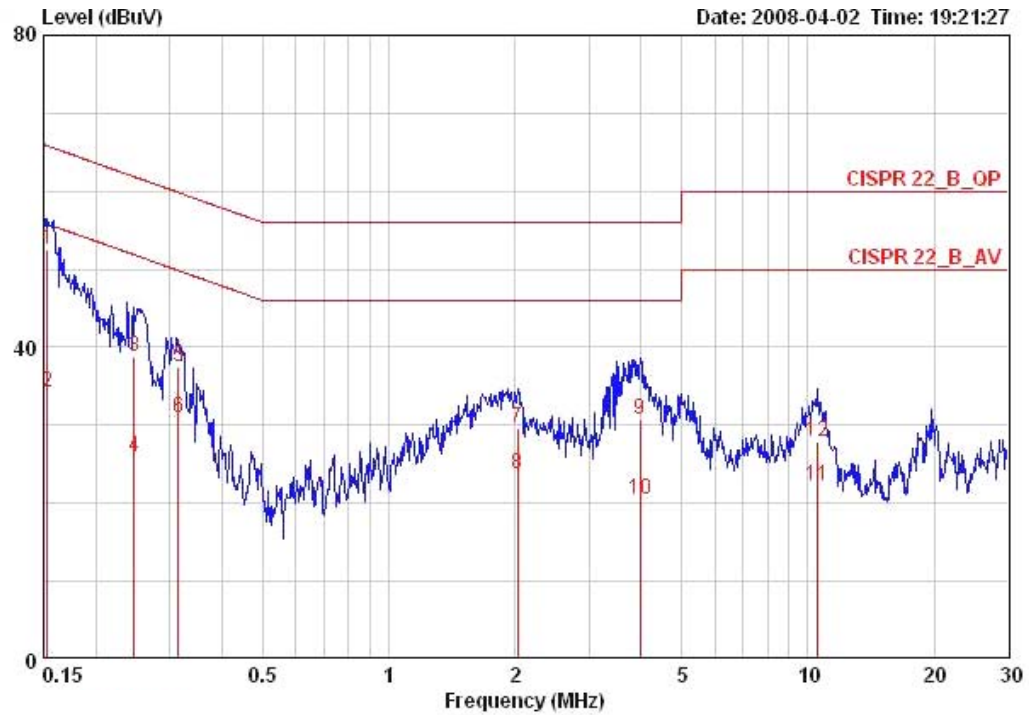

	Freq	Level	Over	Limit	Read	LISN	Cable	
	MHz	dBuV	Limit	Line	Level	Factor	Loss	Remark
			dB	dBuV	dBuV	dB	dB	
1	0.15321	52.60	-13.22	65.82	52.20	0.20	0.20	QP
2	0.15321	34.21	-21.61	55.82	33.81	0.20	0.20	AVERAGE
3	0.24682	38.77	-23.09	61.86	38.47	0.10	0.20	QP
4	0.24682	26.01	-25.85	51.86	25.71	0.10	0.20	AVERAGE
5	0.31495	37.40	-22.44	59.84	37.10	0.10	0.20	QP
6	0.31495	30.87	-18.97	49.84	30.57	0.10	0.20	AVERAGE
7	2.033	29.66	-26.34	56.00	29.46	0.00	0.20	QP
8	2.033	23.73	-22.27	46.00	23.53	0.00	0.20	AVERAGE
9	3.985	30.81	-25.19	56.00	30.51	0.00	0.30	QP
10	3.985	20.45	-25.55	46.00	20.15	0.00	0.30	AVERAGE
11	10.564	22.19	-27.81	50.00	21.69	0.10	0.40	AVERAGE
12	10.564	27.96	-32.04	60.00	27.46	0.10	0.40	QP

Temperature	25°C	Humidity	43%
Test Engineer	Cloud Peng	Phase	Neutral
Configuration	Antenna 2		

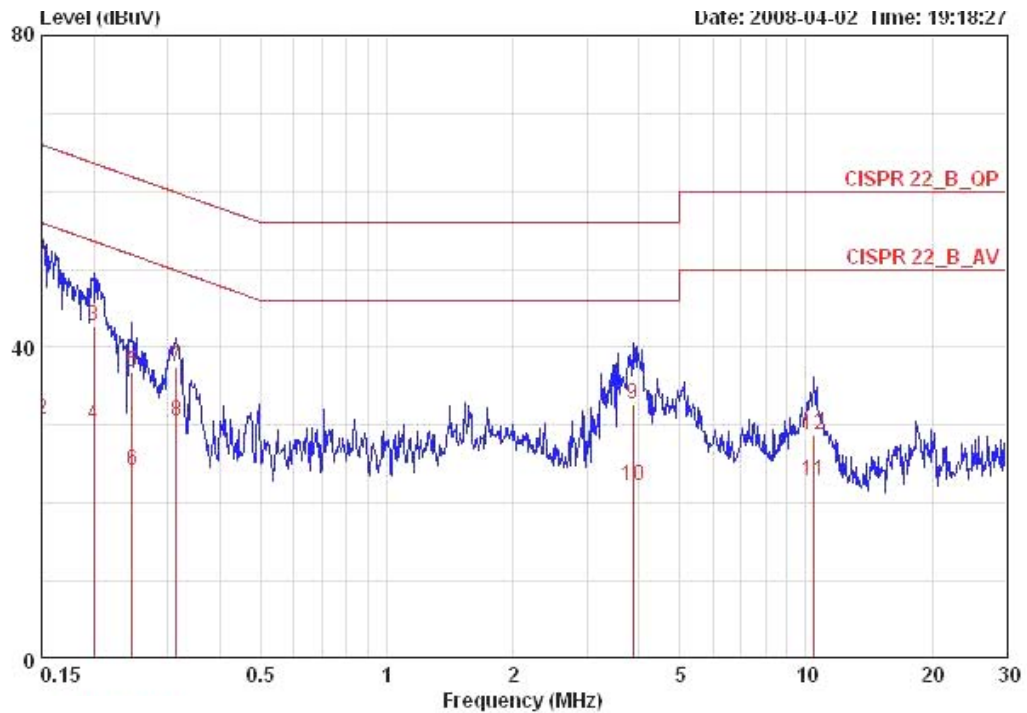

	Freq	Level	Over Limit	Limit Line	Read Level	LISN Factor	Cable Loss	Remark
	MHz	dBuV	dB	dBuV	dBuV	dB	dB	
1	0.15000	51.93	-14.07	66.00	51.43	0.30	0.20	QP
2	0.15000	30.80	-25.20	56.00	30.30	0.30	0.20	AVERAGE
3	0.19969	42.66	-20.96	63.62	42.26	0.20	0.20	QP
4	0.19969	29.99	-23.63	53.62	29.59	0.20	0.20	AVERAGE
5	0.24682	36.77	-25.09	61.86	36.39	0.18	0.20	QP
6	0.24682	24.12	-27.74	51.86	23.74	0.18	0.20	AVERAGE
7	0.31495	37.47	-22.37	59.84	37.14	0.13	0.20	QP
8	0.31495	30.43	-19.41	49.84	30.10	0.13	0.20	AVERAGE
9	3.860	32.68	-23.32	56.00	32.28	0.10	0.30	QP
10	3.860	22.22	-23.78	46.00	21.82	0.10	0.30	AVERAGE
11	10.452	22.87	-27.13	50.00	22.38	0.10	0.39	AVERAGE
12	10.452	28.75	-31.25	60.00	28.26	0.10	0.39	QP

Note:

Level = Read Level + LISN Factor + Cable Loss.

Temperature	25°C	Humidity	43%
Test Engineer	Cloud Peng	Phase	Line
Configuration	Antenna 3		

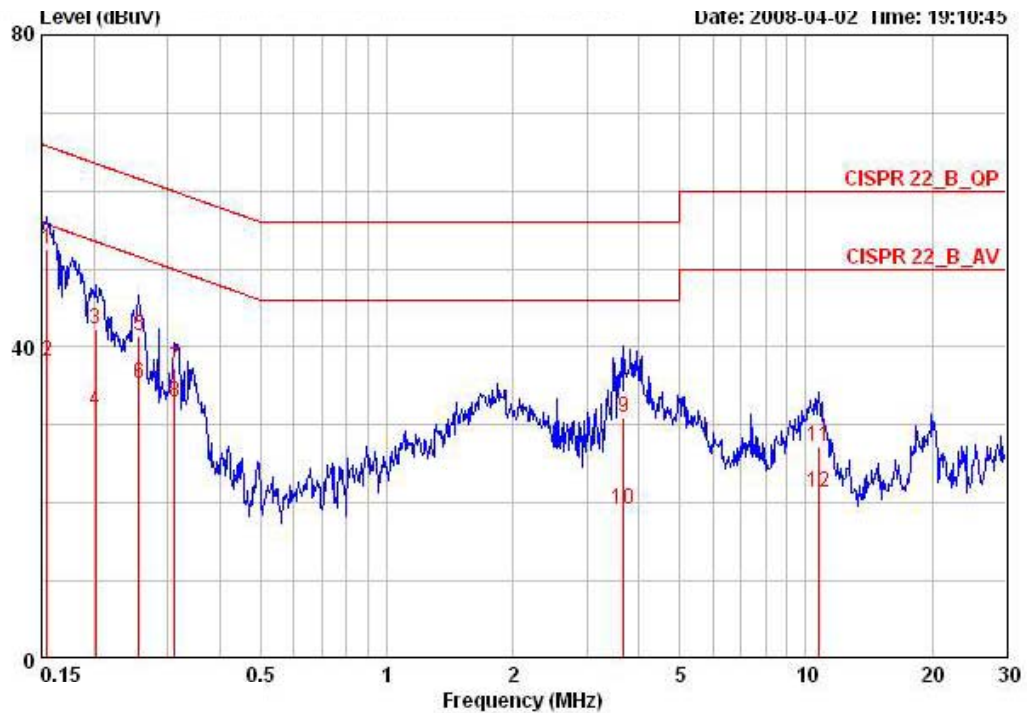

	Freq	Level	Over	Limit	Read	LISN	Cable	
	MHz	dBuV	Limit	Line	Level	Factor	Loss	Remark
			dB	dBuV	dBuV	dB	dB	
1	0.15485	52.60	-13.14	65.74	52.20	0.20	0.20	QP
2	0.15485	38.10	-17.64	55.74	37.70	0.20	0.20	AVERAGE
3	0.20181	42.20	-21.34	63.54	41.90	0.10	0.20	QP
4	0.20181	31.92	-21.62	53.54	31.62	0.10	0.20	AVERAGE
5	0.25615	41.34	-20.22	61.56	41.04	0.10	0.20	QP
6	0.25615	35.31	-16.25	51.56	35.01	0.10	0.20	AVERAGE
7	0.31163	37.36	-22.57	59.93	37.06	0.10	0.20	QP
8	0.31163	32.99	-16.94	49.93	32.69	0.10	0.20	AVERAGE
9	3.681	31.02	-24.98	56.00	30.72	0.00	0.30	QP
10	3.681	19.29	-26.71	46.00	18.99	0.00	0.30	AVERAGE
11	10.733	27.23	-32.77	60.00	26.73	0.10	0.40	QP
12	10.733	21.35	-28.65	50.00	20.85	0.10	0.40	AVERAGE

Temperature	25°C	Humidity	43%
Test Engineer	Cloud Peng	Phase	Neutral
Configuration	Antenna 3		

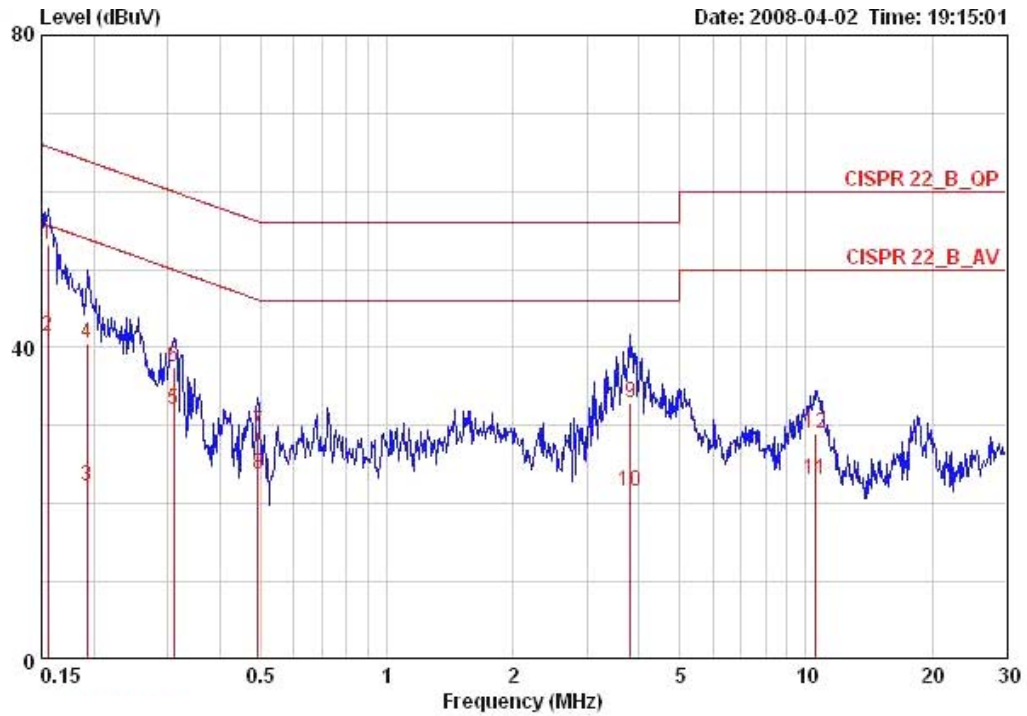

	Freq	Level	Over	Limit	Read	LISN	Cable	Remark
	MHz	dBuV	Limit	Line	Level	Factor	Loss	
			dB	dBuV	dBuV	dB	dB	
1	0.15567	53.19	-12.50	65.69	52.69	0.30	0.20	QP
2	0.15567	41.36	-14.33	55.69	40.86	0.30	0.20	AVERAGE
3	0.19242	22.21	-31.72	53.93	21.76	0.25	0.20	AVERAGE
4	0.19242	40.56	-23.37	63.93	40.11	0.25	0.20	QP
5	0.30998	32.05	-17.92	49.97	31.70	0.15	0.20	AVERAGE
6	0.30998	37.40	-22.57	59.97	37.05	0.15	0.20	QP
7	0.49150	29.17	-26.98	56.14	28.94	0.10	0.13	QP
8	0.49150	23.66	-22.49	46.14	23.43	0.10	0.13	AVERAGE
9	3.820	32.90	-23.10	56.00	32.50	0.10	0.30	QP
10	3.820	21.51	-24.49	46.00	21.11	0.10	0.30	AVERAGE
11	10.508	23.02	-26.98	50.00	22.52	0.10	0.40	AVERAGE
12	10.508	28.95	-31.05	60.00	28.45	0.10	0.40	QP

Note:

Level = Read Level + LISN Factor + Cable Loss.

Temperature	25°C	Humidity	43%
Test Engineer	Cloud Peng	Phase	Line
Configuration	Antenna 4		

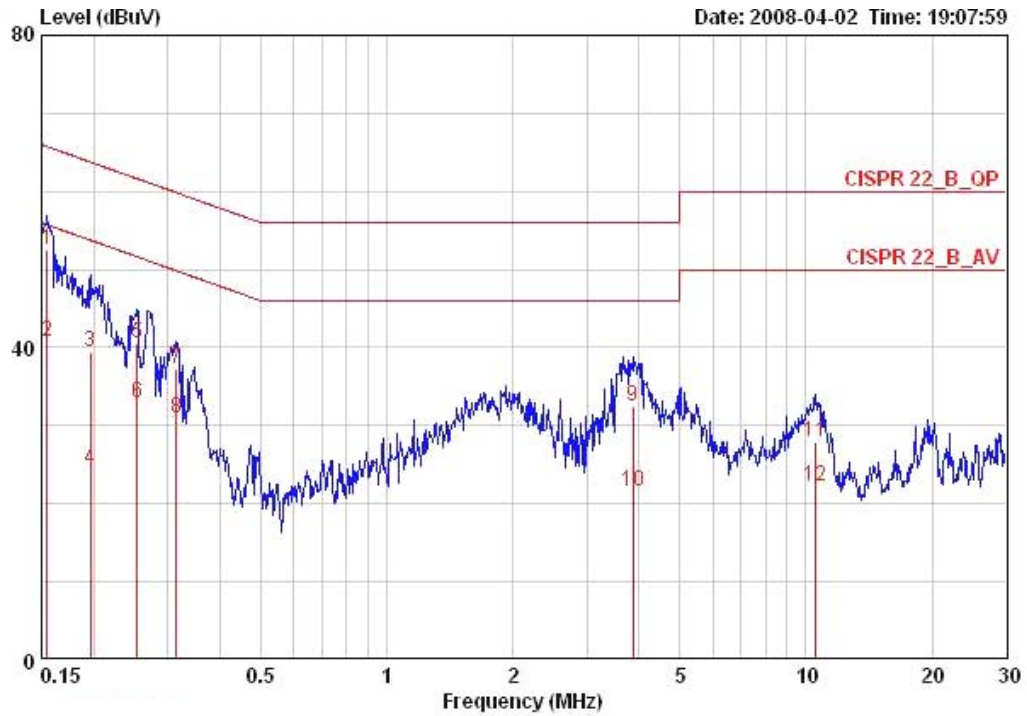

	Freq	Level	Over	Limit	Read	LISN	Cable	Remark
	MHz	dBuV	Limit	Line	Level	Factor	Loss	
			dB	dBuV	dBuV	dB	dB	
1	0.15485	52.50	-13.24	65.74	52.10	0.20	0.20	QP
2	0.15485	40.79	-14.95	55.74	40.39	0.20	0.20	AVERAGE
3	0.19654	39.53	-24.23	63.76	39.23	0.10	0.20	QP
4	0.19654	24.51	-29.25	53.76	24.21	0.10	0.20	AVERAGE
5	0.25345	40.54	-21.10	61.64	40.24	0.10	0.20	QP
6	0.25345	32.97	-18.67	51.64	32.67	0.10	0.20	AVERAGE
7	0.31495	37.38	-22.46	59.84	37.08	0.10	0.20	QP
8	0.31495	31.03	-18.81	49.84	30.73	0.10	0.20	AVERAGE
9	3.860	32.40	-23.60	56.00	32.10	0.00	0.30	QP
10	3.860	21.67	-24.33	46.00	21.37	0.00	0.30	AVERAGE
11	10.564	27.92	-32.08	60.00	27.42	0.10	0.40	QP
12	10.564	22.24	-27.76	50.00	21.74	0.10	0.40	AVERAGE

Temperature	25°C	Humidity	43%
Test Engineer	Cloud Peng	Phase	Neutral
Configuration	Antenna 4		

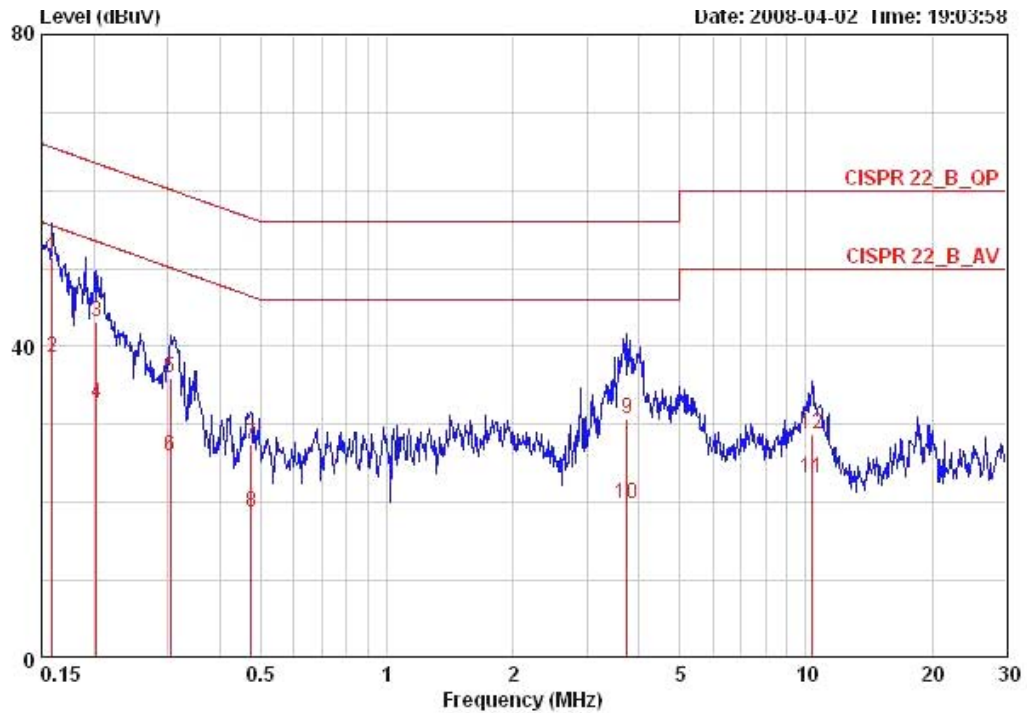

	Freq	Level	Over Limit	Limit Line	Read Level	LISN Factor	Cable Loss	Remark
	MHz	dBuV	dB	dBuV	dBuV	dB	dB	
1	0.15900	51.37	-14.15	65.52	50.87	0.30	0.20	QP
2	0.15900	38.58	-16.94	55.52	38.08	0.30	0.20	AVERAGE
3	0.20289	43.23	-20.26	63.49	42.83	0.20	0.20	QP
4	0.20289	32.68	-20.81	53.49	32.28	0.20	0.20	AVERAGE
5	0.30509	36.07	-24.03	60.10	35.72	0.15	0.20	QP
6	0.30509	26.01	-24.09	50.10	25.66	0.15	0.20	AVERAGE
7	0.47360	27.44	-29.02	56.45	27.16	0.10	0.18	QP
8	0.47360	18.70	-27.76	46.45	18.42	0.10	0.18	AVERAGE
9	3.740	30.78	-25.22	56.00	30.38	0.10	0.30	QP
10	3.740	19.92	-26.08	46.00	19.52	0.10	0.30	AVERAGE
11	10.342	23.07	-26.93	50.00	22.60	0.10	0.37	AVERAGE
12	10.342	28.75	-31.25	60.00	28.28	0.10	0.37	QP

Note:

Level = Read Level + LISN Factor + Cable Loss.

Temperature	25°C	Humidity	43%
Test Engineer	Cloud Peng	Phase	Line
Configuration	Antenna 5		

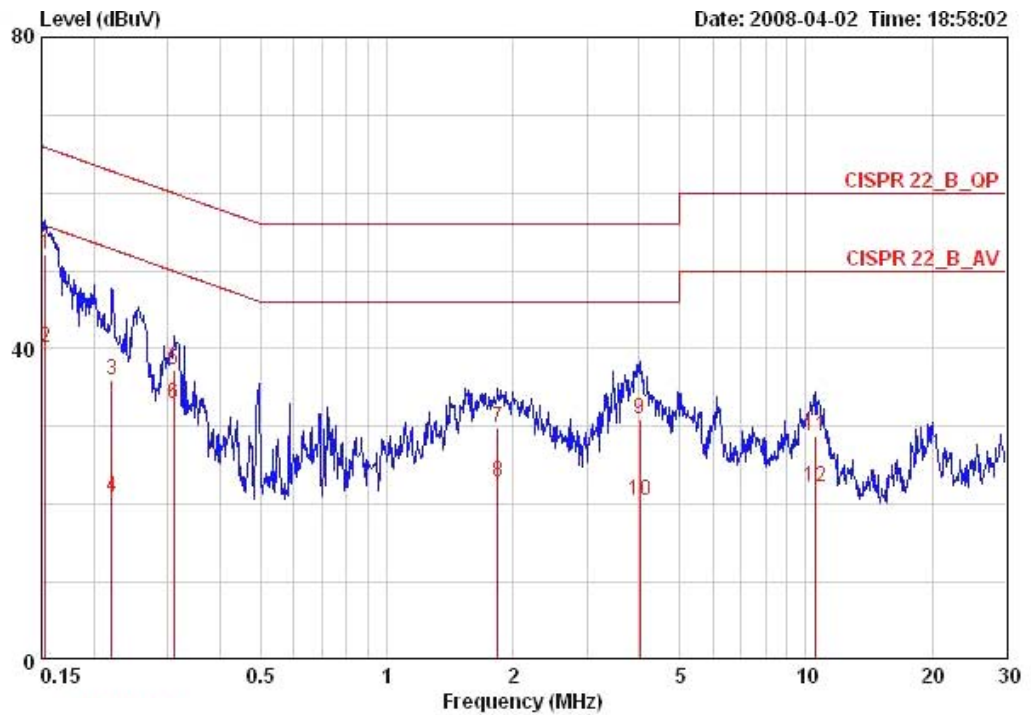

	Freq	Level	Over	Limit	Read	LISN	Cable	Remark
	MHz	dBuV	Limit	Line	Level	Factor	Loss	
			dB	dBuV	dBuV	dB	dB	
1	0.15321	52.12	-13.70	65.82	51.72	0.20	0.20	QP
2	0.15321	40.19	-15.63	55.82	39.79	0.20	0.20	AVERAGE
3	0.22083	36.04	-26.75	62.79	35.74	0.10	0.20	QP
4	0.22083	20.88	-31.91	52.79	20.58	0.10	0.20	AVERAGE
5	0.30998	37.25	-22.72	59.97	36.95	0.10	0.20	QP
6	0.30998	32.90	-17.07	49.97	32.60	0.10	0.20	AVERAGE
7	1.839	29.86	-26.14	56.00	29.69	0.00	0.17	QP
8	1.839	22.96	-23.04	46.00	22.79	0.00	0.17	AVERAGE
9	4.006	30.90	-25.10	56.00	30.60	0.00	0.30	QP
10	4.006	20.40	-25.60	46.00	20.10	0.00	0.30	AVERAGE
11	10.564	28.67	-31.33	60.00	28.17	0.10	0.40	QP
12	10.564	22.30	-27.70	50.00	21.80	0.10	0.40	AVERAGE

Temperature	25°C	Humidity	43%
Test Engineer	Cloud Peng	Phase	Neutral
Configuration	Antenna 5		

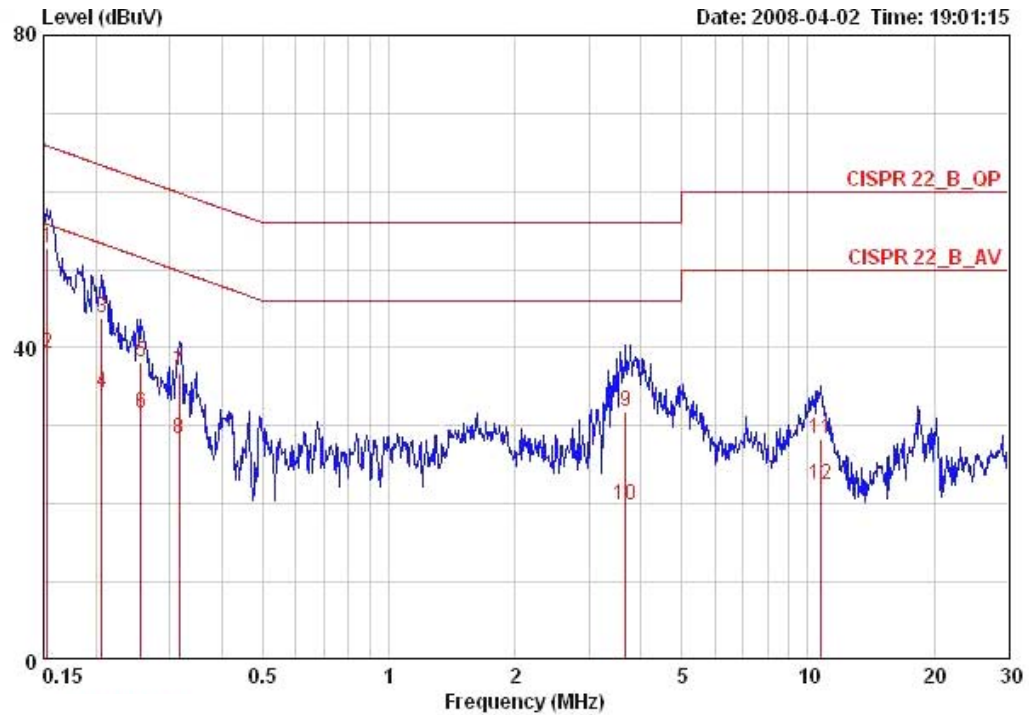

	Freq	Level	Over Limit	Limit Line	Read Level	LISN Factor	Cable Loss	Remark
	MHz	dBuV	dB	dBuV	dBuV	dB	dB	
1	0.15321	52.82	-13.00	65.82	52.32	0.30	0.20	QP
2	0.15321	39.24	-16.58	55.82	38.74	0.30	0.20	AVERAGE
3	0.20614	43.81	-19.55	63.36	43.41	0.20	0.20	QP
4	0.20614	34.31	-19.05	53.36	33.91	0.20	0.20	AVERAGE
5	0.25615	38.12	-23.44	61.56	37.75	0.17	0.20	QP
6	0.25615	31.71	-19.85	51.56	31.34	0.17	0.20	AVERAGE
7	0.31662	36.74	-23.05	59.80	36.41	0.13	0.20	QP
8	0.31662	28.37	-21.42	49.80	28.04	0.13	0.20	AVERAGE
9	3.681	31.77	-24.23	56.00	31.37	0.10	0.30	QP
10	3.681	19.89	-26.11	46.00	19.49	0.10	0.30	AVERAGE
11	10.733	28.23	-31.77	60.00	27.73	0.10	0.40	QP
12	10.733	22.45	-27.55	50.00	21.95	0.10	0.40	AVERAGE

Note:

Level = Read Level + LISN Factor + Cable Loss.

Temperature	25°C	Humidity	43%
Test Engineer	Cloud Peng	Phase	Line
Configuration	Antenna 6		

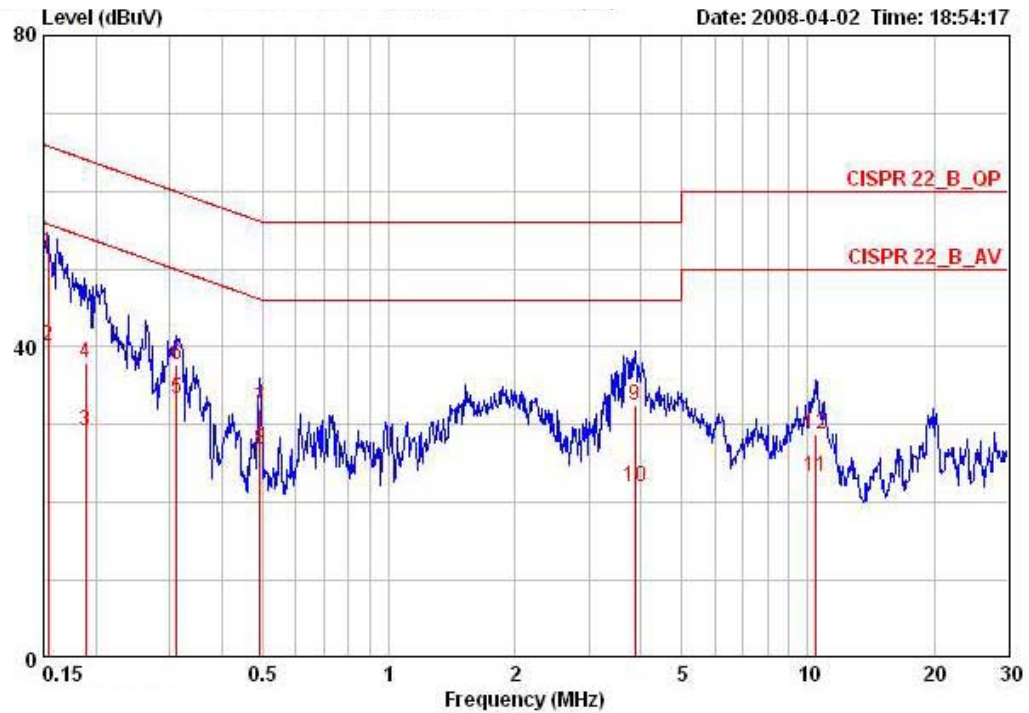

	Freq	Level	Over	Limit	Read	LISN	Cable	Remark
	MHz	dBuV	Limit	Line	Level	Factor	Loss	
			dB	dBuV	dBuV	dB	dB	
1	0.15403	52.10	-13.68	65.78	51.70	0.20	0.20	QP
2	0.15403	40.19	-15.59	55.78	39.79	0.20	0.20	AVERAGE
3	0.18938	29.12	-24.94	54.06	28.77	0.15	0.20	AVERAGE
4	0.18938	37.97	-26.09	64.06	37.62	0.15	0.20	QP
5	0.31163	33.42	-16.51	49.93	33.12	0.10	0.20	AVERAGE
6	0.31163	37.74	-22.19	59.93	37.44	0.10	0.20	QP
7	0.49150	31.94	-24.20	56.14	31.73	0.09	0.13	QP
8	0.49150	26.78	-19.36	46.14	26.57	0.09	0.13	AVERAGE
9	3.860	32.46	-23.54	56.00	32.16	0.00	0.30	QP
10	3.860	21.96	-24.04	46.00	21.66	0.00	0.30	AVERAGE
11	10.397	23.25	-26.75	50.00	22.77	0.10	0.38	AVERAGE
12	10.397	28.88	-31.12	60.00	28.40	0.10	0.38	QP

Temperature	25°C	Humidity	43%
Test Engineer	Cloud Peng	Phase	Neutral
Configuration	Antenna 6		

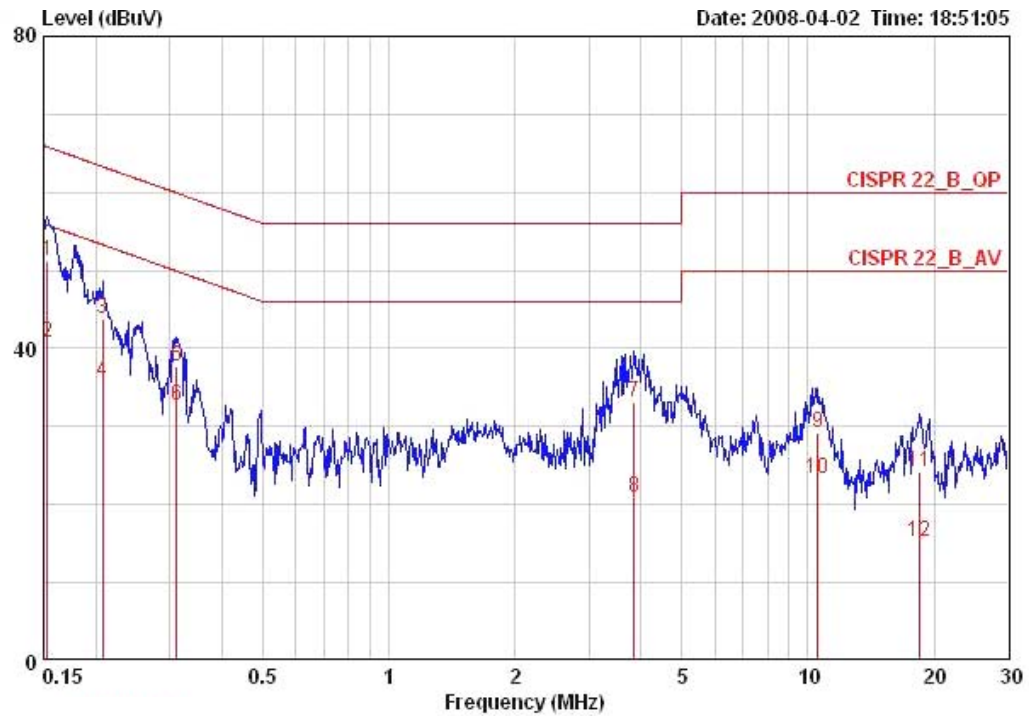

	Freq	Level	Over Limit	Limit Line	Read Level	LISN Factor	Cable Loss	Remark
	MHz	dBuV	dB	dBuV	dBuV	dB	dB	
1	0.15321	51.27	-14.55	65.82	50.77	0.30	0.20	QP
2	0.15321	40.82	-15.00	55.82	40.32	0.30	0.20	AVERAGE
3	0.20723	43.81	-19.51	63.32	43.41	0.20	0.20	QP
4	0.20723	35.82	-17.50	53.32	35.42	0.20	0.20	AVERAGE
5	0.31163	37.73	-22.20	59.93	37.38	0.15	0.20	QP
6	0.31163	32.77	-17.16	49.93	32.42	0.15	0.20	AVERAGE
7	3.840	33.09	-22.91	56.00	32.69	0.10	0.30	QP
8	3.840	20.99	-25.01	46.00	20.59	0.10	0.30	AVERAGE
9	10.564	29.27	-30.73	60.00	28.77	0.10	0.40	QP
10	10.564	23.28	-26.72	50.00	22.78	0.10	0.40	AVERAGE
11	18.524	24.20	-35.80	60.00	23.60	0.10	0.50	QP
12	18.524	15.31	-34.69	50.00	14.71	0.10	0.50	AVERAGE

Note:

Level = Read Level + LISN Factor + Cable Loss.

Temperature	25°C	Humidity	43%
Test Engineer	Cloud Peng	Phase	Line
Configuration	Antenna 7		

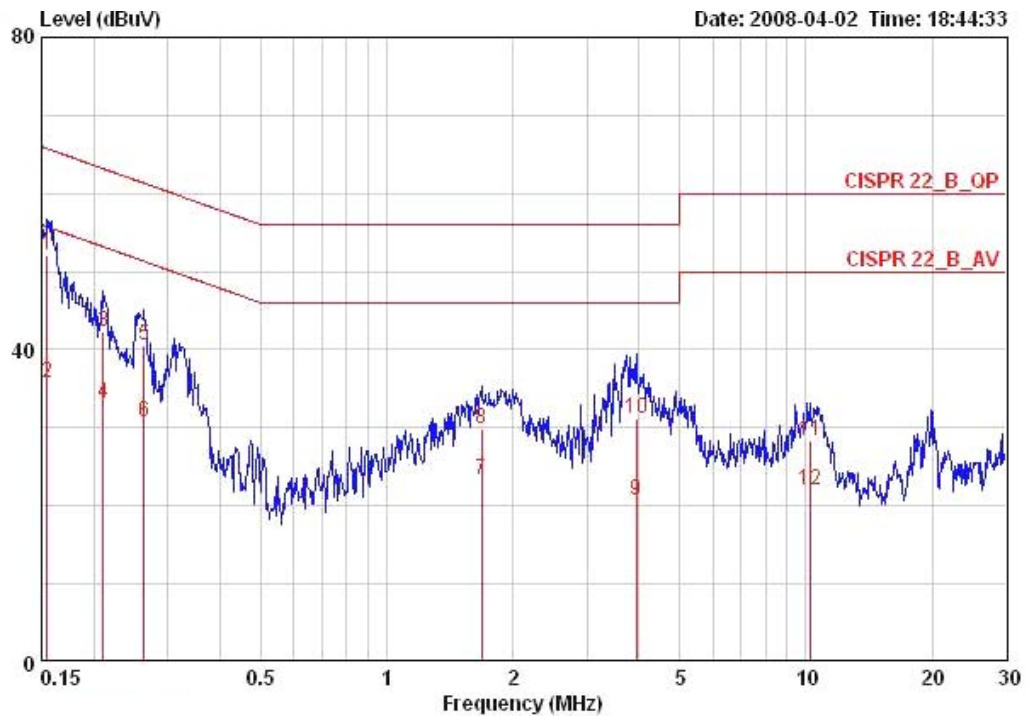

	Freq	Level	Over	Limit	Read	LISN	Cable	
	MHz	dBuV	Limit	Line	Level	Factor	Loss	Remark
			dB	dBuV	dBuV	dB	dB	
1	0.15485	52.18	-13.56	65.74	51.78	0.20	0.20	QP
2	0.15485	35.66	-20.08	55.74	35.26	0.20	0.20	AVERAGE
3	0.21055	42.30	-20.88	63.18	42.00	0.10	0.20	QP
4	0.21055	33.05	-20.13	53.18	32.75	0.10	0.20	AVERAGE
5	0.26303	40.46	-20.88	61.34	40.16	0.10	0.20	QP
6	0.26303	30.64	-20.70	51.34	30.34	0.10	0.20	AVERAGE
7	1.680	23.33	-22.67	46.00	23.19	0.00	0.14	AVERAGE
8	1.680	29.93	-26.07	56.00	29.79	0.00	0.14	QP
9	3.943	20.76	-25.24	46.00	20.46	0.00	0.30	AVERAGE
10	3.943	31.19	-24.81	56.00	30.89	0.00	0.30	QP
11	10.233	28.23	-31.77	60.00	27.79	0.10	0.34	QP
12	10.233	22.02	-27.98	50.00	21.58	0.10	0.34	AVERAGE

Temperature	25°C	Humidity	43%
Test Engineer	Cloud Peng	Phase	Neutral
Configuration	Antenna 7		

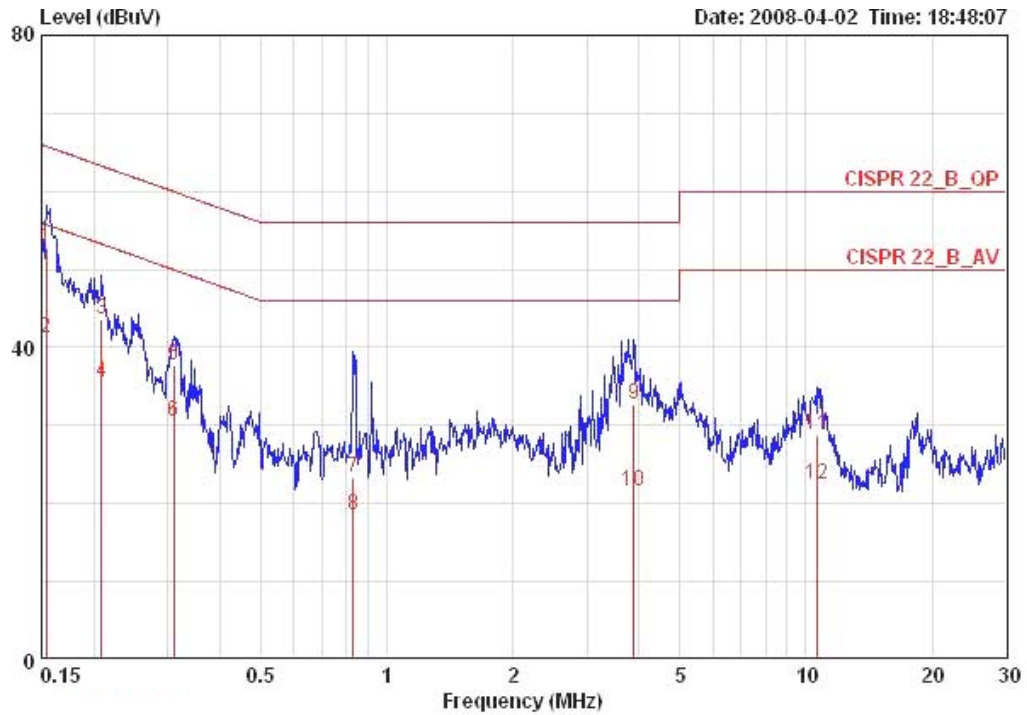

	Freq	Level	Over	Limit	Read	LISN	Cable	Remark
	MHz	dBuV	Limit	Line	Level	Factor	Loss	
			dB	dBuV	dBuV	dB	dB	
1	0.15403	52.72	-13.06	65.78	52.22	0.30	0.20	QP
2	0.15403	41.17	-14.61	55.78	40.67	0.30	0.20	AVERAGE
3	0.20833	43.59	-19.68	63.27	43.19	0.20	0.20	QP
4	0.20833	35.61	-17.66	53.27	35.21	0.20	0.20	AVERAGE
5	0.30998	37.64	-22.33	59.97	37.29	0.15	0.20	QP
6	0.30998	30.54	-19.43	49.97	30.19	0.15	0.20	AVERAGE
7	0.83047	23.42	-32.58	56.00	23.12	0.10	0.20	QP
8	0.83047	18.61	-27.39	46.00	18.31	0.10	0.20	AVERAGE
9	3.881	32.63	-23.37	56.00	32.23	0.10	0.30	QP
10	3.881	21.58	-24.42	46.00	21.18	0.10	0.30	AVERAGE
11	10.676	28.88	-31.12	60.00	28.38	0.10	0.40	QP
12	10.676	22.49	-27.51	50.00	21.99	0.10	0.40	AVERAGE

Note:

Level = Read Level + LISN Factor + Cable Loss.

4.2. Maximum Conducted Output Power Measurement

4.2.1. Limit

For systems using digital modulation in the 2400-2483.5MHz, the limit for peak output power is 30dBm. The limited has to be reduced by the amount in dB that the gain of the antenna exceed 6dBi. In case of point-to-point operation, the limit has to be reduced by 1dB for every 3dB that the directional gain of the antenna exceeds 6dBi.

4.2.2. Measuring Instruments and Setting

Please refer to section 5 of equipments list in this report. The following table is the setting of the spectrum analyzer.

Spectrum Parameter	Setting
Attenuation	Auto
Span Frequency	Encompass the entire emissions bandwidth (EBW) of the signal
RB	1000 kHz
VB	3000 kHz
Detector	RMS
Trace	MAX HOLD
Sweep Time	Auto

4.2.3. Test Procedures

1. The transmitter output (antenna port) was connected to the spectrum analyzer.
2. Test was performed in accordance with Measurement of Digital Transmission Systems Operating under Section 15.247 March 23, 2005.
3. When measuring maximum conducted output power with multiple antenna systems, add every result of the values by mathematic formula.

4.2.4. Test Setup Layout

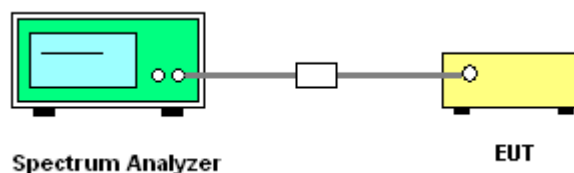

4.2.5. Test Deviation

There is no deviation with the original standard.

4.2.6. EUT Operation during Test

The EUT was programmed to be in continuously transmitting mode.

4.2.7. Test Result of Maximum Conducted Output Power

Temperature	23°C	Humidity	62%
Test Engineer	Sam Chen	Configurations	Draft n / Antenna 1

Configuration Draft n MCS0 20MHz Ant. 1-1

Channel	Frequency	Conducted Power (dBm)	Max. Limit (dBm)	Result
1	2412 MHz	15.49	30.00	Complies
6	2437 MHz	19.41	30.00	Complies
11	2462 MHz	14.68	30.00	Complies

Configuration Draft n MCS0 20MHz Ant. 1-2

Channel	Frequency	Conducted Power (dBm)	Max. Limit (dBm)	Result
1	2412 MHz	16.13	30.00	Complies
6	2437 MHz	20.09	30.00	Complies
11	2462 MHz	15.40	30.00	Complies

Configuration Draft n MCS0 20MHz Ant. 1-3

Channel	Frequency	Conducted Power (dBm)	Max. Limit (dBm)	Result
1	2412 MHz	16.10	30.00	Complies
6	2437 MHz	19.92	30.00	Complies
11	2462 MHz	15.36	30.00	Complies

Configuration Draft n MCS8 20MHz Ant. 1-1 + Ant. 1-2 + Ant. 1-3

Channel	Frequency	Conducted Power (dBm)	Max. Limit (dBm)	Result
1	2412 MHz	20.69	30.00	Complies
6	2437 MHz	24.59	30.00	Complies
11	2462 MHz	19.93	30.00	Complies

Configuration Draft n MCS0 40MHz Ant. 1-1

Channel	Frequency	Conducted Power (dBm)	Max. Limit (dBm)	Result
3	2422 MHz	12.47	30.00	Complies
6	2437 MHz	15.81	30.00	Complies
9	2452 MHz	12.72	30.00	Complies

Configuration Draft n MCS0 40MHz Ant. 1-2

Channel	Frequency	Conducted Power (dBm)	Max. Limit (dBm)	Result
3	2422 MHz	12.90	30.00	Complies
6	2437 MHz	16.35	30.00	Complies
9	2452 MHz	13.60	30.00	Complies

Configuration Draft n MCS0 40MHz Ant. 1-3

Channel	Frequency	Conducted Power (dBm)	Max. Limit (dBm)	Result
3	2422 MHz	13.59	30.00	Complies
6	2437 MHz	16.51	30.00	Complies
9	2452 MHz	13.52	30.00	Complies

Configuration Draft n MCS8 40MHz Ant. 1-1 + Ant. 1-2 + Ant. 1-3

Channel	Frequency	Conducted Power (dBm)	Max. Limit (dBm)	Result
3	2422 MHz	17.78	30.00	Complies
6	2437 MHz	21.00	30.00	Complies
9	2452 MHz	18.07	30.00	Complies

Temperature	23°C	Humidity	62%
Test Engineer	Sam Chen	Configurations	11a Draft n / Antenna 1

Configuration 11a Draft n MCS8 20MHz Ant. 1-1

Channel	Frequency	Conducted Power (dBm)	Max. Limit (dBm)	Result
149	5745 MHz	23.61	30.00	Complies
157	5785 MHz	22.42	30.00	Complies
165	5825 MHz	22.40	30.00	Complies

Configuration 11a Draft n MCS8 20MHz Ant. 1-2

Channel	Frequency	Conducted Power (dBm)	Max. Limit (dBm)	Result
149	5745 MHz	24.20	30.00	Complies
157	5785 MHz	23.24	30.00	Complies
165	5825 MHz	23.19	30.00	Complies

Configuration 11a Draft n MCS8 20MHz Ant. 1-3

Channel	Frequency	Conducted Power (dBm)	Max. Limit (dBm)	Result
149	5745 MHz	24.21	30.00	Complies
157	5785 MHz	22.96	30.00	Complies
165	5825 MHz	22.95	30.00	Complies

Configuration 11a Draft n MCS8 20MHz Ant. 1-1 + Ant. 1-2 + Ant. 1-3

Channel	Frequency	Conducted Power (dBm)	Max. Limit (dBm)	Result
149	5745 MHz	28.78	30.00	Complies
157	5785 MHz	27.66	30.00	Complies
165	5825 MHz	27.63	30.00	Complies

Configuration 11a Draft n MCS8 40MHz Ant. 1-1

Channel	Frequency	Conducted Power (dBm)	Max. Limit (dBm)	Result
151	5755 MHz	20.12	30.00	Complies
159	5795 MHz	22.92	30.00	Complies

Configuration 11a Draft n MCS8 40MHz Ant. 1-2

Channel	Frequency	Conducted Power (dBm)	Max. Limit (dBm)	Result
151	5755 MHz	18.55	30.00	Complies
159	5795 MHz	23.36	30.00	Complies

Configuration 11a Draft n MCS8 40MHz Ant. 1-3

Channel	Frequency	Conducted Power (dBm)	Max. Limit (dBm)	Result
151	5755 MHz	20.04	30.00	Complies
159	5795 MHz	23.73	30.00	Complies

Configuration 11a Draft n MCS8 40MHz Ant. 1-1 + Ant. 1-2+ Ant. 1-3

Channel	Frequency	Conducted Power (dBm)	Max. Limit (dBm)	Result
151	5755 MHz	24.40	30.00	Complies
159	5795 MHz	28.12	30.00	Complies

Temperature	23°C	Humidity	62%
Test Engineer	Sam Chen	Configurations	Draft n / Antenna 2

Configuration Draft n MCS0 20MHz Ant. 2-1

Channel	Frequency	Conducted Power (dBm)	Max. Limit (dBm)	Result
1	2412 MHz	13.31	27.50	Complies
6	2437 MHz	15.10	27.50	Complies
11	2462 MHz	12.17	27.50	Complies

Configuration Draft n MCS0 20MHz Ant. 2-2

Channel	Frequency	Conducted Power (dBm)	Max. Limit (dBm)	Result
1	2412 MHz	12.87	27.50	Complies
6	2437 MHz	15.68	27.50	Complies
11	2462 MHz	12.63	27.50	Complies

Configuration Draft n MCS0 20MHz Ant. 2-3

Channel	Frequency	Conducted Power (dBm)	Max. Limit (dBm)	Result
1	2412 MHz	12.83	27.50	Complies
6	2437 MHz	15.41	27.50	Complies
11	2462 MHz	12.98	27.50	Complies

Configuration Draft n MCS8 20MHz Ant. 2-1 + Ant. 2-2+ Ant. 2-3

Channel	Frequency	Conducted Power (dBm)	Max. Limit (dBm)	Result
1	2412 MHz	17.78	27.50	Complies
6	2437 MHz	20.17	27.50	Complies
11	2462 MHz	17.38	27.50	Complies

Configuration Draft n MCS0 40MHz Ant. 2-1

Channel	Frequency	Conducted Power (dBm)	Max. Limit (dBm)	Result
3	2422 MHz	9.63	27.50	Complies
6	2437 MHz	12.26	27.50	Complies
9	2452 MHz	9.88	27.50	Complies

Configuration Draft n MCS0 40MHz Ant. 2-2

Channel	Frequency	Conducted Power (dBm)	Max. Limit (dBm)	Result
3	2422 MHz	9.47	27.50	Complies
6	2437 MHz	12.86	27.50	Complies
9	2452 MHz	10.11	27.50	Complies

Configuration Draft n MCS0 40MHz Ant. 2-3

Channel	Frequency	Conducted Power (dBm)	Max. Limit (dBm)	Result
3	2422 MHz	9.95	27.50	Complies
6	2437 MHz	12.50	27.50	Complies
9	2452 MHz	9.77	27.50	Complies

Configuration Draft n MCS8 40MHz Ant. 2-1 + Ant. 2-2+ Ant. 2-3

Channel	Frequency	Conducted Power (dBm)	Max. Limit (dBm)	Result
3	2422 MHz	14.46	27.50	Complies
6	2437 MHz	17.31	27.50	Complies
9	2452 MHz	14.69	27.50	Complies

Temperature	23°C	Humidity	62%
Test Engineer	Sam Chen	Configurations	Draft n / Antenna 3

Configuration Draft n MCS0 20MHz Ant. 3-1

Channel	Frequency	Conducted Power (dBm)	Max. Limit (dBm)	Result
1	2412 MHz	13.86	30.00	Complies
6	2437 MHz	19.06	30.00	Complies
11	2462 MHz	15.03	30.00	Complies

Configuration Draft n MCS0 20MHz Ant. 3-2

Channel	Frequency	Conducted Power (dBm)	Max. Limit (dBm)	Result
1	2412 MHz	14.18	30.00	Complies
6	2437 MHz	19.94	30.00	Complies
11	2462 MHz	15.68	30.00	Complies

Configuration Draft n MCS0 20MHz Ant. 3-3

Channel	Frequency	Conducted Power (dBm)	Max. Limit (dBm)	Result
1	2412 MHz	14.30	30.00	Complies
6	2437 MHz	20.13	30.00	Complies
11	2462 MHz	15.79	30.00	Complies

Configuration Draft n MCS8 20MHz Ant. 3-1 + Ant. 3-2+ Ant. 3-3

Channel	Frequency	Conducted Power (dBm)	Max. Limit (dBm)	Result
1	2412 MHz	18.89	30.00	Complies
6	2437 MHz	24.49	30.00	Complies
11	2462 MHz	20.28	30.00	Complies

Configuration Drafft n MCS0 40MHz Ant. 3-1

Channel	Frequency	Conducted Power (dBm)	Max. Limit (dBm)	Result
3	2422 MHz	12.03	30.00	Complies
6	2437 MHz	14.70	30.00	Complies
9	2452 MHz	12.01	30.00	Complies

Configuration Drafft n MCS0 40MHz Ant. 3-2

Channel	Frequency	Conducted Power (dBm)	Max. Limit (dBm)	Result
3	2422 MHz	12.40	30.00	Complies
6	2437 MHz	15.46	30.00	Complies
9	2452 MHz	12.79	30.00	Complies

Configuration Drafft n MCS0 40MHz Ant. 3-3

Channel	Frequency	Conducted Power (dBm)	Max. Limit (dBm)	Result
3	2422 MHz	12.17	30.00	Complies
6	2437 MHz	14.79	30.00	Complies
9	2452 MHz	12.99	30.00	Complies

Configuration Drafft n MCS8 40MHz Ant. 3-1+ Ant. 3-2+ Ant. 3-3

Channel	Frequency	Conducted Power (dBm)	Max. Limit (dBm)	Result
3	2422 MHz	16.97	30.00	Complies
6	2437 MHz	19.76	30.00	Complies
9	2452 MHz	17.39	30.00	Complies

Temperature	23°C	Humidity	62%
Test Engineer	Sam Chen	Configurations	Draft n / Antenna 4

Configuration Draft n MCS0 20MHz Ant. 4-1

Channel	Frequency	Conducted Power (dBm)	Max. Limit (dBm)	Result
1	2412 MHz	16.56	22.10	Complies
6	2437 MHz	16.48	22.10	Complies
11	2462 MHz	16.75	22.10	Complies

Configuration Draft n MCS0 20MHz Ant. 4-2

Channel	Frequency	Conducted Power (dBm)	Max. Limit (dBm)	Result
1	2412 MHz	17.71	22.10	Complies
6	2437 MHz	17.43	22.10	Complies
11	2462 MHz	17.22	22.10	Complies

Configuration Draft n MCS0 20MHz Ant. 4-3

Channel	Frequency	Conducted Power (dBm)	Max. Limit (dBm)	Result
1	2412 MHz	17.06	22.10	Complies
6	2437 MHz	17.01	22.10	Complies
11	2462 MHz	17.51	22.10	Complies

Configuration Draft n MCS8 20MHz Ant. 4-1 + Ant. 4-2+ Ant. 4-3

Channel	Frequency	Conducted Power (dBm)	Max. Limit (dBm)	Result
1	2412 MHz	21.94	22.10	Complies
6	2437 MHz	21.76	22.10	Complies
11	2462 MHz	21.91	22.10	Complies

Configuration Draft n MCS0 40MHz Ant. 4-1

Channel	Frequency	Conducted Power (dBm)	Max. Limit (dBm)	Result
3	2422 MHz	16.11	22.10	Complies
6	2437 MHz	16.84	22.10	Complies
9	2452 MHz	15.14	22.10	Complies

Configuration Draft n MCS0 40MHz Ant. 4-2

Channel	Frequency	Conducted Power (dBm)	Max. Limit (dBm)	Result
3	2422 MHz	16.81	22.10	Complies
6	2437 MHz	17.60	22.10	Complies
9	2452 MHz	15.71	22.10	Complies

Configuration Draft n MCS0 40MHz Ant. 4-3

Channel	Frequency	Conducted Power (dBm)	Max. Limit (dBm)	Result
3	2422 MHz	16.55	22.10	Complies
6	2437 MHz	17.04	22.10	Complies
9	2452 MHz	16.45	22.10	Complies

Configuration Draft n MCS8 40MHz Ant. 4-1 + Ant. 4-2+ Ant. 4-3

Channel	Frequency	Conducted Power (dBm)	Max. Limit (dBm)	Result
3	2422 MHz	21.27	22.10	Complies
6	2437 MHz	21.94	22.10	Complies
9	2452 MHz	20.57	22.10	Complies

Temperature	23°C	Humidity	62%
Test Engineer	Sam Chen	Configurations	Draft n / Antenna 5

Configuration Draft n MCS0 20MHz Ant. 5-1

Channel	Frequency	Conducted Power (dBm)	Max. Limit (dBm)	Result
1	2412 MHz	15.61	30.00	Complies
6	2437 MHz	22.21	30.00	Complies
11	2462 MHz	15.03	30.00	Complies

Configuration Draft n MCS0 20MHz Ant. 5-2

Channel	Frequency	Conducted Power (dBm)	Max. Limit (dBm)	Result
1	2412 MHz	15.95	30.00	Complies
6	2437 MHz	23.27	30.00	Complies
11	2462 MHz	15.68	30.00	Complies

Configuration Draft n MCS0 20MHz Ant. 5-3

Channel	Frequency	Conducted Power (dBm)	Max. Limit (dBm)	Result
1	2412 MHz	16.26	30.00	Complies
6	2437 MHz	23.29	30.00	Complies
11	2462 MHz	15.79	30.00	Complies

Configuration Draft n MCS8 20MHz Ant. 5-1 + Ant. 5-2+ Ant. 5-3

Channel	Frequency	Conducted Power (dBm)	Max. Limit (dBm)	Result
1	2412 MHz	20.72	30.00	Complies
6	2437 MHz	27.72	30.00	Complies
11	2462 MHz	20.28	30.00	Complies

Configuration Draft n MCS0 40MHz Ant. 5-1

Channel	Frequency	Conducted Power (dBm)	Max. Limit (dBm)	Result
3	2422 MHz	13.66	30.00	Complies
6	2437 MHz	15.81	30.00	Complies
9	2452 MHz	12.78	30.00	Complies

Configuration Draft n MCS0 40MHz Ant. 5-2

Channel	Frequency	Conducted Power (dBm)	Max. Limit (dBm)	Result
3	2422 MHz	14.25	30.00	Complies
6	2437 MHz	16.35	30.00	Complies
9	2452 MHz	13.51	30.00	Complies

Configuration Draft n MCS0 40MHz Ant. 5-3

Channel	Frequency	Conducted Power (dBm)	Max. Limit (dBm)	Result
3	2422 MHz	13.74	30.00	Complies
6	2437 MHz	16.51	30.00	Complies
9	2452 MHz	13.45	30.00	Complies

Configuration Draft n MCS8 40MHz Ant. 5-1 + Ant. 5-2+ Ant. 5-3

Channel	Frequency	Conducted Power (dBm)	Max. Limit (dBm)	Result
3	2422 MHz	18.66	30.00	Complies
6	2437 MHz	21.00	30.00	Complies
9	2452 MHz	18.03	30.00	Complies

Temperature	23°C	Humidity	62%
Test Engineer	Sam Chen	Configurations	11a Draft n / Antenna 5

Configuration 11a Draft n MCS8 20MHz Ant. 5-1

Channel	Frequency	Conducted Power (dBm)	Max. Limit (dBm)	Result
149	5745 MHz	23.61	30.00	Complies
157	5785 MHz	20.96	30.00	Complies
165	5825 MHz	23.28	30.00	Complies

Configuration 11a Draft n MCS8 20MHz Ant. 5-2

Channel	Frequency	Conducted Power (dBm)	Max. Limit (dBm)	Result
149	5745 MHz	24.20	30.00	Complies
157	5785 MHz	24.03	30.00	Complies
165	5825 MHz	23.50	30.00	Complies

Configuration 11a Draft n MCS8 20MHz Ant. 5-3

Channel	Frequency	Conducted Power (dBm)	Max. Limit (dBm)	Result
149	5745 MHz	24.21	30.00	Complies
157	5785 MHz	24.39	30.00	Complies
165	5825 MHz	21.35	30.00	Complies

Configuration 11a Draft n MCS8 20MHz Ant. 5-1 + Ant. 5-2 + Ant. 5-3

Channel	Frequency	Conducted Power (dBm)	Max. Limit (dBm)	Result
149	5745 MHz	28.78	30.00	Complies
157	5785 MHz	28.15	30.00	Complies
165	5825 MHz	27.58	30.00	Complies

Configuration 11a Draft n MCS8 40MHz Ant. 5-1

Channel	Frequency	Conducted Power (dBm)	Max. Limit (dBm)	Result
151	5755 MHz	20.12	30.00	Complies
159	5795 MHz	22.92	30.00	Complies

Configuration 11a Draft n MCS8 40MHz Ant. 5-2

Channel	Frequency	Conducted Power (dBm)	Max. Limit (dBm)	Result
151	5755 MHz	18.55	30.00	Complies
159	5795 MHz	23.36	30.00	Complies

Configuration 11a Draft n MCS8 40MHz Ant. 5-3

Channel	Frequency	Conducted Power (dBm)	Max. Limit (dBm)	Result
151	5755 MHz	20.04	30.00	Complies
159	5795 MHz	23.73	30.00	Complies

Configuration 11a Draft n MCS8 40MHz Ant. 5-1 + Ant. 5-2 + Ant. 5-3

Channel	Frequency	Conducted Power (dBm)	Max. Limit (dBm)	Result
151	5755 MHz	24.40	30.00	Complies
159	5795 MHz	28.12	30.00	Complies

Temperature	23°C	Humidity	62%
Test Engineer	Sam Chen	Configurations	11a Draft n / Antenna 6

Configuration 11a Draft n MCS8 20MHz Ant. 6-1

Channel	Frequency	Conducted Power (dBm)	Max. Limit (dBm)	Result
149	5745 MHz	18.64	23.00	Complies
157	5785 MHz	18.30	23.00	Complies
165	5825 MHz	18.60	23.00	Complies

Configuration 11a Draft n MCS8 20MHz Ant. 6-2

Channel	Frequency	Conducted Power (dBm)	Max. Limit (dBm)	Result
149	5745 MHz	17.35	23.00	Complies
157	5785 MHz	17.50	23.00	Complies
165	5825 MHz	17.32	23.00	Complies

Configuration 11a Draft n MCS8 20MHz Ant. 6-3

Channel	Frequency	Conducted Power (dBm)	Max. Limit (dBm)	Result
149	5745 MHz	17.40	23.00	Complies
157	5785 MHz	17.54	23.00	Complies
165	5825 MHz	17.64	23.00	Complies

Configuration 11a Draft n MCS8 20MHz Ant. 6-1 + Ant. 6-2 + Ant. 6-3

Channel	Frequency	Conducted Power (dBm)	Max. Limit (dBm)	Result
149	5745 MHz	22.61	23.00	Complies
157	5785 MHz	22.56	23.00	Complies
165	5825 MHz	22.66	23.00	Complies

Configuration 11a Draft n MCS8 40MHz Ant. 6-1

Channel	Frequency	Conducted Power (dBm)	Max. Limit (dBm)	Result
151	5755 MHz	18.73	23.00	Complies
159	5795 MHz	18.60	23.00	Complies

Configuration 11a Draft n MCS8 40MHz Ant. 6-2

Channel	Frequency	Conducted Power (dBm)	Max. Limit (dBm)	Result
151	5755 MHz	17.72	23.00	Complies
159	5795 MHz	17.71	23.00	Complies

Configuration 11a Draft n MCS8 40MHz Ant. 6-3

Channel	Frequency	Conducted Power (dBm)	Max. Limit (dBm)	Result
151	5755 MHz	17.50	23.00	Complies
159	5795 MHz	17.75	23.00	Complies

Configuration 11a Draft n MCS8 40MHz Ant. 6-1 + Ant. 6-2+ Ant. 6-3

Channel	Frequency	Conducted Power (dBm)	Max. Limit (dBm)	Result
151	5755 MHz	22.73	23.00	Complies
159	5795 MHz	22.81	23.00	Complies

Temperature	23°C	Humidity	62%
Test Engineer	Sam Chen	Configurations	11a Draft n / Antenna 7

Configuration 11a Draft n MCS8 20MHz Ant. 7-1

Channel	Frequency	Conducted Power (dBm)	Max. Limit (dBm)	Result
149	5745 MHz	23.61	30.00	Complies
157	5785 MHz	22.42	30.00	Complies
165	5825 MHz	22.40	30.00	Complies

Configuration 11a Draft n MCS8 20MHz Ant. 7-2

Channel	Frequency	Conducted Power (dBm)	Max. Limit (dBm)	Result
149	5745 MHz	24.20	30.00	Complies
157	5785 MHz	23.24	30.00	Complies
165	5825 MHz	23.19	30.00	Complies

Configuration 11a Draft n MCS8 20MHz Ant. 7-3

Channel	Frequency	Conducted Power (dBm)	Max. Limit (dBm)	Result
149	5745 MHz	24.21	30.00	Complies
157	5785 MHz	22.96	30.00	Complies
165	5825 MHz	22.95	30.00	Complies

Configuration 11a Draft n MCS8 20MHz Ant. 7-1 + Ant. 7-2 + Ant. 7-3

Channel	Frequency	Conducted Power (dBm)	Max. Limit (dBm)	Result
149	5745 MHz	28.78	30.00	Complies
157	5785 MHz	27.66	30.00	Complies
165	5825 MHz	27.63	30.00	Complies

Configuration 11a Draft n MCS8 40MHz Ant. 7-1

Channel	Frequency	Conducted Power (dBm)	Max. Limit (dBm)	Result
151	5755 MHz	20.12	30.00	Complies
159	5795 MHz	22.92	30.00	Complies

Configuration 11a Draft n MCS8 40MHz Ant. 7-2

Channel	Frequency	Conducted Power (dBm)	Max. Limit (dBm)	Result
151	5755 MHz	18.55	30.00	Complies
159	5795 MHz	23.36	30.00	Complies

Configuration 11a Draft n MCS8 40MHz Ant. 7-3

Channel	Frequency	Conducted Power (dBm)	Max. Limit (dBm)	Result
151	5755 MHz	20.04	30.00	Complies
159	5795 MHz	23.73	30.00	Complies

Configuration 11a Draft n MCS8 40MHz Ant. 7-1 + Ant. 7-2+ Ant. 7-3

Channel	Frequency	Conducted Power (dBm)	Max. Limit (dBm)	Result
151	5755 MHz	24.40	30.00	Complies
159	5795 MHz	28.12	30.00	Complies

Conducted Output Power Plot on Configuration Draft n MCS8 20MHz Ant. 1-1/ 2412 MHz

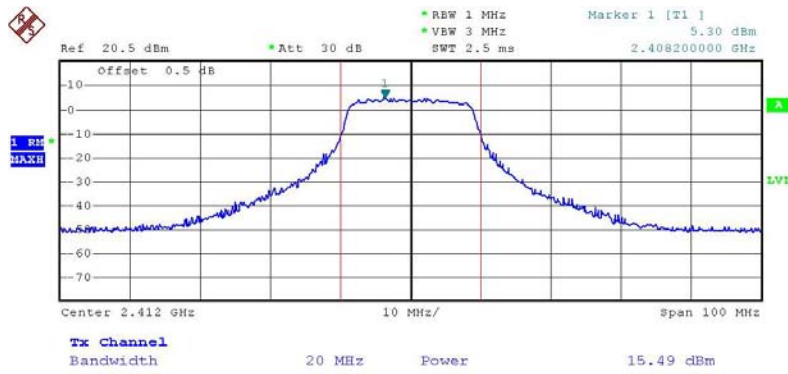

Date: 17.MAR.2008 13:37:13

Conducted Output Power Plot on Configuration Draft n MCS8 20MHz Ant. 1-2/ 2412 MHz

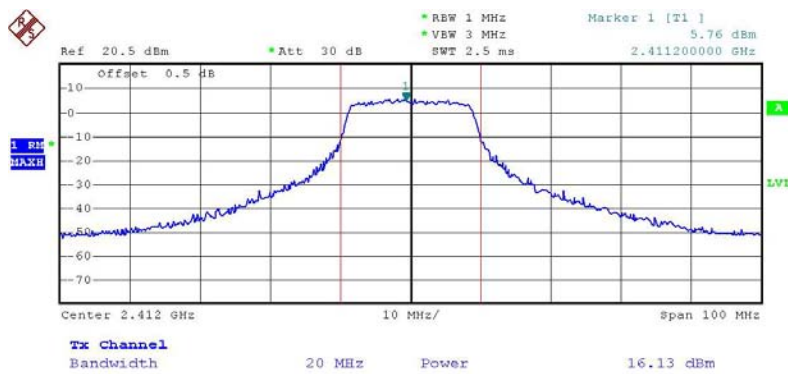

Date: 17.MAR.2008 13:39:14

Conducted Output Power Plot on Configuration Draft n MCS8 20MHz Ant. 1-3/ 2412 MHz

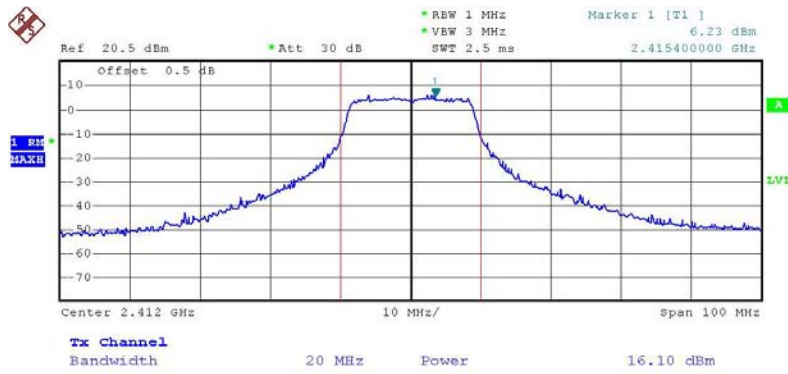

Date: 17.MAR.2008 13:40:57

Conducted Output Power Plot on Configuration Draft n MCS8 20MHz Ant. 1-1/ 2437 MHz



Date: 17.MAR.2008 13:48:46

Conducted Output Power Plot on Configuration Draft n MCS8 20MHz Ant. 1-2/ 2437 MHz

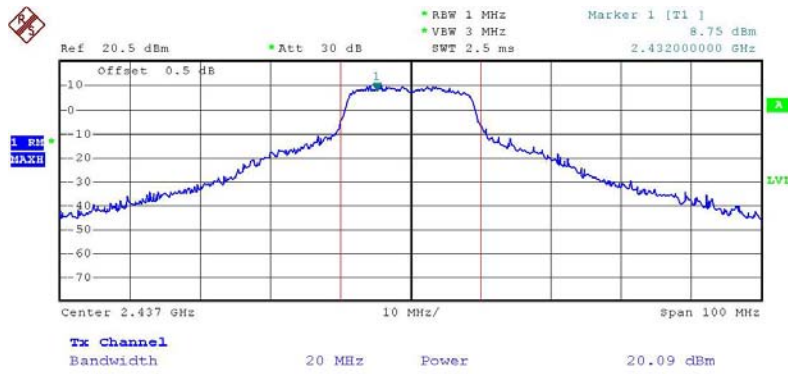

Date: 17.MAR.2008 13:45:44

Conducted Output Power Plot on Configuration Draft n MCS8 20MHz Ant. 1-3/ 2437 MHz

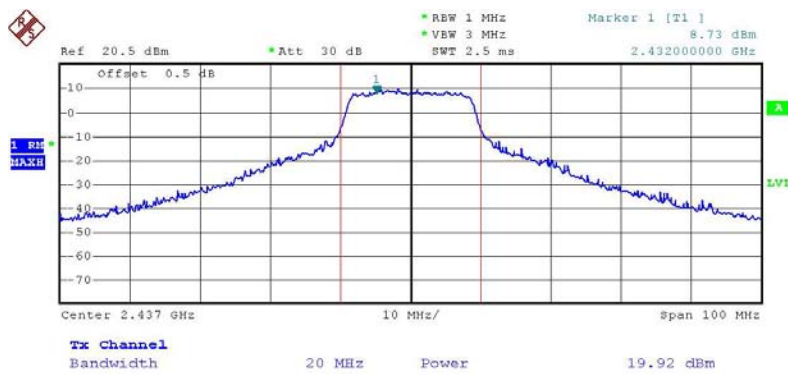

Date: 17.MAR.2008 13:44:19

Conducted Output Power Plot on Configuration Draft n MCS8 20MHz Ant. 1-1/ 2462 MHz

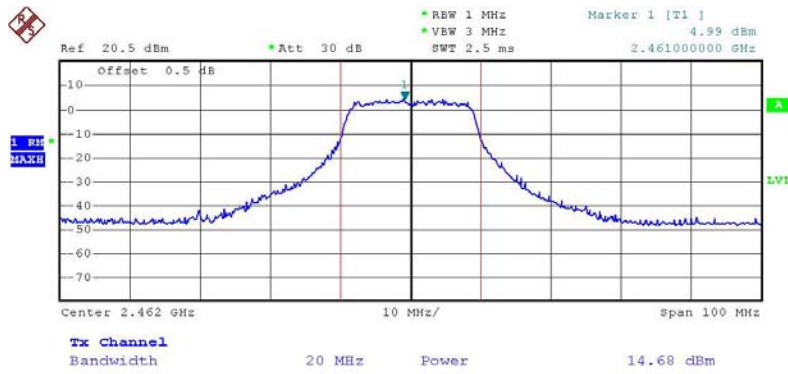

Date: 17.MAR.2008 13:50:22

Conducted Output Power Plot on Configuration Draft n MCS8 20MHz Ant. 1-2/ 2462 MHz

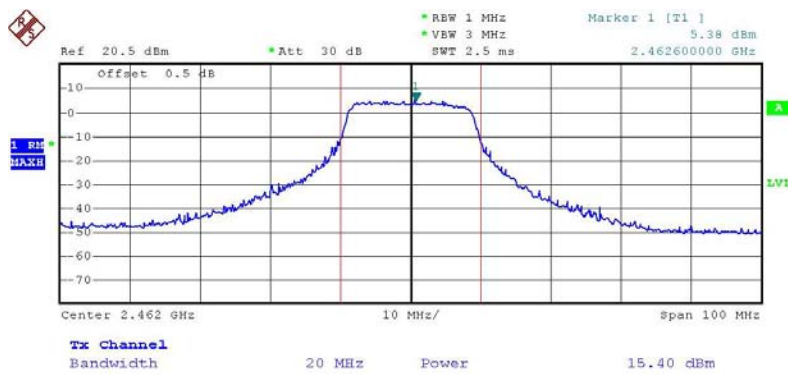

Date: 17.MAR.2008 13:51:40

Conducted Output Power Plot on Configuration Draft n MCS8 20MHz Ant. 1-3/ 2462 MHz

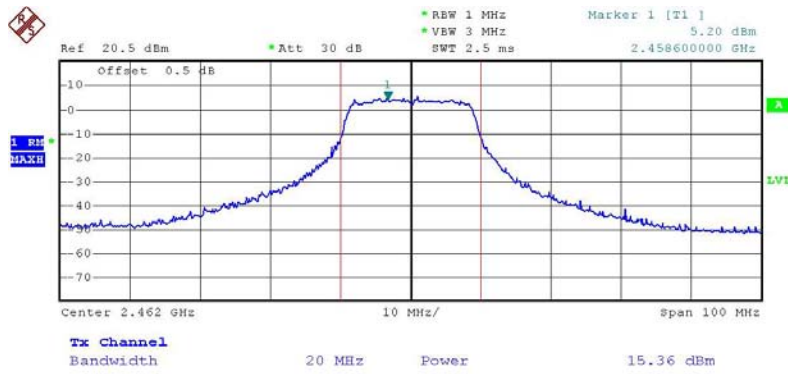

Date: 17.MAR.2008 13:53:34

Conducted Output Power Plot on Configuration Draft n MCS8 40MHz Ant. 1-1/ 2422 MHz

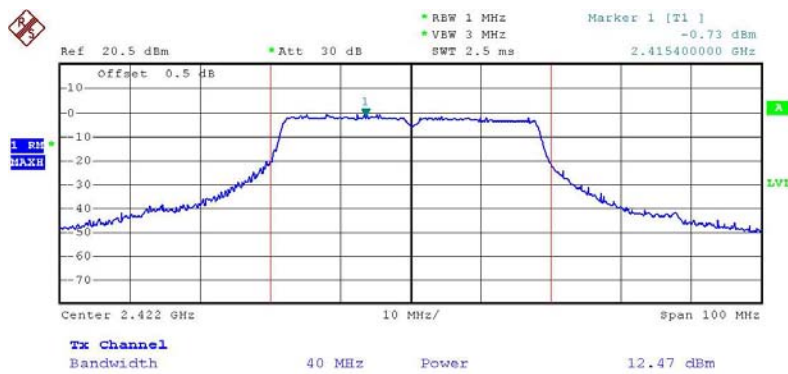

Date: 17.MAR.2008 14:10:26

Conducted Output Power Plot on Configuration Draft n MCS8 40MHz Ant. 1-2/ 2422 MHz

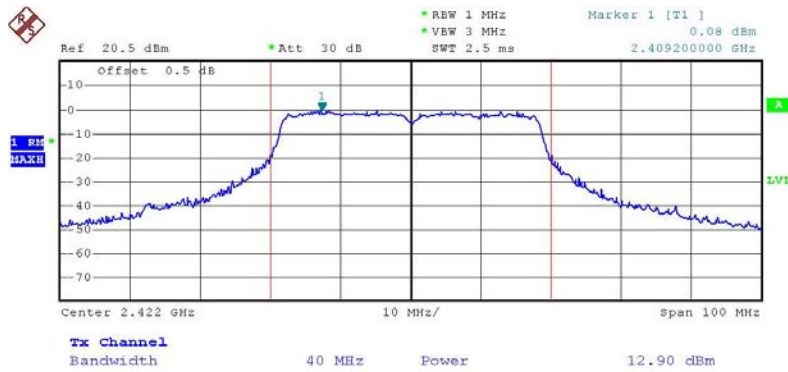

Date: 17.MAR.2008 14:08:33

Conducted Output Power Plot on Configuration Draft n MCS8 40MHz Ant. 1-3/ 2422 MHz

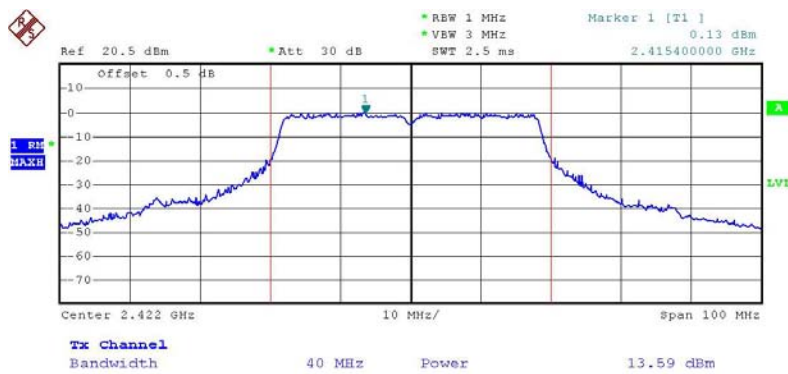

Date: 17.MAR.2008 14:06:32

Conducted Output Power Plot on Configuration Draft n MCS8 40MHz Ant. 1-1/ 2437 MHz

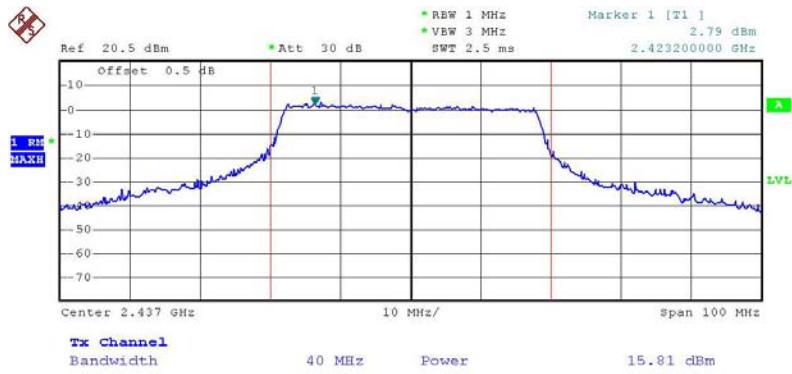

Date: 17.MAR.2008 14:00:28

Conducted Output Power Plot on Configuration Draft n MCS8 40MHz Ant. 1-2/ 2437 MHz

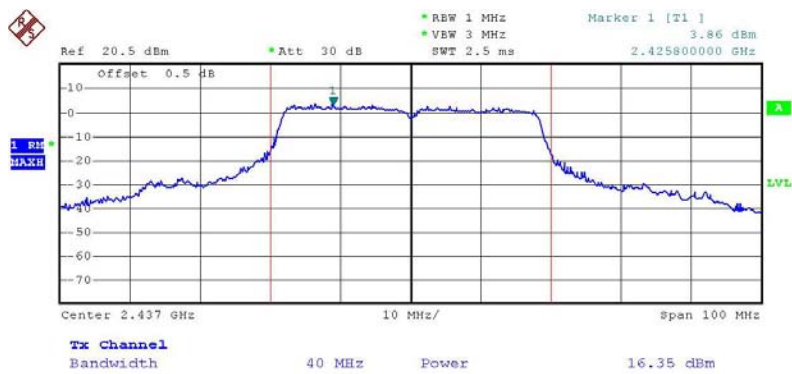

Date: 17.MAR.2008 14:02:08

Conducted Output Power Plot on Configuration Draft n MCS8 40MHz Ant. 1-3/ 2437 MHz

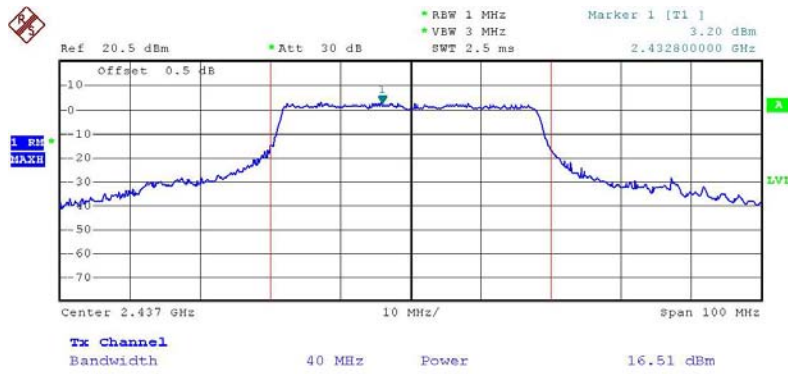

Date: 17.MAR.2008 14:03:48

Conducted Output Power Plot on Configuration Draft n MCS8 40MHz Ant. 1-1/ 2452 MHz

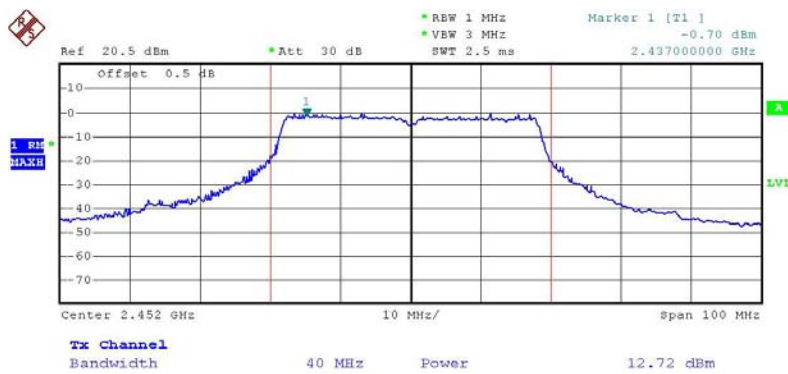

Date: 17.MAR.2008 13:58:27

Conducted Output Power Plot on Configuration Draft n MCS8 40MHz Ant. 1-2/ 2452 MHz

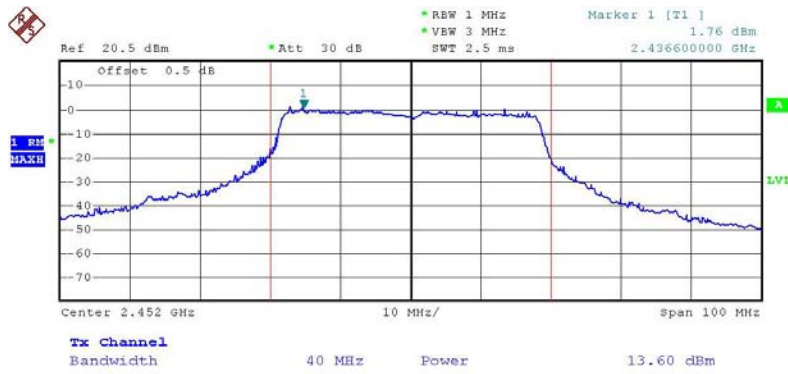

Date: 17.MAR.2008 13:57:14

Conducted Output Power Plot on Configuration Draft n MCS8 40MHz Ant. 1-3/ 2452 MHz



Date: 17.MAR.2008 13:55:48

Conducted Output Power Plot on Configuration 11a Draft n MCS8 20MHz Ant. 1-1/ 5745 MHz

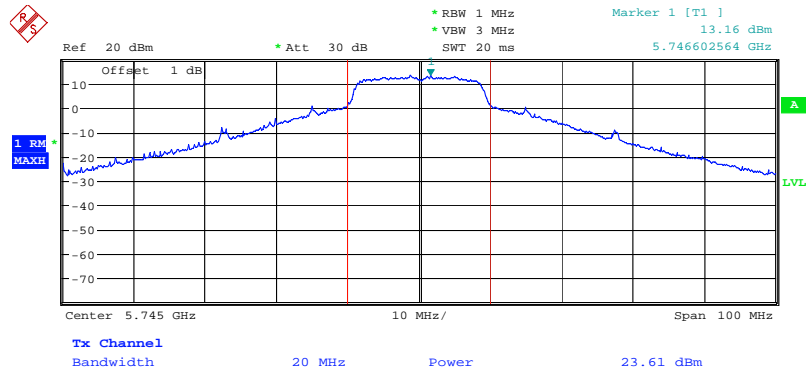

Date: 20.MAR.2008 21:07:12

Conducted Output Power Plot on Configuration 11a Draft n MCS8 20MHz Ant. 1-2/ 5745 MHz

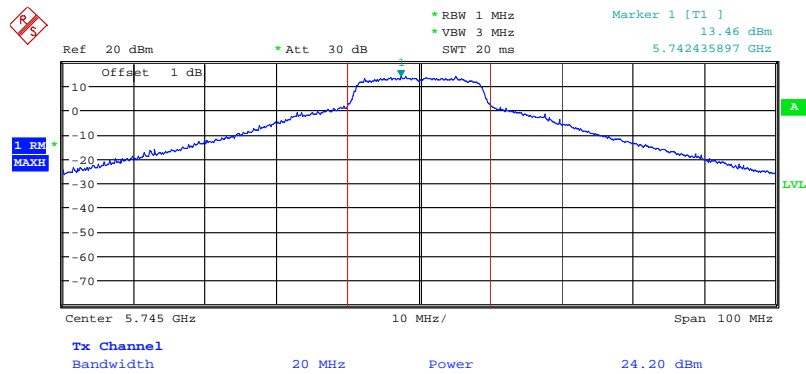

Date: 20.MAR.2008 21:08:40

Conducted Output Power Plot on Configuration 11a Draft n MCS8 20MHz Ant. 1-3/ 5745 MHz

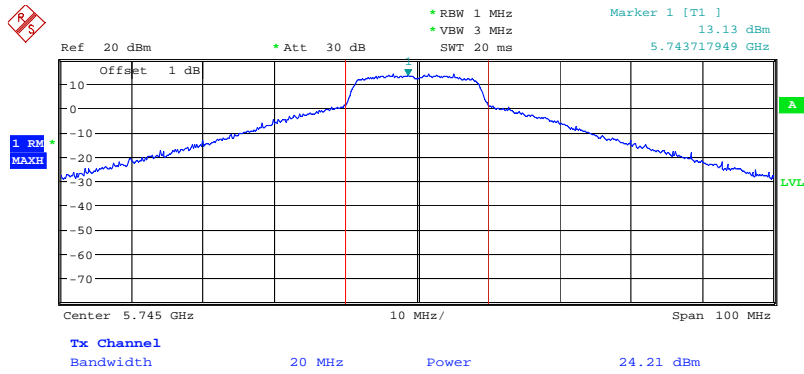

Date: 20.MAR.2008 21:07:56

Conducted Output Power Plot on Configuration 11a Draft n MCS8 20MHz Ant. 1-1/ 5785MHz

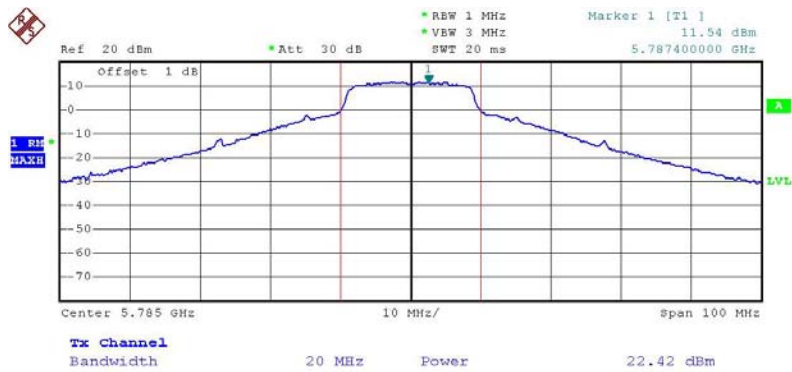

Date: 17.MAR.2008 17:24:36

Conducted Output Power Plot on Configuration 11a Draft n MCS8 20MHz Ant. 1-2/ 5785MHz

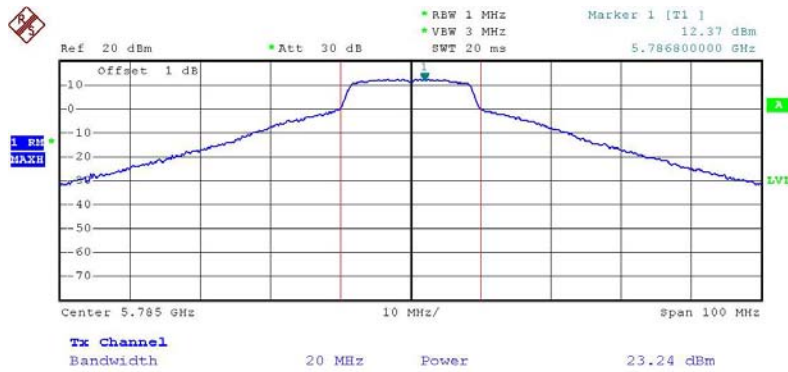

Date: 17.MAR.2008 17:23:02

Conducted Output Power Plot on Configuration 11a Draft n MCS8 20MHz Ant. 1-3/ 5785MHz

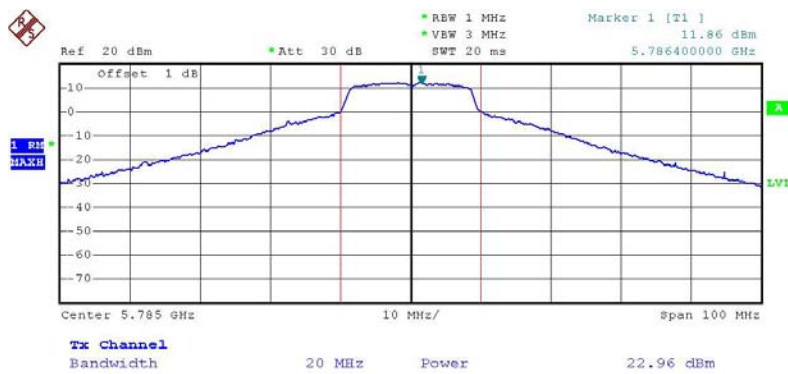

Date: 17.MAR.2008 17:22:03

Conducted Output Power Plot on Configuration 11a Draft n MCS8 20MHz Ant. 1-1/ 5825 MHz

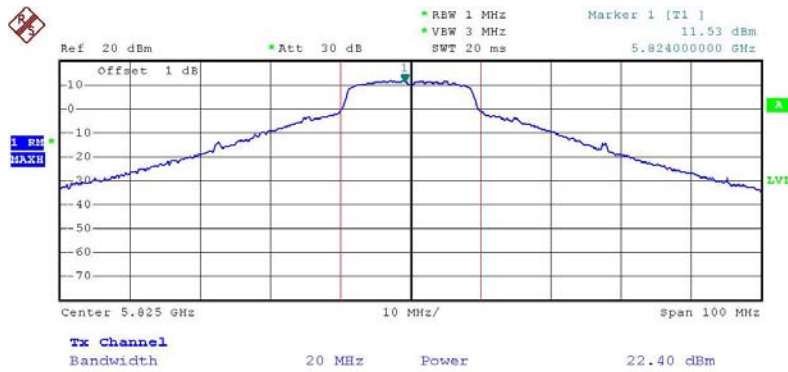

Date: 17.MAR.2008 17:17:59

Conducted Output Power Plot on Configuration 11a Draft n MCS8 20MHz Ant. 1-2/ 5825 MHz

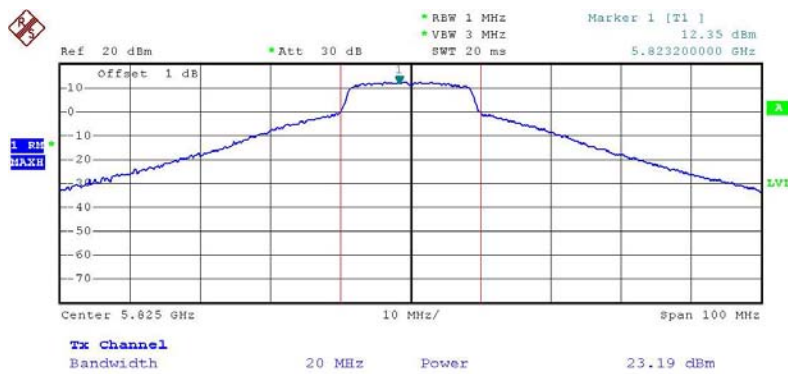

Date: 17.MAR.2008 17:20:14

Conducted Output Power Plot on Configuration 11a Draft n MCS8 20MHz Ant. 1-3/ 5825 MHz

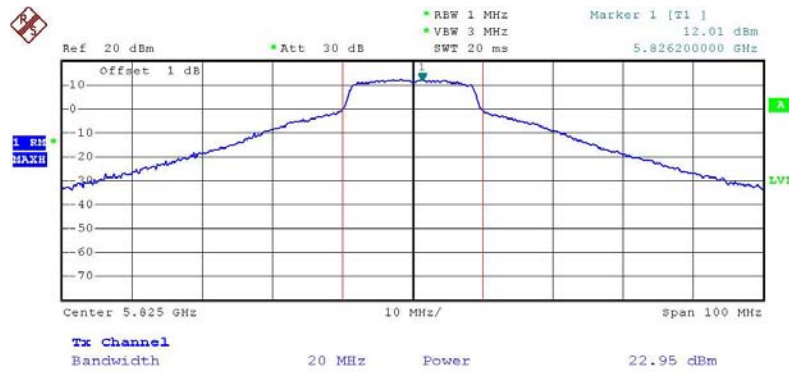

Date: 17.MAR.2008 17:21:16

Conducted Output Power Plot on Configuration 11a Draft n MCS8 40MHz Ant. 1-1/ 5755 MHz

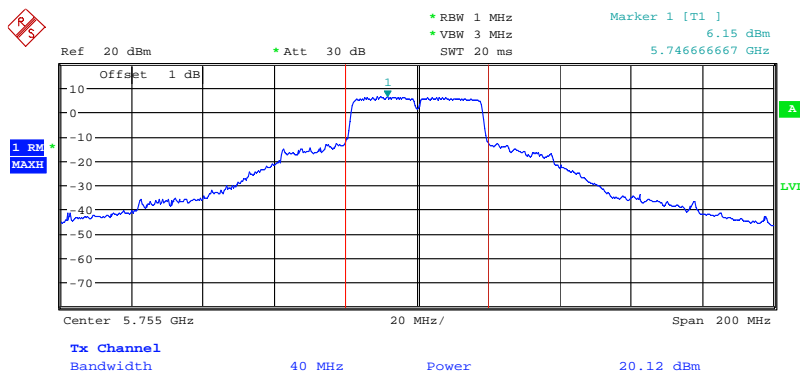

Date: 20.MAR.2008 21:04:54

Conducted Output Power Plot on Configuration 11a Draft n MCS8 40MHz Ant. 1-2/ 5755 MHz

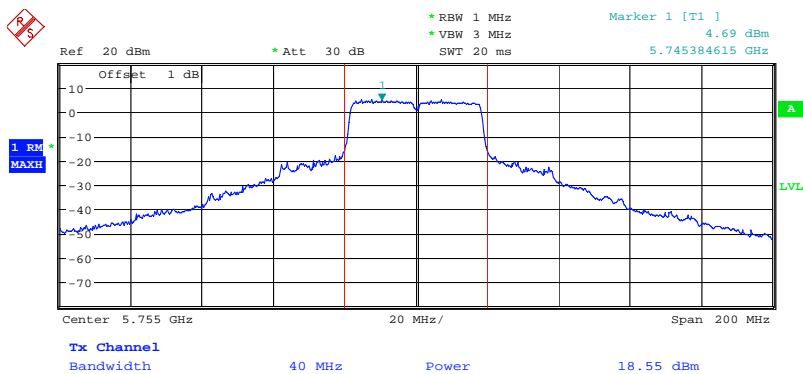

Date: 20.MAR.2008 21:03:13

Conducted Output Power Plot on Configuration 11a Draft n MCS8 40MHz Ant. 1-3/ 5755 MHz

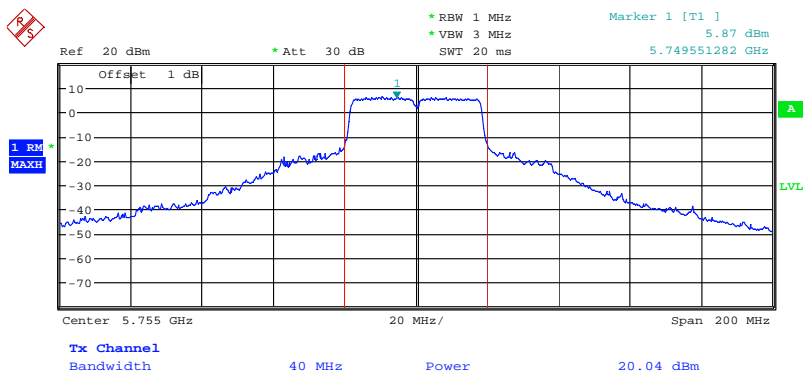

Date: 20.MAR.2008 21:04:12

Conducted Output Power Plot on Configuration 11a Draft n MCS8 40MHz Ant. 1-1/ 5795 MHz

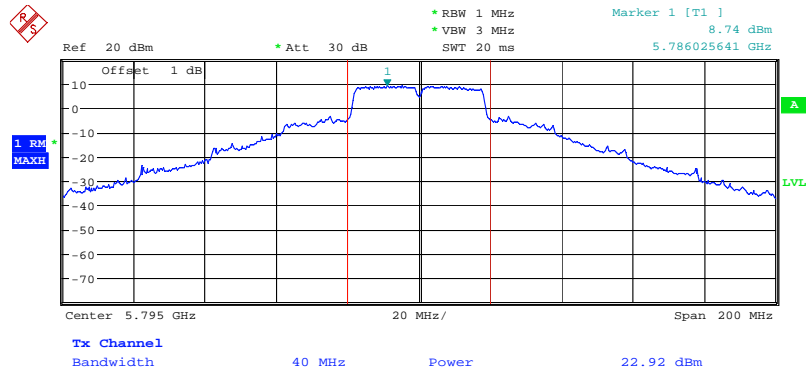

Date: 20.MAR.2008 21:14:25

Conducted Output Power Plot on Configuration 11a Draft n MCS8 40MHz Ant. 1-2/ 5755 MHz

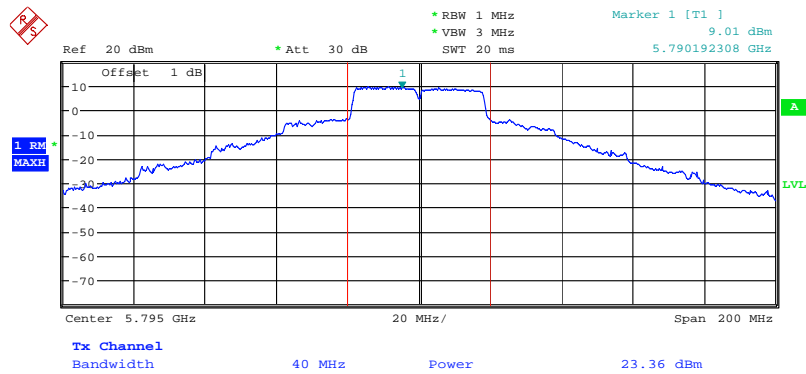

Date: 20.MAR.2008 21:15:01

Conducted Output Power Plot on Configuration 11a Draft n MCS8 40MHz Ant. 1-3/ 5795 MHz

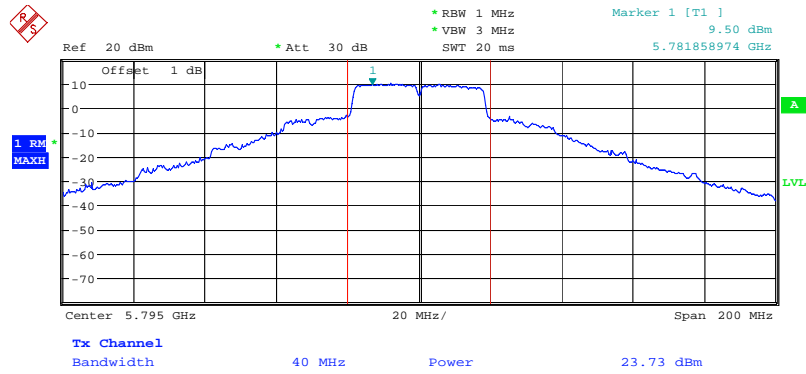

Date: 20.MAR.2008 21:15:42

Conducted Output Power Plot on Configuration Draft n MCS8 20MHz Ant. 2-1/ 2412 MHz

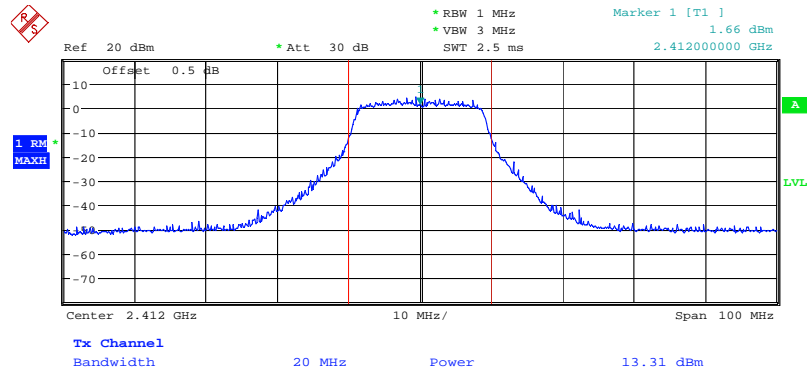

Date: 22.MAR.2008 15:32:03

Conducted Output Power Plot on Configuration Draft n MCS8 20MHz Ant. 2-2/ 2412 MHz

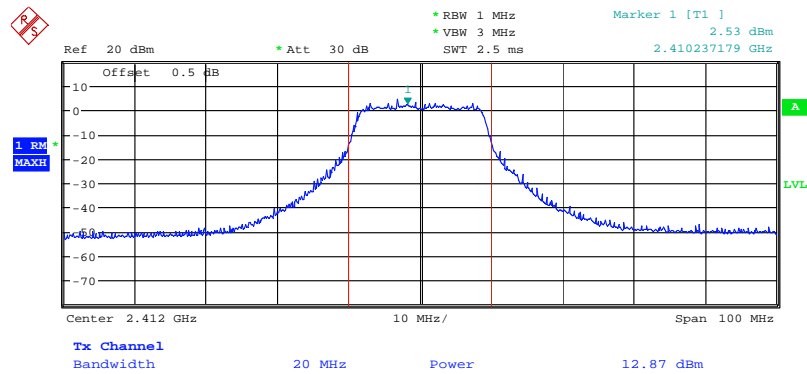

Date: 22.MAR.2008 15:32:57

Conducted Output Power Plot on Configuration Draft n MCS8 20MHz Ant. 2-3/ 2412 MHz

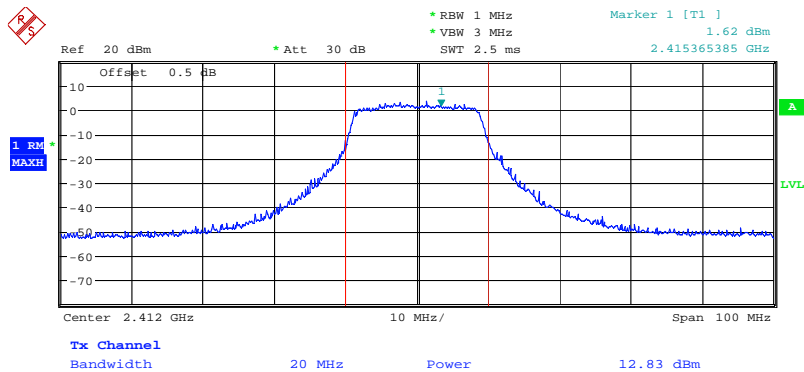

Date: 22.MAR.2008 15:33:48

Conducted Output Power Plot on Configuration Draft n MCS8 20MHz Ant. 2-1/ 2437 MHz

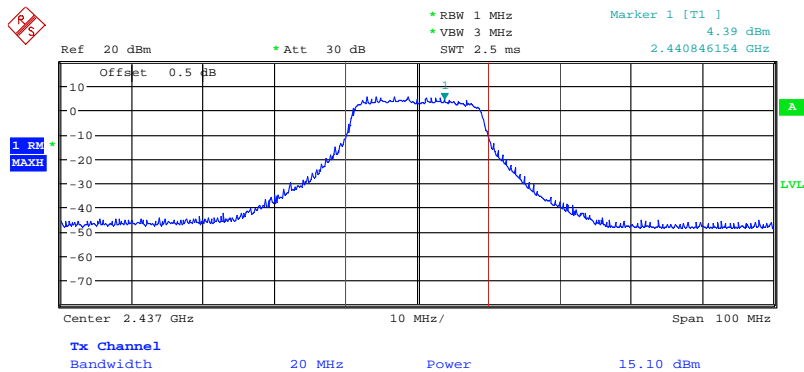

Date: 22.MAR.2008 15:18:08

Conducted Output Power Plot on Configuration Draft n MCS8 20MHz Ant. 2-2/ 2437 MHz

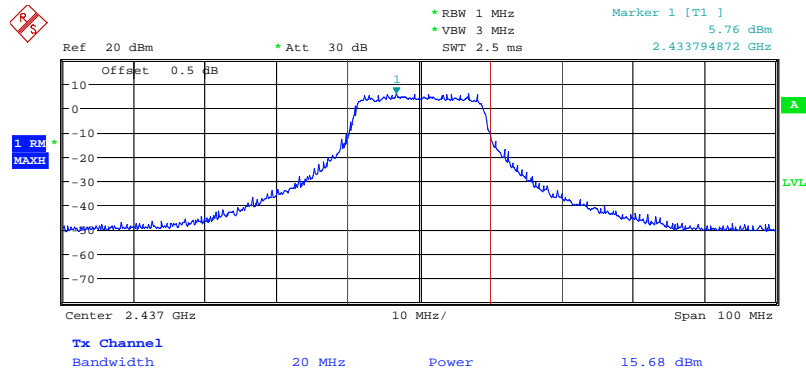

Date: 22.MAR.2008 15:17:00

Conducted Output Power Plot on Configuration Draft n MCS8 20MHz Ant. 2-3/ 2437 MHz

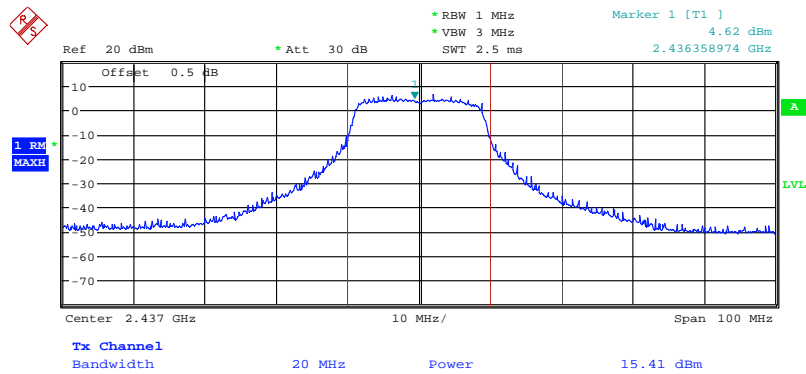

Date: 22.MAR.2008 15:16:02

Conducted Output Power Plot on Configuration Draft n MCS8 20MHz Ant. 2-1/ 2462 MHz

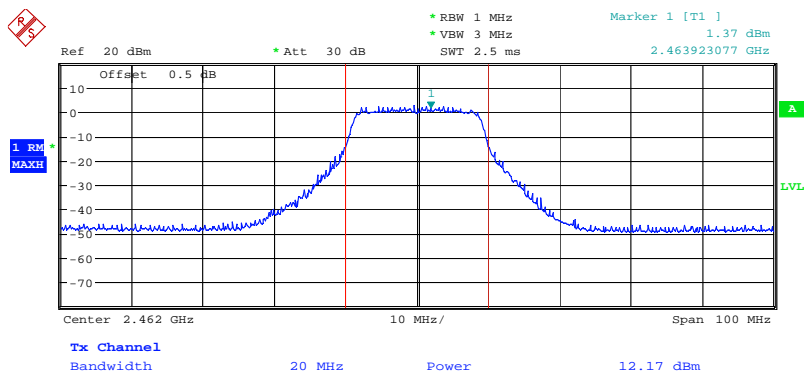

Date: 22.MAR.2008 15:12:17

Conducted Output Power Plot on Configuration Draft n MCS8 20MHz Ant. 2-2/ 2462 MHz

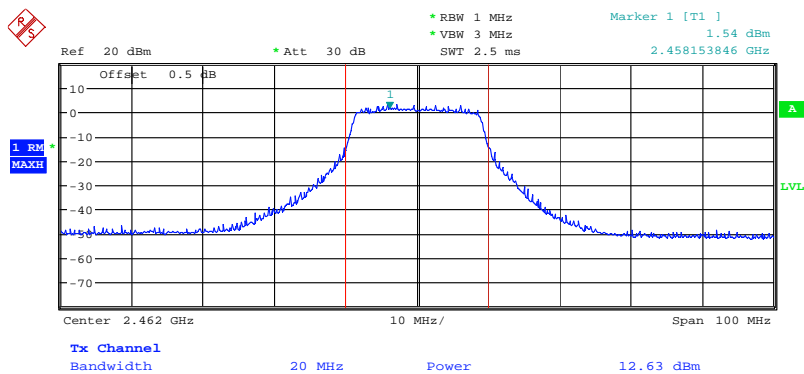

Date: 22.MAR.2008 15:12:57

Conducted Output Power Plot on Configuration Draft n MCS8 20MHz Ant. 2-3/ 2462 MHz

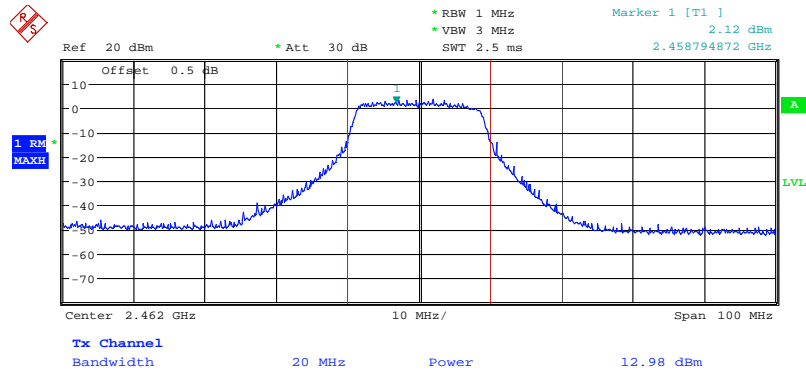

Date: 22.MAR.2008 15:13:53

Conducted Output Power Plot on Configuration Draft n MCS8 40MHz Ant. 2-1/ 2422 MHz

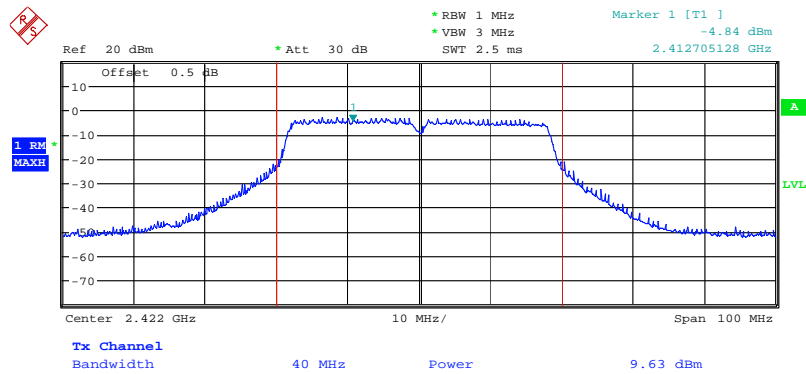

Date: 22.MAR.2008 15:40:12

Conducted Output Power Plot on Configuration Draft n MCS8 40MHz Ant. 2-2/ 2422 MHz

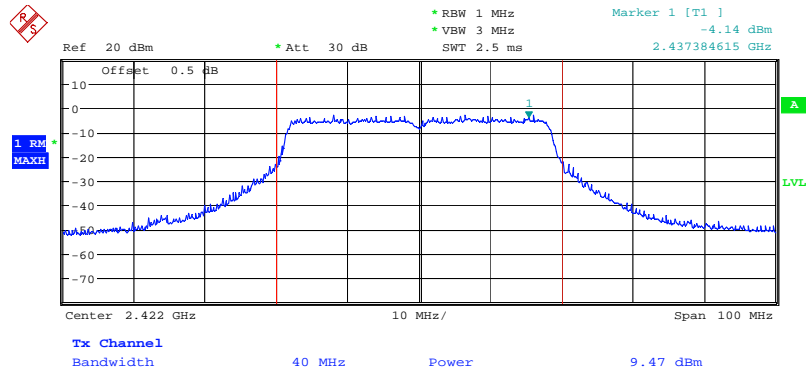

Date: 22.MAR.2008 15:37:29

Conducted Output Power Plot on Configuration Draft n MCS8 40MHz Ant. 2-3/ 2422 MHz

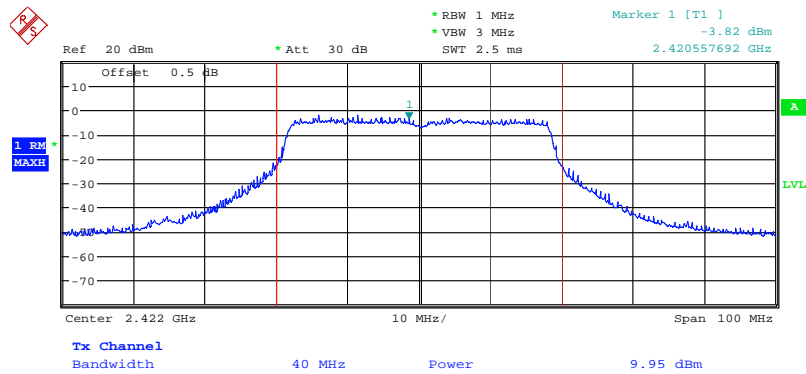

Date: 22.MAR.2008 15:36:03

Conducted Output Power Plot on Configuration Draft n MCS8 40MHz Ant. 2-1/ 2437 MHz

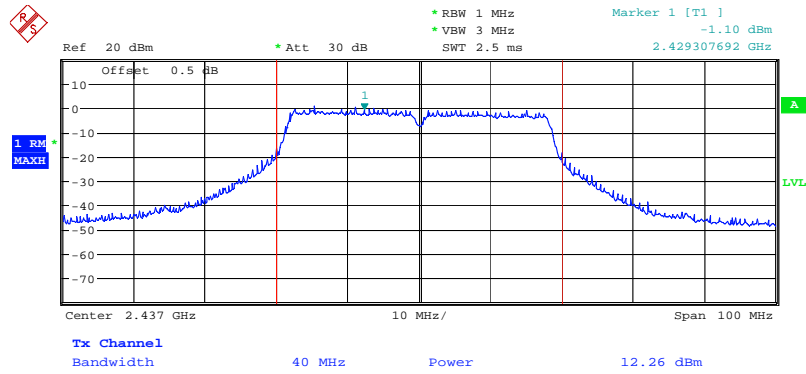

Date: 22.MAR.2008 15:48:14

Conducted Output Power Plot on Configuration Draft n MCS8 40MHz Ant. 2-2/ 2437 MHz

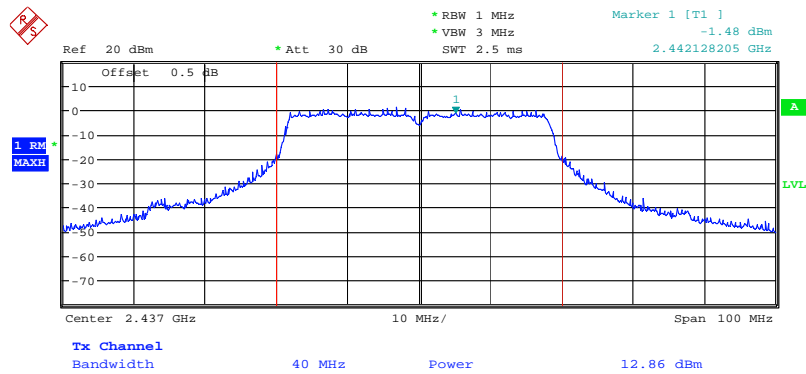

Date: 22.MAR.2008 15:49:10

Conducted Output Power Plot on Configuration Draft n MCS8 40MHz Ant. 2-3/ 2437 MHz

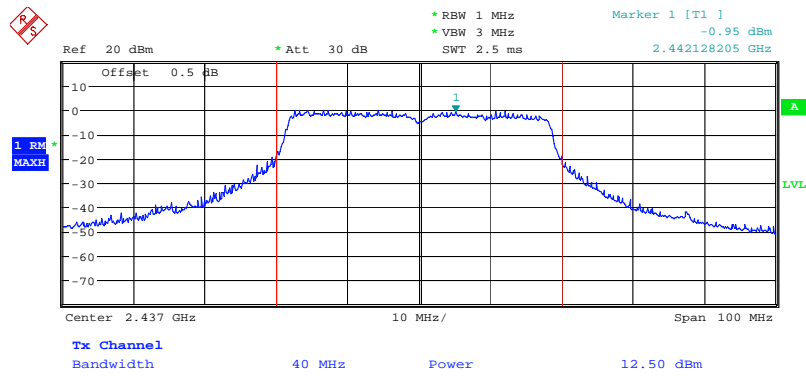

Date: 22.MAR.2008 15:51:39

Conducted Output Power Plot on Configuration Draft n MCS8 40MHz Ant. 2-1/ 2452 MHz

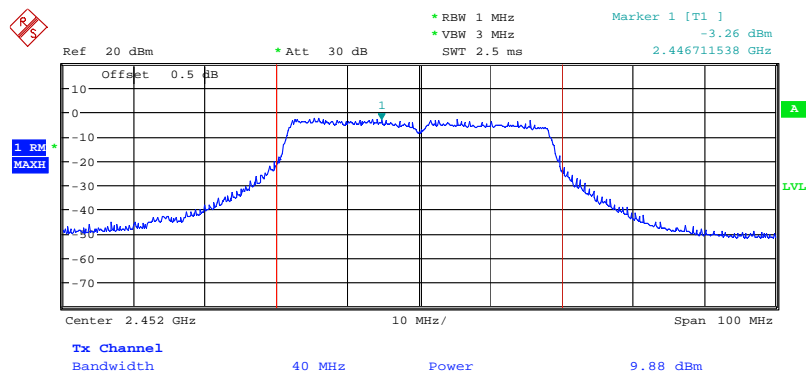

Date: 22.MAR.2008 15:53:45

Conducted Output Power Plot on Configuration Draft n MCS8 40MHz Ant. 2-2/ 2452 MHz

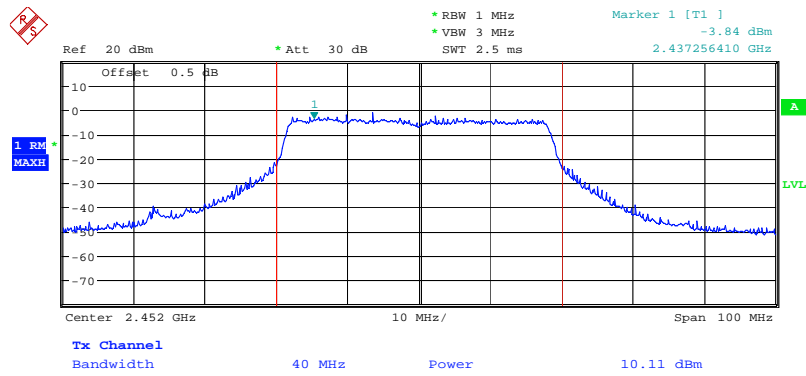

Date: 22.MAR.2008 15:55:23

Conducted Output Power Plot on Configuration Draft n MCS8 40MHz Ant. 2-3/ 2452 MHz

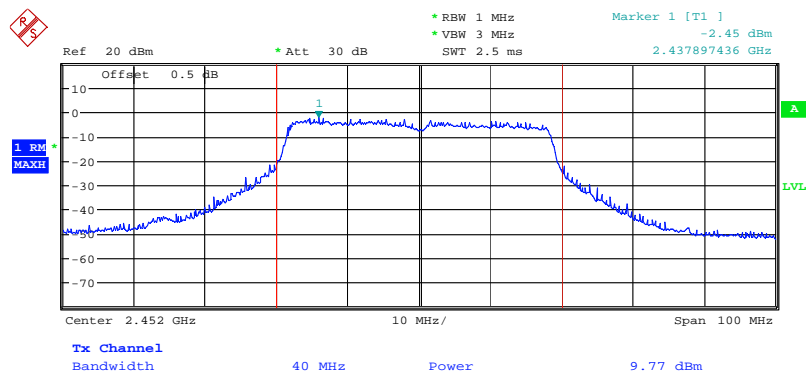

Date: 22.MAR.2008 15:57:44

Conducted Output Power Plot on Configuration Draft n MCS8 20MHz Ant. 3-1/ 2412 MHz

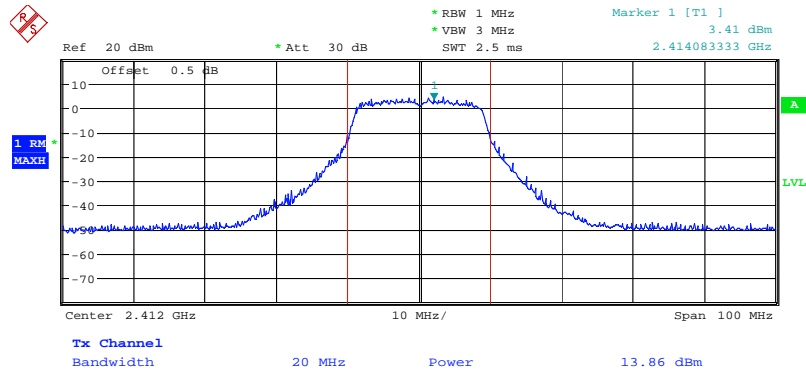

Date: 22.MAR.2008 15:29:28

Conducted Output Power Plot on Configuration Draft n MCS8 20MHz Ant. 3-2/ 2412 MHz

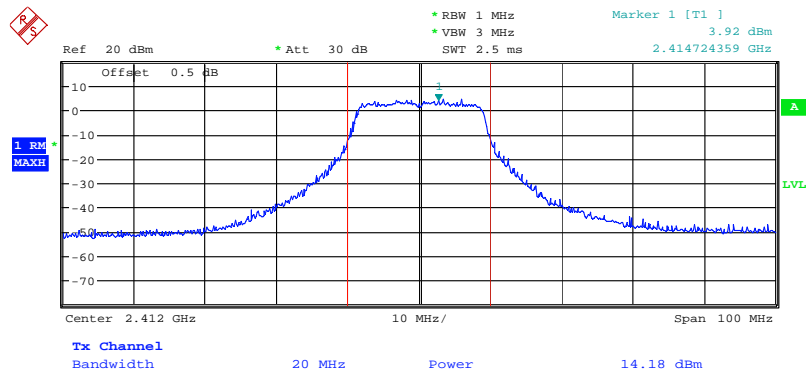

Date: 22.MAR.2008 15:28:39

Conducted Output Power Plot on Configuration Draft n MCS8 20MHz Ant. 3-3/ 2412 MHz

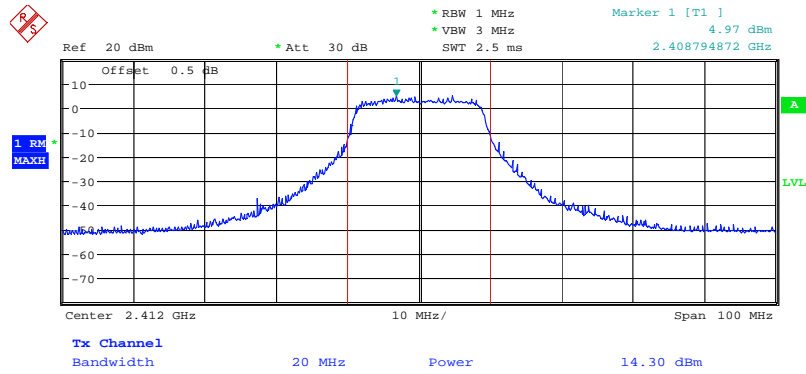

Date: 22.MAR.2008 15:27:37

Conducted Output Power Plot on Configuration Draft n MCS8 20MHz Ant. 3-1/ 2437 MHz

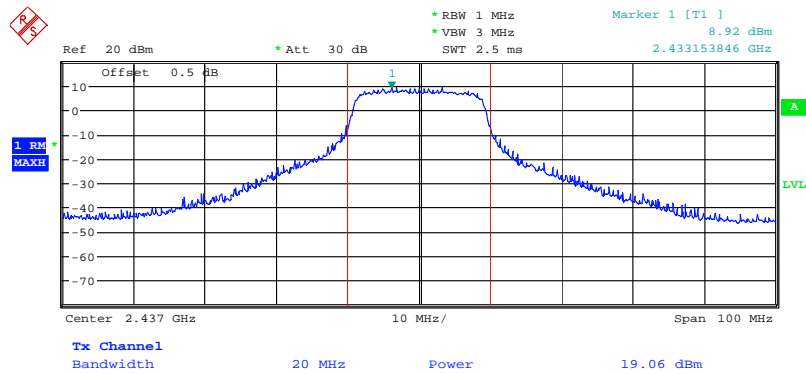

Date: 22.MAR.2008 15:19:52

Conducted Output Power Plot on Configuration Draft n MCS8 20MHz Ant. 3-2/ 2437 MHz

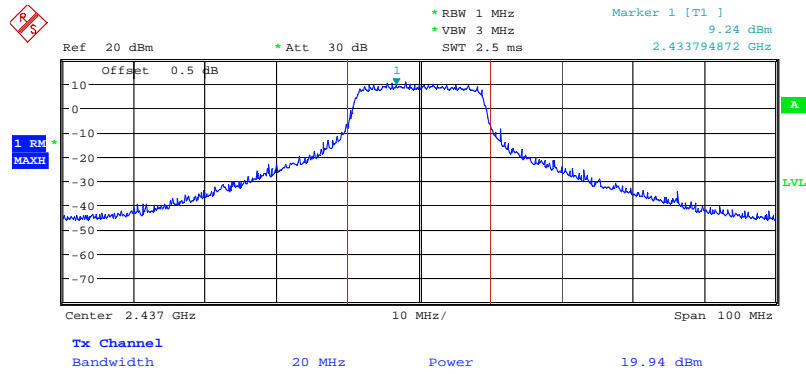

Date: 22.MAR.2008 15:21:14

Conducted Output Power Plot on Configuration Draft n MCS8 20MHz Ant. 3-3/ 2437 MHz

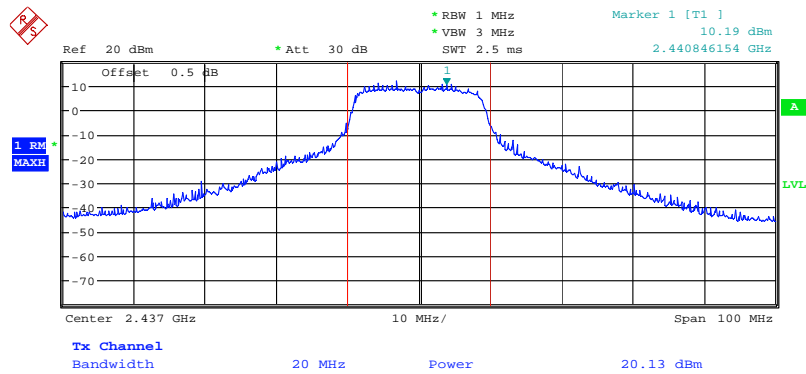

Date: 22.MAR.2008 15:24:03

Conducted Output Power Plot on Configuration Draft n MCS8 20MHz Ant. 3-1/ 2462 MHz

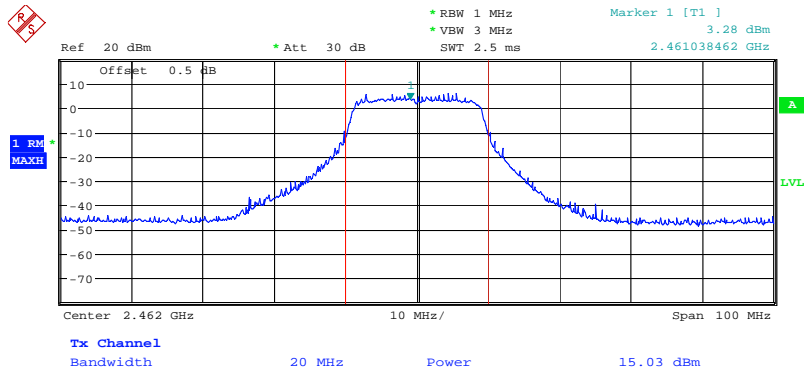

Date: 21.MAR.2008 15:18:07

Conducted Output Power Plot on Configuration Draft n MCS8 20MHz Ant. 3-2/ 2462 MHz

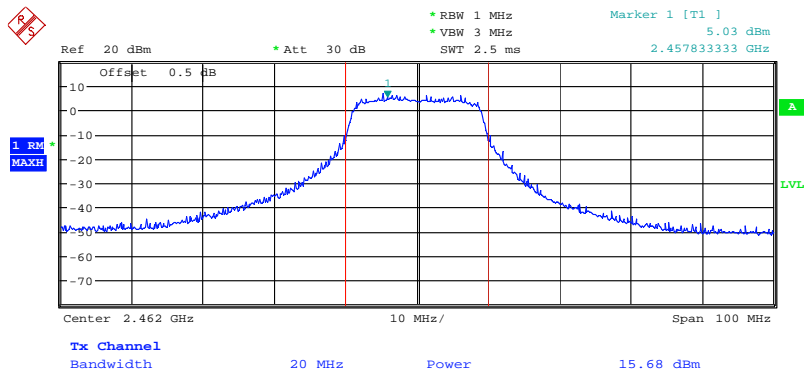

Date: 21.MAR.2008 15:17:24

Conducted Output Power Plot on Configuration Draft n MCS8 20MHz Ant. 3-3/ 2462 MHz

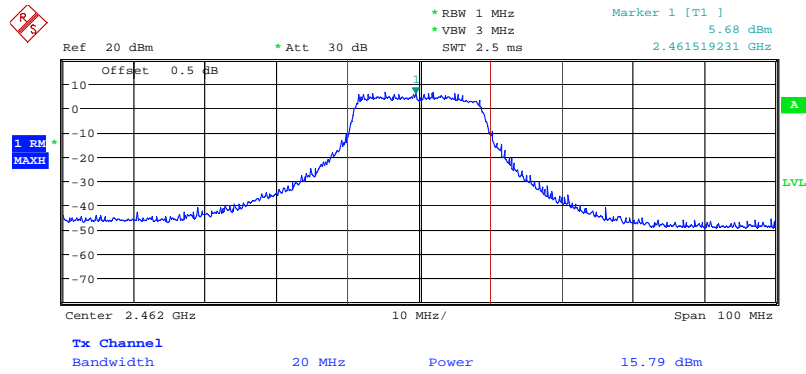

Date: 21.MAR.2008 15:16:27

Conducted Output Power Plot on Configuration Draft n MCS8 40MHz Ant. 3-1/ 2422 MHz

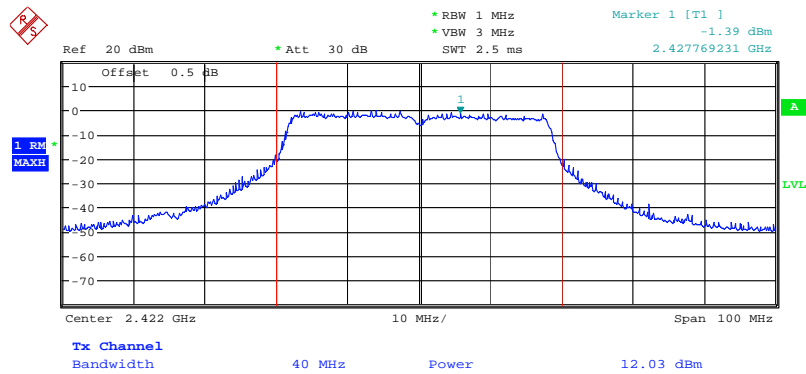

Date: 22.MAR.2008 15:41:38

Conducted Output Power Plot on Configuration Draft n MCS8 40MHz Ant. 3-2/ 2422 MHz

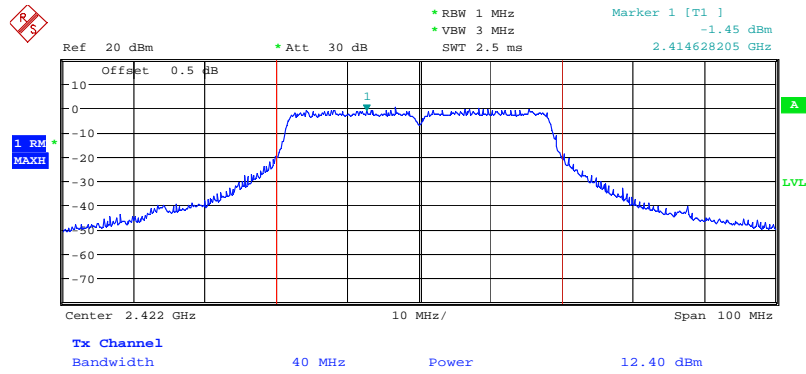

Date: 22.MAR.2008 15:42:37

Conducted Output Power Plot on Configuration Draft n MCS8 40MHz Ant. 3-3/ 2422 MHz

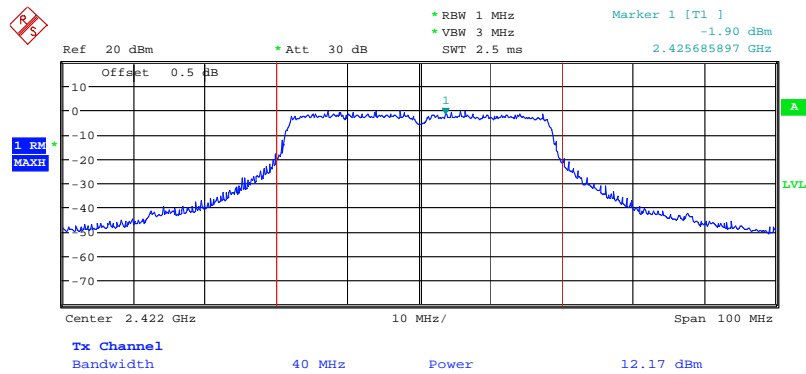

Date: 22.MAR.2008 15:43:25

Conducted Output Power Plot on Configuration Draft n MCS8 40MHz Ant. 3-1/ 2437 MHz

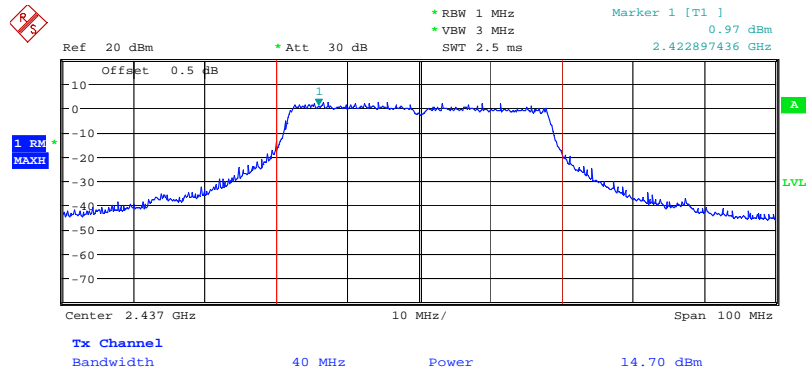

Date: 22.MAR.2008 15:46:27

Conducted Output Power Plot on Configuration Draft n MCS8 40MHz Ant. 3-2/ 2437 MHz

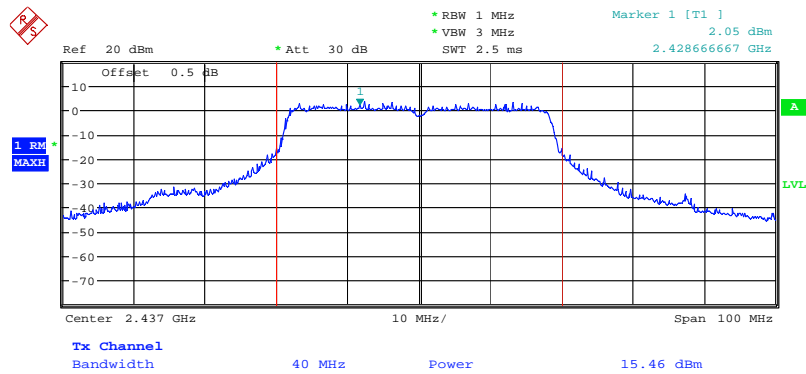

Date: 22.MAR.2008 15:45:33

Conducted Output Power Plot on Configuration Draft n MCS8 40MHz Ant. 3-3/ 2437 MHz

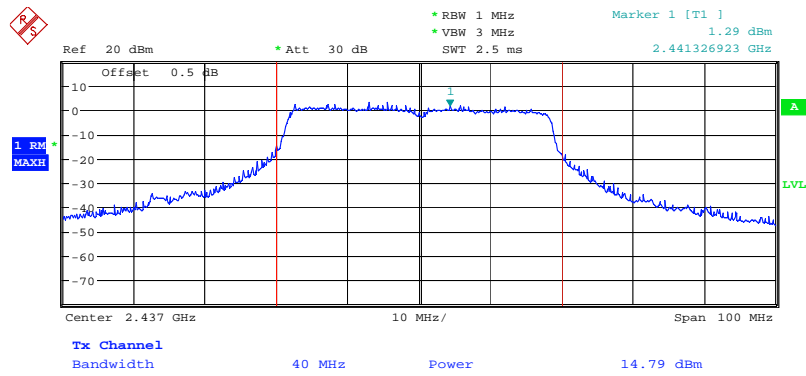

Date: 22.MAR.2008 15:44:32

Conducted Output Power Plot on Configuration Draft n MCS8 40MHz Ant. 3-1/ 2452 MHz

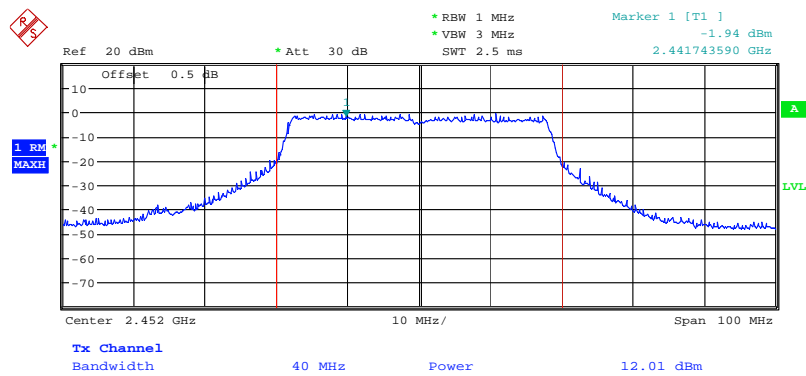

Date: 22.MAR.2008 16:01:29

Conducted Output Power Plot on Configuration Draft n MCS8 40MHz Ant. 3-2/ 2452 MHz

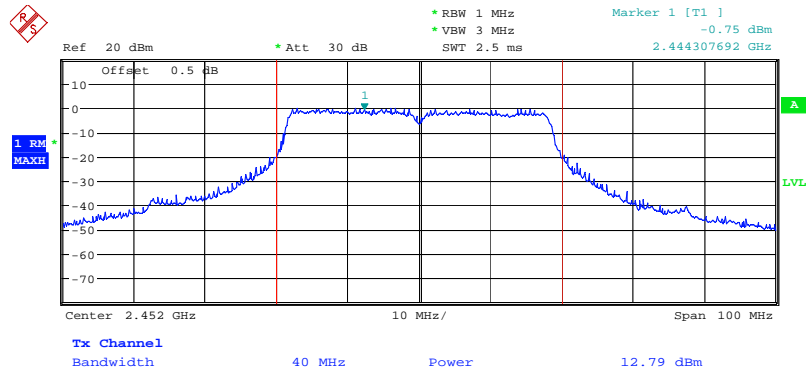

Date: 22.MAR.2008 16:00:19

Conducted Output Power Plot on Configuration Draft n MCS8 40MHz Ant. 3-3/ 2452 MHz

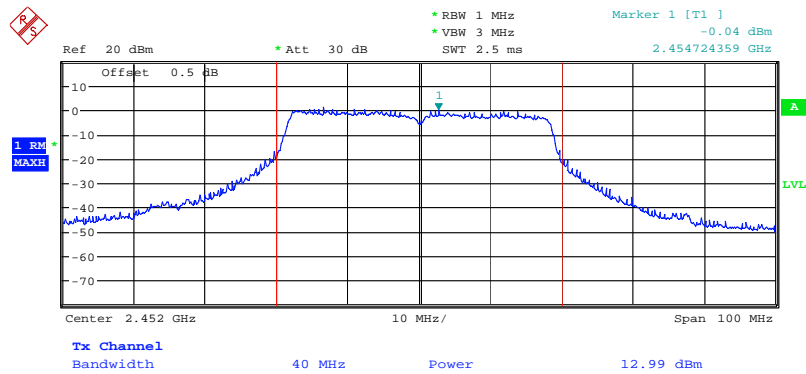

Date: 22.MAR.2008 15:59:15

Conducted Output Power Plot on Configuration Draft n MCS8 20MHz Ant. 4-1/ 2412 MHz

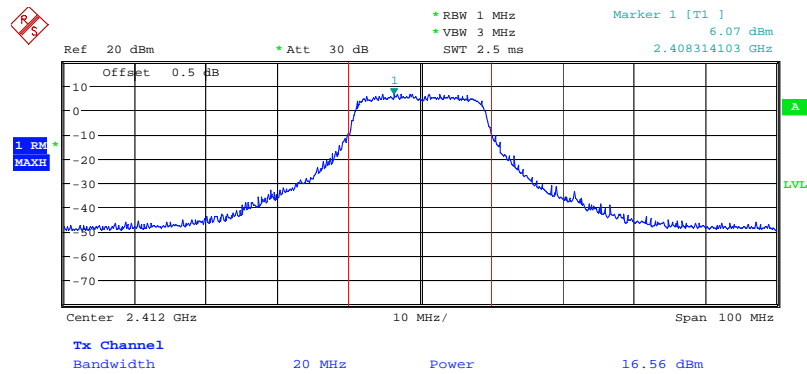

Date: 21.MAR.2008 18:37:40

Conducted Output Power Plot on Configuration Draft n MCS8 20MHz Ant. 4-2/ 2412 MHz

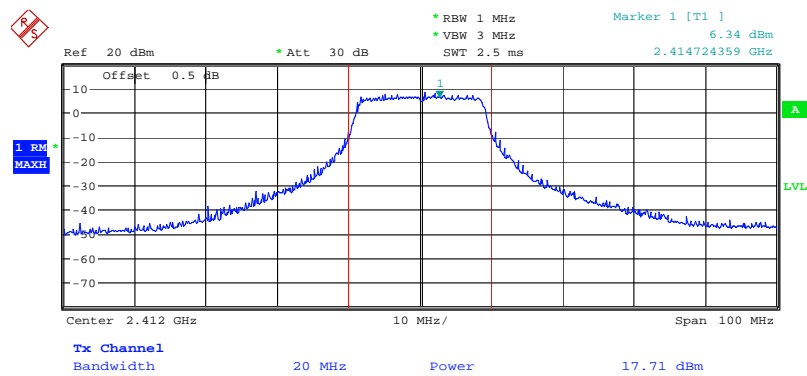

Date: 21.MAR.2008 18:40:20

Conducted Output Power Plot on Configuration Draft n MCS8 20MHz Ant. 4-3/ 2412 MHz

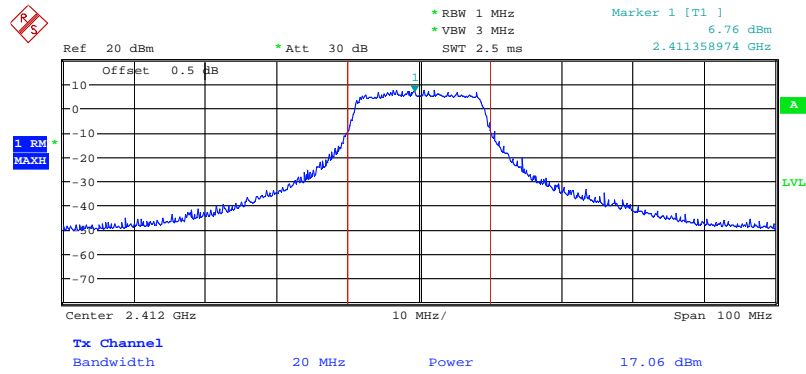

Date: 21.MAR.2008 18:41:38

Conducted Output Power Plot on Configuration Draft n MCS8 20MHz Ant. 4-1/ 2437 MHz

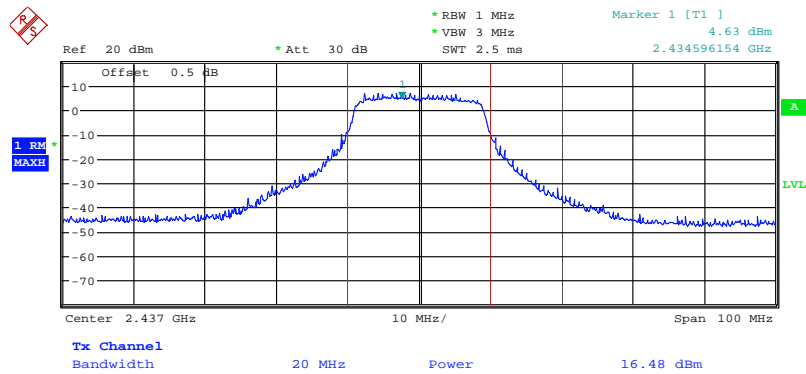

Date: 21.MAR.2008 18:36:18

Conducted Output Power Plot on Configuration Draft n MCS8 20MHz Ant. 4-2/ 2437 MHz

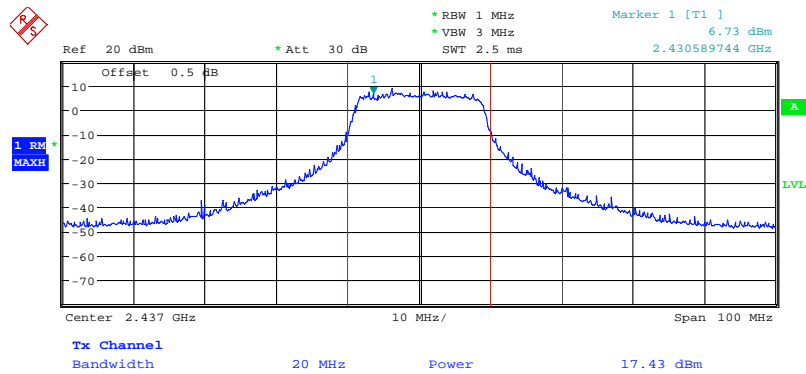

Date: 21.MAR.2008 18:35:06

Conducted Output Power Plot on Configuration Draft n MCS8 20MHz Ant. 4-3/ 2437 MHz

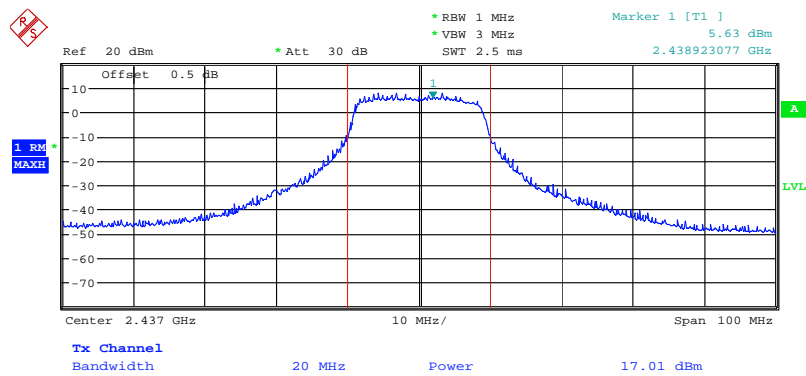

Date: 21.MAR.2008 18:33:49

Conducted Output Power Plot on Configuration Draft n MCS8 20MHz Ant. 4-1/ 2462 MHz

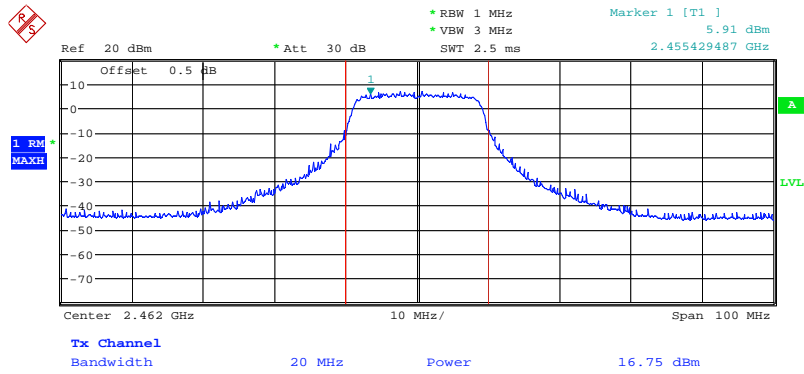

Date: 21.MAR.2008 18:28:35

Conducted Output Power Plot on Configuration Draft n MCS8 20MHz Ant. 4-2/ 2462 MHz

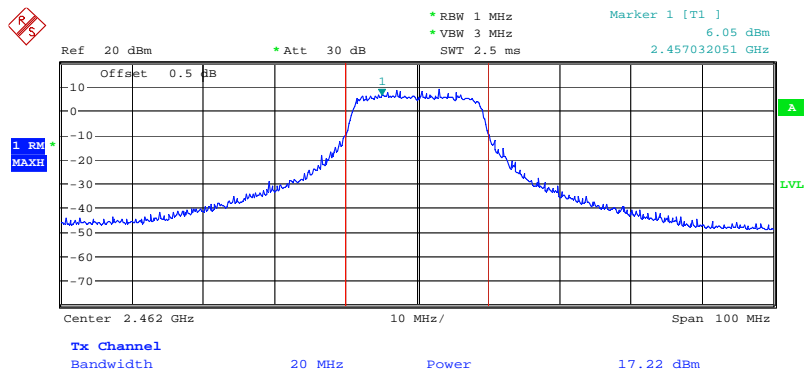

Date: 21.MAR.2008 18:29:26

Conducted Output Power Plot on Configuration Draft n MCS8 20MHz Ant. 4-3/ 2462 MHz

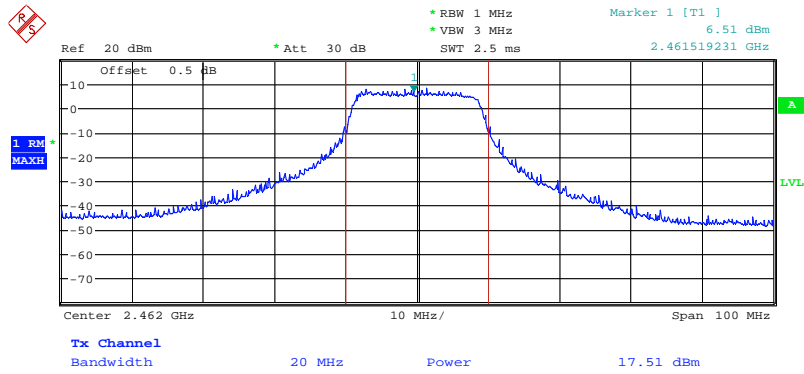

Date: 21.MAR.2008 18:30:22

Conducted Output Power Plot on Configuration Draft n MCS8 40MHz Ant. 4-1/ 2422 MHz

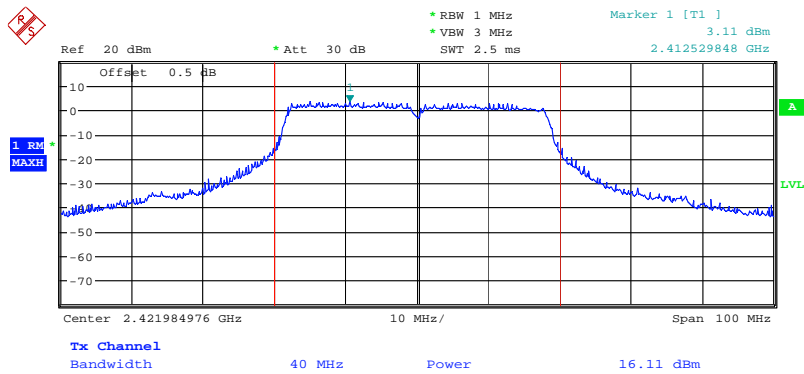

Date: 21.MAR.2008 18:14:08