



SPORTON International Inc.

No. 52, Hwa Ya 1st Rd., Kwei-Shan Hsiang, TaoYuan Hsien, Taiwan, R.O.C.
Ph: 886-3-327-3456 / FAX: 886-3-327-0973 / www.sporton.com.tw

FCC RADIO TEST REPORT

Applicant's company	Motorola Solutions, Inc.
Applicant Address	One Motorola Plaza Holtsville, NY 11742 USA
FCC ID	UZ7AP0622
Manufacturer's company	Joy Technology (ShenZhen) Corporation
Manufacturer Address	HengKeng Ind., Shangpai, Shangwu,Aiqun Rd., Shiyan Town,Shenzhen 518108 China

Product Name	Wireless Dual Band AP
Brand Name	MOTOROLA
Model Name	AP-0622
Test Rule Part(s)	47 CFR FCC Part 15 Subpart C § 15.247
Test Freq. Range	2400 ~ 2483.5MHz / 5725 ~ 5850MHz
Received Date	Sep. 22, 2011
Final Test Date	Jan. 09, 2013
Submission Type	Class II Change



Statement

Test result included is only for the IEEE 802.11n, IEEE 802.11b/g part and IEEE 802.11a (5725 ~ 5850MHz) of the product.

The test result in this report refers exclusively to the presented test model / sample.

Without written approval of SPORTON International Inc., the test report shall not be reproduced except in full.

The measurements and test results shown in this test report were made in accordance with the procedures and found in compliance with the limit given in ANSI C63.10-2009, 47 CFR FCC Part 15 Subpart C, KDB 558074 D01 v02 and KDB 662911 D01 v01r02.

The test equipment used to perform the test is calibrated and traceable to NML/ROC.





Table of Contents

1. CERTIFICATE OF COMPLIANCE	1
2. SUMMARY OF THE TEST RESULT	2
3. GENERAL INFORMATION	3
3.1. Product Details.....	3
3.2. Accessories.....	5
3.3. Table for Filed Antenna.....	6
3.4. Table for Carrier Frequencies	10
3.5. Table for Test Modes	11
3.6. Table for Testing Locations.....	14
3.7. Table for Class II Change	15
3.8. Table for Supporting Units	15
3.9. Test Configurations	16
4. TEST RESULT	20
4.1. AC Power Line Conducted Emissions Measurement.....	20
4.2. Maximum Conducted Output Power Measurement.....	26
4.3. Power Spectral Density Measurement	31
4.4. 6dB Spectrum Bandwidth Measurement	44
4.5. Radiated Emissions Measurement	55
4.6. Band Edge Emissions Measurement	95
4.7. Antenna Requirements	126
5. LIST OF MEASURING EQUIPMENTS	127
6. TEST LOCATION.....	129
APPENDIX A. TEST PHOTOS	A1 ~ A7
APPENDIX B. MAXIMUM PERMISSIBLE EXPOSURE	B1 ~ B3
APPENDIX C. CO-LOCATION REPORT.....	C1 ~ C3

1. CERTIFICATE OF COMPLIANCE

Product Name : Wireless Dual Band AP
Brand Name : MOTOROLA
Model Name : AP-0622
Applicant : Motorola Solutions, Inc.
Test Rule Part(s) : 47 CFR FCC Part 15 Subpart C § 15.247

Sporton International as requested by the applicant to evaluate the EMC performance of the product sample received on Sep. 22, 2011 would like to declare that the tested sample has been evaluated and found to be in compliance with the tested rule parts. The data recorded as well as the test configuration specified is true and accurate for showing the sample's EMC nature.

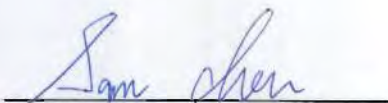

Sam Chen

SPORTON INTERNATIONAL INC.

2. SUMMARY OF THE TEST RESULT

Applied Standard: 47 CFR FCC Part 15 Subpart C				
Part	Rule Section	Description of Test	Result	Under Limit
4.1	15.207	AC Power Line Conducted Emissions	Complies	10.20 dB
4.2	15.247(b)(3)	Maximum Conducted Output Power	Complies	1.69 dB
4.3	15.247(e)	Power Spectral Density	Complies	6.77 dB
4.4	15.247(a)(2)	6dB Spectrum Bandwidth	Complies	-
4.5	15.247(d)	Radiated Emissions	Complies	0.01 dB
4.6	15.247(d)	Band Edge Emissions	Complies	0.03 dB
4.7	15.203	Antenna Requirements	Complies	-

Test Items	Uncertainty	Remark
AC Power Line Conducted Emissions	±2.3dB	Confidence levels of 95%
Maximum Conducted Output Power	±0.8dB	Confidence levels of 95%
Power Spectral Density	±0.5dB	Confidence levels of 95%
6dB Spectrum Bandwidth	±8.5×10 ⁻⁸	Confidence levels of 95%
Radiated Emissions (9kHz~30MHz)	±0.8dB	Confidence levels of 95%
Radiated Emissions (30MHz~1000MHz)	±1.9dB	Confidence levels of 95%
Radiated / Band Edge Emissions (1GHz~18GHz)	±1.9dB	Confidence levels of 95%
Radiated Emissions (18GHz~40GHz)	±1.9dB	Confidence levels of 95%
Temperature	±0.7°C	Confidence levels of 95%
Humidity	±3.2%	Confidence levels of 95%
DC / AC Power Source	±1.4%	Confidence levels of 95%

3. GENERAL INFORMATION

3.1. Product Details

IEEE 802.11n

Items	Description
Product Type	Please refer to section 3.3
Radio Type	Intentional Transceiver
Power Type	From POE
Modulation	see the below table for IEEE 802.11n
Data Modulation	OFDM (BPSK / QPSK / 16QAM / 64QAM)
Data Rate (Mbps)	see the below table for IEEE 802.11n
Frequency Range	2400 ~ 2483.5MHz / 5725 ~ 5850MHz
Channel Number	For 2.4GHz Band: 11 for 20MHz bandwidth ; 7 for 40MHz bandwidth For 5GHz Band: 5 for 20MHz bandwidth ; 2 for 40MHz bandwidth
Channel Band Width (99%)	For Mode 1. EUT 2 (with internal antenna) + Ant. 18 (Embedded antenna) / Radio 1 (2.4GHz band): MCS0 (20MHz): 18.64 MHz ; MCS0 (40MHz): 36.48 MHz For Mode 2. EUT 2 (with internal antenna) + Ant. 19 (Embedded antenna) / Radio 2 (2.4GHz + 5GHz band): For 2.4GHz Band: MCS0 (20MHz): 18.00 MHz ; MCS0 (40MHz): 36.80 MHz For 5GHz Band: MCS0 (20MHz): 18.08 MHz ; MCS0 (40MHz): 36.64 MHz
Maximum Conducted Output Power	For Mode 1. EUT 2 (with internal antenna) + Ant. 18 (Embedded antenna) / Radio 1 (2.4GHz band): MCS0 (20MHz): 27.08 dBm ; MCS0 (40MHz): 20.69 dBm For Mode 2. EUT 2 (with internal antenna) + Ant. 19 (Embedded antenna) / Radio 2 (2.4GHz + 5GHz band): For 2.4GHz Band: MCS0 (20MHz): 27.00 dBm ; MCS0 (40MHz): 23.22 dBm For 5GHz Band: MCS0 (20MHz): 23.31 dBm ; MCS0 (40MHz): 22.71 dBm
Carrier Frequencies	Please refer to section 3.4
Antenna	Please refer to section 3.3

802.11a/b/g

Items	Description
Product Type	Please refer to section 3.3
Radio Type	Intentional Transceiver
Power Type	From POE
Modulation	DSSS for IEEE 802.11b ; OFDM for IEEE 802.11a/g
Data Modulation	DSSS (BPSK / QPSK / CCK) ; OFDM (BPSK / QPSK / 16QAM / 64QAM)
Data Rate (Mbps)	DSSS (1/ 2/ 5.5/11) ; OFDM (6/9/12/18/24/36/48/54)
Frequency Range	2400 ~ 2483.5MHz / 5725 ~ 5850MHz
Channel Number	11b/g: 11 ; 11a: 5
Channel Band Width (99%)	<p>For Mode 1. EUT 2 (with internal antenna) + Ant. 18 (Embedded antenna) / Radio 1 (2.4GHz band): 11b: 14.08 MHz ; 11g: 18.24 MHz</p> <p>For Mode 2. EUT 2 (with internal antenna) + Ant. 19 (Embedded antenna) / Radio 2 (2.4GHz + 5GHz band): 11b: 14.00 MHz ; 11g: 16.96 MHz ; 11a: 16.24 MHz</p>
Maximum Conducted Output Power	<p>For Mode 1. EUT 2 (with internal antenna) + Ant. 18 (Embedded antenna) / Radio 1 (2.4GHz band): 11b: 24.84 dBm ; 11g: 27.24 dBm</p> <p>For Mode 2. EUT 2 (with internal antenna) + Ant. 19 (Embedded antenna) / Radio 2 (2.4GHz + 5GHz band): 11b: 24.20 dBm ; 11g: 27.23 dBm ; 11a: 22.96 dBm</p>
Carrier Frequencies	Please refer to section 3.4
Antenna	Please refer to section 3.3

Outdoor Version: The outdoor version of the MODEL: AP-0622 Access Point is sold under Part Number: AP-6562.

IEEE 802.11n spec

MCS Index	Nss	Modulation	R	NBPS	NCBPS		NDBPS		Datarate(Mbps)			
					20MHz	40MHz	20MHz	40MHz	800nsGI		400nsGI	
									20MHz	40MHz	20MHz	40MHz
0	1	BPSK	1/2	1	52	108	26	54	6.5	13.5	7.200	15
1	1	QPSK	1/2	2	104	216	52	108	13.0	27.0	14.400	30
2	1	QPSK	3/4	2	104	216	78	162	19.5	40.5	21.700	45
3	1	16-QAM	1/2	4	208	432	104	216	26.0	54.0	28.900	60
4	1	16-QAM	3/4	4	208	432	156	324	39.0	81.0	43.300	90
5	1	64-QAM	2/3	6	312	648	208	432	52.0	108.0	57.800	120
6	1	64-QAM	3/4	6	312	648	234	486	58.5	121.5	65.000	135
7	1	64-QAM	5/6	6	312	648	260	540	65.0	135.0	72.200	150
8	2	BPSK	1/2	1	104	216	52	108	13.0	27.0	14.444	30
9	2	QPSK	1/2	2	208	432	104	216	26.0	54.0	28.889	60
10	2	QPSK	3/4	2	208	432	156	324	39.0	81.0	43.333	90
11	2	16-QAM	1/2	4	416	864	208	432	52.0	108.0	57.778	120
12	2	16-QAM	3/4	4	416	864	312	648	78.0	162.0	86.667	180
13	2	64-QAM	2/3	6	624	1296	416	864	104.0	216.0	115.556	240
14	2	64-QAM	3/4	6	624	1296	468	972	117.0	243.0	130.000	270
15	2	64-QAM	5/6	6	624	1296	520	1080	130.0	270.0	144.444	300

Symbol	Explanation
NSS	Number of spatial streams
R	Code rate
NBPS	Number of coded bits per single carrier
NCBPS	Number of coded bits per symbol
NDBPS	Number of data bits per symbol
GI	guard interval

3.2. Accessories

N/A

3.3. Table for Filed Antenna

Ant.	Model Name	Antenna Type	Chip/Radio	Gain (dBi)	
				2.4GHz	5GHz
1	ML-2499-FHPA9-01R	Dipole	Radio1/2-CH1/2	8.5	-
2	ML-2499-SD3-01R	Patch	Radio1/2-CH1/2	3.5	-
3	ML-2499-BPNA3-01R	Panel	Radio1/2-CH1/2	10.9	-
4	ML-2499-BYGA2-01R	Yagi	Radio1/2-CH1/2	11.1	-
5	ML-5299-FHPA10-01R	Dipole	Radio1/2-CH1/2	-	9
6	ML-5299-PTA1-01R	Patch	Radio1/2-CH1/2	-	4.6
7	ML-5299-WPNA1-01R	Panel	Radio1/2-CH1/2	-	12.5
8	ML-5299-BYGA15-012	Yagi	Radio1/2-CH1/2	-	11
9	ML-2499-5PNL-72-N	Panel	Radio1/2-CH1/2	5	-
10	ML-2499-APA2-01	Dipole	Radio1/2-CH1/2	2	-
11	ML-2499-HPA3-01R	Dipole	Radio1/2-CH1/2	4.7	-
12	ML-5299-APA1-01R	Dipole	Radio1/2-CH1/2	-	2
13	ML-5299-HPA1-01R	Dipole	Radio1/2-CH1/2	-	5
14	ML-2452-APA2-01	Dipole	Radio1/2-CH1/2	3	5
15	ML-2452-PNA5-01R	Panel	Radio1/2-CH1/2	4.5	5
16	ML-2452-PNA7-01R	Panel	Radio1/2-CH1/2	7	9
17	ML-2452-HPA5-036	Dipole	Radio1/2-CH1/2	3	5
18	120G00000038A	Embedded	Radio1-CH1	7.07	-
	120G00000038A	Embedded	Radio1-CH2	6.27	-
19	120G00000037A	Embedded	Radio2-CH1	5.72	7.15
	120G00000037A	Embedded	Radio2-CH2	6.84	6.34
20	ML-2499-HPA8-01	Dipole	Radio1/2-CH1/2	8	-
21	ML-2499-HPA4-01	Dipole	Radio1/2-CH1/2	4	-
22	RAN4054A	Dipole	Radio1/2-CH1/2	8	-
23	ML-5299-HPA5-01	Dipole	Radio1/2-CH1/2	-	5
24	ML-5299-FHPA6-01	Dipole	Radio1/2-CH1/2	-	8
25	ML-2452-HPAG5A8-01	Dipole	Radio1/2-CH1/2	7.5	8.0

Antenna	Antenna Gain		Cable loss		Test Antenna Gain	
	2.4GHz	5GHz	2.4GHz	5GHz	2.4GHz	5GHz
1	9	-	0.5	-	8.5	-
2	3.5	-	0.0	-	3.5	-
3	13.9	-	3.0	-	10.9	-
4	14.1	-	3.0	-	11.1	-
5	-	10	-	1	-	9
6	-	4.6	-	0.0	-	4.6
7	-	12.5	-	0.0	-	12.5
8	-	12	-	1	-	11
9	5	-	0.0	-	5	-
10	2	-	0.0	-	2	-
11	4.7	-	0.0	-	4.7	-
12	-	2	-	0.0	-	2
13	-	5	-	0.0	-	5
14	3	5	0.0	0.0	3	5
15	4.5	5	0.0	0.0	4.5	5
16	7	9	0.0	0.0	7	9
17	3	5	0.0	0.0	3	5
18	7.07	-	0.0	-	7.07	-
	6.27	-	0.0	-	6.27	-
19	5.72	7.15	0.0	0.0	5.72	7.15
	6.84	6.34	0.0	0.0	6.84	6.34
20	8	-	0.0	-	8	-
21	4	-	0.0	-	4	-
22	8	-	0.0	-	8	-
23	-	5	-	0.0	-	5
24	-	8	-	0.0	-	8
25	7.5	8	0.0	0.0	7.5	8

Note:

1. There are two types of EUT. One collocates with internal antenna only, and the other collocates with external antennas only.
2. There are two chips, Radio 1 and Radio 2 respectively. Radio 1 support Chain 2.4GHz function and Radio 2 support Chain 2.4GHz+5GHz function. Radio 1 is hardware configured as 2.4GHz only and Radio 2 is software restricted to 5GHz only.
3. Rx function is always 2Rx for 2Tx, but may be either 1Rx or 2Rx for 1Tx.
4. Ant. 1 ~ Ant. 17 are the original antennas, Ant. 18 ~ Ant. 25 are additional antennas.
The gain of additional external antennas (Ant. 20 ~ Ant. 25) is lower than original antennas (Ant. 1 ~ Ant. 17), and the test result is recorded in original report (Sporton Report No.: FR192220).

Table of TX/RX Function in each antenna:

Item			Radio 1				Radio 2			
			Chain 1		Chain 2		Chain 1		Chain 2	
			TX	RX	TX	RX	TX	RX	TX	RX
Ant. 18	2.4GHz	*11b	-	V	V	V	-	-	-	-
		11g	V	V	V	V	-	-	-	-
		11n	V	V	V	V	-	-	-	-
Ant. 19	2.4GHz	*11b	-	-	-	-	V	V	-	V
		11g	-	-	-	-	V	V	V	V
		11n	-	-	-	-	V	V	V	V
	5GHz	11a	-	-	-	-	V	V	V	V
		11n	-	-	-	-	V	V	V	V

Note: Marked "-" on behalf of no function.

Marked "*" Rx function may be either 1Rx or 2Rx for 1Tx.

Radio 1 support Chain 2 and Radio 2 support Chain 1 when perform the 1TX function.

Chip/Radio	Required 1TX Port
Radio 1-2.4G	Chain 2
Radio 2-2.4G	Chain 1
Radio 2-5G	Chain 1

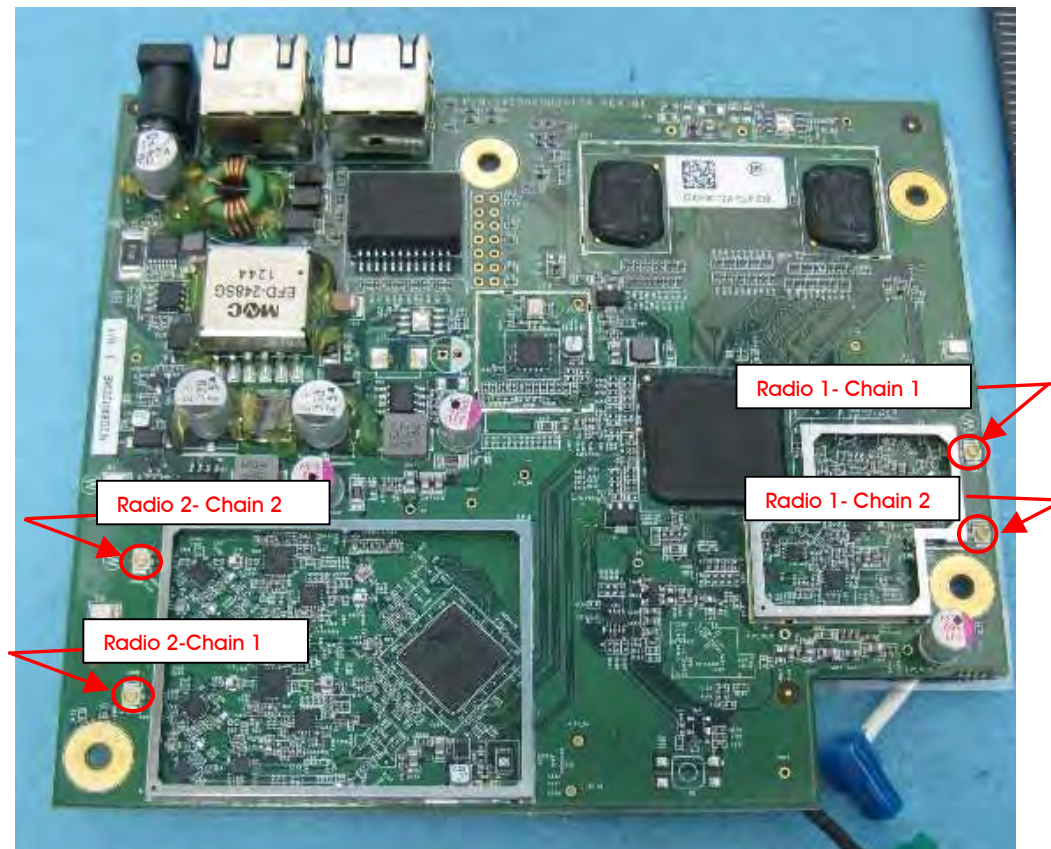

3.4. Table for Carrier Frequencies

For 2.4GHz Band:

For IEEE 802.11b/g, use Channel 1~Channel 11.

There are two bandwidth systems for IEEE 802.11n.

For both 20MHz bandwidth systems, use Channel 1~Channel 11.

For both 40MHz bandwidth systems, use Channel 3~Channel 9.

Frequency Band	Channel No.	Frequency	Channel No.	Frequency
2400~2483.5MHz	1	2412 MHz	7	2442 MHz
	2	2417 MHz	8	2447 MHz
	3	2422 MHz	9	2452 MHz
	4	2427 MHz	10	2457 MHz
	5	2432 MHz	11	2462 MHz
	6	2437 MHz	-	-

For 5GHz Band:

For IEEE 802.11a, use Channel 149, 153, 157, 161, 165.

There are two bandwidth systems for IEEE 802.11n.

For 20MHz bandwidth systems, use Channel 149, 153, 157, 161, 165.

For 40MHz bandwidth systems, use Channel 151, 159.

Frequency Band	Channel No.	Frequency	Channel No.	Frequency
5725~5850 MHz Band 4	149	5745 MHz	159	5795 MHz
	151	5755 MHz	161	5805 MHz
	153	5765 MHz	165	5825 MHz
	157	5785 MHz		

3.5. Table for Test Modes

Preliminary tests were performed in different data rate to find the worst radiated emission. The data rate shown in the table below is the worst-case rate with respect to the specific test item. Investigation has been done on all the possible configurations for searching the worst cases. The following table is a list of the test modes shown in this test report.

For Mode 1. EUT 2 (with internal antenna) + Ant. 18 (Embedded antenna) / Radio 1 (2.4GHz band):

Test Items	Mode	Data Rate	Channel	Chain
AC Power Line Conducted Emissions	Normal Link	Auto	-	-
Maximum Conducted Output Power	MCS0/20MHz	6.5 Mbps	1/6/11	1/2/1+2
	MCS0/40MHz	13.5 Mbps	3/6/9	1/2/1+2
	11b/CCK	1 Mbps	1/6/11	2
	11g/BPSK	6 Mbps	1/6/11	1/2/1+2
Power Spectral Density	MCS0/20MHz	6.5 Mbps	1/6/11	1/2
	MCS0/40MHz	13.5 Mbps	3/6/9	1/2
	11b/CCK	1 Mbps	1/6/11	2
	11g/BPSK	6 Mbps	1/6/11	1/2
6dB Spectrum Bandwidth	MCS0/20MHz	6.5 Mbps	1/6/11	1+2
	MCS0/40MHz	13.5 Mbps	3/6/9	1+2
	11b/CCK	1 Mbps	1/6/11	2
	11g/BPSK	6 Mbps	1/6/11	1+2
Radiated Emissions Below 1GHz	Normal Link	Auto	-	-
Radiated Emissions Above 1GHz	MCS0/20MHz	6.5 Mbps	1/6/11	1+2
	MCS0/40MHz	13.5 Mbps	3/6/9	1+2
	11b/CCK	1 Mbps	1/6/11	2
	11g/BPSK	6 Mbps	1/6/11	1+2
Band Edge Emissions	MCS0/20MHz	6.5 Mbps	1/11	1+2
	MCS0/40MHz	13.5 Mbps	3/9	1+2
	11b/CCK	1 Mbps	1/11	2
	11g/BPSK	6 Mbps	1/11	1+2

For Mode 2. EUT 2 (with internal antenna) + Ant. 19 (Embedded antenna) / Radio 2 (2.4GHz + 5GHz band):

<For 2.4GHz Band>

Test Items	Mode	Data Rate	Channel	Chain
AC Power Line Conducted Emissions	Normal Link	Auto	-	-
Maximum Conducted Output Power	MCS0/20MHz	6.5 Mbps	1/6/11	1/2/1+2
	MCS0/40MHz	13.5 Mbps	3/6/9	1/2/1+2
	11b/CCK	1 Mbps	1/6/11	1
	11g/BPSK	6 Mbps	1/6/11	1/2/1+2
Power Spectral Density	MCS0/20MHz	6.5 Mbps	1/6/11	1/2
	MCS0/40MHz	13.5 Mbps	3/6/9	1/2
	11b/CCK	1 Mbps	1/6/11	1
	11g/BPSK	6 Mbps	1/6/11	1/2
6dB Spectrum Bandwidth	MCS0/20MHz	6.5 Mbps	1/6/11	1+2
	MCS0/40MHz	13.5 Mbps	3/6/9	1+2
	11b/CCK	1 Mbps	1/6/11	1
	11g/BPSK	6 Mbps	1/6/11	1+2
Radiated Emissions Below 1GHz	Normal Link	Auto	-	-
Radiated Emissions Above 1GHz	MCS0/20MHz	6.5 Mbps	1/6/11	1+2
	MCS0/40MHz	13.5 Mbps	3/6/9	1+2
	11b/CCK	1 Mbps	1/6/11	1
	11g/BPSK	6 Mbps	1/6/11	1+2
Band Edge Emissions	MCS0/20MHz	6.5 Mbps	1/11	1+2
	MCS0/40MHz	13.5 Mbps	3/9	1+2
	11b/CCK	1 Mbps	1/11	1
	11g/BPSK	6 Mbps	1/11	1+2

<For 5GHz Band>

Test Items	Mode	Data Rate	Channel	Antenna
AC Power Line Conducted Emissions	Normal Link	Auto	-	-
Maximum Conducted Output Power	MCS0/20MHz	6.5 Mbps	149/157/165	1/2/1+2
	MCS0/40MHz	13.5 Mbps	151/159	1/2/1+2
	11a/BPSK	6 Mbps	149/157/165	1/2/1+2
Power Spectral Density	MCS0/20MHz	6.5 Mbps	149/157/165	1/2/1+2
	MCS0/40MHz	13.5 Mbps	151/159	1/2/1+2
	11a/BPSK	6 Mbps	149/157/165	1/2/1+2
6dB Spectrum Bandwidth	MCS0/20MHz	6.5 Mbps	149/157/165	1+2
	MCS0/40MHz	13.5 Mbps	151/159	1+2
	11a/BPSK	6 Mbps	149/157/165	1+2
Radiated Emissions Below 1GHz	Normal Link	Auto	-	-
Radiated Emissions Above 1GHz	MCS0/20MHz	6.5 Mbps	149/157/165	1+2
	MCS0/40MHz	13.5 Mbps	151/159	1+2
	11a/BPSK	6 Mbps	149/157/165	1+2
Band Edge Emissions	MCS0/20MHz	6.5 Mbps	149/157/165	1+2
	MCS0/40MHz	13.5 Mbps	151/159	1+2
	11a/BPSK	6 Mbps	149/157/165	1+2

The following test modes were performed for all tests:

There are two types of EUT.

EUT 1 collocates with external antennas.

EUT 2 collocates with internal antennas.

For Conducted emission test:

Mode 1. EUT 1 (with external antenna) + Dipole antenna / Ant. 1 and Ant. 5 + POE

Mode 2. EUT 2 (with internal antenna) + Embedded antenna / Ant. 18 and Ant. 19 + POE

For Radiated emission below 1GHz test:

The EUT for Radiated emission test was performed at vertically and horizontally horizontally, and the worst-case was found at vertically. So the measurement will follow this same test configuration.

Mode 1. EUT 1 (with external antenna) + Dipole antenna / Ant. 1 (2.4GHz) and Ant. 5 (5GHz)

Mode 2. EUT 1 (with external antenna) + Patch antenna / Ant. 2 (2.4GHz) and Ant. 6 (5GHz)

Mode 3. EUT 1 (with external antenna) + Panel antenna / Ant. 3 (2.4GHz) and Ant. 7 (5GHz)

Mode 4. EUT 1 (with external antenna) + Yagi antenna / Ant. 4 (2.4GHz) and Ant. 8 (5GHz)

Mode 5. EUT 2 (with internal antenna) + Embedded antenna / Ant. 18 (2.4GHz) and Ant. 19 (5GHz)

Mode 2 and Mode 5 generated the worst test result, so both of them were recorded in the report.

For Co-location test:

Mode 1. EUT 1 (with external antenna) + Yagi antenna / Ant. 4 (2.4GHz) and Ant. 8 (5GHz)

Mode 2. EUT 2 (with internal antenna) + Embedded antenna / Ant. 18 (2.4GHz) and Ant. 19 (5GHz)

For Radiated emission above 1GHz and other tests:

Mode 1. EUT 2 (with internal antenna) + Embedded antenna + Ant. 18 / Radio 1 (2.4GHz band)

Mode 2. EUT 2 (with internal antenna) + Embedded antenna + Ant. 19 / Radio 2 (2.4GHz + 5GHz band)

Note: For HT20/40 2TX, MCS8 (2-stream) limit are higher than MCS0 (1-stream) limits due to no array gain reduction on conducted limits. MCS8 signals on 2TX are completely uncorrelated when the direct mapping is configured. If antenna gain is greater than 5 dBi, this mode should be included to realize higher conducted testing limits.

For MPE and Co-location Test:

The EUT could be applied with 2.4GHz WLAN function and 5GHz WLAN function; therefore Maximum Permissible Exposure (Please refer to Appendix B) and Co-location (please refer to Appendix C) tests are added for simultaneously transmit between 2.4GHz WLAN function and 5GHz WLAN function.

3.6. Table for Testing Locations

Test Site No.	Site Category	Location	FCC Reg. No.	IC File No.
03CH01-CB	SAC	Hsin Chu	262045	IC 4086D
CO01-CB	Conduction	Hsin Chu	262045	IC 4086D
TH01-CB	OVEN Room	Hsin Chu	-	-

Open Area Test Site (OATS); Semi Anechoic Chamber (SAC); Please refer section 6 for Test Site Address.

3.7. Table for Class II Change

This product is an extension of original one reported under Sporton project number: FR192220

Below is the table for the change of the product with respect to the original one.

Description	Performance Checking
1. Change the housing of EUT. 2. Remove original embedded antennas as the list below: (1) 120G00000000A / 3.92dBi (2.4GHz) (2) 120G00000001A / 3.77dBi (2.4GHz) (3) 120G00000002A / 4.08dBi (2.4GHz), 7.5dBi (5GHz) (4) 120G00000003A / 4.44dBi (2.4GHz), 5.52dBi (5GHz) 3. Add two embedded antennas (Ant. 18 and Ant. 19). Please refer to section 3.3 for more detail information. 4. Add six dipole antennas. The gain of additional dipole antennas (Ant. 20 ~ Ant. 25) is lower than original antennas (Ant. 1 ~ Ant. 17). - No need for additional test. Please refer to section 3.3 for more detail information. 5. Change EUT operational environment to outdoor from indoor. The outdoor use device is not allowed to operate in 5GHz band 1. Therefore, the function of 5GHz band 1 is turned off. 6. No apply for the adaptor that recording in original report.	AC Power Line Conducted Emissions Maximum Conducted Output Power Power Spectral Density 6dB Spectrum Bandwidth Radiated Emissions Band Edge Emissions

3.8. Table for Supporting Units

Support Unit	Brand	Model	FCC ID
Notebook	DELL	E6250	E2K4965AGNM
Notebook	DELL	E6220	E2K4965AGNM
Notebook	DELL	E6220	E2K4965AGNM
PoE	POWERDsine	PD-3501G/AC	N/A
Notebook	DELL	M1330	E2KWM3945ABG

3.9. Test Configurations

3.9.1. Radiation Emissions Test Configuration

Test Configuration: 30MHz~1GHz

Test Mode: Mode 2

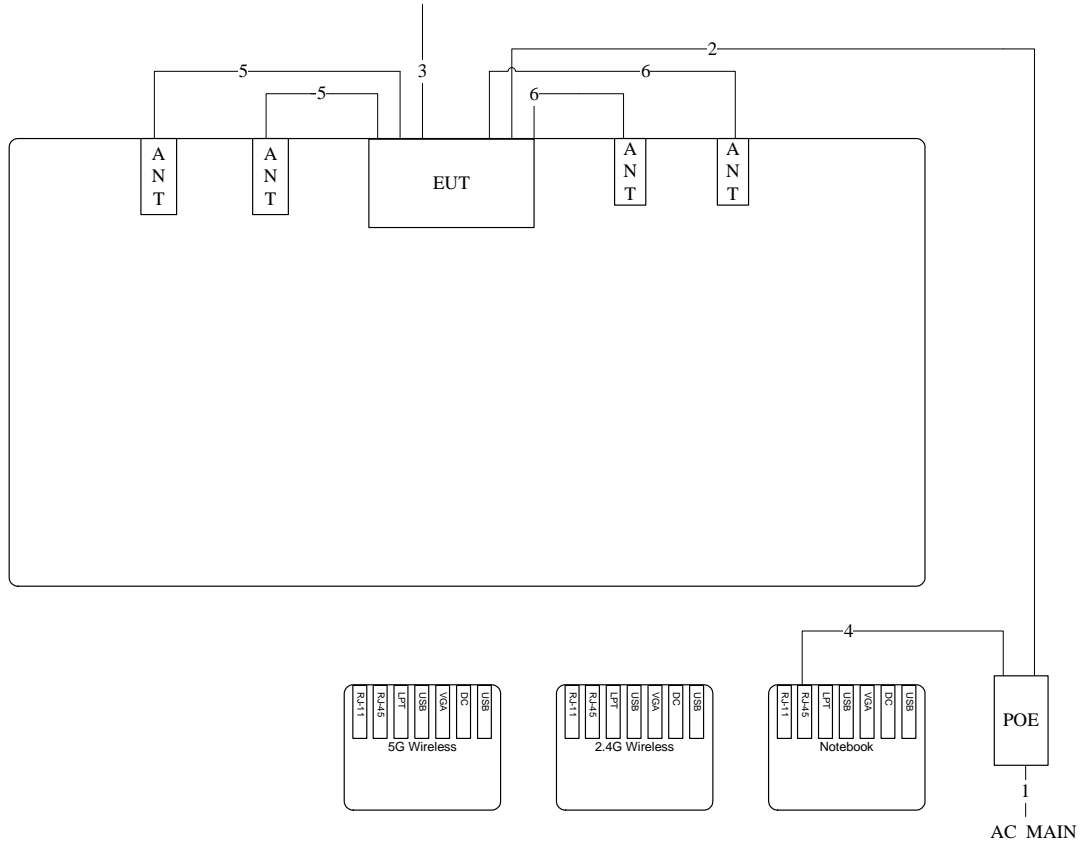

Item	Connection	Shield	Length	Remark
1	Power Cable	No	1.8m	-
2	RJ45 Cable	No	10m	-
3	RS232 Cable	Yes	1.8m	-
4	RJ45 Cable	No	1m	-
5	RF Cable	Yes	1.2m	-
6	RF Cable	Yes	0.9m	-

Test Mode: Mode 5

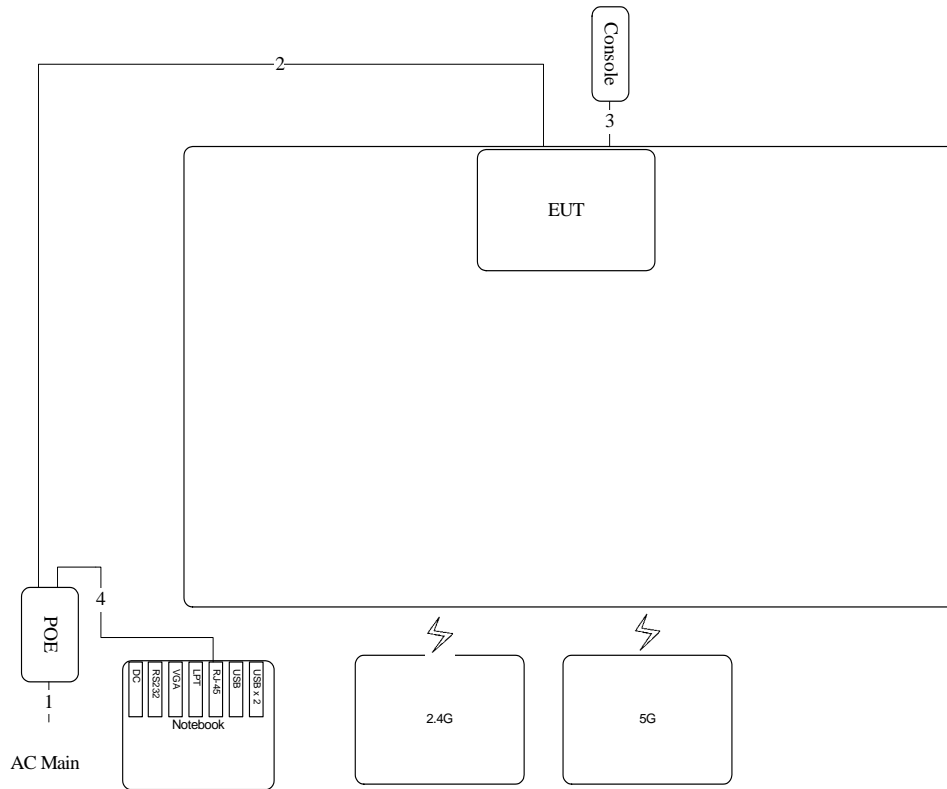

Item	Connection	Shield	Length	Remark
1	Power cable	No	1.8m	-
2	RJ-45 cable	No	10m	-
3	Console cable	No	1.5m	-
4	RJ-45 cable	No	1.5m	-

Test Configuration: above 1GHz

Test Mode: Mode 1 / Mode 2

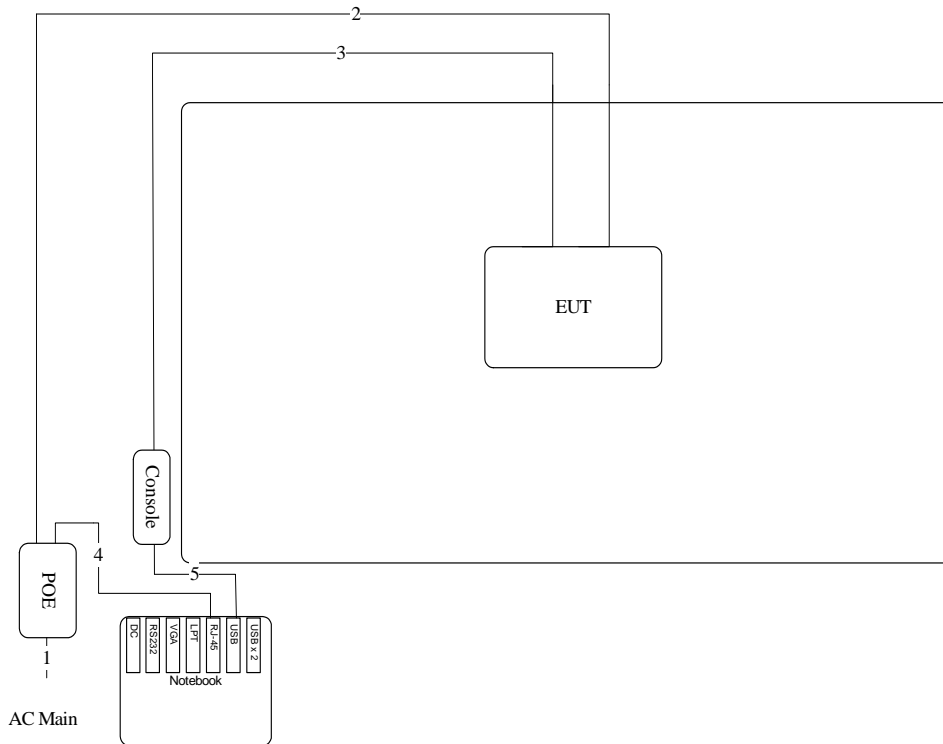

Item	Connection	Shield	Length	Remark
1	Power cable	No	1.8m	-
2	RJ-45 cable	No	10m	-
3	RJ-45 cable	No	10m	-
4	RJ-45 cable	No	1.5m	-
5	Console cable	No	1.5m	-

3.9.2. AC Power Line Conduction Emissions Test Configuration

Test Mode: Mode 1 / Mode 2

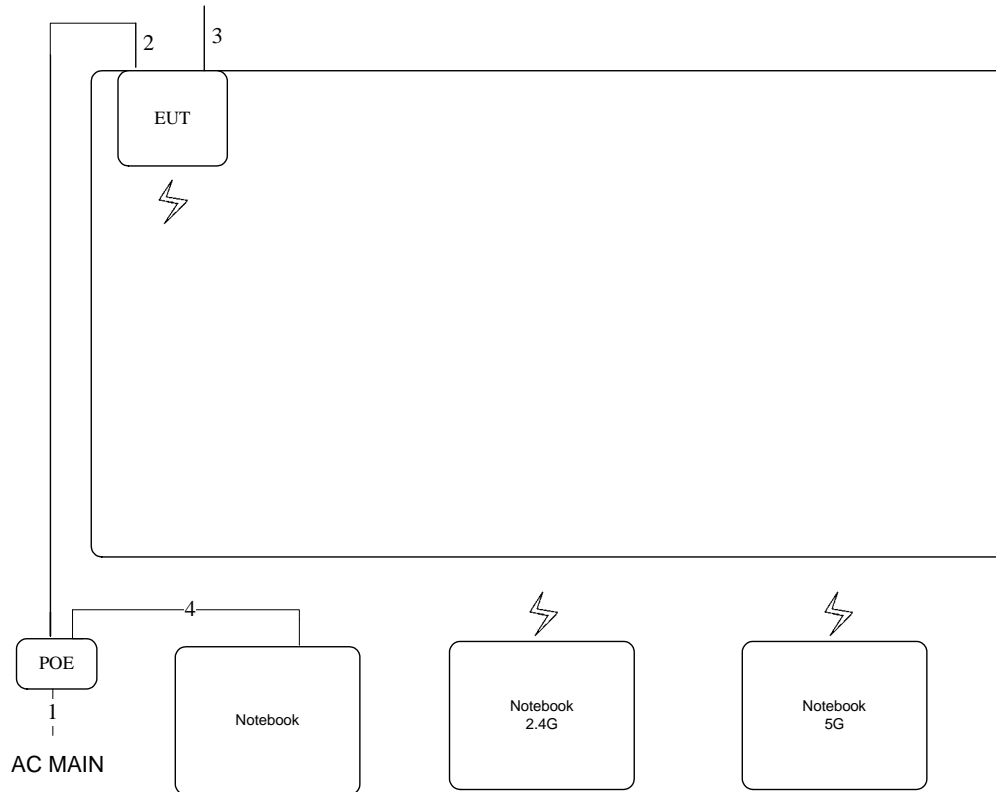

Item	Connection	Shield	Length	Remark
1	Power Cable	No	1.8m	-
2	RJ45 Cable	No	10m	-
3	Console Cable	No	1.5m	-
4	RJ45 Cable	No	1.5m	-

4. TEST RESULT

4.1. AC Power Line Conducted Emissions Measurement

4.1.1. Limit

For this product which is designed to be connected to the AC power line, the radio frequency voltage that is conducted back onto the AC power line on any frequency or frequencies within the band 150 kHz to 30 MHz shall not exceed below limits table.

Frequency (MHz)	QP Limit (dBuV)	AV Limit (dBuV)
0.15~0.5	66~56	56~46
0.5~5	56	46
5~30	60	50

4.1.2. Measuring Instruments and Setting

Please refer to section 5 of equipments list in this report. The following table is the setting of the receiver.

Receiver Parameters	Setting
Attenuation	10 dB
Start Frequency	0.15 MHz
Stop Frequency	30 MHz
IF Bandwidth	9 KHz

4.1.3. Test Procedures

1. Configure the EUT according to ANSI C63.10. The EUT or host of EUT has to be placed 0.4 meter far from the conducting wall of the shielding room and at least 80 centimeters from any other grounded conducting surface.
2. Connect EUT or host of EUT to the power mains through a line impedance stabilization network (LISN).
3. All the support units are connected to the other LISNs. The LISN should provide 50uH/50ohms coupling impedance.
4. The frequency range from 150 KHz to 30 MHz was searched.
5. Set the test-receiver system to Peak Detect Function and Specified Bandwidth with Maximum Hold Mode.
6. The measurement has to be done between each power line and ground at the power terminal.

4.1.4. Test Setup Layout

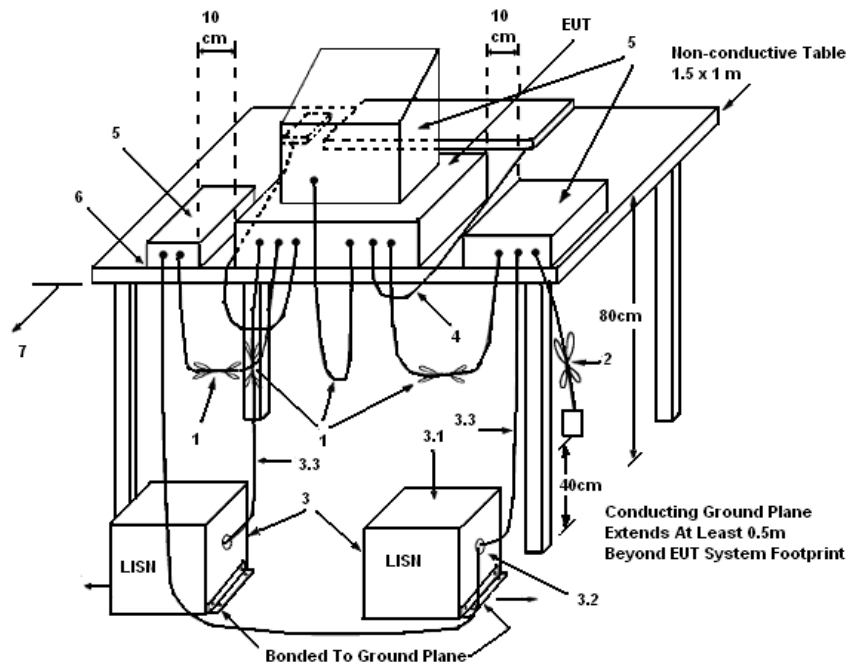

LEGEND:

- (1) Interconnecting cables that hang closer than 40 cm to the ground plane shall be folded back and forth in the center forming a bundle 30 to 40 cm long.
- (2) I/O cables that are not connected to a peripheral shall be bundled in the center. The end of the cable may be terminated, if required, using the correct terminating impedance. The overall length shall not exceed 1 m.
- (3) EUT connected to one LISN. Unused LISN measuring port connectors shall be terminated in 50 Ω . LISN can be placed on top of, or immediately beneath, reference ground plane.
 - (3.1) All other equipment powered from additional LISN(s).
 - (3.2) Multiple outlet strip can be used for multiple power cords of non-EUT equipment.
 - (3.3) LISN at least 80 cm from nearest part of EUT chassis.
- (4) Cables of hand-operated devices, such as keyboards, mice, etc., shall be placed as for normal use.
- (5) Non-EUT components of EUT system being tested.
- (6) Rear of EUT, including peripherals, shall all be aligned and flush with rear of tabletop.
- (7) Rear of tabletop shall be 40 cm removed from a vertical conducting plane that is bonded to the ground plane.

4.1.5. Test Deviation

There is no deviation with the original standard.

4.1.6. EUT Operation during Test

The EUT was placed on the test table and programmed in normal function.

4.1.7. Results of AC Power Line Conducted Emissions Measurement

Temperature	24°C	Humidity	64%
Test Engineer	Sollo Luo	Phase	Line
Test Mode	Mode 1. EUT 1 (with external antenna) / Ant. 1 + Ant. 5 (Dipole antenna) + POE / Normal Link		

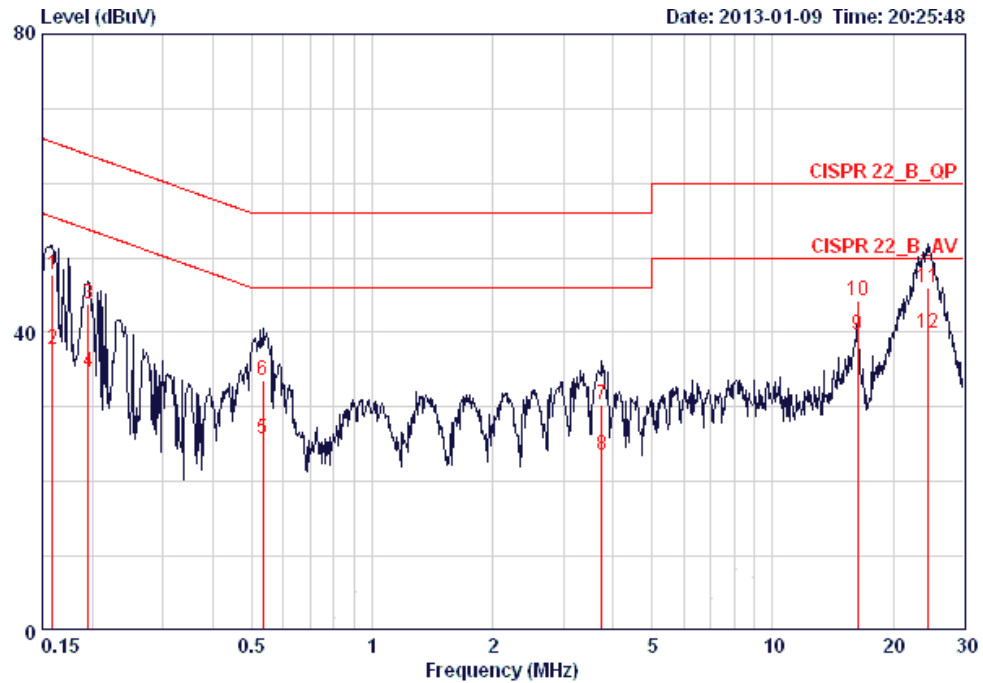

	Freq	Level	Over	Limit	Read	LISN	Cable	
	MHz	dBuV	Limit	Line	Level	Factor	Loss	Remark
			dB	dBuV	dBuV	dB	dB	
1	0.15900	47.74	-17.77	65.52	47.40	0.16	0.18	QP
2	0.15900	37.79	-17.72	55.52	37.45	0.16	0.18	AVERAGE
3	0.19550	43.84	-19.96	63.80	43.49	0.15	0.20	QP
4	0.19550	34.57	-19.23	53.80	34.22	0.15	0.20	AVERAGE
5	0.53215	25.79	-20.21	46.00	25.44	0.15	0.20	AVERAGE
6	0.53215	33.48	-22.52	56.00	33.13	0.15	0.20	QP
7	3.740	30.36	-25.64	56.00	29.86	0.22	0.29	QP
8	3.740	23.47	-22.53	46.00	22.97	0.22	0.29	AVERAGE
9	16.312	39.65	-10.35	50.00	38.81	0.43	0.41	AVERAGE
10	16.312	44.15	-15.85	60.00	43.31	0.43	0.41	QP
11	24.529	46.07	-13.93	60.00	44.94	0.58	0.56	QP
12	24.529	39.79	-10.21	50.00	38.66	0.58	0.56	AVERAGE

Temperature	24°C	Humidity	64%
Test Engineer	Sollo Luo	Phase	Neutral
Test Mode	Mode 1. EUT 1 (with external antenna) / Ant. 1 + Ant. 5 (Dipole antenna) + POE / Normal Link		

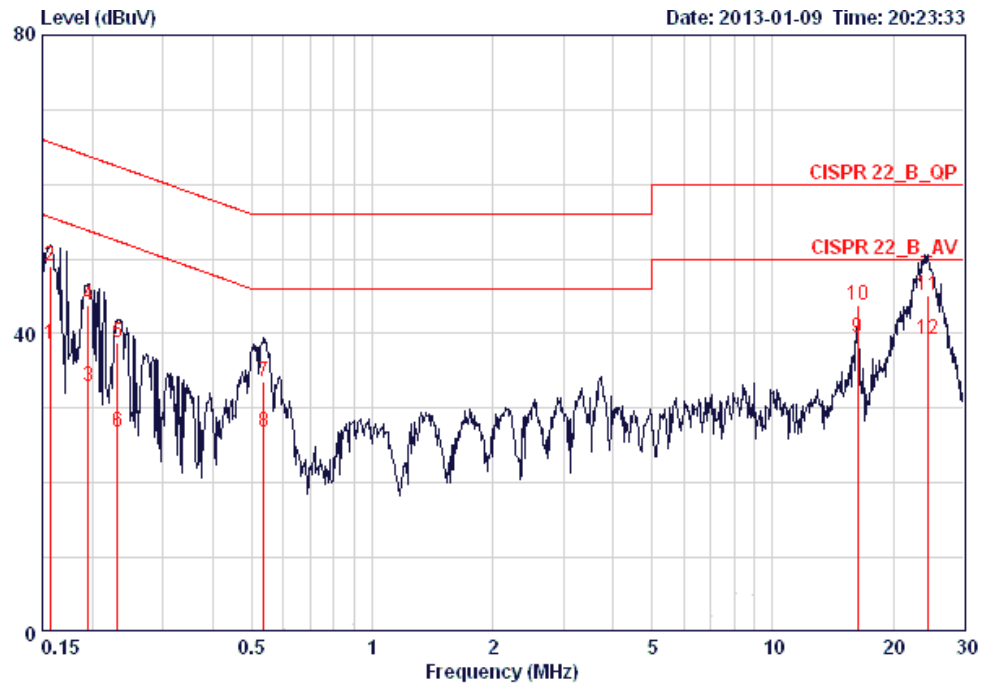

	Freq	Level	Over Limit	Limit Line	Read Level	LISN Factor	Cable Loss	Remark
	MHz	dBuV	dB	dBuV	dBuV	dB	dB	
1	0.15650	38.51	-17.14	55.65	38.25	0.08	0.18	AVERAGE
2	0.15650	49.08	-16.57	65.65	48.82	0.08	0.18	QP
3	0.19550	32.96	-20.84	53.80	32.68	0.08	0.20	AVERAGE
4	0.19550	43.77	-20.03	63.80	43.49	0.08	0.20	QP
5	0.23162	38.73	-23.66	62.39	38.45	0.08	0.20	QP
6	0.23162	26.85	-25.54	52.39	26.57	0.08	0.20	AVERAGE
7	0.53498	33.49	-22.51	56.00	33.21	0.08	0.20	QP
8	0.53498	26.88	-19.12	46.00	26.60	0.08	0.20	AVERAGE
9	16.312	39.39	-10.61	50.00	38.65	0.33	0.41	AVERAGE
10	16.312	43.86	-16.14	60.00	43.12	0.33	0.41	QP
11	24.529	45.05	-14.95	60.00	44.01	0.48	0.56	QP
12	24.529	39.34	-10.66	50.00	38.30	0.48	0.56	AVERAGE

Note:

Level = Read Level + LISN Factor + Cable Loss

Temperature	24°C	Humidity	64%
Test Engineer	Sollo Luo	Phase	Line
Test Mode	Mode 2. EUT 2 (with internal antenna) / Ant. 18 + Ant. 19 (Embedded antenna) + POE / Normal Link		

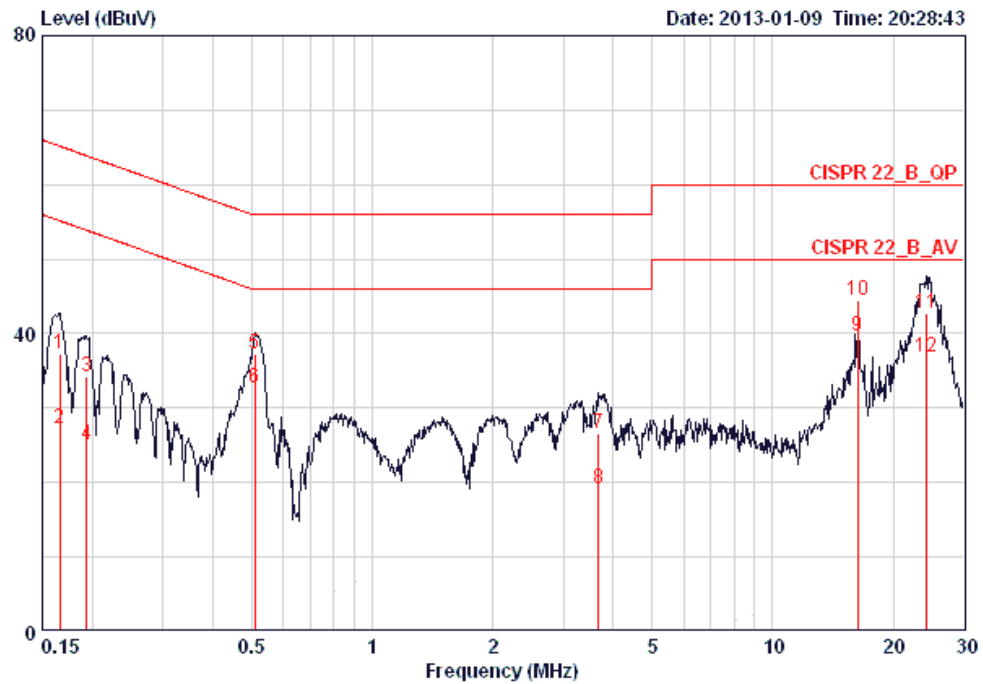

	Freq	Level	Over Limit	Limit Line	Read Level	LISN Factor	Cable Loss	Remark
	MHz	dBuV	dB	dBuV	dBuV	dB	dB	
1	0.16589	37.37	-27.80	65.16	37.02	0.16	0.19	QP
2	0.16589	27.32	-27.85	55.16	26.97	0.16	0.19	AVERAGE
3	0.19344	34.29	-29.60	63.89	33.94	0.15	0.20	QP
4	0.19344	25.06	-28.83	53.89	24.71	0.15	0.20	AVERAGE
5	0.51007	37.19	-18.81	56.00	36.84	0.15	0.20	QP
6	0.51007	32.79	-13.21	46.00	32.44	0.15	0.20	AVERAGE
7	3.681	26.55	-29.45	56.00	26.05	0.22	0.29	QP
8	3.681	19.08	-26.92	46.00	18.58	0.22	0.29	AVERAGE
9	16.312	39.70	-10.30	50.00	38.86	0.43	0.41	AVERAGE
10	16.312	44.43	-15.57	60.00	43.59	0.43	0.41	QP
11	24.142	42.68	-17.32	60.00	41.56	0.57	0.55	QP
12	24.142	36.91	-13.09	50.00	35.79	0.57	0.55	AVERAGE

Temperature	24°C	Humidity	64%
Test Engineer	Sollo Luo	Phase	Neutral
Test Mode	Mode 2. EUT 2 (with internal antenna) / Ant. 18 + Ant. 19 (Embedded antenna) + POE / Normal Link		

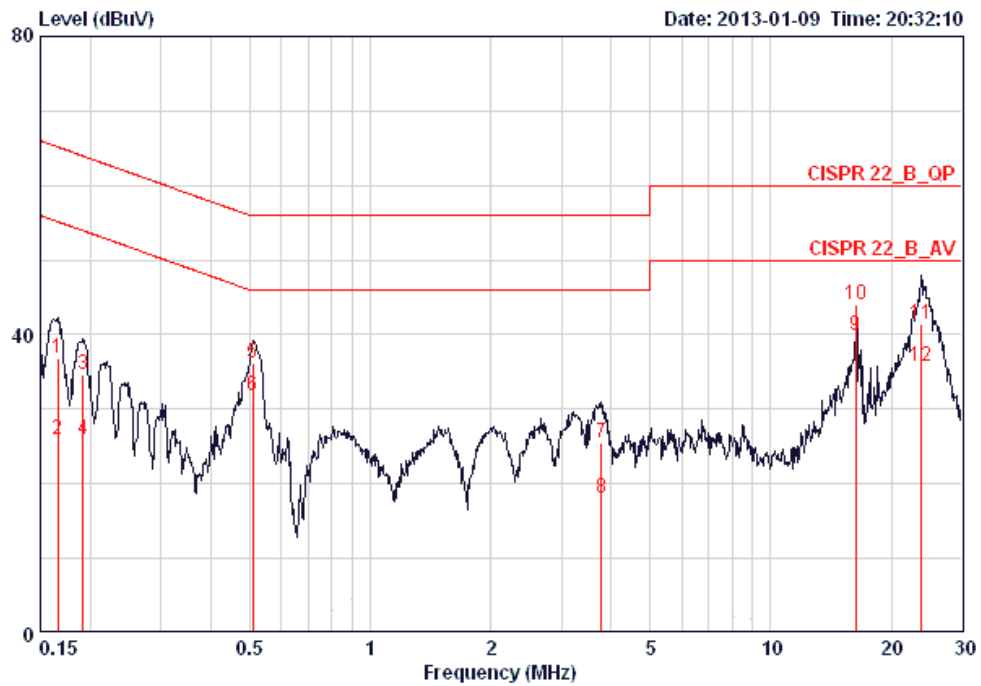

	Freq	Level	Over Limit	Limit Line	Read Level	LISN Factor	Cable Loss	Remark
	MHz	dBuV	dB	dBuV	dBuV	dB	dB	
1	0.16589	36.86	-28.31	65.16	36.59	0.08	0.19	QP
2	0.16589	25.95	-29.22	55.16	25.68	0.08	0.19	AVERAGE
3	0.19140	34.77	-29.21	63.98	34.49	0.08	0.20	QP
4	0.19140	25.89	-28.09	53.98	25.61	0.08	0.20	AVERAGE
5	0.51007	36.21	-19.79	56.00	35.93	0.08	0.20	QP
6	0.51007	31.74	-14.26	46.00	31.46	0.08	0.20	AVERAGE
7	3.779	25.57	-30.43	56.00	25.15	0.13	0.29	QP
8	3.779	18.08	-27.92	46.00	17.66	0.13	0.29	AVERAGE
9	16.312	39.80	-10.20	50.00	39.06	0.33	0.41	AVERAGE
10	16.312	44.09	-15.91	60.00	43.35	0.33	0.41	QP
11	23.762	41.45	-18.55	60.00	40.44	0.47	0.55	QP
12	23.762	35.65	-14.35	50.00	34.64	0.47	0.55	AVERAGE

Note:

$$\text{Level} = \text{Read Level} + \text{LISN Factor} + \text{Cable Loss}$$

4.2. Maximum Conducted Output Power Measurement

4.2.1. Limit

For systems using digital modulation in the 2400-2483.5MHz, the limit for output power is 30dBm. The limited has to be reduced by the amount in dB that the gain of the antenna exceed 6dBi. In case of point-to-point operation, the limit has to be reduced by 1dB for every 3dB that the directional gain of the antenna exceeds 6dBi. Systems operating in the 5725-5850 MHz band that are used exclusively for fixed, point-to-point operations may employ transmitting antennas with directional gain greater than 6 dBi without any corresponding reduction in transmitter output power.

4.2.2. Measuring Instruments and Setting

Please refer to section 5 of equipments list in this report. The following table is the setting of the power meter.

Power Meter Parameter	Setting
Bandwidth	50MHz bandwidth is greater than the EUT emission bandwidth
Detector	Average

4.2.3. Test Procedures

1. Test procedures refer KDB558074 v01 r02 section 8.2.3 option 3.
2. This procedure provides an alternative for determining the RMS output power using a broadband RF average power meter with a thermocouple detector.

4.2.4. Test Setup Layout

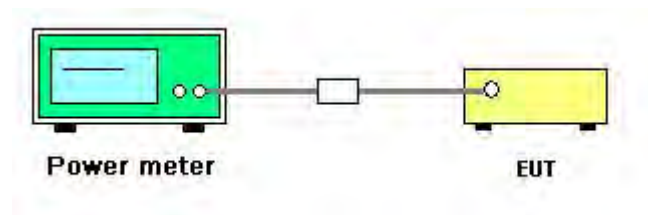

4.2.5. Test Deviation

There is no deviation with the original standard.

4.2.6. EUT Operation during Test

The EUT was programmed to be in continuously transmitting mode.

4.2.7. Test Result of Maximum Conducted Output Power

Temperature	24°C	Humidity	61%
Test Engineer	Robert Chang	Configurations	IEEE 802.11n
Test Mode	Mode 1. EUT 2 (with internal antenna) + Ant. 18 (Embedded antenna) / Radio 1 (2.4GHz band)		
Test Date	Jan. 02, 2013		

Configuration IEEE 802.11n MCS0 20MHz

Channel	Frequency	Conducted Power (dBm)		Total Conducted Power (dBm)	Max. Limit (dBm)	Result
		Chain 1	Chain 2			
1	2412 MHz	18.02	16.03	20.15	28.93	Complies
6	2437 MHz	24.55	23.53	27.08	28.93	Complies
11	2462 MHz	16.06	14.63	18.41	28.93	Complies

Note: 7.07dBi > 6dBi, so Limit = 30-(7.07-6)=28.93 dBm

Configuration IEEE 802.11n MCS0 40MHz

Channel	Frequency	Conducted Power (dBm)		Total Conducted Power (dBm)	Max. Limit (dBm)	Result
		Chain 1	Chain 2			
3	2422 MHz	15.02	13.11	17.18	28.93	Complies
6	2437 MHz	18.19	17.11	20.69	28.93	Complies
9	2452 MHz	12.98	11.79	15.44	28.93	Complies

Note: 7.07dBi > 6dBi, so Limit = 30-(7.07-6)=28.93 dBm

Temperature	24°C	Humidity	61%
Test Engineer	Robert Chang	Configurations	IEEE 802.11b/g
Test Mode	Mode 1. EUT 2 (with internal antenna) + Ant. 18 (Embedded antenna) / Radio 1 (2.4GHz band)		
Test Date	Jan. 02, 2013		

Configuration IEEE 802.11b / Chain 2

Channel	Frequency	Conducted Power (dBm)	Max. Limit (dBm)	Result
1	2412 MHz	21.10	29.73	Complies
6	2437 MHz	24.84	29.73	Complies
11	2462 MHz	22.24	29.73	Complies

Note: 6.27dBi > 6dBi, so Limit = 30-(6.27-6)=29.73 dBm

Configuration IEEE 802.11g

Channel	Frequency	Conducted Power (dBm)		Total Conducted Power (dBm)	Max. Limit (dBm)	Result
		Chain 1	Chain 2			
1	2412 MHz	17.09	15.11	19.22	28.93	Complies
6	2437 MHz	24.60	23.82	27.24	28.93	Complies
11	2462 MHz	18.74	17.73	21.27	28.93	Complies

Note: 7.07dBi > 6dBi, so Limit = 30-(7.07-6)=28.93 dBm

Temperature	24°C	Humidity	61%
Test Engineer	Robert Chang	Configurations	IEEE 802.11n
Test Mode	Mode 2. EUT 2 (with internal antenna) + Ant. 19 (Embedded antenna) / Radio 2 (2.4GHz + 5GHz band)		
Test Date	Jan. 02, 2013		

For 2.4GHz Band

Configuration IEEE 802.11n MCS0 20MHz

Channel	Frequency	Conducted Power (dBm)		Total Conducted Power (dBm)	Max. Limit (dBm)	Result
		Chain 1	Chain 2			
1	2412 MHz	20.32	19.61	22.99	29.16	Complies
6	2437 MHz	24.22	23.75	27.00	29.16	Complies
11	2462 MHz	18.81	18.67	21.75	29.16	Complies

Note: 6.84dBi > 6dBi, so Limit = 30-(6.84-6)=29.16dBm

Configuration IEEE 802.11n MCS0 40MHz

Channel	Frequency	Conducted Power (dBm)		Total Conducted Power (dBm)	Max. Limit (dBm)	Result
		Chain 1	Chain 2			
3	2422 MHz	16.82	16.16	19.51	29.16	Complies
6	2437 MHz	20.31	20.11	23.22	29.16	Complies
9	2452 MHz	15.74	16.02	18.89	29.16	Complies

Note: 6.84dBi > 6dBi, so Limit = 30-(6.84-6)=29.16dBm

For 5GHz Band

Configuration IEEE 802.11n MCS0 20MHz

Channel	Frequency	Conducted Power (dBm)		Total Conducted Power (dBm)	Max. Limit (dBm)	Result
		Chain 1	Chain 2			
149	5745 MHz	18.45	21.39	23.17	28.85	Complies
157	5785 MHz	18.00	21.80	23.31	28.85	Complies
165	5825 MHz	17.41	20.35	22.13	28.85	Complies

Note: 7.15dBi > 6dBi, so Limit = 30-(7.15-6)=28.85 dBm

Configuration IEEE 802.11n MCS0 40MHz

Channel	Frequency	Conducted Power (dBm)		Total Conducted Power (dBm)	Max. Limit (dBm)	Result
		Chain 1	Chain 2			
151	5755 MHz	17.80	21.01	22.71	28.85	Complies
159	5795 MHz	17.54	20.50	22.28	28.85	Complies

Note: 7.15dBi > 6dBi, so Limit = 30-(7.15-6)=28.85 dBm

Temperature	24°C	Humidity	61%
Test Engineer	Robert Chang	Configurations	IEEE 802.11a/b/g
Test Mode	Mode 2. EUT 2 (with internal antenna) + Ant. 19 (Embedded antenna) / Radio 2 (2.4GHz + 5GHz band)		
Test Date	Jan. 02, 2013		

Configuration IEEE 802.11b / Chain 1

Channel	Frequency	Conducted Power (dBm)	Max. Limit (dBm)	Result
1	2412 MHz	22.02	30.00	Complies
6	2437 MHz	24.20	30.00	Complies
11	2462 MHz	21.68	30.00	Complies

Configuration IEEE 802.11g

Channel	Frequency	Conducted Power (dBm)		Total Conducted Power (dBm)	Max. Limit (dBm)	Result
		Chain 1	Chain 2			
1	2412 MHz	20.54	19.88	23.23	29.16	Complies
6	2437 MHz	24.41	24.02	27.23	29.16	Complies
11	2462 MHz	20.11	19.89	23.01	29.16	Complies

Note: 6.84dBi > 6dBi, so Limit = 30-(6.84-6)=29.16 dBm

Configuration IEEE 802.11a

Channel	Frequency	Conducted Power (dBm)		Total Conducted Power (dBm)	Max. Limit (dBm)	Result
		Chain 1	Chain 2			
149	5745 MHz	18.37	21.11	22.96	28.85	Complies
157	5785 MHz	17.33	20.06	21.92	28.85	Complies
165	5825 MHz	17.07	20.12	21.87	28.85	Complies

Note: 7.15dBi > 6dBi, so Limit = 30-(7.15-6)=28.85 dBm

4.3. Power Spectral Density Measurement

4.3.1. Limit

For digitally modulated systems, the power spectral density conducted from the intentional radiator to the antenna shall not be greater than 8dBm in any 3 kHz band during any time interval of continuous transmission.

4.3.2. Measuring Instruments and Setting

Please refer to section 5 of equipments list in this report. The following table is the setting of the spectrum analyzer.

Spectrum Parameter	Setting
Attenuation	Auto
Span Frequency	Set the span to 1.5 times the DTS channel bandwidth.
RB	100 kHz
VB	300 kHz
Detector	Peak
Trace	Max Hold
Sweep Time	Auto couple

4.3.3. Test Procedures

1. Test procedures refer KDB558074 v01 r02 section 9.1 option 1
2. Spectrum analyzer must be capable of utilizing a number of measurement points in each sweep that is greater than or equal to twice the span/RBW in order to ensure bin-to-bin spacing of $\leq RBW/2$ so that narrowband signals are not lost between frequency bins.
3. Use this procedure when the maximum conducted output power in the fundamental emission is used to demonstrate compliance. The EUT must be configured to transmit continuously at full power over the measurement duration.
4. Ensure that the number of measurement points in the sweep $\geq 2 \times \text{span}/\text{RBW}$ (use of a greater number of measurement points than this minimum requirement is recommended).
5. Use the peak marker function to determine the maximum level in any 100 kHz band segment within the fundamental EBW.
6. Scale the observed power level to an equivalent level in 3 kHz by adjusting (reducing) the measured power by a bandwidth correction factor (BWCF) where: $BWCF = 10\log(3 \text{ kHz}/100 \text{ kHz} = -15.2 \text{ dB})$.
7. The resulting PSD level must be $\leq 8 \text{ dBm}$.
8. When measuring power spectral density with multiple antenna systems, add every result of the values by mathematic formula.

4.3.4. Test Setup Layout

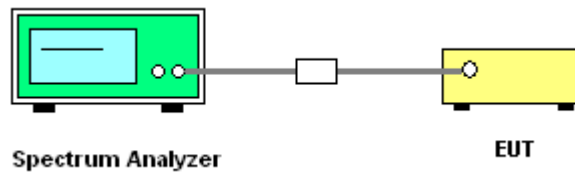

4.3.5. Test Deviation

There is no deviation with the original standard.

4.3.6. EUT Operation during Test

The EUT was programmed to be in continuously transmitting mode.

4.3.7. Test Result of Power Spectral Density

Temperature	24°C	Humidity	61%
Test Engineer	Robert Chang	Configurations	IEEE 802.11n
Test Mode	Mode 1. EUT 2 (with internal antenna) + Ant. 18 (Embedded antenna) / Radio 1 (2.4GHz band)		

For 2.4GHz Band

Configuration IEEE 802.11n MCS0 20MHz

Channel	Frequency	Power Density (dBm/100kHz)		BWCF factor (100KHz to 3KHz)	Power Density (dBm/3kHz)		Single Port Limit (dBm/3kHz)	Result
		Chain 1	Chain 2		Chain 1	Chain 2		
1	2412 MHz	4.23	1.81	-15.23	-11.00	-13.42	3.92	Complies
6	2437 MHz	10.64	9.99	-15.23	-4.59	-5.24	3.92	Complies
11	2462 MHz	2.28	0.57	-15.23	-12.95	-14.66	3.92	Complies

Note: 7.07dBi > 6dBi, so Limit = 8-(7.07-6)-10log(2)=3.92dBm/3kHz

Configuration IEEE 802.11n MCS0 40MHz

Channel	Frequency	Power Density (dBm/100kHz)		BWCF factor (100KHz to 3KHz)	Power Density (dBm/3kHz)		Single Port Limit (dBm/3kHz)	Result
		Chain 1	Chain 2		Chain 1	Chain 2		
3	2422 MHz	-2.00	-3.51	-15.23	-17.23	-18.74	3.92	Complies
6	2437 MHz	1.86	0.29	-15.23	-13.37	-14.94	3.92	Complies
9	2452 MHz	-4.06	-5.06	-15.23	-19.29	-20.29	3.92	Complies

Note: 7.07dBi > 6dBi, so Limit = 8-(7.07-6)-10log(2)=3.92dBm/3kHz

Temperature	24°C	Humidity	61%
Test Engineer	Robert Chang	Configurations	IEEE 802.11b/g
Test Mode	Mode 1. EUT 2 (with internal antenna) + Ant. 18 (Embedded antenna) / Radio 1 (2.4GHz band)		

Configuration IEEE 802.11b / Chain 2

Channel	Frequency	Power Density (dBm/100kHz)	BWCF factor (100KHz to 3KHz)	Power Density (dBm/3kHz)	Max. Limit (dBm/3kHz)	Result
1	2412 MHz	12.28	-15.23	-2.95	7.73	Complies
6	2437 MHz	16.19	-15.23	0.96	7.73	Complies
11	2462 MHz	13.57	-15.23	-1.66	7.73	Complies

Note: 6.27dBi > 6dBi, so Limit = 8-(6.27-6)=7.73dBm/3kHz

Configuration IEEE 802.11g

Channel	Frequency	Power Density (dBm/100kHz)		BWCF factor (100KHz to 3KHz)	Power Density (dBm/3kHz)		Single Port Limit (dBm/3kHz)	Result
		Chain 1	Chain 2		Chain 1	Chain 2		
1	2412 MHz	3.36	2.71	-15.23	-11.87	-12.52	3.92	Complies
6	2437 MHz	11.33	11.40	-15.23	-3.90	-3.83	3.92	Complies
11	2462 MHz	5.23	4.37	-15.23	-10.00	-10.86	3.92	Complies

Note: 7.07dBi > 6dBi, so Limit = 8-(7.07-6)-10log(2)=3.92dBm/3kHz

Temperature	24°C	Humidity	61%
Test Engineer	Robert Chang	Configurations	IEEE 802.11n
Test Mode	Mode 2. EUT 2 (with internal antenna) + Ant. 19 (Embedded antenna) / Radio 2 (2.4GHz + 5GHz band)		

For 2.4GHz Band
Configuration IEEE 802.11n MCS0 20MHz

Channel	Frequency	Power Density (dBm/100kHz)		BWCF factor (100KHz to 3KHz)	Power Density (dBm/3kHz)		Single Port Limit (dBm/3kHz)	Result
		Chain 1	Chain 2		Chain 1	Chain 2		
1	2412 MHz	7.04	6.80	-15.23	-8.19	-8.43	4.15	Complies
6	2437 MHz	11.73	10.55	-15.23	-3.50	-4.68	4.15	Complies
11	2462 MHz	5.39	5.93	-15.23	-9.84	-9.30	4.15	Complies

Note: 6.84dBi > 6dBi, so Limit = $8 - (6.84 - 6) - 10\log(2) = 4.15\text{dBm}/3\text{kHz}$

Configuration IEEE 802.11n MCS0 40MHz

Channel	Frequency	Power Density (dBm/100kHz)		BWCF factor (100KHz to 3KHz)	Power Density (dBm/3kHz)		Single Port Limit (dBm/3kHz)	Result
		Chain 1	Chain 2		Chain 1	Chain 2		
3	2422 MHz	1.29	0.26	-15.23	-13.94	-14.97	4.15	Complies
6	2437 MHz	3.76	4.01	-15.23	-11.47	-11.22	4.15	Complies
9	2452 MHz	-1.34	-0.94	-15.23	-16.57	-16.17	4.15	Complies

Note: 6.84dBi > 6dBi, so Limit = $8 - (6.84 - 6) - 10\log(2) = 4.15\text{dBm}/3\text{kHz}$

For 5GHz Band
Configuration IEEE 802.11n MCS0 20MHz

Channel	Frequency	Power Density (dBm/100kHz)		BWCF factor (100KHz to 3KHz)	Power Density (dBm/3kHz)		Single Port Limit (dBm/3kHz)	Result
		Chain 1	Chain 2		Chain 1	Chain 2		
149	5745 MHz	3.52	6.27	-15.23	-11.71	-8.96	3.84	Complies
157	5785 MHz	2.82	5.83	-15.23	-12.41	-9.40	3.84	Complies
165	5825 MHz	2.60	5.36	-15.23	-12.63	-9.87	3.84	Complies

Note: $7.15\text{dBi} > 6\text{dBi}$, so Limit = $8 - (7.15 - 6) - 10\log(2) = 3.84\text{dBm}/3\text{kHz}$

Configuration IEEE 802.11n MCS0 40MHz

Channel	Frequency	Power Density (dBm/100kHz)		BWCF factor (100KHz to 3KHz)	Power Density (dBm/3kHz)		Single Port Limit (dBm/3kHz)	Result
		Chain 1	Chain 2		Chain 1	Chain 2		
151	5755 MHz	-1.52	2.46	-15.23	-16.75	-12.77	3.84	Complies
159	5795 MHz	-0.12	2.55	-15.23	-15.35	-12.68	3.84	Complies

Note: $7.15\text{dBi} > 6\text{dBi}$, so Limit = $8 - (7.15 - 6) - 10\log(2) = 3.84\text{dBm}/3\text{kHz}$

Temperature	24°C	Humidity	61%
Test Engineer	Robert Chang	Configurations	IEEE 802.11a/b/g
Test Mode	Mode 2. EUT 2 (with internal antenna) + Ant. 19 (Embedded antenna) / Radio 2 (2.4GHz + 5GHz band)		

Configuration IEEE 802.11b / Chain 1

Channel	Frequency	Power Density (dBm/100kHz)	BWCF factor (100KHz to 3KHz)	Power Density (dBm/3kHz)	Max. Limit (dBm/3kHz)	Result
1	2412 MHz	12.86	-15.23	-2.37	8.00	Complies
6	2437 MHz	14.16	-15.23	-1.07	8.00	Complies
11	2462 MHz	12.31	-15.23	-2.92	8.00	Complies

Configuration IEEE 802.11g

Channel	Frequency	Power Density (dBm/100kHz)		BWCF factor (100KHz to 3KHz)	Power Density (dBm/3kHz)		Single Port Limit (dBm/3kHz)	Result
		Chain 1	Chain 2		Chain 1	Chain 2		
1	2412 MHz	7.90	7.09	-15.23	-7.33	-8.14	4.15	Complies
6	2437 MHz	11.77	11.89	-15.23	-3.46	-3.34	4.15	Complies
11	2462 MHz	6.52	6.78	-15.23	-8.71	-8.45	4.15	Complies

Note: 6.84dBi > 6dBi, so Limit = 8-(6.84-6)-10log(2)=4.15dBm/3kHz

Configuration IEEE 802.11a

Channel	Frequency	Power Density (dBm/100kHz)		BWCF factor (100KHz to 3KHz)	Power Density (dBm/3kHz)		Single Port Limit (dBm/3kHz)	Result
		Chain 1	Chain 2		Chain 1	Chain 2		
149	5745 MHz	3.86	8.24	-15.23	-11.37	-6.99	3.84	Complies
157	5785 MHz	3.05	6.05	-15.23	-12.18	-9.18	3.84	Complies
165	5825 MHz	2.95	6.11	-15.23	-12.28	-9.12	3.84	Complies

Note: 7.15dBi > 6dBi, so Limit = 8-(7.15-6)-10log(2)=3.84dBm/3kHz

Note: All the test values were listed in the report.

For plots, only the channel with maximum results was shown.

**For Mode 1. EUT 2 (with internal antenna) + Ant. 18 (Embedded antenna) / Radio 1 (2.4GHz band):
Power Density Plot on Configuration IEEE 802.11n MCS0 20MHz / Chain 1 / 2437 MHz**

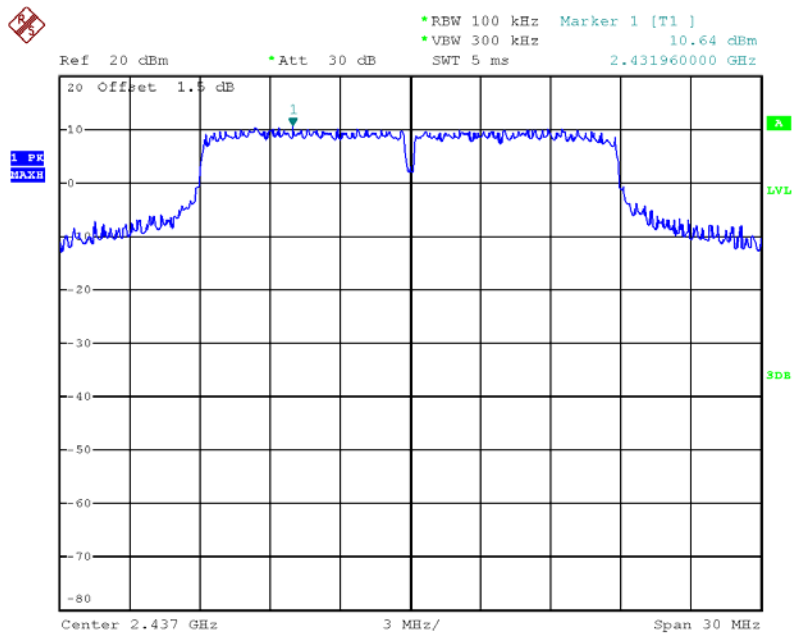

Date: 2.JAN.2013 22:06:19

Power Density Plot on Configuration IEEE 802.11n MCS0 40MHz / Chain 1 / 2422 MHz

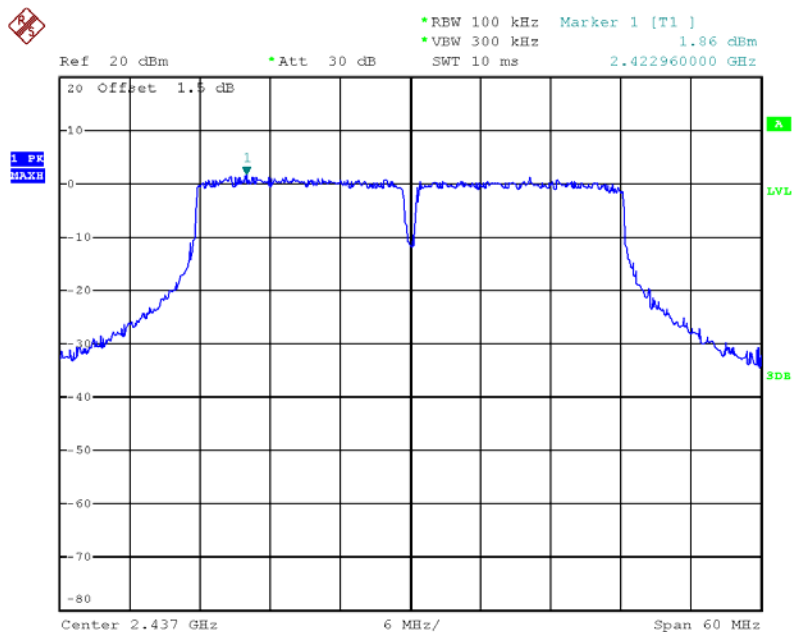

Date: 2.JAN.2013 22:12:44

Power Density Plot on Configuration IEEE 802.11b / Chain 2 / 2437 MHz

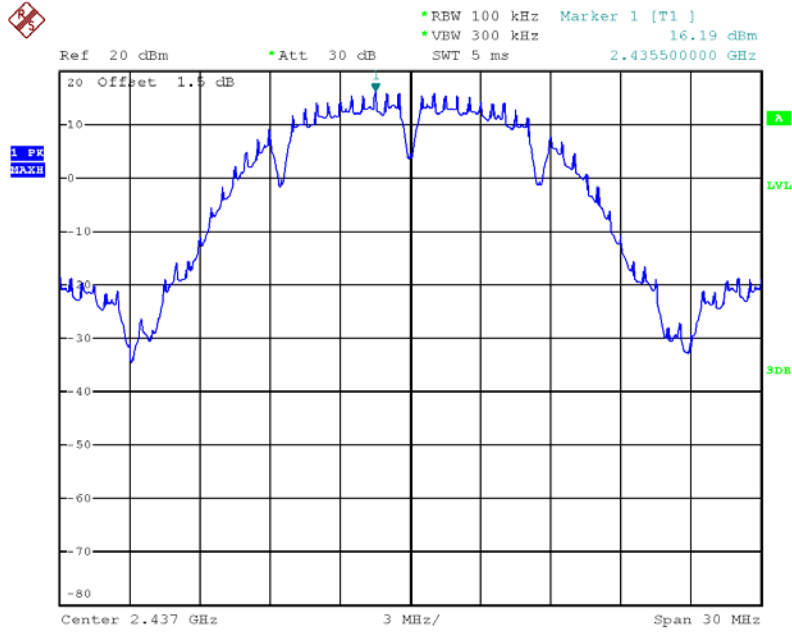

Date: 2.JAN.2013 21:37:05

Power Density Plot on Configuration IEEE 802.11g / Chain 2 / 2437 MHz

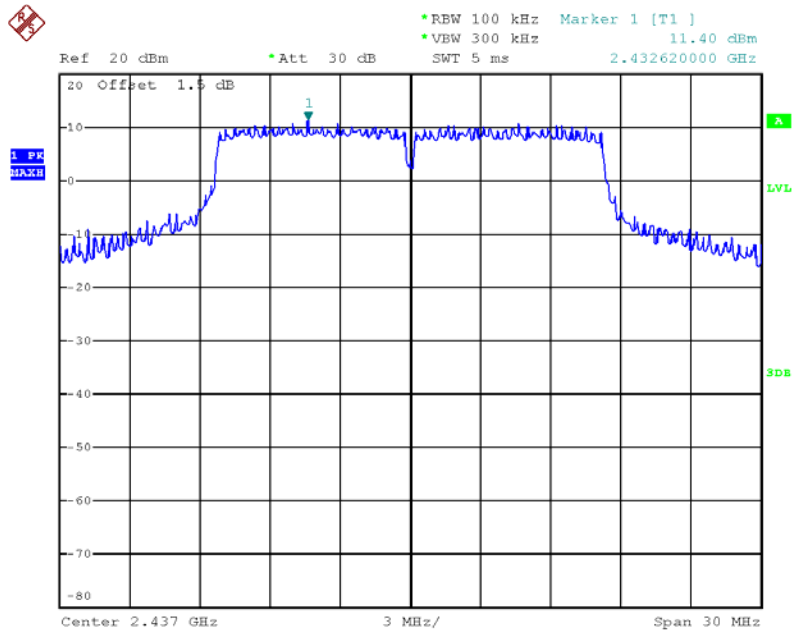

Date: 2.JAN.2013 21:59:48

For Mode 2. EUT 2 (with internal antenna) + Ant. 19 (Embedded antenna) / Radio 2 (2.4GHz + 5GHz band):

Power Density Plot on Configuration IEEE 802.11n MCS0 20MHz / Chain 1 / 2437 MHz

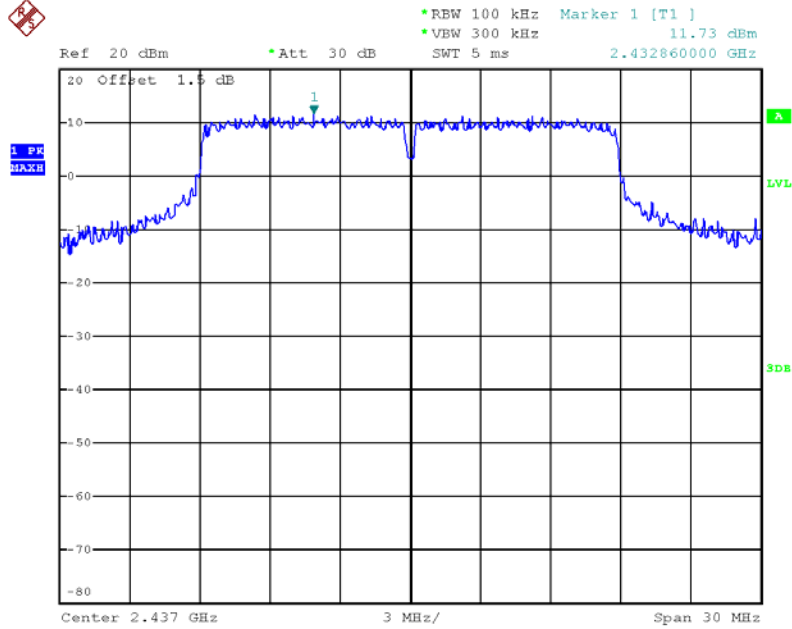

Date: 3.JAN.2013 00:21:14

Power Density Plot on Configuration IEEE 802.11n MCS0 40MHz / Chain 2 / 2437 MHz

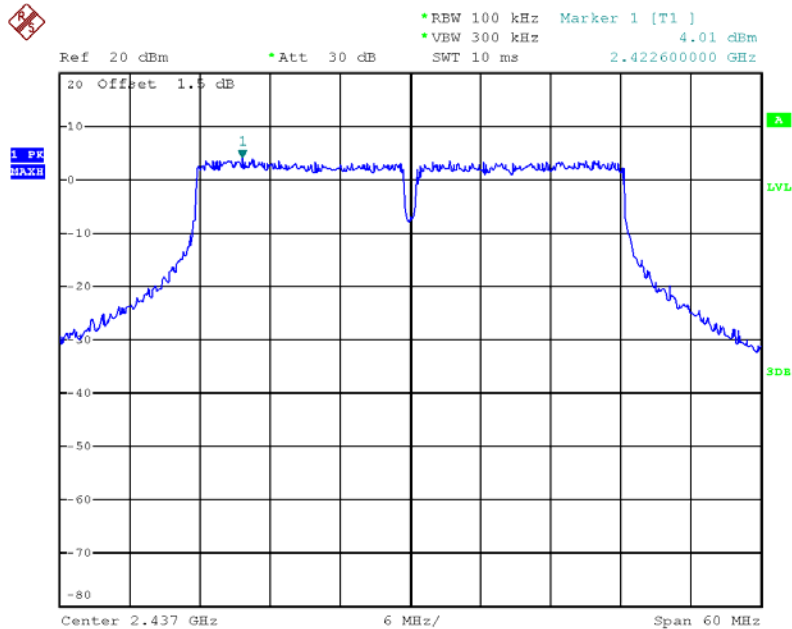

Date: 3.JAN.2013 00:27:11

Power Density Plot on Configuration IEEE 802.11n MCS0 20MHz / Chain 2 / 5745 MHz

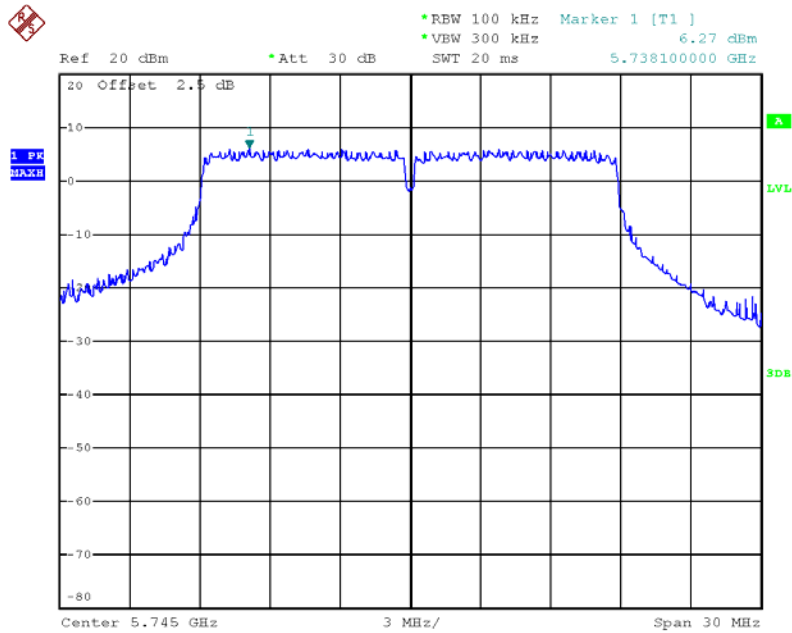

Date: 3.JAN.2013 00:36:34

Power Density Plot on Configuration IEEE 802.11n MCS0 40MHz / Chain 2 / 5795 MHz

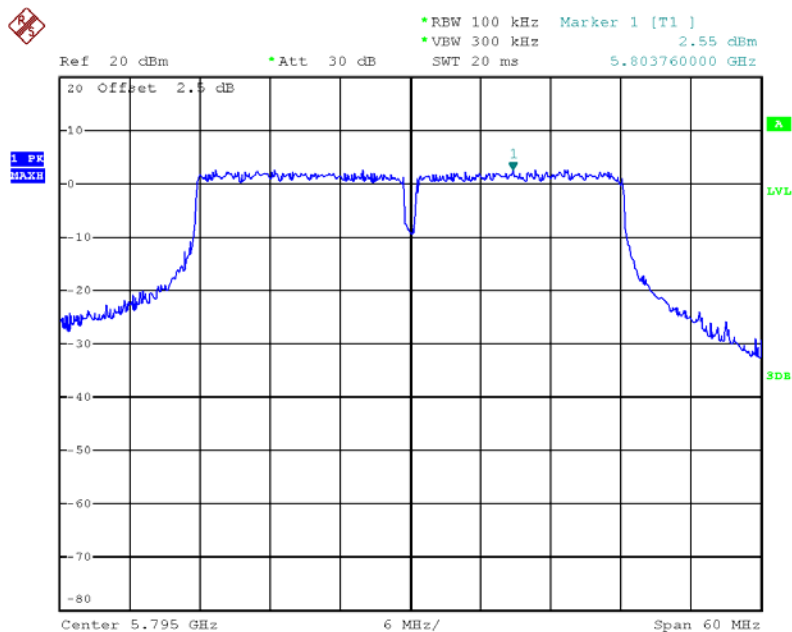

Date: 3.JAN.2013 00:41:52

Power Density Plot on Configuration IEEE 802.11b / Chain 1 / 2437 MHz

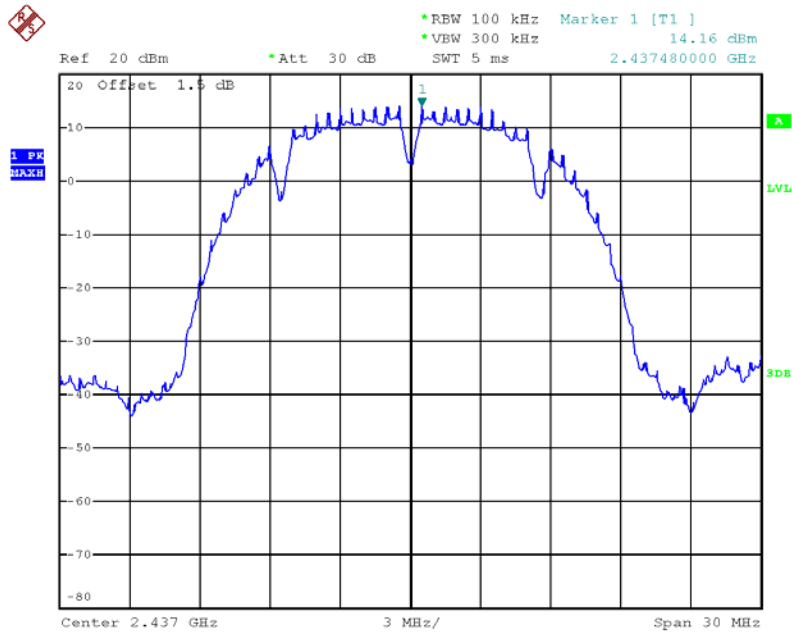

Date: 3.JAN.2013 00:11:03

Power Density Plot on Configuration IEEE 802.11g / Chain 2 / 2437 MHz

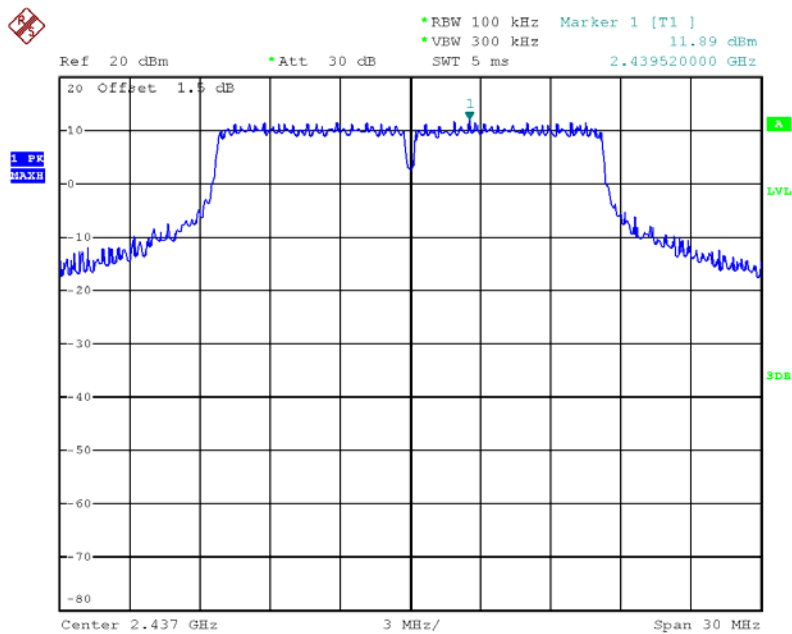

Date: 3.JAN.2013 00:14:25

Power Density Plot on Configuration IEEE 802.11a / Chain 2 / 5745 MHz

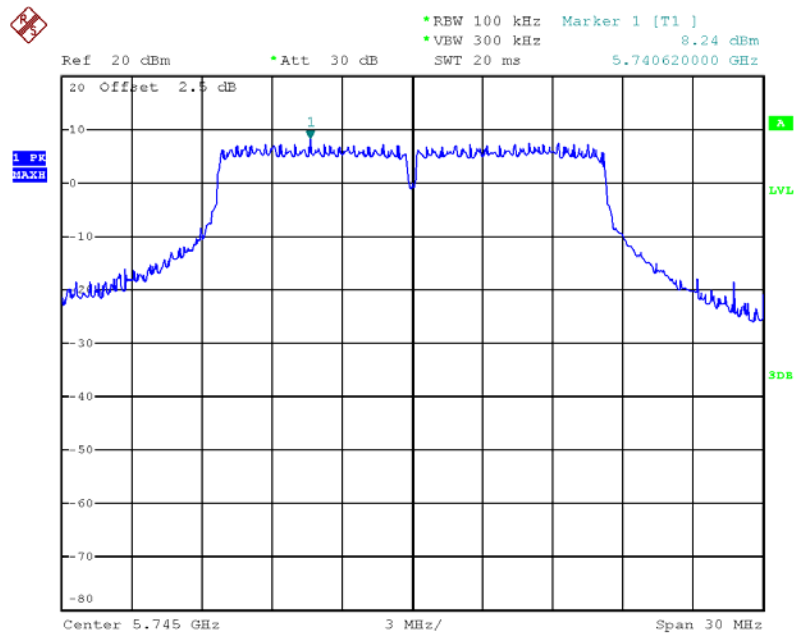

Date: 3.JAN.2013 00:31:31

4.4. 6dB Spectrum Bandwidth Measurement

4.4.1. Limit

For digital modulation systems, the minimum 6dB bandwidth shall be at least 500 kHz.

4.4.2. Measuring Instruments and Setting

Please refer to section 5 of equipments list in this report. The following table is the setting of the spectrum analyzer.

Spectrum Parameters	Setting
Attenuation	Auto
Span Frequency	> 6dB Bandwidth
RB	1-5 % or DTS BW, not exceed 100KHz
VB	$\geq 3 \times RBW$
Detector	Peak
Trace	Max Hold
Sweep Time	Auto

4.4.3. Test Procedures

1. The transmitter output (antenna port) was connected to the spectrum analyzer in peak hold mode.
2. Test was performed in accordance with KDB 558074 Guidance for Performing Compliance Measurements on Digital Transmission Systems (DTS) Operating Under §15.247 section 5.1.1 EBW Measurement Procedure
3. Multiple antenna system was performed in accordance with KDB 662911 Emissions Testing of Transmitters with Multiple Outputs in the Same Band.
4. Measured the spectrum width with power higher than 6dB below carrier.

4.4.4. Test Setup Layout

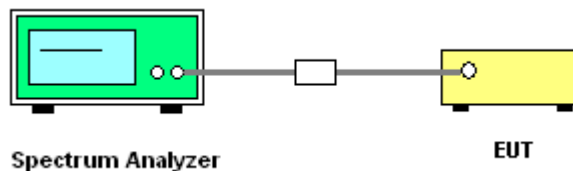

4.4.5. Test Deviation

There is no deviation with the original standard.

4.4.6. EUT Operation during Test

The EUT was programmed to be in continuously transmitting mode.

4.4.7. Test Result of 6dB Spectrum Bandwidth

Temperature	24°C	Humidity	61%
Test Engineer	Robert Chang	Configurations	IEEE 802.11n
Test Mode	Mode 1. EUT 2 (with internal antenna) + Ant. 18 (Embedded antenna) / Radio 1 (2.4GHz band)		

Configuration IEEE 802.11n MCS0 20MHz / Chain 1 + Chain 2

Channel	Frequency	6dB Bandwidth (MHz)	99% Occupied Bandwidth (MHz)	Min. Limit (kHz)	Test Result
1	2412 MHz	17.84	17.76	500	Complies
6	2437 MHz	17.76	18.64	500	Complies
11	2462 MHz	17.92	17.76	500	Complies

Configuration IEEE 802.11n MCS0 40MHz / Chain 1 + Chain 2

Channel	Frequency	6dB Bandwidth (MHz)	99% Occupied Bandwidth (MHz)	Min. Limit (kHz)	Test Result
3	2422 MHz	36.48	36.48	500	Complies
6	2437 MHz	36.48	36.48	500	Complies
9	2452 MHz	36.48	36.48	500	Complies

Temperature	24°C	Humidity	61%
Test Engineer	Robert Chang	Configurations	IEEE 802.11b/g
Test Mode	Mode 1. EUT 2 (with internal antenna) + Ant. 18 (Embedded antenna) / Radio 1 (2.4GHz band)		

Configuration IEEE 802.11b / Chain 2

Channel	Frequency	6dB Bandwidth (MHz)	99% Occupied Bandwidth (MHz)	Min. Limit (kHz)	Test Result
1	2412 MHz	10.08	13.92	500	Complies
6	2437 MHz	10.08	14.08	500	Complies
11	2462 MHz	10.08	14.00	500	Complies

Configuration IEEE 802.11g / Chain 1 + Chain 2

Channel	Frequency	6dB Bandwidth (MHz)	99% Occupied Bandwidth (MHz)	Min. Limit (kHz)	Test Result
1	2412 MHz	16.56	16.56	500	Complies
6	2437 MHz	16.48	18.24	500	Complies
11	2462 MHz	16.56	16.56	500	Complies

Temperature	24°C	Humidity	61%
Test Engineer	Robert Chang	Configurations	IEEE 802.11n
Test Mode	Mode 2. EUT 2 (with internal antenna) + Ant. 19 (Embedded antenna) / Radio 2 (2.4GHz + 5GHz band)		

For 2.4GHz Band
Configuration IEEE 802.11n MCS0 20MHz / Chain 1 + Chain 2

Channel	Frequency	6dB Bandwidth (MHz)	99% Occupied Bandwidth (MHz)	Min. Limit (kHz)	Test Result
1	2412 MHz	17.84	18.00	500	Complies
6	2437 MHz	17.36	17.92	500	Complies
11	2462 MHz	17.92	18.00	500	Complies

Configuration IEEE 802.11n MCS0 40MHz / Chain 1 + Chain 2

Channel	Frequency	6dB Bandwidth (MHz)	99% Occupied Bandwidth (MHz)	Min. Limit (kHz)	Test Result
3	2422 MHz	36.48	36.64	500	Complies
6	2437 MHz	35.84	36.16	500	Complies
9	2452 MHz	36.64	36.80	500	Complies

For 5GHz Band
Configuration IEEE 802.11n MCS0 20MHz / Chain 1 + Chain 2

Channel	Frequency	6dB Bandwidth (MHz)	99% Occupied Bandwidth (MHz)	Min. Limit (kHz)	Test Result
149	5745 MHz	17.76	18.08	500	Complies
157	5785 MHz	17.76	18.08	500	Complies
165	5825 MHz	17.76	18.08	500	Complies

Configuration IEEE 802.11n MCS0 40MHz / Chain 1 + Chain 2

Channel	Frequency	6dB Bandwidth (MHz)	99% Occupied Bandwidth (MHz)	Min. Limit (kHz)	Test Result
151	5755 MHz	36.64	36.64	500	Complies
159	5795 MHz	36.48	36.64	500	Complies

Temperature	24°C	Humidity	61%
Test Engineer	Robert Chang	Configurations	IEEE 802.11 a/b/g
Test Mode	Mode 2. EUT 2 (with internal antenna) + Ant. 19 (Embedded antenna) / Radio 2 (2.4GHz + 5GHz band)		

Configuration IEEE 802.11b / Chain 1

Channel	Frequency	6dB Bandwidth (MHz)	99% Occupied Bandwidth (MHz)	Min. Limit (kHz)	Test Result
1	2412 MHz	10.08	14.00	500	Complies
6	2437 MHz	10.08	13.92	500	Complies
11	2462 MHz	10.08	13.92	500	Complies

Configuration IEEE 802.11g / Chain 1 + Chain 2

Channel	Frequency	6dB Bandwidth (MHz)	99% Occupied Bandwidth (MHz)	Min. Limit (kHz)	Test Result
1	2412 MHz	16.48	16.64	500	Complies
6	2437 MHz	15.76	16.96	500	Complies
11	2462 MHz	16.40	16.56	500	Complies

Configuration IEEE 802.11a / Chain 1 + Chain 2

Channel	Frequency	6dB Bandwidth (MHz)	99% Occupied Bandwidth (MHz)	Min. Limit (kHz)	Test Result
149	5745 MHz	16.48	16.64	500	Complies
157	5785 MHz	16.40	16.64	500	Complies
165	5825 MHz	15.76	16.24	500	Complies

Note: All the test values were listed in the report.

For plots, only the channel with maximum results was shown.

**For Mode 1. EUT 2 (with internal antenna) + Ant. 18 (Embedded antenna) / Radio 1 (2.4GHz band):
6 dB Bandwidth Plot on Configuration IEEE 802.11n MCS0 20MHz / Chain 1 + Chain 2 / 2437 MHz**

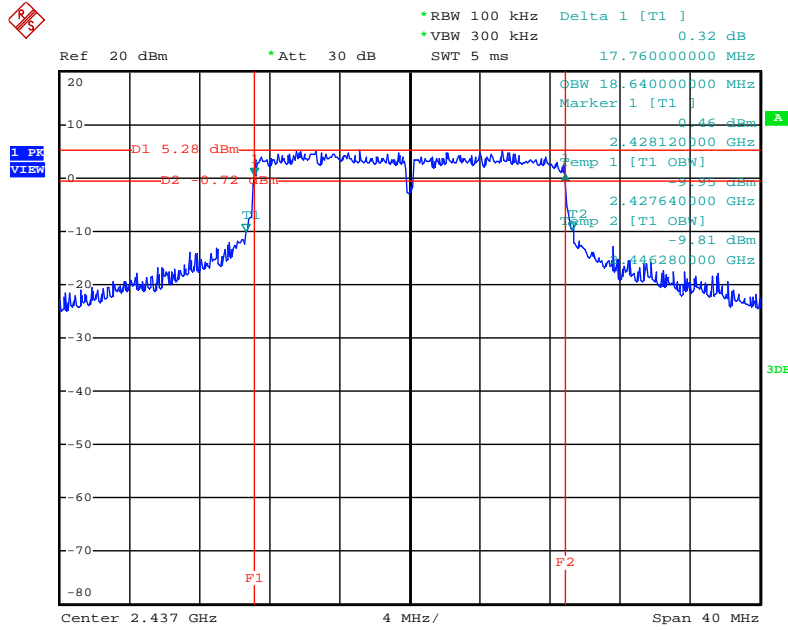

Date: 2.JAN.2013 22:50:15

6 dB Bandwidth Plot on Configuration IEEE 802.11n MCS0 40MHz / Chain 1 + Chain 2 / 2437 MHz

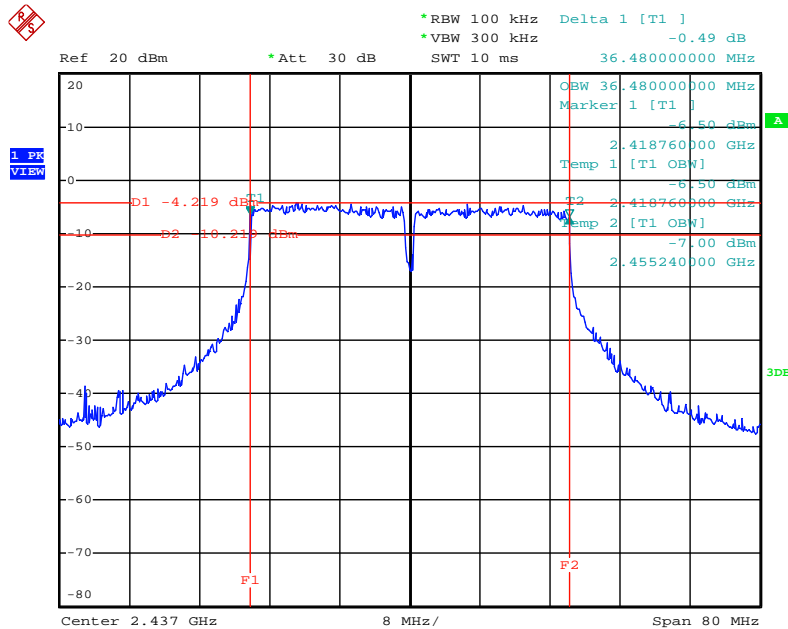

Date: 2.JAN.2013 22:52:14

6 dB Bandwidth Plot on Configuration IEEE 802.11b / Chain 2 / 2437 MHz

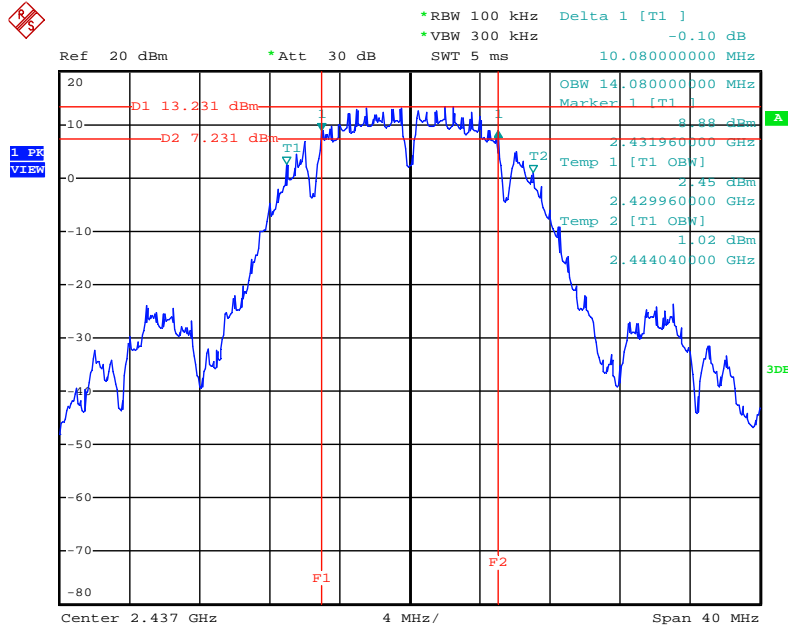

Date: 2.JAN.2013 22:42:15

6 dB Bandwidth Plot on Configuration IEEE 802.11g / Chain 1 + Chain 2 / 2437 MHz

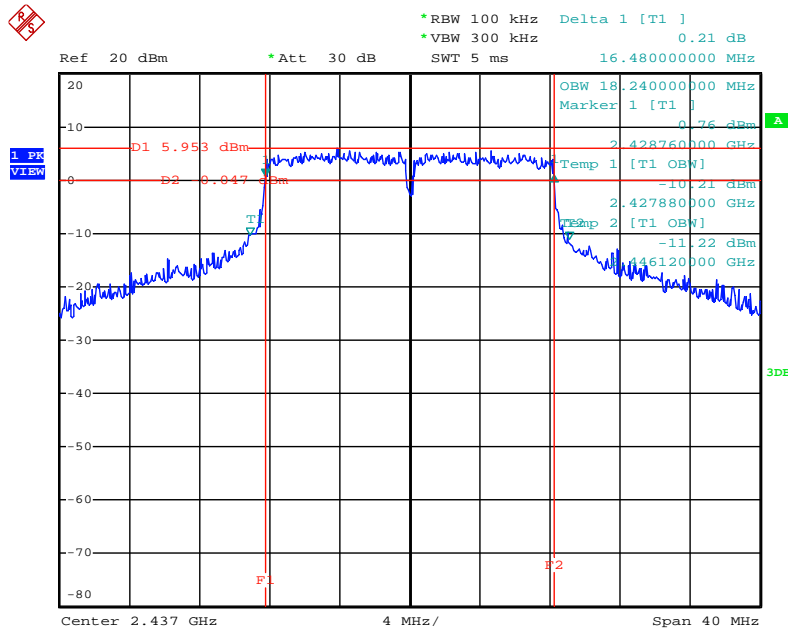

Date: 2.JAN.2013 22:45:46

For Mode 2. EUT 2 (with internal antenna) + Ant. 19 (Embedded antenna) / Radio 2 (2.4GHz + 5GHz band):

6 dB Bandwidth Plot on Configuration IEEE 802.11n MCS0 20MHz / Chain 1 + Chain 2 / 2437 MHz

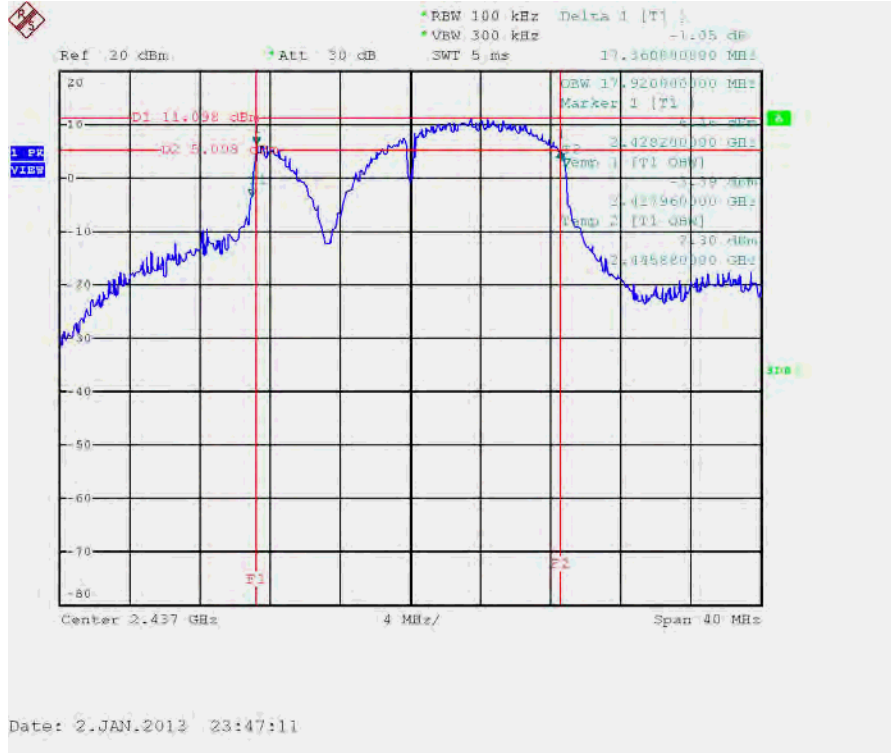

6 dB Bandwidth Plot on Configuration IEEE 802.11n MCS0 40MHz / Chain 1 + Chain 2 / 2437 MHz

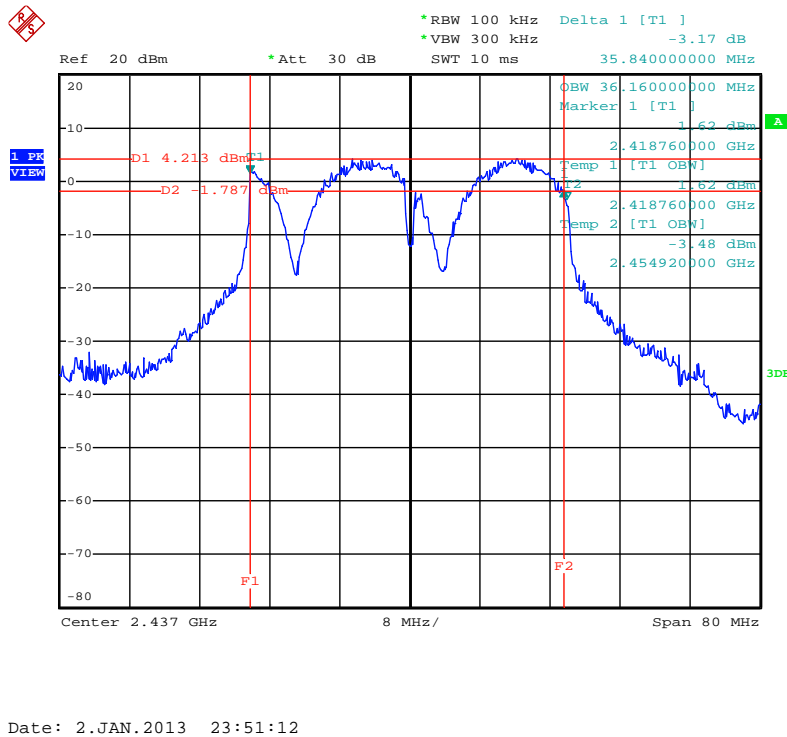

6 dB Bandwidth Plot on Configuration IEEE 802.11b / Chain 1 / 2412 MHz

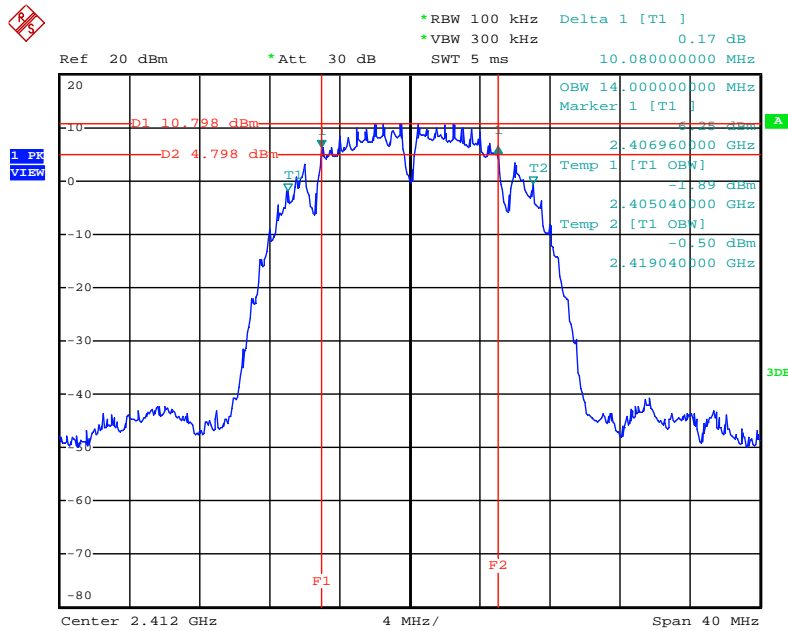

Date: 3.JAN.2013 00:05:42

6 dB Bandwidth Plot on Configuration IEEE 802.11g / Chain 1 + Chain 2 / 2437 MHz

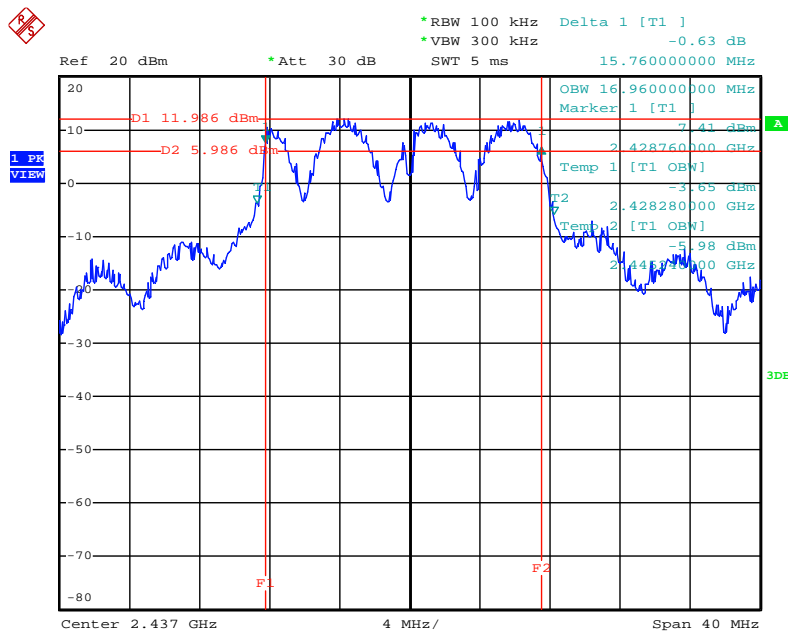

Date: 2.JAN.2013 23:43:32

6 dB Bandwidth Plot on Configuration IEEE 802.11a / Chain 1 + Chain 2 / 5825 MHz

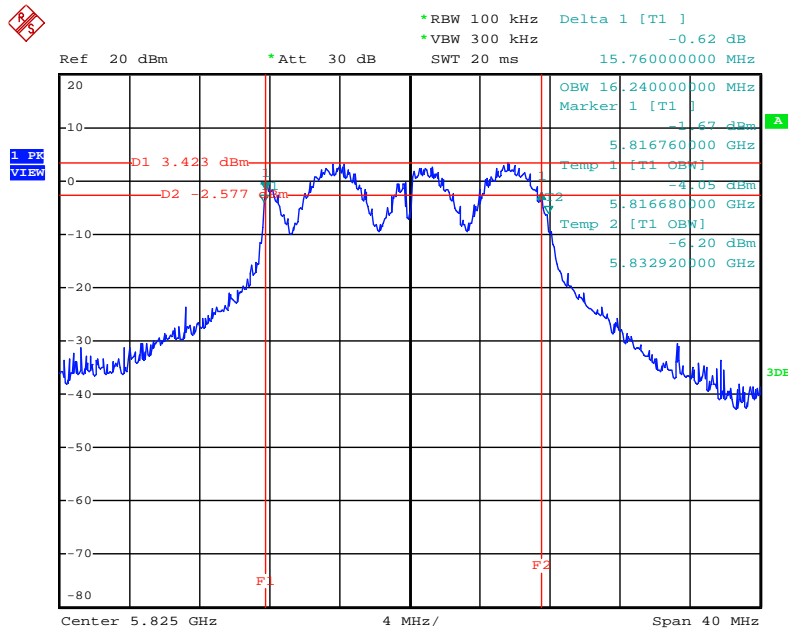

Date: 2.JAN.2013 23:57:40

4.5. Radiated Emissions Measurement

4.5.1. Limit

30dBc in any 100 kHz bandwidth outside the operating frequency band. In case the emission fall within the restricted band specified on 15.205(a), then the 15.209(a) limit in the table below has to be followed.

Frequencies (MHz)	Field Strength (microrvolts/meter)	Measurement Distance (meters)
0.009~0.490	2400/F(KHz)	300
0.490~1.705	24000/F(KHz)	30
1.705~30.0	30	30
30~88	100	3
88~216	150	3
216~960	200	3
Above 960	500	3

4.5.2. Measuring Instruments and Setting

Please refer to section 5 of equipments list in this report. The following table is the setting of spectrum analyzer and receiver.

Spectrum Parameter	Setting
Attenuation	Auto
Start Frequency	1000 MHz
Stop Frequency	10th carrier harmonic
RB / VB (Emission in restricted band)	1MHz / 3MHz for Peak, 1 MHz / 10Hz for Average
RB / VB (Emission in non-restricted band)	1MHz / 3MHz for peak

Receiver Parameter	Setting
Attenuation	Auto
Start ~ Stop Frequency	9kHz~150kHz / RB 200Hz for QP
Start ~ Stop Frequency	150kHz~30MHz / RB 9kHz for QP
Start ~ Stop Frequency	30MHz~1000MHz / RB 120kHz for QP

4.5.3. Test Procedures

1. Configure the EUT according to ANSI C63.10. The EUT was placed on the top of the turntable 0.8 meter above ground. The phase center of the receiving antenna mounted on the top of a height-variable antenna tower was placed 3 meters far away from the turntable.
2. Power on the EUT and all the supporting units. The turntable was rotated by 360 degrees to determine the position of the highest radiation.
3. The height of the broadband receiving antenna was varied between one meter and four meters above ground to find the maximum emissions field strength of both horizontal and vertical polarization.
4. For each suspected emissions, the antenna tower was scan (from 1 M to 4 M) and then the turntable was rotated (from 0 degree to 360 degrees) to find the maximum reading.
5. Set the test-receiver system to Peak or CISPR quasi-peak Detect Function with specified bandwidth under Maximum Hold Mode.
6. For emissions above 1GHz, use 1MHz VBW and 3MHz RBW for peak reading. Then 1MHz RBW and 10Hz VBW for average reading in spectrum analyzer.
7. When the radiated emissions limits are expressed in terms of the average value of the emissions, and pulsed operation is employed, the measurement field strength shall be determined by averaging over one complete pulse train, including blanking intervals, as long as the pulse train does not exceed 0.1 seconds. As an alternative (provided the transmitter operates for longer than 0.1 seconds) or in cases where the pulse train exceeds 0.1 seconds, the measured field strength shall be determined from the average absolute voltage during a 0.1 second interval during which the field strength is at its maximum value.
8. If the emissions level of the EUT in peak mode was 3 dB lower than the average limit specified, then testing will be stopped and peak values of EUT will be reported, otherwise, the emissions which do not have 3 dB margin will be repeated one by one using the quasi-peak method for below 1GHz.
9. For testing above 1GHz, the emissions level of the EUT in peak mode was lower than average limit (that means the emissions level in peak mode also complies with the limit in average mode), then testing will be stopped and peak values of EUT will be reported, otherwise, the emissions will be measured in average mode again and reported.
10. In case the emission is lower than 30MHz, loop antenna has to be used for measurement and the recorded data should be QP measured by receiver. High – Low scan is not required in this case.

4.5.4. Test Setup Layout

For radiated emissions below 1GHz

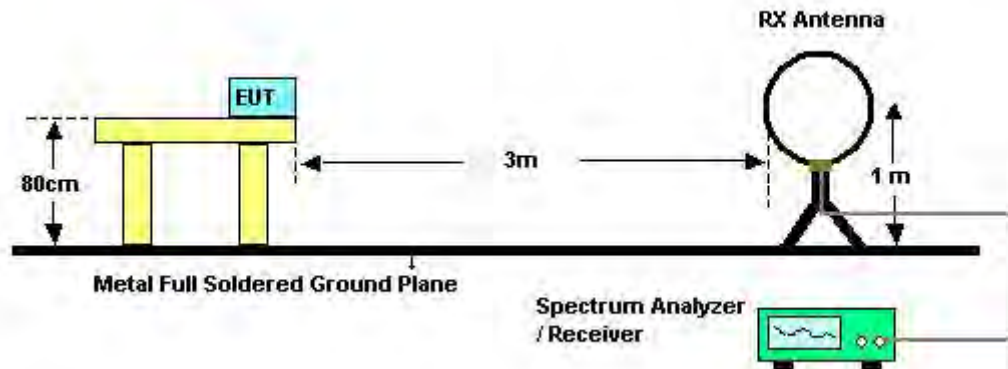

For radiated emissions above 1GHz

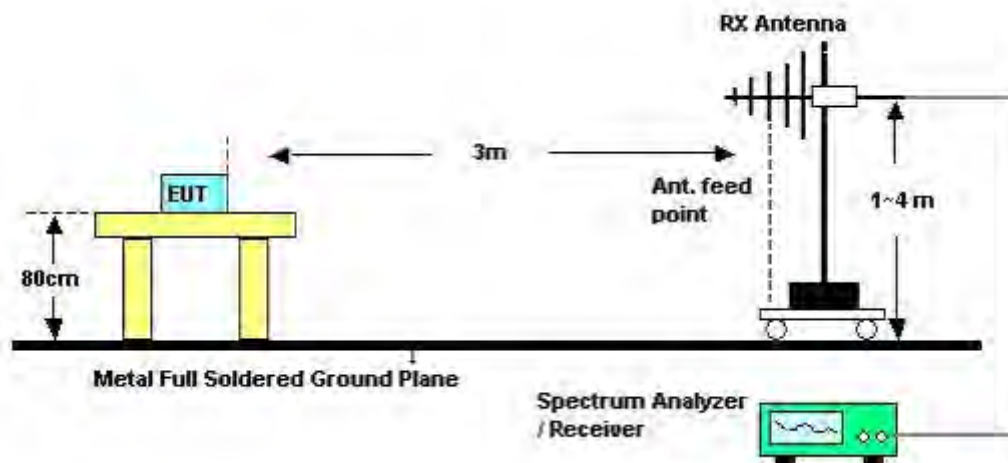

4.5.5. Test Deviation

There is no deviation with the original standard.

4.5.6. EUT Operation during Test

The EUT was programmed to be in continuously transmitting mode.

4.5.7. Results of Radiated Emissions (9kHz~30MHz)

Temperature	26°C	Humidity	60%
Test Engineer	Jim Huang	Test Date	Dec. 29, 2012
Test Mode	Mode 2 / Mode 5		

Freq. (MHz)	Level (dBuV)	Over Limit (dB)	Limit Line (dBuV)	Remark
-	-	-	-	See Note

Note:

The amplitude of spurious emissions that are attenuated by more than 20 dB below the permissible value has no need to be reported.

Distance extrapolation factor = $40 \log(\text{specific distance} / \text{test distance})$ (dB);

Limit line = specific limits (dBuV) + distance extrapolation factor.

4.5.8. Results of Radiated Emissions (30MHz~1GHz)

Temperature	26°C	Humidity	60%
Test Engineer	Jim Huang	Configurations	Normal Link
Test Mode	Mode 2. EUT 1 (with external antenna) + Patch antenna / Ant. 2 (2.4GHz) and Ant. 6 (5GHz)		

Horizontal

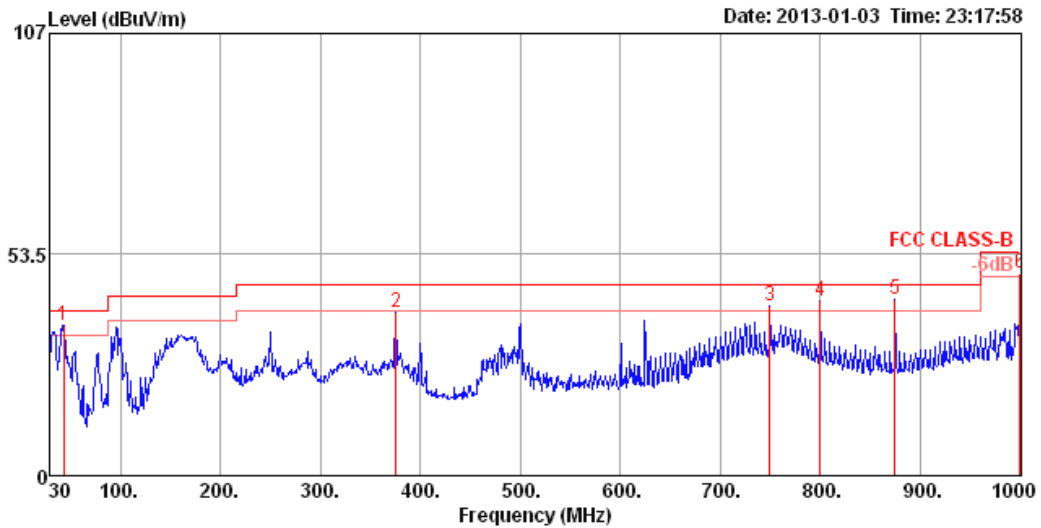

	Freq	Level	Limit	Over	Read	CableAntenna	Preamp	A/Pos	T/Pos	Pol/Phase	Remark
	MHz	dBuV/m	dBuV/m	dB	dBuV	dB	dB/m	dB	cm	deg	
1 !	43.58	36.26	40.00	-3.74	55.70	0.78	11.62	31.84	150	2	HORIZONTAL Peak
2	375.32	39.56	46.00	-6.44	52.63	2.44	15.92	31.43	125	0	HORIZONTAL Peak
3 !	749.74	40.88	46.00	-5.12	48.52	3.53	20.20	31.37	100	338	HORIZONTAL Peak
4 !	800.18	42.42	46.00	-3.58	49.22	3.67	20.80	31.27	100	355	HORIZONTAL Peak
5 pp	874.87	42.47	46.00	-3.53	48.38	3.89	21.35	31.15	150	326	HORIZONTAL Peak
6 !	1000.00	49.12	54.00	-4.88	53.89	4.21	22.20	31.18	125	329	HORIZONTAL Peak

Vertical

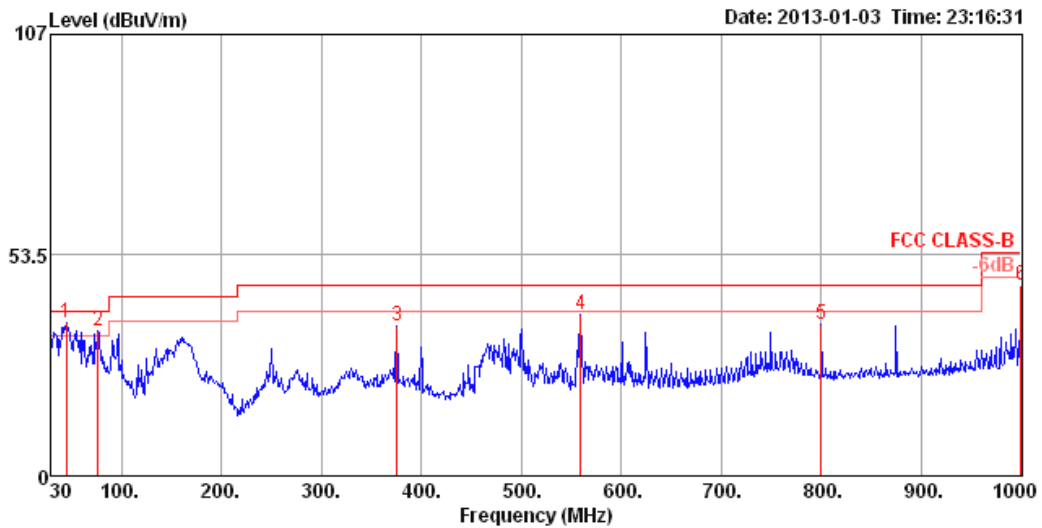

	Freq	Level	Limit	Over	Read	CableAntenna	Preamp	A/Pos	T/Pos	Pol/Phase	Remark	
	MHz	dBuV/m	dBuV/m	dB	dBuV	Loss	Factor	dB	cm	deg		
1	pp	44.55	36.93	40.00	-3.07	56.91	0.79	11.06	31.83	100	80 VERTICAL	Peak
2	!	76.56	35.11	40.00	-4.89	58.55	1.03	7.22	31.69	150	249 VERTICAL	Peak
3		375.32	36.43	46.00	-9.57	49.50	2.44	15.92	31.43	150	360 VERTICAL	Peak
4		559.62	39.12	46.00	-6.88	48.51	2.96	18.90	31.25	100	0 VERTICAL	Peak
5		800.18	36.75	46.00	-9.25	43.55	3.67	20.80	31.27	125	50 VERTICAL	Peak
6		1000.00	46.26	54.00	-7.74	51.03	4.21	22.20	31.18	100	277 VERTICAL	Peak

Temperature	26°C	Humidity	60%
Test Engineer	Jim Huang	Configurations	Normal Link
Test Mode	Mode 5. EUT 2 (with internal antenna) + Embedded antenna / Ant. 18 (2.4GHz) + Ant. 19 (5GHz)		

Horizontal

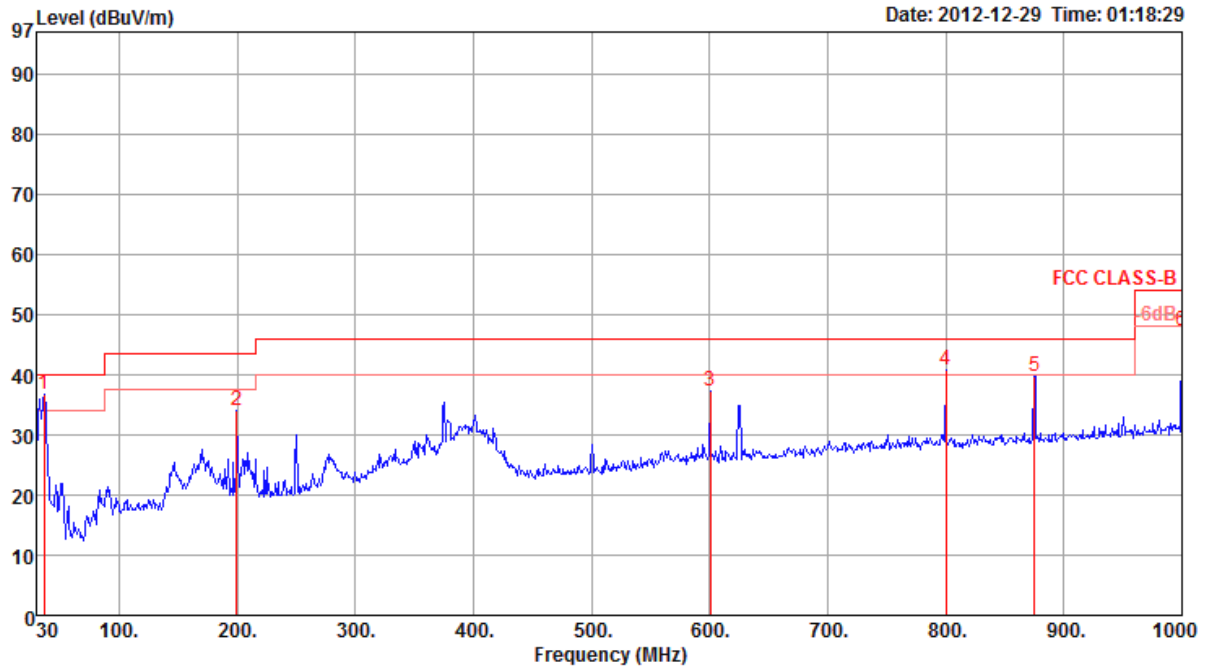

	Freq	Level	Limit	Over	Read	Cable	Preamp	Antenna	Remark	T/Pos	A/Pos	Pol/Phase
	MHz	dBuV/m	dBuV/m	dB	dBuV	dB	dB	dB/m		deg	cm	
1	36.79	36.78	40.00	-3.22	48.21	0.95	28.00	15.62	Peak	0	400	HORIZONTAL
2	199.75	34.00	43.50	-9.50	48.76	2.09	27.25	10.40	Peak	0	400	HORIZONTAL
3	600.36	37.36	46.00	-8.64	41.93	3.73	27.60	19.30	Peak	0	400	HORIZONTAL
4	800.18	40.77	46.00	-5.23	42.50	4.36	26.89	20.80	Peak	0	400	HORIZONTAL
5	874.87	39.82	46.00	-6.18	40.82	4.51	26.86	21.35	Peak	0	400	HORIZONTAL
6	1000.00	47.33	54.00	-6.67	46.51	4.84	26.22	22.20	Peak	0	400	HORIZONTAL

Vertical

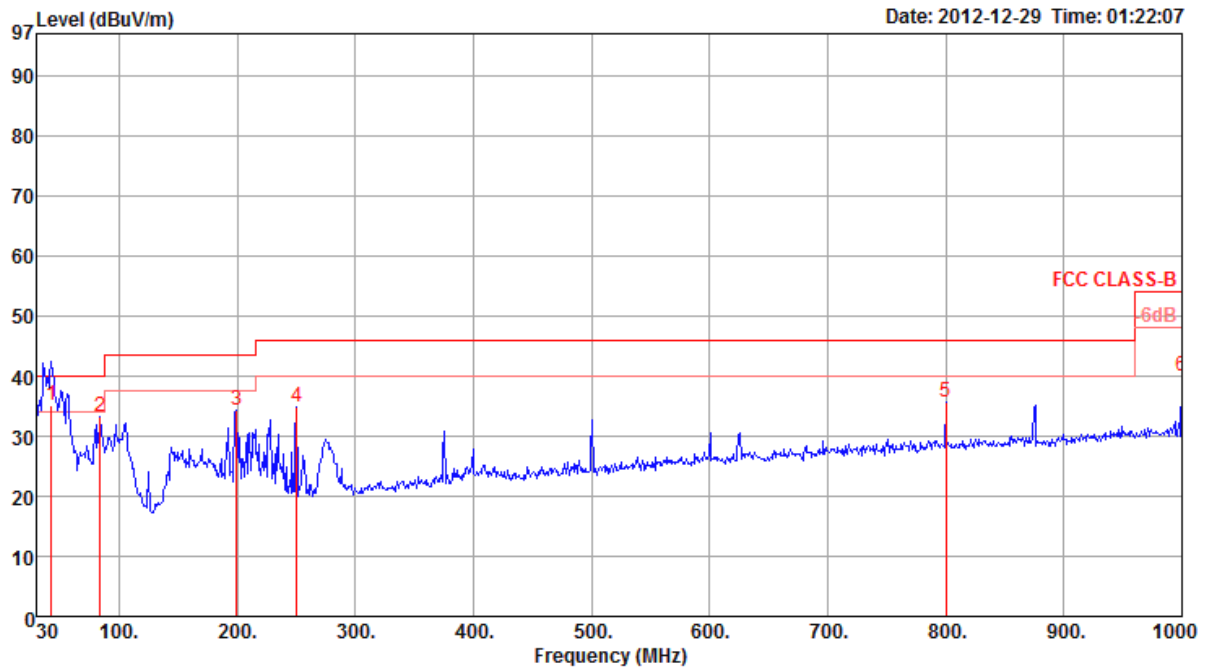

	Freq	Level	Limit	Over	Read	Cable	Preamp	Antenna	Remark	T/Pos	A/Pos	Pol/Phase
	MHz	dBuV/m	dBuV/m	dB	dBuV	dB	dB	dB/m		deg	cm	
1	q	42.95	35.19	40.00	-4.81	50.19	1.00	27.96	11.96	QP	219	100 VERTICAL
2	p	84.32	33.19	40.00	-6.81	51.49	1.37	27.89	8.22	Peak	0	100 VERTICAL
3		199.75	34.32	43.50	-9.18	49.08	2.09	27.25	10.40	Peak	0	100 VERTICAL
4		250.19	34.89	46.00	-11.11	46.56	2.38	26.95	12.90	Peak	0	100 VERTICAL
5		800.18	35.71	46.00	-10.29	37.44	4.36	26.89	20.80	Peak	0	100 VERTICAL
6		1000.00	40.09	54.00	-13.91	39.27	4.84	26.22	22.20	Peak	0	100 VERTICAL

Note:

The amplitude of spurious emissions that are attenuated by more than 20dB below the permissible value has no need to be reported.

Emission level (dBuV/m) = 20 log Emission level (uV/m).

Corrected Reading: Antenna Factor + Cable Loss + Read Level - Preamp Factor = Level.

4.5.9. Results for Radiated Emissions (1GHz~10th Harmonic)

Temperature	26°C	Humidity	60%
Test Engineer	Jim Huang	Test Date	Dec. 26, 2012
Configurations	IEEE 802.11n MCS0 20MHz Ch 1 / Chain 1 + Chain 2		
Test Mode	Mode 1. EUT 2 (with internal antenna) + Ant. 18 (Embedded antenna) / Radio 1 (2.4GHz band)		

Horizontal

	Freq	Level	Limit Line	Over Limit	Read Level	Cable Loss	Antenna Factor	Preamp Factor	Remark	A/Pos	T/Pos	Pol/Phase
	MHz	dBuV/m	dBuV/m	dB	dBuV	dB	dB/m	dB		cm	deg	
1	4824.56	37.00	54.00	-17.00	32.54	6.27	33.39	35.20	Average	100	236	HORIZONTAL
2	4827.44	51.46	74.00	-22.54	47.00	6.27	33.39	35.20	Peak	100	236	HORIZONTAL

Vertical

	Freq	Level	Limit Line	Over Limit	Read Level	Cable Loss	Antenna Factor	Preamp Factor	Remark	A/Pos	T/Pos	Pol/Phase
	MHz	dBuV/m	dBuV/m	dB	dBuV	dB	dB/m	dB		cm	deg	
1	4824.32	52.46	74.00	-21.54	48.00	6.27	33.39	35.20	Peak	110	76	VERTICAL
2	4824.36	38.34	54.00	-15.66	33.88	6.27	33.39	35.20	Average	110	76	VERTICAL

Temperature	26°C	Humidity	60%
Test Engineer	Jim Huang	Test Date	Dec. 26, 2012
Configurations	IEEE 802.11n MCS0 20MHz Ch 6 / Chain 1 + Chain 2		
Test Mode	Mode 1. EUT 2 (with internal antenna) + Ant. 18 (Embedded antenna) / Radio 1 (2.4GHz band)		

Horizontal

	Freq	Level	Limit Line	Over Limit	Read Level	CableAntenna Loss	Antenna Factor	Preamp Factor	Remark	A/Pos	T/Pos	Pol/Phase
	MHz	dBuV/m	dBuV/m	dB	dBuV	dB	dB/m	dB		cm	deg	
1	2287.91	55.99	74.00	-18.01	58.89	4.26	27.80	34.96	Peak	158	78	HORIZONTAL
2	2287.97	48.62	54.00	-5.38	51.52	4.26	27.80	34.96	Average	158	78	HORIZONTAL
3	4873.00	48.21	54.00	-5.79	43.62	6.31	33.48	35.20	Average	100	228	HORIZONTAL
4	4874.80	62.95	74.00	-11.05	58.36	6.31	33.48	35.20	Peak	100	228	HORIZONTAL
5	7303.52	37.27	54.00	-16.73	28.70	7.51	36.48	35.42	Average	100	42	HORIZONTAL
6	7311.60	49.60	74.00	-24.40	41.01	7.51	36.51	35.43	Peak	100	42	HORIZONTAL

Vertical

	Freq	Level	Limit Line	Over Limit	Read Level	CableAntenna Loss	Antenna Factor	Preamp Factor	Remark	A/Pos	T/Pos	Pol/Phase
	MHz	dBuV/m	dBuV/m	dB	dBuV	dB	dB/m	dB		cm	deg	
1	2287.97	50.21	54.00	-3.79	53.11	4.26	27.80	34.96	Average	100	219	VERTICAL
2	2288.16	58.10	74.00	-15.90	61.00	4.26	27.80	34.96	Peak	100	219	VERTICAL
3	4877.30	61.06	74.00	-12.94	56.47	6.31	33.48	35.20	Peak	100	133	VERTICAL
4	4879.20	45.45	54.00	-8.55	40.86	6.31	33.48	35.20	Average	100	133	VERTICAL
5	7309.32	37.70	54.00	-16.30	29.11	7.51	36.51	35.43	Average	100	177	VERTICAL
6	7311.52	50.38	74.00	-23.62	41.79	7.51	36.51	35.43	Peak	100	177	VERTICAL

Temperature	26°C	Humidity	60%
Test Engineer	Jim Huang	Test Date	Dec. 27, 2012
Configurations	IEEE 802.11n MCS0 20MHz Ch 11 / Chain 1 + Chain 2		
Test Mode	Mode 1. EUT 2 (with internal antenna) + Ant. 18 (Embedded antenna) / Radio 1 (2.4GHz band)		

Horizontal

	Freq	Level	Limit Line	Over Limit	Read Level	CableAntenna Loss	Antenna Factor	Preamp Factor	Remark	A/Pos	T/Pos	Pol/Phase
	MHz	dBuV/m	dBuV/m	dB	dBuV	dB	dB/m	dB		cm	deg	
1	4923.32	50.96	74.00	-23.04	46.23	6.35	33.58	35.20	Peak	100	143	HORIZONTAL
2	4924.36	37.16	54.00	-16.84	32.43	6.35	33.58	35.20	Average	100	143	HORIZONTAL
3	7380.08	36.65	54.00	-17.35	27.88	7.61	36.61	35.45	Average	100	195	HORIZONTAL
4	7380.72	49.45	74.00	-24.55	40.68	7.61	36.61	35.45	Peak	100	195	HORIZONTAL

Vertical

	Freq	Level	Limit Line	Over Limit	Read Level	CableAntenna Loss	Antenna Factor	Preamp Factor	Remark	A/Pos	T/Pos	Pol/Phase
	MHz	dBuV/m	dBuV/m	dB	dBuV	dB	dB/m	dB		cm	deg	
1	4923.44	36.30	54.00	-17.70	31.57	6.35	33.58	35.20	Average	100	131	VERTICAL
2	4927.28	49.73	74.00	-24.27	45.00	6.35	33.58	35.20	Peak	100	131	VERTICAL
3	7376.00	36.75	54.00	-17.25	27.98	7.61	36.61	35.45	Average	100	286	VERTICAL
4	7389.68	49.28	74.00	-24.72	40.49	7.64	36.61	35.46	Peak	100	286	VERTICAL

Temperature	26°C	Humidity	60%
Test Engineer	Jim Huang	Test Date	Dec. 27, 2012
Configurations	IEEE 802.11n MCS0 40MHz Ch 3 / Chain 1 + Chain 2		
Test Mode	Mode 1. EUT 2 (with internal antenna) + Ant. 18 (Embedded antenna) / Radio 1 (2.4GHz band)		

Horizontal

	Freq	Level	Limit Line	Over Limit	Read Level	CableAntenna Loss	Antenna Factor	Preamp Factor	Remark	A/Pos	T/Pos	Pol/Phase
	MHz	dBuV/m	dBuV/m	dB	dBuV	dB	dB/m	dB		cm	deg	
1	4840.00	34.27	54.00	-19.73	29.76	6.29	33.42	35.20	Average	100	283	HORIZONTAL
2	4852.70	46.16	74.00	-27.84	41.65	6.29	33.42	35.20	Peak	100	283	HORIZONTAL

Vertical

	Freq	Level	Limit Line	Over Limit	Read Level	CableAntenna Loss	Antenna Factor	Preamp Factor	Remark	A/Pos	T/Pos	Pol/Phase
	MHz	dBuV/m	dBuV/m	dB	dBuV	dB	dB/m	dB		cm	deg	
1	4819.00	44.63	74.00	-29.37	40.20	6.27	33.36	35.20	Peak	100	178	VERTICAL
2	4828.90	32.57	54.00	-21.43	28.11	6.27	33.39	35.20	Average	100	178	VERTICAL

Temperature	26°C	Humidity	60%
Test Engineer	Jim Huang	Test Date	Dec. 27, 2012
Configurations	IEEE 802.11n MCS0 40MHz Ch 6 / Chain 1 + Chain 2		
Test Mode	Mode 1. EUT 2 (with internal antenna) + Ant. 18 (Embedded antenna) / Radio 1 (2.4GHz band)		

Horizontal

	Freq	Level	Limit	Over	Read	Cable	Antenna	Preamp	Remark	A/Pos	T/Pos	Pol/Phase
	MHz	dBuV/m	dBuV/m	dB	dBuV	dB	dB/m	dB		cm	deg	
1	4869.10	48.58	74.00	-25.42	44.02	6.31	33.45	35.20	Peak	100	229	HORIZONTAL
2	4871.30	36.46	54.00	-17.54	31.87	6.31	33.48	35.20	Average	100	229	HORIZONTAL
3	7292.80	36.77	54.00	-17.23	28.20	7.51	36.48	35.42	Average	100	94	HORIZONTAL
4	7300.50	49.43	74.00	-24.57	40.86	7.51	36.48	35.42	Peak	100	94	HORIZONTAL

Vertical

	Freq	Level	Limit	Over	Read	Cable	Antenna	Preamp	Remark	A/Pos	T/Pos	Pol/Phase
	MHz	dBuV/m	dBuV/m	dB	dBuV	dB	dB/m	dB		cm	deg	
1	4860.10	35.31	54.00	-18.69	30.77	6.29	33.45	35.20	Average	100	174	VERTICAL
2	4883.70	47.98	74.00	-26.02	43.39	6.31	33.48	35.20	Peak	100	174	VERTICAL
3	7295.00	36.72	54.00	-17.28	28.15	7.51	36.48	35.42	Average	100	279	VERTICAL
4	7309.70	49.74	74.00	-24.26	41.15	7.51	36.51	35.43	Peak	100	279	VERTICAL

Temperature	26°C	Humidity	60%
Test Engineer	Jim Huang	Test Date	Dec. 27, 2012
Configurations	IEEE 802.11n MCS0 40MHz Ch 9 / Chain 1 + Chain 2		
Test Mode	Mode 1. EUT 2 (with internal antenna) + Ant. 18 (Embedded antenna) / Radio 1 (2.4GHz band)		

Horizontal

	Freq	Level	Limit Line	Over Limit	Read Level	CableAntenna Loss	Antenna Factor	Preamp Factor	Remark	A/Pos	T/Pos	Pol/Phase
	MHz	dBuV/m	dBuV/m	dB	dBuV	dB	dB/m	dB		cm	deg	
1	4904.10	33.18	54.00	-20.82	28.54	6.33	33.51	35.20	Average	100	197	HORIZONTAL
2	4913.10	45.52	74.00	-28.48	40.83	6.35	33.54	35.20	Peak	100	197	HORIZONTAL
3	7348.60	49.18	74.00	-24.82	40.49	7.57	36.56	35.44	Peak	100	328	HORIZONTAL
4	7367.90	37.02	54.00	-16.98	28.27	7.61	36.59	35.45	Average	100	328	HORIZONTAL

Vertical

	Freq	Level	Limit Line	Over Limit	Read Level	CableAntenna Loss	Antenna Factor	Preamp Factor	Remark	A/Pos	T/Pos	Pol/Phase
	MHz	dBuV/m	dBuV/m	dB	dBuV	dB	dB/m	dB		cm	deg	
1	4900.70	45.78	74.00	-28.22	41.14	6.33	33.51	35.20	Peak	100	149	VERTICAL
2	4919.60	32.49	54.00	-21.51	27.80	6.35	33.54	35.20	Average	100	149	VERTICAL
3	7363.70	36.93	54.00	-17.07	28.18	7.61	36.59	35.45	Average	100	256	VERTICAL
4	7370.30	49.63	74.00	-24.37	40.88	7.61	36.59	35.45	Peak	100	256	VERTICAL

Temperature	26°C	Humidity	60%
Test Engineer	Jim Huang	Test Date	Dec. 25, 2012
Configurations	IEEE 802.11b CH 1 / Chain 2		
Test Mode	Mode 1. EUT 2 (with internal antenna) + Ant. 18 (Embedded antenna) / Radio 1 (2.4GHz band)		

Horizontal

	Freq	Level	Limit Line	Over Limit	Read Level	CableAntenna Loss	Antenna Factor	Preamp Factor	Remark	A/Pos	T/Pos	Pol/Phase
	MHz	dBuV/m	dBuV/m	dB	dBuV	dB	dB/m	dB		cm	deg	
1	4823.97	53.55	54.00	-0.45	49.09	6.27	33.39	35.20	Average	125	252	HORIZONTAL
2	4824.00	56.27	74.00	-17.73	51.81	6.27	33.39	35.20	Peak	125	252	HORIZONTAL

Vertical

	Freq	Level	Limit Line	Over Limit	Read Level	CableAntenna Loss	Antenna Factor	Preamp Factor	Remark	A/Pos	T/Pos	Pol/Phase
	MHz	dBuV/m	dBuV/m	dB	dBuV	dB	dB/m	dB		cm	deg	
1	4823.90	53.93	74.00	-20.07	49.47	6.27	33.39	35.20	Peak	124	145	VERTICAL
2	4823.96	50.05	54.00	-3.95	45.59	6.27	33.39	35.20	Average	124	145	VERTICAL

Temperature	26°C	Humidity	60%
Test Engineer	Jim Huang	Test Date	Dec. 25, 2012
Configurations	IEEE 802.11b CH 6 / Chain 2		
Test Mode	Mode 1. EUT 2 (with internal antenna) + Ant. 18 (Embedded antenna) / Radio 1 (2.4GHz band)		

Horizontal

	Freq	Level	Limit Line	Over Limit	Read Level	CableAntenna Loss	Antenna Factor	Preamp Factor	Remark	A/Pos	T/Pos	Pol/Phase
	MHz	dBuV/m	dBuV/m	dB	dBuV	dB	dB/m	dB		cm	deg	
1	4873.95	55.43	74.00	-18.57	50.84	6.31	33.48	35.20	Peak	100	166	HORIZONTAL
2	4873.97	52.38	54.00	-1.62	47.79	6.31	33.48	35.20	Average	100	166	HORIZONTAL

Vertical

	Freq	Level	Limit Line	Over Limit	Read Level	CableAntenna Loss	Antenna Factor	Preamp Factor	Remark	A/Pos	T/Pos	Pol/Phase
	MHz	dBuV/m	dBuV/m	dB	dBuV	dB	dB/m	dB		cm	deg	
1	4873.97	51.65	54.00	-2.35	47.06	6.31	33.48	35.20	Average	100	174	VERTICAL
2	4874.02	54.82	74.00	-19.18	50.23	6.31	33.48	35.20	Peak	100	174	VERTICAL

Temperature	26°C	Humidity	60%
Test Engineer	Jim Huang	Test Date	Dec. 25, 2012
Configurations	IEEE 802.11b CH 11 / Chain 2		
Test Mode	Mode 1. EUT 2 (with internal antenna) + Ant. 18 (Embedded antenna) / Radio 1 (2.4GHz band)		

Horizontal

	Freq	Level	Limit Line	Over Limit	Read Level	CableAntenna Loss	Antenna Factor	Preamp Factor	Remark	A/Pos	T/Pos	Pol/Phase
	MHz	dBuV/m	dBuV/m	dB	dBuV	dB	dB/m	dB		cm	deg	
1	4923.97	53.46	54.00	-0.54	48.73	6.35	33.58	35.20	Average	100	70	HORIZONTAL
2	4924.01	56.16	74.00	-17.84	51.43	6.35	33.58	35.20	Peak	100	70	HORIZONTAL

Vertical

	Freq	Level	Limit Line	Over Limit	Read Level	CableAntenna Loss	Antenna Factor	Preamp Factor	Remark	A/Pos	T/Pos	Pol/Phase
	MHz	dBuV/m	dBuV/m	dB	dBuV	dB	dB/m	dB		cm	deg	
1	4923.94	52.98	74.00	-21.02	48.25	6.35	33.58	35.20	Peak	102	73	VERTICAL
2	4923.97	48.38	54.00	-5.62	43.65	6.35	33.58	35.20	Average	102	73	VERTICAL

Temperature	26°C	Humidity	60%
Test Engineer	Jim Huang	Test Date	Dec. 26, 2012
Configurations	IEEE 802.11g CH 1 / Chain 1 + Chain 2		
Test Mode	Mode 1. EUT 2 (with internal antenna) + Ant. 18 (Embedded antenna) / Radio 1 (2.4GHz band)		

Horizontal

	Freq	Level	Limit Line	Over Limit	Read Level	CableAntenna Loss	Antenna Factor	Preamp Factor	Remark	A/Pos	T/Pos	Pol/Phase
	MHz	dBuV/m	dBuV/m	dB	dBuV	dB	dB/m	dB		cm	deg	
1	4823.60	37.92	54.00	-16.08	33.46	6.27	33.39	35.20	Average	111	278	HORIZONTAL
2	4824.28	53.43	74.00	-20.57	48.97	6.27	33.39	35.20	Peak	111	278	HORIZONTAL

Vertical

	Freq	Level	Limit Line	Over Limit	Read Level	CableAntenna Loss	Antenna Factor	Preamp Factor	Remark	A/Pos	T/Pos	Pol/Phase
	MHz	dBuV/m	dBuV/m	dB	dBuV	dB	dB/m	dB		cm	deg	
1	4824.40	31.70	54.00	-22.30	27.24	6.27	33.39	35.20	Average	100	360	VERTICAL
2	4831.00	45.45	74.00	-28.55	40.99	6.27	33.39	35.20	Peak	100	360	VERTICAL

Temperature	26°C	Humidity	60%
Test Engineer	Jim Huang	Test Date	Dec. 26, 2012
Configurations	IEEE 802.11g CH 6 / Chain 1 + Chain 2		
Test Mode	Mode 1. EUT 2 (with internal antenna) + Ant. 18 (Embedded antenna) / Radio 1 (2.4GHz band)		

Horizontal

	Freq	Level	Limit Line	Over Limit	Read Level	CableAntenna Loss	Antenna Factor	Preamp Factor	Remark	A/Pos	T/Pos	Pol/Phase
	MHz	dBuV/m	dBuV/m	dB	dBuV	dB	dB/m	dB		cm	deg	
1	4873.64	49.52	54.00	-4.48	44.93	6.31	33.48	35.20	Average	100	234	HORIZONTAL
2	4874.40	64.70	74.00	-9.30	60.11	6.31	33.48	35.20	Peak	100	234	HORIZONTAL
3	7307.88	38.33	54.00	-15.67	29.74	7.51	36.51	35.43	Average	2950	107	HORIZONTAL
4	7313.28	51.63	74.00	-22.37	43.01	7.54	36.51	35.43	Peak	100	107	HORIZONTAL

Vertical

	Freq	Level	Limit Line	Over Limit	Read Level	CableAntenna Loss	Antenna Factor	Preamp Factor	Remark	A/Pos	T/Pos	Pol/Phase
	MHz	dBuV/m	dBuV/m	dB	dBuV	dB	dB/m	dB		cm	deg	
1	4870.88	47.08	54.00	-6.92	42.49	6.31	33.48	35.20	Average	142	132	VERTICAL
2	4874.80	62.53	74.00	-11.47	57.94	6.31	33.48	35.20	Peak	100	132	VERTICAL
3	7307.96	37.16	54.00	-16.84	28.57	7.51	36.51	35.43	Average	100	194	VERTICAL
4	7316.00	50.12	74.00	-23.88	41.50	7.54	36.51	35.43	Peak	100	194	VERTICAL

Temperature	26°C	Humidity	60%
Test Engineer	Jim Huang	Test Date	Dec. 26, 2012
Configurations	IEEE 802.11g CH 11 / Chain 1 + Chain 2		
Test Mode	Mode 1. EUT 2 (with internal antenna) + Ant. 18 (Embedded antenna) / Radio 1 (2.4GHz band)		

Horizontal

	Freq	Level	Limit Line	Over Limit	Read Level	Cable Loss	Antenna Factor	Preamp Factor	Remark	A/Pos	T/Pos	Pol/Phase
	MHz	dBuV/m	dBuV/m	dB	dBuV	dB	dB/m	dB		cm	deg	
1	4923.48	39.70	54.00	-14.30	34.97	6.35	33.58	35.20	Average	100	145	HORIZONTAL
2	4928.64	55.12	74.00	-18.88	50.39	6.35	33.58	35.20	Peak	100	145	HORIZONTAL
3	7401.30	49.95	74.00	-24.05	41.13	7.64	36.64	35.46	Peak	100	214	HORIZONTAL
4	7411.00	36.05	54.00	-17.95	27.21	7.64	36.67	35.47	Average	100	214	HORIZONTAL

Vertical

	Freq	Level	Limit Line	Over Limit	Read Level	Cable Loss	Antenna Factor	Preamp Factor	Remark	A/Pos	T/Pos	Pol/Phase
	MHz	dBuV/m	dBuV/m	dB	dBuV	dB	dB/m	dB		cm	deg	
1	4924.40	38.28	54.00	-15.72	33.55	6.35	33.58	35.20	Average	100	131	VERTICAL
2	4925.12	54.07	74.00	-19.93	49.34	6.35	33.58	35.20	Peak	100	131	VERTICAL
3	7395.80	37.07	54.00	-16.93	28.25	7.64	36.64	35.46	Average	100	173	VERTICAL
4	7410.90	49.78	74.00	-24.22	40.94	7.64	36.67	35.47	Peak	100	173	VERTICAL

Note:

The amplitude of spurious emissions that are attenuated by more than 20dB below the permissible value has no need to be reported.

Emission level (dBuV/m) = 20 log Emission level (uV/m).

Corrected Reading: Antenna Factor + Cable Loss + Read Level - Preamp Factor = Level.

Temperature	26°C	Humidity	60%
Test Engineer	Jim Huang	Test Date	Dec. 27, 2012
Configurations	IEEE 802.11n MCS0 20MHz Ch 1 / Chain 1 + Chain 2		
Test Mode	Mode 2. EUT 2 (with internal antenna) + Ant. 19 (Embedded antenna) / Radio 2 (2.4GHz + 5GHz band)		

Horizontal

	Freq	Level	Limit Line	Over Limit	Read Level	CableAntenna Loss	Antenna Factor	Preamp Factor	Remark	A/Pos	T/Pos	Pol/Phase
	MHz	dBuV/m	dBuV/m	dB	dBuV	dB	dB/m	dB		cm	deg	
1	4822.90	34.68	54.00	-19.32	30.22	6.27	33.39	35.20	Average	100	220	HORIZONTAL
2	4827.90	47.54	74.00	-26.46	43.08	6.27	33.39	35.20	Peak	100	220	HORIZONTAL

Vertical

	Freq	Level	Limit Line	Over Limit	Read Level	CableAntenna Loss	Antenna Factor	Preamp Factor	Remark	A/Pos	T/Pos	Pol/Phase
	MHz	dBuV/m	dBuV/m	dB	dBuV	dB	dB/m	dB		cm	deg	
1	4821.30	48.80	74.00	-25.20	44.34	6.27	33.39	35.20	Peak	100	172	VERTICAL
2	4823.10	36.20	54.00	-17.80	31.74	6.27	33.39	35.20	Average	100	172	VERTICAL



Temperature	26°C	Humidity	60%
Test Engineer	Jim Huang	Test Date	Dec. 27, 2012
Configurations	IEEE 802.11n MCS0 20MHz Ch 6 / Chain 1 + Chain 2		
Test Mode	Mode 2. EUT 2 (with internal antenna) + Ant. 19 (Embedded antenna) / Radio 2 (2.4GHz + 5GHz band)		

Horizontal

	Freq	Level	Limit Line	Over Limit	Read Level	CableAntenna Loss	Antenna Factor	Preamplifier Factor	Remark	A/Pos	T/Pos	Pol/Phase
	MHz	dBuV/m	dBuV/m	dB	dBuV	dB	dB/m	dB		cm	deg	
1	4871.10	53.71	74.00	-20.29	49.12	6.31	33.48	35.20	Peak	100	220	HORIZONTAL
2	4871.50	40.32	54.00	-13.68	35.73	6.31	33.48	35.20	Average	100	220	HORIZONTAL
3	7301.10	53.83	74.00	-20.17	45.26	7.51	36.48	35.42	Peak	100	235	HORIZONTAL
4	7305.00	41.25	54.00	-12.75	32.68	7.51	36.48	35.42	Average	100	235	HORIZONTAL

Vertical

	Freq	Level	Limit Line	Over Limit	Read Level	CableAntenna Loss	Antenna Factor	Preamplifier Factor	Remark	A/Pos	T/Pos	Pol/Phase
	MHz	dBuV/m	dBuV/m	dB	dBuV	dB	dB/m	dB		cm	deg	
1	4871.20	59.81	74.00	-14.19	55.22	6.31	33.48	35.20	Peak	100	129	VERTICAL
2	4872.10	46.22	54.00	-7.78	41.63	6.31	33.48	35.20	Average	100	129	VERTICAL
3	7314.10	46.69	54.00	-7.31	38.07	7.54	36.51	35.43	Average	100	143	VERTICAL
4	7315.70	59.38	74.00	-14.62	50.76	7.54	36.51	35.43	Peak	100	143	VERTICAL

Temperature	26°C	Humidity	60%
Test Engineer	Jim Huang	Test Date	Dec. 27, 2012
Configurations	IEEE 802.11n MCS0 20MHz Ch 11 / Chain 1 + Chain 2		
Test Mode	Mode 2. EUT 2 (with internal antenna) + Ant. 19 (Embedded antenna) / Radio 2 (2.4GHz + 5GHz band)		

Horizontal

	Freq	Level	Limit Line	Over Limit	Read Level	CableAntenna Loss	Antenna Factor	Preamp Factor	Remark	A/Pos	T/Pos	Pol/Phase
	MHz	dBuV/m	dBuV/m	dB	dBuV	dB	dB/m	dB		cm	deg	
1	4920.68	47.17	74.00	-26.83	42.48	6.35	33.54	35.20	Peak	100	247	HORIZONTAL
2	4924.00	35.50	54.00	-18.50	30.77	6.35	33.58	35.20	Average	100	247	HORIZONTAL
3	7386.40	37.73	54.00	-16.27	28.97	7.61	36.61	35.46	Average	100	169	HORIZONTAL
4	7389.56	50.56	74.00	-23.44	41.77	7.64	36.61	35.46	Peak	100	169	HORIZONTAL

Vertical

	Freq	Level	Limit Line	Over Limit	Read Level	CableAntenna Loss	Antenna Factor	Preamp Factor	Remark	A/Pos	T/Pos	Pol/Phase
	MHz	dBuV/m	dBuV/m	dB	dBuV	dB	dB/m	dB		cm	deg	
1	4925.48	54.56	74.00	-19.44	49.83	6.35	33.58	35.20	Peak	100	135	VERTICAL
2	4926.56	40.60	54.00	-13.40	35.87	6.35	33.58	35.20	Average	100	135	VERTICAL
3	7383.48	40.00	54.00	-14.00	31.24	7.61	36.61	35.46	Average	100	143	VERTICAL
4	7384.16	53.55	74.00	-20.45	44.79	7.61	36.61	35.46	Peak	100	143	VERTICAL

Temperature	26°C	Humidity	60%
Test Engineer	Jim Huang	Test Date	Dec. 27, 2012
Configurations	IEEE 802.11n MCS0 40MHz Ch 3 / Chain 1 + Chain 2		
Test Mode	Mode 2. EUT 2 (with internal antenna) + Ant. 19 (Embedded antenna) / Radio 2 (2.4GHz + 5GHz band)		

Horizontal

	Freq	Level	Limit Line	Over Limit	Read Level	CableAntenna Loss	Antenna Factor	Preamp Factor	Remark	A/Pos	T/Pos	Pol/Phase
	MHz	dBuV/m	dBuV/m	dB	dBuV	dB	dB/m	dB		cm	deg	
1	4824.60	45.65	74.00	-28.35	41.19	6.27	33.39	35.20	Peak	100	258	HORIZONTAL
2	4840.00	33.67	54.00	-20.33	29.16	6.29	33.42	35.20	Average	100	258	HORIZONTAL

Vertical

	Freq	Level	Limit Line	Over Limit	Read Level	CableAntenna Loss	Antenna Factor	Preamp Factor	Remark	A/Pos	T/Pos	Pol/Phase
	MHz	dBuV/m	dBuV/m	dB	dBuV	dB	dB/m	dB		cm	deg	
1	4826.20	44.74	74.00	-29.26	40.28	6.27	33.39	35.20	Peak	100	110	VERTICAL
2	4830.60	32.61	54.00	-21.39	28.15	6.27	33.39	35.20	Average	100	110	VERTICAL

Temperature	26°C	Humidity	60%
Test Engineer	Jim Huang	Test Date	Dec. 27, 2012
Configurations	IEEE 802.11n MCS0 40MHz Ch 6 / Chain 1 + Chain 2		
Test Mode	Mode 2. EUT 2 (with internal antenna) + Ant. 19 (Embedded antenna) / Radio 2 (2.4GHz + 5GHz band)		

Horizontal

	Freq	Level	Limit	Over	Read	CableAntenna	Preamp	Remark	A/Pos	T/Pos	Pol/Phase	
	MHz	dBuV/m	dBuV/m	dB	dBuV	dB	dB/m	dB	cm	deg		
1	4869.40	33.95	54.00	-20.05	29.39	6.31	33.45	35.20	Average	100	218	HORIZONTAL
2	4871.90	46.19	74.00	-27.81	41.60	6.31	33.48	35.20	Peak	100	218	HORIZONTAL
3	7292.70	36.94	54.00	-17.06	28.37	7.51	36.48	35.42	Average	100	273	HORIZONTAL
4	7298.20	50.17	74.00	-23.83	41.60	7.51	36.48	35.42	Peak	100	273	HORIZONTAL

Vertical

	Freq	Level	Limit	Over	Read	CableAntenna	Preamp	Remark	A/Pos	T/Pos	Pol/Phase	
	MHz	dBuV/m	dBuV/m	dB	dBuV	dB	dB/m	dB	cm	deg		
1	4870.10	36.79	54.00	-17.21	32.23	6.31	33.45	35.20	Average	100	129	VERTICAL
2	4890.30	50.21	74.00	-23.79	45.57	6.33	33.51	35.20	Peak	100	129	VERTICAL
3	7316.80	49.86	74.00	-24.14	41.24	7.54	36.51	35.43	Peak	100	291	VERTICAL
4	7323.10	38.55	54.00	-15.45	29.93	7.54	36.51	35.43	Average	100	291	VERTICAL

Temperature	26°C	Humidity	60%
Test Engineer	Jim Huang	Test Date	Dec. 27, 2012
Configurations	IEEE 802.11n MCS0 40MHz Ch 9 / Chain 1 + Chain 2		
Test Mode	Mode 2. EUT 2 (with internal antenna) + Ant. 19 (Embedded antenna) / Radio 2 (2.4GHz + 5GHz band)		

Horizontal

	Freq	Level	Limit Line	Over Limit	Read Level	Cable Loss	Antenna Factor	Preamp Factor	Remark	A/Pos	T/Pos	Pol/Phase
	MHz	dBuV/m	dBuV/m	dB	dBuV	dB	dB/m	dB		cm	deg	
1	4924.00	35.04	54.00	-18.96	30.31	6.35	33.58	35.20	Average	100	99	HORIZONTAL
2	4924.80	45.18	74.00	-28.82	40.45	6.35	33.58	35.20	Peak	100	99	HORIZONTAL
3	7347.80	50.21	74.00	-23.79	41.52	7.57	36.56	35.44	Peak	100	339	HORIZONTAL
4	7367.30	37.13	54.00	-16.87	28.38	7.61	36.59	35.45	Average	100	339	HORIZONTAL

Vertical

	Freq	Level	Limit Line	Over Limit	Read Level	Cable Loss	Antenna Factor	Preamp Factor	Remark	A/Pos	T/Pos	Pol/Phase
	MHz	dBuV/m	dBuV/m	dB	dBuV	dB	dB/m	dB		cm	deg	
1	4913.40	33.66	54.00	-20.34	28.97	6.35	33.54	35.20	Average	100	201	VERTICAL
2	4926.10	45.41	74.00	-28.59	40.68	6.35	33.58	35.20	Peak	100	201	VERTICAL
3	7364.60	37.24	54.00	-16.76	28.49	7.61	36.59	35.45	Average	100	277	VERTICAL
4	7366.00	49.52	74.00	-24.48	40.77	7.61	36.59	35.45	Peak	100	277	VERTICAL

Temperature	26°C	Humidity	60%
Test Engineer	Jim Huang	Test Date	Dec. 28, 2012
Test Date	IEEE 802.11n MCS0 20MHz CH 149 / Chain 1 + Chain 2		
Test Mode	Mode 2. EUT 2 (with internal antenna) + Ant. 19 (Embedded antenna) / Radio 2 (2.4GHz + 5GHz band)		

Horizontal

	Freq	Level	Limit Line	Over Limit	Read Level	Cable Loss	Preamp Factor	Antenna Factor	Remark	T/Pos	A/Pos	Pol/Phase
	MHz	dBuV/m	dBuV/m	dB	dBuV	dB	dB	dB/m		deg	cm	
1 a	5360.02	46.74	54.00	-7.26	43.43	4.47	34.62	33.46	Average	301	100	HORIZONTAL
2	5360.04	53.02	74.00	-20.98	49.71	4.47	34.62	33.46	Peak	301	100	HORIZONTAL
3	11490.04	41.55	54.00	-12.45	31.13	6.74	34.82	38.50	Average	57	100	HORIZONTAL
4 p	11491.24	55.54	74.00	-18.46	45.12	6.74	34.82	38.50	Peak	57	100	HORIZONTAL

Vertical

	Freq	Level	Limit Line	Over Limit	Read Level	Cable Loss	Preamp Factor	Antenna Factor	Remark	T/Pos	A/Pos	Pol/Phase
	MHz	dBuV/m	dBuV/m	dB	dBuV	dB	dB	dB/m		deg	cm	
1 p	5359.83	60.79	74.00	-13.21	57.48	4.47	34.62	33.46	Peak	309	100	VERTICAL
2 a	5359.97	53.99	54.00	-0.01	50.68	4.47	34.62	33.46	Average	309	100	VERTICAL
3	11491.04	38.09	54.00	-15.91	27.67	6.74	34.82	38.50	Average	296	100	VERTICAL
4	11493.24	52.85	74.00	-21.15	42.43	6.74	34.82	38.50	Peak	296	100	VERTICAL

Temperature	26°C	Humidity	60%
Test Engineer	Jim Huang	Test Date	Dec. 28, 2012
Configurations	IEEE 802.11n MCS0 20MHz CH 157 / Chain 1 + Chain 2		
Test Mode	Mode 2. EUT 2 (with internal antenna) + Ant. 19 (Embedded antenna) / Radio 2 (2.4GHz + 5GHz band)		

Horizontal

	Freq	Level	Limit Line	Over Limit	Read Level	Cable Loss	Preamp Factor	Antenna Factor	Remark	T/Pos	A/Pos	Pol/Phase
	MHz	dBuV/m	dBuV/m	dB	dBuV	dB	dB	dB/m		deg	cm	
1	5359.84	52.94	74.00	-21.06	49.63	4.47	34.62	33.46	Peak	301	100	HORIZONTAL
2 a	5359.99	45.32	54.00	-8.68	42.01	4.47	34.62	33.46	Average	301	100	HORIZONTAL
3 p	11562.84	55.00	74.00	-19.00	44.57	6.77	34.84	38.50	Peak	67	139	HORIZONTAL
4	11564.72	39.68	54.00	-14.32	29.25	6.77	34.84	38.50	Average	67	139	HORIZONTAL

Vertical

	Freq	Level	Limit Line	Over Limit	Read Level	Cable Loss	Preamp Factor	Antenna Factor	Remark	T/Pos	A/Pos	Pol/Phase
	MHz	dBuV/m	dBuV/m	dB	dBuV	dB	dB	dB/m		deg	cm	
1 p	5359.90	60.71	74.00	-13.29	57.40	4.47	34.62	33.46	Peak	313	100	VERTICAL
2 a	5360.01	53.16	54.00	-0.84	49.85	4.47	34.62	33.46	Average	313	100	VERTICAL
3	11568.28	52.16	74.00	-21.84	41.73	6.77	34.84	38.50	Peak	70	100	VERTICAL
4	11569.56	38.07	54.00	-15.93	27.64	6.77	34.84	38.50	Average	70	100	VERTICAL

Temperature	26°C	Humidity	60%
Test Engineer	Jim Huang	Test Date	Dec. 28, 2012
Configurations	IEEE 802.11n MCS0 20MHz CH 165 / Chain 1 + Chain 2		
Test Mode	Mode 2. EUT 2 (with internal antenna) + Ant. 19 (Embedded antenna) / Radio 2 (2.4GHz + 5GHz band)		

Horizontal

	Freq	Level	Limit Line	Over Limit	Read Level	Cable Loss	Preamp Factor	Antenna Factor	Remark	T/Pos	A/Pos	Pol/Phase
	MHz	dBuV/m	dBuV/m	dB	dBuV	dB	dB	dB/m		deg	cm	
1 a	5359.94	45.57	54.00	-8.43	42.26	4.47	34.62	33.46	Average	301	100	HORIZONTAL
2	5360.13	53.33	74.00	-20.67	50.02	4.47	34.62	33.46	Peak	301	100	HORIZONTAL
3 p	11653.84	59.83	74.00	-14.17	49.40	6.80	34.87	38.50	Peak	68	106	HORIZONTAL
4	11654.56	44.68	54.00	-9.32	34.25	6.80	34.87	38.50	Average	68	106	HORIZONTAL

Vertical

	Freq	Level	Limit Line	Over Limit	Read Level	Cable Loss	Preamp Factor	Antenna Factor	Remark	T/Pos	A/Pos	Pol/Phase
	MHz	dBuV/m	dBuV/m	dB	dBuV	dB	dB	dB/m		deg	cm	
1 a	5359.98	53.44	54.00	-0.56	50.13	4.47	34.62	33.46	Average	309	100	VERTICAL
2 p	5360.03	60.51	74.00	-13.49	57.20	4.47	34.62	33.46	Peak	309	100	VERTICAL
3	11652.24	53.45	74.00	-20.55	43.02	6.80	34.87	38.50	Peak	28	100	VERTICAL
4	11653.12	38.81	54.00	-15.19	28.38	6.80	34.87	38.50	Average	28	100	VERTICAL

Temperature	26°C	Humidity	60%
Test Engineer	Jim Huang	Test Date	Dec. 28, 2012
Configurations	IEEE 802.11n MCS0 40MHz CH 151 / Chain 1 + Chain 2		
Test Mode	Mode 2. EUT 2 (with internal antenna) + Ant. 19 (Embedded antenna) / Radio 2 (2.4GHz + 5GHz band)		

Horizontal

	Freq	Level	Limit Line	Over Limit	Read Level	Cable Loss	Preamp Factor	Antenna Factor	Remark	T/Pos	A/Pos	Pol/Phase
	MHz	dBuV/m	dBuV/m	dB	dBuV	dB	dB	dB/m		deg	cm	
1 a	5359.99	53.23	54.00	-0.77	49.92	4.47	34.62	33.46	Average	314	100	HORIZONTAL
2 p	5360.01	60.54	74.00	-13.46	57.23	4.47	34.62	33.46	Peak	314	100	HORIZONTAL
3	11510.70	45.04	54.00	-8.96	34.61	6.75	34.82	38.50	Average	68	102	HORIZONTAL
4	11511.40	59.38	74.00	-14.62	48.95	6.75	34.82	38.50	Peak	68	102	HORIZONTAL

Vertical

	Freq	Level	Limit Line	Over Limit	Read Level	Cable Loss	Preamp Factor	Antenna Factor	Remark	T/Pos	A/Pos	Pol/Phase
	MHz	dBuV/m	dBuV/m	dB	dBuV	dB	dB	dB/m		deg	cm	
1 p	5359.90	62.81	74.00	-11.19	59.50	4.47	34.62	33.46	Peak	314	100	VERTICAL
2 a	5360.01	53.09	54.00	-0.91	49.78	4.47	34.62	33.46	Average	314	100	VERTICAL
3	11510.60	43.23	54.00	-10.77	32.80	6.75	34.82	38.50	Average	71	112	VERTICAL
4	11511.10	56.20	74.00	-17.80	45.77	6.75	34.82	38.50	Peak	71	112	VERTICAL

Temperature	26°C	Humidity	60%
Test Engineer	Jim Huang	Test Date	Dec. 28, 2012
Configurations	IEEE 802.11n MCS0 40MHz CH 159 / Chain 1 + Chain 2		
Test Mode	Mode 2. EUT 2 (with internal antenna) + Ant. 19 (Embedded antenna) / Radio 2 (2.4GHz + 5GHz band)		

Horizontal

	Freq	Level	Limit Line	Over Limit	Read Level	Cable Loss	Preamp Factor	Antenna Factor	Remark	T/Pos	A/Pos	Pol/Phase
	MHz	dBuV/m	dBuV/m	dB	dBuV	dB	dB	dB/m		deg	cm	
1 a	5359.97	46.73	54.00	-7.27	43.42	4.47	34.62	33.46	Average	302	100	HORIZONTAL
2	5360.09	53.76	74.00	-20.24	50.45	4.47	34.62	33.46	Peak	302	100	HORIZONTAL
3 p	11598.40	55.60	74.00	-18.40	45.17	6.78	34.85	38.50	Peak	64	105	HORIZONTAL
4	11600.00	42.17	54.00	-11.83	31.73	6.79	34.85	38.50	Average	64	105	HORIZONTAL

Vertical

	Freq	Level	Limit Line	Over Limit	Read Level	Cable Loss	Preamp Factor	Antenna Factor	Remark	T/Pos	A/Pos	Pol/Phase
	MHz	dBuV/m	dBuV/m	dB	dBuV	dB	dB	dB/m		deg	cm	
1 p	5359.82	61.23	74.00	-12.77	57.92	4.47	34.62	33.46	Peak	313	100	VERTICAL
2 a	5359.99	53.87	54.00	-0.13	50.56	4.47	34.62	33.46	Average	313	100	VERTICAL
3	11596.80	38.12	54.00	-15.88	27.69	6.78	34.85	38.50	Average	28	100	VERTICAL
4	11599.60	51.07	74.00	-22.93	40.63	6.79	34.85	38.50	Peak	28	100	VERTICAL

Temperature	26°C	Humidity	60%
Test Engineer	Jim Huang	Test Date	Dec. 27, 2012
Configurations	IEEE 802.11b CH 1 / Chain 1		
Test Mode	Mode 2. EUT 2 (with internal antenna) + Ant. 19 (Embedded antenna) / Radio 2 (2.4GHz + 5GHz band)		

Horizontal

	Freq	Level	Limit Line	Over Limit	Read Level	CableAntenna Loss	Antenna Factor	Preamp Factor	Remark	A/Pos	T/Pos	Pol/Phase
	MHz	dBuV/m	dBuV/m	dB	dBuV	dB	dB/m	dB		cm	deg	
1	4823.91	49.98	74.00	-24.02	45.52	6.27	33.39	35.20	Peak	113	223	HORIZONTAL
2	4823.97	44.76	54.00	-9.24	40.30	6.27	33.39	35.20	Average	113	223	HORIZONTAL

Vertical

	Freq	Level	Limit Line	Over Limit	Read Level	CableAntenna Loss	Antenna Factor	Preamp Factor	Remark	A/Pos	T/Pos	Pol/Phase
	MHz	dBuV/m	dBuV/m	dB	dBuV	dB	dB/m	dB		cm	deg	
1	4823.92	56.15	74.00	-17.85	51.69	6.27	33.39	35.20	Peak	109	174	VERTICAL
2	4823.97	53.62	54.00	-0.38	49.16	6.27	33.39	35.20	Average	109	174	VERTICAL

Temperature	26°C	Humidity	60%
Test Engineer	Jim Huang	Test Date	Dec. 27, 2012
Configurations	IEEE 802.11b CH 6 / Chain 1		
Test Mode	Mode 2. EUT 2 (with internal antenna) + Ant. 19 (Embedded antenna) / Radio 2 (2.4GHz + 5GHz band)		

Horizontal

	Freq	Level	Limit Line	Over Limit	Read Level	Cable Loss	Antenna Factor	Preamp Factor	Remark	A/Pos	T/Pos	Pol/Phase
	MHz	dBuV/m	dBuV/m	dB	dBuV	dB	dB/m	dB		cm	deg	
1	4873.97	52.59	54.00	-1.41	48.00	6.31	33.48	35.20	Average	133	215	HORIZONTAL
2	4874.04	55.42	74.00	-18.58	50.83	6.31	33.48	35.20	Peak	133	215	HORIZONTAL
3	7311.71	43.79	54.00	-10.21	35.20	7.51	36.51	35.43	Average	116	188	HORIZONTAL
4	7312.98	53.35	74.00	-20.65	44.73	7.54	36.51	35.43	Peak	116	188	HORIZONTAL

Vertical

	Freq	Level	Limit Line	Over Limit	Read Level	Cable Loss	Antenna Factor	Preamp Factor	Remark	A/Pos	T/Pos	Pol/Phase
	MHz	dBuV/m	dBuV/m	dB	dBuV	dB	dB/m	dB		cm	deg	
1	4873.97	53.70	54.00	-0.30	49.11	6.31	33.48	35.20	Average	113	127	VERTICAL
2	4874.00	55.93	74.00	-18.07	51.34	6.31	33.48	35.20	Peak	113	127	VERTICAL
3	7311.66	55.81	74.00	-18.19	47.22	7.51	36.51	35.43	Peak	100	143	VERTICAL
4	7311.70	48.71	54.00	-5.29	40.12	7.51	36.51	35.43	Average	100	143	VERTICAL

Temperature	26°C	Humidity	60%
Test Engineer	Jim Huang	Test Date	Dec. 27, 2012
Configurations	IEEE 802.11b CH 11 / Chain 1		
Test Mode	Mode 2. EUT 2 (with internal antenna) + Ant. 19 (Embedded antenna) / Radio 2 (2.4GHz + 5GHz band)		

Horizontal

	Freq	Level	Limit Line	Over Limit	Read Level	Cable Loss	Antenna Factor	Preamp Factor	Remark	A/Pos	T/Pos	Pol/Phase
	MHz	dBuV/m	dBuV/m	dB	dBuV	dB	dB/m	dB		cm	deg	
1	4923.91	54.79	74.00	-19.21	50.06	6.35	33.58	35.20	Peak	131	214	HORIZONTAL
2	4923.97	51.69	54.00	-2.31	46.96	6.35	33.58	35.20	Average	131	214	HORIZONTAL
3	7385.12	39.34	54.00	-14.66	30.58	7.61	36.61	35.46	Average	100	215	HORIZONTAL
4	7385.43	50.93	74.00	-23.07	42.17	7.61	36.61	35.46	Peak	100	215	HORIZONTAL

Vertical

	Freq	Level	Limit Line	Over Limit	Read Level	Cable Loss	Antenna Factor	Preamp Factor	Remark	A/Pos	T/Pos	Pol/Phase
	MHz	dBuV/m	dBuV/m	dB	dBuV	dB	dB/m	dB		cm	deg	
1	4923.92	56.01	74.00	-17.99	51.28	6.35	33.58	35.20	Peak	100	132	VERTICAL
2	4923.97	53.22	54.00	-0.78	48.49	6.35	33.58	35.20	Average	100	132	VERTICAL
3	7384.49	53.98	74.00	-20.02	45.22	7.61	36.61	35.46	Peak	100	144	VERTICAL
4	7385.21	45.40	54.00	-8.60	36.64	7.61	36.61	35.46	Average	100	144	VERTICAL

Temperature	26°C	Humidity	60%
Test Engineer	Jim Huang	Test Date	Dec. 27, 2012
Configurations	IEEE 802.11g CH 1 / Chain 1 + Chain 2		
Test Mode	Mode 2. EUT 2 (with internal antenna) + Ant. 19 (Embedded antenna) / Radio 2 (2.4GHz + 5GHz band)		

Horizontal

	Freq	Level	Limit Line	Over Limit	Read Level	CableAntenna Loss	Antenna Factor	Preamp Factor	Remark	A/Pos	T/Pos	Pol/Phase
	MHz	dBuV/m	dBuV/m	dB	dBuV	dB	dB/m	dB		cm	deg	
1	4822.12	45.09	74.00	-28.91	40.63	6.27	33.39	35.20	Peak	100	164	HORIZONTAL
2	4827.52	33.60	54.00	-20.40	29.14	6.27	33.39	35.20	Average	100	164	HORIZONTAL

Vertical

	Freq	Level	Limit Line	Over Limit	Read Level	CableAntenna Loss	Antenna Factor	Preamp Factor	Remark	A/Pos	T/Pos	Pol/Phase
	MHz	dBuV/m	dBuV/m	dB	dBuV	dB	dB/m	dB		cm	deg	
1	4824.12	48.89	74.00	-25.11	44.43	6.27	33.39	35.20	Peak	100	171	VERTICAL
2	4826.00	36.09	54.00	-17.91	31.63	6.27	33.39	35.20	Average	100	171	VERTICAL

Temperature	26°C	Humidity	60%
Test Engineer	Jim Huang	Test Date	Dec. 27, 2012
Configurations	IEEE 802.11g CH 6 / Chain 1 + Chain 2		
Test Mode	Mode 2. EUT 2 (with internal antenna) + Ant. 19 (Embedded antenna) / Radio 2 (2.4GHz + 5GHz band)		

Horizontal

	Freq	Level	Limit Line	Over Limit	Read Level	CableAntenna Loss	Antenna Factor	Preamp Factor	Remark	A/Pos	T/Pos	Pol/Phase
	MHz	dBuV/m	dBuV/m	dB	dBuV	dB	dB/m	dB		cm	deg	
1	4872.12	53.33	74.00	-20.67	48.74	6.31	33.48	35.20	Peak	100	220	HORIZONTAL
2	4872.64	40.26	54.00	-13.74	35.67	6.31	33.48	35.20	Average	100	220	HORIZONTAL
3	7305.60	52.03	74.00	-21.97	43.46	7.51	36.48	35.42	Peak	100	173	HORIZONTAL
4	7310.52	39.78	54.00	-14.22	31.19	7.51	36.51	35.43	Average	100	173	HORIZONTAL

Vertical

	Freq	Level	Limit Line	Over Limit	Read Level	CableAntenna Loss	Antenna Factor	Preamp Factor	Remark	A/Pos	T/Pos	Pol/Phase
	MHz	dBuV/m	dBuV/m	dB	dBuV	dB	dB/m	dB		cm	deg	
1	4872.80	59.06	74.00	-14.94	54.47	6.31	33.48	35.20	Peak	100	129	VERTICAL
2	4873.40	46.12	54.00	-7.88	41.53	6.31	33.48	35.20	Average	100	129	VERTICAL
3	7313.40	60.20	74.00	-13.80	51.58	7.54	36.51	35.43	Peak	100	143	VERTICAL
4	7314.12	46.96	54.00	-7.04	38.34	7.54	36.51	35.43	Average	100	143	VERTICAL

Temperature	26°C	Humidity	60%
Test Engineer	Jim Huang	Test Date	Dec. 27, 2012
Configurations	IEEE 802.11g CH 11 / Chain 1 + Chain 2		
Test Mode	Mode 2. EUT 2 (with internal antenna) + Ant. 19 (Embedded antenna) / Radio 2 (2.4GHz + 5GHz band)		

Horizontal

	Freq	Level	Limit Line	Over Limit	Read Level	CableAntenna Loss	Antenna Factor	Preamp Factor	Remark	A/Pos	T/Pos	Pol/Phase
	MHz	dBuV/m	dBuV/m	dB	dBuV	dB	dB/m	dB		cm	deg	
1	4923.60	48.12	74.00	-25.88	43.39	6.35	33.58	35.20	Peak	100	97	HORIZONTAL
2	4924.16	35.83	54.00	-18.17	31.10	6.35	33.58	35.20	Average	100	97	HORIZONTAL
3	7384.00	51.04	74.00	-22.96	42.28	7.61	36.61	35.46	Peak	100	218	HORIZONTAL
4	7384.60	38.08	54.00	-15.92	29.32	7.61	36.61	35.46	Average	100	218	HORIZONTAL

Vertical

	Freq	Level	Limit Line	Over Limit	Read Level	CableAntenna Loss	Antenna Factor	Preamp Factor	Remark	A/Pos	T/Pos	Pol/Phase
	MHz	dBuV/m	dBuV/m	dB	dBuV	dB	dB/m	dB		cm	deg	
1	4925.00	41.51	54.00	-12.49	36.78	6.35	33.58	35.20	Average	100	133	VERTICAL
2	4929.60	54.30	74.00	-19.70	49.57	6.35	33.58	35.20	Peak	100	133	VERTICAL
3	7382.16	41.78	54.00	-12.22	33.01	7.61	36.61	35.45	Average	100	145	VERTICAL
4	7386.60	56.75	74.00	-17.25	47.99	7.61	36.61	35.46	Peak	100	145	VERTICAL

Temperature	26°C	Humidity	60%
Test Engineer	Jim Huang	Test Date	Dec. 28, 2012
Configurations	IEEE 802.11a CH 149 / Chain 1 + Chain 2		
Test Mode	Mode 2. EUT 2 (with internal antenna) + Ant. 19 (Embedded antenna) / Radio 2 (2.4GHz + 5GHz band)		

Horizontal

	Freq	Level	Limit Line	Over Limit	Read Level	Cable Loss	Preamp Factor	Antenna Factor	Remark	T/Pos	A/Pos	Pol/Phase
	MHz	dBuV/m	dBuV/m	dB	dBuV	dB	dB	dB/m		deg	cm	
1	5360.01	46.24	54.00	-7.76	42.93	4.47	34.62	33.46	Average	302	100	HORIZONTAL
2	5360.02	54.16	74.00	-19.84	50.85	4.47	34.62	33.46	Peak	302	100	HORIZONTAL
3 p	11489.64	64.76	74.00	-9.24	54.34	6.74	34.82	38.50	Peak	59	100	HORIZONTAL
4 a	11489.96	49.00	54.00	-5.00	38.58	6.74	34.82	38.50	Average	59	100	HORIZONTAL

Vertical

	Freq	Level	Limit Line	Over Limit	Read Level	Cable Loss	Preamp Factor	Antenna Factor	Remark	T/Pos	A/Pos	Pol/Phase
	MHz	dBuV/m	dBuV/m	dB	dBuV	dB	dB	dB/m		deg	cm	
1 p	5359.84	61.66	74.00	-12.34	58.35	4.47	34.62	33.46	Peak	312	100	VERTICAL
2 a	5359.99	53.66	54.00	-0.34	50.35	4.47	34.62	33.46	Average	312	100	VERTICAL
3	11485.64	54.55	74.00	-19.45	44.13	6.74	34.82	38.50	Peak	296	100	VERTICAL
4	11491.04	40.12	54.00	-13.88	29.70	6.74	34.82	38.50	Average	296	100	VERTICAL

Temperature	26°C	Humidity	60%
Test Engineer	Jim Huang	Test Date	Dec. 28, 2012
Configurations	IEEE 802.11a CH 157 / Chain 1 + Chain 2		
Test Mode	Mode 2. EUT 2 (with internal antenna) + Ant. 19 (Embedded antenna) / Radio 2 (2.4GHz + 5GHz band)		

Horizontal

	Freq	Level	Limit Line	Over Limit	Read Level	Cable Loss	Preamp Factor	Antenna Factor	Remark	T/Pos	A/Pos	Pol/Phase
	MHz	dBuV/m	dBuV/m	dB	dBuV	dB	dB	dB/m		deg	cm	
1	5359.91	52.96	74.00	-21.04	49.65	4.47	34.62	33.46	Peak	302	100	HORIZONTAL
2 a	5360.00	45.72	54.00	-8.28	42.41	4.47	34.62	33.46	Average	302	100	HORIZONTAL
3	11568.32	43.34	54.00	-10.66	32.91	6.77	34.84	38.50	Average	68	140	HORIZONTAL
4 p	11573.56	57.41	74.00	-16.59	46.99	6.77	34.85	38.50	Peak	68	140	HORIZONTAL

Vertical

	Freq	Level	Limit Line	Over Limit	Read Level	Cable Loss	Preamp Factor	Antenna Factor	Remark	T/Pos	A/Pos	Pol/Phase
	MHz	dBuV/m	dBuV/m	dB	dBuV	dB	dB	dB/m		deg	cm	
1 a	5359.97	53.49	54.00	-0.51	50.18	4.47	34.62	33.46	Average	309	100	VERTICAL
2 p	5360.04	60.02	74.00	-13.98	56.71	4.47	34.62	33.46	Peak	309	100	VERTICAL
3	11569.52	39.10	54.00	-14.90	28.67	6.77	34.84	38.50	Average	70	100	VERTICAL
4	11569.84	53.06	74.00	-20.94	42.64	6.77	34.85	38.50	Peak	70	100	VERTICAL

Temperature	26°C	Humidity	60%
Test Engineer	Jim Huang	Test Date	Dec. 28, 2012
Configurations	IEEE 802.11a CH 165 / Chain 1 + Chain 2		
Test Mode	Mode 2. EUT 2 (with internal antenna) + Ant. 19 (Embedded antenna) / Radio 2 (2.4GHz + 5GHz band)		

Horizontal

	Freq	Level	Limit Line	Over Limit	Read Level	Cable Loss	Preamp Factor	Antenna Factor	Remark	T/Pos	A/Pos	Pol/Phase
	MHz	dBuV/m	dBuV/m	dB	dBuV	dB	dB	dB/m		deg	cm	
1	5359.99	46.30	54.00	-7.70	42.99	4.47	34.62	33.46	Average	303	100	HORIZONTAL
2	5360.01	54.18	74.00	-19.82	50.87	4.47	34.62	33.46	Peak	303	100	HORIZONTAL
3 a	11651.80	46.96	54.00	-7.04	36.53	6.80	34.87	38.50	Average	67	143	HORIZONTAL
4 p	11652.12	61.77	74.00	-12.23	51.34	6.80	34.87	38.50	Peak	67	143	HORIZONTAL

Vertical

	Freq	Level	Limit Line	Over Limit	Read Level	Cable Loss	Preamp Factor	Antenna Factor	Remark	T/Pos	A/Pos	Pol/Phase
	MHz	dBuV/m	dBuV/m	dB	dBuV	dB	dB	dB/m		deg	cm	
1 p	5359.89	60.50	74.00	-13.50	57.19	4.47	34.62	33.46	Peak	310	100	VERTICAL
2 a	5359.96	53.83	54.00	-0.17	50.52	4.47	34.62	33.46	Average	310	100	VERTICAL
3	11651.16	41.99	54.00	-12.01	31.56	6.80	34.87	38.50	Average	28	100	VERTICAL
4	11651.56	56.59	74.00	-17.41	46.16	6.80	34.87	38.50	Peak	28	100	VERTICAL

Note:

The amplitude of spurious emissions that are attenuated by more than 20dB below the permissible value has no need to be reported.

Emission level (dBuV/m) = 20 log Emission level (uV/m).

Corrected Reading: Antenna Factor + Cable Loss + Read Level - Preamp Factor = Level.

4.6. Band Edge Emissions Measurement

4.6.1. Limit

30dBc in any 100 kHz bandwidth outside the operating frequency band. In case the emission fall within the restricted band specified on 15.205(a), then the 15.209(a) limit in the table below has to be followed.

Frequencies (MHz)	Field Strength (micovolts/meter)	Measurement Distance (meters)
0.009~0.490	2400/F(KHz)	300
0.490~1.705	24000/F(KHz)	30
1.705~30.0	30	30
30~88	100	3
88~216	150	3
216~960	200	3
Above 960	500	3

4.6.2. Measuring Instruments and Setting

Please refer to section 5 of equipments list in this report. The following table is the setting of the spectrum analyzer.

Spectrum Parameter	Setting
Attenuation	Auto
Span Frequency	100 MHz
RB / VB (Emission in restricted band)	1 MHz / 3MHz for Peak, 1 MHz / 10Hz for Average
RB / VB (Emission in non-restricted band)	100 KHz / 300 KHz for Peak

4.6.3. Test Procedures

- The test procedure is the same as section 4.5.3, only the frequency range investigated is limited to 100MHz around bandedges.

4.6.4. Test Setup Layout

This test setup layout is the same as that shown in section 4.5.4.

4.6.5. Test Deviation

There is no deviation with the original standard.

4.6.6. EUT Operation during Test

The EUT was programmed to be in continuously transmitting mode.

4.6.7. Test Result of Band Edge and Fundamental Emissions

Temperature	26°C	Humidity	60%
Test Engineer	Jim Huang	Test Date	Dec. 26, 2012 ~ Dec. 27, 2012
Configurations	IEEE 802.11n MCS0 20MHz Ch 1, 6, 11 / Chain 1 + Chain 2		
Test Mode	Mode 1. EUT 2 (with internal antenna) + Ant. 18 (Embedded antenna) / Radio 1 (2.4GHz band)		

Channel 1

	Freq	Level	Limit Line	Over Limit	Read Level	CableAntenna Loss	Antenna Factor	Preamp Factor	Remark	A/Pos	T/Pos	Pol/Phase
	MHz	dBuV/m	dBuV/m	dB	dBuV	dB	dB/m	dB		cm	deg	
1	2390.00	53.37	54.00	-0.63	20.98	4.34	28.05	0.00	Average	147	184	VERTICAL
2	2390.00	72.27	74.00	-1.73	39.88	4.34	28.05	0.00	Peak	147	184	VERTICAL
3	2418.20	113.86			81.37	4.36	28.13	0.00	Peak	147	184	VERTICAL
4	2418.80	104.29			71.80	4.36	28.13	0.00	Average	147	184	VERTICAL

Item 3, 4 are the fundamental frequency at 2412 MHz.

Channel 6

	Freq	Level	Limit Line	Over Limit	Read Level	CableAntenna Loss	Antenna Factor	Preamp Factor	Remark	A/Pos	T/Pos	Pol/Phase
	MHz	dBuV/m	dBuV/m	dB	dBuV	dB	dB/m	dB		cm	deg	
1	2388.40	70.88	74.00	-3.12	38.49	4.34	28.05	0.00	Peak	129	177	VERTICAL
2	2390.00	53.85	54.00	-0.15	21.46	4.34	28.05	0.00	Average	129	177	VERTICAL
3	2430.60	122.33			89.84	4.36	28.13	0.00	Peak	129	177	VERTICAL
4	2431.40	112.12			79.63	4.36	28.13	0.00	Average	129	177	VERTICAL
5	2483.50	53.41	54.00	-0.59	20.75	4.40	28.26	0.00	Average	129	177	VERTICAL
6	2483.50	71.23	74.00	-2.77	38.57	4.40	28.26	0.00	Peak	129	177	VERTICAL

Item 3, 4 are the fundamental frequency at 2437MHz.

Channel 11

	Freq	Level	Limit Line	Over Limit	Read Level	CableAntenna Loss	Antenna Factor	Preamp Factor	Remark	A/Pos	T/Pos	Pol/Phase
	MHz	dBuV/m	dBuV/m	dB	dBuV	dB	dB/m	dB		cm	deg	
1	2458.60	103.41			70.81	4.38	28.22	0.00	Average	152	159	VERTICAL
2	2460.80	113.09			80.49	4.38	28.22	0.00	Peak	152	159	VERTICAL
3	2483.50	53.68	54.00	-0.32	21.02	4.40	28.26	0.00	Average	152	159	VERTICAL
4	2484.30	68.73	74.00	-5.27	36.07	4.40	28.26	0.00	Peak	152	159	VERTICAL

Item 1, 2 are the fundamental frequency at 2462 MHz.

Temperature	26°C	Humidity	60%
Test Engineer	Jim Huang	Test Date	Dec. 27, 2012
Configurations	IEEE 802.11n MCS0 40MHz Ch 3, 6, 9 / Chain 1 + Chain 2		
Test Mode	Mode 1. EUT 2 (with internal antenna) + Ant. 18 (Embedded antenna) / Radio 1 (2.4GHz band)		

Channel 3

	Freq	Level	Limit Line	Over Limit	Read Level	CableAntenna Loss	Antenna Factor	Preamp Factor	Remark	A/Pos	T/Pos	Pol/Phase
	MHz	dBuV/m	dBuV/m	dB	dBuV	dB	dB/m	dB		cm	deg	
1	2390.00	53.68	54.00	-0.32	21.29	4.34	28.05	0.00	Average	149	177	VERTICAL
2	2390.00	69.35	74.00	-4.65	36.96	4.34	28.05	0.00	Peak	149	177	VERTICAL
3	2408.80	109.64			77.21	4.34	28.09	0.00	Peak	149	177	VERTICAL
4	2411.20	99.32			66.89	4.34	28.09	0.00	Average	149	177	VERTICAL

Item 3, 4 are the fundamental frequency at 2422 MHz.

Channel 6

	Freq	Level	Limit Line	Over Limit	Read Level	CableAntenna Loss	Antenna Factor	Preamp Factor	Remark	A/Pos	T/Pos	Pol/Phase
	MHz	dBuV/m	dBuV/m	dB	dBuV	dB	dB/m	dB		cm	deg	
1	2390.00	53.59	54.00	-0.41	21.20	4.34	28.05	0.00	Average	156	170	VERTICAL
2	2390.00	68.50	74.00	-5.50	36.11	4.34	28.05	0.00	Peak	156	170	VERTICAL
3	2420.60	114.18			81.69	4.36	28.13	0.00	Peak	156	170	VERTICAL
4	2422.20	103.77			71.28	4.36	28.13	0.00	Average	156	170	VERTICAL
5	2483.50	51.05	54.00	-2.95	18.39	4.40	28.26	0.00	Average	156	170	VERTICAL
6	2483.90	65.48	74.00	-8.52	32.82	4.40	28.26	0.00	Peak	156	170	VERTICAL

Item 3, 4 are the fundamental frequency at 2437MHz.

Channel 9

	Freq	Level	Limit Line	Over Limit	Read Level	CableAntenna Loss	Antenna Factor	Preamp Factor	Remark	A/Pos	T/Pos	Pol/Phase
	MHz	dBuV/m	dBuV/m	dB	dBuV	dB	dB/m	dB		cm	deg	
1	2454.00	96.88			64.28	4.38	28.22	0.00	Average	153	167	VERTICAL
2	2455.60	107.15			74.55	4.38	28.22	0.00	Peak	153	167	VERTICAL
3	2483.50	53.24	54.00	-0.76	20.58	4.40	28.26	0.00	Average	153	167	VERTICAL
4	2483.50	69.21	74.00	-4.79	36.55	4.40	28.26	0.00	Peak	153	167	VERTICAL

Item 1, 2 are the fundamental frequency at 2452 MHz.

Note:

Emission level (dBuV/m) = 20 log Emission level (uV/m).

Corrected Reading: Antenna Factor + Cable Loss + Read Level - Preamp Factor = Level.

Temperature	26°C	Humidity	60%
Test Engineer	Jim Huang	Test Date	Dec. 25, 2012
Configurations	IEEE 802.11b CH 1, 6, 11 / Chain 2		
Test Mode	Mode 1. EUT 2 (with internal antenna) + Ant. 18 (Embedded antenna) / Radio 1 (2.4GHz band)		

Channel 1

	Freq	Level	Limit Line	Over Limit	Read Level	CableAntenna Loss	Antenna Factor	Preamp Factor	Remark	A/Pos	T/Pos	Pol/Phase
	MHz	dBuV/m	dBuV/m	dB	dBuV	dB	dB/m	dB		cm	deg	
1	2385.99	51.62	54.00	-2.38	19.25	4.32	28.05	0.00	Average	147	174	VERTICAL
2	2386.31	62.44	74.00	-11.56	30.07	4.32	28.05	0.00	Peak	147	174	VERTICAL
3	2412.96	114.55			82.10	4.36	28.09	0.00	Peak	147	174	VERTICAL
4	2413.76	110.97			78.52	4.36	28.09	0.00	Average	147	174	VERTICAL

Item 3, 4 are the fundamental frequency at 2412 MHz.

Channel 6

	Freq	Level	Limit Line	Over Limit	Read Level	CableAntenna Loss	Antenna Factor	Preamp Factor	Remark	A/Pos	T/Pos	Pol/Phase
	MHz	dBuV/m	dBuV/m	dB	dBuV	dB	dB/m	dB		cm	deg	
1	2389.04	62.63	74.00	-11.37	30.24	4.34	28.05	0.00	Peak	173	171	VERTICAL
2	2390.00	51.21	54.00	-2.79	18.82	4.34	28.05	0.00	Average	173	171	VERTICAL
3	2437.96	118.78			86.22	4.38	28.18	0.00	Peak	173	171	VERTICAL
4	2438.76	115.06			82.50	4.38	28.18	0.00	Average	173	171	VERTICAL
5	2484.14	49.74	54.00	-4.26	17.08	4.40	28.26	0.00	Average	173	171	VERTICAL
6	2485.10	62.49	74.00	-11.51	29.79	4.40	28.30	0.00	Peak	173	171	VERTICAL

Item 3, 4 are the fundamental frequency at 2437 MHz.

Channel 11

	Freq	Level	Limit Line	Over Limit	Read Level	CableAntenna Loss	Antenna Factor	Preamp Factor	Remark	A/Pos	T/Pos	Pol/Phase
	MHz	dBuV/m	dBuV/m	dB	dBuV	dB	dB/m	dB		cm	deg	
1	2460.24	112.02			79.42	4.38	28.22	0.00	Average	168	170	VERTICAL
2	2461.04	115.65			83.05	4.38	28.22	0.00	Peak	168	170	VERTICAL
3	2483.50	52.21	54.00	-1.79	19.55	4.40	28.26	0.00	Average	168	170	VERTICAL
4	2483.50	63.67	74.00	-10.33	31.01	4.40	28.26	0.00	Peak	168	170	VERTICAL

Item 1, 2 are the fundamental frequency at 2462 MHz.

Temperature	26°C	Humidity	60%
Test Engineer	Jim Huang	Test Date	Dec. 26, 2012
Configurations	IEEE 802.11g CH 1, 6, 11 / Chain 1 + Chain 2		
Test Mode	Mode 1. EUT 2 (with internal antenna) + Ant. 18 (Embedded antenna) / Radio 1 (2.4GHz band)		

Channel 1

	Freq	Level	Limit Line	Over Limit	Read Level	CableAntenna Loss	Antenna Factor	Preamp Factor	Remark	A/Pos	T/Pos	Pol/Phase
	MHz	dBuV/m	dBuV/m	dB	dBuV	dB	dB/m	dB		cm	deg	
1	2390.00	51.87	54.00	-2.13	19.48	4.34	28.05	0.00	Average	132	158	VERTICAL
2	2390.00	67.04	74.00	-6.96	34.65	4.34	28.05	0.00	Peak	132	158	VERTICAL
3	2418.60	114.77			82.28	4.36	28.13	0.00	Peak	132	158	VERTICAL
4	2418.80	105.21			72.72	4.36	28.13	0.00	Average	132	158	VERTICAL

Item 3, 4 are the fundamental frequency at 2412 MHz.

Channel 6

	Freq	Level	Limit Line	Over Limit	Read Level	CableAntenna Loss	Antenna Factor	Preamp Factor	Remark	A/Pos	T/Pos	Pol/Phase
	MHz	dBuV/m	dBuV/m	dB	dBuV	dB	dB/m	dB		cm	deg	
1	2387.60	53.29	54.00	-0.71	20.90	4.34	28.05	0.00	Average	154	164	VERTICAL
2	2387.60	69.78	74.00	-4.22	37.39	4.34	28.05	0.00	Peak	154	164	VERTICAL
3	2434.60	112.87			80.33	4.36	28.18	0.00	Average	154	164	VERTICAL
4	2434.60	122.67			90.13	4.36	28.18	0.00	Peak	154	164	VERTICAL
5	2483.50	51.77	54.00	-2.23	19.11	4.40	28.26	0.00	Average	154	164	VERTICAL
6	2483.50	64.66	74.00	-9.34	32.00	4.40	28.26	0.00	Peak	154	164	VERTICAL

Item 3, 4 are the fundamental frequency at 2437 MHz.

Channel 11

	Freq	Level	Limit Line	Over Limit	Read Level	CableAntenna Loss	Antenna Factor	Preamp Factor	Remark	A/Pos	T/Pos	Pol/Phase
	MHz	dBuV/m	dBuV/m	dB	dBuV	dB	dB/m	dB		cm	deg	
1	2464.80	115.82			83.20	4.40	28.22	0.00	Peak	154	172	VERTICAL
2	2465.00	105.95			73.33	4.40	28.22	0.00	Average	154	172	VERTICAL
3	2483.50	52.99	54.00	-1.01	20.33	4.40	28.26	0.00	Average	154	172	VERTICAL
4	2483.50	70.43	74.00	-3.57	37.77	4.40	28.26	0.00	Peak	154	172	VERTICAL

Item 1, 2 are the fundamental frequency at 2462 MHz.

Note:

Emission level (dBuV/m) = 20 log Emission level (uV/m).

Corrected Reading: Antenna Factor + Cable Loss + Read Level - Preamp Factor = Level.

Temperature	26°C	Humidity	60%
Test Engineer	Jim Huang	Test Date	Dec. 27, 2012
Configurations	IEEE 802.11n MCS0 20MHz Ch 1, 6, 11 / Chain 1 + Chain 2		
Test Mode	Mode 2. EUT 2 (with internal antenna) + Ant. 19 (Embedded antenna) / Radio 2 (2.4GHz + 5GHz band)		

Channel 1

	Freq	Level	Limit Line	Over Limit	Read Level	CableAntenna Loss	Antenna Factor	Preamp Factor	Remark	A/Pos	T/Pos	Pol/Phase
	MHz	dBuV/m	dBuV/m	dB	dBuV	dB	dB/m	dB		cm	deg	
1	2389.00	71.82	74.00	-2.18	39.43	4.34	28.05	0.00	Peak	157	154	VERTICAL
2	2390.00	53.32	54.00	-0.68	20.93	4.34	28.05	0.00	Average	157	154	VERTICAL
3	2418.20	106.43			73.94	4.36	28.13	0.00	Average	157	154	VERTICAL
4	2418.20	116.30			83.81	4.36	28.13	0.00	Peak	157	154	VERTICAL

Item 3, 4 are the fundamental frequency at 2412 MHz.

Channel 6

	Freq	Level	Limit Line	Over Limit	Read Level	CableAntenna Loss	Antenna Factor	Preamp Factor	Remark	A/Pos	T/Pos	Pol/Phase
	MHz	dBuV/m	dBuV/m	dB	dBuV	dB	dB/m	dB		cm	deg	
1	2360.80	47.90	54.00	-6.10	15.63	4.30	27.97	0.00	Average	125	173	HORIZONTAL
2	2363.20	60.65	74.00	-13.35	28.36	4.32	27.97	0.00	Peak	125	173	HORIZONTAL
3	2433.00	110.03			77.54	4.36	28.13	0.00	Average	125	173	HORIZONTAL
4	2434.20	119.53			86.99	4.36	28.18	0.00	Peak	125	173	HORIZONTAL
5	2483.50	52.14	54.00	-1.86	19.48	4.40	28.26	0.00	Average	125	173	HORIZONTAL
6	2488.30	65.24	74.00	-8.76	32.52	4.42	28.30	0.00	Peak	125	173	HORIZONTAL

Item 3, 4 are the fundamental frequency at 2437MHz.

Channel 11

	Freq	Level	Limit Line	Over Limit	Read Level	CableAntenna Loss	Antenna Factor	Preamp Factor	Remark	A/Pos	T/Pos	Pol/Phase
	MHz	dBuV/m	dBuV/m	dB	dBuV	dB	dB/m	dB		cm	deg	
1	2468.60	105.43			72.77	4.40	28.26	0.00	Average	150	175	HORIZONTAL
2	2468.80	115.35			82.69	4.40	28.26	0.00	Peak	150	175	HORIZONTAL
3	2483.50	53.39	54.00	-0.61	20.73	4.40	28.26	0.00	Average	150	175	HORIZONTAL
4	2485.30	69.43	74.00	-4.57	36.73	4.40	28.30	0.00	Peak	150	175	HORIZONTAL

Item 1, 2 are the fundamental frequency at 2462 MHz.

Temperature	26°C	Humidity	60%
Test Engineer	Jim Huang	Test Date	Dec. 27, 2012
Configurations	IEEE 802.11n MCS0 40MHz Ch 3, 6, 9 / Chain 1 + Chain 2		
Test Mode	Mode 2. EUT 2 (with internal antenna) + Ant. 19 (Embedded antenna) / Radio 2 (2.4GHz + 5GHz band)		

Channel 3

	Freq	Level	Limit Line	Over Limit	Read Level	CableAntenna Loss	Antenna Factor	Preamp Factor	Remark	A/Pos	T/Pos	Pol/Phase
	MHz	dBuV/m	dBuV/m	dB	dBuV	dB	dB/m	dB		cm	deg	
1	2390.00	53.47	54.00	-0.53	21.08	4.34	28.05	0.00	Average	161	156	VERTICAL
2	2390.00	70.63	74.00	-3.37	38.24	4.34	28.05	0.00	Peak	161	156	VERTICAL
3	2435.60	100.72			68.18	4.36	28.18	0.00	Average	161	156	VERTICAL
4	2436.40	110.27			77.73	4.36	28.18	0.00	Peak	161	156	VERTICAL

Item 3, 4 are the fundamental frequency at 2422 MHz.

Channel 6

	Freq	Level	Limit Line	Over Limit	Read Level	CableAntenna Loss	Antenna Factor	Preamp Factor	Remark	A/Pos	T/Pos	Pol/Phase
	MHz	dBuV/m	dBuV/m	dB	dBuV	dB	dB/m	dB		cm	deg	
1	2390.00	53.60	54.00	-0.40	21.21	4.34	28.05	0.00	Average	136	185	VERTICAL
2	2390.00	73.23	74.00	-0.77	40.84	4.34	28.05	0.00	Peak	136	185	VERTICAL
3	2419.80	104.73			72.24	4.36	28.13	0.00	Average	136	185	VERTICAL
4	2420.20	113.92			81.43	4.36	28.13	0.00	Peak	136	185	VERTICAL
5	2483.50	52.56	54.00	-1.44	19.90	4.40	28.26	0.00	Average	136	185	VERTICAL
6	2485.10	69.65	74.00	-4.35	36.95	4.40	28.30	0.00	Peak	136	185	VERTICAL

Item 3, 4 are the fundamental frequency at 2437MHz.

Channel 9

	Freq	Level	Limit Line	Over Limit	Read Level	CableAntenna Loss	Antenna Factor	Preamp Factor	Remark	A/Pos	T/Pos	Pol/Phase
	MHz	dBuV/m	dBuV/m	dB	dBuV	dB	dB/m	dB		cm	deg	
1	2461.60	99.32			66.72	4.38	28.22	0.00	Average	123	174	HORIZONTAL
2	2463.20	109.55			76.93	4.40	28.22	0.00	Peak	123	174	HORIZONTAL
3	2483.50	53.45	54.00	-0.55	20.79	4.40	28.26	0.00	Average	123	174	HORIZONTAL
4	2483.50	71.46	74.00	-2.54	38.80	4.40	28.26	0.00	Peak	123	174	HORIZONTAL

Item 1, 2 are the fundamental frequency at 2452 MHz.

Note:

Emission level (dBuV/m) = 20 log Emission level (uV/m).

Corrected Reading: Antenna Factor + Cable Loss + Read Level - Preamp Factor = Level.

Temperature	26°C	Humidity	60%
Test Engineer	Jim Huang	Test Date	Dec. 27, 2012
Configurations	IEEE 802.11b CH 1, 6, 11 / Chain 1		
Test Mode	Mode 2. EUT 2 (with internal antenna) + Ant. 19 (Embedded antenna) / Radio 2 (2.4GHz + 5GHz band)		

Channel 1

	Freq	Level	Limit Line	Over Limit	Read Level	CableAntenna Loss	Antenna Factor	Preamp Factor	Remark	A/Pos	T/Pos	Pol/Phase
	MHz	dBuV/m	dBuV/m	dB	dBuV	dB	dB/m	dB		cm	deg	
1	2389.40	55.69	74.00	-18.31	23.30	4.34	28.05	0.00	Peak	100	216	VERTICAL
2	2390.00	44.65	54.00	-9.35	12.26	4.34	28.05	0.00	Average	100	216	VERTICAL
3	2411.20	105.40			72.97	4.34	28.09	0.00	Average	100	216	VERTICAL
4	2413.00	108.85			76.40	4.36	28.09	0.00	Peak	100	216	VERTICAL

Item 3, 4 are the fundamental frequency at 2412 MHz.

Channel 6

	Freq	Level	Limit Line	Over Limit	Read Level	CableAntenna Loss	Antenna Factor	Preamp Factor	Remark	A/Pos	T/Pos	Pol/Phase
	MHz	dBuV/m	dBuV/m	dB	dBuV	dB	dB/m	dB		cm	deg	
1	2390.00	46.81	54.00	-7.19	14.42	4.34	28.05	0.00	Average	146	151	VERTICAL
2	2390.00	57.68	74.00	-16.32	25.29	4.34	28.05	0.00	Peak	146	151	VERTICAL
3	2438.20	112.39			79.83	4.38	28.18	0.00	Peak	146	151	VERTICAL
4	2438.60	108.62			76.06	4.38	28.18	0.00	Average	146	151	VERTICAL
5	2483.50	46.77	54.00	-7.23	14.11	4.40	28.26	0.00	Average	146	151	VERTICAL
6	2483.50	58.64	74.00	-15.36	25.98	4.40	28.26	0.00	Peak	146	151	VERTICAL

Item 3, 4 are the fundamental frequency at 2437 MHz.

Channel 11

	Freq	Level	Limit Line	Over Limit	Read Level	CableAntenna Loss	Antenna Factor	Preamp Factor	Remark	A/Pos	T/Pos	Pol/Phase
	MHz	dBuV/m	dBuV/m	dB	dBuV	dB	dB/m	dB		cm	deg	
1	2463.00	109.76			77.14	4.40	28.22	0.00	Peak	157	175	HORIZONTAL
2	2463.80	106.06			73.44	4.40	28.22	0.00	Average	157	175	HORIZONTAL
3	2483.50	46.16	54.00	-7.84	13.50	4.40	28.26	0.00	Average	157	175	HORIZONTAL
4	2483.50	57.31	74.00	-16.69	24.65	4.40	28.26	0.00	Peak	157	175	HORIZONTAL

Item 1, 2 are the fundamental frequency at 2462 MHz.

Temperature	26°C	Humidity	60%
Test Engineer	Jim Huang	Test Date	Dec. 27, 2012
Configurations	IEEE 802.11g CH 1, 6, 11 / Chain 1 + Chain 2		
Test Mode	Mode 2. EUT 2 (with internal antenna) + Ant. 19 (Embedded antenna) / Radio 2 (2.4GHz + 5GHz band)		

Channel 1

	Freq	Level	Limit Line	Over Limit	Read Level	CableAntenna Loss	Antenna Factor	Preamp Factor	Remark	A/Pos	T/Pos	Pol/Phase
	MHz	dBuV/m	dBuV/m	dB	dBuV	dB	dB/m	dB		cm	deg	
1	2389.20	72.25	74.00	-1.75	39.86	4.34	28.05	0.00	Peak	153	191	VERTICAL
2	2390.00	53.28	54.00	-0.72	20.89	4.34	28.05	0.00	Average	153	191	VERTICAL
3	2419.20	107.50			75.01	4.36	28.13	0.00	Average	153	191	VERTICAL
4	2419.20	117.54			85.05	4.36	28.13	0.00	Peak	153	191	VERTICAL

Item 3, 4 are the fundamental frequency at 2412 MHz.

Channel 6

	Freq	Level	Limit Line	Over Limit	Read Level	CableAntenna Loss	Antenna Factor	Preamp Factor	Remark	A/Pos	T/Pos	Pol/Phase
	MHz	dBuV/m	dBuV/m	dB	dBuV	dB	dB/m	dB		cm	deg	
1	2390.00	51.00	54.00	-3.00	18.61	4.34	28.05	0.00	Average	159	156	VERTICAL
2	2390.00	68.24	74.00	-5.76	35.85	4.34	28.05	0.00	Peak	159	156	VERTICAL
3	2435.40	120.60			88.06	4.36	28.18	0.00	Peak	159	156	VERTICAL
4	2439.80	111.05			78.49	4.38	28.18	0.00	Average	159	156	VERTICAL
5	2483.50	51.27	54.00	-2.73	18.61	4.40	28.26	0.00	Average	159	156	VERTICAL
6	2483.50	65.68	74.00	-8.32	33.02	4.40	28.26	0.00	Peak	159	156	VERTICAL

Item 3, 4 are the fundamental frequency at 2437 MHz.

Channel 11

	Freq	Level	Limit Line	Over Limit	Read Level	CableAntenna Loss	Antenna Factor	Preamp Factor	Remark	A/Pos	T/Pos	Pol/Phase
	MHz	dBuV/m	dBuV/m	dB	dBuV	dB	dB/m	dB		cm	deg	
1	2456.20	105.50			72.90	4.38	28.22	0.00	Average	157	161	VERTICAL
2	2456.20	115.53			82.93	4.38	28.22	0.00	Peak	157	161	VERTICAL
3	2483.50	53.97	54.00	-0.03	21.31	4.40	28.26	0.00	Average	157	161	VERTICAL
4	2483.90	70.46	74.00	-3.54	37.80	4.40	28.26	0.00	Peak	157	161	VERTICAL

Item 1, 2 are the fundamental frequency at 2462 MHz.

Note:

Emission level (dBuV/m) = 20 log Emission level (uV/m).

Corrected Reading: Antenna Factor + Cable Loss + Read Level - Preamp Factor = Level.

For Emission not in Restricted Band

For Mode 1. EUT 2 (with internal antenna) + Ant. 18 (Embedded antenna) / Radio 1 (2.4GHz band):

Plot on Configuration IEEE 802.11n MCS0 20MHz / Reference Level

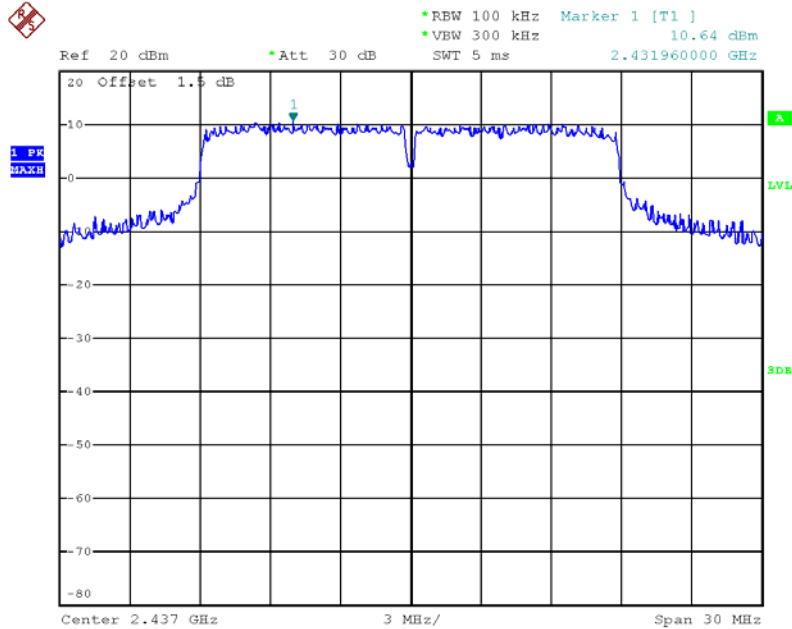

Date: 2.JAN.2013 22:06:19

Plot on Configuration IEEE 802.11n MCS0 20MHz / CH 1 (down 30dBc)

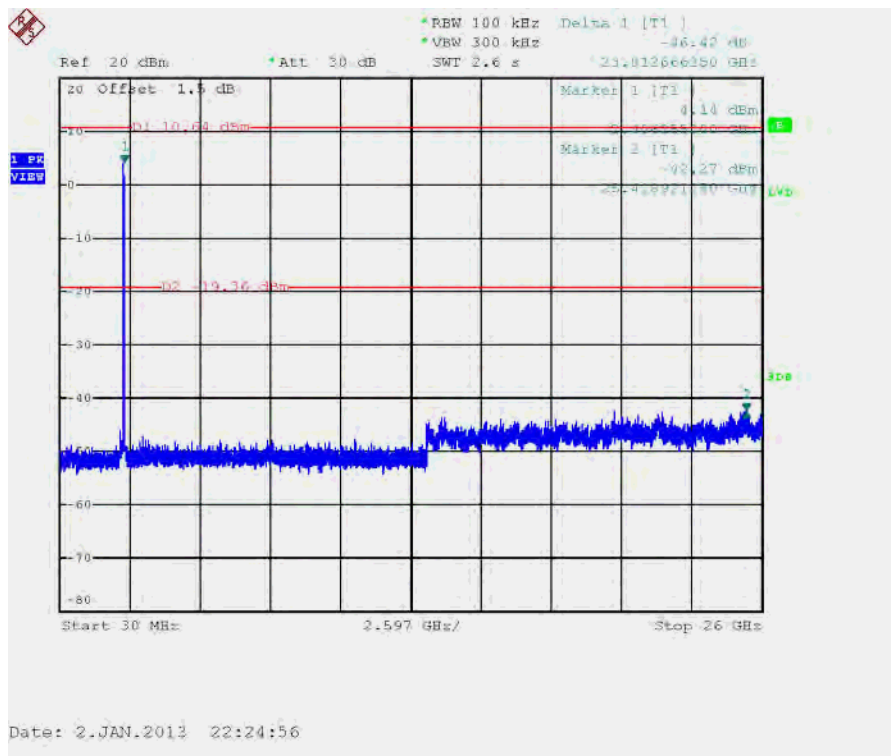

Date: 2.JAN.2013 22:24:56

Plot on Configuration IEEE 802.11n MCS0 20MHz / CH 6 (down 30dBc)

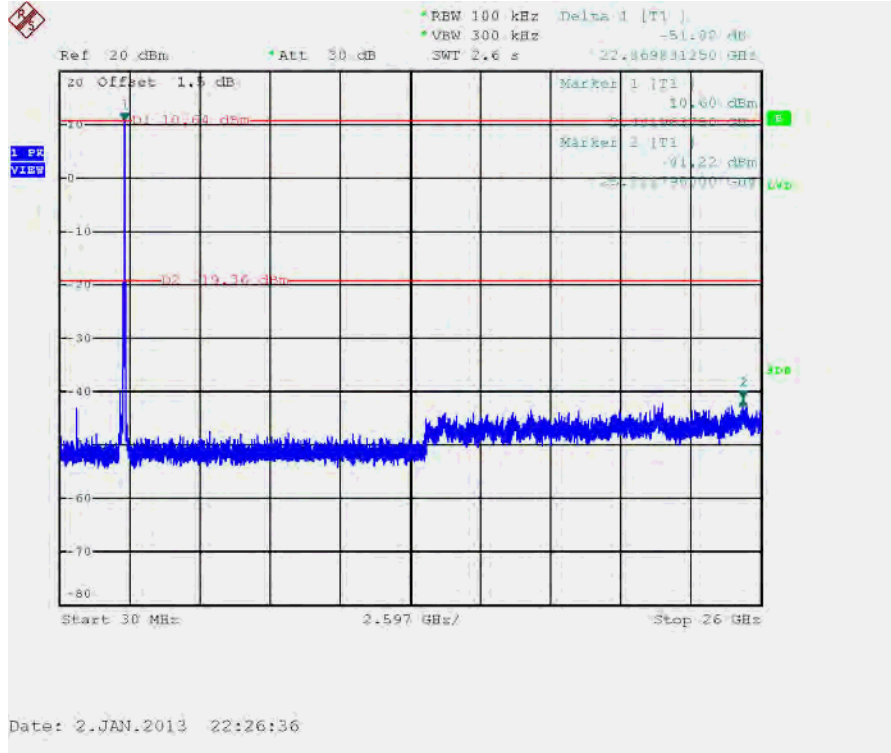

Plot on Configuration IEEE 802.11n MCS0 20MHz / CH 11 (down 30dBc)

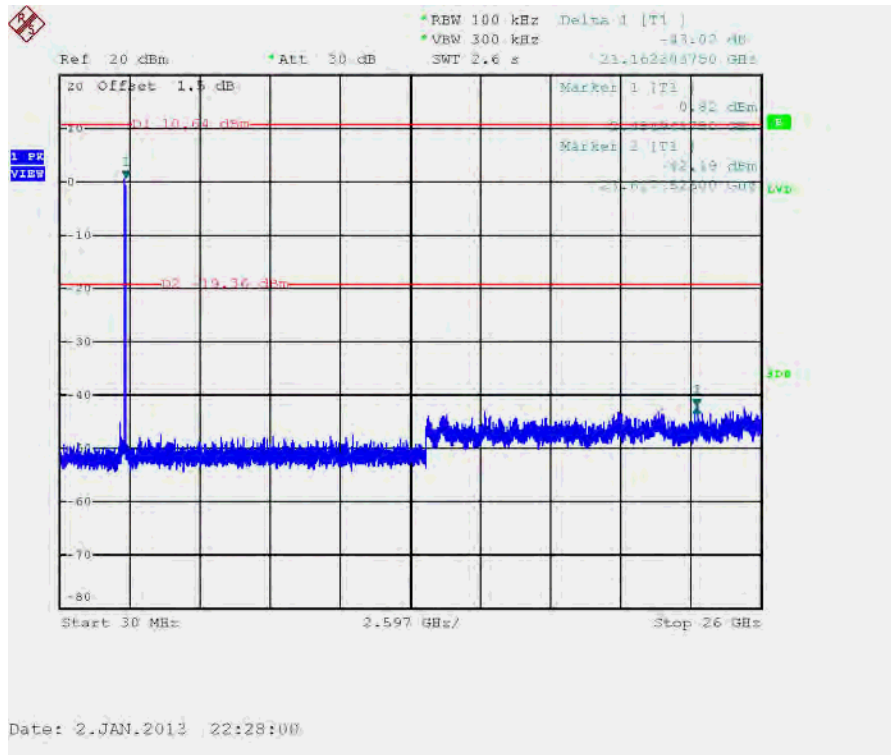

Plot on Configuration IEEE 802.11n MCS0 40MHz / Reference Level

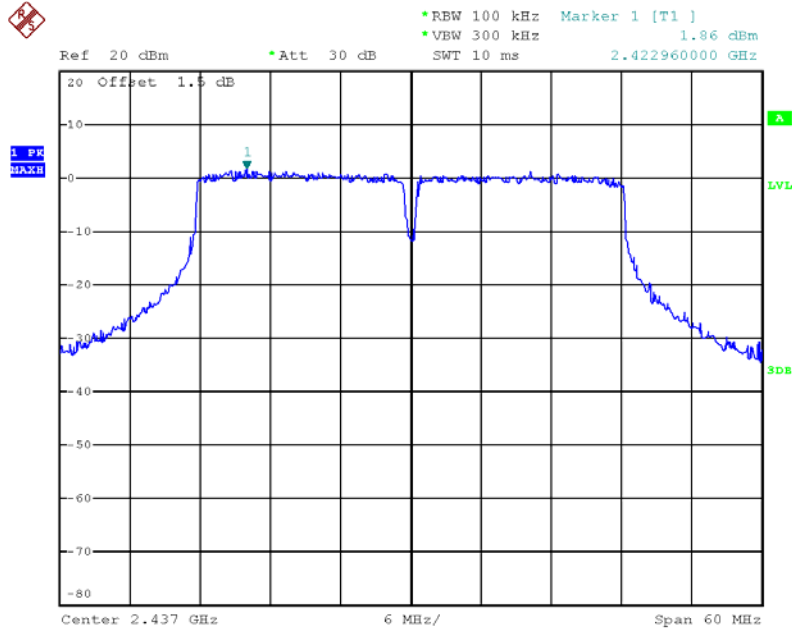

Date: 2.JAN.2013 22:12:44

Plot on Configuration IEEE 802.11n MCS0 40MHz / CH 3 (down 30dBc)

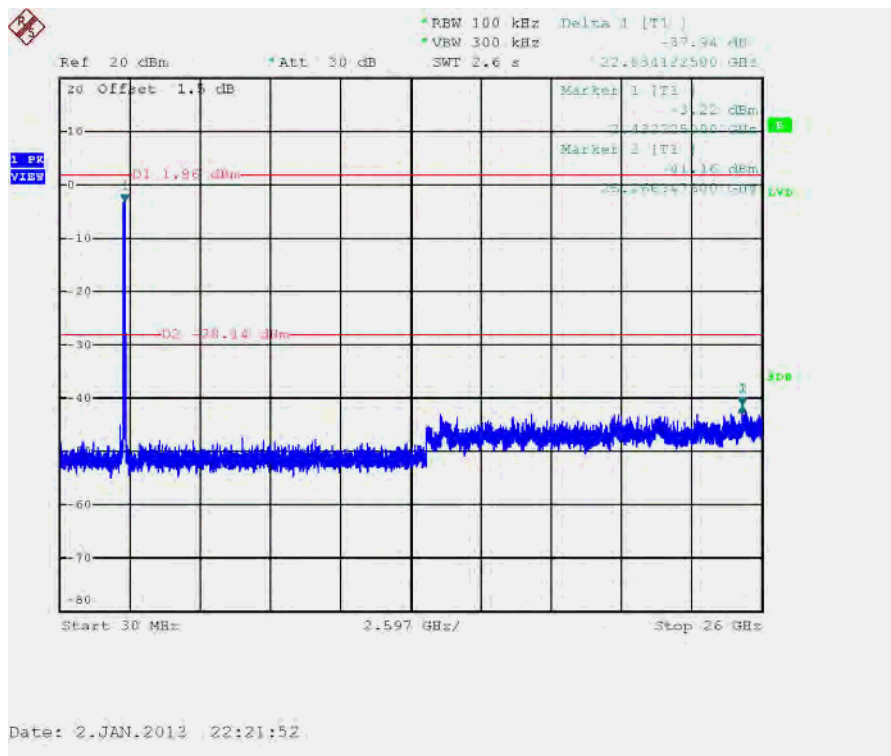

Plot on Configuration IEEE 802.11n MCS0 40MHz / CH 6 (down 30dBc)

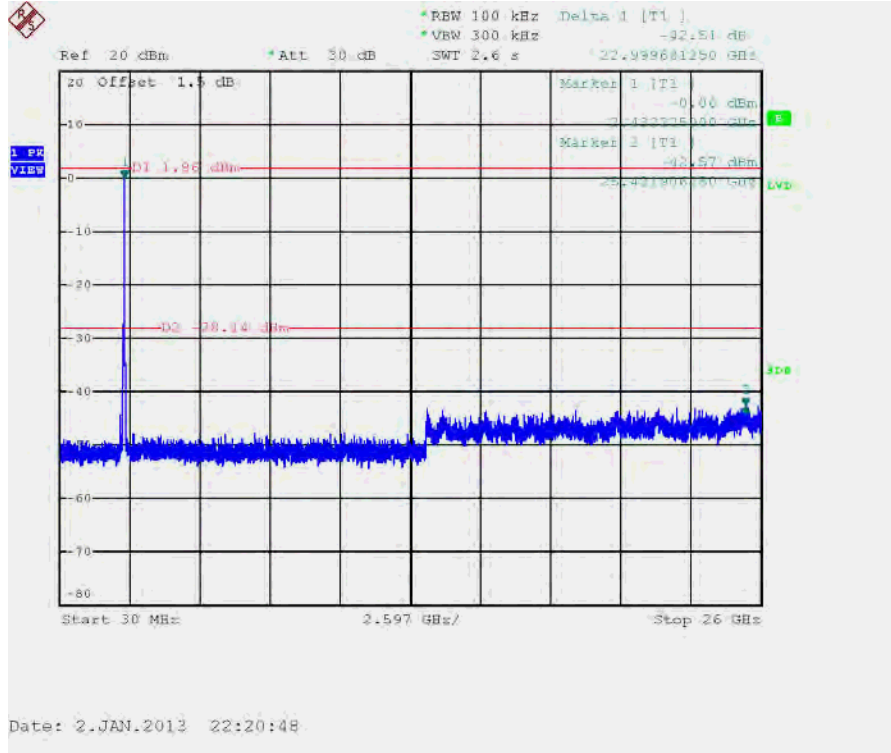

Plot on Configuration IEEE 802.11n MCS0 40MHz / CH 9 (down 30dBc)

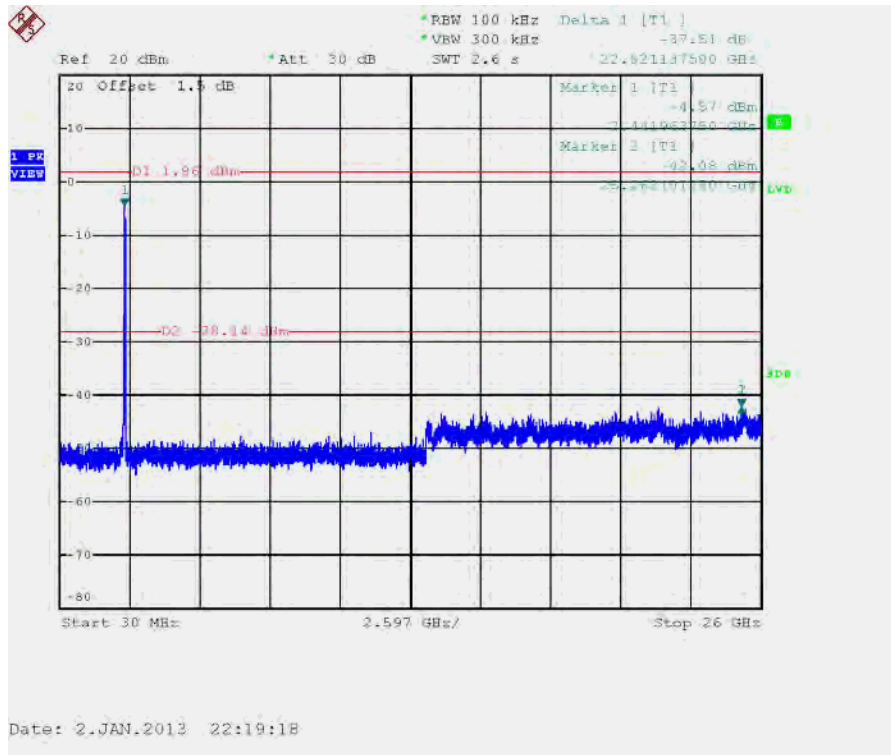

Plot on Configuration IEEE 802.11b / Reference Level

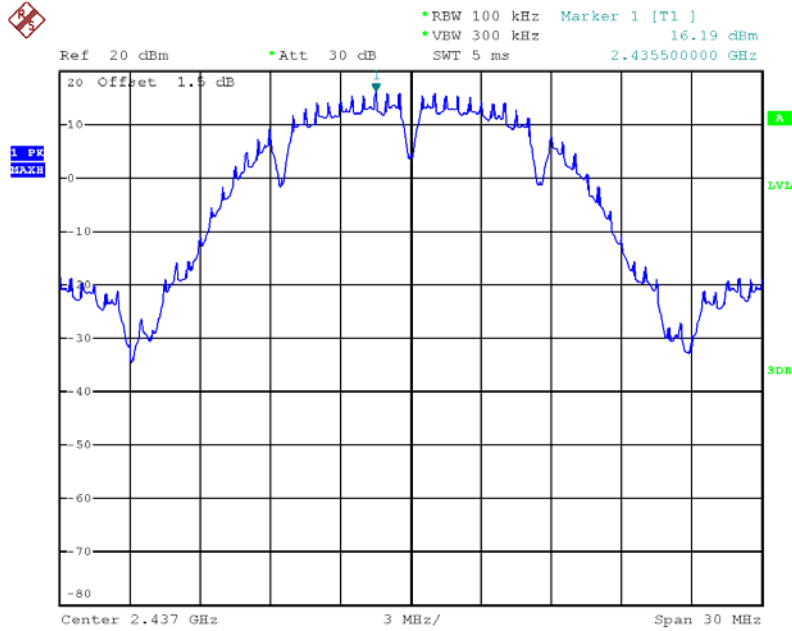

Date: 2.JAN.2013 21:37:05

Plot on Configuration IEEE 802.11b / CH 1 (down 30dBc)

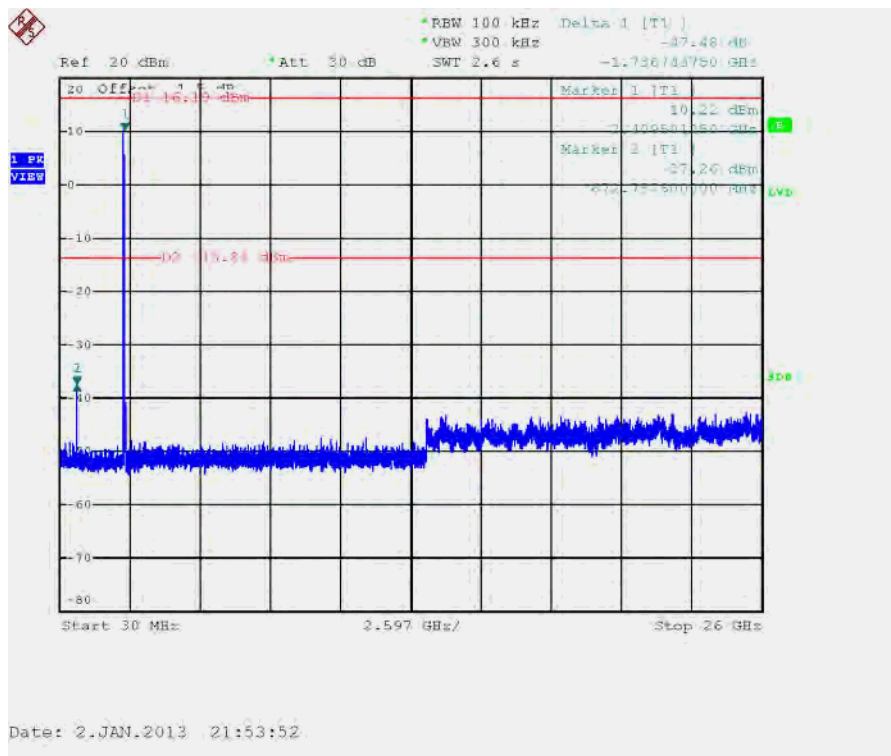

Date: 2.JAN.2013 21:53:52

Plot on Configuration IEEE 802.11g / Reference Level

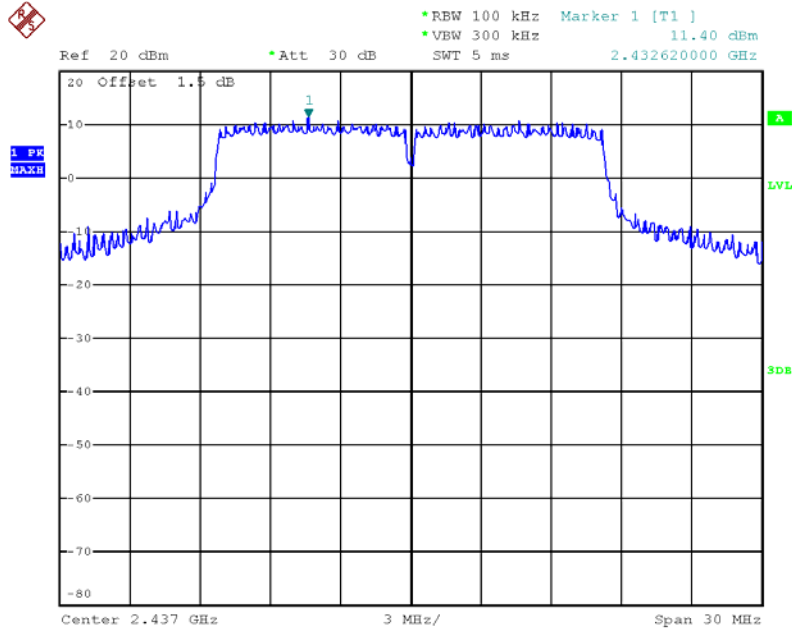

Date: 2.JAN.2013 21:59:48

Plot on Configuration IEEE 802.11g / CH 1 (down 30dBc)

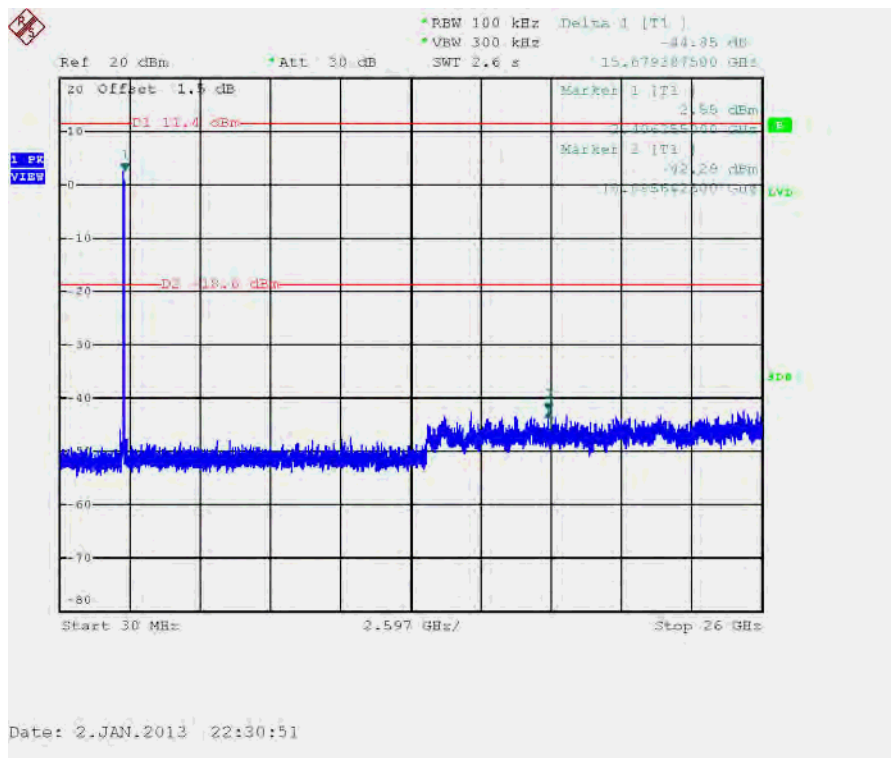

Date: 2.JAN.2013 22:30:51

For Mode 2. EUT 2 (with internal antenna) + Ant. 19 (Embedded antenna) / Radio 2 (2.4GHz + 5GHz band):

Plot on Configuration IEEE 802.11n MCS0 20MHz / Reference Level

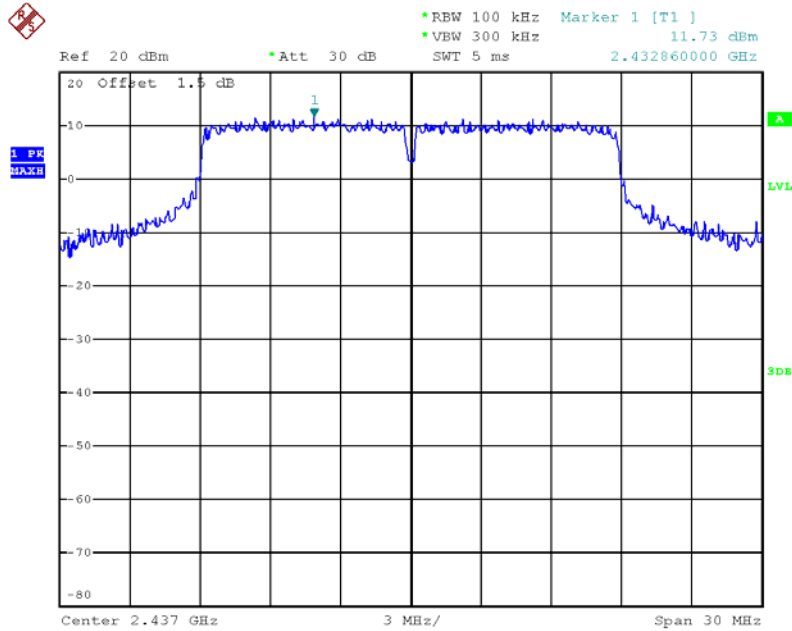

Date: 3.JAN.2013 00:21:14

Plot on Configuration IEEE 802.11n MCS0 20MHz / CH 1 (down 30dBc)

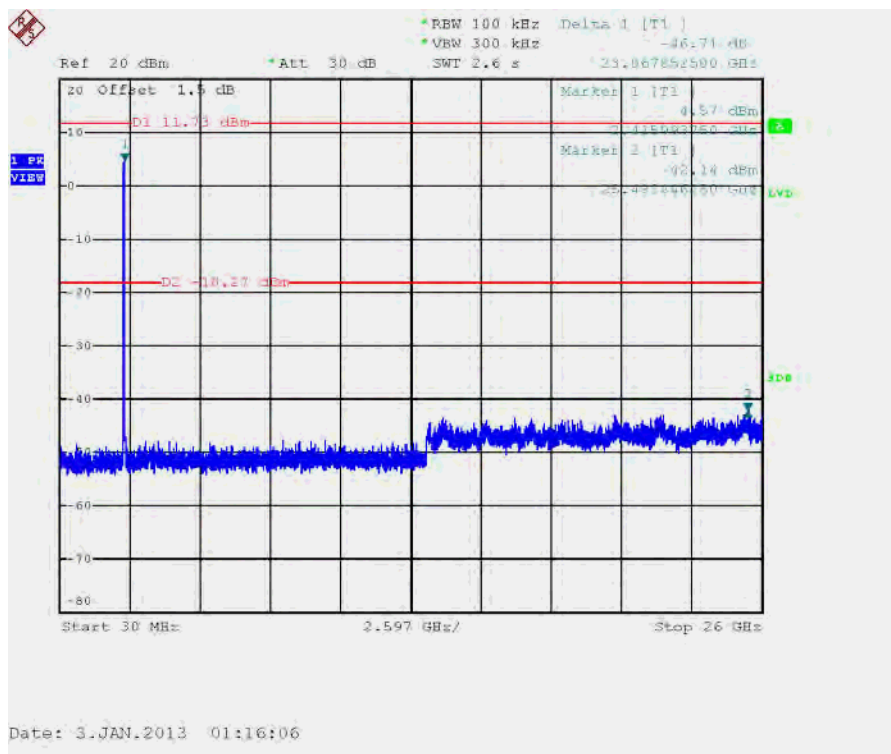

Plot on Configuration IEEE 802.11n MCS0 20MHz / CH 6 (down 30dBc)

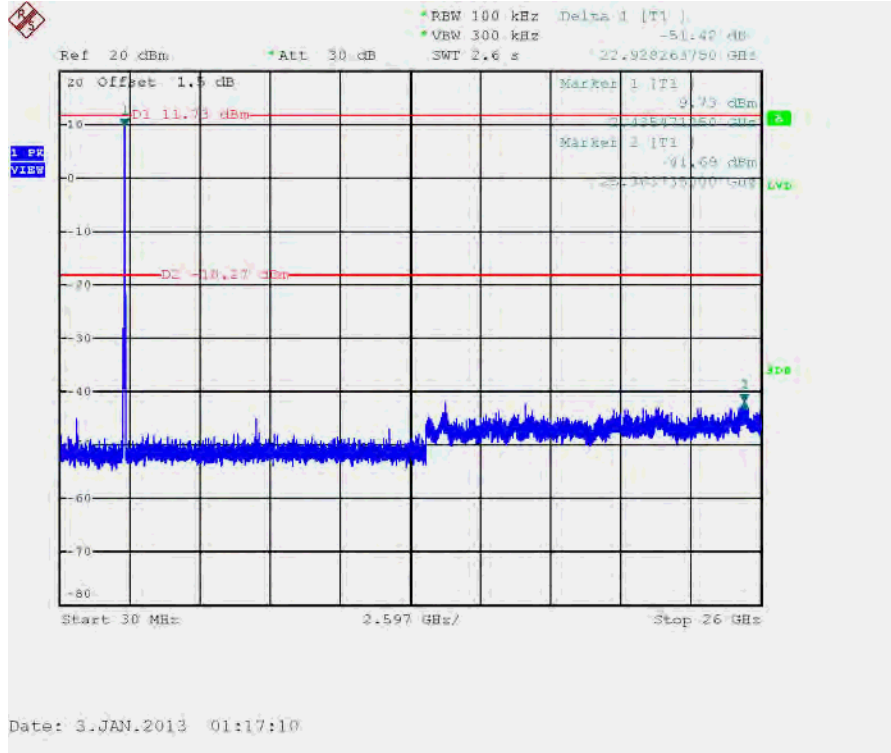

Plot on Configuration IEEE 802.11n MCS0 20MHz / CH 11 (down 30dBc)

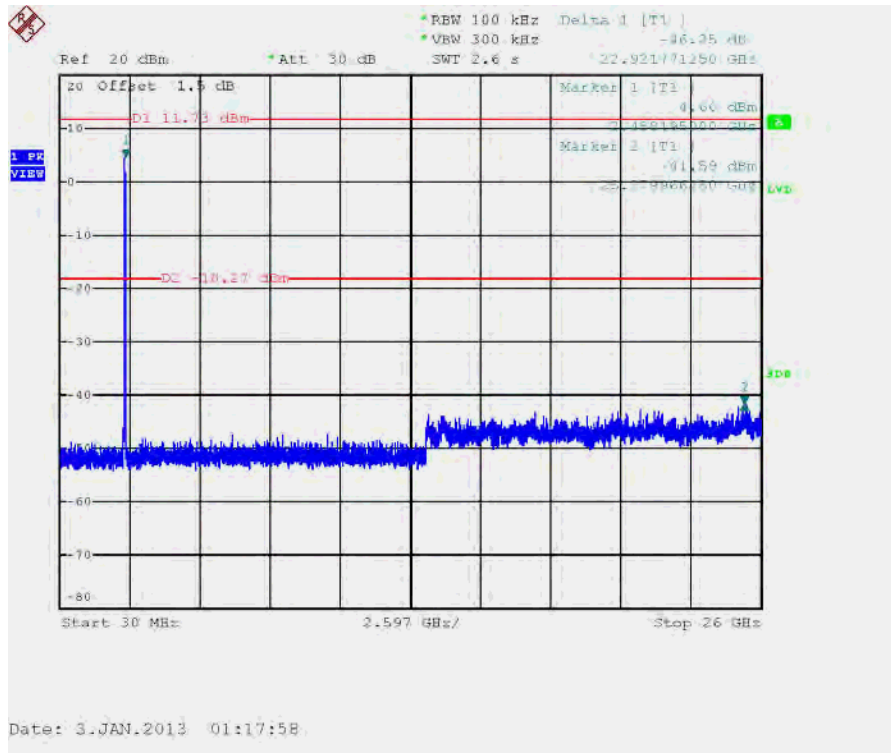

Plot on Configuration IEEE 802.11n MCS0 40MHz / Reference Level

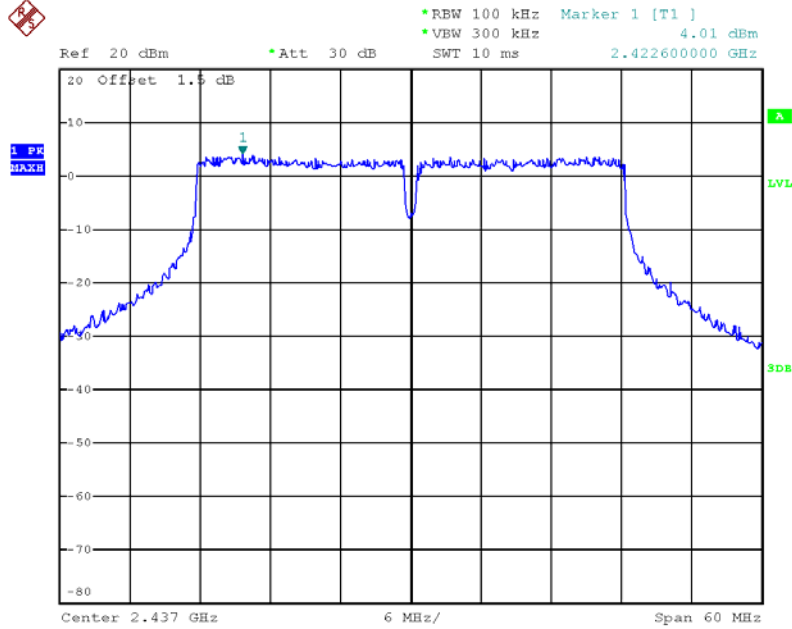

Date: 3.JAN.2013 00:27:11

Plot on Configuration IEEE 802.11n MCS0 40MHz / CH 3 (down 30dBc)

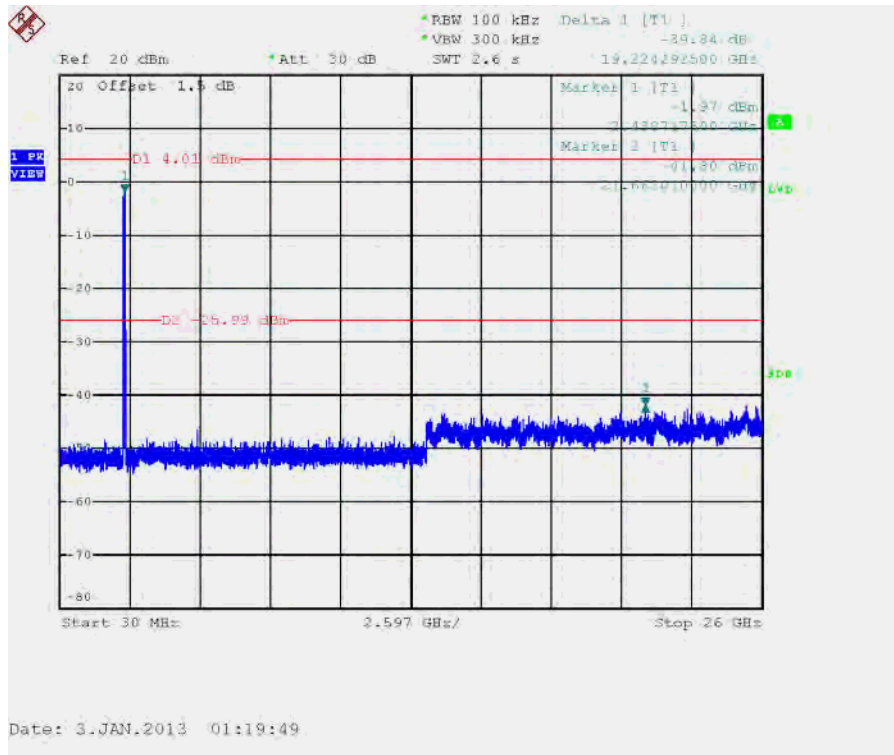

Plot on Configuration IEEE 802.11n MCS0 40MHz / CH 6 (down 30dBc)

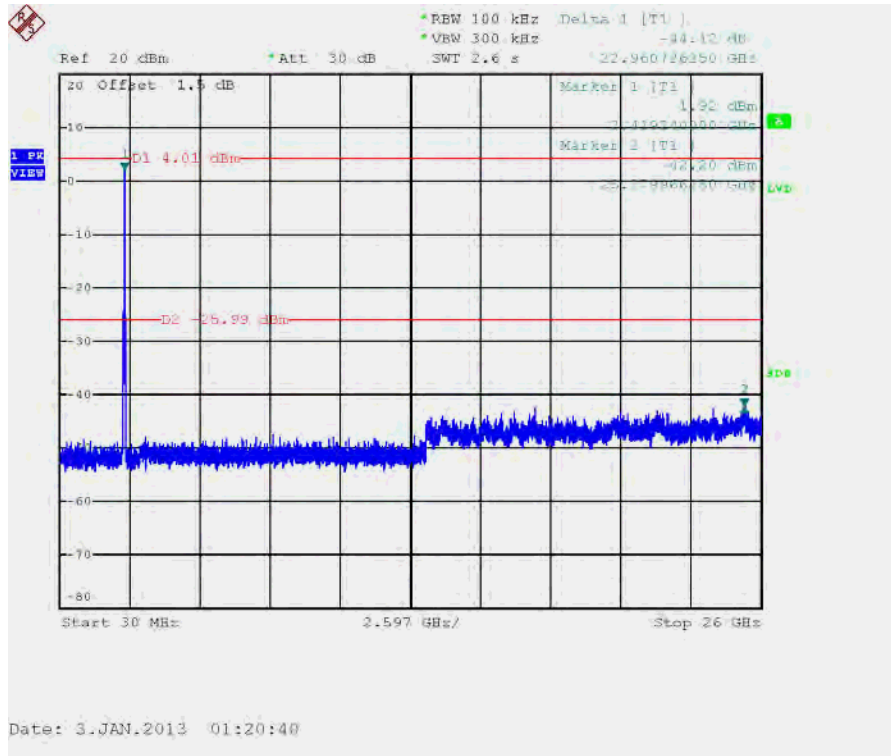

Plot on Configuration IEEE 802.11n MCS0 40MHz / CH 9 (down 30dBc)

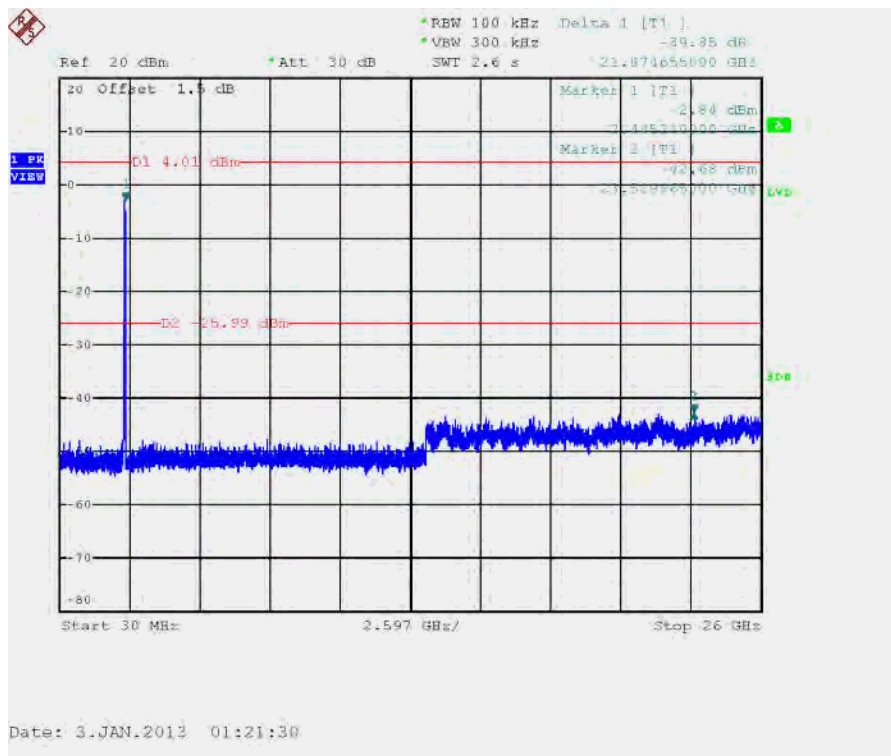

Plot on Configuration IEEE 802.11n MCS0 20MHz / Reference Level

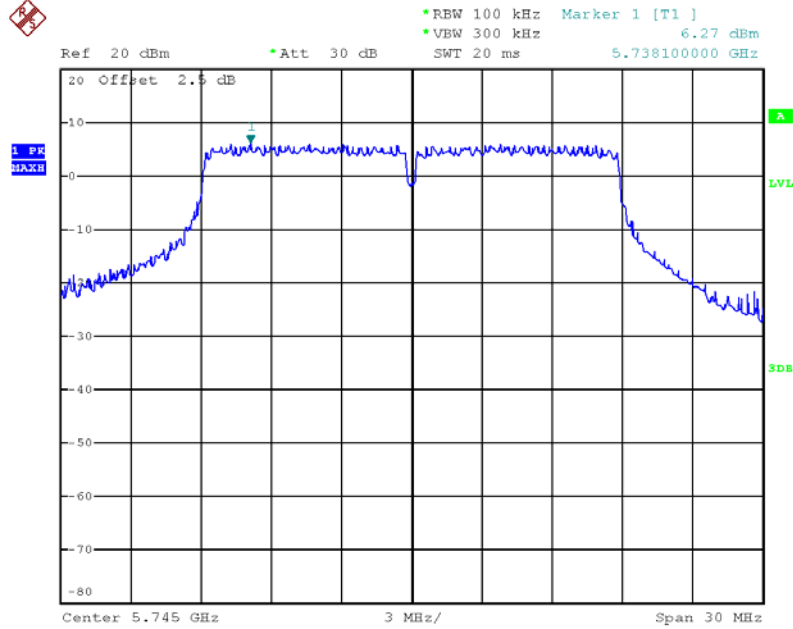

Date: 3.JAN.2013 00:36:34

Plot on Configuration IEEE 802.11n MCS0 20MHz / CH 149 (down 30dBc)

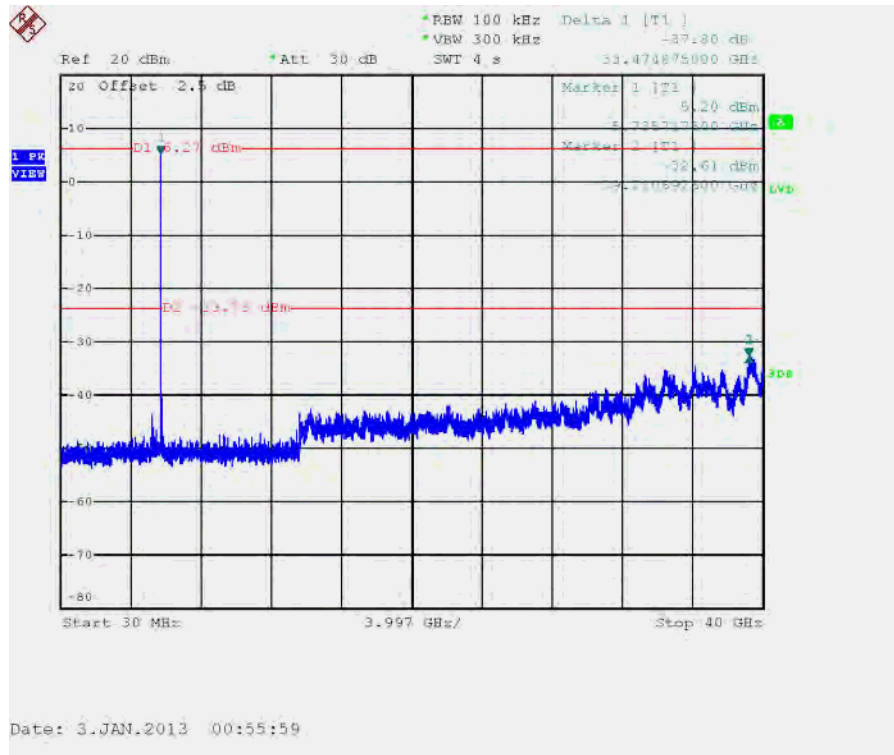

Date: 3.JAN.2013 00:55:59

Plot on Configuration IEEE 802.11n MCS0 20MHz / CH 157 (down 30dBc)

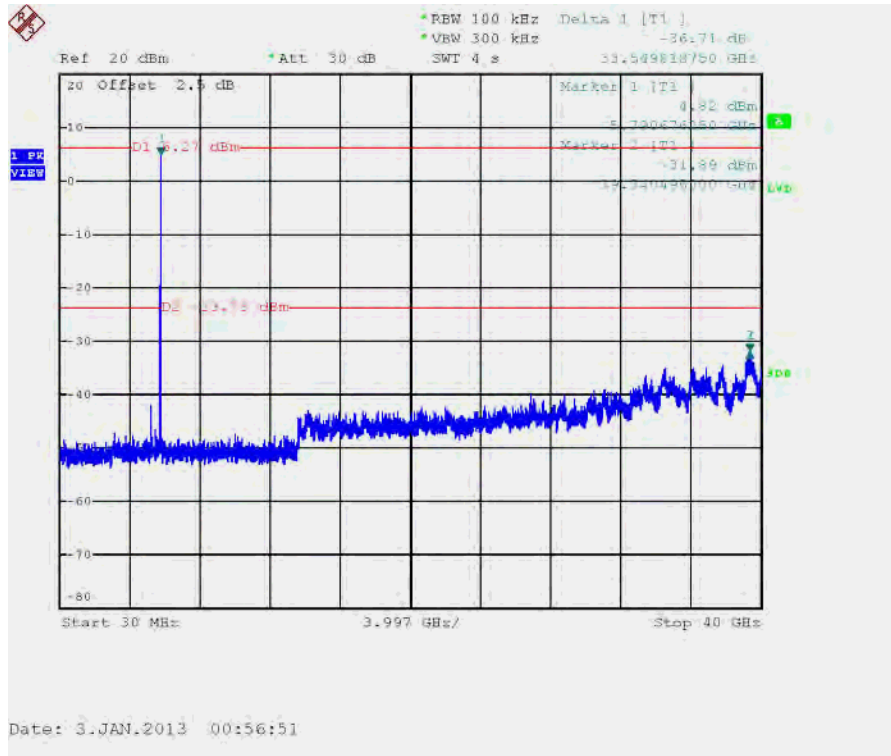

Plot on Configuration IEEE 802.11n MCS0 20MHz / CH 165 (down 30dBc)

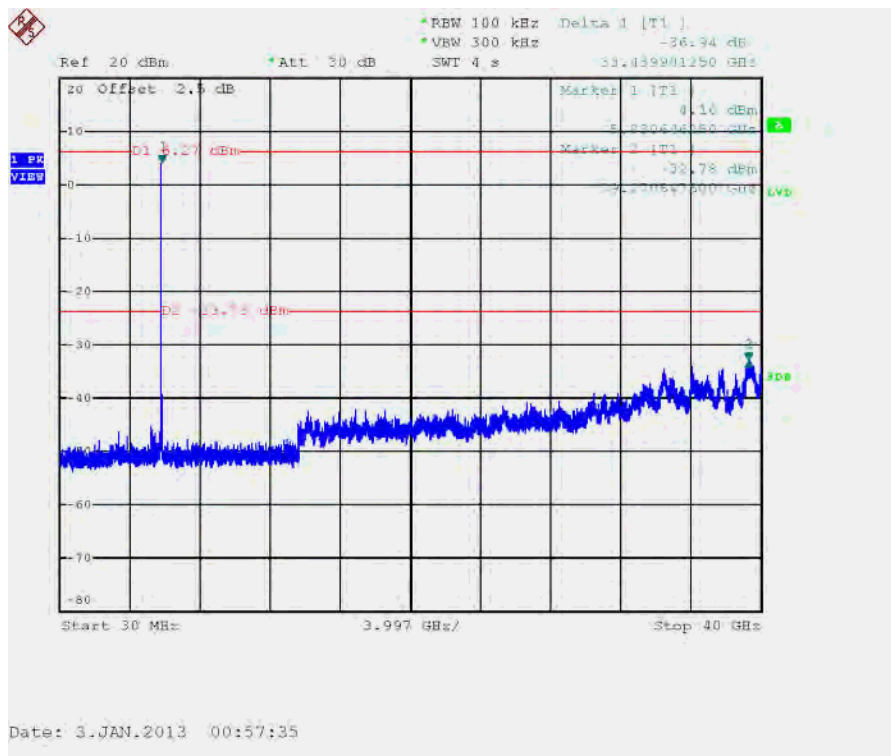

Plot on Configuration IEEE 802.11n MCS0 40MHz / Reference Level

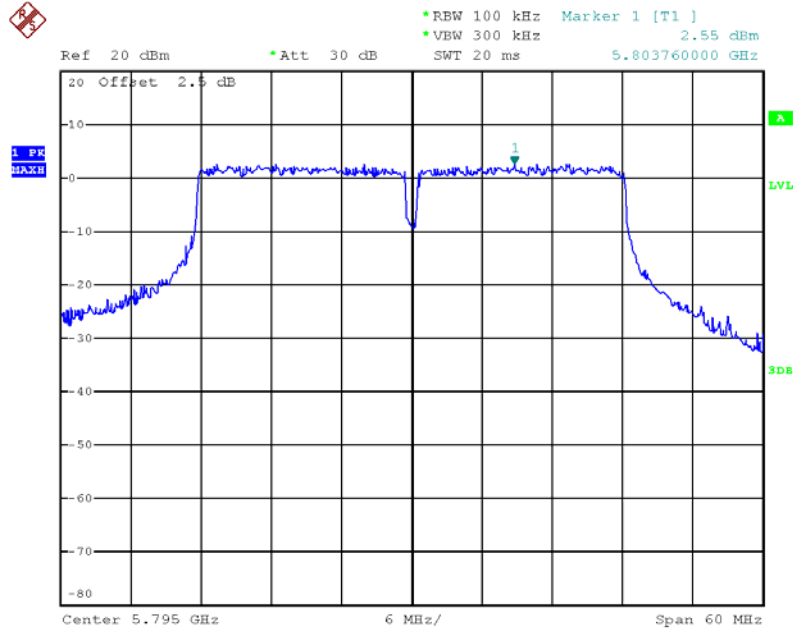

Date: 3.JAN.2013 00:41:52

Plot on Configuration IEEE 802.11n MCS0 40MHz / CH 151 (down 30dBc)

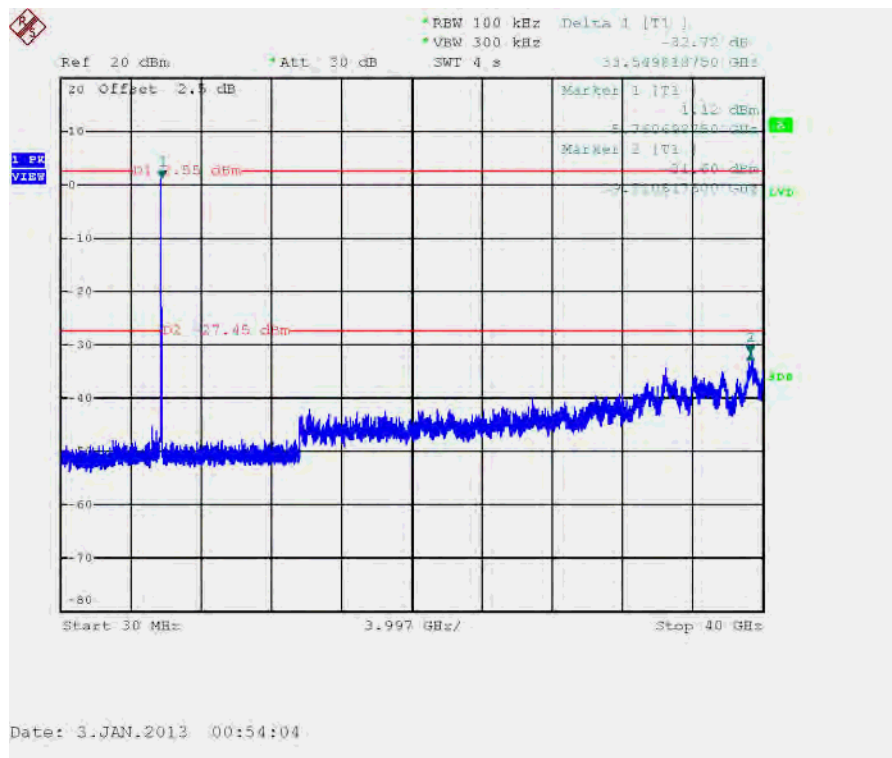

Date: 3.JAN.2013 00:54:04

Plot on Configuration IEEE 802.11n MCS0 40MHz / CH 159 (down 30dBc)

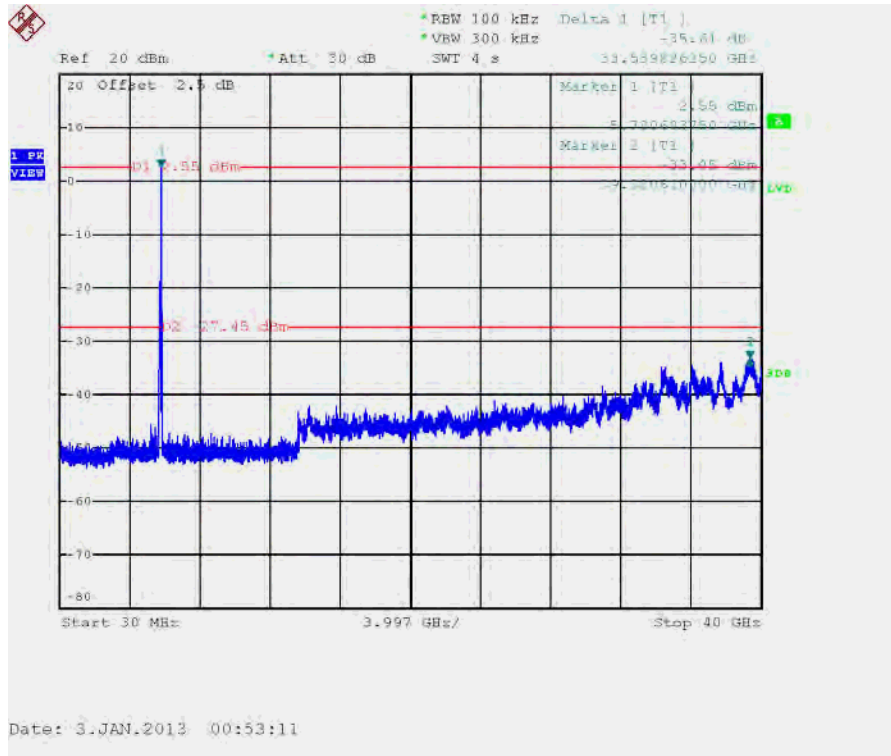

Plot on Configuration IEEE 802.11b / Reference Level

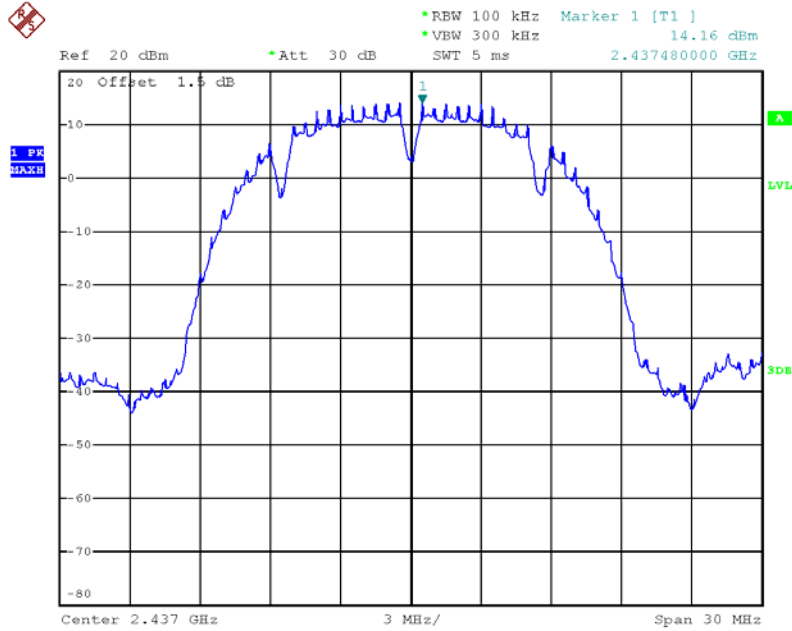

Date: 3.JAN.2013 00:11:03

Plot on Configuration IEEE 802.11b / CH 1 (down 30dBc)

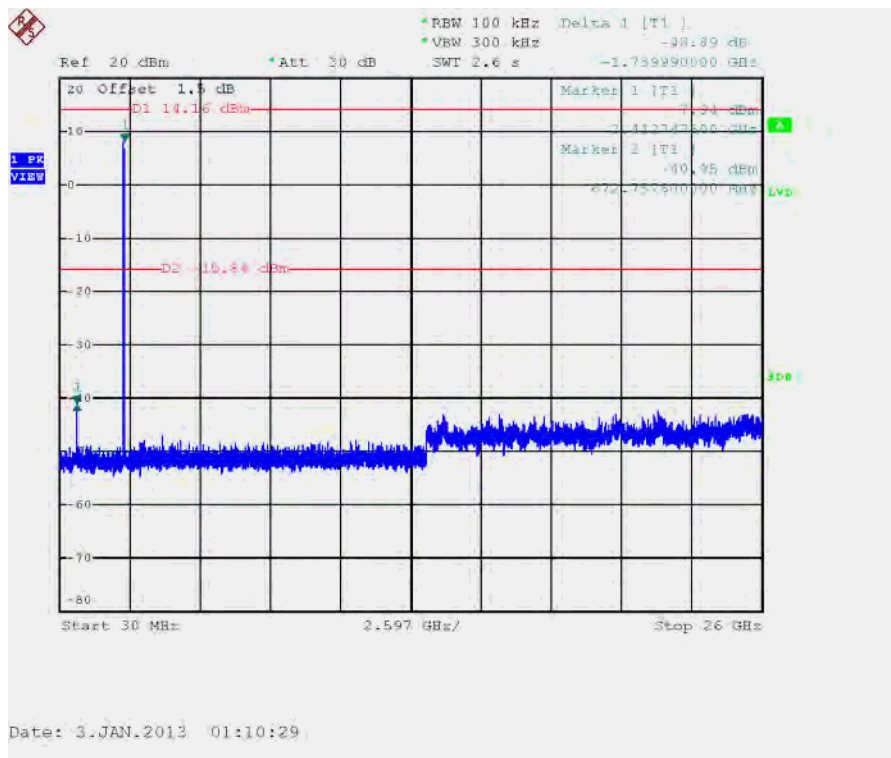

Date: 3.JAN.2013 01:10:29

Plot on Configuration IEEE 802.11g / Reference Level

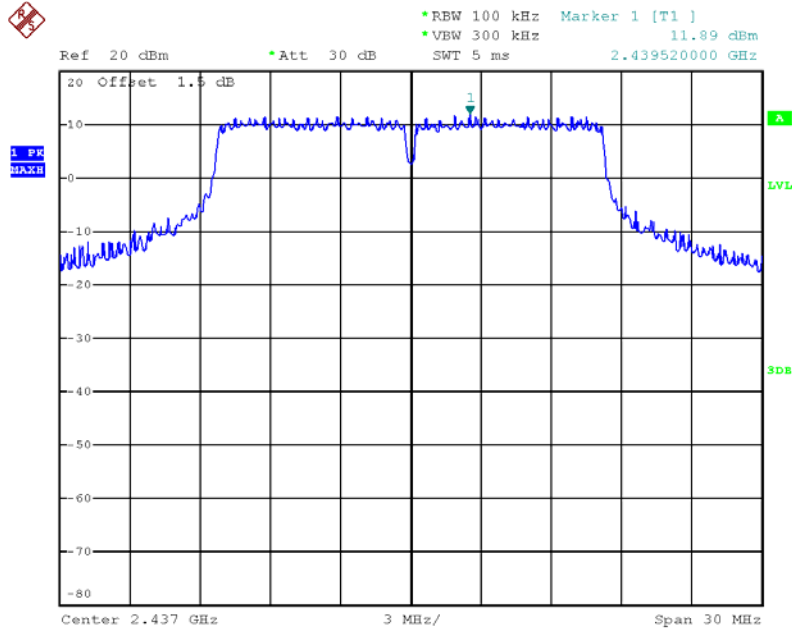

Date: 3.JAN.2013 00:14:25

Plot on Configuration IEEE 802.11g / CH 1 (down 30dBc)

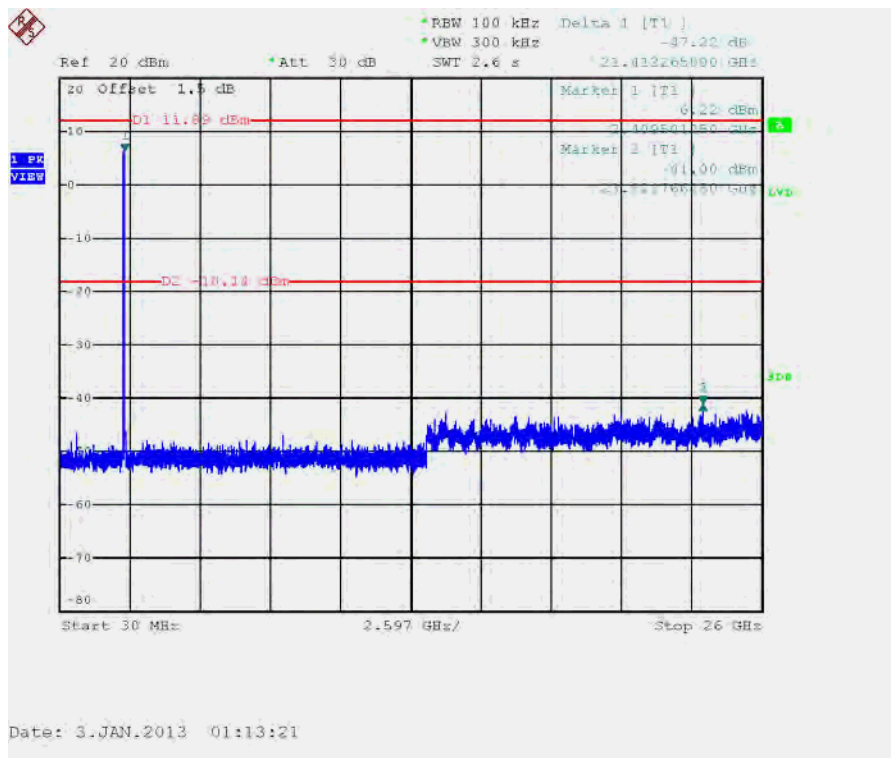

Plot on Configuration IEEE 802.11a / Reference Level

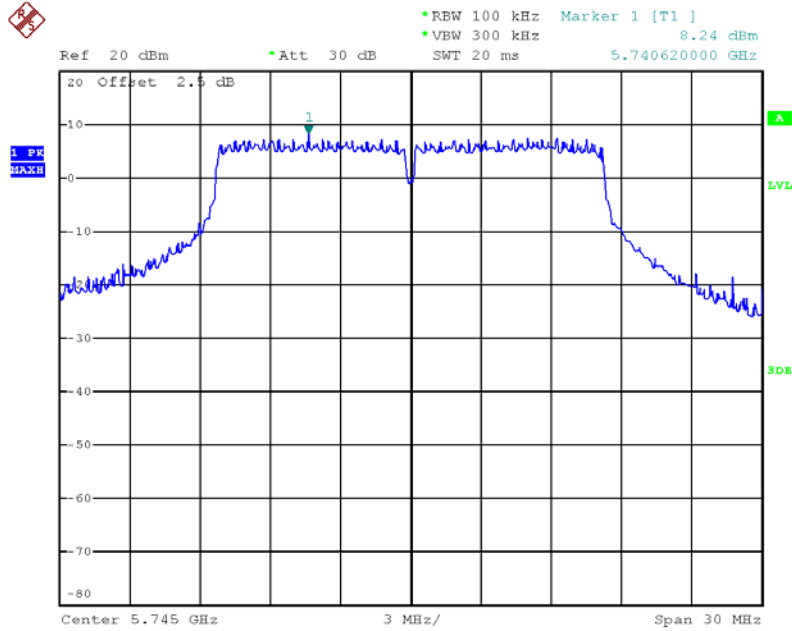

Date: 3.JAN.2013 00:31:31

Plot on Configuration IEEE 802.11a / CH 149 (down 30dBc)

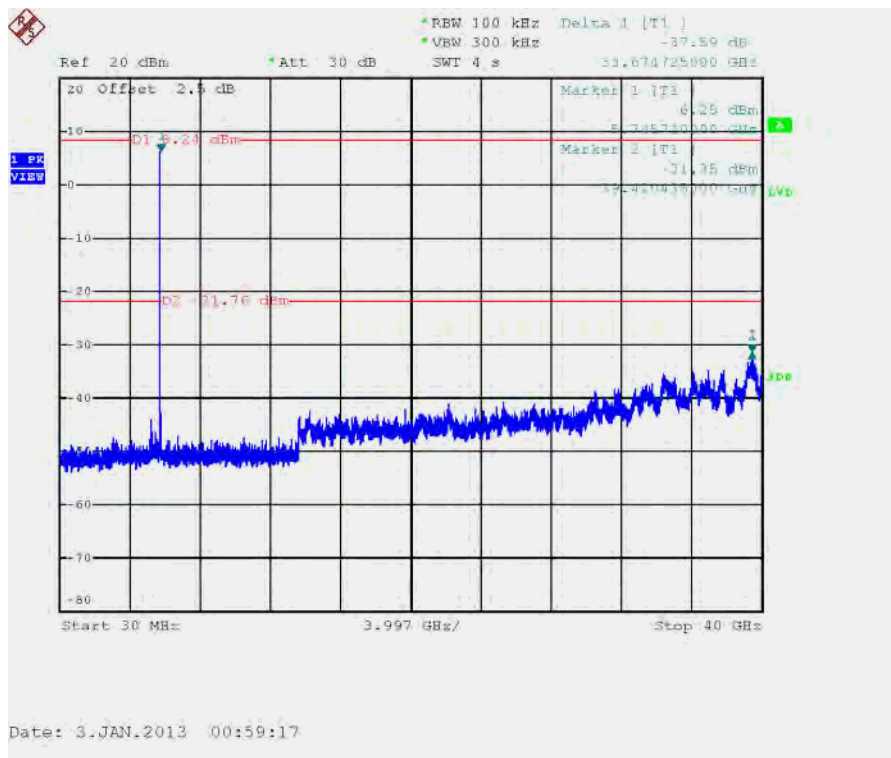

Date: 3.JAN.2013 00:59:17

4.7. Antenna Requirements

4.7.1. Limit

Except for special regulations, the Low-power Radio-frequency Devices must not be equipped with any jacket for installing an antenna with extension cable. An intentional radiator shall be designed to ensure that no antenna other than that furnished by the responsible party shall be used with the device. The use of a permanently attached antenna or of an antenna that uses a unique coupling to the intentional radiator shall be considered sufficient to comply with the provisions of this Section. The manufacturer may design the unit so that the user can replace a broken antenna, but the use of a standard antenna jack or electrical connector is prohibited. Further, this requirement does not apply to intentional radiators that must be professionally installed.

4.7.2. Antenna Connector Construction

Please refer to section 3.3 in this test report; antenna connector complied with the requirements.

5. LIST OF MEASURING EQUIPMENTS

Instrument	Manufacturer	Model No.	Serial No.	Characteristics	Calibration Date	Remark
EMI Test Receiver	R&S	ESCS 30	100377	9kHz ~ 2.75GHz	Oct. 23, 2012	Conduction (CO01-CB)
LISN	F.C.C.	FCC-LISN-50-16-2	04083	150kHz ~ 100MHz	Nov. 26, 2012	Conduction (CO01-CB)
V- LISN	Schwarzbeck	NSLK 8127	8127-478	9kHz ~ 30MHz	Jun. 22, 2012	Conduction (CO01-CB)
Impulsbegrenzer Pulse Limiter	Rohde&Schwarz	ESH3-Z2	100430	9kHz~30MHz	Feb. 03, 2012	Conduction (CO01-CB)
COND Cable	Woken	Cable	01	0.15MHz~30MHz	Dec. 04, 2012	Conduction (CO01-CB)
Software	Audix	E3	5.410e	-	-	Conduction (CO01-CB)
BILOG ANTENNA	Schaffner	CBL6112D	22021	20MHz ~ 2GHz	Jan. 11, 2012	Radiation (03CH01-CB)
Horn Antenna	EMCO	3115	00075790	750MHz~18GHz	Nov. 27, 2012	Radiation (03CH01-CB)
Horn Antenna	SCHWARZBEAK	BBHA 9170	BBHA9170252	15GHz ~ 40GHz	Nov. 23, 2012	Radiation (03CH01-CB)
Pre-Amplifier	Agilent	8447D	2944A10991	0.1MHz ~ 1.3GHz	Nov. 27, 2012	Radiation (03CH01-CB)
Pre-Amplifier	Agilent	8449B	3008A02310	1GHz ~ 26.5GHz	Nov. 23, 2012	Radiation (03CH01-CB)
Pre-Amplifier	WM	TF-130N-R1	923365	26.5GHz ~ 40GHz	Jul. 31, 2012	Radiation (03CH01-CB)
Spectrum analyzer	R&S	FSP40	100056	9KHz~40GHz	Nov. 16, 2012	Radiation (03CH01-CB)
EMI Test Receiver	R&S	ESCS 30	100355	9KHz ~ 2.75GHz	Mar. 20, 2012	Radiation (03CH01-CB)
Turn Table	INN CO	CO 2000	N/A	0 ~ 360 degree	N.C.R	Radiation (03CH01-CB)
Antenna Mast	INN CO	CO2000	N/A	1 m - 4 m	N.C.R	Radiation (03CH01-CB)
RF Cable-low	Woken	Low Cable-1	N/A	30 MHz - 1 GHz	Nov. 18, 2012	Radiation (03CH01-CB)
RF Cable-high	Woken	High Cable-1	N/A	1 GHz – 26.5 GHz	Nov. 18, 2012	Radiation (03CH01-CB)
RF Cable-high	Woken	High Cable-2	N/A	1 GHz – 26.5 GHz	Nov. 18, 2012	Radiation (03CH01-CB)
RF Cable-high	Woken	High Cable-3	N/A	1 GHz - 40 GHz	Nov. 18, 2012	Radiation (03CH01-CB)
RF Cable-high	Woken	High Cable-4	N/A	1 GHz - 40 GHz	Nov. 18, 2012	Radiation (03CH01-CB)
Signal analyzer	R&S	FSV40	100979	9KHz~40GHz	Oct. 08, 2012	Conducted (TH01-CB)
Temp. and Humidity Chamber	Ten Billion	TTH-D3SP	TBN-931011	-30~100 degree	Jun. 05, 2012	Conducted (TH01-CB)
RF Power Divider	Woken	2 Way	0120A02056002D	2GHz ~ 18GHz	Nov. 18, 2012	Conducted (TH01-CB)
RF Power Divider	Woken	3 Way	MDC2366	2GHz ~ 18GHz	Nov. 18, 2012	Conducted (TH01-CB)
RF Power Divider	Woken	4 Way	0120A04056002D	2GHz ~ 18GHz	Nov. 18, 2012	Conducted (TH01-CB)

Instrument	Manufacturer	Model No.	Serial No.	Characteristics	Calibration Date	Remark
RF Cable-high	Woken	High Cable-7	-	1 GHz – 26.5 GHz	Nov. 19, 2012	Conducted (TH01-CB)
RF Cable-high	Woken	High Cable-8	-	1 GHz – 26.5 GHz	Nov. 19, 2012	Conducted (TH01-CB)
RF Cable-high	Woken	High Cable-9	-	1 GHz – 26.5 GHz	Nov. 19, 2012	Conducted (TH01-CB)
RF Cable-high	Woken	High Cable-10	-	1 GHz – 26.5 GHz	Nov. 19, 2012	Conducted (TH01-CB)
RF Cable-high	Woken	High Cable-11	-	1 GHz – 26.5 GHz	Nov. 19, 2012	Conducted (TH01-CB)
Power Sensor	Anritsu	MA2411B	0917223	300MHz~40GHz	Nov. 28, 2012	Conducted (TH01-CB)
Power Meter	Anritsu	ML2495A	1035008	300MHz~40GHz	Nov. 27, 2012	Conducted (TH01-CB)

Note: Calibration Interval of instruments listed above is one year.

NCR means Non-Calibration required.

6. TEST LOCATION

SHIJR	ADD : 6Fl., No. 106, Sec. 1, Shintai 5th Rd., Shijr City, Taipei, Taiwan 221, R.O.C. TEL : 886-2-2696-2468 FAX : 886-2-2696-2255
HWA YA	ADD : No. 52, Hwa Ya 1st Rd., Kwei-Shan Hsiang, Tao Yuan Hsien, Taiwan, R.O.C. TEL : 886-3-327-3456 FAX : 886-3-318-0055
LINKOU	ADD : No. 30-2, Dingfu Tsuen, Linkou Shiang, Taipei, Taiwan 244, R.O.C TEL : 886-2-2601-1640 FAX : 886-2-2601-1695
DUNGHU	ADD : No. 3, Lane 238, Kangle St., Neihu Chiu, Taipei, Taiwan 114, R.O.C. TEL : 886-2-2631-4739 FAX : 886-2-2631-9740
JUNGHE	ADD : 7Fl., No. 758, Jungjeng Rd., Junghe City, Taipei, Taiwan 235, R.O.C. TEL : 886-2-8227-2020 FAX : 886-2-8227-2626
NEIHU	ADD : 4Fl., No. 339, Hsin Hu 2 nd Rd., Taipei 114, Taiwan, R.O.C. TEL : 886-2-2794-8886 FAX : 886-2-2794-9777
JHUBEI	ADD : No.8, Lane 724, Bo-ai St., Jhubei City, HsinChu County 302, Taiwan, R.O.C. TEL : 886-3-656-9065 FAX : 886-3-656-9085