



FCC RF Test Report

APPLICANT : Zebra Technologies Corporation
EQUIPMENT : WLAN/BT module
BRAND NAME : Zebra
MODEL NAME : 21-148603-0B
FCC ID : UZ7211486030B
STANDARD : FCC Part 15 Subpart E §15.407
CLASSIFICATION : (NII) Unlicensed National Information Infrastructure

The product was received on Nov. 13, 2015 and testing was completed on Nov. 26, 2015. We, SPORTON INTERNATIONAL INC., would like to declare that the tested sample has been evaluated in accordance with the test procedures and has been in compliance with the applicable technical standards.

The test results in this report apply exclusively to the tested model / sample. Without written approval of SPORTON INTERNATIONAL INC., the test report shall not be reproduced except in full.

Reviewed by: Joseph Lin / Supervisor

Approved by: Jones Tsai / Manager



SPORTON INTERNATIONAL INC.

No. 52, Hwa Ya 1st Rd., Hwa Ya Technology Park, Kwei-Shan District, Tao Yuan City, Taiwan, R.O.C.



TABLE OF CONTENTS

REVISION HISTORY 3

SUMMARY OF TEST RESULT 4

1 GENERAL DESCRIPTION 5

 1.1 Applicant 5

 1.2 Manufacturer 5

 1.3 Product Feature of Equipment Under Test 5

 1.4 Product Specification of Equipment Under Test 6

 1.5 Modification of EUT 6

 1.6 Testing Location 7

 1.7 Applicable Standards 7

2 TEST CONFIGURATION OF EQUIPMENT UNDER TEST 8

 2.1 Carrier Frequency and Channel 8

 2.2 Pre-Scanned RF Power 9

 2.3 Test Mode 10

 2.4 Connection Diagram of Test System 11

 2.5 EUT Operation Test Setup 11

 2.6 Measurement Results Explanation Example 11

3 TEST RESULT 12

 3.1 6dB and 26dB and 99% Occupied Bandwidth Measurement 12

 3.2 Maximum Conducted Output Power Measurement 15

 3.3 Power Spectral Density Measurement 16

 3.4 Unwanted Emissions Measurement 19

 3.5 Frequency Stability Measurement 24

 3.6 Automatically Discontinue Transmission 25

 3.7 Antenna Requirements 26

4 LIST OF MEASURING EQUIPMENT 27

5 UNCERTAINTY OF EVALUATION 28

APPENDIX A. CONDUCTED TEST RESULTS

APPENDIX B. RADIATED SPURIOUS EMISSION

APPENDIX C. RADIATED SPURIOUS EMISSION PLOTS

APPENDIX D. SETUP PHOTOGRAPHS



REVISION HISTORY

REPORT NO.	VERSION	DESCRIPTION	ISSUED DATE
FR3N0602-02B	Rev. 01	Updating the FCC 15E standard to new rule.	Mar. 16, 2016



SUMMARY OF TEST RESULT

Report Section	FCC Rule	Description	Limit	Result	Remark
3.1	15.403(i)	6dB, 26dB and 99% Occupied Bandwidth	> 500kHz	Pass	-
3.2	15.407(a)	Maximum Conducted Output Power	≤ 30 dBm	Pass	-
3.3	15.407(a)	Power Spectral Density	≤ 30 dBm/500kHz	Pass	-
3.4	15.407(b)	Unwanted Emissions	≤ -17, -27 dBm/MHz & 15.209(a)	Pass	Under limit 1.06 dB at 5860.080 MHz
3.5	15.407(g)	Frequency Stability	Within Operation Band	Pass	-
3.6	15.407(c)	Automatically Discontinue Transmission	Discontinue Transmission	Pass	-
3.7	15.203 & 15.407(a)	Antenna Requirement	N/A	Pass	-



1 General Description

1.1 Applicant

Zebra Technologies Corporation
1 Zebra Plaza, Holtsville, NY 11742

1.2 Manufacturer

Zebra Technologies Corporation
1 Zebra Plaza, Holtsville, NY 11742

1.3 Product Feature of Equipment Under Test

Product Feature	
Equipment	WLAN/BT module
Brand Name	Zebra
Model Name	21-148603-0B
FCC ID	UZ7211486030B
EUT supports Radios application	WLAN 11a/n HT20 Bluetooth v2.1 EDR
Host HW Version	MV
Host SW Version	2.4.42930.0
Host FW Version	X_2.01.0.0.024R
MFD	11JUL15
EUT Stage	Identical Prototype

Remark: The above EUT's information was declared by manufacturer. Please refer to the specifications or user's manual for more detailed description.



1.4 Product Specification of Equipment Under Test

Standards-related Product Specification										
Tx/Rx Channel Frequency Range	5745 MHz ~ 5825 MHz									
Maximum Output Power	<p><5745 MHz ~ 5825 MHz> <Ant. 1> 802.11a : 15.48 dBm / 0.0353 W 802.11n HT20 : 15.04 dBm / 0.0319 W <Ant. 2> 802.11a : 15.19 dBm / 0.0330 W 802.11n HT20 : 14.53 dBm / 0.0284 W</p>									
99% Occupied Bandwidth	802.11a : 18.95 MHz 802.11n HT20 : 19.50 MHz									
Type of Modulation	802.11a/n : OFDM (BPSK / QPSK / 16QAM / 64QAM)									
Antenna Type	PIFA Antenna									
Antenna Gain	<Ant. 1> : 4.19 dBi <Ant. 2> : 4.19 dBi									
Antenna Function Description	<table border="1"> <thead> <tr> <th></th> <th>Ant. 1</th> <th>Ant. 2</th> </tr> </thead> <tbody> <tr> <td>802.11 a</td> <td>V</td> <td>V</td> </tr> <tr> <td>802.11 n</td> <td>V</td> <td>V</td> </tr> </tbody> </table>		Ant. 1	Ant. 2	802.11 a	V	V	802.11 n	V	V
	Ant. 1	Ant. 2								
802.11 a	V	V								
802.11 n	V	V								

1.5 Modification of EUT

No modifications are made to the EUT during all test items.



1.6 Testing Location

Sporton Lab is accredited to ISO 17025 by Taiwan Accreditation Foundation (TAF code : 1190) and the FCC designation No. TW1022 under the FCC 2.948(e) by Mutual Recognition Agreement (MRA) in FCC Test.

Test Site	SPORTON INTERNATIONAL INC.
Test Site Location	No. 52, Hwa Ya 1 st Rd., Hwa Ya Technology Park, Kwei-Shan District, Tao Yuan City, Taiwan, R.O.C. TEL: +886-3-327-3456 FAX: +886-3-328-4978
Test Site No.	Sporton Site No.
	TH02-HY

Note: The test site complies with ANSI C63.4 2014 requirement.

Test Site	SPORTON INTERNATIONAL INC.
Test Site Location	No.58, Aly. 75, Ln. 564, Wenhua 3rd Rd. Guishan Dist, Taoyuan City, Taiwan (R.O.C.) TEL: +886-3-327-0868 FAX: +886-3-327-0855
Test Site No.	Sporton Site No.
	03CH10-HY

Note: The test site complies with ANSI C63.4 2014 requirement.

1.7 Applicable Standards

According to the specifications of the manufacturer, the EUT must comply with the requirements of the following standards:

- ♦ FCC Part 15 Subpart E
- ♦ FCC KDB 789033 D02 General UNII Test Procedures New Rules v01r01
- ♦ ANSI C63.10-2013

Remark: All test items were verified and recorded according to the standards and without any deviation during the test.



2 Test Configuration of Equipment Under Test

The EUT has been associated with peripherals and configuration operated in a manner tended to maximize its emission characteristics in a typical application. Frequency range investigated: conducted emission (150 kHz to 30 MHz) and radiated emission (9 kHz to the 10th harmonic of the highest fundamental frequency or to 40 GHz, whichever is lower). For radiated measurement, pre-scanned in three orthogonal panels, X, Y, Z. The worst cases (X plane) were recorded in this report.

The final configuration from all the combinations and the worst-case data rates were investigated by measuring the maximum power across all the data rates and modulation modes under section 2.2.

Based on the worst configuration found above, the RF power setting is set individually to meet FCC compliance limit for the final conducted and radiated tests shown in section 2.3.

2.1 Carrier Frequency and Channel

Frequency Band	Channel	Freq. (MHz)	Channel	Freq. (MHz)
5725-5850 MHz Band 4 (U-NII-3)	149	5745	157	5785
	151	5755	159	5795
	153	5765	161	5805
	155	5775	165	5825



2.2 Pre-Scanned RF Power

Preliminary tests were performed in different data rate and data rate associated with the highest power were chosen for full test in the following tables.

<Ant. 1>

5GHz 802.11a mode									
Channel	Frequency	Data Rate (MHz)							
		6M bps	9M bps	12M bps	18M bps	24M bps	36M bps	48M bps	54M bps
CH 149	5745 MHz	13.00	12.99	12.88	12.95	12.91	12.93	12.89	12.88
CH 157	5785 MHz	15.48	15.28	15.26	15.28	15.27	15.28	15.39	15.41
CH 165	5825 MHz	14.81	14.80	14.75	14.74	14.71	14.75	14.73	14.51

5GHz 802.11n HT20 mode									
Channel	Frequency	Data Rate (MHz)							
		MCS0	MCS1	MCS2	MCS3	MCS4	MCS5	MCS6	MCS7
CH 149	5745 MHz	12.48	12.35	12.39	12.37	12.37	12.48	12.42	12.42
CH 157	5785 MHz	15.04	14.99	14.92	14.90	14.85	14.93	14.90	14.87
CH 165	5825 MHz	14.27	14.22	14.19	14.05	14.04	14.02	14.01	13.90

<Ant. 2>

5GHz 802.11a mode									
Channel	Frequency	Data Rate (MHz)							
		6M bps	9M bps	12M bps	18M bps	24M bps	36M bps	48M bps	54M bps
CH 149	5745 MHz	12.62	12.53	12.49	12.51	12.47	12.53	12.58	12.57
CH 157	5785 MHz	15.19	15.17	15.18	15.16	15.13	15.13	15.13	15.06
CH 165	5825 MHz	14.25	14.23	14.23	14.20	14.23	14.19	14.19	14.17

5GHz 802.11n HT20 mode									
Channel	Frequency	Data Rate (MHz)							
		MCS0	MCS1	MCS2	MCS3	MCS4	MCS5	MCS6	MCS7
CH 149	5745 MHz	12.08	12.01	12.04	11.98	11.88	11.94	11.90	11.76
CH 157	5785 MHz	14.53	14.42	14.41	14.33	14.21	14.20	14.08	14.03
CH 165	5825 MHz	13.91	13.82	13.82	13.78	13.67	13.67	13.62	13.64



2.3 Test Mode

Final test mode of conducted test items and radiated spurious emissions are considering the modulation and worse data rates from the power table described in section 2.2.

Modulation	Data Rate
802.11a	6 Mbps
802.11n HT20	MCS0

Ch. #		Band IV : 5725-5850 MHz	
		802.11a	802.11n HT20
L	Low	149	149
M	Middle	157	157
H	High	165	165

2.4 Connection Diagram of Test System

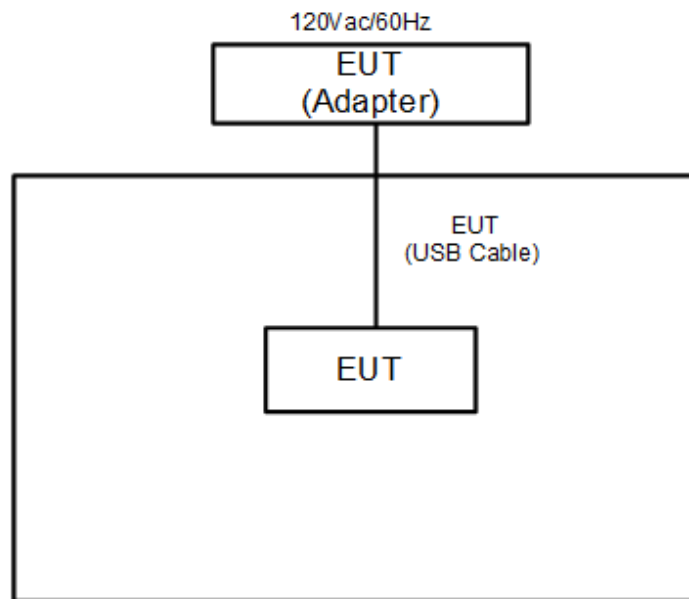

2.5 EUT Operation Test Setup

The programmed RF utility "XW2DMT", is installed in EUT to provide channel selection, power level, data rate and the application type. RF Utility can send transmitting signal for all testing. The RF output power selection is for the setting of RF output power expected by the customer and is going to be fixed on the firmware of the final end product.

2.6 Measurement Results Explanation Example

For all conducted test items:

The offset level is set in the spectrum analyzer to compensate the RF cable loss and attenuator factor between EUT conducted output port and spectrum analyzer. With the offset compensation, the spectrum analyzer reading level is exactly the EUT RF output level.

Example :

The spectrum analyzer offset is derived from RF cable loss and attenuator factor.

Offset = RF cable loss + attenuator factor.

Following shows an offset computation example with cable loss 4.2 dB and 10dB attenuator.

$$\begin{aligned} \text{Offset(dB)} &= \text{RF cable loss(dB)} + \text{attenuator factor(dB)}. \\ &= 4.2 + 10 = 14.2 \text{ (dB)} \end{aligned}$$

3 Test Result

3.1 6dB and 26dB and 99% Occupied Bandwidth Measurement

3.1.1 Description of 6dB and 26dB and 99% Occupied Bandwidth

The minimum 6 dB bandwidth shall be at least 500 kHz.

26dB and 99% Occupied bandwidth are reporting only.

3.1.2 Measuring Instruments

The measuring equipment is listed in the section 4 of this test report.

3.1.3 Test Procedures

1. The testing follows FCC KDB 789033 D02 General UNII Test Procedures New Rules v01r01.
Section C) Emission bandwidth for the band 5.725-5.85GHz
2. Set RBW = 100kHz.
3. Set the VBW $\geq 3 \times$ RBW.
4. Detector = Peak.
5. Trace mode = max hold
6. Measure the maximum width of the emission that is 6 dB down from the peak of the emission.
7. Measure and record the results in the test report.

3.1.4 Test Setup

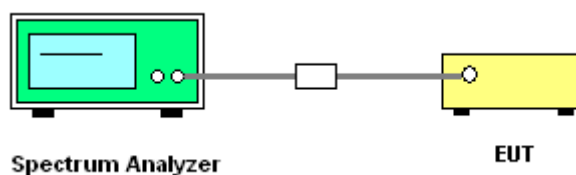



3.1.5 Test Result of 6dB Bandwidth

Please refer to Appendix A.

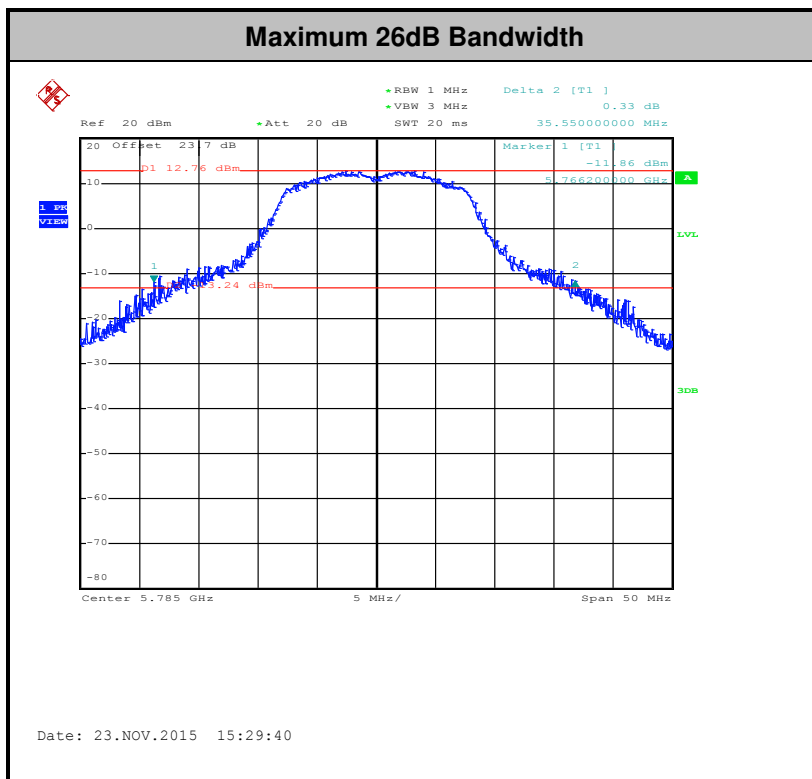
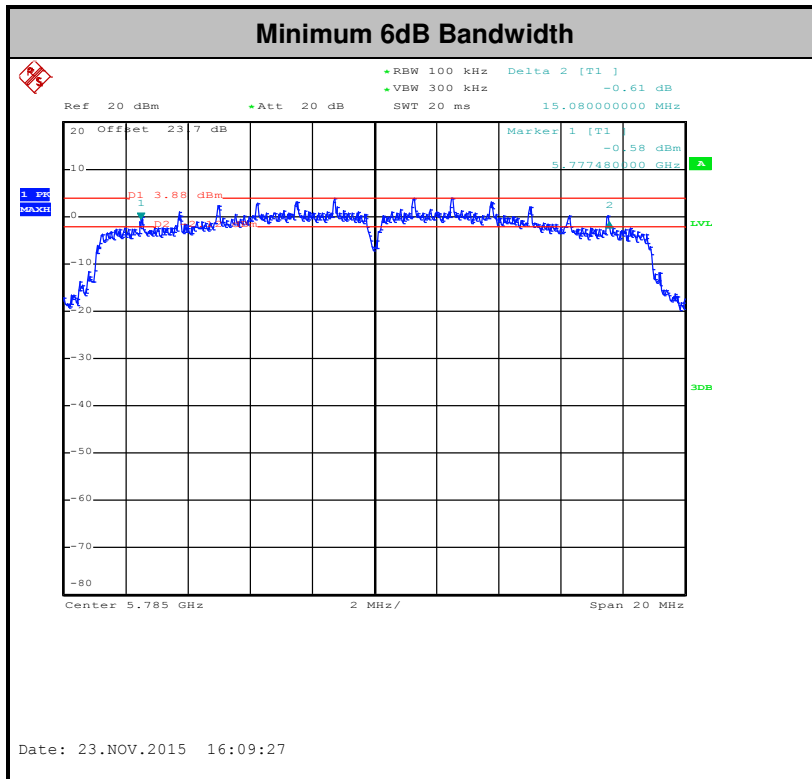

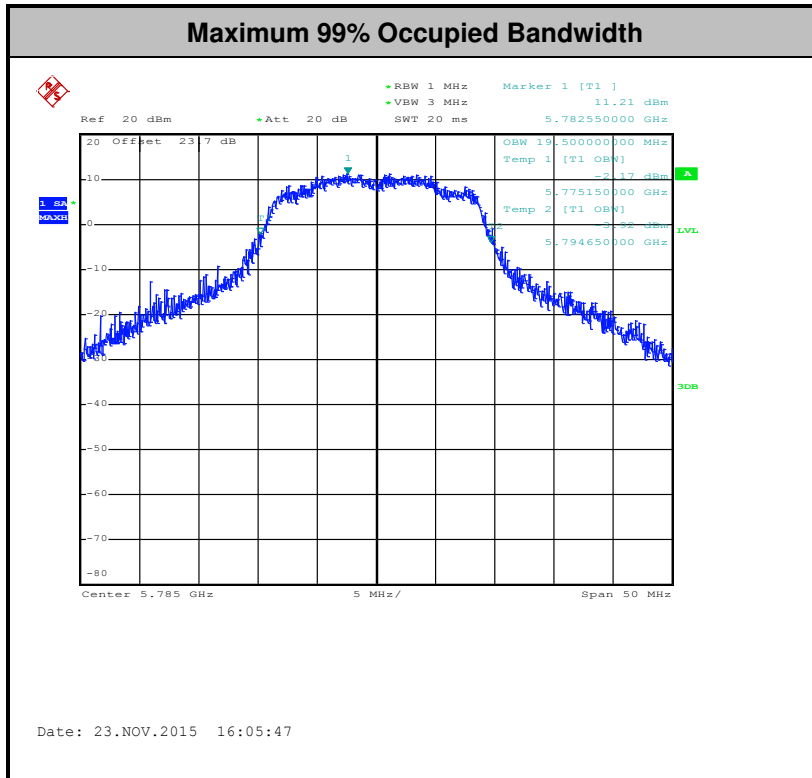

Note: The occupied channel bandwidth is maintained within the band of operation for all of the modulations.

3.2 Maximum Conducted Output Power Measurement

3.2.1 Limit of Maximum Conducted Output Power

For the band 5.725–5.85 GHz, the maximum conducted output power over the frequency band of operation shall not exceed 1 W.

If transmitting antennas of directional gain greater than 6 dBi are used, the peak output power shall be reduced by the amount in dB that the directional gain of the antenna exceeds 6 dBi.

3.2.2 Measuring Instruments

The measuring equipment is listed in the section 4 of this test report.

3.2.3 Test Procedures

The testing follows Method PM of FCC KDB 789033 D02 General UNII Test Procedures New Rules v01r01.

Method PM (Measurement using an RF average power meter):

1. Measurement is performed using a wideband RF power meter.
2. The EUT is configured to transmit continuously with a consistent duty cycle at its maximum power control level.
3. Measure the average power of the transmitter, and the average power is corrected with duty factor, $10 \log(1/x)$, where x is the duty cycle.

3.2.4 Test Setup

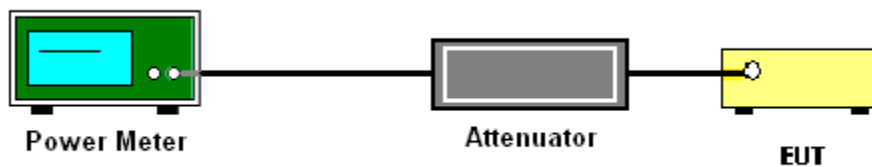

3.2.5 Test Result of Maximum Conducted Output Power

Please refer to Appendix A.



3.3 Power Spectral Density Measurement

3.3.1 Limit of Power Spectral Density

For the band 5.725–5.85 GHz, the maximum power spectral density shall not exceed 30 dBm in any 500-kHz band.

If transmitting antennas of directional gain greater than 6 dBi are used, the peak output power shall be reduced by the amount in dB that the directional gain of the antenna exceeds 6 dBi.

3.3.2 Measuring Instruments

The measuring equipment is listed in the section 4 of this test report.

3.3.3 Test Procedures

The testing follows FCC KDB 789033 D02 General UNII Test Procedures New Rules v01r01.
Section F) Maximum power spectral density.

Method SA-2

(trace averaging across on and off times of the EUT transmissions, followed by duty cycle correction).

1. The testing follows Method SA-2 of FCC KDB 789033 D02 General UNII Test Procedures New Rules v01r01.
 - Measure the duty cycle.
 - Set span to encompass the entire emission bandwidth (EBW) of the signal.
 - Set RBW = 300 kHz.
 - Set VBW \geq 1 MHz.
 - Number of points in sweep \geq 2 Span / RBW.
 - Sweep time = auto.
 - Detector = RMS
 - Trace average at least 100 traces in power averaging mode.
 - Add $10 \log(500\text{kHz}/\text{RBW})$ to the test result.
 - Add $10 \log(1/x)$, where x is the duty cycle, to the measured power in order to compute the average power during the actual transmission times. For example, add $10 \log(1/0.25) = 6$ dB if the duty cycle is 25 percent.
2. The RF output of EUT was connected to the spectrum analyzer by a low loss cable.
3. Each plot has already offset with cable loss, and attenuator loss. Measure the PPSD and record it.

3.3.4 Test Setup

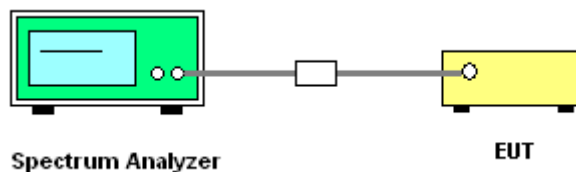



3.3.5 Test Result of Power Spectral Density

Please refer to Appendix A.

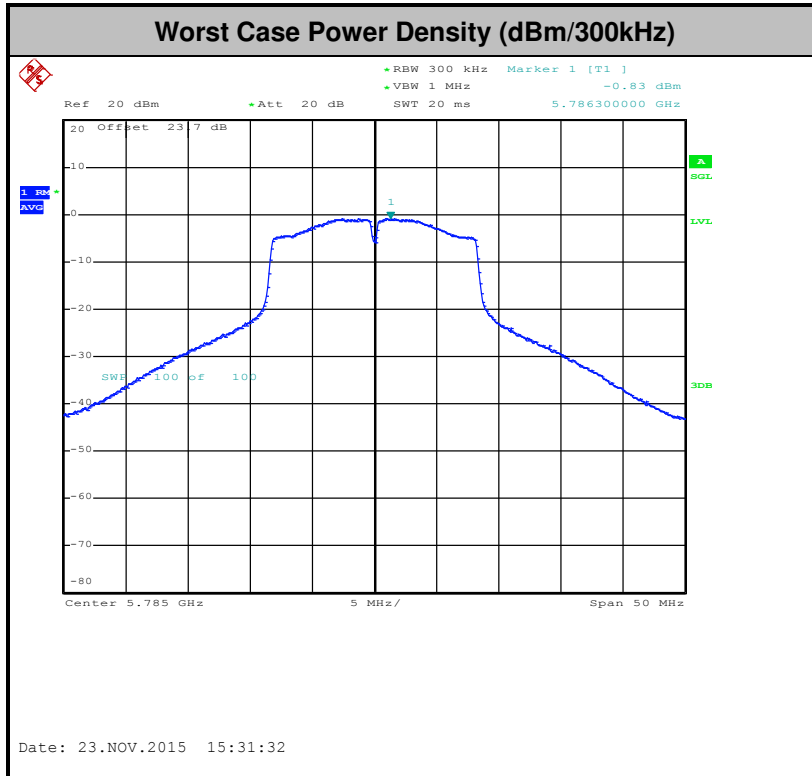



3.4 Unwanted Emissions Measurement

This section as specified in FCC Part 15.407(b) is to measure unwanted emissions through radiated measurement for band edge spurious emissions and out of band emissions measurement. The unwanted emissions shall comply with 15.407(b)(1) to (6), and restricted bands per FCC Part15.205.

3.4.1 Limit of Unwanted Emissions

- (1) For transmitters operating in the 5725-5850 MHz band: all emissions within the frequency range from the band edge to 10 MHz above or below the band edge shall not exceed an EIRP of -17 dBm/MHz (78.3dBµV/m); for frequencies 10 MHz or greater above or below the band edge, emissions shall not exceed an EIRP of -27 dBm/MHz (68.3dBµV/m).
- (2) Unwanted spurious emissions fallen in restricted bands per FCC Part15.205 shall comply with the general field strength limits set forth in § 15.209 as below table,

Frequency (MHz)	Field Strength (microvolts/meter)	Measurement Distance (meters)
0.009 – 0.490	2400/F(kHz)	300
0.490 – 1.705	24000/F(kHz)	30
1.705 – 30.0	30	30
30 – 88	100	3
88 – 216	150	3
216 - 960	200	3
Above 960	500	3

Note: The following formula is used to convert the EIRP to field strength.

$$E = \frac{1000000\sqrt{30P}}{3} \mu\text{V/m, where P is the eirp (Watts)}$$

EIRP (dBm)	Field Strength at 3m (dBµV/m)
-17	78.3
-27	68.3

- (3) KDB 789033 D02 General UNII Test Procedures New Rules v01r01 G)2)c) As specified in 15.407(b), emissions above 1000 MHz that are outside of the restricted bands are subject to a peak emission limit of -27 dBm/MHz (or -17 dBm/MHz as specified in 15.407(b)(4)). However, an out-of-band emission that complies with both the average and peak limits of 15.209 is not required to satisfy the -27 dBm/MHz or -17 dBm/MHz peak emission limit.



3.4.2 Measuring Instruments

The measuring equipment is listed in the section 4 of this test report.

3.4.3 Test Procedures

1. The testing follows FCC KDB 789033 D02 General UNII Test Procedures New Rules v01r01. Section G) Unwanted emissions measurement.

(1) Procedure for Unwanted Emissions Measurements Below 1000MHz

- RBW = 120 kHz
- VBW = 300 kHz
- Detector = Peak
- Trace mode = max hold

(2) Procedure for Peak Unwanted Emissions Measurements Above 1000 MHz

- RBW = 1 MHz
- VBW ≥ 3 MHz
- Detector = Peak
- Sweep time = auto
- Trace mode = max hold

(3) Procedures for Average Unwanted Emissions Measurements Above 1000MHz

- RBW = 1 MHz
- VBW = 10 Hz, when duty cycle is no less than 98 percent.
- $VBW \geq 1/T$, when duty cycle is less than 98 percent where T is the minimum transmission duration over which the transmitter is on and is transmitting at its maximum power control level for the tested mode of operation.

Antenna	Band	Duty Cycle(%)	T(us)	1/T(kHz)	VBW Setting
0	802.11a	98.57	-	-	10Hz
0	5GHz 802.11n HT20	97.18	2760	0.36	1kHz
1	802.11a	98.57	-	-	10Hz
1	5GHz 802.11n HT20	97.18	2760	0.36	1kHz



2. The EUT was placed on a turntable with 0.8 meter for frequency below 1GHz and 1.5 meter for frequency above 1GHz respectively above ground.
3. The EUT was set 3 meters from the interference receiving antenna which was mounted on the top of a variable height antenna tower.
4. The antenna is a broadband antenna and its height is adjusted between one meter and four meters above ground to find the maximum value of the field strength for both horizontal polarization and vertical polarization of the antenna.
5. For each suspected emission, the EUT was arranged to its worst case and then adjust the antenna tower (from 1 m to 4 m) and turntable (from 0 degree to 360 degrees) to find the maximum reading.
6. For testing below 1GHz, if the emission level of the EUT in peak mode was 3 dB lower than the limit specified, then peak values of EUT will be reported, otherwise, the emissions will be repeated one by one using the CISPR quasi-peak method and reported.
7. For testing above 1GHz, the emission level of the EUT in peak mode was 20dB lower than average limit (that means the emission level in average mode also complies with the limit in average mode), then peak values of EUT will be reported, otherwise, the emissions will be measured in average mode again and reported.

3.4.4 Test Setup

For radiated emissions below 30MHz

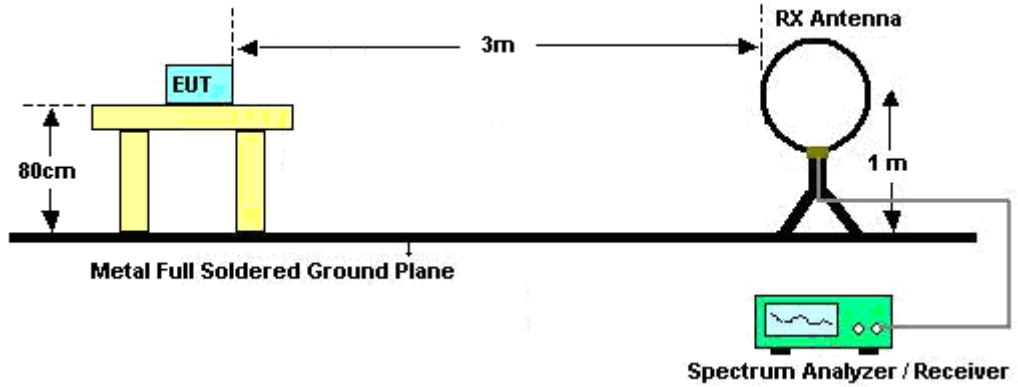

For radiated emissions from 30MHz to 1GHz

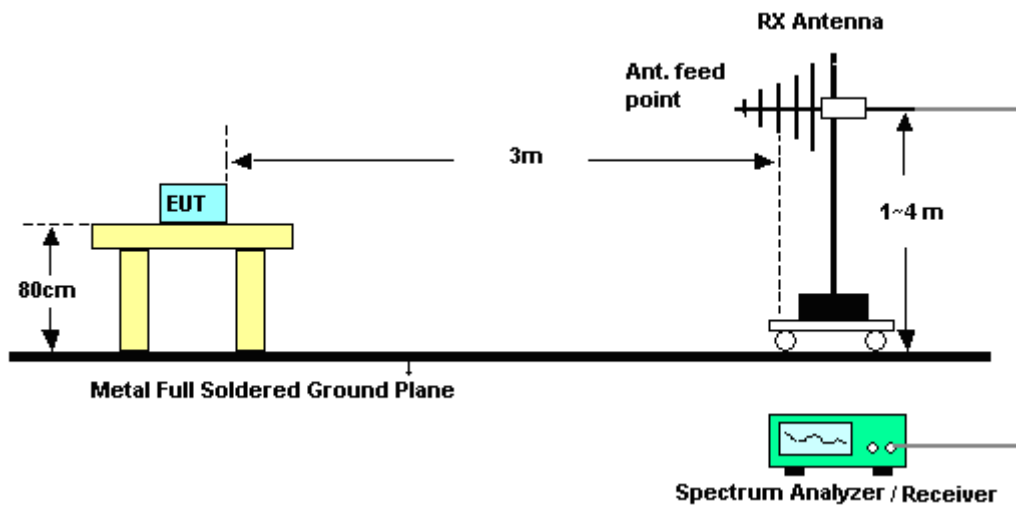

For radiated emissions above 1GHz

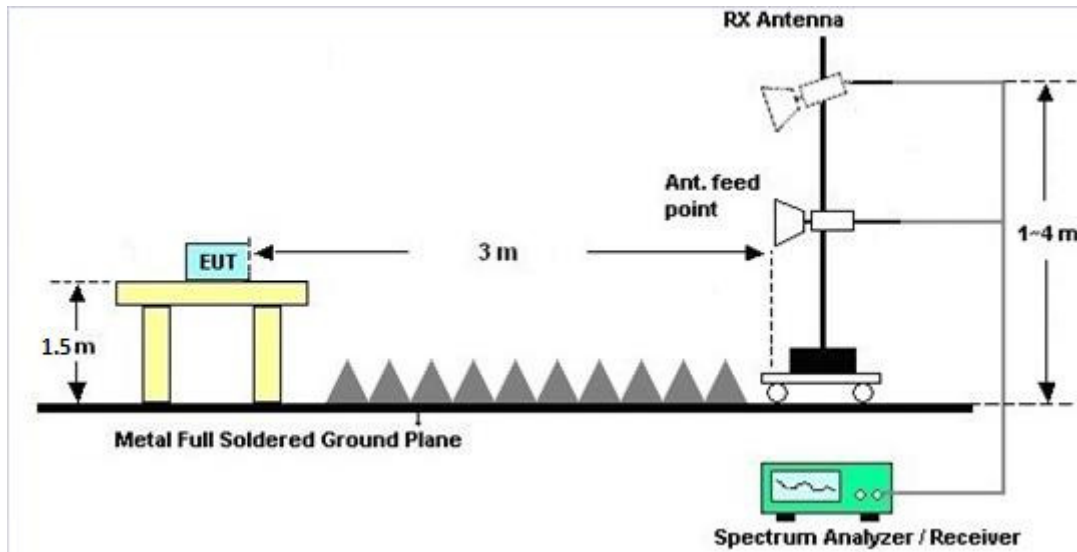

3.4.5 Test Results of Radiated Emissions (9 kHz ~ 30 MHz)

The low frequency, which started from 9 kHz to 30MHz, was pre-scanned and the result which was 20dB lower than the limit line per 15.31(o) was not reported.

3.4.6 Test Result of Radiated Band Edges

Please refer to Appendix A.

3.4.7 Test Result of Unwanted Radiated Emission (30MHz ~ 10th Harmonic)

Please refer to Appendix A.

3.5 Frequency Stability Measurement

3.5.1 Limit of Frequency Stability

Manufacturers of U-NII devices are responsible for ensuring frequency stability such that an emission is maintained within the band of operation under all conditions of normal operation as specified in the user's manual.

3.5.2 Measuring Instruments

The measuring equipment is listed in the section 4 of this test report.

3.5.3 Test Procedures

1. To ensure emission at the band edge is maintained within the authorized band, those values shall be measured by radiation emissions at upper and lower frequency points, and finally compensated by frequency deviation as procedures below.
2. The EUT was operated at the maximum output power, and connected to the spectrum analyzer, which is set to maximum hold function and peak detector. The peak value of the power envelope was measured and noted. The upper and lower frequency points were respectively measured relatively 10dB lower than the measured peak value.
3. The frequency deviation was calculated by adding the upper frequency point and the lower frequency point divided by two. Those detailed values of frequency deviation are provided in table below.

3.5.4 Test Setup



3.5.5 Test Result of Frequency Stability

Please refer to Appendix A.



3.6 Automatically Discontinue Transmission

3.6.1 Limit of Automatically Discontinue Transmission

The device shall automatically discontinue transmission in case of either absence of information to transmit or operational failure. These provisions are not intended to preclude the transmission of control or signaling information or the use of repetitive codes used by certain digital technologies to complete frame or burst intervals. Applicants shall include in their application for equipment authorization to describe how this requirement is met.

3.6.2 Measuring Instruments

The measuring equipment is listed in the section 4 of this test report.

3.6.3 Test Result of Automatically Discontinue Transmission

While the EUT is not transmitting any information, the EUT can automatically discontinue transmission and become standby mode for power saving. The EUT can detect the controlling signal of ACK message transmitting from remote device and verify whether it shall resend or discontinue transmission.



3.7 Antenna Requirements

3.7.1 Standard Applicable

According to FCC 47 CFR Section 15.407(a)(1)(2) ,if transmitting antenna directional gain is greater than 6 dBi, both the peak transmit power and the peak power spectral density shall be reduced by the amount in dB that the directional gain of the antenna exceeds 6 dBi.

3.7.2 Antenna Anti-Replacement Construction

An embedded-in antenna design is used.

3.7.3 Antenna Gain

FCC KDB 662911 D01 Multiple Transmitter Output v02r01

For CDD transmissions, directional gain is calculated as

Directional gain = $G_{ANT} + \text{Array Gain}$, where Array Gain is as follows.

For power spectral density (PSD) measurements on all devices,

Array Gain = $10 \log(N_{ANT}/N_{SS}=1)$ dB.

For power measurements on IEEE 802.11 devices,

Array Gain = 0 dB (i.e., no array gain) for $N_{ANT} \leq 4$.

The power and PSD limit should be modified if the directional gain of EUT is over 6 dBi,

The directional gain "DG" is calculated as following table.

			DG	DG	Power	PSD
			for	for	Limit	Limit
	Ant 1	Ant 2	Power	PSD	Reduction	Reduction
	(dBi)	(dBi)	(dBi)	(dBi)	(dB)	(dB)
Band IV	4.47	4.47	4.47	7.48	0.00	1.48

Power limit reduction = Composite gain – 6dBi, (min = 0)

PSD limit reduction = Composite gain + PSD Array gain – 6dBi, (min = 0)



4 List of Measuring Equipment

Instrument	Manufacturer	Model No.	Serial No.	Characteristics	Calibration Date	Test Date	Due Date	Remark
DC Power Supply	TOPWARD	3303D	740889	N/A	May. 27, 2015	Nov. 24, 2015~ Nov. 25, 2015	May. 26, 2016	Conducted (TH02-HY)
Power Meter	Agilent	E4416A	GB41292344	300MHz~40GHz	Jan. 14, 2015	Nov. 24, 2015~ Nov. 25, 2015	Jan. 13, 2016	Conducted (TH02-HY)
Power Sensor	Agilent	E9327A	US40441548	300MHz~40GHz	Jan. 14, 2015	Nov. 24, 2015~ Nov. 25, 2015	Jan. 13, 2016	Conducted (TH02-HY)
Spectrum Analyzer	Rohde & Schwarz	FSP40	100055	9kHz~40GHz	Jun. 18, 2015	Nov. 24, 2015~ Nov. 25, 2015	Jun. 17, 2016	Conducted (TH02-HY)
Loop Antenna	Rohde & Schwarz	HFH2-Z2	100315	9 kHz~30 MHz	Sep. 02, 2015	Nov. 13, 2015~ Nov. 26, 2015	Sep. 01, 2016	Radiation (03CH10-HY)
Bilog Antenna	TESEQ	CBL 6111D	35413	30MHz~1GHz	Oct. 31, 2015	Nov. 13, 2015~ Nov. 26, 2015	Oct. 30, 2016	Radiation (03CH10-HY)
EMI Test Receiver	Keysight	N9038A(MXE)	MY54130085	20Hz ~ 8.4GHz	Nov. 04, 2015	Nov. 13, 2015~ Nov. 26, 2015	Nov. 03, 2016	Radiation (03CH10-HY)
Horn Antenna	SCHWARZBECK	BBHA 9120 D	9120D-1325	1GHz ~ 18GHz	Sep. 30, 2015	Nov. 13, 2015~ Nov. 26, 2015	Sep. 29, 2016	Radiation (03CH10-HY)
Preamplifier	Keysight	83017A	MY53270078	1GHz~26.5GHz	Nov. 13, 2015	Nov. 13, 2015~ Nov. 26, 2015	Nov. 12, 2016	Radiation (03CH10-HY)
Spectrum Analyzer	Keysight	N9010A	MY54200485	10Hz ~ 44GHZ	Oct. 15, 2015	Nov. 13, 2015~ Nov. 26, 2015	Oct. 14, 2016	Radiation (03CH10-HY)
Controller	EMEC	EM 1000	N/A	Control Turn table & Ant Mast	N/A	Nov. 13, 2015~ Nov. 26, 2015	N/A	Radiation (03CH10-HY)
Antenna Mast	EMEC	AM-BS-4500-B	N/A	1~4m	N/A	Nov. 13, 2015~ Nov. 26, 2015	N/A	Radiation (03CH10-HY)
Turn Table	EMEC	TT 2200	N/A	0-360 degree	N/A	Nov. 13, 2015~ Nov. 26, 2015	N/A	Radiation (03CH10-HY)
Preamplifier	MITEQ	AMF-7D-0010 1800-30-10P	1902247	1GHz~18GHz	Jul. 01, 2015	Nov. 13, 2015~ Nov. 26, 2015	Jun. 30, 2016	Radiation (03CH10-HY)
Amplifier	Sonoma-Instrument	310 N	187282	10MHz~1GHz	Jan. 14, 2015	Nov. 13, 2015~ Nov. 26, 2015	Jan. 13, 2016	Radiation (03CH10-HY)
Horn Antenna	SCHWARZBECK	BBHA 9170	BBHA9170584	18GHz- 40GHz	Nov. 02, 2015	Nov. 13, 2015~ Nov. 26, 2015	Nov. 01, 2016	Radiation (03CH10-HY)
Preamplifier	MITEQ	JS44-1800400 0-33-8P	1840917	18GHz ~ 40GHz	Jun. 02, 2015	Nov. 13, 2015~ Nov. 26, 2015	Jun. 01, 2016	Radiation (03CH10-HY)



5 Uncertainty of Evaluation

Uncertainty of Conducted Emission Measurement (150kHz ~ 30MHz)

Measuring Uncertainty for a Level of Confidence of 95% ($U = 2Uc(y)$)	2.26
---	------

Uncertainty of Radiated Emission Measurement (30 MHz ~ 1000 MHz)

Measuring Uncertainty for a Level of Confidence of 95% ($U = 2Uc(y)$)	4.90
---	------



Appendix A. Conducted Test Results

Test Engineer:	AC CHANG	Temperature:	21~25	°C
Test Date:	104/11/23	Relative Humidity:	51~54	%

TEST RESULTS DATA
6dB and 26dB EBW and 99% OBW

Band IV													
Mod.	Data Rate	NTX	CH.	Freq. (MHz)	99% Bandwidth (MHz)		26dB Bandwidth (MHz)		6 dB Bandwidth (MHz)		6 dB Bandwidth Min. Limit (MHz)		Pass/Fail
					Ant 1	Ant 2	Ant 1	Ant 2	Ant 1	Ant 2	Ant 1	Ant 2	
11a	6Mbps	1	149	5745	17.95		28.25		15.62		0.5	0.5	Pass
11a	6Mbps	1	157	5785	18.95		35.55		15.10		0.5	0.5	Pass
11a	6Mbps	1	165	5825	18.20		33.05		15.14		0.5	0.5	Pass
HT20	MCS0	1	149	5745	18.80		27.90		15.12		0.5	0.5	Pass
HT20	MCS0	1	157	5785	19.50		35.35		15.08		0.5	0.5	Pass
HT20	MCS0	1	165	5825	19.45		33.75		15.14		0.5	0.5	Pass

TEST RESULTS DATA
Average Power Table

Band IV														
Mod.	Data Rate	NTX	CH.	Freq. (MHz)	Duty Factor (dB)		Average Conducted Power (dBm)			FCC Conducted Power Limit (dBm)		DG (dBi)		Pass/Fail
					Ant 1	Ant 2	Ant 1	Ant 2	SUM	Ant 1	Ant 2	Ant 1	Ant 2	
11a	6Mbps	1	149	5745	0.06	0.06	13.00	12.62		30.00	30.00	4.47	4.47	Pass
11a	6Mbps	1	157	5785	0.06	0.06	15.48	15.19		30.00	30.00	4.47	4.47	Pass
11a	6Mbps	1	165	5825	0.06	0.06	14.81	14.25		30.00	30.00	4.47	4.47	Pass
HT20	MCS0	1	149	5745	0.12	0.12	19.68	12.48		30.00	30.00	4.47	4.47	Pass
HT20	MCS0	1	157	5785	0.12	0.12	20.07	15.04		30.00	30.00	4.47	4.47	Pass
HT20	MCS0	1	165	5825	0.12	0.12	20.01	14.27		30.00	30.00	4.47	4.47	Pass

TEST RESULTS DATA
Power Spectral Density

Band IV																
Mod.	Data Rate	NTX	CH.	Freq. (MHz)	Duty Factor (dB)		10log (500kHz /RBW) Factor (dB)		Average Power Density (dBm/500kHz)			Average PSD Limit (dBm/500kHz)		DG (dBi)		Pass /Fail
					Ant 1	Ant 2	Ant 1	Ant 2	Ant 1	Ant 2	SUM	Ant 1	Ant 2	Ant 1	Ant 2	
11a	6Mbps	1	149	5745	0.06	0.06	2.22	2.22	-1.38			30.00	30.00	4.47	4.47	Pass
11a	6Mbps	1	157	5785	0.06	0.06	2.22	2.22	1.45			30.00	30.00	4.47	4.47	Pass
11a	6Mbps	1	165	5825	0.06	0.06	2.22	2.22	0.39			30.00	30.00	4.47	4.47	Pass
HT20	MCS0	1	149	5745	0.12	0.12	2.22	2.22	-2.05			30.00	30.00	4.47	4.47	Pass
HT20	MCS0	1	157	5785	0.12	0.12	2.22	2.22	0.44			30.00	30.00	4.47	4.47	Pass
HT20	MCS0	1	165	5825	0.12	0.12	2.22	2.22	-0.44			30.00	30.00	4.47	4.47	Pass

TEST RESULTS DATA
Frequency Stability

Band IV										
Mod.	Data Rate	NTX	CH.	Freq. (MHz)	Center Frequency (MHz)	Frequency Deviation (MHz)	Frequency Stability (ppm)	Temperature (°C)	Voltage (V)	Note
11a	6Mbps	1	149	5745	5745.000	0.000	0.00	20	3.4	
11a	6Mbps	1	149	5745	5745.000	0.000	0.00	20	4.2	
11a	6Mbps	1	149	5745	5744.975	-0.025	-4.35	20	3.7	
11a	6Mbps	1	149	5745	5745.000	0.000	0.00	-30	3.7	
11a	6Mbps	1	149	5745	5745.025	0.025	4.35	50	3.7	



Appendix B. Radiated Spurious Emission

Test Engineer :	Tsung Lee, Stan Hsieh and Ray Lee	Temperature :	23~25°C
		Relative Humidity :	45~48%

Band 4 - 5725~5850MHz

WIFI 802.11a (Band Edge @ 3m)

WIFI Ant. 1	Note	Frequency (MHz)	Level (dBμV/m)	Over Limit (dB)	Limit Line (dBμV/m)	Read Level (dBμV)	Antenna Factor (dB/m)	Cable Loss (dB)	Preamp Factor (dB)	Ant Pos (cm)	Table Pos (deg)	Peak Avg. (P/A)	Pol. (H/V)	
802.11a CH 149 5745MHz		5712.92	64.39	-9.61	74	55.64	32.52	8.3	32.07	100	134	P	H	
		5725	71.01	-7.29	78.3	62.22	32.53	8.33	32.07	100	134	P	H	
		5715	52.71	-1.29	54	43.96	32.52	8.3	32.07	100	134	A	H	
	*	5743	111.8	-	-	102.99	32.54	8.33	32.06	100	134	P	H	
	*	5743	105.19	-	-	96.38	32.54	8.33	32.06	100	134	A	H	
														H
														H
														H
			5714.76	54.91	-19.09	74	46.16	32.52	8.3	32.07	100	134	P	V
			5724.2	66.43	-11.87	78.3	57.64	32.53	8.33	32.07	100	134	P	V
			5715	46.5	-7.5	54	37.75	32.52	8.3	32.07	100	43	A	V
	*		5747	104.76	-	-	95.95	32.54	8.33	32.06	100	43	P	V
	*		5747	98.17	-	-	89.36	32.54	8.33	32.06	100	43	A	V
														V
														V
														V



WIFI Ant. 1	Note	Frequency (MHz)	Level (dBμV/m)	Over Limit (dB)	Limit Line (dBμV/m)	Read Level (dBμV)	Antenna Factor (dB/m)	Cable Loss (dB)	Preamp Factor (dB)	Ant Pos (cm)	Table Pos (deg)	Peak Avg. (P/A)	Pol. (H/V)
802.11a CH 157 5785MHz		5714.92	56.67	-17.33	74	47.92	32.52	8.3	32.07	100	137	P	H
		5724.2	58.42	-19.88	78.3	49.63	32.53	8.33	32.07	100	137	P	H
		5714.92	48	-6	54	39.25	32.52	8.3	32.07	100	137	A	H
	*	5784	114.61	-	-	105.74	32.57	8.35	32.05	100	137	P	H
	*	5784	107.51	-	-	98.64	32.57	8.35	32.05	100	137	A	H
		5852.8	55.23	-23.07	78.3	46.22	32.61	8.43	32.03	100	137	P	H
		5862.16	54.03	-19.97	74	45	32.62	8.43	32.02	100	137	P	H
		5860.08	45.7	-8.3	54	36.67	32.62	8.43	32.02	100	137	A	H
		5710.92	50.64	-23.36	74	41.89	32.52	8.3	32.07	100	81	P	V
		5718.28	54.14	-24.16	78.3	45.38	32.53	8.3	32.07	100	81	P	V
		5714.92	42.73	-11.27	54	33.98	32.52	8.3	32.07	100	81	A	V
	*	5787	107.52	-	-	98.64	32.58	8.35	32.05	100	81	P	V
	*	5787	100.42	-	-	91.54	32.58	8.35	32.05	100	81	A	V
		5852.48	51.69	-26.61	78.3	42.68	32.61	8.43	32.03	100	81	P	V
		5868	51.65	-22.35	74	42.62	32.62	8.43	32.02	100	81	P	V
		5860.32	43.03	-10.97	54	34	32.62	8.43	32.02	100	81	A	V



WiFi Ant. 1	Note	Frequency (MHz)	Level (dBμV/m)	Over Limit (dB)	Limit Line (dBμV/m)	Read Level (dBμV)	Antenna Factor (dB/m)	Cable Loss (dB)	Preamp Factor (dB)	Ant Pos (cm)	Table Pos (deg)	Peak Avg. (P/A)	Pol. (H/V)	
802.11a CH 165 5825MHz	*	5823	111.98	-	-	103.03	32.6	8.39	32.04	246	126	P	H	
	*	5823	105.76	-	-	96.81	32.6	8.39	32.04	246	126	A	H	
		5852.32	72.01	-6.29	78.3	63	32.61	8.43	32.03	246	126	P	H	
		5861.52	63.98	-10.02	74	54.95	32.62	8.43	32.02	246	126	P	H	
		5860	52.01	-1.99	54	42.98	32.62	8.43	32.02	246	126	A	H	
														H
														H
														H
	*	5824	106.48	-	-	97.53	32.6	8.39	32.04	100	84	P	V	
	*	5824	100.08	-	-	91.13	32.6	8.39	32.04	100	84	A	V	
		5851.28	65.16	-13.14	78.3	56.15	32.61	8.43	32.03	100	84	P	V	
		5860.96	60.19	-13.81	74	51.16	32.62	8.43	32.02	100	84	P	V	
		5860	47.85	-6.15	54	38.82	32.62	8.43	32.02	100	84	A	V	
														V
														V
														V
													V	
Remark	1. No other spurious found. 2. All results are PASS against Peak and Average limit line.													



Band 4 5725~5850MHz

WIFI 802.11a (Harmonic @ 3m)

WIFI Ant. 1	Note	Frequency (MHz)	Level (dBμV/m)	Over Limit (dB)	Limit Line (dBμV/m)	Read Level (dBμV)	Antenna Factor (dB/m)	Cable Loss (dB)	Preamp Factor (dB)	Ant Pos (cm)	Table Pos (deg)	Peak Avg. (P/A)	Pol. (H/V)
802.11a CH 149 5745MHz		11490	47.04	-26.96	74	57.25	40.01	12.58	62.8	100	0	P	H
		17232	47.72	-26.28	74	51.2	41.05	15.61	60.14	100	0	P	H
													H
													H
		11490	46.83	-27.17	74	57.04	40.01	12.58	62.8	100	0	P	V
		17232	46.36	-27.64	74	49.84	41.05	15.61	60.14	100	0	P	V
													V
													V
802.11a CH 157 5785MHz		11571	46.51	-27.49	74	56.71	39.88	12.66	62.74	100	0	P	H
		17355	47.33	-26.67	74	50.37	41.38	15.79	60.21	100	0	P	H
													H
													H
		11571	46.02	-27.98	74	56.22	39.88	12.66	62.74	100	0	P	V
		17355	46.23	-27.77	74	49.27	41.38	15.79	60.21	100	0	P	V
													V
													V
802.11a CH 165 5825MHz		11650	45.35	-28.65	74	55.56	39.75	12.73	62.69	100	0	P	H
		17472	47.8	-26.2	74	50.49	41.71	15.88	60.28	100	0	P	H
													H
													H
		11650	46.97	-27.03	74	57.18	39.75	12.73	62.69	100	0	P	V
		17472	47.53	-26.47	74	50.22	41.71	15.88	60.28	100	0	P	V
													V
													V
Remark	1. No other spurious found. 2. All results are PASS against Peak and Average limit line.												



Band 4 5725~5850MHz

WIFI 802.11n HT20 (Band Edge @ 3m)

WIFI Ant. 1	Note	Frequency (MHz)	Level (dBμV/m)	Over Limit (dB)	Limit Line (dBμV/m)	Read Level (dBμV)	Antenna Factor (dB/m)	Cable Loss (dB)	Preamp Factor (dB)	Ant Pos (cm)	Table Pos (deg)	Peak Avg. (P/A)	Pol. (H/V)	
802.11n HT20 CH 149 5745MHz		5711.16	58.17	-15.83	74	49.42	32.52	8.3	32.07	100	132	P	H	
		5724.84	72.14	-6.16	78.3	63.35	32.53	8.33	32.07	100	132	P	H	
		5714.76	50.26	-3.74	54	41.51	32.52	8.3	32.07	100	132	A	H	
	*	5744	110.84	-	-	102.03	32.54	8.33	32.06	100	132	P	H	
	*	5744	104.05	-	-	95.24	32.54	8.33	32.06	100	132	A	H	
														H
														H
														H
			5714.12	53.21	-20.79	74	44.46	32.52	8.3	32.07	136	41	P	V
			5725	64.53	-13.77	78.3	55.74	32.53	8.33	32.07	136	41	P	V
			5715	45.15	-8.85	54	36.4	32.52	8.3	32.07	136	41	A	V
		*	5747	104.14	-	-	95.33	32.54	8.33	32.06	136	41	P	V
		*	5747	97.41	-	-	88.6	32.54	8.33	32.06	136	41	A	V
														V
														V
													V	



WIFI Ant. 1	Note	Frequency (MHz)	Level (dBμV/m)	Over Limit (dB)	Limit Line (dBμV/m)	Read Level (dBμV)	Antenna Factor (dB/m)	Cable Loss (dB)	Preamp Factor (dB)	Ant Pos (cm)	Table Pos (deg)	Peak Avg. (P/A)	Pol. (H/V)
802.11n HT20 CH 157 5785MHz		5713.72	52.6	-21.4	74	43.85	32.52	8.3	32.07	100	131	P	H
		5724.12	55.49	-22.81	78.3	46.7	32.53	8.33	32.07	100	131	P	H
		5714.2	45.37	-8.63	54	36.62	32.52	8.3	32.07	100	131	A	H
	*	5787	112.73	-	-	103.85	32.58	8.35	32.05	100	131	P	H
	*	5787	105.63	-	-	96.75	32.58	8.35	32.05	100	131	A	H
		5856.8	54.7	-23.6	78.3	45.67	32.62	8.43	32.02	100	131	P	H
		5860.48	52.91	-21.09	74	43.88	32.62	8.43	32.02	100	131	P	H
		5862.4	44.17	-9.83	54	35.14	32.62	8.43	32.02	100	131	A	H
		5698.6	49.75	-24.25	74	41.02	32.51	8.3	32.08	100	85	P	V
		5718.68	51.23	-27.07	78.3	42.47	32.53	8.3	32.07	100	85	P	V
		5713.56	41.84	-12.16	54	33.09	32.52	8.3	32.07	100	85	A	V
	*	5786	105.99	-	-	97.11	32.58	8.35	32.05	100	85	P	V
	*	5786	98.89	-	-	90.01	32.58	8.35	32.05	100	85	A	V
		5850.16	50.33	-27.97	78.3	41.32	32.61	8.43	32.03	100	85	P	V
		5882.88	51.29	-22.71	74	42.21	32.63	8.47	32.02	100	85	P	V
	5862.8	42.5	-11.5	54	33.47	32.62	8.43	32.02	100	85	A	V	



WIFI Ant. 1	Note	Frequency (MHz)	Level (dBμV/m)	Over Limit (dB)	Limit Line (dBμV/m)	Read Level (dBμV)	Antenna Factor (dB/m)	Cable Loss (dB)	Preamp Factor (dB)	Ant Pos (cm)	Table Pos (deg)	Peak Avg. (P/A)	Pol. (H/V)	
802.11n HT20 CH 165 5825MHz	*	5827	112.74	-	-	103.79	32.6	8.39	32.04	245	126	P	H	
	*	5827	105.47	-	-	96.52	32.6	8.39	32.04	245	126	A	H	
		5856.08	70.85	-7.45	78.3	61.82	32.62	8.43	32.02	245	126	P	H	
		5861.44	63.55	-10.45	74	54.52	32.62	8.43	32.02	245	126	P	H	
		5860.08	52.94	-1.06	54	43.91	32.62	8.43	32.02	245	126	A	H	
														H
														H
														H
	*	5823	105.96	-	-	97.01	32.6	8.39	32.04	100	85	P	V	
	*	5823	99.22	-	-	90.27	32.6	8.39	32.04	100	85	A	V	
		5850.88	66.36	-11.94	78.3	57.35	32.61	8.43	32.03	100	85	P	V	
		5863.68	56.15	-17.85	74	47.12	32.62	8.43	32.02	100	85	P	V	
		5860.64	47.96	-6.04	54	38.93	32.62	8.43	32.02	100	85	A	V	
														V
														V
													V	
Remark	1. No other spurious found. 2. All results are PASS against Peak and Average limit line.													



Band 4 5725~5850MHz

WIFI 802.11n HT20 (Harmonic @ 3m)

WIFI Ant. 1	Note	Frequency (MHz)	Level (dBμV/m)	Over Limit (dB)	Limit Line (dBμV/m)	Read Level (dBμV)	Antenna Factor (dB/m)	Cable Loss (dB)	Preamp Factor (dB)	Ant Pos (cm)	Table Pos (deg)	Peak Avg. (P/A)	Pol. (H/V)
802.11n HT20 CH 149 5745MHz		11490	48.01	-25.99	74	58.22	40.01	12.58	62.8	100	0	P	H
		17232	46.87	-27.13	74	50.35	41.05	15.61	60.14	100	0	P	H
													H
													H
		11490	47.35	-26.65	74	57.56	40.01	12.58	62.8	100	0	P	V
		17232	47.69	-26.31	74	51.17	41.05	15.61	60.14	100	0	P	V
													V
802.11n HT20 CH 157 5785MHz		11570	46.31	-27.69	74	56.51	39.88	12.66	62.74	100	0	P	H
		17352	47.62	-26.38	74	50.7	41.38	15.75	60.21	100	0	P	H
													H
													H
		11570	47.09	-26.91	74	57.29	39.88	12.66	62.74	100	0	P	V
		17352	47.89	-26.11	74	50.97	41.38	15.75	60.21	100	0	P	V
													V
802.11n HT20 CH 165 5825MHz		11650	45.62	-28.38	74	55.83	39.75	12.73	62.69	100	0	P	H
		17472	47.76	-26.24	74	50.45	41.71	15.88	60.28	100	0	P	H
													H
													H
		11650	45.3	-28.7	74	55.51	39.75	12.73	62.69	100	0	P	V
		17472	48.35	-25.65	74	51.04	41.71	15.88	60.28	100	0	P	V
													V
Remark	1. No other spurious found.												
	2. All results are PASS against Peak and Average limit line.												



Emission below 1GHz

5GHz WIFI 802.11n HT20 (LF @ 3m)

WIFI	Note	Frequency	Level	Over	Limit	Read	Antenna	Cable	Preamp	Ant	Table	Peak	Pol.	
Ant.				Limit	Line	Level	Factor	Loss	Factor	Pos	Pos	Avg.		
1		(MHz)	(dBμV/m)	(dB)	(dBμV/m)	(dBμV)	(dB/m)	(dB)	(dB)	(cm)	(deg)	(P/A)	(H/V)	
5GHz 802.11n HT20 LF		139.89	19.18	-24.32	43.5	38.62	11.9	1.33	32.67			P	H	
		240.06	21.9	-24.1	46	41.03	11.98	1.62	32.73			P	H	
		268.14	22.39	-23.61	46	39.82	13.54	1.76	32.73	113	157	P	H	
		311.9	21.52	-24.48	46	38.23	14.15	1.88	32.74			P	H	
		360.2	21.1	-24.9	46	36.51	15.45	1.94	32.8			P	H	
		987.4	26.34	-27.66	54	30.16	24.15	3.38	31.35			P	H	
														H
														H
														H
														H
														H
														H
														H
			41.88	29.7	-10.3	40	48.47	13.38	0.65	32.8	100	315	P	V
			121.8	18.79	-24.71	43.5	38.38	11.92	1.14	32.65			P	V
			264.09	23.45	-22.55	46	40.68	13.74	1.76	32.73			P	V
			515.6	19.47	-26.53	46	31.72	18.36	2.33	32.94			P	V
			699.7	21.63	-24.37	46	31.21	20.59	2.82	32.99			P	V
			947.5	26.28	-19.72	46	30.52	24.26	3.29	31.79			P	V
														V
													V	
													V	
													V	
													V	
													V	
Remark	1. No other spurious found. 2. All results are PASS against limit line.													



Note symbol

*	Fundamental Frequency which can be ignored. However, the level of any unwanted emissions shall not exceed the level of the fundamental frequency.
!	Test result is over limit line.
P/A	Peak or Average
H/V	Horizontal or Vertical



A calculation example for radiated spurious emission is shown as below:

WIFI	Note	Frequency	Level	Over	Limit	Read	Antenna	Cable	Preamp	Ant	Table	Peak	Pol.
Ant.				Limit	Line	Level	Factor	Loss	Factor	Pos	Pos	Avg.	
1		(MHz)	(dBμV/m)	(dB)	(dBμV/m)	(dBμV)	(dB/m)	(dB)	(dB)	(cm)	(deg)	(P/A)	(H/V)
802.11b		2390	55.45	-18.55	74	54.51	32.22	4.58	35.86	103	308	P	H
CH 01													
2412MHz		2390	43.54	-10.46	54	42.6	32.22	4.58	35.86	103	308	A	H

- 1. Level(dBμV/m) =
Antenna Factor(dB/m) + Cable Loss(dB) + Read Level(dBμV) - Preamp Factor(dB)
- 2. Over Limit(dB) = Level(dBμV/m) – Limit Line(dBμV/m)

For Peak Limit @ 2390MHz:

- 1. Level(dBμV/m)
= Antenna Factor(dB/m) + Cable Loss(dB) + Read Level(dBμV) - Preamp Factor(dB)
= 32.22(dB/m) + 4.58(dB) + 54.51(dBμV) – 35.86 (dB)
= 55.45 (dBμV/m)
- 2. Over Limit(dB)
= Level(dBμV/m) – Limit Line(dBμV/m)
= 55.45(dBμV/m) – 74(dBμV/m)
= -18.55(dB)

For Average Limit @ 2390MHz:

- 1. Level(dBμV/m)
= Antenna Factor(dB/m) + Cable Loss(dB) + Read Level(dBμV) - Preamp Factor(dB)
= 32.22(dB/m) + 4.58(dB) + 42.6(dBμV) – 35.86 (dB)
= 43.54 (dBμV/m)
- 2. Over Limit(dB)
= Level(dBμV/m) – Limit Line(dBμV/m)
= 43.54(dBμV/m) – 54(dBμV/m)
= -10.46(dB)

Both peak and average measured complies with the limit line, so test result is “PASS”.



Band 4 - 5725~5850MHz

WIFI 802.11a (Band Edge @ 3m)

WIFI Ant.	Note	Frequency	Level	Over Limit	Limit Line	Read Level	Antenna Factor	Cable Loss	Preamp Factor	Ant Pos	Table Pos	Peak Avg.	Pol.	
2		(MHz)	(dBµV/m)	(dB)	(dBµV/m)	(dBµV)	(dB/m)	(dB)	(dB)	(cm)	(deg)	(P/A)	(H/V)	
802.11a CH 149 5745MHz		5711.8	62.53	-11.47	74	54.37	32.52	8.3	32.66	100	328	P	H	
		5723.8	74.93	-3.37	78.3	66.73	32.53	8.33	32.66	100	328	P	H	
		5715	52.16	-1.84	54	44	32.52	8.3	32.66	100	328	A	H	
	*	5747	110.22	-	-	102.02	32.54	8.33	32.67	100	328	P	H	
	*	5747	103.07	-	-	94.87	32.54	8.33	32.67	100	328	A	H	
														H
														H
														H
			5714.92	61.37	-12.63	74	53.21	32.52	8.3	32.66	100	141	P	V
			5724.84	73.91	-4.39	78.3	65.71	32.53	8.33	32.66	100	141	P	V
			5715	49.31	-4.69	54	41.15	32.52	8.3	32.66	100	141	A	V
	*		5743	106.35	-	-	98.15	32.54	8.33	32.67	100	141	P	V
	*		5743	99.99	-	-	91.79	32.54	8.33	32.67	100	141	A	V
														V
														V
													V	



WIFI Ant. 2	Note	Frequency (MHz)	Level (dBμV/m)	Over Limit (dB)	Limit Line (dBμV/m)	Read Level (dBμV)	Antenna Factor (dB/m)	Cable Loss (dB)	Preamp Factor (dB)	Ant Pos (cm)	Table Pos (deg)	Peak Avg. (P/A)	Pol. (H/V)
802.11a CH 157 5785MHz		5713.88	51.71	-22.29	74	43.55	32.52	8.3	32.66	100	302	P	H
		5724.28	52.21	-26.09	78.3	44.01	32.53	8.33	32.66	100	302	P	H
		5715	43.4	-10.6	54	35.24	32.52	8.3	32.66	100	302	A	H
	*	5787	112.22	-	-	103.97	32.58	8.35	32.68	100	302	P	H
	*	5787	105.22	-	-	96.97	32.58	8.35	32.68	100	302	A	H
		5853.68	51.4	-26.9	78.3	43.05	32.62	8.43	32.7	100	302	P	H
		5869.92	51.33	-22.67	74	42.99	32.62	8.43	32.71	100	302	P	H
		5860.08	42.25	-11.75	54	33.91	32.62	8.43	32.71	100	302	A	H
		5708.12	51.9	-22.1	74	43.74	32.52	8.3	32.66	100	140	P	V
		5721.24	53.96	-24.34	78.3	45.79	32.53	8.3	32.66	100	140	P	V
		5714.6	41.47	-12.53	54	33.31	32.52	8.3	32.66	100	140	A	V
	*	5787	107.3	-	-	99.05	32.58	8.35	32.68	100	140	P	V
	*	5787	100.3	-	-	92.05	32.58	8.35	32.68	100	140	A	V
		5852.08	49.38	-28.92	78.3	41.04	32.61	8.43	32.7	100	140	P	V
		5866.56	50.37	-23.63	74	42.03	32.62	8.43	32.71	100	140	P	V
		5860.72	40.93	-13.07	54	32.59	32.62	8.43	32.71	100	140	A	V



WIFI Ant. 2	Note	Frequency (MHz)	Level (dBμV/m)	Over Limit (dB)	Limit Line (dBμV/m)	Read Level (dBμV)	Antenna Factor (dB/m)	Cable Loss (dB)	Preamp Factor (dB)	Ant Pos (cm)	Table Pos (deg)	Peak Avg. (P/A)	Pol. (H/V)	
802.11a CH 165 5825MHz	*	5827	111.36	-	-	103.06	32.6	8.39	32.69	102	302	P	H	
	*	5827	104.26	-	-	95.96	32.6	8.39	32.69	102	302	A	H	
		5850.72	66.94	-11.36	78.3	58.6	32.61	8.43	32.7	102	302	P	H	
		5861.2	60.11	-13.89	74	51.77	32.62	8.43	32.71	102	302	P	H	
		5860	51.3	-2.7	54	42.96	32.62	8.43	32.71	102	302	A	H	
														H
														H
														H
	*	5824	107.13	-	-	98.83	32.6	8.39	32.69	100	140	P	V	
	*	5824	99.84	-	-	91.54	32.6	8.39	32.69	100	140	A	V	
		5850.88	66.05	-12.25	78.3	57.71	32.61	8.43	32.7	100	140	P	V	
		5862.72	58.66	-15.34	74	50.32	32.62	8.43	32.71	100	140	P	V	
		5860	47.79	-6.21	54	39.45	32.62	8.43	32.71	100	140	A	V	
														V
														V
														V
														V
Remark	3. No other spurious found. 4. All results are PASS against Peak and Average limit line.													



Band 4 5725~5850MHz

WIFI 802.11a (Harmonic @ 3m)

WIFI Ant. 2	Note	Frequency (MHz)	Level (dBμV/m)	Over Limit (dB)	Limit Line (dBμV/m)	Read Level (dBμV)	Antenna Factor (dB/m)	Cable Loss (dB)	Preamp Factor (dB)	Ant Pos (cm)	Table Pos (deg)	Peak Avg. (P/A)	Pol. (H/V)
802.11a CH 149 5745MHz		11490	46.82	-27.18	74	57.03	40.01	12.58	62.8	100	0	P	H
		17232	47.04	-26.96	74	50.52	41.05	15.61	60.14	100	0	P	H
													H
													H
		11490	46.96	-27.04	74	57.17	40.01	12.58	62.8	100	0	P	V
		17232	46.82	-27.18	74	50.3	41.05	15.61	60.14	100	0	P	V
													V
													V
802.11a CH 157 5785MHz		11571	46.63	-27.37	74	56.83	39.88	12.66	62.74	100	0	P	H
		17355	47.81	-26.19	74	50.85	41.38	15.79	60.21	100	0	P	H
													H
													H
		11571	46.5	-27.5	74	56.7	39.88	12.66	62.74	100	0	P	V
		17355	47.65	-26.35	74	50.69	41.38	15.79	60.21	100	0	P	V
													V
													V
802.11a CH 165 5825MHz		11650	45.27	-28.73	74	55.48	39.75	12.73	62.69	100	0	P	H
		17472	47.19	-26.81	74	49.88	41.71	15.88	60.28	100	0	P	H
													H
													H
		11650	45.67	-28.33	74	55.88	39.75	12.73	62.69	100	0	P	V
		17472	47.9	-26.1	74	50.59	41.71	15.88	60.28	100	0	P	V
													V
													V
Remark	3. No other spurious found. 4. All results are PASS against Peak and Average limit line.												



Band 4 5725~5850MHz

WIFI 802.11n HT20 (Band Edge @ 3m)

WIFI Ant. 2	Note	Frequency (MHz)	Level (dBμV/m)	Over Limit (dB)	Limit Line (dBμV/m)	Read Level (dBμV)	Antenna Factor (dB/m)	Cable Loss (dB)	Preamp Factor (dB)	Ant Pos (cm)	Table Pos (deg)	Peak Avg. (P/A)	Pol. (H/V)	
802.11n HT20 CH 149 5745MHz		5714.52	60.39	-13.61	74	52.23	32.52	8.3	32.66	100	324	P	H	
		5724.92	73.37	-4.93	78.3	65.17	32.53	8.33	32.66	100	324	P	H	
		5714.36	50.93	-3.07	54	42.77	32.52	8.3	32.66	100	324	A	H	
	*	5746	109.29	-	-	101.09	32.54	8.33	32.67	100	324	P	H	
	*	5746	102.33	-	-	94.13	32.54	8.33	32.67	100	324	A	H	
														H
														H
														H
			5709.72	57.43	-16.57	74	49.27	32.52	8.3	32.66	100	139	P	V
			5724.44	67.17	-11.13	78.3	58.97	32.53	8.33	32.66	100	139	P	V
			5715	47.66	-6.34	54	39.5	32.52	8.3	32.66	100	139	A	V
		*	5747	105.48	-	-	97.28	32.54	8.33	32.67	100	139	P	V
		*	5747	98.69	-	-	90.49	32.54	8.33	32.67	100	139	A	V
														V
														V
													V	



WIFI Ant. 2	Note	Frequency (MHz)	Level (dBμV/m)	Over Limit (dB)	Limit Line (dBμV/m)	Read Level (dBμV)	Antenna Factor (dB/m)	Cable Loss (dB)	Preamp Factor (dB)	Ant Pos (cm)	Table Pos (deg)	Peak Avg. (P/A)	Pol. (H/V)
802.11n HT20 CH 157 5785MHz		5708.68	51.19	-22.81	74	43.03	32.52	8.3	32.66	100	301	P	H
		5719.16	52.06	-26.24	78.3	43.89	32.53	8.3	32.66	100	301	P	H
		5712.76	43.67	-10.33	54	35.51	32.52	8.3	32.66	100	301	A	H
	*	5787	111.6	-	-	103.35	32.58	8.35	32.68	100	301	P	H
	*	5787	104.5	-	-	96.25	32.58	8.35	32.68	100	301	A	H
		5855.36	52.25	-26.05	78.3	43.9	32.62	8.43	32.7	100	301	P	H
		5870.24	50.26	-23.74	74	41.92	32.62	8.43	32.71	100	301	P	H
		5860	42.78	-11.22	54	34.44	32.62	8.43	32.71	100	301	A	H
		5688.76	50.43	-23.57	74	42.27	32.51	8.3	32.65	104	140	P	V
		5723.08	49.86	-28.44	78.3	41.66	32.53	8.33	32.66	104	140	P	V
		5697.24	41.79	-12.21	54	33.63	32.51	8.3	32.65	104	140	A	V
	*	5783	106.64	-	-	98.4	32.57	8.35	32.68	104	140	P	V
	*	5783	99.64	-	-	91.4	32.57	8.35	32.68	104	140	A	V
		5853.2	49.94	-28.36	78.3	41.6	32.61	8.43	32.7	104	140	P	V
		5879.04	50.19	-23.81	74	41.84	32.63	8.43	32.71	104	140	P	V
	5869.76	41.39	-12.61	54	33.05	32.62	8.43	32.71	104	140	A	V	



WIFI Ant. 2	Note	Frequency (MHz)	Level (dBμV/m)	Over Limit (dB)	Limit Line (dBμV/m)	Read Level (dBμV)	Antenna Factor (dB/m)	Cable Loss (dB)	Preamp Factor (dB)	Ant Pos (cm)	Table Pos (deg)	Peak Avg. (P/A)	Pol. (H/V)	
802.11n HT20 CH 165 5825MHz	*	5827	110.86	-	-	102.56	32.6	8.39	32.69	100	301	P	H	
	*	5827	103.67	-	-	95.37	32.6	8.39	32.69	100	301	A	H	
		5851.36	69.72	-8.58	78.3	61.38	32.61	8.43	32.7	100	301	P	H	
		5862.56	64.51	-9.49	74	56.17	32.62	8.43	32.71	100	301	P	H	
		5860.08	52.47	-1.53	54	44.13	32.62	8.43	32.71	100	301	A	H	
														H
														H
														H
	*	5823	106.06	-	-	97.76	32.6	8.39	32.69	100	144	144	P	V
	*	5823	99.39	-	-	91.09	32.6	8.39	32.69	100	144	144	A	V
		5850	64.79	-9.21	74	56.45	32.61	8.43	32.7	100	144	144	P	V
		5860.08	58.56	-15.44	74	50.22	32.62	8.43	32.71	100	144	144	P	V
		5860.16	49.41	-4.59	54	41.07	32.62	8.43	32.71	100	144	144	A	V
														V
														V
													V	
Remark	3. No other spurious found. 4. All results are PASS against Peak and Average limit line.													



Band 4 5725~5850MHz

WIFI 802.11n HT20 (Harmonic @ 3m)

WIFI Ant. 2	Note	Frequency (MHz)	Level (dBμV/m)	Over Limit (dB)	Limit Line (dBμV/m)	Read Level (dBμV)	Antenna Factor (dB/m)	Cable Loss (dB)	Preamp Factor (dB)	Ant Pos (cm)	Table Pos (deg)	Peak Avg. (P/A)	Pol. (H/V)	
802.11n HT20 CH 149 5745MHz		11490	46.79	-27.21	74	57	40.01	12.58	62.8	100	0	P	H	
		17232	46.46	-27.54	74	49.94	41.05	15.61	60.14	100	0	P	H	
													H	
													H	
			11490	46.37	-27.63	74	56.58	40.01	12.58	62.8	100	0	P	V
			17232	46.61	-27.39	74	50.09	41.05	15.61	60.14	100	0	P	V
														V
802.11n HT20 CH 157 5785MHz		11570	46.52	-27.48	74	56.72	39.88	12.66	62.74	100	0	P	H	
		17352	47.57	-26.43	74	50.65	41.38	15.75	60.21	100	0	P	H	
													H	
													H	
			11570	46.26	-27.74	74	56.46	39.88	12.66	62.74	100	0	P	V
			17352	48.12	-25.88	74	51.2	41.38	15.75	60.21	100	0	P	V
														V
802.11n HT20 CH 165 5825MHz		11650	45.55	-28.45	74	55.76	39.75	12.73	62.69	100	0	P	H	
		17472	48.61	-25.39	74	51.3	41.71	15.88	60.28	100	0	P	H	
													H	
													H	
			11650	45.53	-28.47	74	55.74	39.75	12.73	62.69	100	0	P	V
			17472	48.21	-25.79	74	50.9	41.71	15.88	60.28	100	0	P	V
														V
Remark	3. No other spurious found.													
	4. All results are PASS against Peak and Average limit line.													



Emission below 1GHz

5GHz WIFI 802.11n HT20 (LF @ 3m)

WIFI	Note	Frequency	Level	Over	Limit	Read	Antenna	Cable	Preamp	Ant	Table	Peak	Pol.	
Ant.				Limit	Line	Level	Factor	Loss	Factor	Pos	Pos	Avg.		
2		(MHz)	(dBμV/m)	(dB)	(dBμV/m)	(dBμV)	(dB/m)	(dB)	(dB)	(cm)	(deg)	(P/A)	(H/V)	
5GHz 802.11n HT20 LF		227.91	29.76	-16.24	46	49.95	10.92	1.62	32.73			P	H	
		264.09	29.85	-16.15	46	41.18	19.64	1.76	32.73	100	0	P	H	
		288.12	27.9	-18.1	46	45.21	13.54	1.88	32.73			P	H	
		311.9	27.95	-18.05	46	44.66	14.15	1.88	32.74			P	H	
		360.2	20.8	-25.2	46	36.21	15.45	1.94	32.8			P	H	
		975.5	26.57	-27.43	54	30.48	24.2	3.38	31.49			P	H	
													H	
													H	
													H	
													H	
													H	
													H	
													H	
													H	
			40.26	30.85	-9.15	40	43.06	19.94	0.65	32.8	100	56	P	V
			240.06	28.74	-17.26	46	47.87	11.98	1.62	32.73			P	V
			264.09	27.36	-18.64	46	44.59	13.74	1.76	32.73			P	V
			311.9	18.85	-27.15	46	35.56	14.15	1.88	32.74			P	V
			524.7	19.47	-26.53	46	31.5	18.45	2.47	32.95			P	V
			861.4	25.01	-20.99	46	31.72	22.66	3.16	32.53			P	V
													V	
													V	
													V	
													V	
													V	
													V	
Remark	3. No other spurious found. 4. All results are PASS against limit line.													



Note symbol

*	Fundamental Frequency which can be ignored. However, the level of any unwanted emissions shall not exceed the level of the fundamental frequency.
!	Test result is over limit line.
P/A	Peak or Average
H/V	Horizontal or Vertical



A calculation example for radiated spurious emission is shown as below:

WIFI	Note	Frequency	Level	Over	Limit	Read	Antenna	Cable	Preamp	Ant	Table	Peak	Pol.
Ant.				Limit	Line	Level	Factor	Loss	Factor	Pos	Pos	Avg.	
2		(MHz)	(dBμV/m)	(dB)	(dBμV/m)	(dBμV)	(dB/m)	(dB)	(dB)	(cm)	(deg)	(P/A)	(H/V)
802.11b		2390	55.45	-18.55	74	54.51	32.22	4.58	35.86	103	308	P	H
CH 01													
2412MHz		2390	43.54	-10.46	54	42.6	32.22	4.58	35.86	103	308	A	H

- 3. Level(dBμV/m) =
Antenna Factor(dB/m) + Cable Loss(dB) + Read Level(dBμV) - Preamp Factor(dB)
- 4. Over Limit(dB) = Level(dBμV/m) – Limit Line(dBμV/m)

For Peak Limit @ 2390MHz:

- 3. Level(dBμV/m)
= Antenna Factor(dB/m) + Cable Loss(dB) + Read Level(dBμV) - Preamp Factor(dB)
= 32.22(dB/m) + 4.58(dB) + 54.51(dBμV) – 35.86 (dB)
= 55.45 (dBμV/m)
- 4. Over Limit(dB)
= Level(dBμV/m) – Limit Line(dBμV/m)
= 55.45(dBμV/m) – 74(dBμV/m)
= -18.55(dB)

For Average Limit @ 2390MHz:

- 3. Level(dBμV/m)
= Antenna Factor(dB/m) + Cable Loss(dB) + Read Level(dBμV) - Preamp Factor(dB)
= 32.22(dB/m) + 4.58(dB) + 42.6(dBμV) – 35.86 (dB)
= 43.54 (dBμV/m)
- 4. Over Limit(dB)
= Level(dBμV/m) – Limit Line(dBμV/m)
= 43.54(dBμV/m) – 54(dBμV/m)
= -10.46(dB)

Both peak and average measured complies with the limit line, so test result is “PASS”.



Appendix C. Radiated Spurious Emission Plots

Note symbol

-L	Low channel location
-R	High channel location



Band 4 - 5725~5850MHz
WIFI 802.11a (Band Edge @ 3m)

WIFI	Band 4 5725~5850MHz Band Edge @ 3m	
ANT	802.11a CH149 5745MHz	
1	Horizontal	Vertical
Peak	<p>Site : 03CH10-HY Condition : FCC CLASS-B_BAND 4 3m HORN 9120D-HF HORIZONTAL Detector : Peak Project : 3N0602-02 Mode : 1</p>	<p>Site : 03CH10-HY Condition : FCC CLASS-B_BAND 4 3m HORN 9120D-HF VERTICAL Detector : Peak Project : 3N0602-02 Mode : 1</p>
Avg.	<p>Site : 03CH10-HY Condition : FCC CLASS-B (AVG) 3m HORN 9120D-HF HORIZONTAL Detector : Peak Project : 3N0602-02 Mode : 1</p>	<p>Site : 03CH10-HY Condition : FCC CLASS-B (AVG) 3m HORN 9120D-HF VERTICAL Detector : Peak Project : 3N0602-02 Mode : 1</p>



WIFI	Band 4 5725~5850MHz Band Edge @ 3m	
ANT	802.11a CH157 5785MHz - L	
1	Horizontal	Vertical
Peak	<p>Site : 03CH10-HY Condition : FCC CLASS-B_BAND 4 3m HORN 9120D-HF HORIZONTAL RBW:1000.000KHz VBW:3000.000KHz SWT:Auto Detector : Peak Project : 3N0602-02 Mode : 2</p>	<p>Site : 03CH10-HY Condition : FCC CLASS-B_BAND 4 3m HORN 9120D-HF VERTICAL RBW:1000.000KHz VBW:3000.000KHz SWT:Auto Detector : Peak Project : 3N0602-02 Mode : 2</p>
Avg.	<p>Site : 03CH10-HY Condition : FCC CLASS-B (AVG) 3m HORN 9120D-HF HORIZONTAL RBW:1000.000KHz VBW:0.010KHz SWT:Auto Detector : Peak Project : 3N0602-02 Mode : 2</p>	<p>Site : 03CH10-HY Condition : FCC CLASS-B (AVG) 3m HORN 9120D-HF VERTICAL RBW:1000.000KHz VBW:0.010KHz SWT:Auto Detector : Peak Project : 3N0602-02 Mode : 2</p>

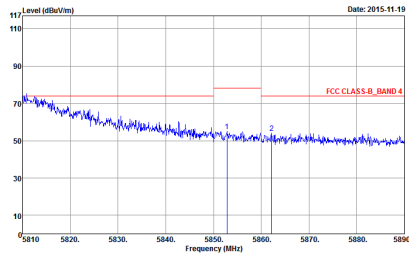
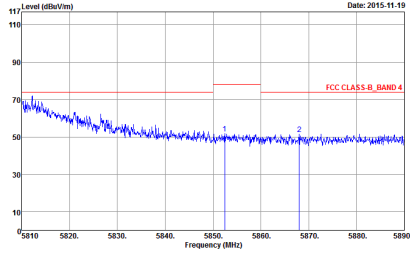
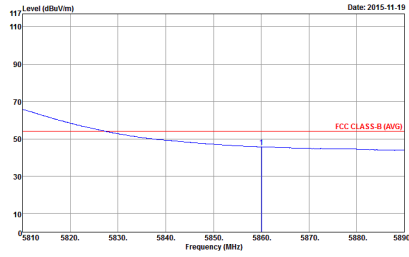
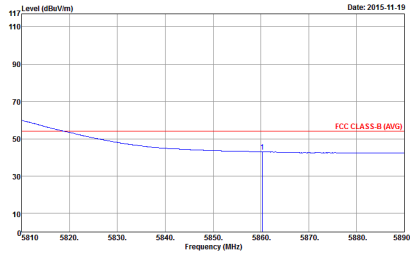

WIFI	Band 4 5725~5850MHz Band Edge @ 3m	
ANT	802.11a CH157 5785MHz - R	
1	Horizontal	Vertical
Peak	 <p>Site : 03CH10-HY Condition : FCC CLASS-B_BAND 4 3m HORN 9120D-HF HORIZONTAL RBW:1000.000KHz VBW:3000.000KHz SWT:Auto Detector : Peak Project : 3N0602-02 Mode : 2</p>	 <p>Site : 03CH10-HY Condition : FCC CLASS-B_BAND 4 3m HORN 9120D-HF VERTICAL RBW:1000.000KHz VBW:3000.000KHz SWT:Auto Detector : Peak Project : 3N0602-02 Mode : 2</p>
Avg.	 <p>Site : 03CH10-HY Condition : FCC CLASS-B (AVG) 3m HORN 9120D-HF HORIZONTAL RBW:1000.000KHz VBW:0.010KHz SWT:Auto Detector : Peak Project : 3N0602-02 Mode : 2</p>	 <p>Site : 03CH10-HY Condition : FCC CLASS-B (AVG) 3m HORN 9120D-HF VERTICAL RBW:1000.000KHz VBW:0.010KHz SWT:Auto Detector : Peak Project : 3N0602-02 Mode : 2</p>

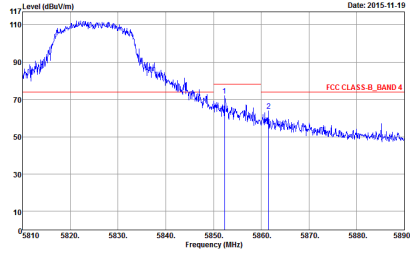
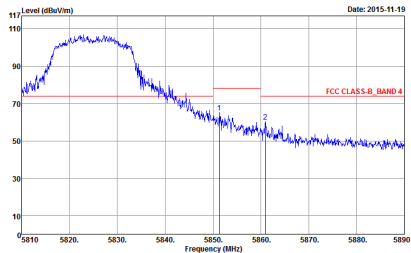
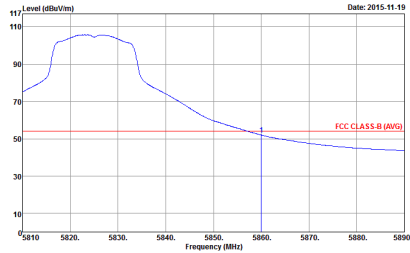
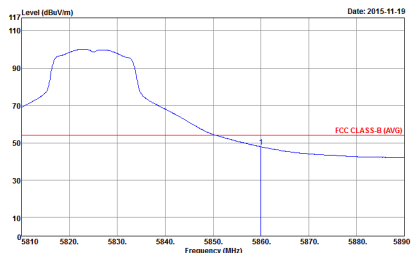

WIFI	Band 4 5725~5850MHz Band Edge @ 3m	
ANT	802.11a CH165 5825MHz	
1	Horizontal	Vertical
Peak	 <p>Site : 03CH10-HY Condition : FCC CLASS-B_BAND 4 3m HORN 9120D-HF HORIZONTAL RBW:1000.000KHz VBW:3000.000KHz SWT:Auto Detector : Peak Project : 3N0602-02 Mode : 3</p>	 <p>Site : 03CH10-HY Condition : FCC CLASS-B_BAND 4 3m HORN 9120D-HF VERTICAL RBW:1000.000KHz VBW:3000.000KHz SWT:Auto Detector : Peak Project : 3N0602-02 Mode : 3</p>
Avg.	 <p>Site : 03CH10-HY Condition : FCC CLASS-B (AVG) 3m HORN 9120D-HF HORIZONTAL RBW:1000.000KHz VBW:0.010KHz SWT:Auto Detector : Peak Project : 3N0602-02 Mode : 3</p>	 <p>Site : 03CH10-HY Condition : FCC CLASS-B (AVG) 3m HORN 9120D-HF VERTICAL RBW:1000.000KHz VBW:0.010KHz SWT:Auto Detector : Peak Project : 3N0602-02 Mode : 3</p>

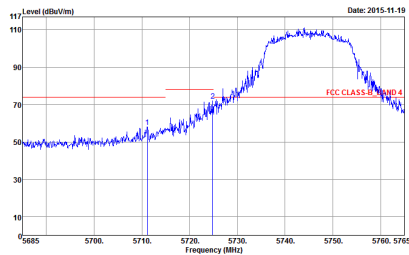
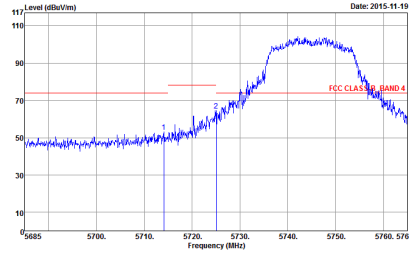
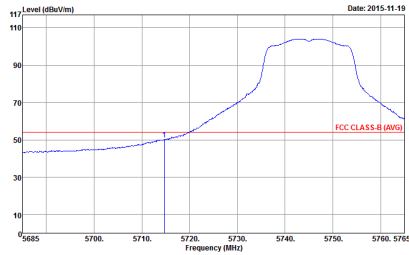
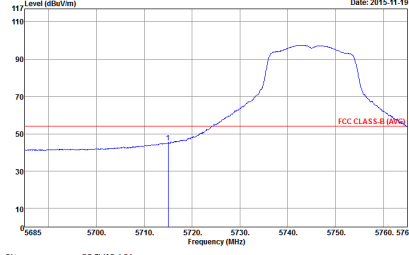

Band 4 5725~5850MHz
WIFI 802.11n HT20 (Band Edge @ 3m)

WIFI	Band 4 5725~5850MHz Band Edge @ 3m	
ANT	802.11n HT20 CH149 5745MHz	
1	Horizontal	Vertical
Peak	 <p>Site : 03CH10-HY Condition : FCC CLASS-B_BAND 4 3m HORN 9120D-HF HORIZONTAL RBW:1000.000KHz VBW:3000.000KHz SWT:Auto Detector : Peak Project : 3N0602-02 Mode : 4</p>	 <p>Site : 03CH10-HY Condition : FCC CLASS-B_BAND 4 3m HORN 9120D-HF VERTICAL RBW:1000.000KHz VBW:3000.000KHz SWT:Auto Detector : Peak Project : 3N0602-02 Mode : 4</p>
Avg.	 <p>Site : 03CH10-HY Condition : FCC CLASS-B (AVG) 3m HORN 9120D-HF HORIZONTAL RBW:1000.000KHz VBW:1000KHz SWT:Auto Detector : Peak Project : 3N0602-02 Mode : 4</p>	 <p>Site : 03CH10-HY Condition : FCC CLASS-B (AVG) 3m HORN 9120D-HF VERTICAL RBW:1000.000KHz VBW:1000KHz SWT:Auto Detector : Peak Project : 3N0602-02 Mode : 4</p>

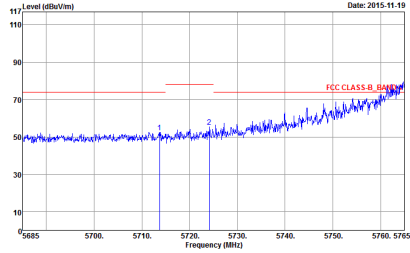
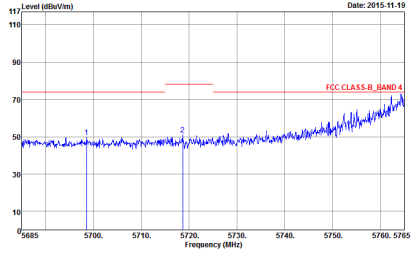
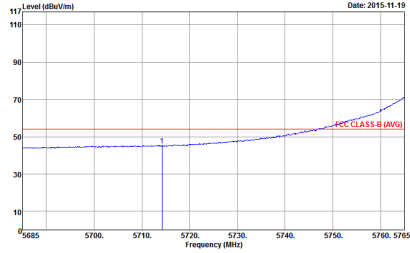
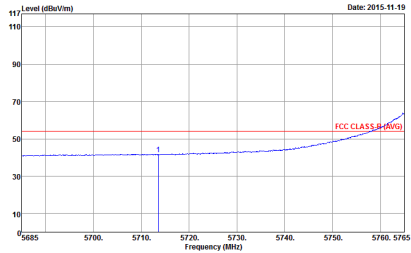

WIFI	Band 4 5725~5850MHz Band Edge @ 3m	
ANT	802.11n HT20 CH157 5785MHz - L	
1	Horizontal	Vertical
<p>Peak</p>	 <p>Site : 03GH10-HY Condition : FCC CLASS-B_BAND 4 3m HORN 9120D-HF HORIZONTAL Detector : Peak Project : 3N0602-02 Mode : 5</p>	 <p>Site : 03GH10-HY Condition : FCC CLASS-B_BAND 4 3m HORN 9120D-HF VERTICAL Detector : Peak Project : 3N0602-02 Mode : 5</p>
<p>Avg.</p>	 <p>Site : 03GH10-HY Condition : FCC CLASS-B (AVG) 3m HORN 9120D-HF HORIZONTAL Detector : Peak Project : 3N0602-02 Mode : 5</p>	 <p>Site : 03GH10-HY Condition : FCC CLASS-B (AVG) 3m HORN 9120D-HF VERTICAL Detector : Peak Project : 3N0602-02 Mode : 5</p>

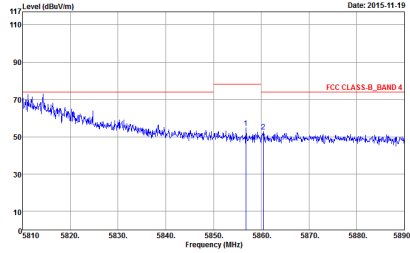
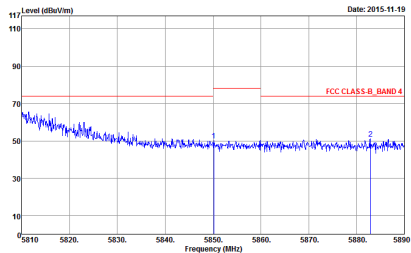
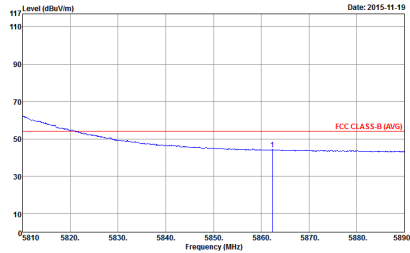
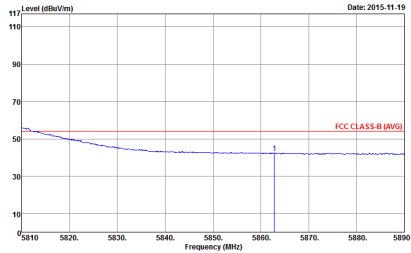

WIFI	Band 4 5725~5850MHz Band Edge @ 3m	
ANT	802.11n HT20 CH157 5785MHz - R	
1	Horizontal	Vertical
<p>Peak</p>	 <p>Site : 03CH10-HY Condition : FCC CLASS-B_BAND 4 3m HORN 9120D-HF HORIZONTAL Detector : Peak Project : 3N0602-02 Mode : 5</p>	 <p>Site : 03CH10-HY Condition : FCC CLASS-B_BAND 4 3m HORN 9120D-HF VERTICAL Detector : Peak Project : 3N0602-02 Mode : 5</p>
<p>Avg.</p>	 <p>Site : 03CH10-HY Condition : FCC CLASS-B (AVG) 3m HORN 9120D-HF HORIZONTAL Detector : Peak Project : 3N0602-02 Mode : 5</p>	 <p>Site : 03CH10-HY Condition : FCC CLASS-B (AVG) 3m HORN 9120D-HF VERTICAL Detector : Peak Project : 3N0602-02 Mode : 5</p>

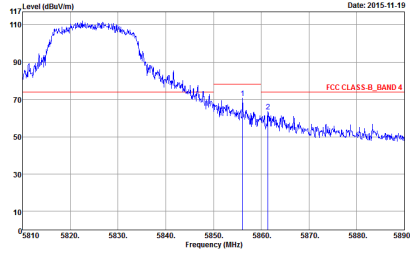
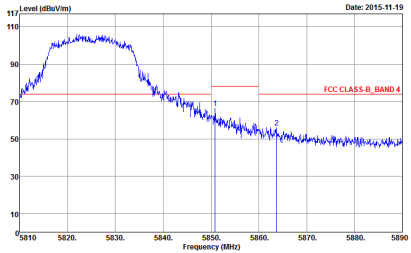
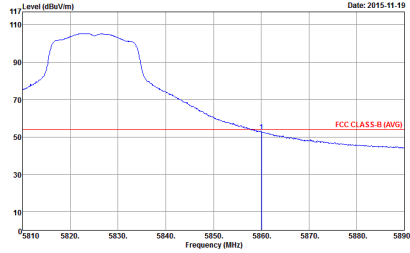
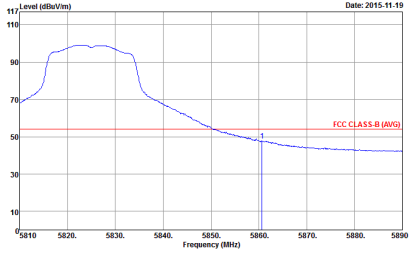

WIFI	Band 4 5725~5850MHz Band Edge @ 3m	
ANT	802.11n HT20 CH165 5825MHz	
1	Horizontal	Vertical
Peak	 <p>Site : 03CH10-HY Condition : FCC CLASS-B_BAND 4 3m HORN 9120D-HF HORIZONTAL Detector : Peak Project : 3N0602-02 Mode : 6</p>	 <p>Site : 03CH10-HY Condition : FCC CLASS-B_BAND 4 3m HORN 9120D-HF VERTICAL Detector : Peak Project : 3N0602-02 Mode : 6</p>
Avg.	 <p>Site : 03CH10-HY Condition : FCC CLASS-B (AVG) 3m HORN 9120D-HF HORIZONTAL Detector : Peak Project : 3N0602-02 Mode : 6</p>	 <p>Site : 03CH10-HY Condition : FCC CLASS-B (AVG) 3m HORN 9120D-HF VERTICAL Detector : Peak Project : 3N0602-02 Mode : 6</p>



Band 4 - 5725~5850MHz
WIFI 802.11a (Harmonic @ 3m)

WIFI	Band 4 5725~5850MHz Harmonic @ 3m	
ANT	802.11a CH149 5745MHz	
1	Horizontal	Vertical
Peak Avg.	<p>Site : 03CH10-HY Condition : FCC CLASS-B_BAND 4 3m HORN 9120D-HF HORIZONTAL Detector : Peak Project : 3N0602-02 Mode : 1</p>	<p>Site : 03CH10-VY Condition : FCC CLASS-B_BAND 4 3m HORN 9120D-HF VERTICAL Detector : Peak Project : 3N0602-02 Mode : 1</p>

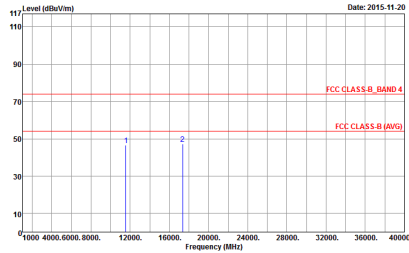
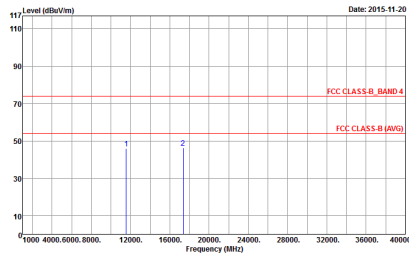

WIFI	Band 4 5725~5850MHz Harmonic @ 3m	
ANT	802.11a CH157 5785MHz	
1	Horizontal	Vertical
Peak Avg.	 <p>Site : 03CH10-HY Condition : FCC CLASS-B_BAND 4 3m HORN 9120D-HF HORIZONTAL Detector : Peak Project : 3N0602-02 Mode : 2</p>	 <p>Site : 03CH10-HY Condition : FCC CLASS-B_BAND 4 3m HORN 9120D-HF VERTICAL Detector : Peak Project : 3N0602-02 Mode : 2</p>

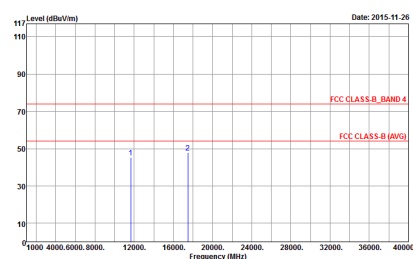
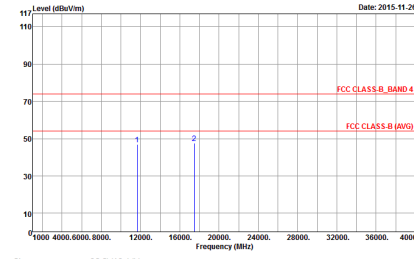

WIFI	Band 4 5725~5850MHz Harmonic @ 3m	
ANT	802.11a CH165 5825MHz	
1	Horizontal	Vertical
<p>Peak</p> <p>Avg.</p>	 <p>Site : 03CH10-HY Condition : FCC CLASS-B_BAND 4 3m HORN 9120D-HF HORIZONTAL Detector : Peak Project : 3N0602-02 Mode : 3</p>	 <p>Site : 03CH10-HY Condition : FCC CLASS-B_BAND 4 3m HORN 9120D-HF VERTICAL Detector : Peak Project : 3N0602-02 Mode : 3</p>



Band 4 5725~5850MHz
WIFI 802.11n HT20 (Harmonic @ 3m)

Table with 3 columns: WIFI, ANT, and 1. It contains two graphs: 'Horizontal' and 'Vertical'. Each graph plots Level (dBuV/m) vs Frequency (MHz) with FCC CLASS-B_BAND 4 and FCC CLASS-B (AVG) limits. Includes site and condition details for each graph.

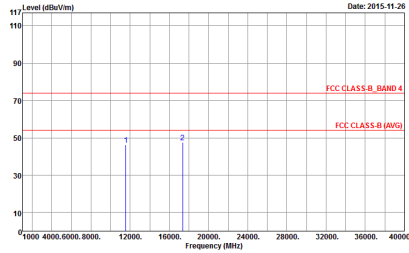
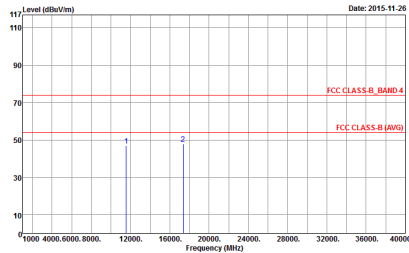

WIFI	Band 4 5725~5850MHz Harmonic @ 3m	
ANT	802.11n HT20 CH157 5785MHz	
1	Horizontal	Vertical
<p>Peak</p> <p>Avg.</p>	 <p>Site : 03CH10-HY Condition : FCC CLASS-B_BAND 4 3m HORN 9120D-HF HORIZONTAL Detector : Peak Project : 3N0602-02 Mode : 5</p>	 <p>Site : 03CH10-HY Condition : FCC CLASS-B_BAND 4 3m HORN 9120D-HF VERTICAL Detector : Peak Project : 3N0602-02 Mode : 5</p>

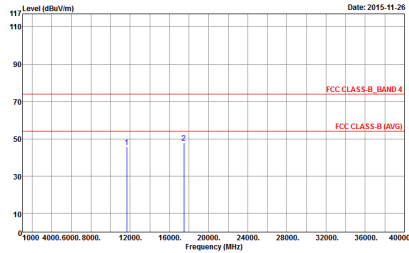
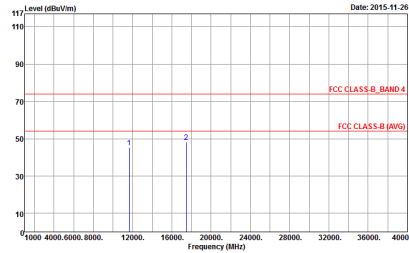

WIFI	Band 4 5725~5850MHz Harmonic @ 3m	
ANT	802.11n HT20 CH165 5825MHz	
1	Horizontal	Vertical
<p>Peak Avg.</p>	 <p>Site : 03CH10-HY Condition : FCC CLASS-B_BAND 4 3m HORN 9120D-HF HORIZONTAL Detector : Peak Project : 3N0602-02 Mode : 6</p>	 <p>Site : 03CH10-HY Condition : FCC CLASS-B_BAND 4 3m HORN 9120D-HF VERTICAL Detector : Peak Project : 3N0602-02 Mode : 6</p>



Emission below 1GHz
5GHz WIFI 802.11n HT20 (LF)

WIFI	5GHz 5725~5850MHz	
ANT	802.11n HT20 LF	
1	Horizontal	Vertical
QP / Peak	<p>Site : 03GH10-HY Condition : FCC CLASS-B 3m BI-LOG 6111D-LF HORIZONTAL Detector : Peak Project : 3N0602-02 Mode : 25</p>	<p>Site : 03GH10-HY Condition : FCC CLASS-B 3m BI-LOG 6111D-LF VERTICAL Detector : Peak Project : 3N0602-02 Mode : 25</p>



Note symbol

-L	Low channel location
-R	High channel location



Band 4 - 5725~5850MHz
WIFI 802.11a (Band Edge @ 3m)

WIFI	Band 4 5725~5850MHz Band Edge @ 3m	
ANT	802.11a CH149 5745MHz	
2	Horizontal	Vertical
Peak	<p>Site : 03CH10-HY Condition : FCC CLASS-B_BAND 4 3m HORN 9120D-HF HORIZONTAL Detector : Peak Project : 3N0602-02 Mode : 13</p>	<p>Site : 03CH10-HY Condition : FCC CLASS-B_BAND 4 3m HORN 9120D-HF VERTICAL Detector : Peak Project : 3N0602-02 Mode : 13</p>
Avg.	<p>Site : 03CH10-HY Condition : FCC CLASS-B (AVG) 3m HORN 9120D-HF HORIZONTAL Detector : Peak Project : 3N0602-02 Mode : 13</p>	<p>Site : 03CH10-HY Condition : FCC CLASS-B (AVG) 3m HORN 9120D-HF VERTICAL Detector : Peak Project : 3N0602-02 Mode : 13</p>

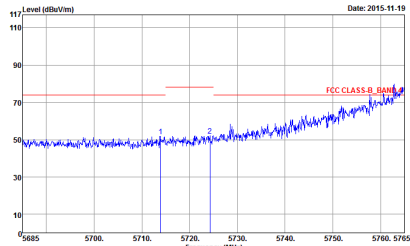
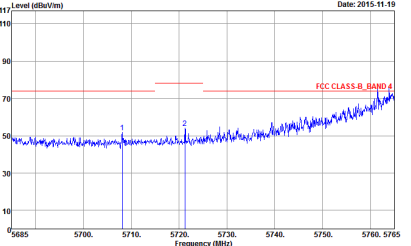
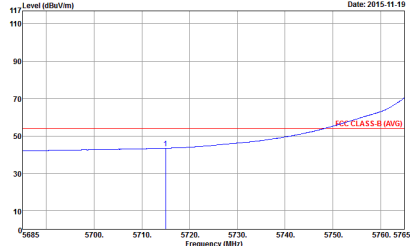
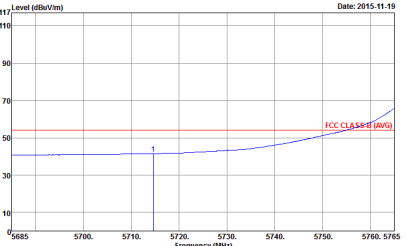

WIFI	Band 4 5725~5850MHz Band Edge @ 3m	
ANT	802.11a CH157 5785MHz - L	
2	Horizontal	Vertical
Peak	 <p>Site : 03CH10-HY Condition : FCC CLASS-B_BAND 4 3m HORN 9120D-HF HORIZONTAL Detector : Peak Project : 3N0602-02 Mode : 14</p>	 <p>Site : 03CH10-HY Condition : FCC CLASS-B_BAND 4 3m HORN 9120D-HF VERTICAL Detector : Peak Project : 3N0602-02 Mode : 14</p>
Avg.	 <p>Site : 03CH10-HY Condition : FCC CLASS-B (AVG) 3m HORN 9120D-HF HORIZONTAL Detector : Peak Project : 3N0602-02 Mode : 14</p>	 <p>Site : 03CH10-HY Condition : FCC CLASS-B (AVG) 3m HORN 9120D-HF VERTICAL Detector : Peak Project : 3N0602-02 Mode : 14</p>

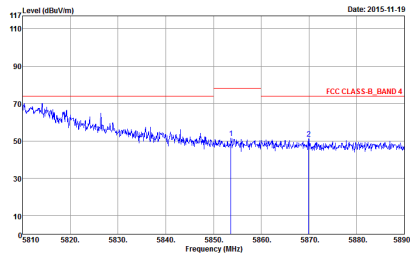
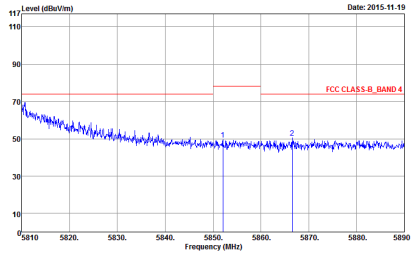
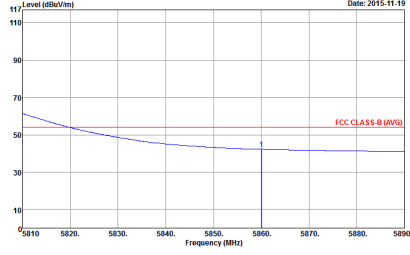
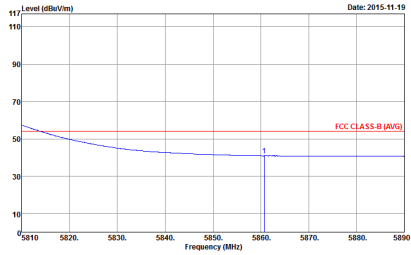

WIFI	Band 4 5725~5850MHz Band Edge @ 3m	
ANT	802.11a CH157 5785MHz - R	
2	Horizontal	Vertical
Peak	 <p>Site : 03CH10-HY Condition : FCC CLASS-B_BAND 4 3m HORN 9120D-HF HORIZONTAL RBW:1000.000KHz VBW:3000.000KHz SWT:Auto Detector : Peak Project : 3N0602-02 Mode : 14</p>	 <p>Site : 03CH10-HY Condition : FCC CLASS-B_BAND 4 3m HORN 9120D-HF VERTICAL RBW:1000.000KHz VBW:3000.000KHz SWT:Auto Detector : Peak Project : 3N0602-02 Mode : 14</p>
Avg.	 <p>Site : 03CH10-HY Condition : FCC CLASS-B (AVG) 3m HORN 9120D-HF HORIZONTAL RBW:1000.000KHz VBW:0.010KHz SWT:Auto Detector : Peak Project : 3N0602-02 Mode : 14</p>	 <p>Site : 03CH10-HY Condition : FCC CLASS-B (AVG) 3m HORN 9120D-HF VERTICAL RBW:1000.000KHz VBW:0.010KHz SWT:Auto Detector : Peak Project : 3N0602-02 Mode : 14</p>

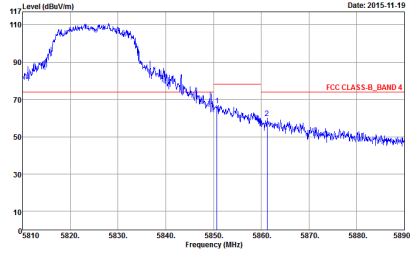
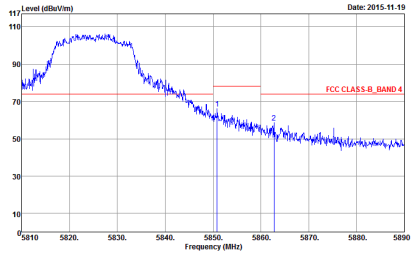
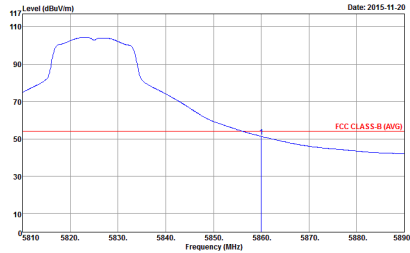
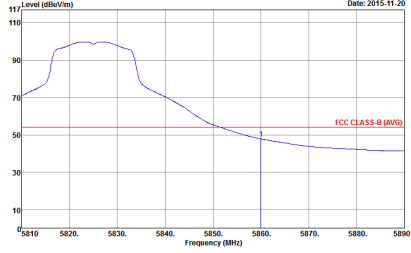

WIFI	Band 4 5725~5850MHz Band Edge @ 3m	
ANT	802.11a CH165 5825MHz	
2	Horizontal	Vertical
Peak	 <p>Site : 03CH10-HY Condition : FCC CLASS-B_BAND 4 3m HORN 9120D-HF HORIZONTAL Detector : Peak Project : 3N0602-02 Mode : 15</p>	 <p>Site : 03CH10-HY Condition : FCC CLASS-B_BAND 4 3m HORN 9120D-HF VERTICAL Detector : Peak Project : 3N0602-02 Mode : 15</p>
Avg.	 <p>Site : 03CH10-HY Condition : FCC CLASS-B (AVG) 3m HORN 9120D-HF HORIZONTAL Detector : Peak Project : 3N0602-02 Mode : 15</p>	 <p>Site : 03CH10-HY Condition : FCC CLASS-B (AVG) 3m HORN 9120D-HF VERTICAL Detector : Peak Project : 3N0602-02 Mode : 15</p>

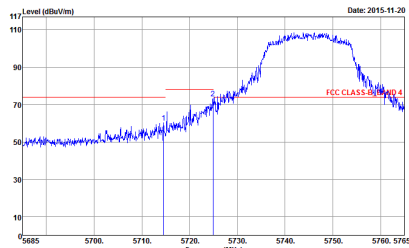
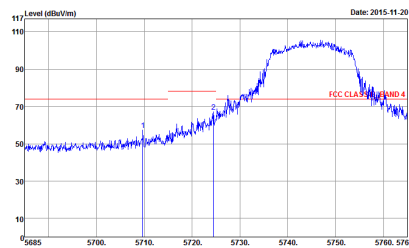
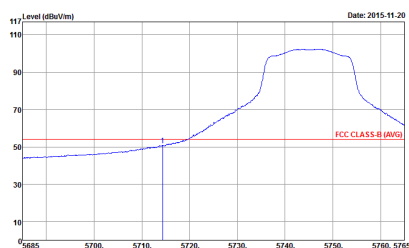
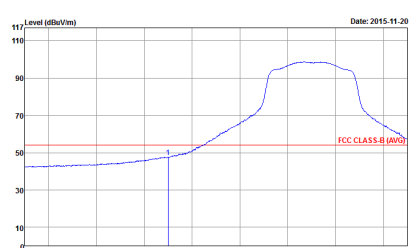

Band 4 5725~5850MHz
WIFI 802.11n HT20 (Band Edge @ 3m)

WIFI	Band 4 5725~5850MHz Band Edge @ 3m	
ANT	802.11n HT20 CH149 5745MHz	
2	Horizontal	Vertical
Peak	 <p>Site : 03CH10-HY Condition : FCC CLASS-B_BAND 4 3m HORN 9120D-HF HORIZONTAL RBW:1000.000KHz VBW:3000.000KHz SWT:Auto Detector : Peak Project : 3N0602-02 Mode : 16</p>	 <p>Site : 03CH10-HY Condition : FCC CLASS-B_BAND 4 3m HORN 9120D-HF VERTICAL RBW:1000.000KHz VBW:3000.000KHz SWT:Auto Detector : Peak Project : 3N0602-02 Mode : 16</p>
Avg.	 <p>Site : 03CH10-HY Condition : FCC CLASS-B (AVG) 3m HORN 9120D-HF HORIZONTAL RBW:1000.000KHz VBW:1.000KHz SWT:Auto Detector : Peak Project : 3N0602-02 Mode : 16</p>	 <p>Site : 03CH10-HY Condition : FCC CLASS-B (AVG) 3m HORN 9120D-HF VERTICAL RBW:1000.000KHz VBW:1.000KHz SWT:Auto Detector : Peak Project : 3N0602-02 Mode : 16</p>

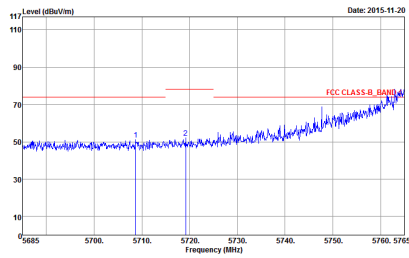
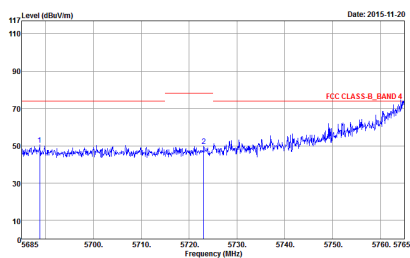
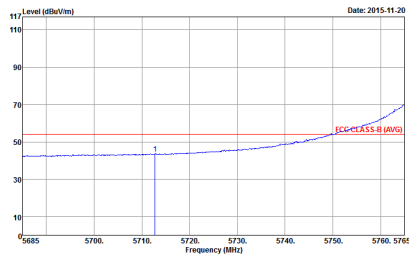
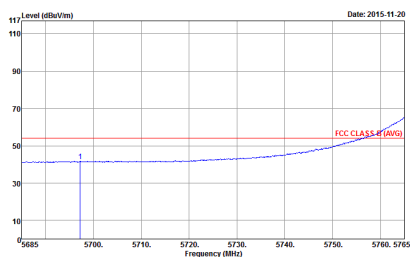

WIFI	Band 4 5725~5850MHz Band Edge @ 3m	
ANT	802.11n HT20 CH157 5785MHz - L	
2	Horizontal	Vertical
Peak	 <p>117 Level (dBuV/m) Date: 2015-11-20</p> <p>Site : 03CH10-HY Condition : FCC CLASS-B_BAND 4 3m HORN 9120D-HF HORIZONTAL Detector : Peak Project : 3N0602-02 Mode : 17</p>	 <p>117 Level (dBuV/m) Date: 2015-11-20</p> <p>Site : 03CH10-HY Condition : FCC CLASS-B_BAND 4 3m HORN 9120D-HF VERTICAL Detector : Peak Project : 3N0602-02 Mode : 17</p>
Avg.	 <p>117 Level (dBuV/m) Date: 2015-11-20</p> <p>Site : 03CH10-HY Condition : FCC CLASS-B (AVG) 3m HORN 9120D-HF HORIZONTAL Detector : Peak Project : 3N0602-02 Mode : 17</p>	 <p>117 Level (dBuV/m) Date: 2015-11-20</p> <p>Site : 03CH10-HY Condition : FCC CLASS-B (AVG) 3m HORN 9120D-HF VERTICAL Detector : Peak Project : 3N0602-02 Mode : 17</p>

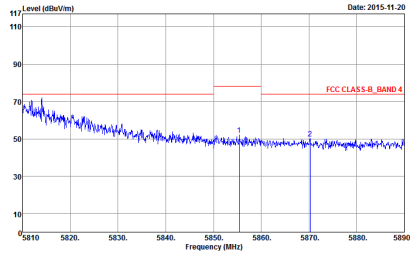
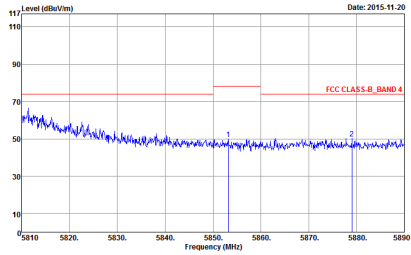
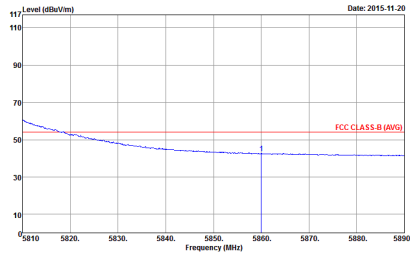
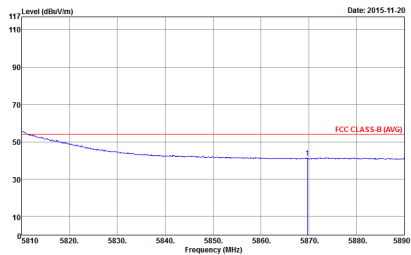

WIFI	Band 4 5725~5850MHz Band Edge @ 3m	
ANT	802.11n HT20 CH157 5785MHz - R	
2	Horizontal	Vertical
Peak	 <p>Site : 03CH10-HY Condition : FCC CLASS-B_BAND 4 3m HORN 9120D-HF HORIZONTAL RBW:1000.000KHz VBW:3000.000KHz SWT:Auto Detector : Peak Project : 3N0602-02 Mode : 17</p>	 <p>Site : 03CH10-HY Condition : FCC CLASS-B_BAND 4 3m HORN 9120D-HF VERTICAL RBW:1000.000KHz VBW:3000.000KHz SWT:Auto Detector : Peak Project : 3N0602-02 Mode : 17</p>
Avg.	 <p>Site : 03CH10-HY Condition : FCC CLASS-B (AVG) 3m HORN 9120D-HF HORIZONTAL RBW:1000.000KHz VBW:1000KHz SWT:Auto Detector : Peak Project : 3N0602-02 Mode : 17</p>	 <p>Site : 03CH10-HY Condition : FCC CLASS-B (AVG) 3m HORN 9120D-HF VERTICAL RBW:1000.000KHz VBW:1000KHz SWT:Auto Detector : Peak Project : 3N0602-02 Mode : 17</p>

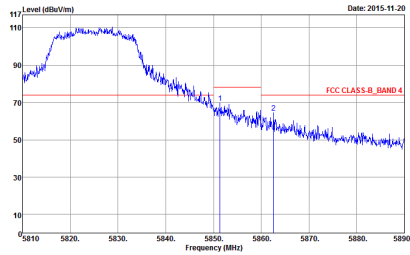
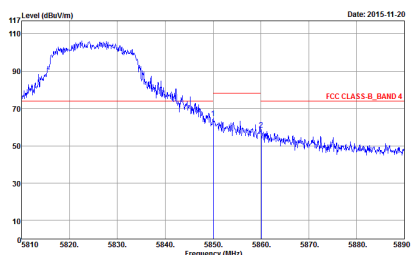
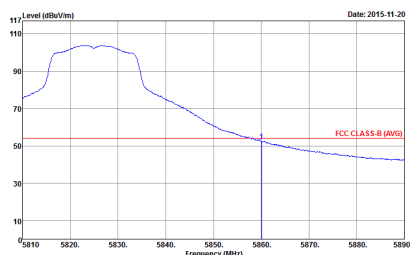
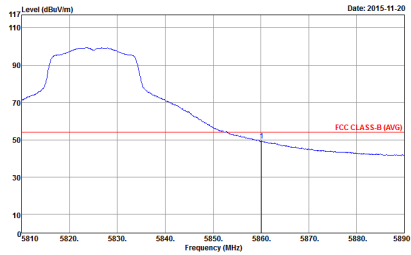

WIFI	Band 4 5725~5850MHz Band Edge @ 3m	
ANT	802.11n HT20 CH165 5825MHz	
2	Horizontal	Vertical
Peak	 <p>Site : 03CH10-HY Condition : FCC CLASS-B_BAND 4 3m HORN 9120D-HF HORIZONTAL RBW:1000.000KHz VBW:3000.000KHz SWT:Auto Detector : Peak Project : 3N0602-02 Mode : 18</p>	 <p>Site : 03CH10-HY Condition : FCC CLASS-B_BAND 4 3m HORN 9120D-HF VERTICAL RBW:1000.000KHz VBW:3000.000KHz SWT:Auto Detector : Peak Project : 3N0602-02 Mode : 18</p>
Avg.	 <p>Site : 03CH10-HY Condition : FCC CLASS-B (AVG) 3m HORN 9120D-HF HORIZONTAL RBW:1000.000KHz VBW:1.000KHz SWT:Auto Detector : Peak Project : 3N0602-02 Mode : 18</p>	 <p>Site : 03CH10-HY Condition : FCC CLASS-B (AVG) 3m HORN 9120D-HF VERTICAL RBW:1000.000KHz VBW:1.000KHz SWT:Auto Detector : Peak Project : 3N0602-02 Mode : 18</p>



Band 4 - 5725~5850MHz
WIFI 802.11a (Harmonic @ 3m)

Table with 3 columns: WIFI, ANT, and antenna orientation (Horizontal/Vertical). It contains two spectral plots showing Level (dBuV/m) vs Frequency (MHz) for Peak and Avg. measurements. The plots include FCC CLASS-B_BAND 4 and FCC CLASS-B (AVG) reference lines.

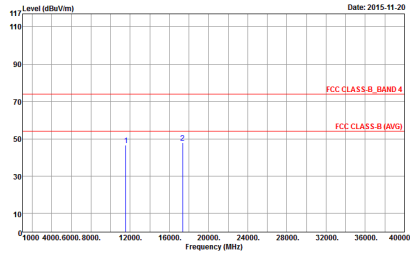
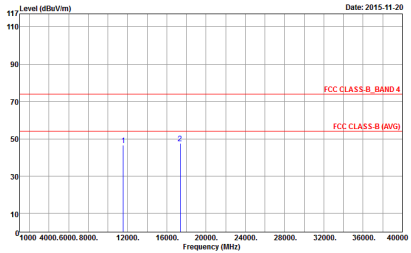

WIFI	Band 4 5725~5850MHz Harmonic @ 3m	
ANT	802.11a CH157 5785MHz	
2	Horizontal	Vertical
Peak Avg.	 <p>Site : 03CH10-HY Condition : FCC CLASS-B_BAND 4 3m HORN 9120D-HF HORIZONTAL Detector : Peak Project : 3N0602-02 Mode : 14</p>	 <p>Site : 03CH10-HY Condition : FCC CLASS-B_BAND 4 3m HORN 9120D-HF VERTICAL Detector : Peak Project : 3N0602-02 Mode : 14</p>

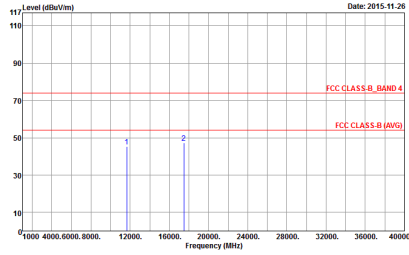
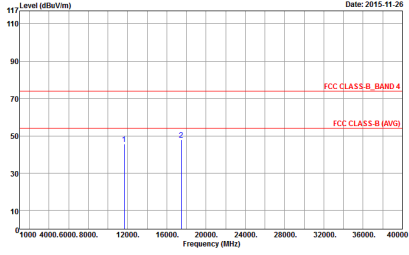

WIFI	Band 4 5725~5850MHz Harmonic @ 3m	
ANT	802.11a CH165 5825MHz	
2	Horizontal	Vertical
Peak Avg.	 <p>Site : 03CH10-HY Condition : FCC CLASS-B_BAND 4 3m HORN 9120D-HF HORIZONTAL Detector : Peak Project : 3N0602-02 Mode : 15</p>	 <p>Site : 03CH10-HY Condition : FCC CLASS-B_BAND 4 3m HORN 9120D-HF VERTICAL Detector : Peak Project : 3N0602-02 Mode : 15</p>



Band 4 5725~5850MHz
WIFI 802.11n HT20 (Harmonic @ 3m)

WIFI	Band 4 5725~5850MHz Harmonic @ 3m	
ANT	802.11n HT20 CH149 5745MHz	
2	Horizontal	Vertical
Peak Avg.	<p>Site : 03CH10-HY Condition : FCC CLASS-B_BAND 4 3m HORN 9120D-HF HORIZONTAL Detector : Peak Project : 3N0602-02 Mode : 16</p>	<p>Site : 03CH10-HY Condition : FCC CLASS-B_BAND 4 3m HORN 9120D-HF VERTICAL Detector : Peak Project : 3N0602-02 Mode : 16</p>

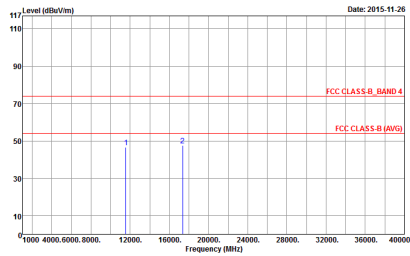
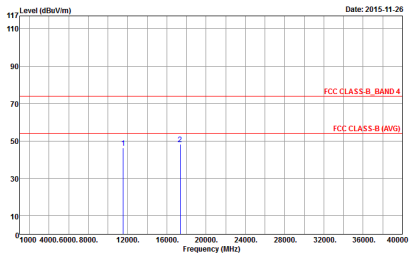

WIFI	Band 4 5725~5850MHz Harmonic @ 3m	
ANT	802.11n HT20 CH157 5785MHz	
2	Horizontal	Vertical
Peak Avg.	 <p>Site : 03CH10-HY Condition : FCC CLASS-B_BAND 4 3m HORN 9120D-HF HORIZONTAL Detector : Peak Project : 3N0602-02 Mode : 17</p>	 <p>Site : 03CH10-HY Condition : FCC CLASS-B_BAND 4 3m HORN 9120D-HF VERTICAL Detector : Peak Project : 3N0602-02 Mode : 17</p>

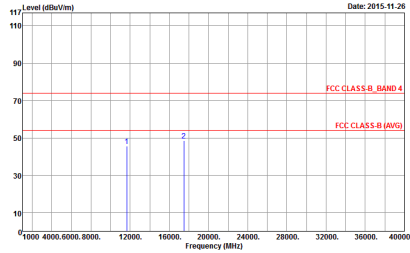
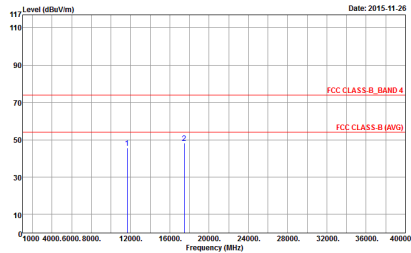

WIFI	Band 4 5725~5850MHz Harmonic @ 3m	
ANT	802.11n HT20 CH165 5825MHz	
2	Horizontal	Vertical
<p>Peak Avg.</p>	 <p>Site : 03CH10-HY Condition : FCC CLASS-B_BAND 4 3m HORN 9120D-HF HORIZONTAL Detector : Peak Project : 3N0602-02 Mode : 18</p>	 <p>Site : 03CH10-HY Condition : FCC CLASS-B_BAND 4 3m HORN 9120D-HF VERTICAL Detector : Peak Project : 3N0602-02 Mode : 18</p>



Emission below 1GHz
5GHz WIFI 802.11n HT20 (LF)

Table with 3 columns: WIFI (5GHz 5725~5850MHz), ANT (802.11n HT20 LF), and 2 (Horizontal/Vertical). It contains two spectral plots showing Level (dBuV/m) vs Frequency (MHz) for QP / Peak. The plots include FCC CLASS B limits and various test parameters like Site, Condition, Detector, Project, and Mode.