



# FCC TEST REPORT (BLUETOOTH)

**REPORT NO.:** RF111028C08A-2

**MODEL NO.:** 21-148603-0B

**FCC ID:** UZ7211486030B

**RECEIVED:** Oct. 28, 2011

**TESTED:** Nov. 25 to Dec. 06, 2011

**ISSUED:** Mar. 09, 2012

**APPLICANT:** Motorola Solutions, Inc.

**ADDRESS:** 1 Motorola Plaza, Holtsville, NY 11742-1300 USA

**ISSUED BY:** Bureau Veritas Consumer Products Services (H.K.)  
Ltd., Taoyuan Branch Hsin Chu Laboratory

**LAB ADDRESS:** No. 81-1, Lu Liao Keng, 9th Ling, Wu Lung Tsuen,  
Chiung Lin Hsiang, Hsin Chu Hsien 307, Taiwan

**TEST LOCATION (1):** No. 81-1, Lu Liao Keng, 9th Ling, Wu Lung Tsuen,  
Chiung Lin Hsiang, Hsin Chu Hsien 307, Taiwan

**TEST LOCATION (2):** No.49, Ln. 206, Wende Rd., Shangshan Tsuen,  
Chiung Lin Hsiang, Hsin Chu Hsien 307, Taiwan

This test report consists of 72 pages in total. It may be duplicated completely for legal use with the approval of the applicant. It should not be reproduced except in full, without the written approval of our laboratory. The client should not use it to claim product certification, approval, or endorsement by TAF or any government agencies. The test results in the report only apply to the tested sample.





# TABLE OF CONTENTS

RELEASE CONTROL RECORD .....	4
1 CERTIFICATION .....	5
2 SUMMARY OF TEST RESULTS.....	6
2.1 MEASUREMENT UNCERTAINTY .....	7
3 GENERAL INFORMATION .....	8
3.1 GENERAL DESCRIPTION OF EUT.....	8
3.2 DESCRIPTION OF TEST MODES.....	10
3.3 TEST MODE APPLICABILITY AND TESTED CHANNEL DETAIL: .....	11
3.4 GENERAL DESCRIPTION OF APPLIED STANDARDS .....	13
3.5 DESCRIPTION OF SUPPORT UNITS .....	14
3.6 CONFIGURATION OF SYSTEM UNDER TEST.....	15
4 TEST PROCEDURES AND RESULTS .....	16
4.1 CONDUCTED EMISSION MEASUREMENT .....	16
4.1.1 LIMITS OF CONDUCTED EMISSION MEASUREMENT.....	16
4.1.2 TEST INSTRUMENTS.....	16
4.1.3 TEST PROCEDURES .....	17
4.1.4 TEST SETUP .....	17
4.1.5 EUT OPERATING CONDITIONS.....	18
4.1.6 TEST RESULTS .....	19
4.2 RADIATED EMISSION MEASUREMENT .....	21
4.2.1 LIMITS OF RADIATED EMISSION MEASUREMENT .....	21
4.2.2 TEST INSTRUMENTS.....	22
4.2.3 TEST PROCEDURES .....	23
4.2.4 DEVIATION FROM TEST STANDARD .....	23
4.2.5 TEST SETUP .....	24
4.2.6 EUT OPERATING CONDITIONS.....	24
4.2.7 TEST RESULTS .....	25
4.3 NUMBER OF HOPPING FREQUENCY USED .....	40
4.3.1 LIMIT OF HOPPING FREQUENCY USED.....	40
4.3.2 TEST INSTRUMENTS.....	40
4.3.3 TEST PROCEDURES .....	40
4.3.4 DEVIATION FROM TEST STANDARD .....	40
4.3.5 TEST SETUP .....	41
4.3.6 TEST RESULTS .....	41
4.4 DWELL TIME ON EACH CHANNEL .....	44
4.4.1 LIMIT OF DWELL TIME USED .....	44
4.4.2 TEST INSTRUMENTS.....	44
4.4.3 TEST PROCEDURES .....	44
4.4.4 DEVIATION FROM TEST STANDARD .....	45
4.4.5 TEST SETUP .....	45
4.4.6 TEST RESULTS .....	46
4.5 CHANNEL BANDWIDTH .....	54
4.5.1 LIMITS OF CHANNEL BANDWIDTH .....	54



A D T

4.5.2	TEST INSTRUMENTS.....	54
4.5.3	TEST PROCEDURE.....	54
4.5.4	DEVIATION FROM TEST STANDARD .....	54
4.5.5	TEST SETUP .....	55
4.5.6	EUT OPERATING CONDITION.....	55
4.5.7	TEST RESULTS.....	56
4.6	HOPPING CHANNEL SEPARATION .....	58
4.6.1	LIMIT OF HOPPING CHANNEL SEPARATION.....	58
4.6.2	TEST INSTRUMENTS.....	58
4.6.3	TEST PROCEDURES .....	58
4.6.4	DEVIATION FROM TEST STANDARD .....	58
4.6.5	TEST SETUP .....	58
4.6.6	TEST RESULTS.....	59
4.7	MAXIMUM PEAK OUTPUT POWER .....	61
4.7.1	LIMITS OF MAXIMUM PEAK OUTPUT POWER MEASUREMENT .....	61
4.7.2	INSTRUMENTS .....	61
4.7.3	TEST PROCEDURES .....	61
4.7.4	DEVIATION FROM TEST STANDARD .....	61
4.7.5	TEST SETUP .....	62
4.7.6	EUT OPERATING CONDITION.....	62
4.7.7	TEST RESULTS.....	63
4.8	CONDUCTED OUT-BAND EMISSION MEASUREMENT.....	65
4.8.1	LIMITS OF CONDUCTED OUT-BAND EMISSION MEASUREMENT.....	65
4.8.2	TEST INSTRUMENTS.....	65
4.8.3	TEST PROCEDURE.....	65
4.8.4	DEVIATION FROM TEST STANDARD .....	65
4.8.5	EUT OPERATING CONDITION .....	65
4.8.6	TEST RESULTS.....	66
5	INFORMATION ON THE TESTING LABORATORIES.....	71
6	APPENDIX A - MODIFICATIONS RECORDERS FOR ENGINEERING CHANGES TO THE EUT BY THE LAB.....	72



A D T

## RELEASE CONTROL RECORD

ISSUE NO.	REASON FOR CHANGE	DATE ISSUED
RF111028C08A-2	Original release	Mar. 09, 2012



# 1 CERTIFICATION

**PRODUCT :** Radio Module  
**BRAND NAME :** Motorola  
**MODEL NO. :** 21-148603-0B  
**TEST SAMPLE :** ENGINEERING SAMPLE  
**APPLICANT :** Motorola Solutions, Inc.  
**TESTED DATE :** Nov. 25 to Dec. 06, 2011  
**STANDARDS :** FCC Part 15, Subpart C (Section 15.247)  
ANSI C63.4-2003  
ANSI C63.10-2009

The above equipment (Model: 21-148603-0B) has been tested by **Bureau Veritas Consumer Products Services (H.K.) Ltd., Taoyuan Branch**, and found compliance with the requirement of the above standards. The test record, data evaluation & Equipment Under Test (EUT) configurations represented herein are true and accurate accounts of the measurements of the sample's EMC characteristics under the conditions specified in this report.

**PREPARED BY :** , **DATE:** Mar. 09, 2012  
( Midoli Peng, Specialist )

**APPROVED BY :** , **DATE:** Mar. 09, 2012  
( May Chen, Deputy Manager )

## 2 SUMMARY OF TEST RESULTS

The EUT has been tested according to the following specifications:

APPLIED STANDARD: FCC Part 15, Subpart C			
STANDARD SECTION	TEST TYPE AND LIMIT	RESULT	REMARK
15.207	AC Power Conducted Emission	PASS	Meet the requirement of limit. Minimum passing margin is -17.95dB at 7.168MHz.
15.247(a)(1)(iii)	Number of Hopping Frequency Used Spec.: At least 15 channels	PASS	Meet the requirement of limit.
15.247(a)(1)(iii)	Dwell Time on Each Channel Spec.: Max. 0.4 second within 31.6 second	PASS	Meet the requirement of limit.
15.247(a)(1)	1. Hopping Channel Separation Spec.: Min. 25 kHz or 20 dB bandwidth, whichever is greater 2. Spectrum Bandwidth of a Frequency Hopping Sequence Spread Spectrum System	PASS	Meet the requirement of limit.
15.247(b)	Maximum Peak Output Power Spec.: max. 21dBm	PASS	Meet the requirement of limit.
15.247(d)	Transmitter Radiated Emissions Spec.: Table 15.209	PASS	Meet the requirement of limit. Minimum passing margin is -6.5dB at 2483.5MHz.
15.247(d)	Conducted Out-Band Emission Measurement	PASS	Meet the requirement of limit.
15.203	Antenna Requirement	PASS	Antenna connector is Reverse SMA not a standard connector.

**NOTE:** If The Frequency Hopping System operating in 2400-2483.5MHz band and the output power less than 125mW. The hopping channel carrier frequencies separated by a minimum of 25kHz or two-thirds of the 20dB bandwidth of hopping channel whichever is greater.

## 2.1 MEASUREMENT UNCERTAINTY

Where relevant, the following measurement uncertainty levels have been estimated for tests performed on the EUT as specified in CISPR 16-4-2:

This uncertainty represents an expanded uncertainty expressed at approximately the 95% confidence level using a coverage factor of  $k=2$ .

Measurement	Value
Conducted emissions	2.45 dB
Radiated emissions (30MHz-1GHz)	3.89 dB
Radiated emissions (1GHz -18GHz)	2.19 dB
Radiated emissions (18GHz -40GHz)	2.56 dB

### 3 GENERAL INFORMATION

#### 3.1 GENERAL DESCRIPTION OF EUT

<b>PRODUCT</b>	Radio Module
<b>MODEL NO.</b>	21-148603-0B
<b>FCC ID</b>	UZ7211486030B
<b>POWER SUPPLY</b>	DC 3.3V
<b>MODULATION TYPE</b>	GFSK, $\pi/4$ -DQPSK, 8DPSK
<b>MODULATION TECHNOLOGY</b>	FHSS
<b>DATE RATE</b>	1/2/3Mbps
<b>FREQUENCY RANGE</b>	2402MHz ~ 2480MHz
<b>NUMBER OF CHANNEL</b>	79
<b>MAX. OUTPUT POWER</b>	14.791mW
<b>ANTENNA TYPE</b>	Please see note
<b>DATA CABLE</b>	NA
<b>I/O PORTS</b>	NA
<b>ASSOCIATED DEVICES</b>	NA

**NOTE:**

1. There are Bluetooth technology, GPS technology and WLAN technology used for the EUT and the functions of EUT listed as below table:

<b>Function</b>	<b>Report No.</b>
WLAN	RF111028C08A (FCC Part15C) RF111028C08A-1(FCC Part15E)
Bluetooth	RF111028C08A-2





A D T

2. The antennas provided to the EUT, please refer to the following table:

No.	Type	Connector	Model	Peak Gain (dBi)	Cable loss (dB)	Net Peak Gain (dBi)	Trace
1	Dipole-1	Reverse SMA	ML-2452-APA2-01 Rev C	2.4GHz : 3 5GHz : 5	2.4GHz : 0.75 5GHz : 1.3	2.4GHz : 2.25 5GHz : 3.7	WiFi
2	Dipole-2	Reverse SMA	C492-510032-A	1.8	2.35	-0.55	BT
3	Chip	Reverse SMA	NA	-	-		GPS

3. The EUT was included two SKU, which are identical to each other in all aspects except for the following table:

	P/N	Description
SKU #1	21-148603-02	Diversity version with WLAN and BT on SEPARATE RF paths
SKU #2	21-148603-04	NON-Diversity version with WLAN and BT on SEPARATE RF paths

**SKU #1**, the worse case one, was chosen for final test.

4. Spurious Emission of the simultaneous operation (WiFi & Bluetooth) have been evaluated and no non-compliance found. (The device can transmit simultaneously on WLAN (5GHz) mode and Bluetooth mode; other modes can't support simultaneously ability.)

5. The above EUT information was declared by the manufacturer and for more detailed features description, please refer to the manufacturer's specifications or User's manual.



### 3.2 DESCRIPTION OF TEST MODES

Seventy-nine channels are provided for Bluetooth.

Channel	Freq. (MHz)	Channel	Freq. (MHz)	Channel	Freq. (MHz)	Channel	Freq. (MHz)
0	2402	20	2422	40	2442	60	2462
1	2403	21	2423	41	2443	61	2463
2	2404	22	2424	42	2444	62	2464
3	2405	23	2425	43	2445	63	2465
4	2406	24	2426	44	2446	64	2466
5	2407	25	2427	45	2447	65	2467
6	2408	26	2428	46	2448	66	2468
7	2409	27	2429	47	2449	67	2469
8	2410	28	2430	48	2450	68	2470
9	2411	29	2431	49	2451	69	2471
10	2412	30	2432	50	2452	70	2472
11	2413	31	2433	51	2453	71	2473
12	2414	32	2434	52	2454	72	2474
13	2415	33	2435	53	2455	73	2475
14	2416	34	2436	54	2456	74	2476
15	2417	35	2437	55	2457	75	2477
16	2418	36	2438	56	2458	76	2478
17	2419	37	2439	57	2459	77	2479
18	2420	38	2440	58	2460	78	2480
19	2421	39	2441	59	2461		



### 3.3 TEST MODE APPLICABILITY AND TESTED CHANNEL DETAIL:

EUT CONFIGURE MODE	APPLICABLE TO					DESCRIPTION
	PLC	RE < 1G	RE ≥ 1G	APCM	OB	
-	√	√	√	√	√	-

Where **PLC**: Power Line Conducted Emission      **RE < 1G**: Radiated Emission below 1GHz  
**RE ≥ 1G**: Radiated Emission above 1GHz      **APCM**: Antenna Port Conducted Measurement  
**OB**: Conducted Out-Band Emission Measurement

#### **Power Line Conducted Emission Test:**

- Pre-Scan has been conducted to determine the worst-case mode from all possible combinations between available modulations, data rates and antenna ports (if EUT with antenna diversity architecture).
- Following channel(s) was (were) selected for the final test as listed below.

Available Channel	Tested Channel	Modulation Technology	Modulation Type	Packet Type
0 to 78	0	FHSS	8DPSK	DH5

#### **Radiated Emission Test (Below 1 GHz):**

- Pre-Scan has been conducted to determine the worst-case mode from all possible combinations between available modulations, data rates and antenna ports (if EUT with antenna diversity architecture).
- Following channel(s) was (were) selected for the final test as listed below.

Available Channel	Tested Channel	Modulation Technology	Modulation Type	Packet Type
0 to 78	0	FHSS	8DPSK	DH5

#### **Radiated Emission Test (Above 1 GHz):**

- Pre-Scan has been conducted to determine the worst-case mode from all possible combinations between available modulations, data rates and antenna ports (if EUT with antenna diversity architecture).
- Following channel(s) was (were) selected for the final test as listed below.

Available Channel	Tested Channel	Modulation Technology	Modulation Type	Packet Type
0 to 78	0, 39, 78	FHSS	GFSK	DH5
0 to 78	0, 39, 78	FHSS	8DPSK	DH5

**Antenna Port Conducted Measurement:**

- Pre-Scan has been conducted to determine the worst-case mode from all possible combinations between available modulations, data rates and antenna ports (if EUT with antenna diversity architecture).
- Following channel(s) was (were) selected for the final test as listed below.

Available Channel	Tested Channel	Modulation Technology	Modulation Type	Packet Type
0 to 78	0, 39, 78	FHSS	GFSK	DH5
0 to 78	0, 39, 78	FHSS	8DPSK	DH5

**Conducted Out-Band Emission Measurement:**

- Pre-Scan has been conducted to determine the worst-case mode from all possible combinations between available modulations, data rates and antenna ports (if EUT with antenna diversity architecture).
- Following channel(s) was (were) selected for the final test as listed below.

Available Channel	Tested Channel	Modulation Technology	Modulation Type	Packet Type
0 to 78	0, 78	FHSS	GFSK	DH5
0 to 78	0, 78	FHSS	8DPSK	DH5

**TEST CONDITION:**

APPLICABLE TO	ENVIRONMENTAL CONDITIONS	INPUT POWER	TESTED BY
PLC	26deg. C, 68%RH	120Vac, 60Hz(system)	Andy Ho
RE<1G	18deg. C, 64%RH	DC 3.3V	Nick Chang
RE <sup>3</sup> 1G	26deg. C, 68%RH	DC 3.3V	Nelson Teng
APCM	25deg. C, 60%RH	DC 3.3V	Kent Liu
OB	25deg. C, 60%RH	DC 3.3V	Kent Liu



### **3.4 GENERAL DESCRIPTION OF APPLIED STANDARDS**

The EUT is a RF product. According to the specifications of the manufacturer, it must comply with the requirements of the following standards:

**FCC Part 15, Subpart C. (15.247)**

**ANSI C63.4-2003**

**ANSI C63.10-2009**

All test items have been performed and recorded as per the above standards.

**NOTE:** The EUT is also considered as a kind of computer peripheral, because the connection to computer is necessary for typical use. It has been verified to comply with the requirements of FCC Part 15, Subpart B, Class B (DoC). The test report has been issued separately.

### 3.5 DESCRIPTION OF SUPPORT UNITS

The EUT has been tested as an independent unit together with other necessary accessories or support units. The following support units or accessories were used to form a representative test configuration during the tests.

No.	Product	Brand	Model No.	Serial No.	FCC ID
1	NOTEBOOK COMPUTER	DELL	PP32LA	FSLB32S	FCC DoC
2	DC POWER SUPPLY	Topward	6603D	795558	NA

No.	Signal cable description
1	USB cable (1.8m with one core)
2	DC line (2m)

Note: 1. All power cords of the above support units are unshielded (1.8m).

### 3.6 CONFIGURATION OF SYSTEM UNDER TEST

For Conducted Emission test:

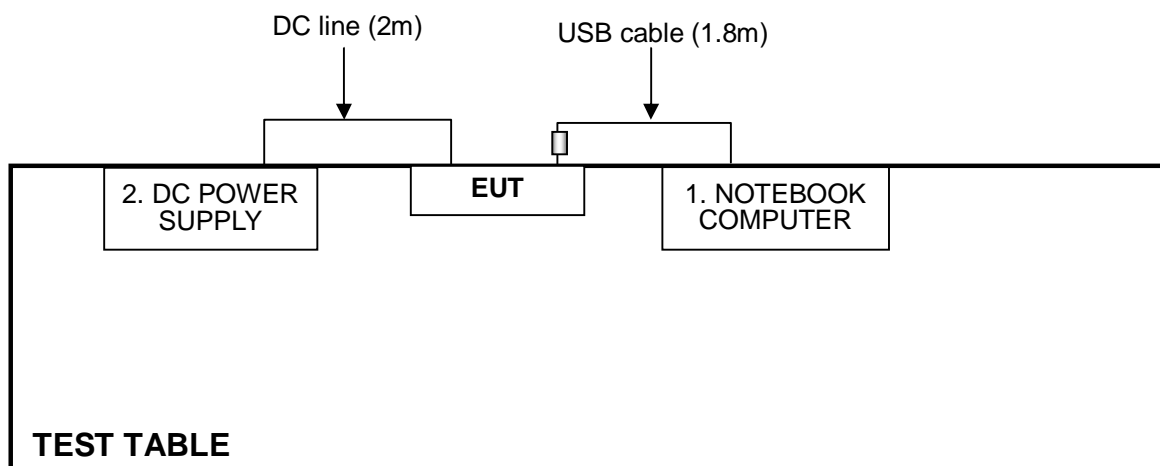

For other test items:

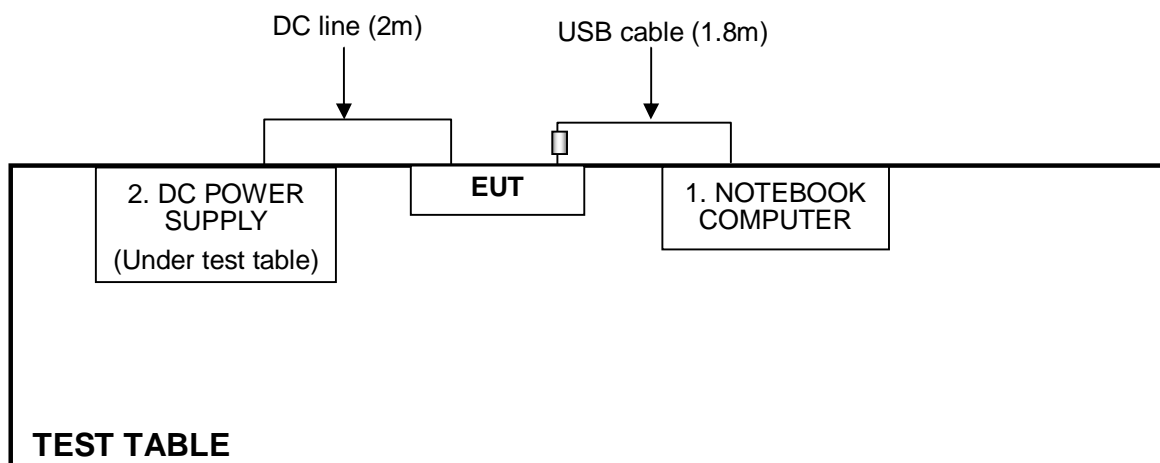

## 4 TEST PROCEDURES AND RESULTS

### 4.1 CONDUCTED EMISSION MEASUREMENT

#### 4.1.1 LIMITS OF CONDUCTED EMISSION MEASUREMENT

FREQUENCY OF EMISSION (MHz)	CONDUCTED LIMIT (dB $\mu$ V)	
	Quasi-peak	Average
0.15-0.5	66 to 56	56 to 46
0.5-5	56	46
5-30	60	50

**NOTE:**

1. The lower limit shall apply at the transition frequencies.
2. All emanations from a class B digital device or system, including any network of conductors and apparatus connected thereto, shall not exceed the level of field strengths specified above.

#### 4.1.2 TEST INSTRUMENTS

Test date: Nov. 25, 2011

DESCRIPTION & MANUFACTURER	MODEL NO.	SERIAL NO.	CALIBRATED DATE	CALIBRATED UNTIL
Test Receiver	ESCS 30	100375	Mar. 09, 2011	Mar. 08, 2012
Line-Impedance Stabilization Network (for EUT)	NSLK8127	8127-522	Sep. 07, 2011	Sep. 06, 2012
Line-Impedance Stabilization Network (for Peripheral)	ESH3-Z5	848773/004	Nov. 01, 2011	Oct. 31, 2012
RF Cable (JYEBAO)	5DFB	COCCAB-002	Aug. 29, 2011	Aug. 28, 2012
50 ohms Terminator	50	3	Nov. 02, 2011	Nov. 01, 2012
Software	BV ADT_Cond_V7.3.7	NA	NA	NA

**Note:**

1. The calibration interval of the above test instruments is 12 months and the calibrations are traceable to NML/ROC and NIST/USA.
2. The test was performed in Shielded Room No. C.
3. The VCCI Con C Registration No. is C-3611.



#### 4.1.3 TEST PROCEDURES

- The EUT/HOST was placed 0.4 meters from the conducting wall of the shielded room with EUT/HOST being connected to the power mains through a line impedance stabilization network (LISN). Other support units were connected to the power mains through another LISN. The two LISNs provide 50 ohm/ 50uH of coupling impedance for the measuring instrument.
- Both lines of the power mains connected to the EUT/HOST were checked for maximum conducted interference.
- The frequency range from 150 kHz to 30 MHz was searched. Emission levels over 10dB under the prescribed limits could not be reported

#### 4.1.4 TEST SETUP

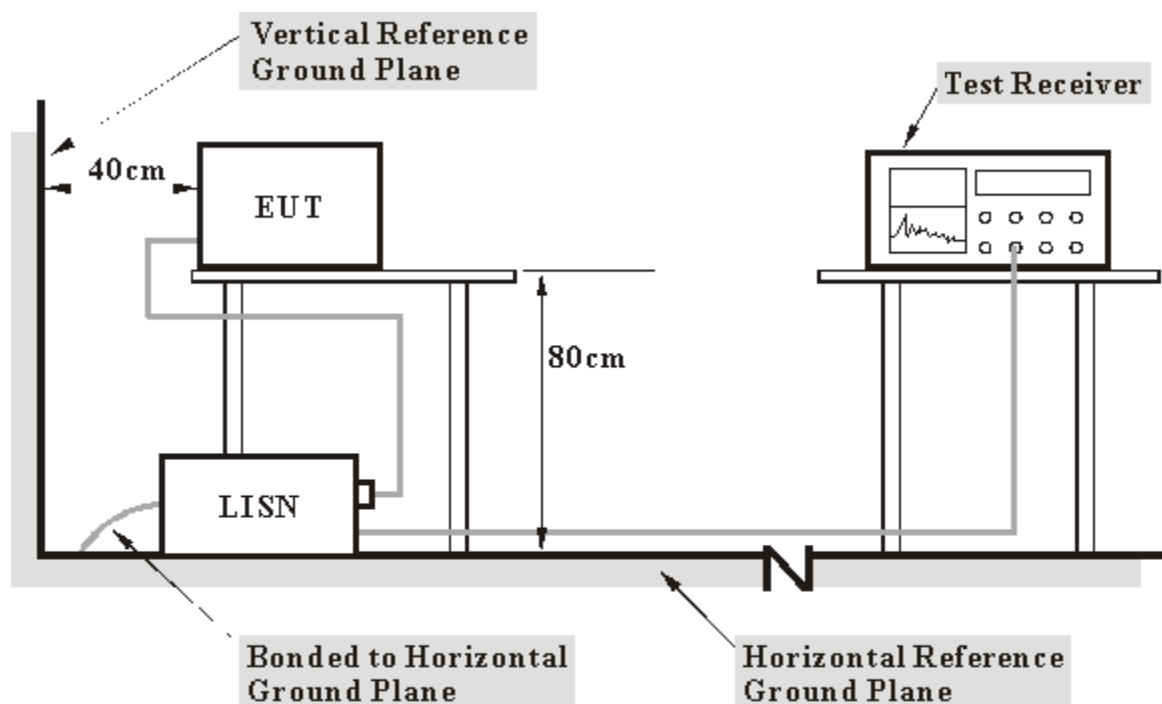

- Note:**
- Support units were connected to second LISN.
  - Both of LISNs (AMN) 80 cm from EUT and at the least 80 cm from other units and other metal planes support units.

For the actual test configuration, please refer to the related item – Photographs of the Test Configuration.

#### 4.1.5 EUT OPERATING CONDITIONS

1. Connect the EUT with the support unit 1 (Notebook Computer) which is placed on a testing table.
2. The communication partner run test program “RTTT.exe” to enable EUT under transmission/receiving condition continuously at specific channel frequency.

### 4.1.6 TEST RESULTS

<b>PHASE</b>	Line (L)	<b>6dB BANDWIDTH</b>	9 kHz
--------------	----------	----------------------	-------

No	Freq.	Corr.	Reading Value		Emission Level		Limit		Margin	
	[MHz]	Factor (dB)	[dB (uV)]		[dB (uV)]		[dB (uV)]		(dB)	
			Q.P.	AV.	Q.P.	AV.	Q.P.	AV.	Q.P.	AV.
1	0.341	0.11	10.11	-4.95	10.22	-4.84	59.17	49.17	-48.95	-54.01
2	5.109	0.36	33.90	25.91	34.26	26.27	60.00	50.00	-25.74	-23.73
3	7.164	0.44	34.27	32.69	34.71	33.13	60.00	50.00	-25.29	-16.87
4	9.891	0.55	27.57	23.48	28.12	24.03	60.00	50.00	-31.88	-25.97
5	11.953	0.59	25.34	20.99	25.93	21.58	60.00	50.00	-34.07	-28.42
6	24.001	0.86	22.70	22.67	23.56	23.53	60.00	50.00	-36.44	-26.47

- REMARKS:**
1. Q.P. and AV. are abbreviations of quasi-peak and average individually.
  2. The emission levels of other frequencies were very low against the limit.
  3. Margin value = Emission level - Limit value
  4. Correction factor = Insertion loss + Cable loss
  5. Emission Level = Correction Factor + Reading Value.

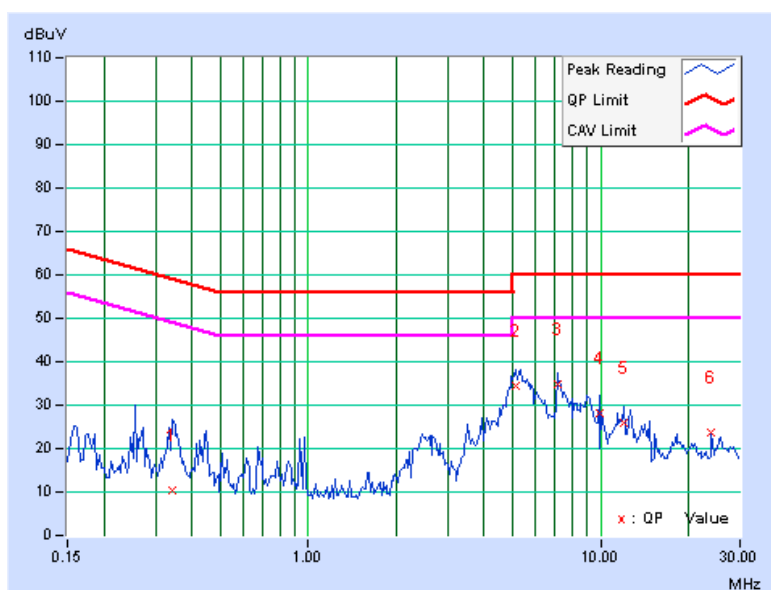



A D T

<b>PHASE</b>	Neutral (N)	<b>6dB BANDWIDTH</b>	9 kHz
--------------	-------------	----------------------	-------

No	Freq.	Corr.	Reading Value		Emission Level		Limit		Margin	
	[MHz]	Factor (dB)	[dB (uV)]		[dB (uV)]		[dB (uV)]		(dB)	
			Q.P.	AV.	Q.P.	AV.	Q.P.	AV.	Q.P.	AV.
1	0.185	0.09	12.41	2.74	12.50	2.83	64.25	54.25	-51.76	-51.43
2	5.254	0.28	34.96	27.80	35.24	28.08	60.00	50.00	-24.76	-21.92
<b>3</b>	<b>7.168</b>	<b>0.33</b>	<b>34.21</b>	<b>31.72</b>	<b>34.54</b>	<b>32.05</b>	<b>60.00</b>	<b>50.00</b>	<b>-25.46</b>	<b>-17.95</b>
4	7.980	0.35	26.07	18.40	26.42	18.75	60.00	50.00	-33.58	-31.25
5	11.430	0.45	23.44	17.43	23.89	17.88	60.00	50.00	-36.11	-32.12
6	24.000	0.75	29.18	28.24	29.93	28.99	60.00	50.00	-30.07	-21.01

- REMARKS:**
1. Q.P. and AV. are abbreviations of quasi-peak and average individually.
  2. The emission levels of other frequencies were very low against the limit.
  3. Margin value = Emission level - Limit value
  4. Correction factor = Insertion loss + Cable loss
  5. Emission Level = Correction Factor + Reading Value.

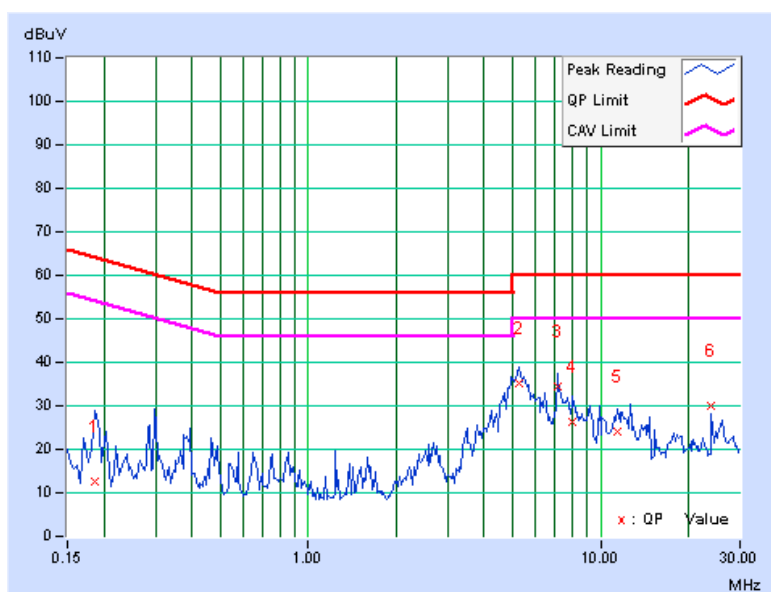

## 4.2 RADIATED EMISSION MEASUREMENT

### 4.2.1 LIMITS OF RADIATED EMISSION MEASUREMENT

Emissions radiated outside of the specified bands, shall be according to the general radiated limits in 15.209 as following:

FREQUENCIES (MHz)	FIELD STRENGTH (microvolts/meter)	MEASUREMENT DISTANCE (meters)
0.009 ~ 0.490	2400/F(kHz)	300
0.490 ~ 1.705	24000/F(kHz)	30
1.705 ~ 30.0	30	30
30 ~ 88	100	3
88 ~ 216	150	3
216 ~ 960	200	3
Above 960	500	3

**NOTE:**

1. The lower limit shall apply at the transition frequencies.
2. Emission level (dBuV/m) = 20 log Emission level (uV/m).
3. As shown in 15.35(b), for frequencies above 1000MHz, the field strength limits are based on average detector, however, the peak field strength of any emission shall not exceed the maximum permitted average limits, specified above by more than 20dB under any condition of modulation.
4. Section 15.205 restricted bands of operation shall compliance with the limits in Section 15.209.



A D T

## 4.2.2 TEST INSTRUMENTS

Test date: Nov. 26 to Dec. 06, 2011

DESCRIPTION & MANUFACTURER	MODEL NO.	SERIAL NO.	CALIBRATED DATE	CALIBRATED UNTIL
Agilent Spectrum Analyzer	E4446A	MY48250253	Aug. 29, 2011	Aug. 28, 2012
Agilent Pre-Selector	N9039A	MY46520310	Aug. 29, 2011	Aug. 28, 2012
Agilent Signal Generator	N5181A	MY49060347	July 25, 2011	July 24, 2012
Mini-Circuits Pre-Amplifier	ZFL-1000VH2B	AMP-ZFL-04	Nov. 15, 2011	Nov. 14, 2012
Agilent Pre-Amplifier	8449B	3008A02465	Feb. 28, 2011	Feb. 27, 2012
SPACEK LABS	SLKKa-48-6	9K16	Nov. 15, 2011	Nov. 14, 2012
SCHWARZBECK Trilog Broadband Antenna	VULB 9168	9168-361	Apr. 14, 2011	Apr. 13, 2012
AISI Horn_Antenna	AIH.8018	0000220091110	Nov. 22, 2011	Nov. 21, 2012
SCHWARZBECK Horn_Antenna	BBHA 9170	9170-424	Oct. 07, 2011	Oct. 06, 2012
RF CABLE	NA	RF104-205 RF104-207 RF104-202	Dec. 28, 2010	Dec. 27, 2011
RF Cable	NA	CHHCAB_001	Oct. 08, 2011	Oct. 07, 2012
Software	ADT_Radiated_V8.7.05	NA	NA	NA
CT Antenna Tower & Turn Table	NA	NA	NA	NA

Note: 1. The calibration interval of the above test instruments is 12 months and the calibrations are traceable to NML/ROC and NIST/USA.

2. The horn antenna, preamplifier (model: 8449B) are used only for the measurement of emission frequency above 1GHz if tested.

3. The test was performed in 966 Chamber No. H.

4. The FCC Site Registration No. is 797305.

5. The CANADA Site Registration No. is IC 7450H-3.

#### 4.2.3 TEST PROCEDURES

- a. The EUT was placed on the top of a rotating table 0.8 meters above the ground at a 3 meters chamber room. The table was rotated 360 degrees to determine the position of the highest radiation.
- b. The EUT was set 3 meters away from the interference-receiving antenna, which was mounted on the top of a variable-height antenna tower.
- c. The height of antenna is varied from one meter to four meters above the ground to determine the maximum value of the field strength. Both horizontal and vertical polarizations of the antenna are set to make the measurement.
- d. For each suspected emission, the EUT was arranged to its worst case and then the antenna was tuned to heights from 1 meter to 4 meters and the rotatable table was turned from 0 degrees to 360 degrees to find the maximum reading.
- e. The test-receiver system was set to quasi-peak detect function and specified bandwidth with maximum hold mode when the test frequency is below 1 GHz.
- f. The test-receiver system was set to peak and average detect function and specified bandwidth with maximum hold mode when the test frequency is above 1 GHz. If the peak reading value also meets average limit, measurement with the average detector is unnecessary.

**NOTE:**

1. The resolution bandwidth and video bandwidth of test receiver/spectrum analyzer is 120kHz for Peak detection (PK) and Quasi-peak detection (QP) at frequency below 1GHz.
2. The resolution bandwidth is 1MHz and video bandwidth of test receiver/spectrum analyzer is 3MHz for Peak detection at frequency above 1GHz.
3. The resolution bandwidth of test receiver/spectrum analyzer is 1 MHz and the video bandwidth is 10 Hz for Average detection (AV) at frequency above 1GHz.

#### 4.2.4 DEVIATION FROM TEST STANDARD

No deviation

#### 4.2.5 TEST SETUP

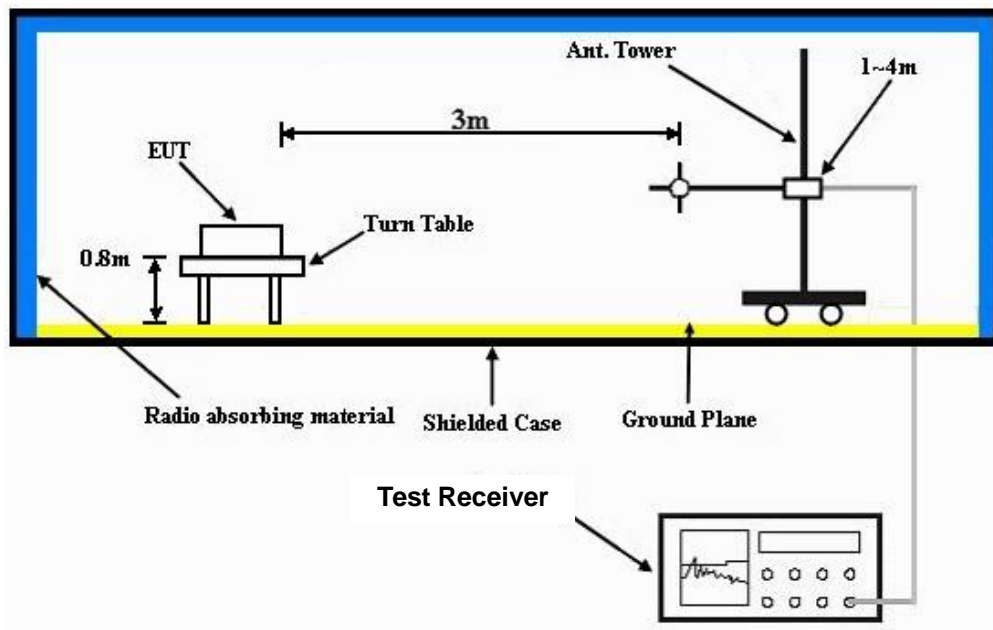

For the actual test configuration, please refer to the related item – Photographs of the Test Configuration.

#### 4.2.6 EUT OPERATING CONDITIONS

Same as 4.1.5



## 4.2.7 TEST RESULTS

### BELOW 1GHz WORST-CASE DATA : 8DPSK MODULATION

EUT TEST CONDITION		MEASUREMENT DETAIL	
CHANNEL	Channel 0	FREQUENCY RANGE	Below 1000MHz
INPUT POWER	DC 3.3V	DETECTOR FUNCTION	Quasi-Peak
ENVIRONMENTAL CONDITIONS	18deg. C, 64%RH	TESTED BY	Nick Chang

ANTENNA POLARITY & TEST DISTANCE: HORIZONTAL AT 3 M								
NO.	FREQ. (MHz)	EMISSION LEVEL (dBuV/m)	LIMIT (dBuV/m)	MARGIN (dB)	ANTENNA HEIGHT (m)	TABLE ANGLE (Degree)	RAW VALUE (dBuV)	CORRECTION FACTOR (dB/m)
1	34.38	25.8 QP	40.0	-14.2	1.50 H	265	12.37	13.39
2	160.50	33.5 QP	43.5	-10.0	2.00 H	200	19.04	14.49
3	236.06	32.6 QP	46.0	-13.4	1.00 H	51	19.83	12.75
4	360.04	31.2 QP	46.0	-14.8	1.00 H	191	14.41	16.75
5	480.01	30.1 QP	46.0	-15.9	1.47 H	240	10.53	19.58
6	720.05	30.7 QP	46.0	-15.3	1.02 H	228	7.12	23.56
7	848.89	36.3 QP	46.0	-9.7	1.02 H	152	10.07	26.20
ANTENNA POLARITY & TEST DISTANCE: VERTICAL AT 3 M								
NO.	FREQ. (MHz)	EMISSION LEVEL (dBuV/m)	LIMIT (dBuV/m)	MARGIN (dB)	ANTENNA HEIGHT (m)	TABLE ANGLE (Degree)	RAW VALUE (dBuV)	CORRECTION FACTOR (dB/m)
1	46.16	27.1 QP	40.0	-12.9	1.02 V	134	12.80	14.33
2	148.30	29.7 QP	43.5	-13.8	1.02 V	304	15.07	14.59
3	360.16	28.9 QP	46.0	-17.1	1.02 V	119	12.19	16.75
4	480.01	26.0 QP	46.0	-20.0	1.01 V	284	6.44	19.58
5	747.29	29.5 QP	46.0	-16.5	1.51 V	234	5.30	24.19
6	848.66	33.0 QP	46.0	-13.0	1.48 V	283	6.82	26.20
7	946.35	30.9 QP	46.0	-15.1	1.02 V	222	3.30	27.62

- REMARKS:**
1. Emission level (dBuV/m) = Raw Value (dBuV) + Correction Factor (dB/m).
  2. Correction Factor (dB/m) = Antenna Factor (dB/m) + Cable Factor (dB).
  3. The other emission levels were very low against the limit.
  4. Margin value = Emission level – Limit value.



A D T

## GFSK MODULATION

EUT TEST CONDITION		MEASUREMENT DETAIL	
CHANNEL	Channel 0	FREQUENCY RANGE	1 ~ 25GHz
INPUT POWER	DC 3.3V	DETECTOR FUNCTION	Peak (PK) Average (AV)
ENVIRONMENTAL CONDITIONS	26deg. C, 68%RH	TESTED BY	Nelson Teng

ANTENNA POLARITY & TEST DISTANCE: HORIZONTAL AT 3 M								
NO.	FREQ. (MHz)	EMISSION LEVEL (dBuV/m)	LIMIT (dBuV/m)	MARGIN (dB)	ANTENNA HEIGHT (m)	TABLE ANGLE (Degree)	RAW VALUE (dBuV)	CORRECTION FACTOR (dB/m)
1	2390.00	56.7 PK	74.0	-17.3	1.01 H	245	25.49	31.21
2	2390.00	43.6 AV	54.0	-10.4	1.01 H	245	12.39	31.21
3	*2402.00	98.4 PK			1.01 H	245	67.15	31.25
4	*2402.00	80.4 AV			1.01 H	245	49.15	31.25
5	4804.00	52.5 PK	74.0	-21.5	1.25 H	29	13.15	39.35
6	4804.00	41.6 AV	54.0	-12.4	1.25 H	29	2.25	39.35
ANTENNA POLARITY & TEST DISTANCE: VERTICAL AT 3 M								
NO.	FREQ. (MHz)	EMISSION LEVEL (dBuV/m)	LIMIT (dBuV/m)	MARGIN (dB)	ANTENNA HEIGHT (m)	TABLE ANGLE (Degree)	RAW VALUE (dBuV)	CORRECTION FACTOR (dB/m)
1	2390.00	62.5 PK	74.0	-11.5	1.00 V	128	31.29	31.21
2	2390.00	43.7 AV	54.0	-10.3	1.00 V	128	12.49	31.21
3	*2402.00	106.0 PK			1.00 V	128	74.75	31.25
4	*2402.00	84.4 AV			1.00 V	128	53.15	31.25
5	4804.00	54.7 PK	74.0	-19.3	1.11 V	67	15.35	39.35
6	4804.00	43.9 AV	54.0	-10.1	1.11 V	67	4.55	39.35

- REMARKS:**
1. Emission level (dBuV/m) = Raw Value (dBuV) + Correction Factor (dB/m).
  2. Correction Factor (dB/m) = Antenna Factor (dB/m) + Cable Factor (dB).
  3. The other emission levels were very low against the limit.
  4. Margin value = Emission level – Limit value.
  5. “ \* “: Fundamental frequency.



A D T

EUT TEST CONDITION		MEASUREMENT DETAIL	
CHANNEL	Channel 39	FREQUENCY RANGE	1 ~ 25GHz
INPUT POWER	DC 3.3V	DETECTOR FUNCTION	Peak (PK) Average (AV)
ENVIRONMENTAL CONDITIONS	26deg. C, 68%RH	TESTED BY	Nelson Teng

ANTENNA POLARITY & TEST DISTANCE: HORIZONTAL AT 3 M								
NO.	FREQ. (MHz)	EMISSION LEVEL (dBuV/m)	LIMIT (dBuV/m)	MARGIN (dB)	ANTENNA HEIGHT (m)	TABLE ANGLE (Degree)	RAW VALUE (dBuV)	CORRECTION FACTOR (dB/m)
1	*2441.00	97.3 PK			1.00 H	241	65.95	31.35
2	*2441.00	89.5 AV			1.00 H	241	58.15	31.35
3	4882.00	52.4 PK	74.0	-21.6	1.23 H	46	12.75	39.65
4	4882.00	41.3 AV	54.0	-12.7	1.23 H	46	1.65	39.65
5	7323.00	53.4 PK	74.0	-20.6	1.00 H	25	9.28	44.12
6	7323.00	40.0 AV	54.0	-14.0	1.00 H	25	-4.12	44.12
ANTENNA POLARITY & TEST DISTANCE: VERTICAL AT 3 M								
NO.	FREQ. (MHz)	EMISSION LEVEL (dBuV/m)	LIMIT (dBuV/m)	MARGIN (dB)	ANTENNA HEIGHT (m)	TABLE ANGLE (Degree)	RAW VALUE (dBuV)	CORRECTION FACTOR (dB/m)
1	*2441.00	105.9 PK			1.02 V	190	74.55	31.35
2	*2441.00	96.5 AV			1.02 V	190	65.15	31.35
3	4882.00	56.2 PK	74.0	-17.8	1.02 V	56	16.55	39.65
4	4882.00	45.2 AV	54.0	-8.8	1.02 V	56	5.55	39.65
5	7323.00	54.1 PK	74.0	-19.9	1.11 V	9	9.98	44.12
6	7323.00	41.4 AV	54.0	-12.6	1.11 V	9	-2.72	44.12

- REMARKS:**
1. Emission level (dBuV/m) = Raw Value (dBuV) + Correction Factor (dB/m).
  2. Correction Factor (dB/m) = Antenna Factor (dB/m) + Cable Factor (dB).
  3. The other emission levels were very low against the limit.
  4. Margin value = Emission level – Limit value.
  5. “ \* “: Fundamental frequency.



A D T

EUT TEST CONDITION		MEASUREMENT DETAIL	
CHANNEL	Channel 78	FREQUENCY RANGE	1 ~ 25GHz
INPUT POWER	DC 3.3V	DETECTOR FUNCTION	Peak (PK) Average (AV)
ENVIRONMENTAL CONDITIONS	26deg. C, 68%RH	TESTED BY	Nelson Teng

**ANTENNA POLARITY & TEST DISTANCE: HORIZONTAL AT 3 M**

NO.	FREQ. (MHz)	EMISSION LEVEL (dBuV/m)	LIMIT (dBuV/m)	MARGIN (dB)	ANTENNA HEIGHT (m)	TABLE ANGLE (Degree)	RAW VALUE (dBuV)	CORRECTION FACTOR (dB/m)
1	*2480.00	95.7 PK			1.05 H	239	64.25	31.45
2	*2480.00	76.9 AV			1.05 H	239	45.45	31.45
3	2483.50	56.1 PK	74.0	-17.9	1.05 H	239	24.64	31.46
4	2483.50	43.1 AV	54.0	-10.9	1.05 H	239	11.64	31.46
5	4960.00	52.6 PK	74.0	-21.4	1.29 H	32	12.63	39.97
6	4960.00	41.4 AV	54.0	-12.6	1.29 H	32	1.43	39.97
7	7440.00	52.7 PK	74.0	-21.3	1.08 H	50	8.46	44.24
8	7440.00	39.5 AV	54.0	-14.5	1.08 H	50	-4.74	44.24

**ANTENNA POLARITY & TEST DISTANCE: VERTICAL AT 3 M**

NO.	FREQ. (MHz)	EMISSION LEVEL (dBuV/m)	LIMIT (dBuV/m)	MARGIN (dB)	ANTENNA HEIGHT (m)	TABLE ANGLE (Degree)	RAW VALUE (dBuV)	CORRECTION FACTOR (dB/m)
1	*2480.00	105.7 PK			1.00 V	194	74.25	31.45
2	*2480.00	86.9 AV			1.00 V	194	55.45	31.45
3	2483.50	57.4 PK	74.0	-16.6	1.00 V	194	25.94	31.46
4	2483.50	43.8 AV	54.0	-10.2	1.00 V	194	12.34	31.46
5	4960.00	56.5 PK	74.0	-17.5	1.13 V	58	16.53	39.97
6	4960.00	45.0 AV	54.0	-9.0	1.13 V	58	5.03	39.97
7	7440.00	56.7 PK	74.0	-17.3	1.05 V	1	12.46	44.24
8	7440.00	44.5 AV	54.0	-9.5	1.05 V	1	0.26	44.24

- REMARKS:**
1. Emission level (dBuV/m) = Raw Value (dBuV) + Correction Factor (dB/m).
  2. Correction Factor (dB/m) = Antenna Factor (dB/m) + Cable Factor (dB).
  3. The other emission levels were very low against the limit.
  4. Margin value = Emission level – Limit value.
  5. “ \* “: Fundamental frequency.



RESTRICTED BANDEDGE (GFSK MODE, CH0, HORIZONTAL )

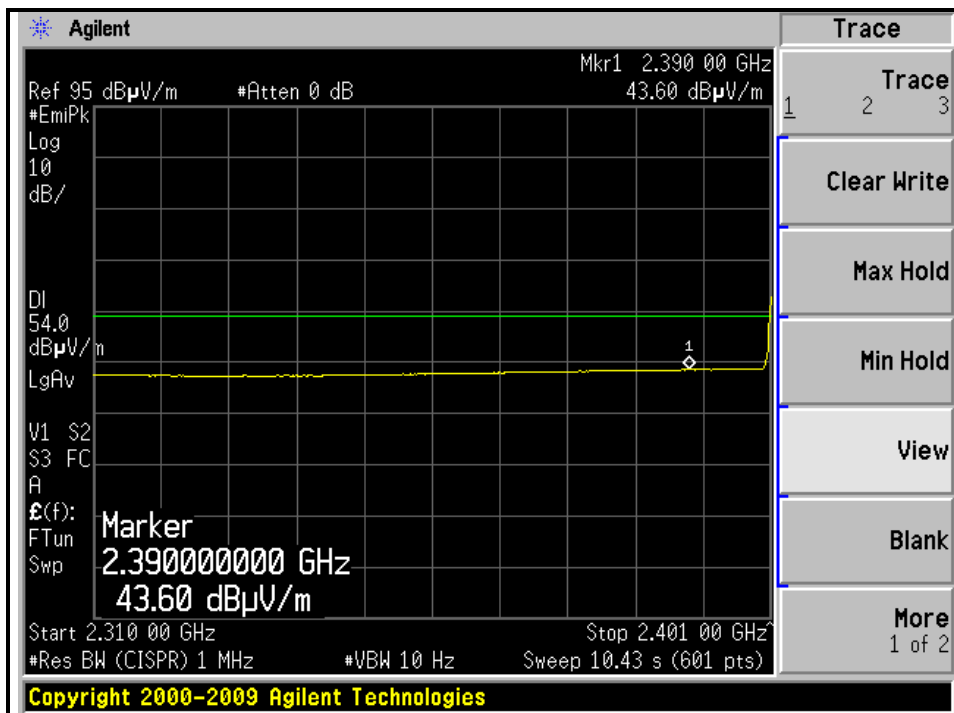
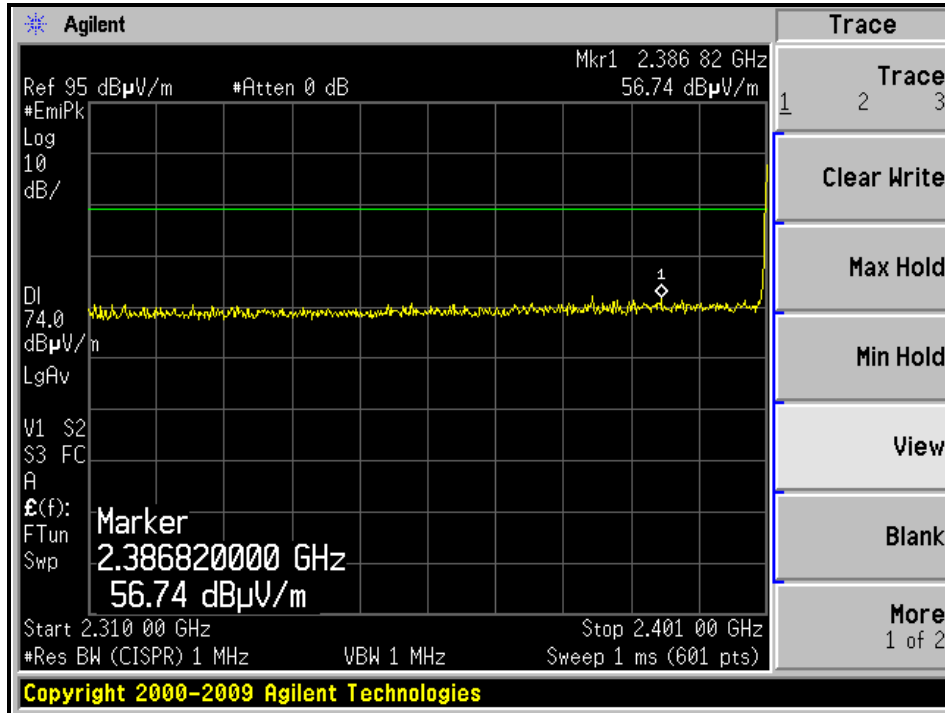



A D T

RESTRICTED BANDEDGE (GFSK MODE, CH0, VERTICAL )

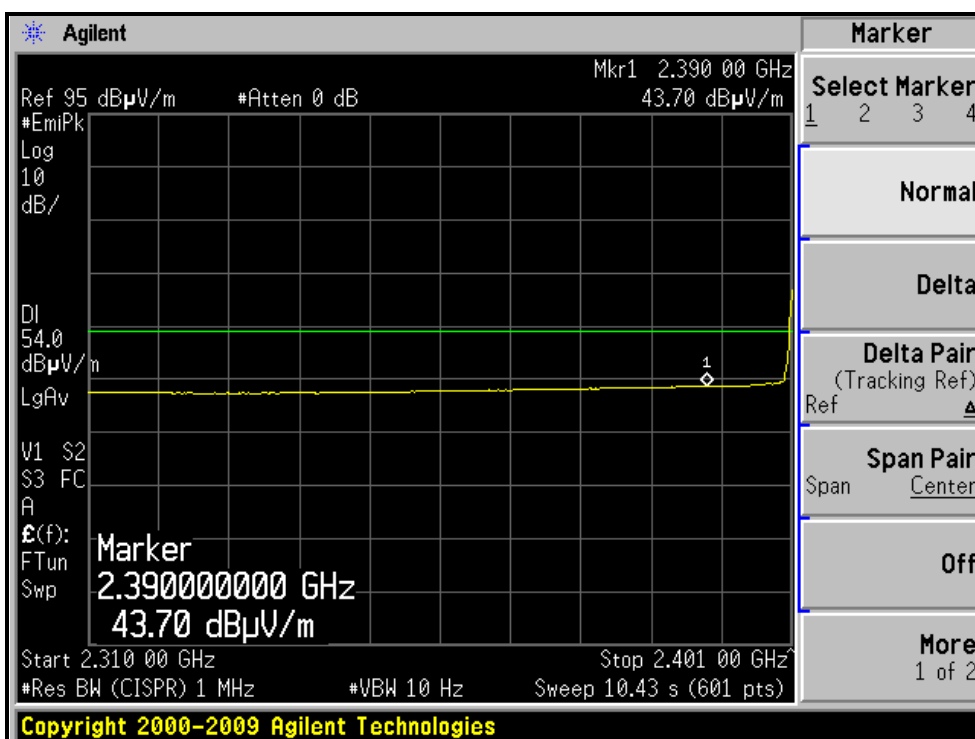
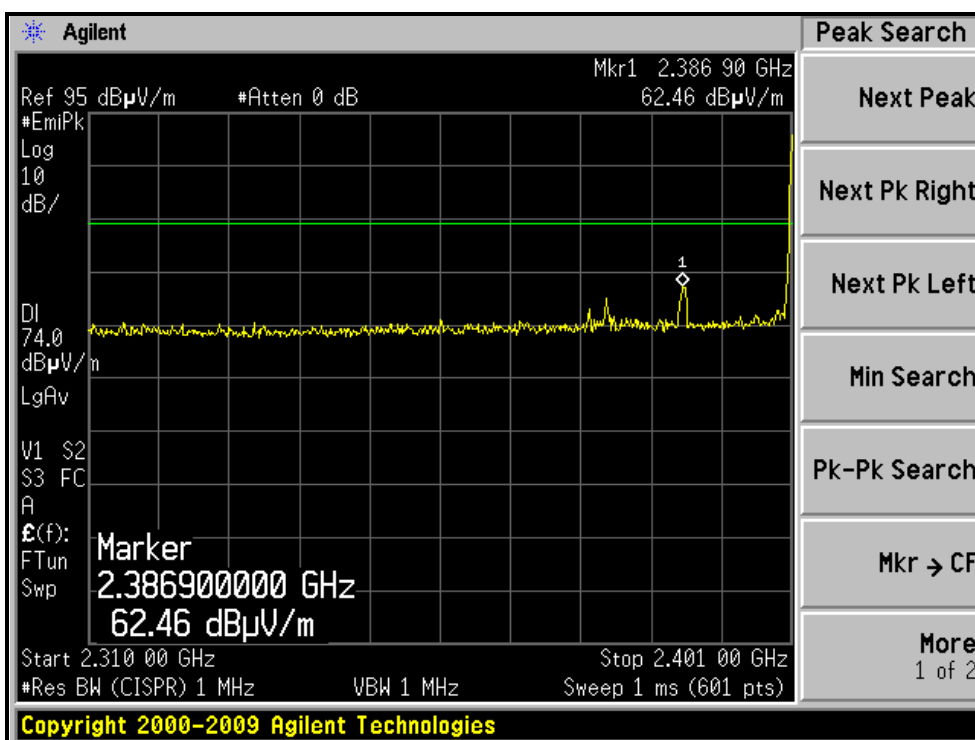



A D T

### RESTRICTED BANDEDGE (GFSK MODE, CH78, HORIZONTAL)

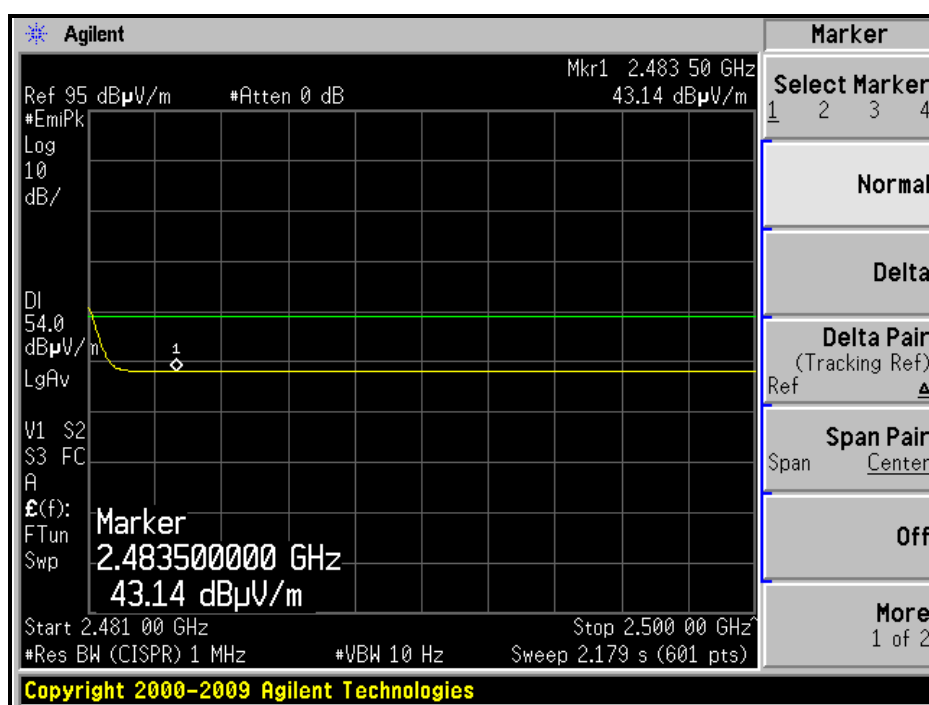
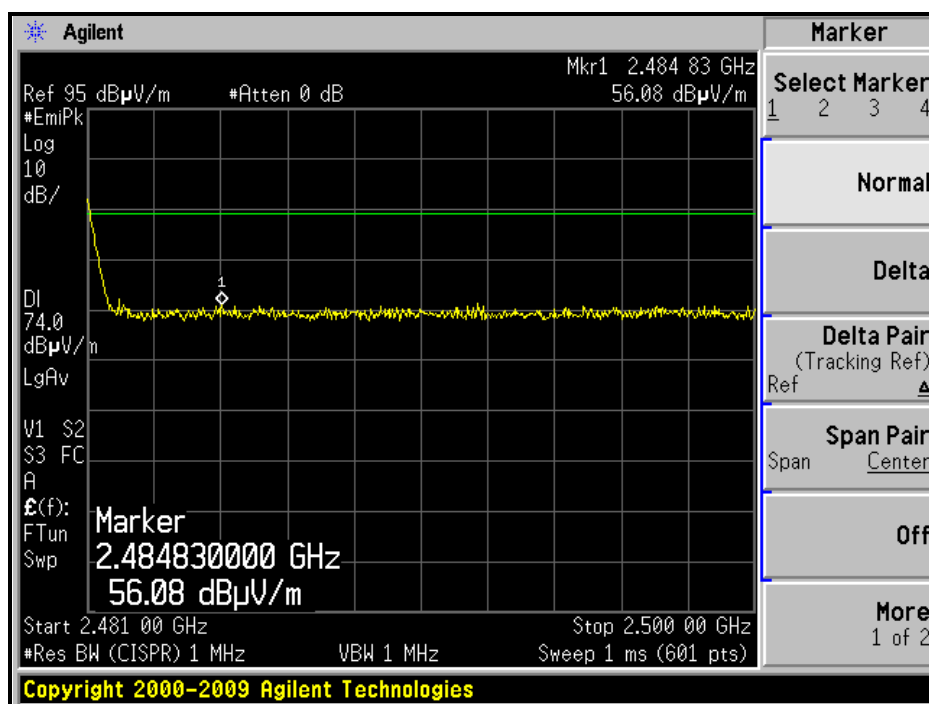



A D T

RESTRICTED BANDEDGE (GFSK MODE, CH78, VERTICAL )

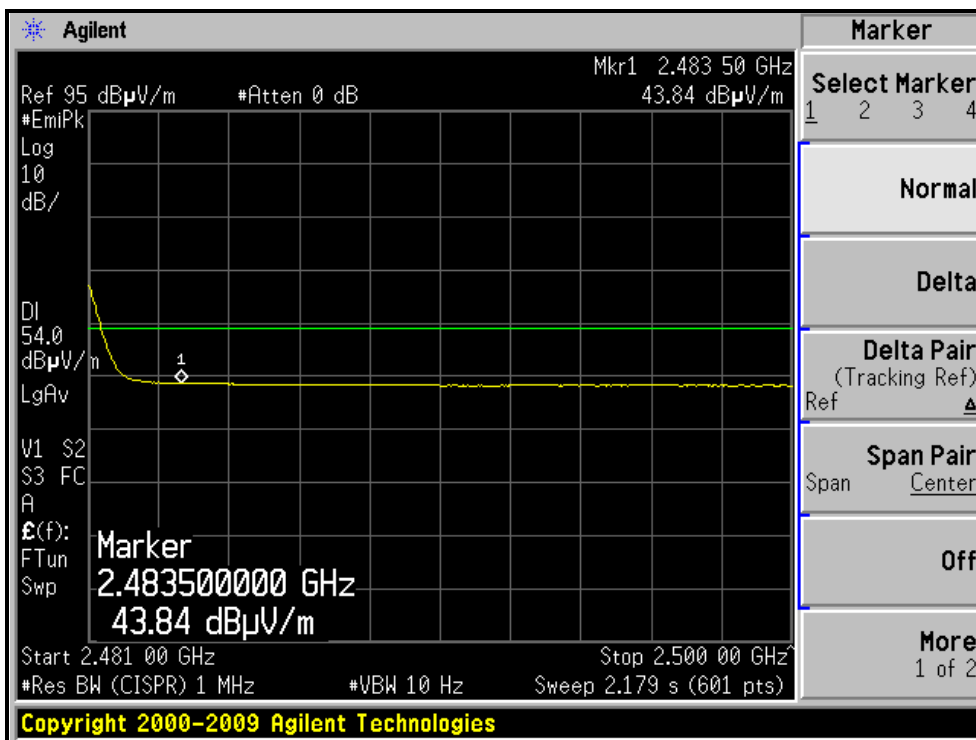
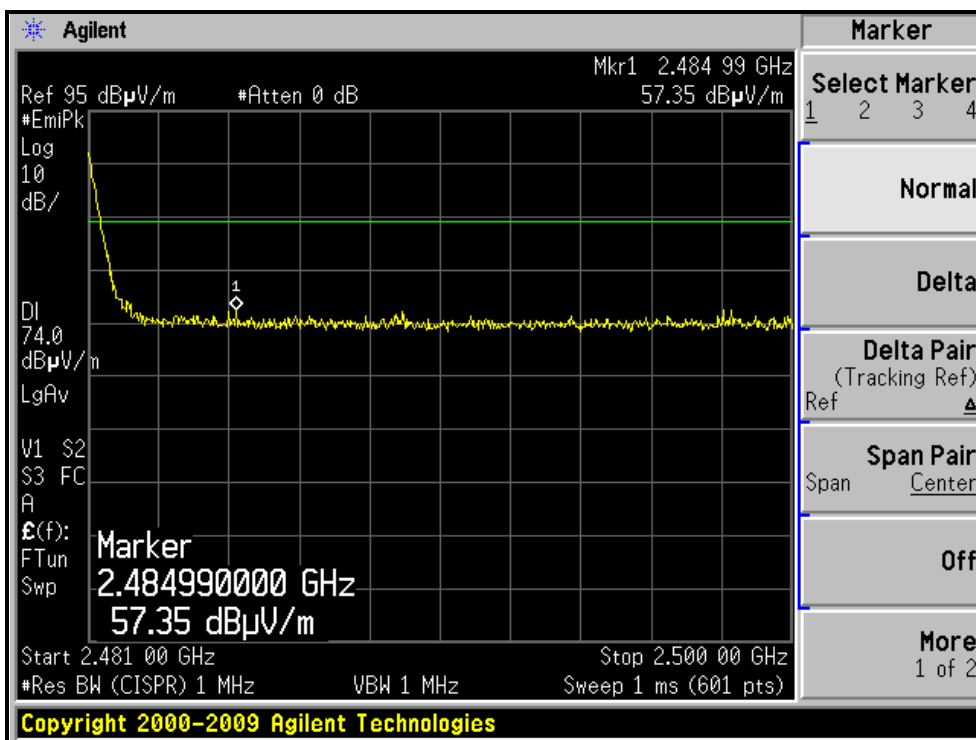





A D T

### 8DPSK MODULATION

EUT TEST CONDITION		MEASUREMENT DETAIL	
CHANNEL	Channel 0	FREQUENCY RANGE	1 ~ 25GHz
INPUT POWER	DC 3.3V	DETECTOR FUNCTION	Peak (PK) Average (AV)
ENVIRONMENTAL CONDITIONS	26deg. C, 68%RH	TESTED BY	Nelson Teng

ANTENNA POLARITY & TEST DISTANCE: HORIZONTAL AT 3 M								
NO.	FREQ. (MHz)	EMISSION LEVEL (dBuV/m)	LIMIT (dBuV/m)	MARGIN (dB)	ANTENNA HEIGHT (m)	TABLE ANGLE (Degree)	RAW VALUE (dBuV)	CORRECTION FACTOR (dB/m)
1	2390.00	56.7 PK	74.0	-17.3	1.03 H	242	25.49	31.21
2	2390.00	43.6 AV	54.0	-10.4	1.03 H	242	12.39	31.21
3	*2402.00	97.3 PK			1.03 H	242	66.05	31.25
4	*2402.00	87.3 AV			1.03 H	242	56.05	31.25
5	4804.00	53.1 PK	74.0	-20.9	1.26 H	36	13.75	39.35
6	4804.00	42.1 AV	54.0	-11.9	1.26 H	36	2.75	39.35
ANTENNA POLARITY & TEST DISTANCE: VERTICAL AT 3 M								
NO.	FREQ. (MHz)	EMISSION LEVEL (dBuV/m)	LIMIT (dBuV/m)	MARGIN (dB)	ANTENNA HEIGHT (m)	TABLE ANGLE (Degree)	RAW VALUE (dBuV)	CORRECTION FACTOR (dB/m)
1	2390.00	58.8 PK	74.0	-15.2	1.00 V	126	27.59	31.21
2	2390.00	43.9 AV	54.0	-10.1	1.00 V	126	12.69	31.21
3	*2402.00	104.8 PK			1.00 V	126	73.55	31.25
4	*2402.00	93.4 AV			1.00 V	126	62.15	31.25
5	4804.00	54.2 PK	74.0	-19.8	1.10 V	55	14.85	39.35
6	4804.00	43.7 AV	54.0	-10.3	1.10 V	55	4.35	39.35

- REMARKS:**
1. Emission level (dBuV/m) = Raw Value (dBuV) + Correction Factor (dB/m).
  2. Correction Factor (dB/m) = Antenna Factor (dB/m) + Cable Factor (dB).
  3. The other emission levels were very low against the limit.
  4. Margin value = Emission level – Limit value.
  5. “ \* “: Fundamental frequency.



A D T

EUT TEST CONDITION		MEASUREMENT DETAIL	
CHANNEL	Channel 39	FREQUENCY RANGE	1 ~ 25GHz
INPUT POWER	DC 3.3V	DETECTOR FUNCTION	Peak (PK) Average (AV)
ENVIRONMENTAL CONDITIONS	26deg. C, 68%RH	TESTED BY	Nelson Teng

**ANTENNA POLARITY & TEST DISTANCE: HORIZONTAL AT 3 M**

NO.	FREQ. (MHz)	EMISSION LEVEL (dBuV/m)	LIMIT (dBuV/m)	MARGIN (dB)	ANTENNA HEIGHT (m)	TABLE ANGLE (Degree)	RAW VALUE (dBuV)	CORRECTION FACTOR (dB/m)
1	*2441.00	96.2 PK			1.04 H	247	64.85	31.35
2	*2441.00	86.6 AV			1.04 H	247	55.25	31.35
3	4882.00	52.8 PK	74.0	-21.2	1.19 H	34	13.15	39.65
4	4882.00	41.7 AV	54.0	-12.3	1.19 H	34	2.05	39.65
5	7323.00	53.3 PK	74.0	-20.7	1.00 H	33	9.18	44.12
6	7323.00	39.8 AV	54.0	-14.2	1.00 H	33	-4.32	44.12

**ANTENNA POLARITY & TEST DISTANCE: VERTICAL AT 3 M**

NO.	FREQ. (MHz)	EMISSION LEVEL (dBuV/m)	LIMIT (dBuV/m)	MARGIN (dB)	ANTENNA HEIGHT (m)	TABLE ANGLE (Degree)	RAW VALUE (dBuV)	CORRECTION FACTOR (dB/m)
1	*2441.00	105.1 PK			1.02 V	189	73.75	31.35
2	*2441.00	93.8 AV			1.02 V	189	62.45	31.35
3	4882.00	56.5 PK	74.0	-17.5	1.08 V	52	16.85	39.65
4	4882.00	45.4 AV	54.0	-8.6	1.08 V	52	5.75	39.65
5	7323.00	54.8 PK	74.0	-19.2	1.05 V	14	10.68	44.12
6	7323.00	41.9 AV	54.0	-12.1	1.05 V	14	-2.22	44.12

- REMARKS:**
1. Emission level (dBuV/m) = Raw Value (dBuV) + Correction Factor (dB/m).
  2. Correction Factor (dB/m) = Antenna Factor (dB/m) + Cable Factor (dB).
  3. The other emission levels were very low against the limit.
  4. Margin value = Emission level – Limit value.
  5. “ \* “: Fundamental frequency.



A D T

EUT TEST CONDITION		MEASUREMENT DETAIL	
CHANNEL	Channel 78	FREQUENCY RANGE	1 ~ 25GHz
INPUT POWER	DC 3.3V	DETECTOR FUNCTION	Peak (PK) Average (AV)
ENVIRONMENTAL CONDITIONS	26deg. C, 68%RH	TESTED BY	Nelson Teng

ANTENNA POLARITY & TEST DISTANCE: HORIZONTAL AT 3 M								
NO.	FREQ. (MHz)	EMISSION LEVEL (dBuV/m)	LIMIT (dBuV/m)	MARGIN (dB)	ANTENNA HEIGHT (m)	TABLE ANGLE (Degree)	RAW VALUE (dBuV)	CORRECTION FACTOR (dB/m)
1	*2480.00	95.4 PK			1.08 H	240	63.95	31.45
2	*2480.00	84.9 AV			1.08 H	240	53.45	31.45
3	2483.50	57.3 PK	74.0	-16.7	1.08 H	240	25.84	31.46
4	2483.50	44.2 AV	54.0	-9.8	1.08 H	240	12.74	31.46
5	4960.00	52.9 PK	74.0	-21.1	1.24 H	34	12.93	39.97
6	4960.00	41.6 AV	54.0	-12.4	1.24 H	34	1.63	39.97
7	7440.00	53.2 PK	74.0	-20.8	1.08 H	48	8.96	44.24
8	7440.00	39.9 AV	54.0	-14.1	1.08 H	48	-4.34	44.24
ANTENNA POLARITY & TEST DISTANCE: VERTICAL AT 3 M								
NO.	FREQ. (MHz)	EMISSION LEVEL (dBuV/m)	LIMIT (dBuV/m)	MARGIN (dB)	ANTENNA HEIGHT (m)	TABLE ANGLE (Degree)	RAW VALUE (dBuV)	CORRECTION FACTOR (dB/m)
1	*2480.00	105.2 PK			1.03 V	197	73.75	31.45
2	*2480.00	92.9 AV			1.03 V	197	61.45	31.45
3	2483.50	66.0 PK	74.0	-8.0	1.03 V	197	34.54	31.46
4	<b>2483.50</b>	<b>47.5 AV</b>	<b>54.0</b>	<b>-6.5</b>	<b>1.03 V</b>	<b>197</b>	<b>16.04</b>	<b>31.46</b>
5	4960.00	55.9 PK	74.0	-18.1	1.19 V	53	15.93	39.97
6	4960.00	44.5 AV	54.0	-9.5	1.19 V	53	4.53	39.97
7	7440.00	56.5 PK	74.0	-17.5	1.02 V	13	12.26	44.24
8	7440.00	44.4 AV	54.0	-9.6	1.02 V	13	0.16	44.24

- REMARKS:**
1. Emission level (dBuV/m) = Raw Value (dBuV) + Correction Factor (dB/m).
  2. Correction Factor (dB/m) = Antenna Factor (dB/m) + Cable Factor (dB).
  3. The other emission levels were very low against the limit.
  4. Margin value = Emission level – Limit value.
  5. “ \* “: Fundamental frequency.



A D T

RESTRICTED BANDEDGE (GFSK MODE, CH0, HORIZONTAL )

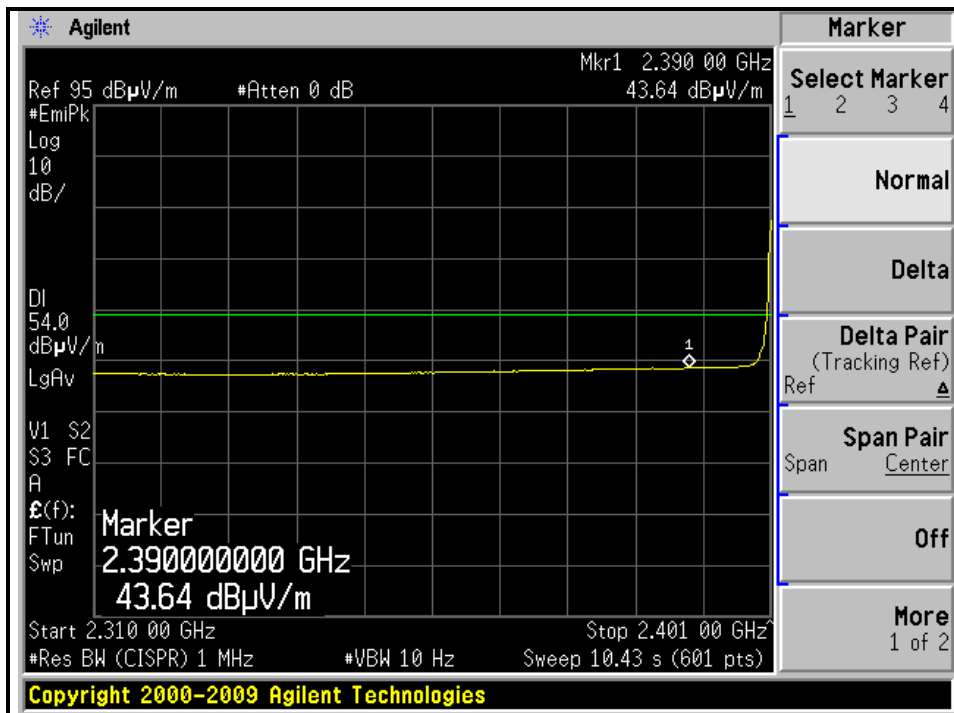
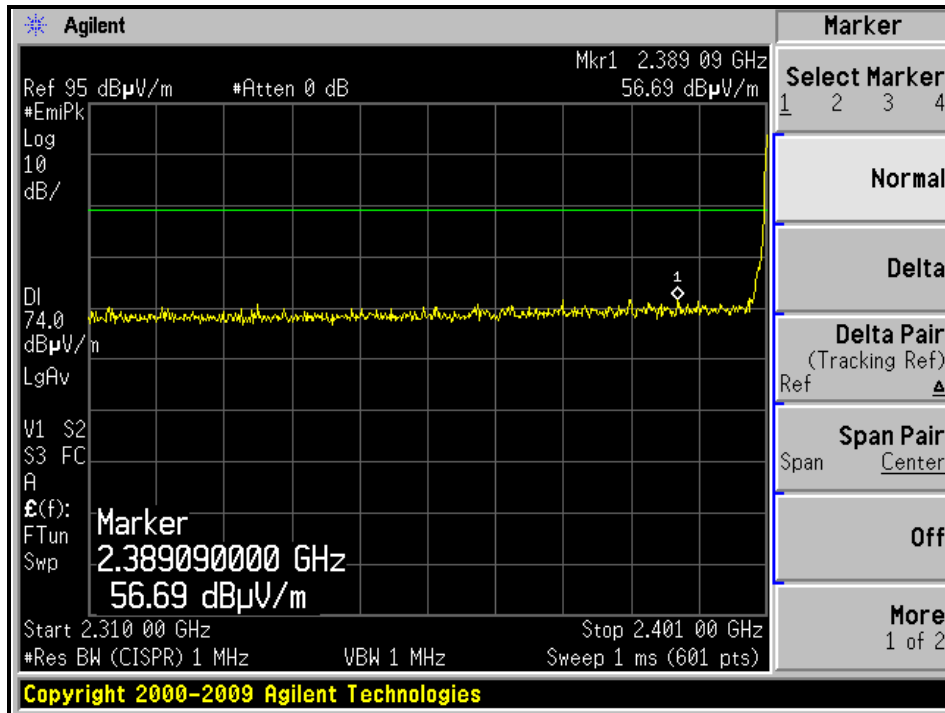



A D T

RESTRICTED BANDEDGE (GFSK MODE, CH0, VERTICAL)

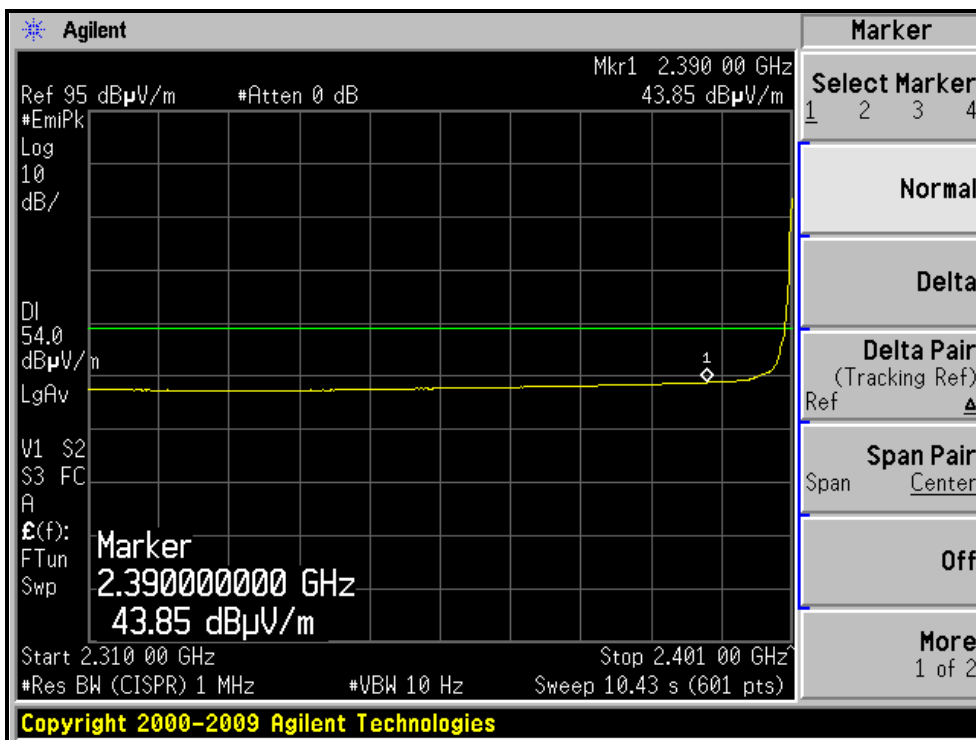
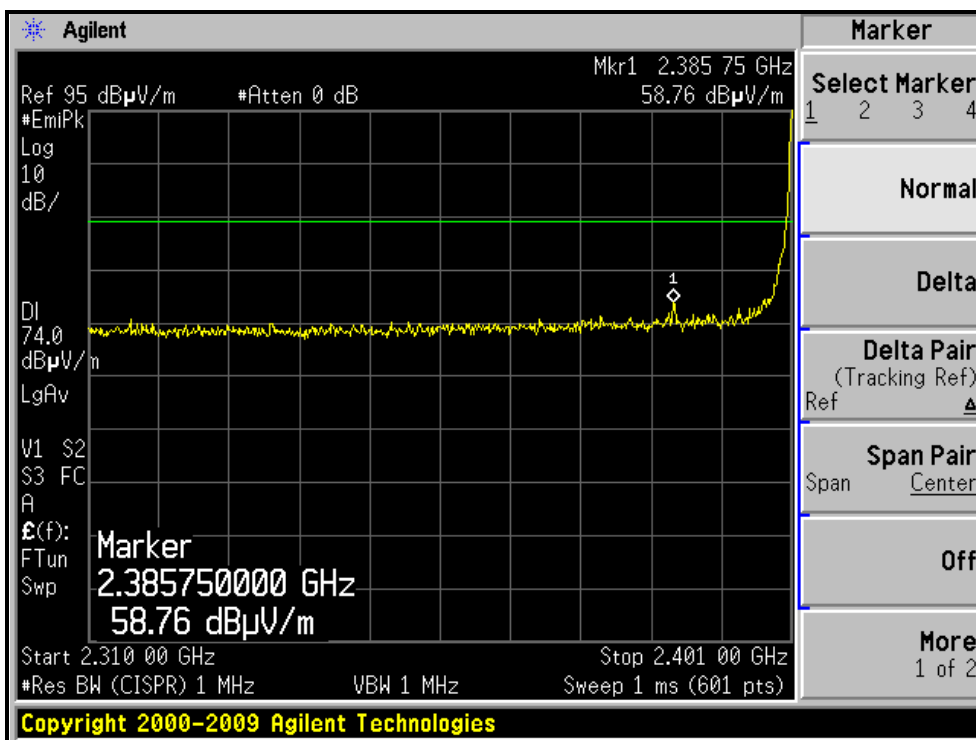

RESTRICTED BANDEDGE (GFSK MODE, CH78, HORIZONTAL )

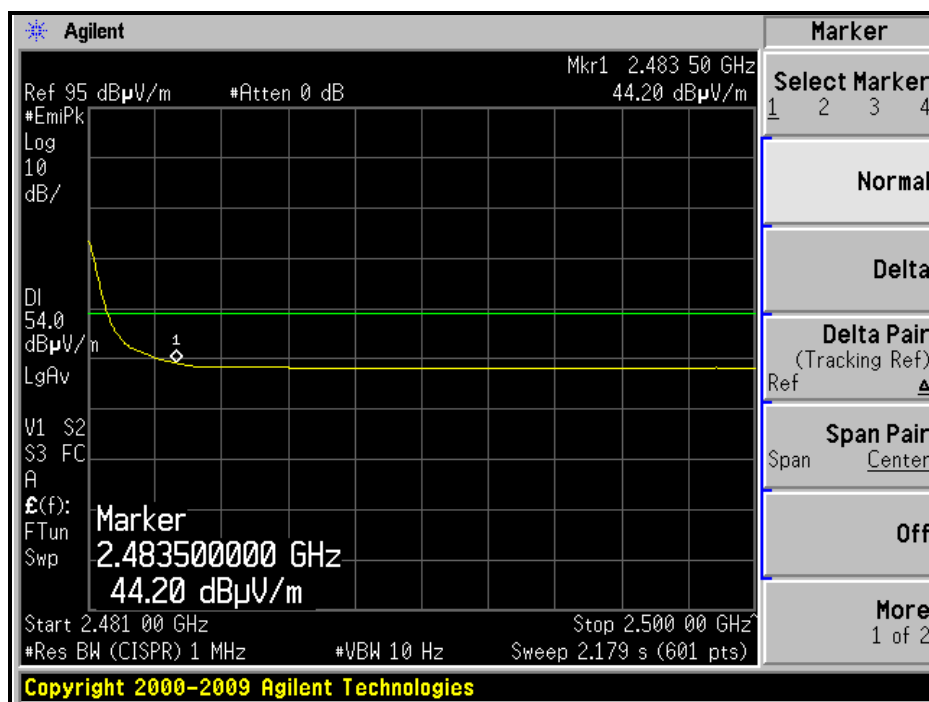
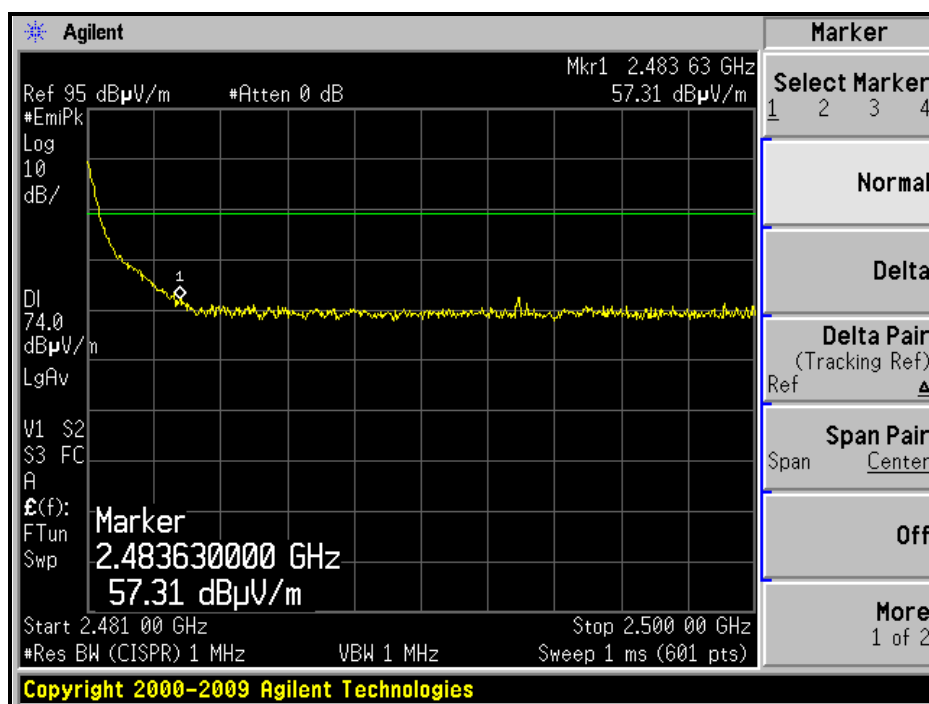



A D T

RESTRICTED BANDEDGE (GFSK MODE, CH78, VERTICAL)

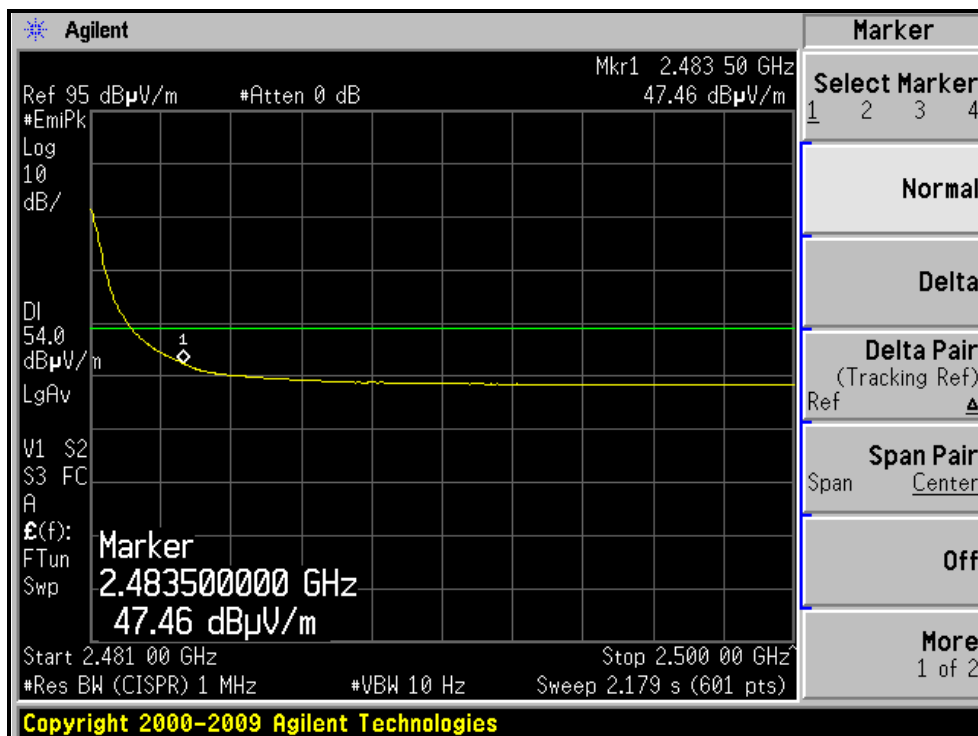
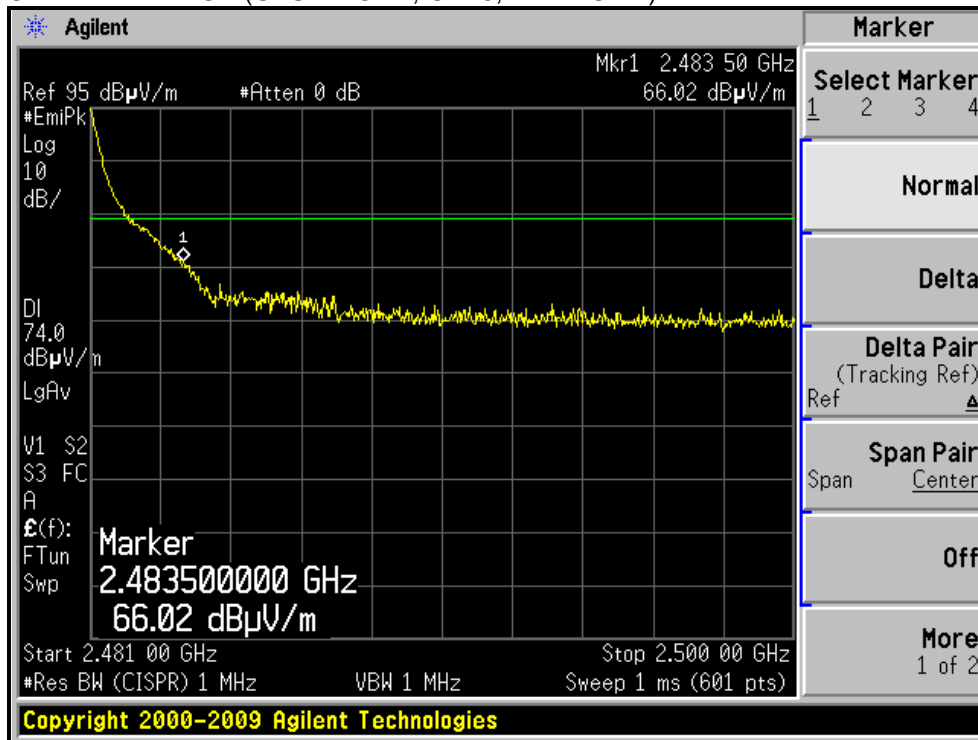

### 4.3 NUMBER OF HOPPING FREQUENCY USED

#### 4.3.1 LIMIT OF HOPPING FREQUENCY USED

At least 15 hopping frequencies, and should be equally spaced.

#### 4.3.2 TEST INSTRUMENTS

Test date: Dec. 03, 2011

DESCRIPTION & MANUFACTURER	MODEL NO.	SERIAL NO.	CALIBRATED DATE	CALIBRATED UNTIL
R&S Spectrum Analyzer	FSP40	100036	Dec. 08, 2010	Dec. 07, 2011

**NOTE:** The calibration interval of the above test instruments is 12 months and the calibrations are traceable to NML/ROC and NIST/USA.

#### 4.3.3 TEST PROCEDURES

1. Check the calibration of the measuring instrument (SA) using either an internal calibrator or a known signal from an external generator.
2. Turn on the EUT and connect its antenna terminal to measurement via a low loss cable. Then set it to any one measured frequency within its operating range and make sure the instrument is operated in its linear range.
3. Set the SA on MaxHold Mode, and then keep the EUT in hopping mode. Record all the signals from each channel until each one has been recorded.
4. Set the SA on View mode and then plot the result on SA screen.
5. Repeat above procedures until all frequencies measured were complete.

#### 4.3.4 DEVIATION FROM TEST STANDARD

No deviation



#### 4.3.5 TEST SETUP

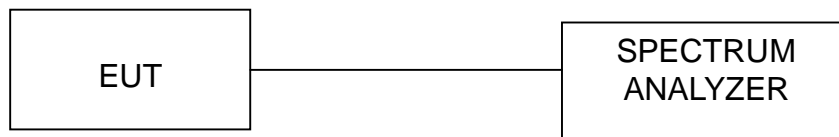

#### 4.3.6 TEST RESULTS

There are 79 hopping frequencies in the hopping mode. Please refer to next pages for the test result. On the plots, it shows that the hopping frequencies are equally spaced.



A D T

### For GFSK

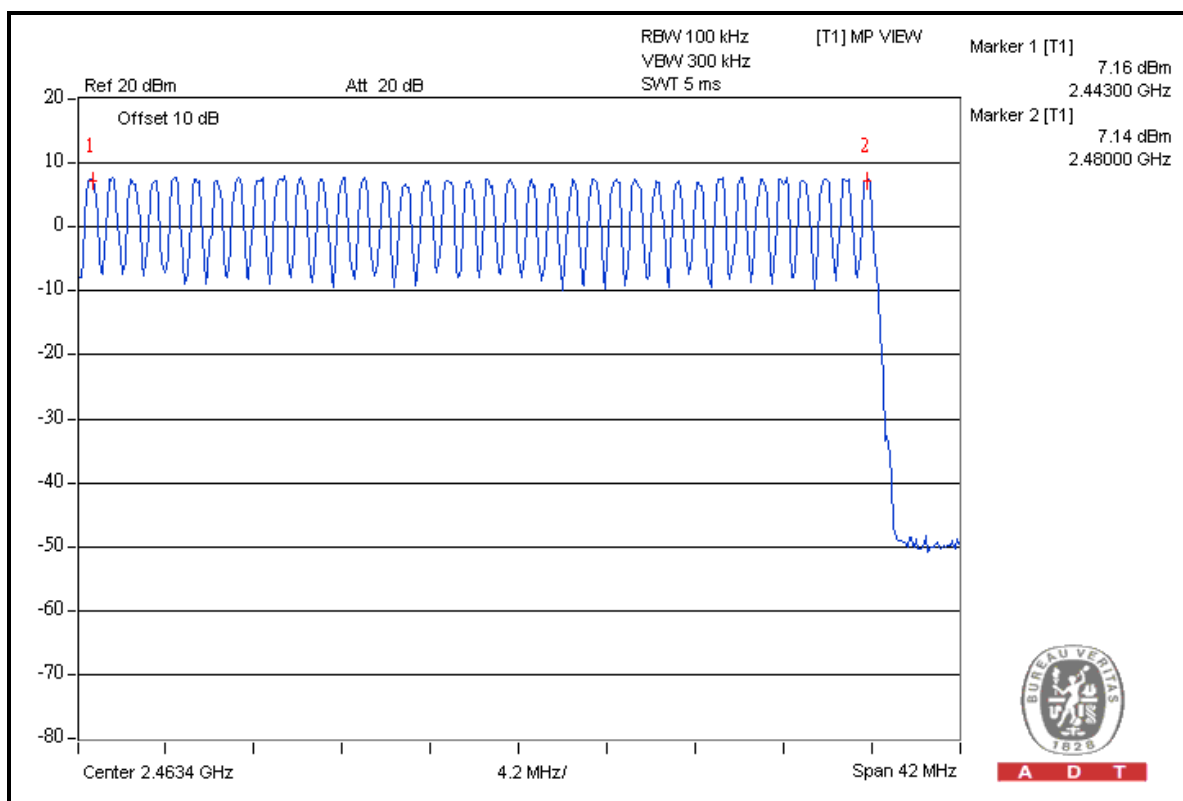
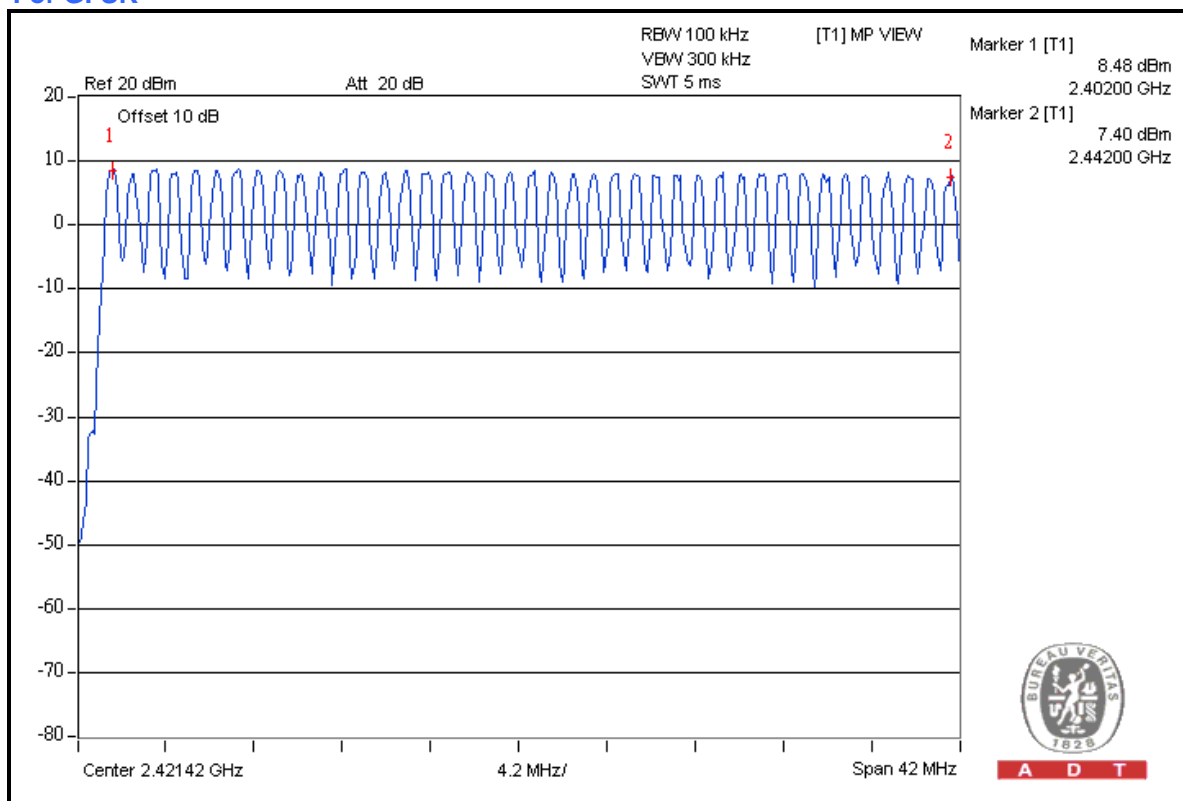



A D T

### For 8DPSK

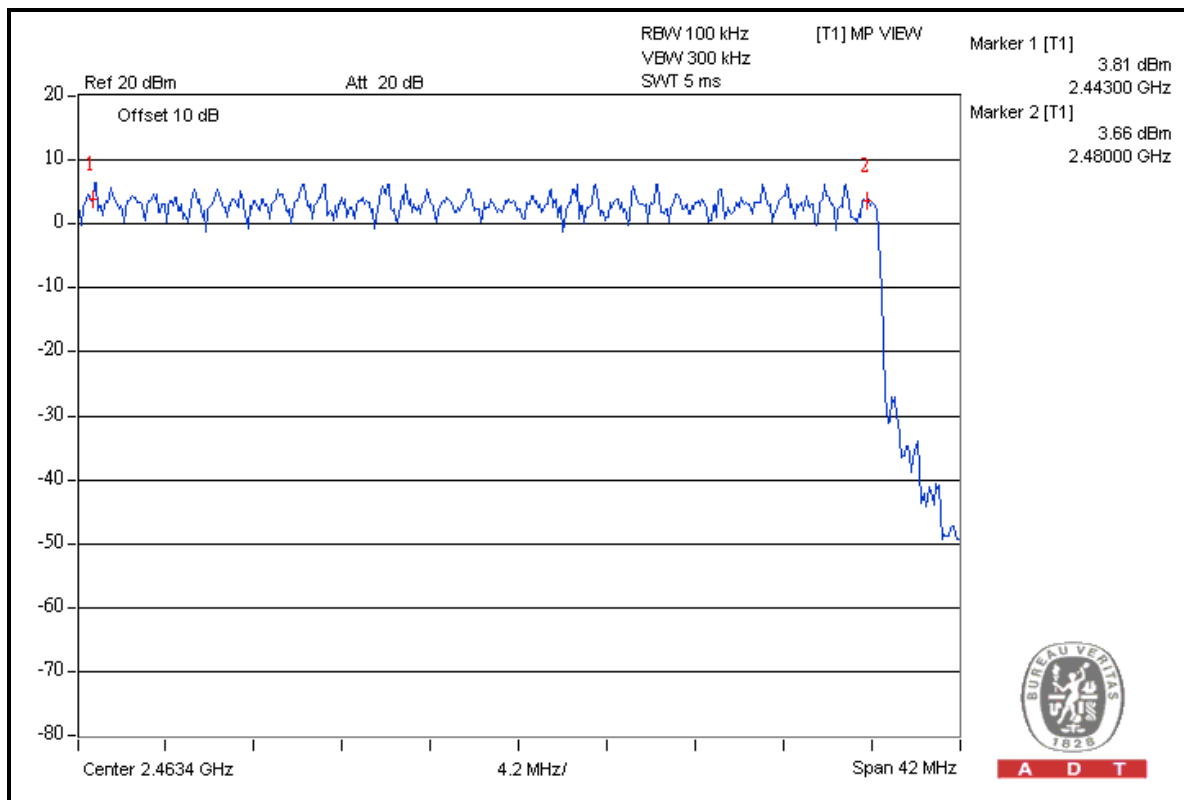
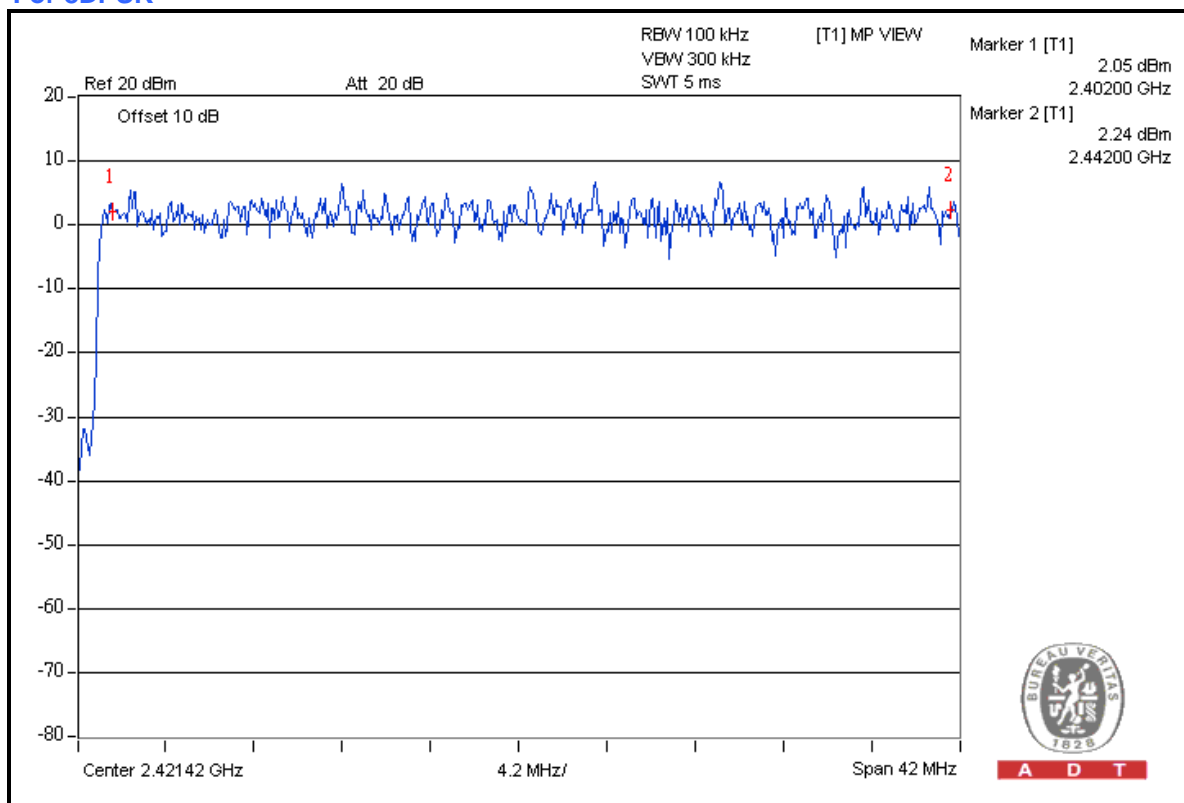

#### 4.4 DWELL TIME ON EACH CHANNEL

##### 4.4.1 LIMIT OF DWELL TIME USED

For FHSS, the average time of occupancy on any frequency shall not be greater than 0.4 seconds within a 31.6 second period. For hybrid systems, the average time of occupancy on any frequency should not exceed 0.4 seconds within a time period in seconds equal to the number of hopping frequencies employed multiplied by 0.4.

##### 4.4.2 TEST INSTRUMENTS

**Test date: Dec. 03, 2011**

DESCRIPTION & MANUFACTURER	MODEL NO.	SERIAL NO.	CALIBRATED DATE	CALIBRATED UNTIL
R&S Spectrum Analyzer	FSP40	100036	Dec. 08, 2010	Dec. 07, 2011

**NOTE:** The calibration interval of the above test instruments is 12 months and the calibrations are traceable to NML/ROC and NIST/USA.

##### 4.4.3 TEST PROCEDURES

1. Check the calibration of the measuring instrument (SA) using either an internal calibrator or a known signal from an external generator.
2. Turn on the EUT and connect its antenna terminal to measurement via a low loss cable. Then set it to any one measured frequency within its operating range and make sure the instrument is operated in its linear range.
3. Adjust the center frequency of SA on any frequency be measured and set SA to zero span mode. And then, set RBW and VBW of spectrum analyzer to proper value.
4. Measure the time duration of one transmission on the measured frequency. And then plot the result with time difference of this time duration.
5. Repeat above procedures until all frequencies measured were complete.

#### 4.4.4 DEVIATION FROM TEST STANDARD

No deviation

#### 4.4.5 TEST SETUP

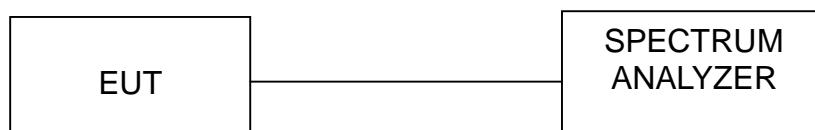

#### 4.4.6 TEST RESULTS

For GFSK:

Mode	Number of transmission in a 31.6 (79Hopping*0.4)	Length of transmission time (msec)	Result (msec)	Limit (msec)
DH1	50 (times / 5 sec) *6.32=316 times	0.486	153.58	400
DH3	25 (times / 5 sec) *6.32=158 times	1.698	268.28	400
DH5	16 (times / 5 sec) *6.32=101.12 times	3	303.36	400

**NOTE:** Test plots of the transmitting time slot are shown on next 3 pages.



A D T

### DH1

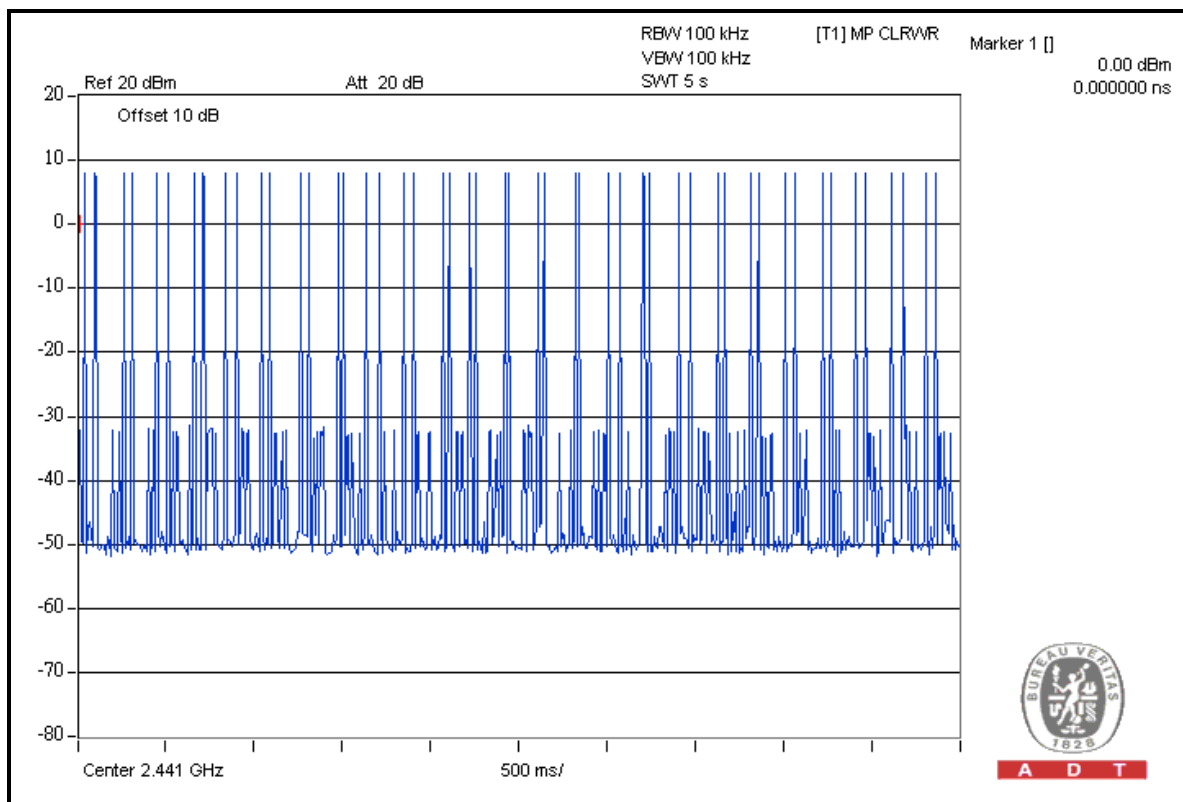

A D T

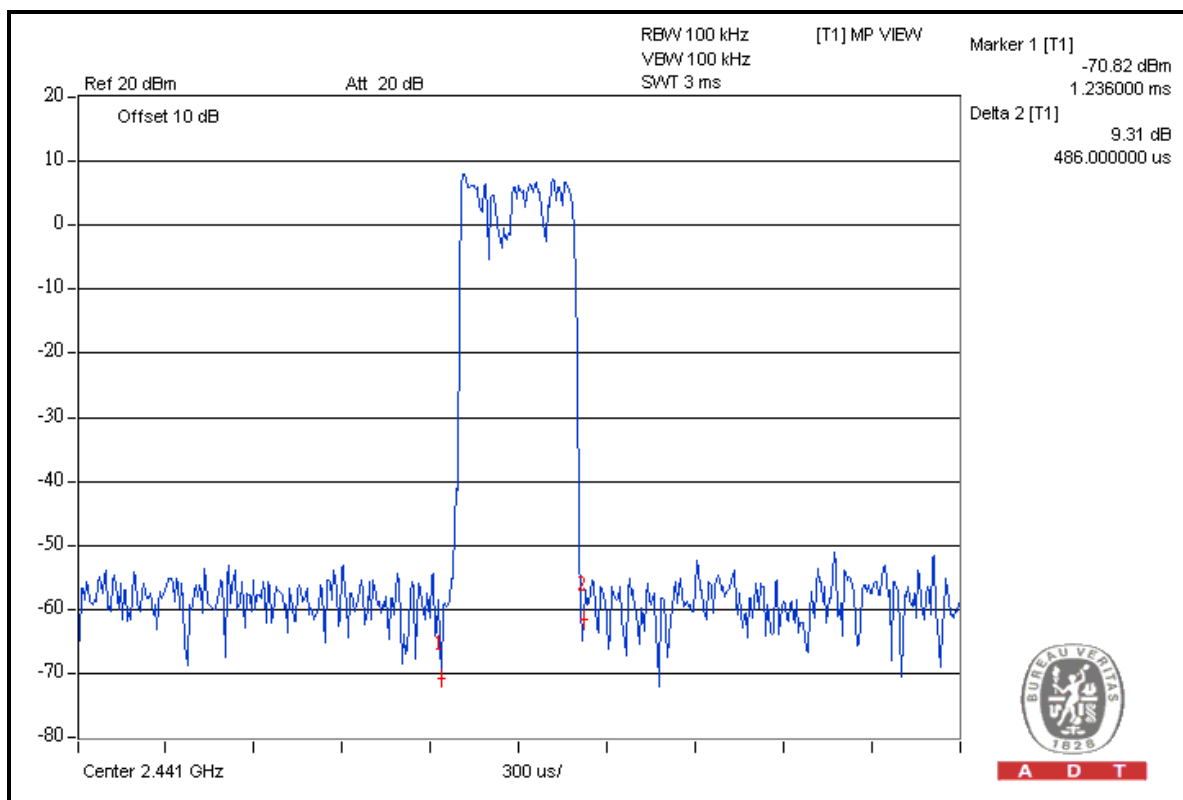

A D T



A D T

### DH3

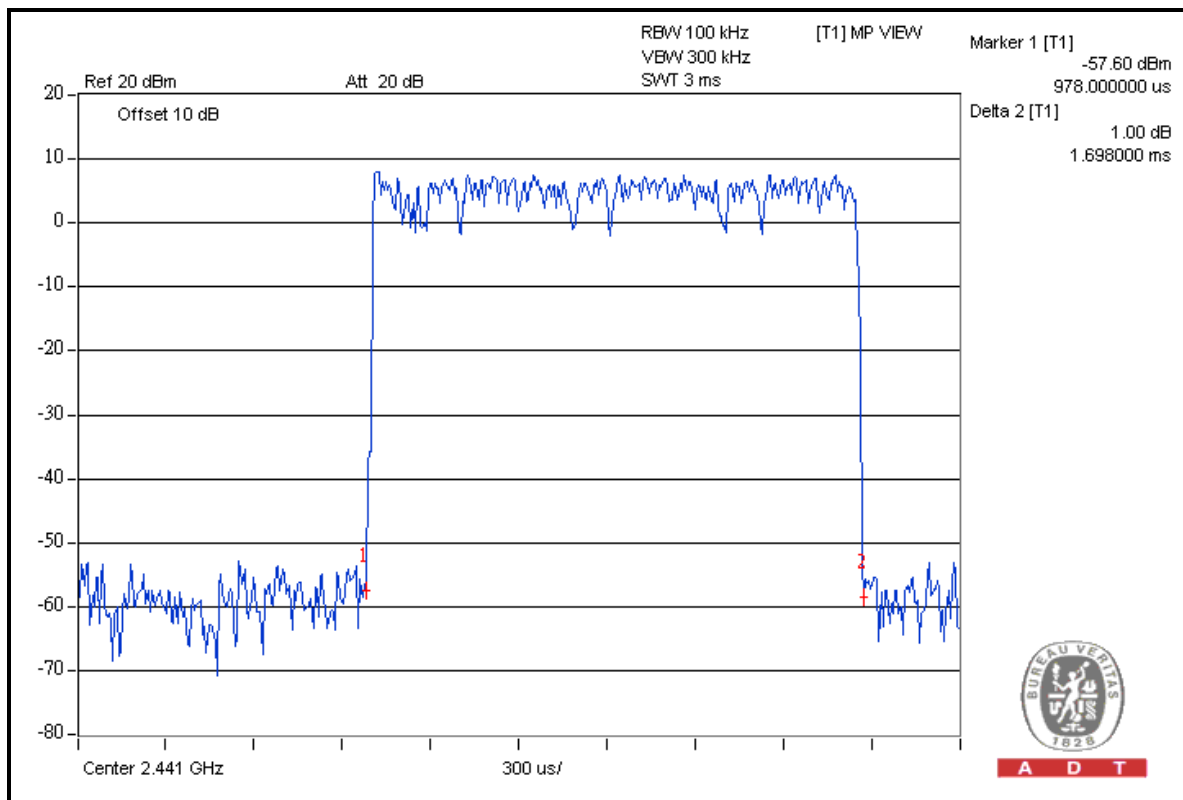
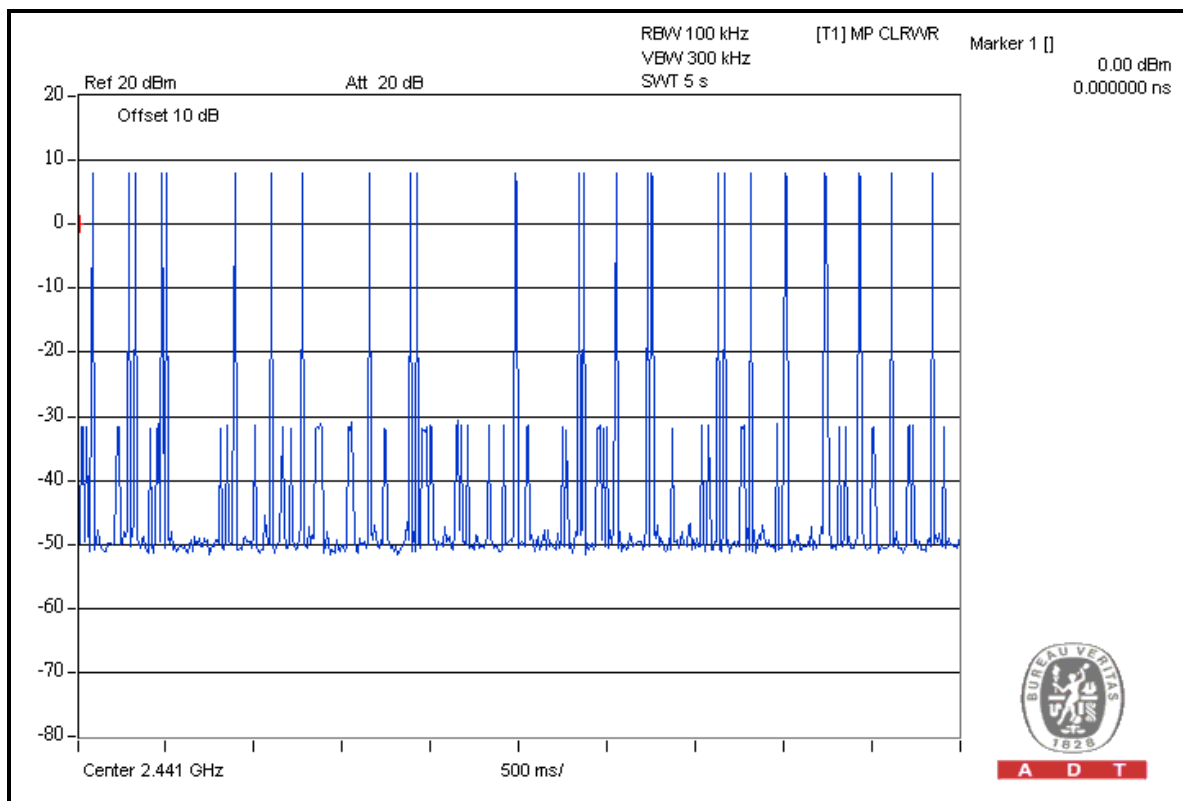





A D T

### DH5

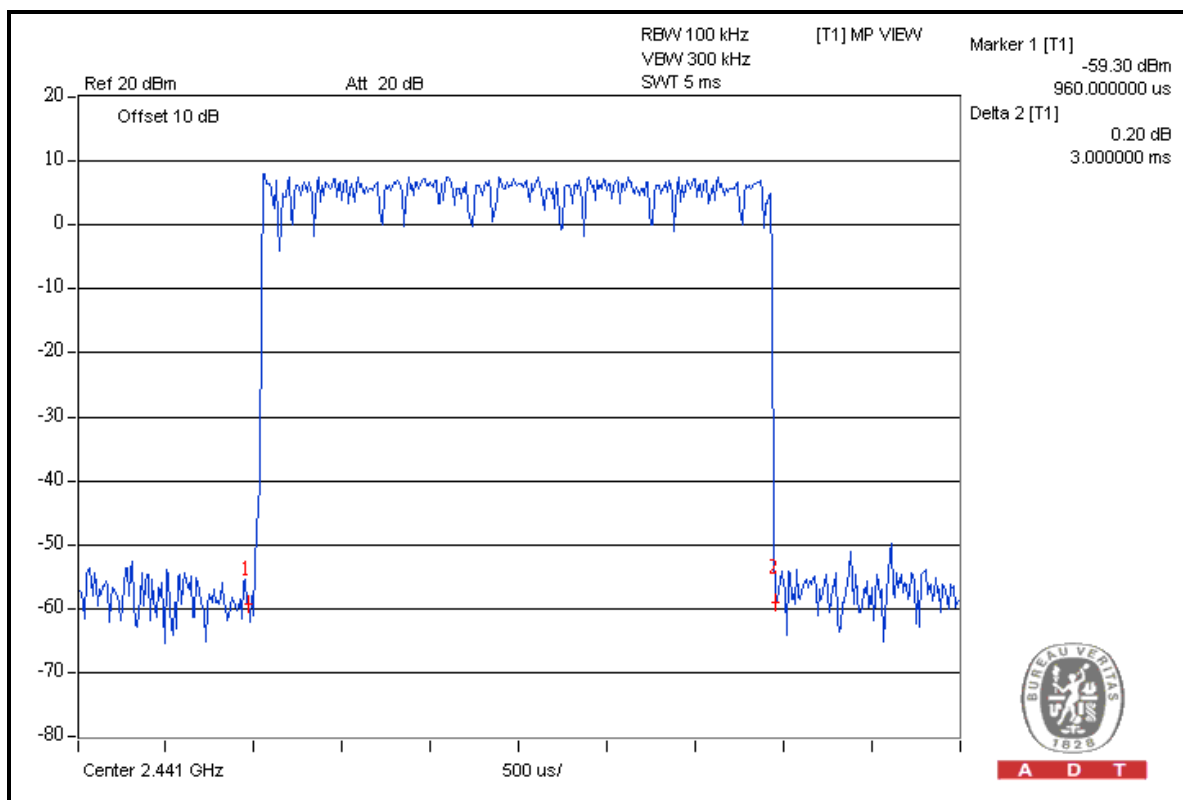
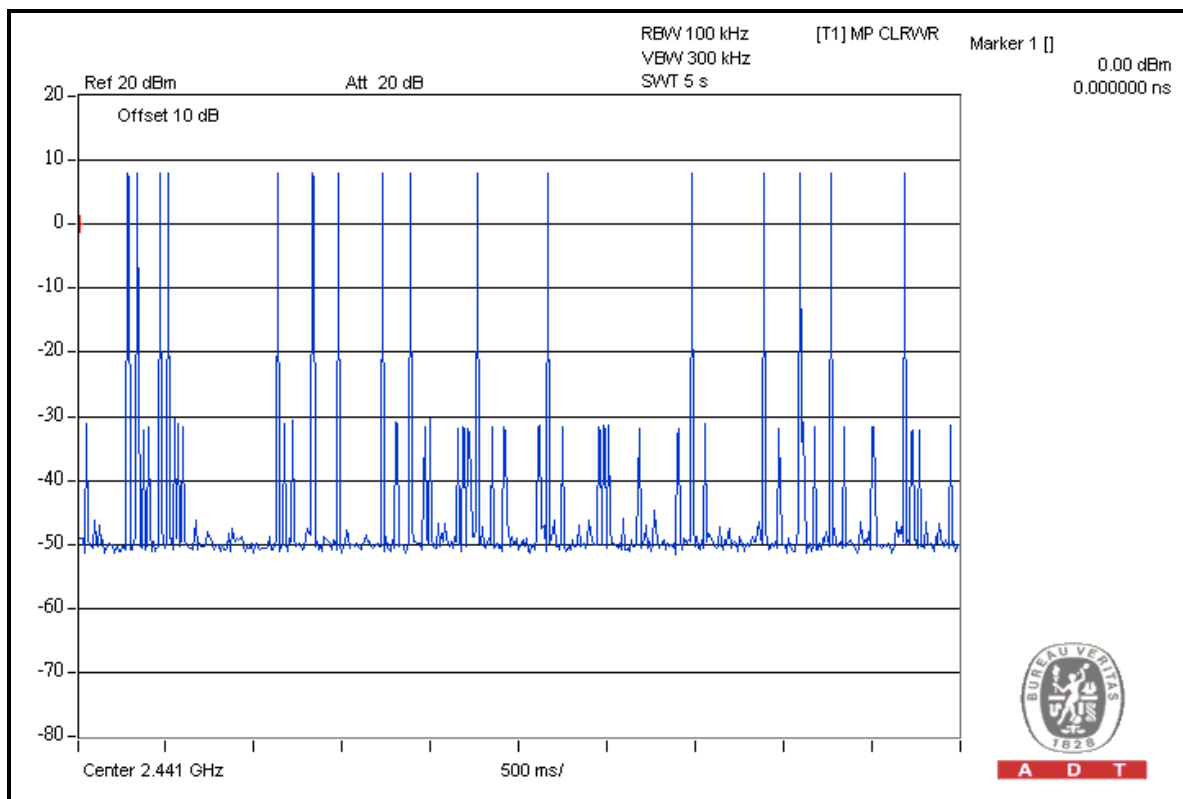



A D T

**For 8DPSK :**

Mode	Number of transmission in a 31.6 (79Hopping*0.4)	Length of transmission time (msec)	Result (msec)	Limit (msec)
DH1	50 (times / 5 sec) *6.32=316 times	0.27	85.32	400
DH3	27 (times / 5 sec) *6.32=170.64 times	1.674	285.65	400
DH5	16 (times / 5 sec) *6.32=101.12 times	2.88	291.23	400

**NOTE:** Test plots of the transmitting time slot are shown on next 3 pages.



A D T

### DH1

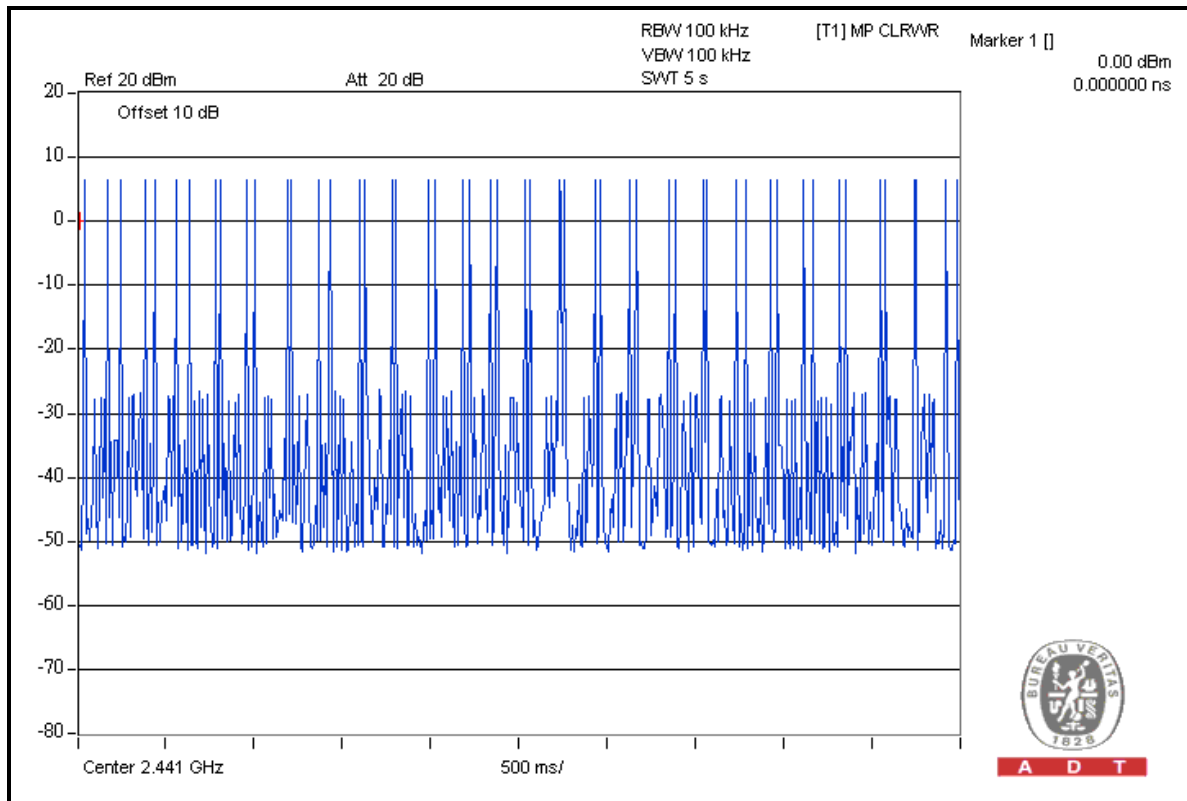

A D T

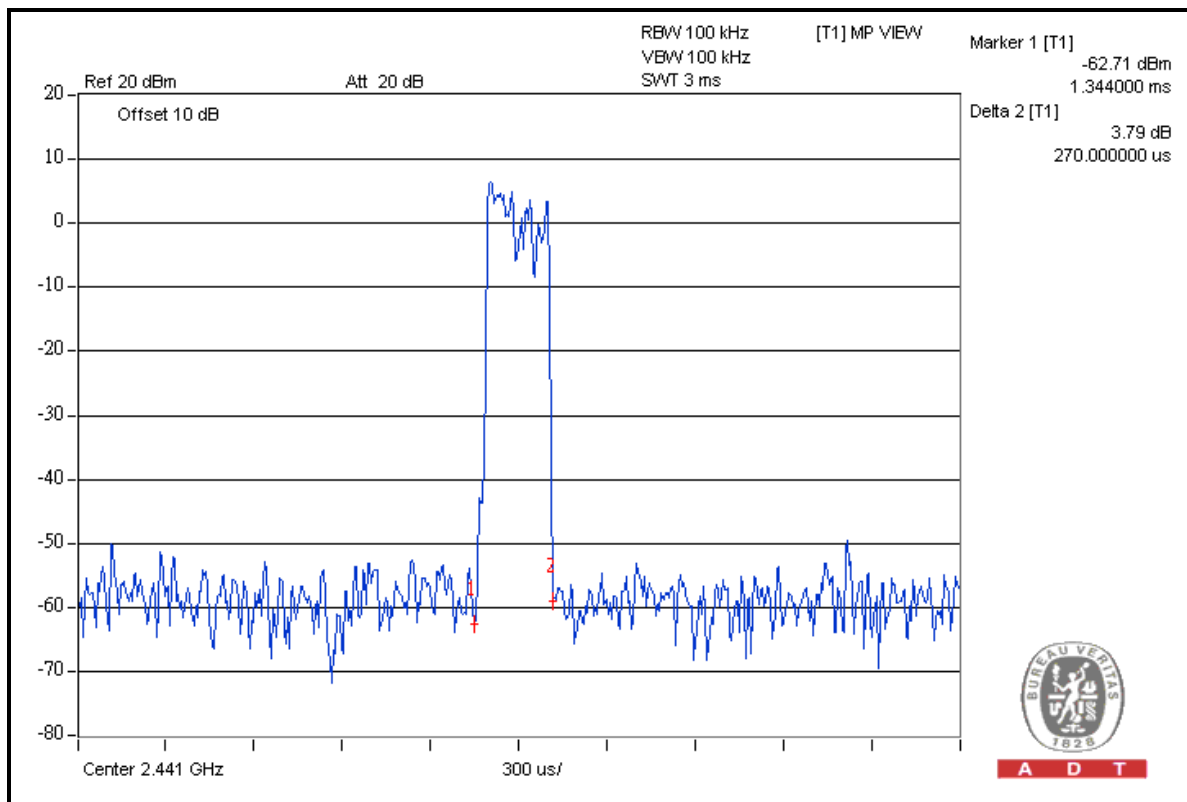

A D T



A D T

### DH3

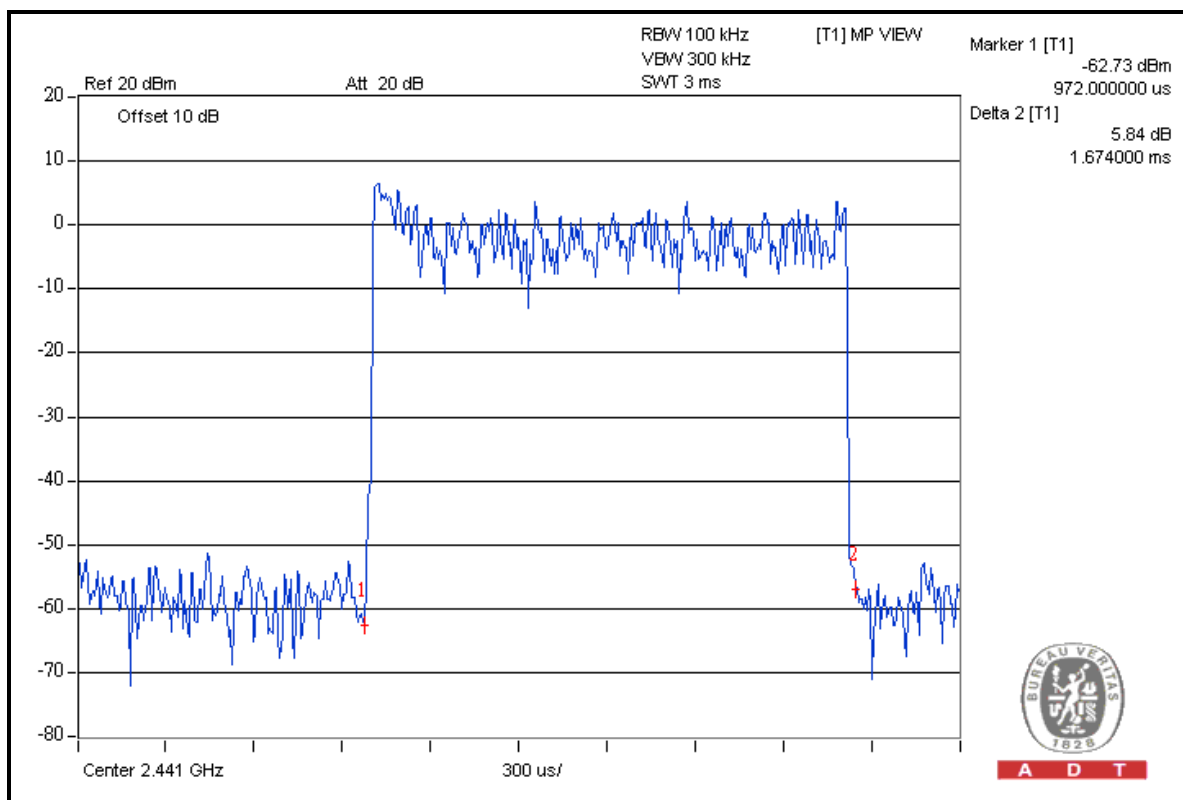
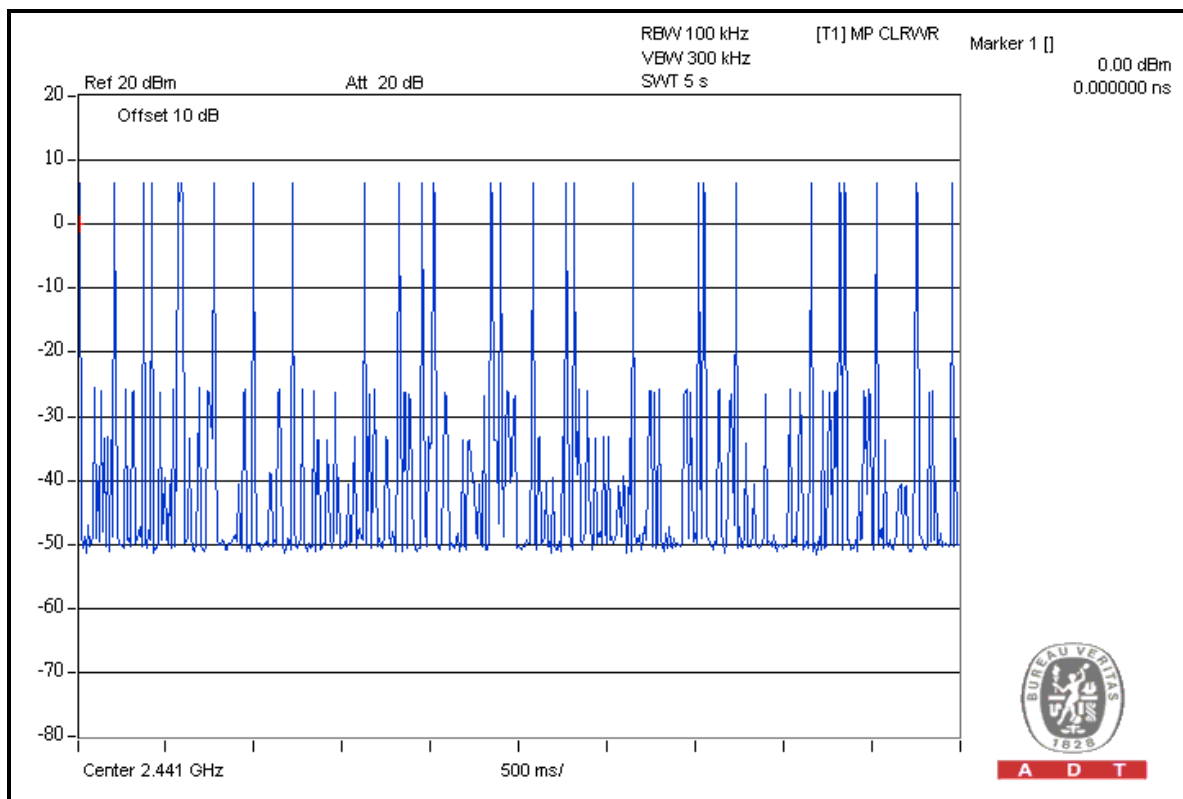



A D T

### DH5

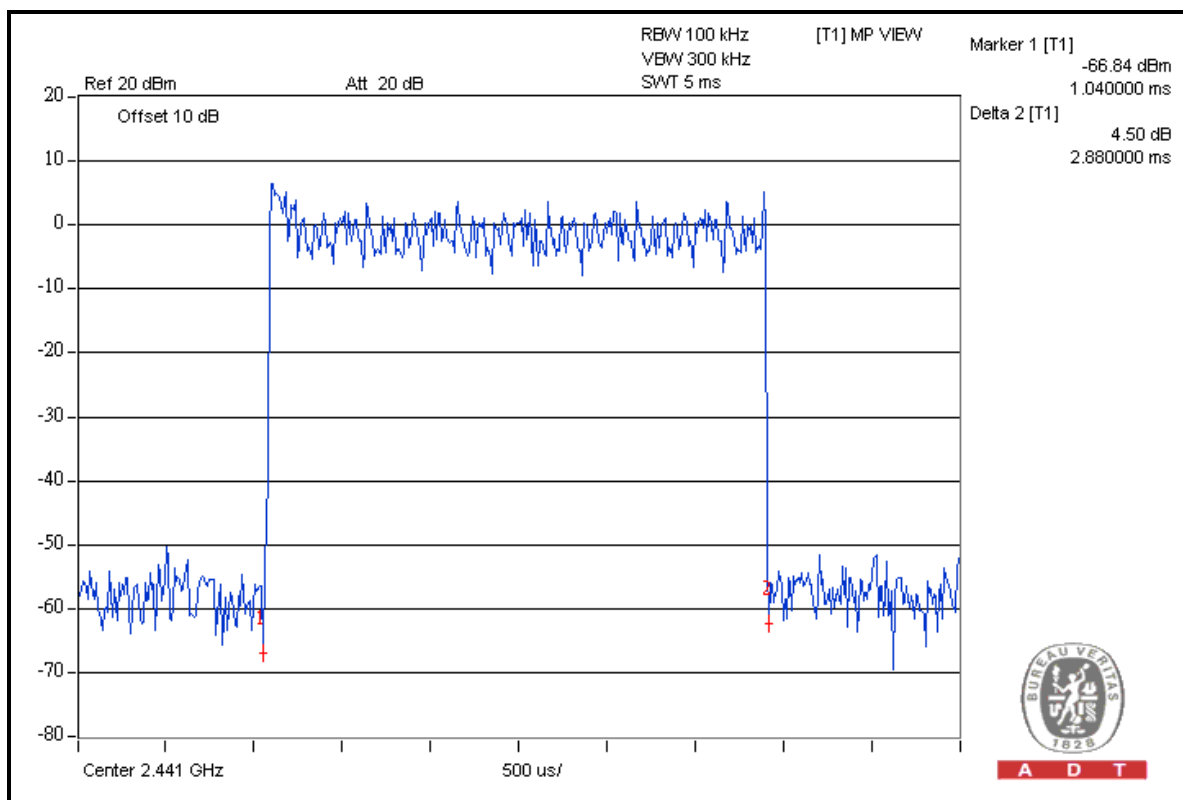
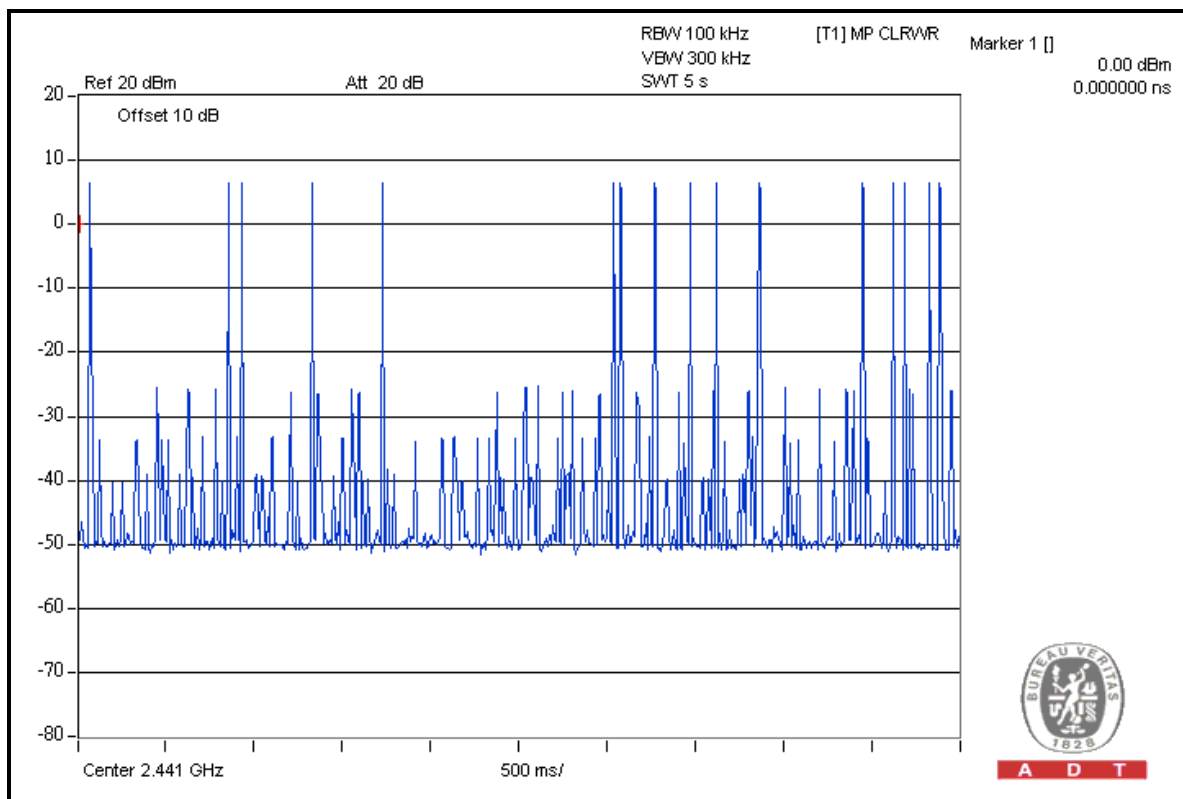

## 4.5 CHANNEL BANDWIDTH

### 4.5.1 LIMITS OF CHANNEL BANDWIDTH

For frequency hopping system operating in the 2400-2483.5MHz, If the two-thirds 20dB bandwidth of hopping channel is greater than 25kHz, two-thirds 20dB bandwidth of hopping channel shall be a minimum limit for the hopping channel separation.

### 4.5.2 TEST INSTRUMENTS

**Test date: Dec. 03, 2011**

DESCRIPTION & MANUFACTURER	MODEL NO.	SERIAL NO.	CALIBRATED DATE	CALIBRATED UNTIL
R&S Spectrum Analyzer	FSP40	100036	Dec. 08, 2010	Dec. 07, 2011

**NOTE:** The calibration interval of the above test instruments is 12 months and the calibrations are traceable to NML/ROC and NIST/USA.

### 4.5.3 TEST PROCEDURE

1. Check the calibration of the measuring instrument using either an internal calibrator or a known signal from an external generator.
2. Turn on the EUT and connect it to measurement instrument. Then set it to any one convenient frequency within its operating range. Set a reference level on the measuring instrument equal to the highest peak value.
3. Measure the frequency difference of two frequencies that were attenuated 20dB from the reference level. Record the frequency difference as the emission bandwidth.
4. Repeat above procedures until all frequencies measured were complete.

### 4.5.4 DEVIATION FROM TEST STANDARD

No deviation

#### 4.5.5 TEST SETUP

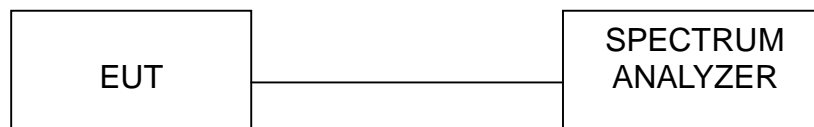

#### 4.5.6 EUT OPERATING CONDITION

The software provided by client enabled the EUT to transmit and receive data at lowest, middle and highest channel frequencies individually.



A D T

### 4.5.7 TEST RESULTS

For GFSK:

CHANNEL	CHANNEL FREQUENCY (MHz)	20dB BANDWIDTH (MHz)
0	2402	0.95
39	2441	0.95
78	2480	0.95

#### CH 78

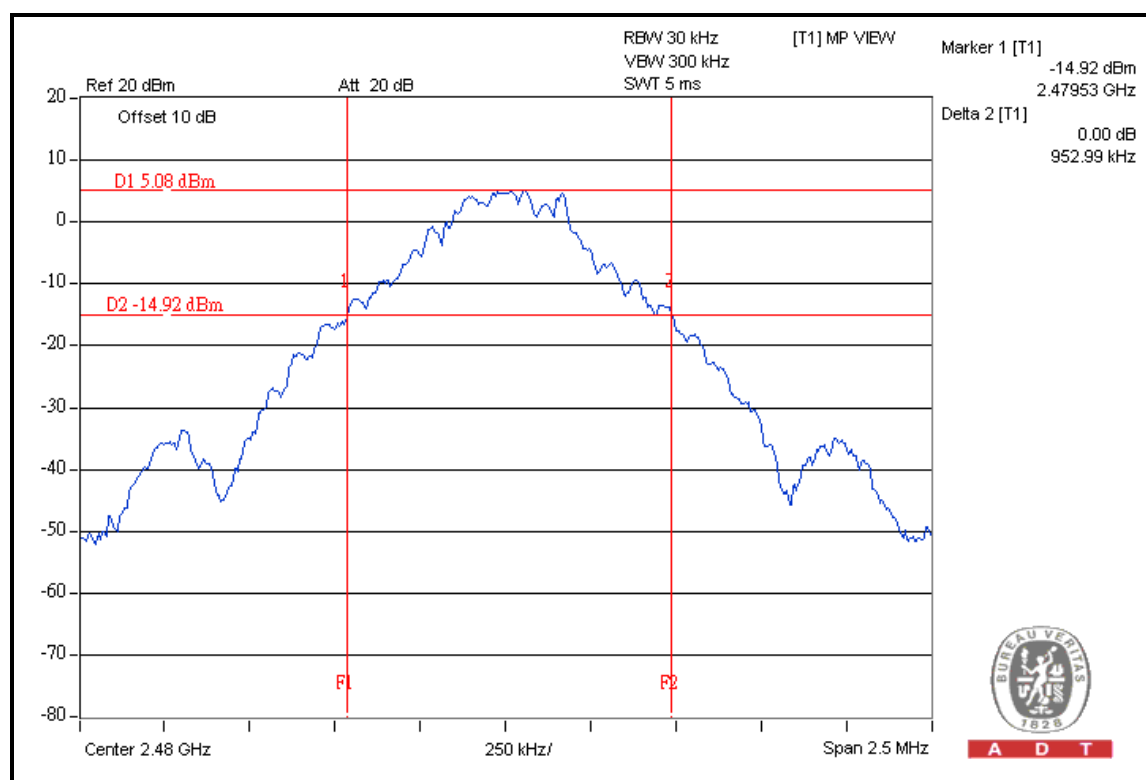





A D T

For 8DPSK:

CHANNEL	CHANNEL FREQUENCY (MHz)	20dB BANDWIDTH (MHz)
0	2402	1.35
39	2441	1.34
78	2480	1.34

CH 0

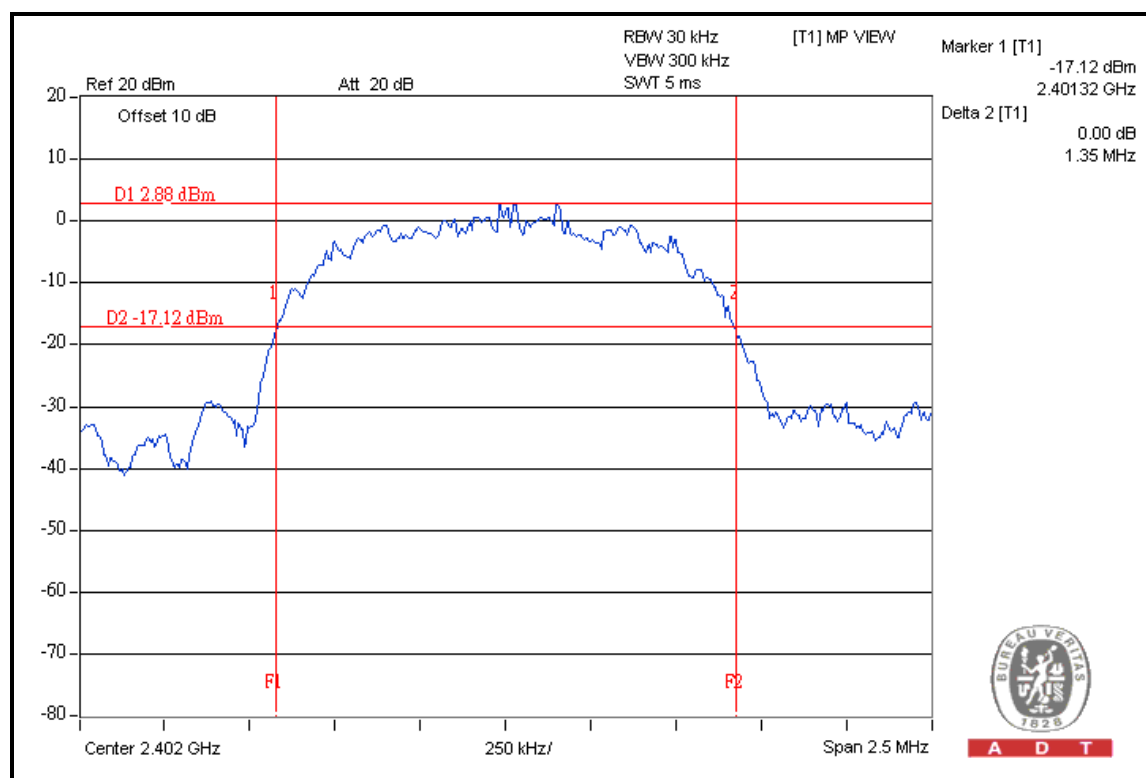

## 4.6 HOPPING CHANNEL SEPARATION

### 4.6.1 LIMIT OF HOPPING CHANNEL SEPARATION

At least 25 kHz or two-thirds of 20dB hopping channel bandwidth (whichever is greater).

### 4.6.2 TEST INSTRUMENTS

**Test date: Dec. 03, 2011**

DESCRIPTION & MANUFACTURER	MODEL NO.	SERIAL NO.	CALIBRATED DATE	CALIBRATED UNTIL
R&S Spectrum Analyzer	FSP40	100036	Dec. 08, 2010	Dec. 07, 2011

**NOTE:** The calibration interval of the above test instruments is 12 months and the calibrations are traceable to NML/ROC and NIST/USA.

### 4.6.3 TEST PROCEDURES

1. Check the calibration of the measuring instrument using either an internal calibrator or a known signal from an external generator.
2. Turn on the EUT and connect it to measurement instrument. Then set it to any one convenient frequency within its operating range.
3. By using the MaxHold function record the separation of two adjacent channels.
4. Measure the frequency difference of these two adjacent channels by SA MARK function. And then plot the result on SA screen.
5. Repeat above procedures until all frequencies measured were complete.

### 4.6.4 DEVIATION FROM TEST STANDARD

No deviation

### 4.6.5 TEST SETUP

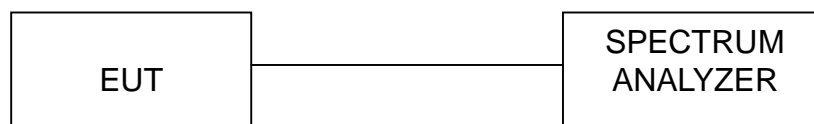



A D T

### 4.6.6 TEST RESULTS

#### For GFSK

Channel	Frequency (MHz)	Adjacent Channel Separation (MHz)	Minimum Limit (MHz)	Pass / Fail
0	2402	1.000	0.63	PASS
39	2441	1.010	0.63	PASS
78	2480	1.010	0.63	PASS

**NOTE:** The minimum limit is two-third 20dB bandwidth.

#### CH 39

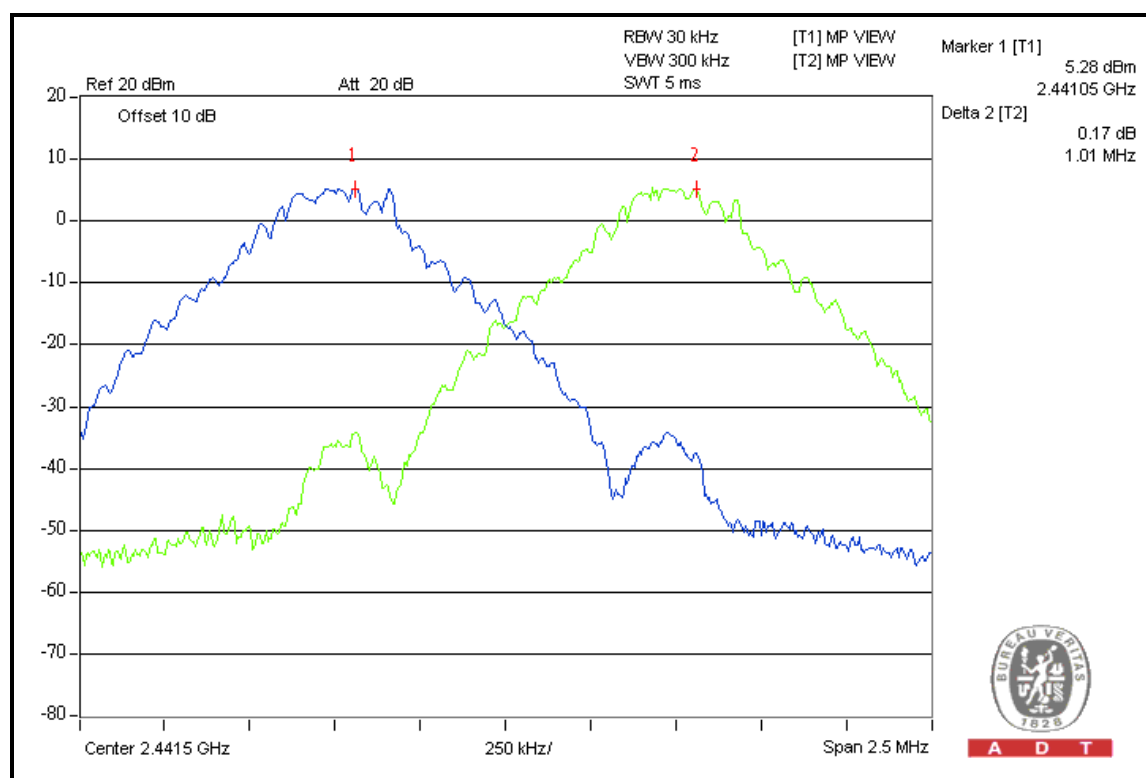



A D T

### For 8DPSK

Channel	Frequency (MHz)	Adjacent Channel Separation (MHz)	Minimum Limit (MHz)	Pass / Fail
0	2402	1.00	0.9	PASS
39	2441	1.01	0.89	PASS
78	2480	1.00	0.89	PASS

**NOTE:** The minimum limit is two-third 20dB bandwidth.

### CH 39

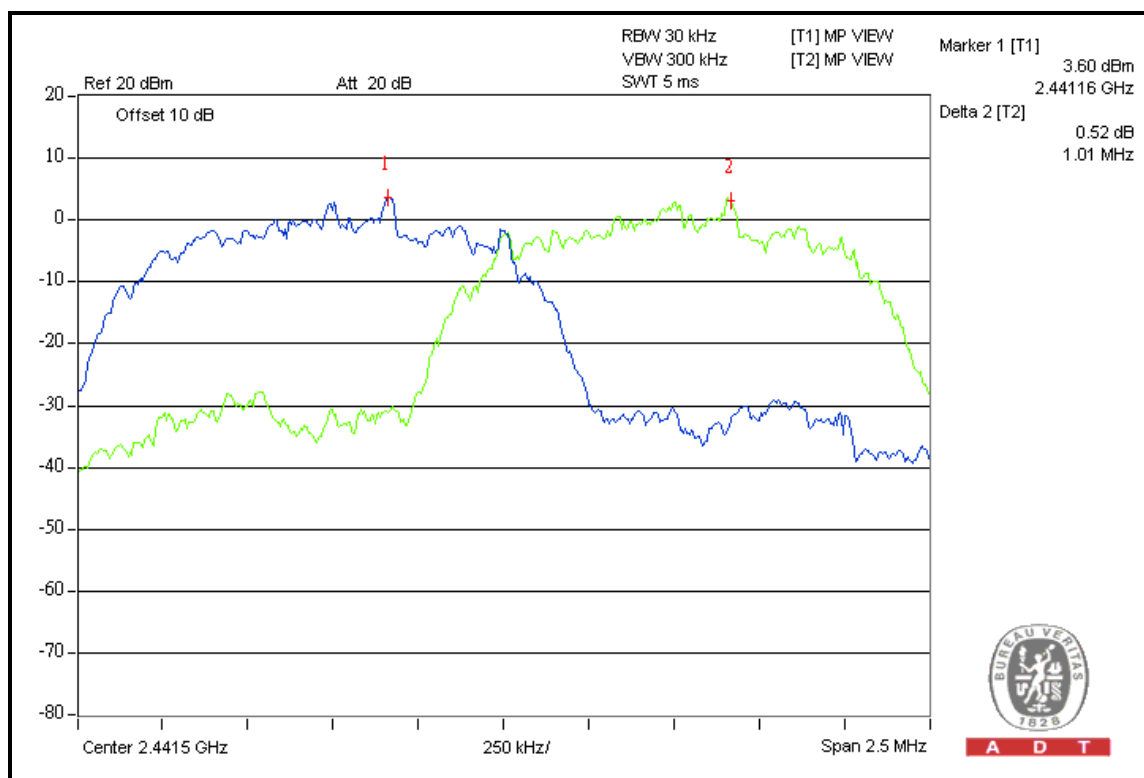

## 4.7 MAXIMUM PEAK OUTPUT POWER

### 4.7.1 LIMITS OF MAXIMUM PEAK OUTPUT POWER MEASUREMENT

The Maximum Peak Output Power Limit is 125mW.

### 4.7.2 INSTRUMENTS

Test date: Dec. 03, 2011

DESCRIPTION & MANUFACTURER	MODEL NO.	SERIAL NO.	CALIBRATED DATE	CALIBRATED UNTIL
R&S Spectrum Analyzer	FSP 40	100060	May 11, 2011	May 10, 2012

**NOTE:** The calibration interval of the above test instruments is 12 months and the calibrations are traceable to NML/ROC and NIST/USA.

### 4.7.3 TEST PROCEDURES

1. Check the calibration of the measuring instrument using either an internal calibrator or a known signal from an external generator.
2. Turn on the EUT and connect it to measurement instrument. Then set it to any one convenient frequency within its operating range. Set a reference level on the measuring instrument equal to the highest peak value.
3. The center frequency of the spectrum analyzer is set to the fundamental frequency and using 3 MHz RBW and 10 MHz VBW.
4. Measure the captured power within the band and recording the plot.
5. Repeat above procedures until all frequencies measured were complete.

### 4.7.4 DEVIATION FROM TEST STANDARD

No deviation

#### 4.7.5 TEST SETUP

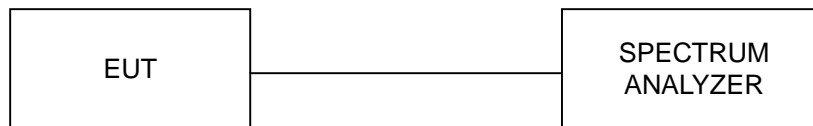

For the actual test configuration, please refer to the related Item – Photographs of the Test Configuration.

#### 4.7.6 EUT OPERATING CONDITION

The software provided by client enabled the EUT to transmit and receive data at lowest, middle and highest channel frequencies individually.



A D T

### 4.7.7 TEST RESULTS

#### GFSK

CHANNEL	CHANNEL FREQUENCY (MHz)	POWER OUTPUT (dBm)	POWER OUTPUT (mW)	POWER LIMIT (mW)	PASS/FAIL
0	2402	11.30	13.490	125	PASS
39	2441	10.50	11.220	125	PASS
78	2480	10.30	10.715	125	PASS

Note: Output Power = Measurement PWR + Trace loss (2.35dB)

#### CH 0

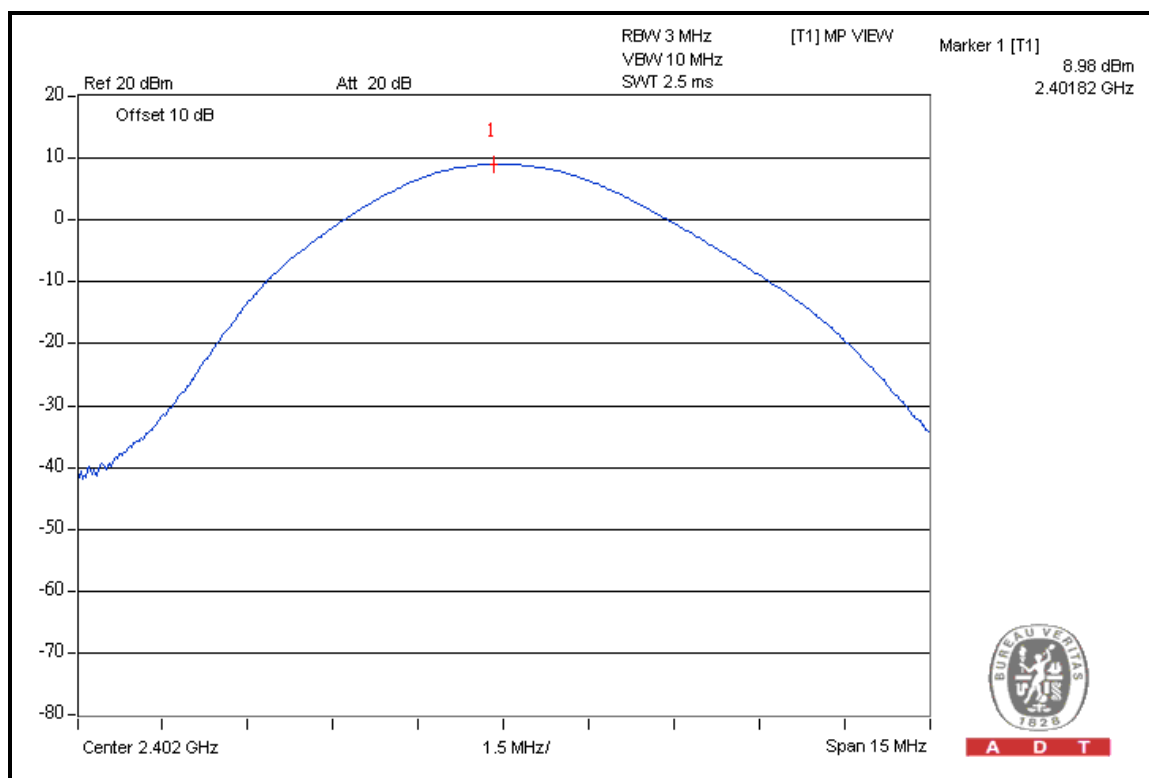



A D T

### For 8DPSK

CHANNEL	CHANNEL FREQUENCY (MHz)	POWER OUTPUT (dBm)	POWER OUTPUT (mW)	POWER LIMIT (mW)	PASS/FAIL
0	2402	11.70	14.791	125	PASS
39	2441	10.90	12.303	125	PASS
78	2480	10.70	11.749	125	PASS

Note: Output Power = Measurement PWR + Trace loss (2.35dB)

### CH 0

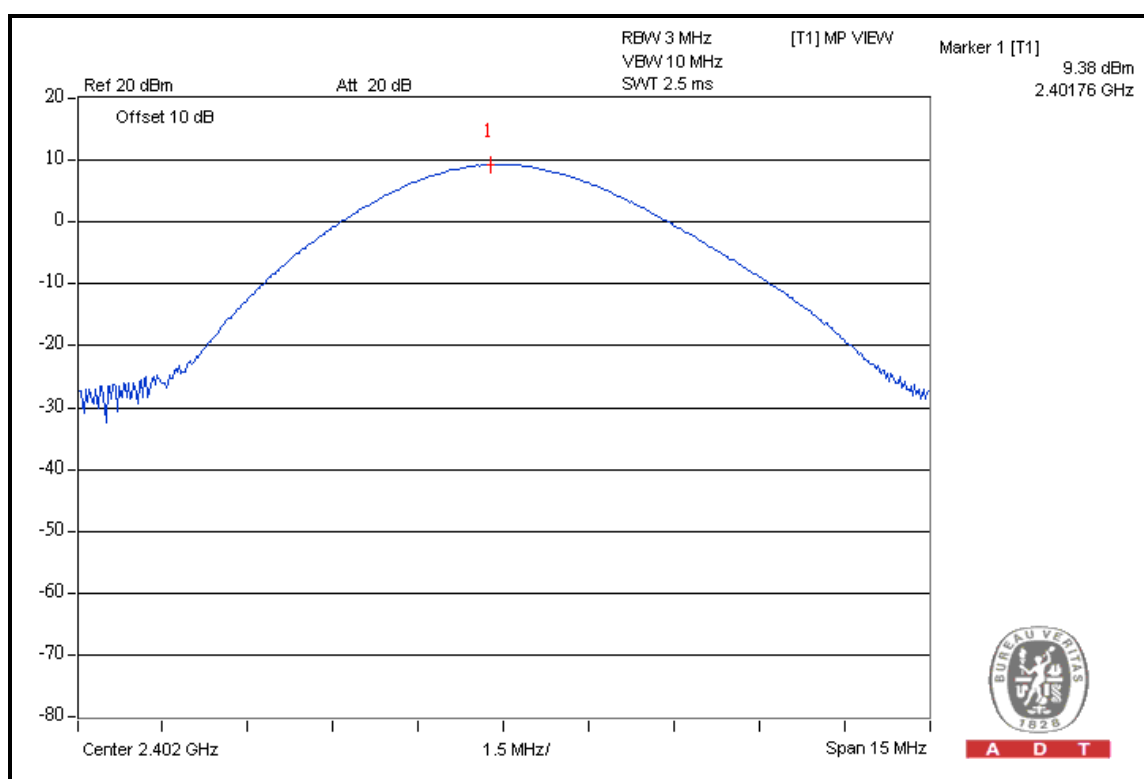



## 4.8 CONDUCTED OUT-BAND EMISSION MEASUREMENT

### 4.8.1 LIMITS OF CONDUCTED OUT-BAND EMISSION MEASUREMENT

Below  $-20\text{dB}$  of the highest emission level of operating band (in 100kHz RBW).

### 4.8.2 TEST INSTRUMENTS

**Test date: Dec. 03, 2011**

DESCRIPTION & MANUFACTURER	MODEL NO.	SERIAL NO.	CALIBRATED DATE	CALIBRATED UNTIL
R&S Spectrum Analyzer	FSP40	100036	Dec. 08, 2010	Dec. 07, 2011

**NOTE:** The calibration interval of the above test instruments is 12 months and the calibrations are traceable to NML/ROC and NIST/USA.

### 4.8.3 TEST PROCEDURE

The transmitter output was connected to the spectrum analyzer via a low lose cable. Set RBW a of spectrum analyzer to 100 kHz and VBW of spectrum analyzer to 300 kHz with suitable frequency span including 100 MHz bandwidth from band edge. The band edges was measured and recorded.

### 4.8.4 DEVIATION FROM TEST STANDARD

No deviation

### 4.8.5 EUT OPERATING CONDITION

The software provided by client enabled the EUT to transmit and receive data at lowest, middle and highest channel frequencies individually.

#### 4.8.6 TEST RESULTS

The spectrum plots are attached on the following images. D1 line indicates the highest level, and D2 line indicates the 20dB offset below D1. It shows compliance with the requirement in part 15.247(d).



A D T

### For GFSK Modulation Type:

### CH 0

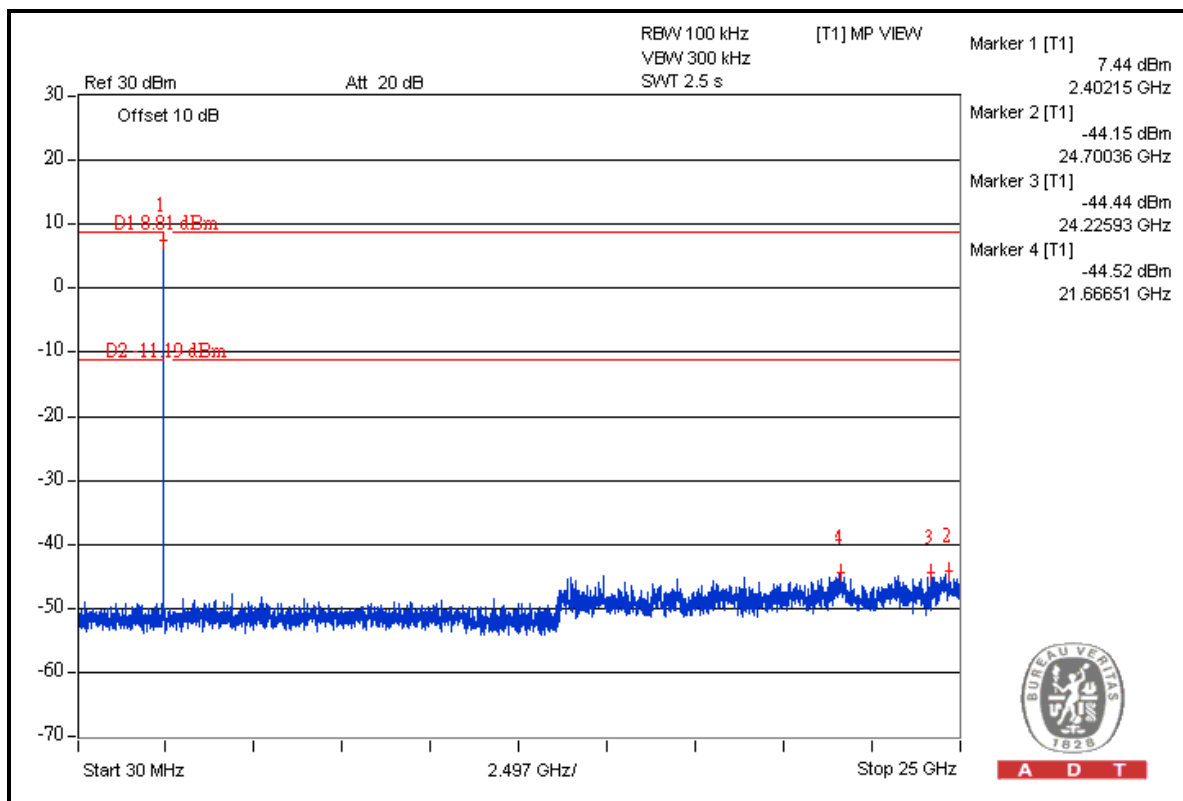
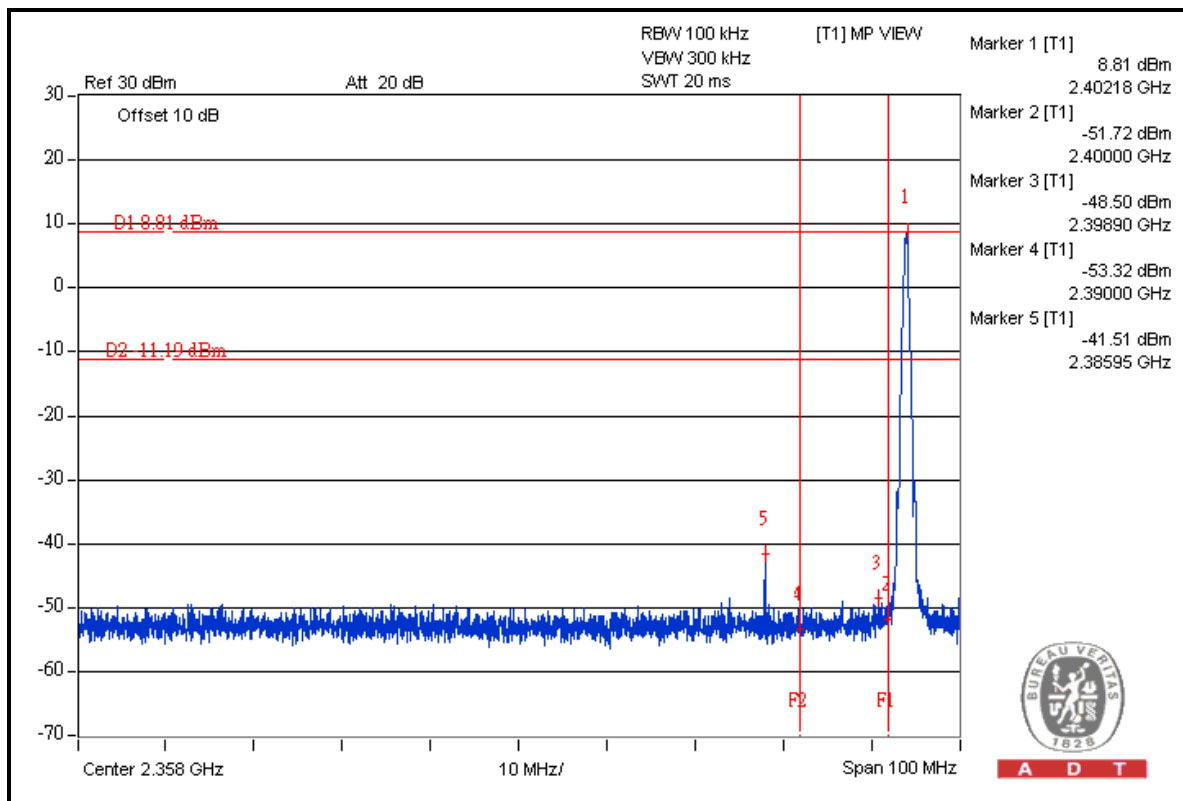



A D T

### CH 78

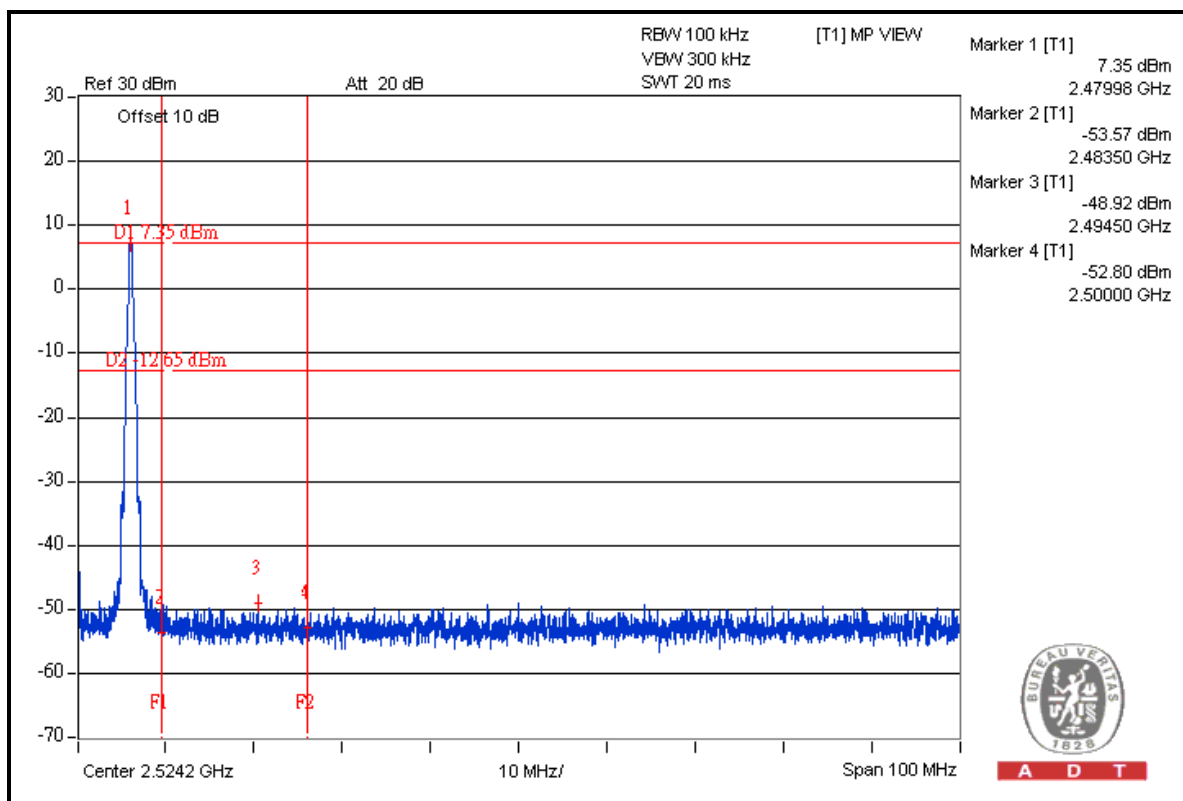

A D T

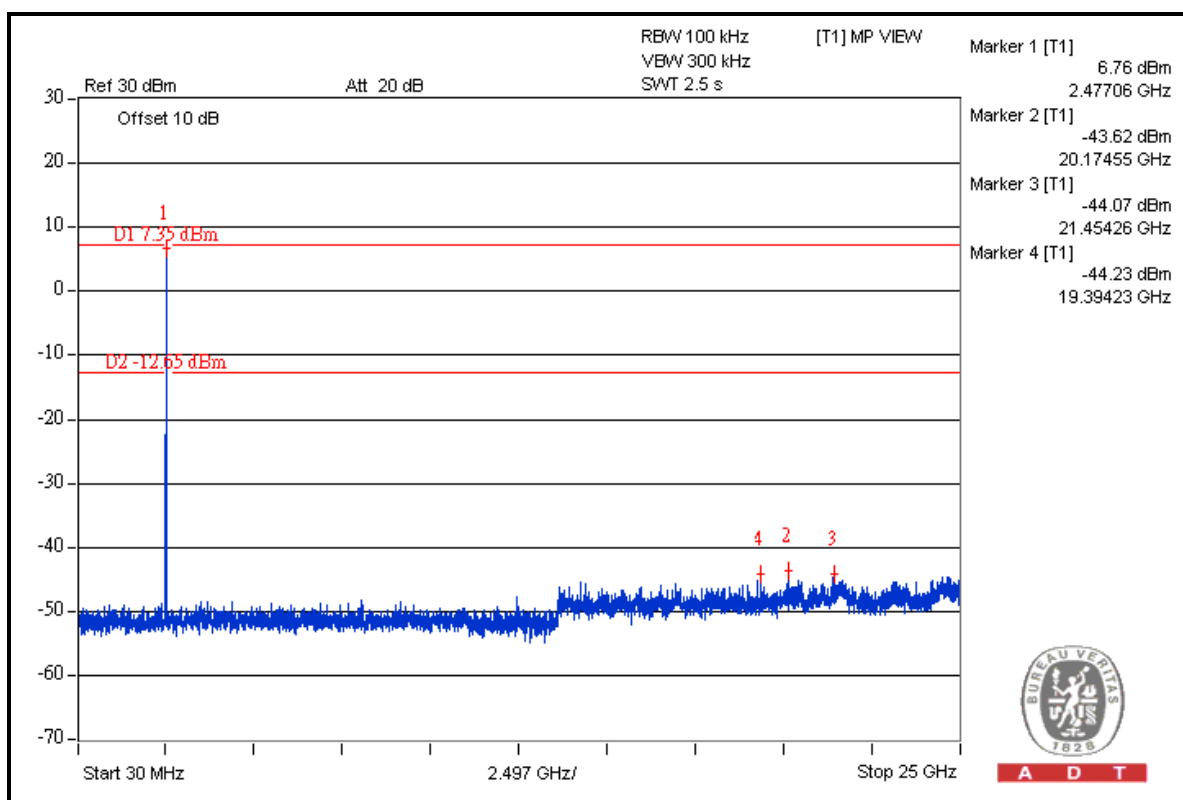

A D T



A D T

### For 8DPSK Modulation Type: CH 0

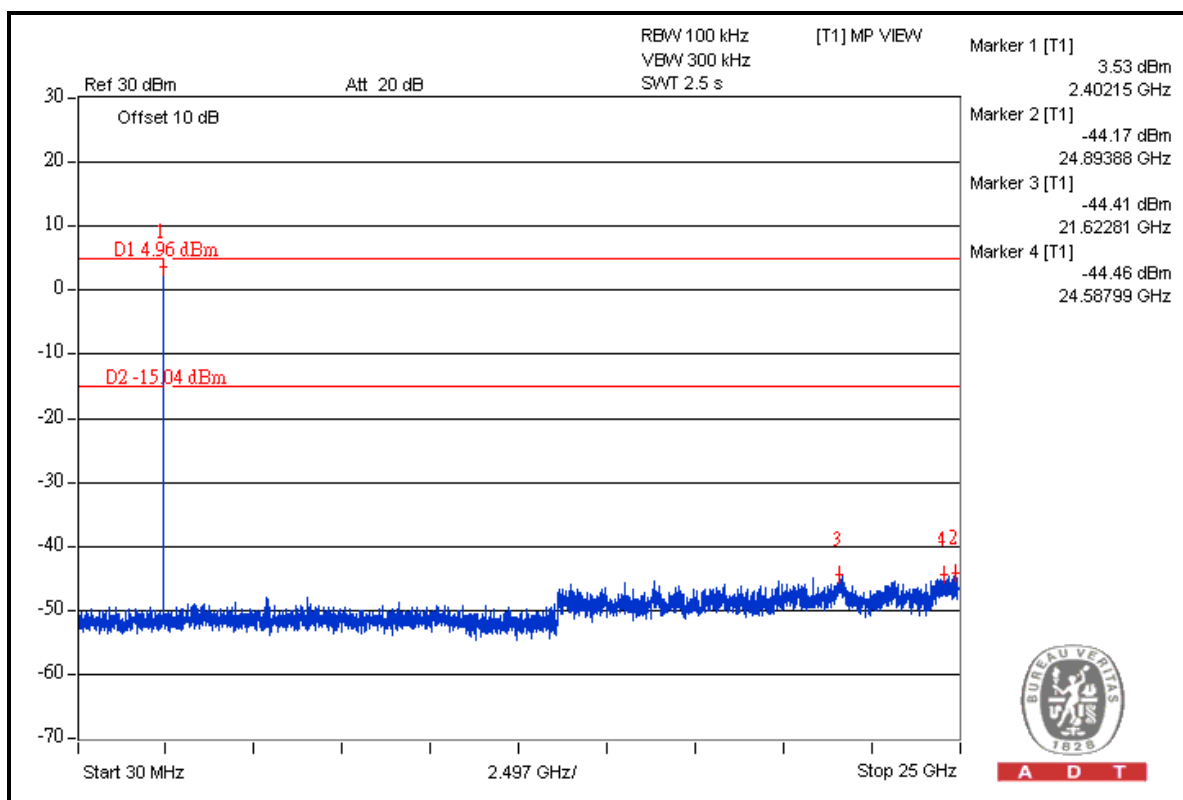
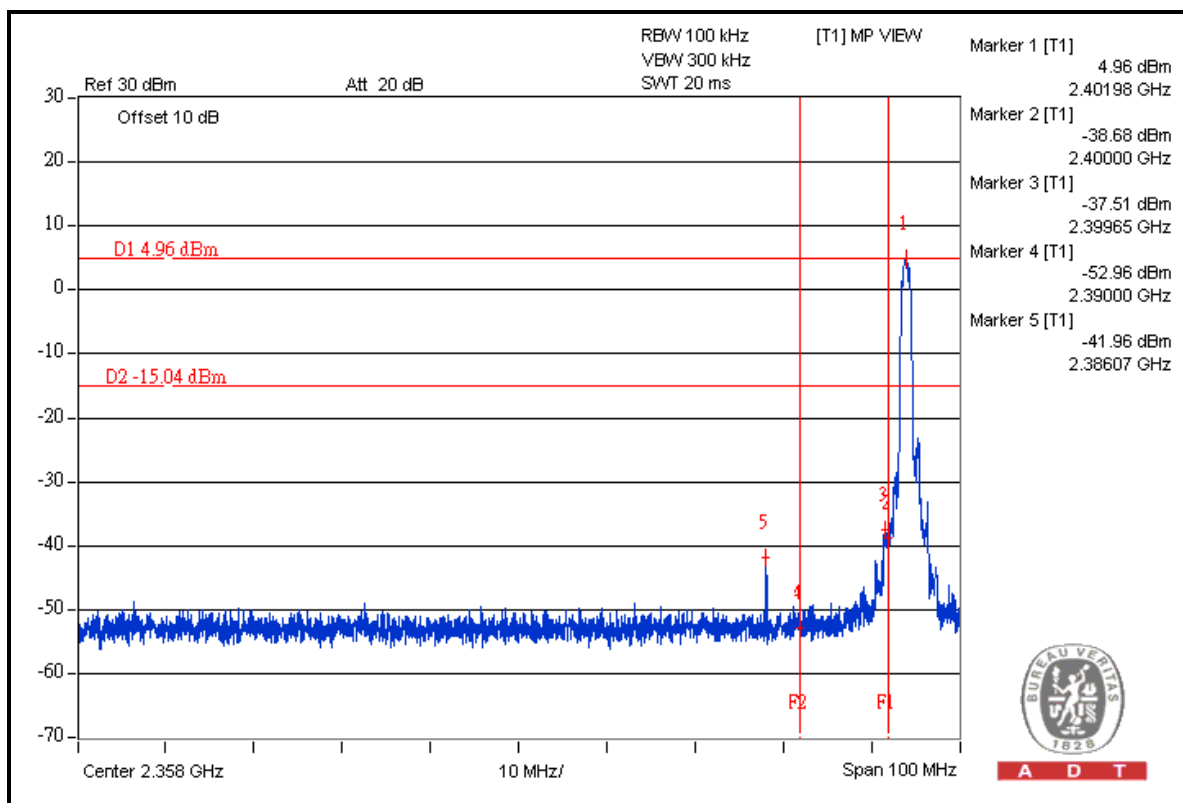



A D T

### CH 78

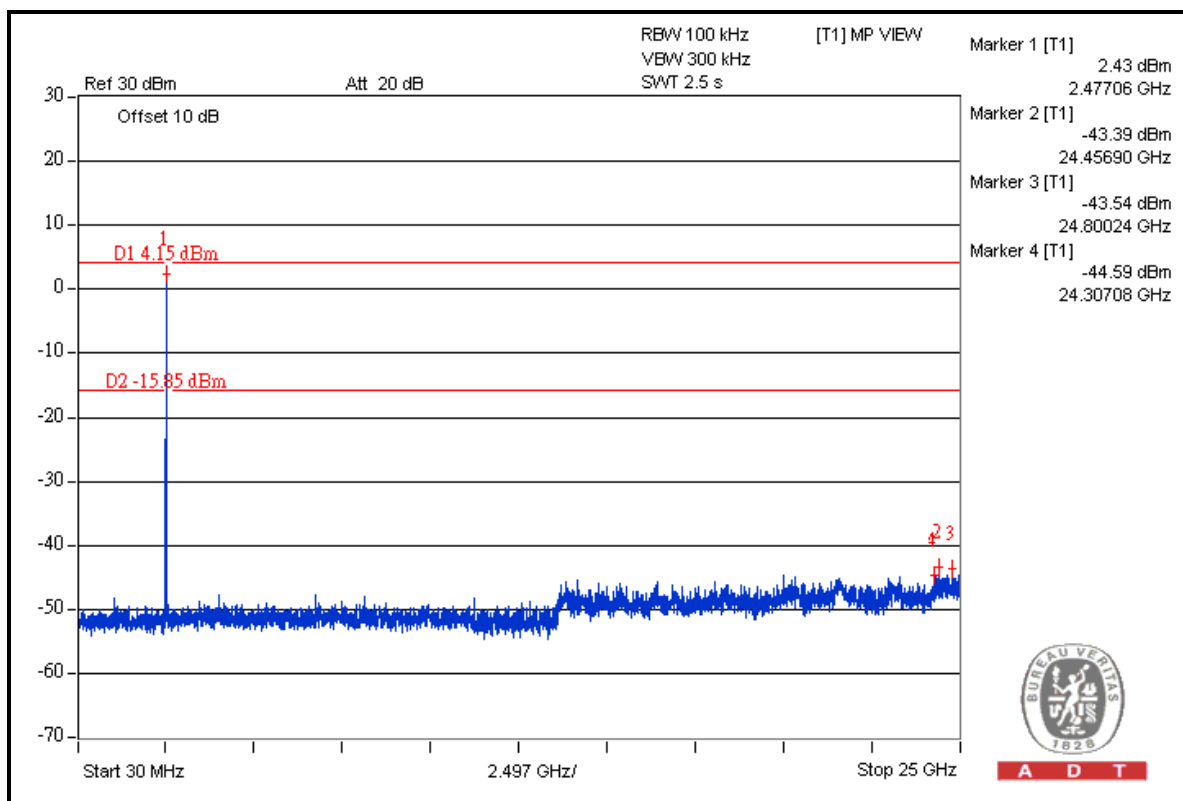
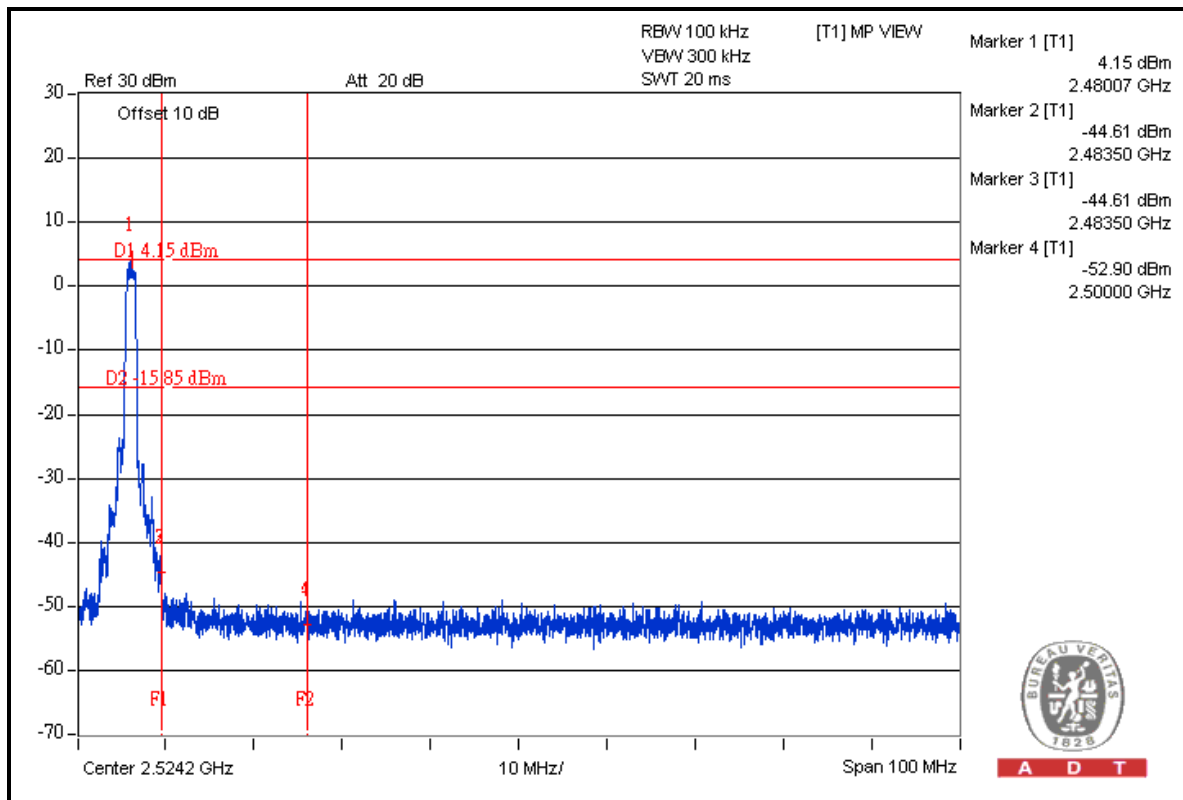



## 5 INFORMATION ON THE TESTING LABORATORIES

We, Bureau Veritas Consumer Products Services (H.K.) Ltd., Taoyuan Branch, were founded in 1988 to provide our best service in EMC, Radio, Telecom and Safety consultation. Our laboratories are accredited and approved according to ISO/IEC 17025.

Copies of accreditation and authorization certificates of our laboratories obtained from approval agencies can be downloaded from our web site:

[www.adt.com.tw/index.5.phtml](http://www.adt.com.tw/index.5.phtml).

If you have any comments, please feel free to contact us at the following:

**Linko EMC/RF Lab:**

Tel: 886-2-26052180

Fax: 886-2-26052943

**Hsin Chu EMC/RF Lab:**

Tel: 886-3-5935343

Fax: 886-3-5935342

**Hwa Ya EMC/RF/Safety/Telecom Lab:**

Tel: 886-3-3183232

Fax: 886-3-3185050

**Email:** [service.adt@tw.bureauveritas.com](mailto:service.adt@tw.bureauveritas.com)

**Web Site:** [www.adt.com.tw](http://www.adt.com.tw)

The address and road map of all our labs can be found in our web site also.

## **6 APPENDIX A - MODIFICATIONS RECORDERS FOR ENGINEERING CHANGES TO THE EUT BY THE LAB**

No modifications were made to the EUT by the lab during the test.

**--- END ---**