

Supplementary FCC Test Report

Report No.: RF111028C08E

FCC ID: UZ7211486030A

Test Model: 21-148603-0A

Received Date: Mar. 24, 2016

Test Date: Apr. 07 to 12, 2016

Issued Date: Apr. 21, 2016

Applicant: Zebra Technologies Corporation

Address: 1 Zebra Plaza, Holtsville, NY 11742

Issued By: Bureau Veritas Consumer Products Services (H.K.) Ltd., Taoyuan Branch
Hsin Chu Laboratory

Lab Address: E-2, No.1, Li Hsin 1st Road, Hsinchu Science Park, Hsinchu City 300,
Taiwan R.O.C.

Test Location (1): E-2, No.1, Li Hsin 1st Road, Hsinchu Science Park, Hsinchu City 300,
Taiwan R.O.C.

Test Location (2): No. 49, Ln. 206, Wende Rd., Shangshan Tsuen, Chiung Lin Hsiang, Hsin
Chu Hsien 307, Taiwan R.O.C.



This report is for your exclusive use. Any copying or replication of this report to or for any other person or entity, or use of our name or trademark, is permitted only with our prior written permission. This report sets forth our findings solely with respect to the test samples identified herein. The results set forth in this report are not indicative or representative of the quality or characteristics of the lot from which a test sample was taken or any similar or identical product unless specifically and expressly noted. Our report includes all of the tests requested by you and the results thereof based upon the information that you provided to us. You have 60 days from date of issuance of this report to notify us of any material error or omission caused by our negligence, provided, however, that such notice shall be in writing and shall specifically address the issue you wish to raise. A failure to raise such issue within the prescribed time shall constitute your unqualified acceptance of the completeness of this report, the tests conducted and the correctness of the report contents. Unless specific mention, the uncertainty of measurement has been explicitly taken into account to declare the compliance or non-compliance to the specification. The report must not be used by the client to claim product certification, approval, or endorsement by TAF or any government agencies.

Table of Contents

Report Issue History Record of EUT (21-148603-0A)	4
Release Control Record	4
1 Certificate of Conformity	5
2 Summary of Test Results	6
2.1 Measurement Uncertainty.....	6
2.2 Modification Record.....	6
3 General Information	7
3.1 General Description of EUT.....	7
3.2 Description of Test Modes.....	9
3.2.1 Test Mode Applicability and Tested Channel Detail.....	10
3.3 Duty Cycle of Test Signal.....	12
3.4 Description of Support Units.....	13
3.4.1 Configuration of System under Test.....	14
3.5 General Description of Applied Standard.....	15
4 Test Types and Results	16
4.1 Radiated Emission and Bandedge Measurement.....	16
4.1.1 Limits of Radiated Emission and Bandedge Measurement.....	16
4.1.2 Test Instruments.....	17
4.1.3 Test Procedure.....	18
4.1.4 Deviation from Test Standard.....	18
4.1.5 Test Setup.....	19
4.1.6 EUT Operating Condition.....	19
4.1.7 Test Results.....	20
4.2 Transmit Power Measurement.....	27
4.2.1 Limits of Transmit Power Measurement.....	27
4.2.2 Test Setup.....	28
4.2.3 Test Instruments.....	28
4.2.4 Test Procedure.....	28
4.2.5 Deviation from Test Standard.....	28
4.2.6 EUT Operating Condition.....	28
4.2.7 Test Result.....	29
4.3 Peak Power Spectral Density Measurement.....	31
4.3.1 Limits of Peak Power Spectral Density Measurement.....	31
4.3.2 Test Setup.....	31
4.3.3 Test Instruments.....	31
4.3.4 Test Procedure.....	31
4.3.5 Deviation from Test Standard.....	31
4.3.6 EUT Operating Condition.....	31
4.3.7 Test Results.....	32
4.4 Frequency Stability Measurement.....	34
4.4.1 Limits of Frequency Stability Measurement.....	34
4.4.2 Test Setup.....	34
4.4.3 Test Instruments.....	34
4.4.4 Test Procedure.....	34
4.4.5 Deviation from Test Standard.....	34
4.4.6 EUT Operating Condition.....	34
4.4.7 Test Results.....	35
4.5 6dB Bandwidth Measurement.....	36
4.5.1 Limits of 6dB Bandwidth Measurement.....	36
4.5.2 Test Setup.....	36
4.5.3 Test Instruments.....	36
4.5.4 Test Procedure.....	36



4.5.5 Deviation from Test Standard	36
4.5.6 EUT Operating Condition	36
4.5.7 Test Results	37
5 Pictures of Test Arrangements.....	39
Appendix – Information on the Testing Laboratories	40



Report Issue History Record of EUT (21-148603-0A)

Attachment No.	Issue Date	Description
111028C08	Mar. 09, 2012	Original release.
111028C08E	Apr. 21, 2016	Upgrade the standard to section 15.407 under new rule.

Release Control Record

Issue No.	Description	Date Issued
RF111028C08E	Original release.	Apr. 21, 2016



A D T

1 Certificate of Conformity

Product: Radio Module

Brand: Zebra

Test Model: 21-148603-0A

Sample Status: ENGINEERING SAMPLE

Applicant: Zebra Technologies Corporation

Test Date: Apr. 07 to 12, 2016

Standard: 47 CFR FCC Part 15, Subpart E (Section 15.407)
ANSI C63.10: 2013

The above equipment has been tested by **Bureau Veritas Consumer Products Services (H.K.) Ltd., Taoyuan Branch**, and found compliance with the requirement of the above standards. The test record, data evaluation & Equipment Under Test (EUT) configurations represented herein are true and accurate accounts of the measurements of the sample's EMC characteristics under the conditions specified in this report.

Prepared by : Wendy Wu , **Date:** Apr. 21, 2016
Wendy Wu / Specialist

Approved by : May Chen , **Date:** Apr. 21, 2016
May Chen / Manager

2 Summary of Test Results

47 CFR FCC Part 15, Subpart E (SECTION 15.407)			
FCC Clause	Test Item	Result	Remarks
15.407(b) (1/2/3/4/6)	Radiated Emissions & Band Edge Measurement	PASS	Meet the requirement of limit. Minimum passing margin is -1.6dB at 5850.00MHz.
15.407(a)(1/2 /3)	Max Average Transmit Power	PASS	Meet the requirement of limit.
15.407(a)(1/2 /3)	Peak Power Spectral Density	PASS	Meet the requirement of limit.
15.407(e)	6dB bandwidth	PASS	Meet the requirement of limit. (U-NII-3 Band only)
15.407(g)	Frequency Stability	PASS	Meet the requirement of limit.
15.203	Antenna Requirement	PASS	Antenna connector is SMA not a standard connector.

NOTE: 1. This report is prepared for FCC Class II change. (Upgraded the standard to section 15.407 under new rule for U-NII-3 band)

2.1 Measurement Uncertainty

Where relevant, the following measurement uncertainty levels have been estimated for tests performed on the EUT as specified in CISPR 16-4-2:

Measurement	Frequency	Expanded Uncertainty (k=2) (±)
Radiated Emissions up to 1 GHz	30MHz ~ 1GHz	5.37 dB
Radiated Emissions above 1 GHz	1GHz ~ 6GHz	3.65 dB
	6GHz ~ 18GHz	3.88 dB
	18GHz ~ 40GHz	4.11 dB

2.2 Modification Record

There were no modifications required for compliance.

3 General Information

3.1 General Description of EUT

Product	Radio Module
Brand	Zebra
Test Model	21-148603-0A
Status of EUT	ENGINEERING SAMPLE
Power Supply Rating	DC 3.3V
Modulation Type	CCK, DQPSK, DBPSK for DSSS 64QAM, 16QAM, QPSK, BPSK for OFDM
Modulation Technology	DSSS, OFDM
Transfer Rate	802.11b: up to 11Mbps 802.11a/g: up to 54Mbps 802.11n: up to 72.2Mbps
Operating Frequency	For 15.407: 5.18 ~ 5.24GHz, 5.26 ~ 5.32GHz, 5.5~5.58GHz & 5.66~5.7GHz, 5.745 ~ 5.825GHz
	For 15.247: 2.412 ~ 2.472GHz
Number of Channel	For 15.407: 802.11a, 802.11n (HT20): 5
	For 15.247: 802.11b, 802.11g, 802.11n (HT20):13
Output Power	For 15.407: 5.18 ~ 5.24GHz 32.4mW 5.26 ~ 5.32GHz 102.3mW 5.5~5.58GHz & 5.66~5.7GHz 97.7mW 5.745 ~ 5.825GHz 73.961mW
	For 15.247: 257.0mW
Antenna Type	Refer to Note
Antenna Connector	Refer to Note
Accessory Device	NA
Data Cable Supplied	NA

Note:

1. This is a supplementary report of Report No.: RF111028C08. The differences between them are as below information:
 - ◆ Upgraded the standard to section 15.407 under new rule for and U-NII-3 band.
 - ◆ Changed the applicant's name and address.
2. According to above conditions, all test items of U-NII-3 band test item need to be performed, except for AC power conducted emission test item. And all data was verified to meet the requirements.
3. There are Bluetooth technology, GPS technology and WLAN technology used for the EUT.
4. The antennas provided to the EUT, please refer to the following table:

No.	Type	Connector	Model	Peak Gain (dBi)	Cable loss (dB)	Net Peak Gain (dBi)	Trace
1	Dipole	Reverse SMA	ML-2452-APA2-01 Rev C	2.4GHz : 3 5GHz : 5	2.4GHz : 0.75 5GHz : 1.3	2.4GHz : 2.25 5GHz : 3.7	WiFi + BT
2	Chip	Reverse SMA	NA	-	-		GPS

5. The EUT was included two SKU, which are identical to each other in all aspects except for the following table:

	P/N	Description
SKU #1	21-148603-01	Diversity version with WLAN and BT on SHARED RF paths
SKU #2	21-148603-03	NON-Diversity version with WLAN and BT on SHARED RF paths

6. Spurious Emission of the simultaneous operation (WiFi & Bluetooth) have been evaluated and no non-compliance found. (The device can transmit simultaneously on WLAN (5GHz) mode and Bluetooth mode; other modes can't support simultaneously ability.)
7. The EUT is 1 * 1 spatial SISO (1Tx & 1Rx) without beam forming function.
8. The above EUT information is declared by manufacturer and for more detailed features description, please refer to the manufacturer's specifications or user's manual.

3.2 Description of Test Modes

FOR 5745 ~ 5825MHz:

5 channels are provided for 802.11a, 802.11n (HT20):

Channel	Frequency	Channel	Frequency
149	5745MHz	161	5805MHz
153	5765MHz	165	5825MHz
157	5785MHz		

3.2.1 Test Mode Applicability and Tested Channel Detail

EUT CONFIGURE MODE	APPLICABLE TO				DESCRIPTION
	RE≥1G	RE<1G	PLC	APCM	
-	√	√	-	√	-

Where **RE≥1G**: Radiated Emission above 1GHz **RE<1G**: Radiated Emission below 1GHz
PLC: Power Line Conducted Emission **APCM**: Antenna Port Conducted Measurement

Radiated Emission Test (Above 1GHz):

- Pre-Scan has been conducted to determine the worst-case mode from all possible combinations between available modulations, data rates and antenna ports (if EUT with antenna diversity architecture).
- Following channel(s) was (were) selected for the final test as listed below.

MODE	FREQ. BAND (MHz)	AVAILABLE CHANNEL	TESTED CHANNEL	MODULATION TECHNOLOGY	MODULATION TYPE	DATA RATE (Mbps)
802.11a	5745-5825	149 to 165	149, 157, 165	OFDM	BPSK	6
802.11n (HT20)		149 to 165	149, 157, 165	OFDM	BPSK	6.5

Radiated Emission Test (Below 1GHz):

- Pre-Scan has been conducted to determine the worst-case mode from all possible combinations between available modulations, data rates and antenna ports (if EUT with antenna diversity architecture).
- Following channel(s) was (were) selected for the final test as listed below.

MODE	FREQ. BAND (MHz)	AVAILABLE CHANNEL	TESTED CHANNEL	MODULATION TECHNOLOGY	MODULATION TYPE	DATA RATE (Mbps)
802.11a	5745-5825	149 to 165	157	OFDM	BPSK	6

Antenna Port Conducted Measurement:

- This item includes all test value of each mode, but only includes spectrum plot of worst value of each mode.
- Pre-Scan has been conducted to determine the worst-case mode from all possible combinations between available modulations, data rates and antenna ports (if EUT with antenna diversity architecture).
- Following channel(s) was (were) selected for the final test as listed below.

MODE	FREQ. BAND (MHz)	AVAILABLE CHANNEL	TESTED CHANNEL	MODULATION TECHNOLOGY	MODULATION TYPE	DATA RATE (Mbps)
802.11a	5745-5825	149 to 165	149, 157, 165	OFDM	BPSK	6
802.11n (HT20)		149 to 165	149, 157, 165	OFDM	BPSK	6.5



Test Condition:

APPLICABLE TO	ENVIRONMENTAL CONDITIONS	INPUT POWER	TESTED BY	TEST LOCATION
RE\geq1G	24deg. C, 65%RH	120Vac, 60Hz	Jyunchun Lin	2
RE$<$1G	24deg. C, 65%RH	120Vac, 60Hz	Jyunchun Lin	2
APCM	24deg. C, 62%RH	120Vac, 60Hz	Anderson Chen	1

3.3 Duty Cycle of Test Signal

Duty cycle of test signal is < 98 %, duty factor shall be considered.

802.11a: Duty cycle = 1.927 ms/2.142 ms = 0.90, Duty factor = $10 * \log(1/0.90) = 0.46$

802.11n (HT20): Duty cycle = 1.795 ms/2.015 ms = 0.891, Duty factor = $10 * \log(1/0.891) = 0.50$

802.11a

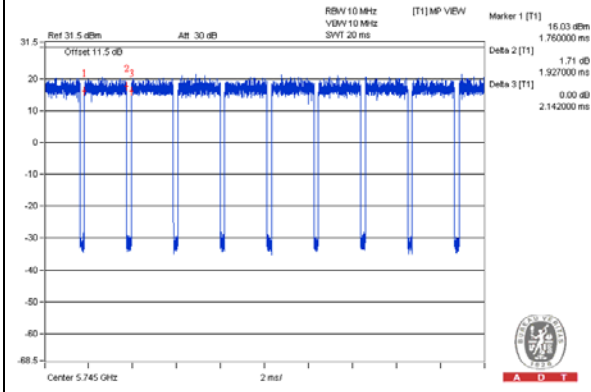

802.11n (HT20)

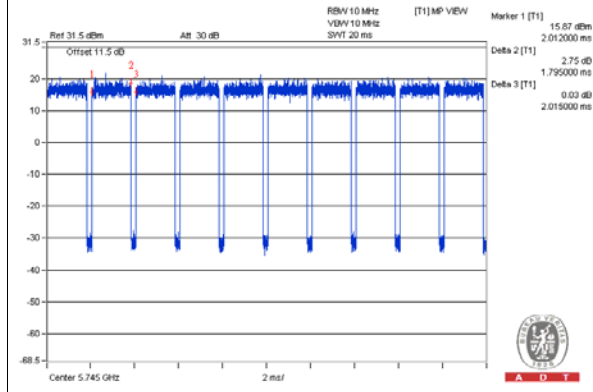

3.4 Description of Support Units

The EUT has been tested as an independent unit together with other necessary accessories or support units. The following support units or accessories were used to form a representative test configuration during the tests.

ID	Product	Brand	Model No.	Serial No.	FCC ID	Remarks
A.	DC Power Supply	Topward	6603D	795558	NA	Provided by Lab
B.	Notebook Computer	Lenovo	7663	NA	NA	Supplied by Client
C.	Test Tool	NA	NA	NA	NA	Supplied by Client

Note:

1. All power cords of the above support units are non-shielded (1.8m).

ID	Descriptions	Qty.	Length (m)	Shielding (Yes/No)	Cores (Qty.)	Remarks
1.	DC cable	1	3	No	0	Provided by Lab
2.	USB cable	1	2	Yes	1	Supplied by Client

Note: The core(s) is(are) originally attached to the cable(s).

3.4.1 Configuration of System under Test

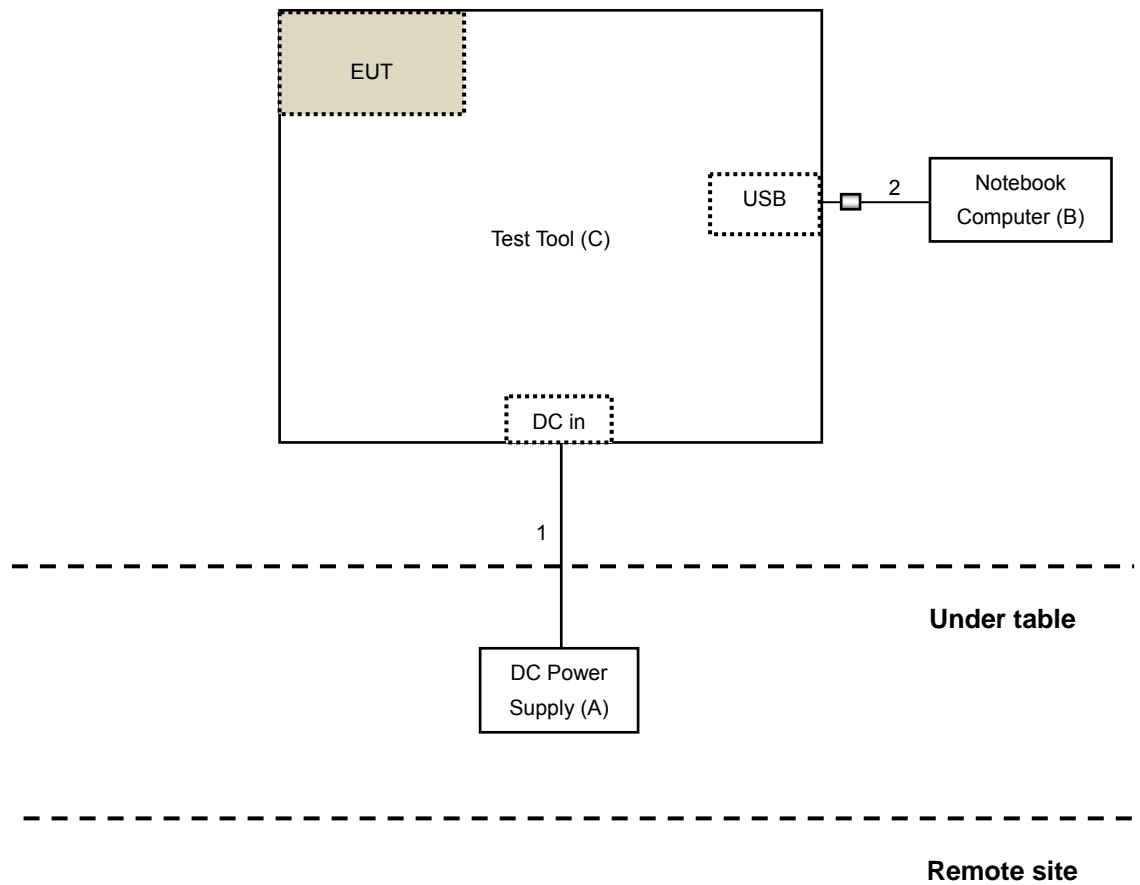

3.5 General Description of Applied Standard

The EUT is a RF Product. According to the specifications of the manufacturer, it must comply with the requirements of the following standards:

FCC Part 15, Subpart E (15.407)

KDB 789033 D02 General UNII Test Procedure New Rules v01r01

ANSI C63.10-2013

All test items have been performed and recorded as per the above standards.

NOTE: The EUT has been verified to comply with the requirements of FCC Part 15, Subpart B, Class B (DoC). The test report has been issued separately.

4 Test Types and Results

4.1 Radiated Emission and Bandedge Measurement

4.1.1 Limits of Radiated Emission and Bandedge Measurement

Radiated emissions which fall in the restricted bands must comply with the radiated emission limits specified as below table.

Frequencies (MHz)	Field Strength (microvolts/meter)	Measurement Distance (meters)
0.009 ~ 0.490	2400/F(kHz)	300
0.490 ~ 1.705	24000/F(kHz)	30
1.705 ~ 30.0	30	30
30 ~ 88	100	3
88 ~ 216	150	3
216 ~ 960	200	3
Above 960	500	3

NOTE:

1. The lower limit shall apply at the transition frequencies.
2. Emission level (dBuV/m) = 20 log Emission level (uV/m).
3. For frequencies above 1000MHz, the field strength limits are based on average detector, however, the peak field strength of any emission shall not exceed the maximum permitted average limits, specified above by more than 20dB under any condition of modulation.

LIMITS OF UNWANTED EMISSION OUT OF THE RESTRICTED BANDS

APPLICABLE TO	LIMIT	
789033 D02 General UNII Test Procedure New Rules v01r01	FIELD STRENGTH AT 3m	
	PK:74 (dBuV/m)	AV:54 (dBuV/m)
APPLICABLE TO	EIRP LIMIT	EQUIVALENT FIELD STRENGTH AT 3m
15.407(b)(1)	PK:-27 (dBm/MHz)	PK:68.2(dBuV/m)
15.407(b)(2)		
15.407(b)(3)		
15.407(b)(4)	PK:-27 (dBm/MHz) ^{*1} PK:-17 (dBm/MHz) ^{*2}	PK: 68.2(dBuV/m) ^{*1} PK:78.2 (dBuV/m) ^{*2}

NOTE: ^{*1} beyond 10MHz of the band edge ^{*2} within 10 MHz of band edge

The following formula is used to convert the equipment isotropic radiated power (eirp) to field strength:

$$E = \frac{1000000\sqrt{30P}}{3} \mu\text{V/m, where P is the eirp (Watts).}$$



4.1.2 Test Instruments

DESCRIPTION & MANUFACTURER	MODEL NO.	SERIAL NO.	CALIBRATED DATE	CALIBRATED UNTIL
Test Receiver Agilent	N9038A	MY51210105	July 24, 2015	July 23, 2016
Pre-Amplifier ^(*) EMCI	EMC001340	980142	Jan. 20, 2016	Jan. 19, 2018
Loop Antenna ^(*) Electro-Metrics	EM-6879	264	Dec. 16, 2014	Dec. 15, 2016
RF Cable	NA	LOOPCAB-001 LOOPCAB-002	Jan. 18, 2016	Jan. 17, 2017
Pre-Amplifier Mini-Circuits	ZFL-1000VH2B	AMP-ZFL-03	Nov. 11, 2015	Nov. 10, 2016
Trilog Broadband Antenna SCHWARZBECK	VULB 9168	9168-360	Jan. 04, 2016	Jan. 03, 2017
RF Cable	8D-FB	CHGCAB-001-1 CHGCAB-001-2	Oct. 03, 2015	Oct. 02, 2016
	RF-141	CHGCAB-004	Oct. 03, 2015	Oct. 02, 2016
Horn_Antenna AIS!	AIH.8018	0000320091110	Jan. 19, 2016	Jan. 18, 2017
Pre-Amplifier Agilent	8449B	3008A02578	June 23, 2015	June 22, 2016
RF Cable	NA	131205 131216 131217 SNMY23684/4	Jan. 15, 2016	Jan. 14, 2017
Boresight Antenna Fixture	NA	NA	NA	NA
Spectrum Analyzer Agilent	E4446A	MY48250254	Nov. 25, 2015	Nov. 24, 2016
Pre-Amplifier SPACEK LABS	SLKKa-48-6	9K16	Dec. 11, 2015	Dec. 10, 2016
Horn_Antenna SCHWARZBECK	BBHA 9170	9170-424	Jan. 18, 2016	Jan. 17, 2017
RF Cable	SUCOFLEX 102	36442/2 36434/2	Dec. 10, 2015	Dec.09, 2016
Software	ADT_Radiated_V8.7.07	NA	NA	NA
Antenna Tower & Turn Table CT	NA	NA	NA	NA
SPECTRUM ANALYZER R&S	FSP 40	100060	May 08, 2015	May 07, 2016
Power meter Anritsu	ML2495A	1014008	Apr. 28, 2015	Apr. 27, 2016
Power sensor Anritsu	MA2411B	0917122	Apr. 28, 2015	Apr. 27, 2016
Temperature & Humidity Chamber GIANTFORCE	GTH-150-40-SP-AR	MAA0812-008	Jan. 15, 2016	Jan. 14, 2017

Note:

1. The calibration interval of the above test instruments is 12 months and the calibrations are traceable to NML/ROC and NIST/USA.
2. *The calibration interval of the above test instruments is 24 months and the calibrations are traceable to NML/ROC and NIST/USA.
3. Loop antenna was used for all emissions below 30 MHz.
4. The test was performed in 966 Chamber No. G.
5. The FCC Site Registration No. is 966073.
6. The VCCI Site Registration No. is G-137.
7. The CANADA Site Registration No. is IC 7450H-2.
8. Tested Date: Apr. 07, 2016

4.1.3 Test Procedure

- a. The EUT was placed on the top of a rotating table 0.8 meters (for below 1GHz) / 1.5 meters (for above 1GHz) above the ground at 3 meter chamber room for test. The table was rotated 360 degrees to determine the position of the highest radiation.
- b. The EUT was set 3 meters away from the interference-receiving antenna, which was mounted on the top of a variable-height antenna tower.
- c. The height of antenna is varied from one meter to four meters above the ground to determine the maximum value of the field strength. Both horizontal and vertical polarizations of the antenna are set to make the measurement.
- d. For each suspected emission, the EUT was arranged to its worst case and then the antenna was tuned to heights from 1 meter to 4 meters and the rotatable table was turned from 0 degrees to 360 degrees to find the maximum reading.
- e. The test-receiver system was set to quasi-peak detect function and specified bandwidth with maximum hold mode when the test frequency is below 1 GHz.
- f. The test-receiver system was set to peak and average detect function and specified bandwidth with maximum hold mode when the test frequency is above 1 GHz. If the peak reading value also meets average limit, measurement with the average detector is unnecessary.

Note:

1. The resolution bandwidth and video bandwidth of test receiver/spectrum analyzer is 120kHz for Quasi-peak detection (QP) at frequency below 1GHz.
2. The resolution bandwidth of test receiver/spectrum analyzer is 1 MHz and the video bandwidth is 3 MHz for Peak detection (PK) at frequency above 1GHz.
3. The resolution bandwidth of test receiver/spectrum analyzer is 1MHz and the video bandwidth is 3MHz for RMS Average (Duty cycle < 98%) for Average detection (AV) at frequency above 1GHz, then the measurement results was added to a correction factor ($10 \log(1/\text{duty cycle})$).
4. The resolution bandwidth of test receiver/spectrum analyzer is 1MHz and the video bandwidth is 10Hz (Duty cycle $\geq 98\%$) for Average detection (AV) at frequency above 1GHz.
5. All modes of operation were investigated and the worst-case emissions are reported.

4.1.4 Deviation from Test Standard

No deviation.

4.1.5 Test Setup

<Frequency Range below 1GHz>

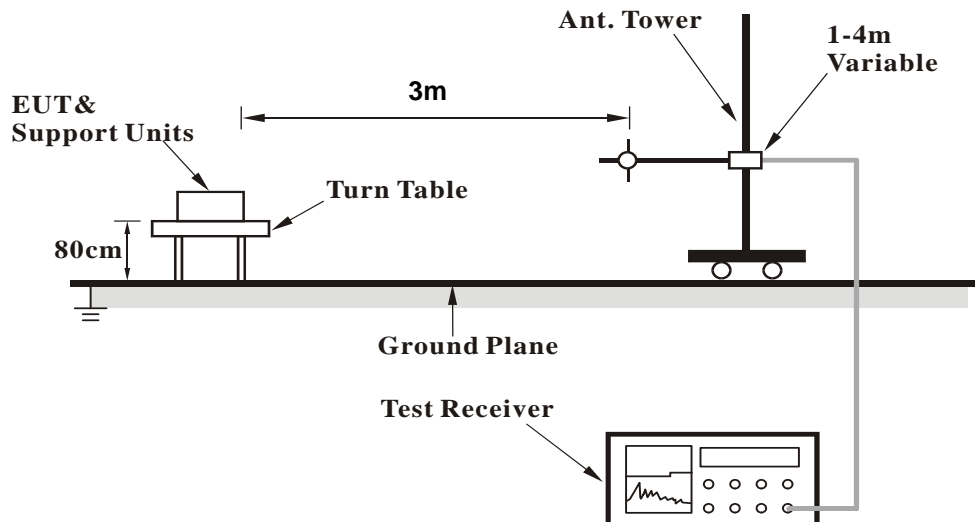

<Frequency Range above 1GHz>

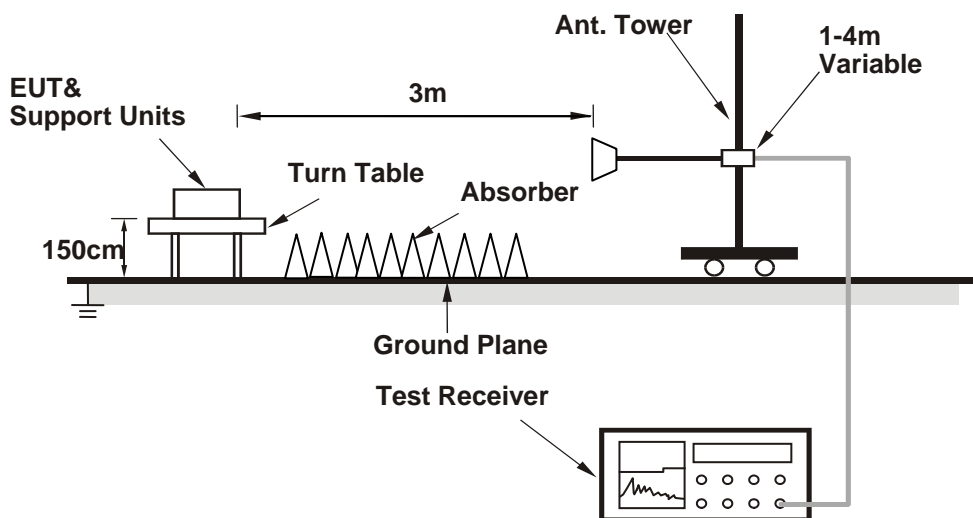

For the actual test configuration, please refer to the attached file (Test Setup Photo).

4.1.6 EUT Operating Condition

1. Connect the EUT with the support unit 1 (Notebook Computer) which is placed on a testing table.
2. The communication partner run test program "Real Time Tuning T00L.EXE V2.0.0.17" to enable EUT under transmission/receiving condition continuously at specific channel frequency.

4.1.7 Test Results

Above 1GHz Data:

802.11a

CHANNEL	TX Channel 149	DETECTOR FUNCTION	Peak (PK)
FREQUENCY RANGE	1GHz ~ 40GHz		Average (AV)

ANTENNA POLARITY & TEST DISTANCE: HORIZONTAL AT 3 M

NO.	FREQ. (MHz)	EMISSION LEVEL (dBuV/m)	LIMIT (dBuV/m)	MARGIN (dB)	ANTENNA HEIGHT (m)	TABLE ANGLE (Degree)	RAW VALUE (dBuV)	CORRECTION FACTOR (dB/m)
1	#5715.00	56.3 PK	74.0	-17.7	2.19 H	323	44.83	11.47
2	#5715.00	43.5 AV	54.0	-10.5	2.19 H	323	32.03	11.47
3	#5725.00	66.3 PK	78.2	-11.9	2.19 H	323	54.79	11.51
4	*5745.00	102.5 PK			2.19 H	323	90.89	11.61
5	*5745.00	90.7 AV			2.19 H	323	79.09	11.61
6	11490.00	58.6 PK	74.0	-15.4	1.40 H	218	40.68	17.92
7	11490.00	46.4 AV	54.0	-7.6	1.40 H	218	28.48	17.92
8	#17235.00	60.5 PK	74.0	-13.5	1.42 H	211	33.29	27.21
9	#17235.00	48.1 AV	54.0	-5.9	1.42 H	211	20.89	27.21

ANTENNA POLARITY & TEST DISTANCE: VERTICAL AT 3 M

NO.	FREQ. (MHz)	EMISSION LEVEL (dBuV/m)	LIMIT (dBuV/m)	MARGIN (dB)	ANTENNA HEIGHT (m)	TABLE ANGLE (Degree)	RAW VALUE (dBuV)	CORRECTION FACTOR (dB/m)
1	#5715.00	67.2 PK	74.0	-6.8	2.06 V	101	55.73	11.47
2	#5715.00	47.1 AV	54.0	-6.9	2.06 V	101	35.63	11.47
3	#5725.00	76.1 PK	78.2	-2.1	2.06 V	101	64.59	11.51
4	*5745.00	112.4 PK			2.06 V	101	100.79	11.61
5	*5745.00	99.4 AV			2.06 V	101	87.79	11.61
6	11490.00	58.8 PK	74.0	-15.2	1.60 V	112	40.88	17.92
7	11490.00	46.5 AV	54.0	-7.5	1.60 V	112	28.58	17.92
8	#17235.00	60.6 PK	74.0	-13.4	1.50 V	125	33.39	27.21
9	#17235.00	48.2 AV	54.0	-5.8	1.50 V	125	20.99	27.21

REMARKS:

1. Emission Level(dBuV/m) = Raw Value(dBuV) + Correction Factor(dB/m)
2. Correction Factor(dB/m) = Antenna Factor(dB/m) + Cable Factor(dB) – Pre-Amplifier Factor(dB)
3. The other emission levels were very low against the limit.
4. Margin value = Emission Level – Limit value
5. " * ": Fundamental frequency.
6. " # ": The radiated frequency is out of the restricted band.



CHANNEL	TX Channel 157	DETECTOR FUNCTION	Peak (PK)
FREQUENCY RANGE	1GHz ~ 40GHz		Average (AV)

ANTENNA POLARITY & TEST DISTANCE: HORIZONTAL AT 3 M

NO.	FREQ. (MHz)	EMISSION LEVEL (dBuV/m)	LIMIT (dBuV/m)	MARGIN (dB)	ANTENNA HEIGHT (m)	TABLE ANGLE (Degree)	RAW VALUE (dBuV)	CORRECTION FACTOR (dB/m)
1	#5715.00	61.3 PK	74.0	-12.7	2.18 H	312	49.83	11.47
2	#5715.00	48.6 AV	54.0	-5.4	2.18 H	312	37.13	11.47
3	#5725.00	61.7 PK	78.2	-16.5	2.18 H	312	50.19	11.51
4	*5785.00	108.7 PK			2.18 H	312	96.89	11.81
5	*5785.00	96.5 AV			2.18 H	312	84.69	11.81
6	#5850.00	60.1 PK	78.2	-18.1	2.18 H	312	48.07	12.03
7	#5860.00	58.6 PK	74.0	-15.4	2.18 H	312	46.55	12.05
8	#5860.00	46.9 AV	54.0	-7.1	2.18 H	312	34.85	12.05
9	11570.00	58.8 PK	74.0	-15.2	1.41 H	207	40.76	18.04
10	11570.00	46.6 AV	54.0	-7.4	1.41 H	207	28.56	18.04
11	#17355.00	60.9 PK	74.0	-13.1	1.38 H	196	33.57	27.33
12	#17355.00	48.3 AV	54.0	-5.7	1.38 H	196	20.97	27.33

ANTENNA POLARITY & TEST DISTANCE: VERTICAL AT 3 M

NO.	FREQ. (MHz)	EMISSION LEVEL (dBuV/m)	LIMIT (dBuV/m)	MARGIN (dB)	ANTENNA HEIGHT (m)	TABLE ANGLE (Degree)	RAW VALUE (dBuV)	CORRECTION FACTOR (dB/m)
1	#5715.00	69.7 PK	74.0	-4.3	2.12 V	101	58.23	11.47
2	#5715.00	52.0 AV	54.0	-2.0	2.12 V	101	40.53	11.47
3	#5725.00	71.6 PK	78.2	-6.6	2.12 V	101	60.09	11.51
4	*5785.00	118.6 PK			2.12 V	101	106.79	11.81
5	*5785.00	105.2 AV			2.12 V	101	93.39	11.81
6	#5850.00	65.3 PK	78.2	-12.9	2.12 V	101	53.27	12.03
7	#5860.00	63.8 PK	74.0	-10.2	2.12 V	101	51.75	12.05
8	#5860.00	50.6 AV	54.0	-3.4	2.12 V	101	38.55	12.05
9	11570.00	58.2 PK	74.0	-15.8	1.62 V	126	40.16	18.04
10	11570.00	46.1 AV	54.0	-7.9	1.62 V	126	28.06	18.04
11	#17355.00	61.1 PK	74.0	-12.9	1.52 V	135	33.77	27.33
12	#17355.00	48.4 AV	54.0	-5.6	1.52 V	135	21.07	27.33

REMARKS:

1. Emission Level(dBuV/m) = Raw Value(dBuV) + Correction Factor(dB/m)
2. Correction Factor(dB/m) = Antenna Factor(dB/m) + Cable Factor(dB) – Pre-Amplifier Factor(dB)
3. The other emission levels were very low against the limit.
4. Margin value = Emission Level – Limit value
5. " * ": Fundamental frequency.
6. " # ": The radiated frequency is out of the restricted band.

CHANNEL	TX Channel 165	DETECTOR FUNCTION	Peak (PK)
FREQUENCY RANGE	1GHz ~ 40GHz		Average (AV)

ANTENNA POLARITY & TEST DISTANCE: HORIZONTAL AT 3 M

NO.	FREQ. (MHz)	EMISSION LEVEL (dBuV/m)	LIMIT (dBuV/m)	MARGIN (dB)	ANTENNA HEIGHT (m)	TABLE ANGLE (Degree)	RAW VALUE (dBuV)	CORRECTION FACTOR (dB/m)
1	*5825.00	105.3 PK			2.22 H	319	93.33	11.97
2	*5825.00	93.9 AV			2.22 H	319	81.93	11.97
3	#5850.00	66.7 PK	78.2	-11.5	2.22 H	319	54.67	12.03
4	#5860.00	61.2 PK	74.0	-12.8	2.22 H	319	49.15	12.05
5	#5860.00	47.6 AV	54.0	-6.4	2.22 H	319	35.55	12.05
6	11650.00	57.9 PK	74.0	-16.1	1.41 H	230	39.95	17.95
7	11650.00	45.9 AV	54.0	-8.1	1.41 H	230	27.95	17.95
8	#17475.00	61.2 PK	74.0	-12.8	1.39 H	219	33.44	27.76
9	#17475.00	48.5 AV	54.0	-5.5	1.39 H	219	20.74	27.76

ANTENNA POLARITY & TEST DISTANCE: VERTICAL AT 3 M

NO.	FREQ. (MHz)	EMISSION LEVEL (dBuV/m)	LIMIT (dBuV/m)	MARGIN (dB)	ANTENNA HEIGHT (m)	TABLE ANGLE (Degree)	RAW VALUE (dBuV)	CORRECTION FACTOR (dB/m)
1	*5825.00	115.2 PK			2.19 V	100	103.23	11.97
2	*5825.00	102.6 AV			2.19 V	100	90.63	11.97
3	#5850.00	76.6 PK	78.2	-1.6	2.19 V	100	64.57	12.03
4	#5860.00	70.4 PK	74.0	-3.6	2.19 V	100	58.35	12.05
5	#5860.00	51.8 AV	54.0	-2.2	2.19 V	100	39.75	12.05
6	11650.00	58.8 PK	74.0	-15.2	1.58 V	116	40.85	17.95
7	11650.00	46.6 AV	54.0	-7.4	1.58 V	116	28.65	17.95
8	#17475.00	62.0 PK	74.0	-12.0	1.45 V	132	34.24	27.76
9	#17475.00	48.7 AV	54.0	-5.3	1.45 V	132	20.94	27.76

REMARKS:

1. Emission Level(dBuV/m) = Raw Value(dBuV) + Correction Factor(dB/m)
2. Correction Factor(dB/m) = Antenna Factor(dB/m) + Cable Factor(dB) – Pre-Amplifier Factor(dB)
3. The other emission levels were very low against the limit.
4. Margin value = Emission Level – Limit value
5. " * ": Fundamental frequency.
6. " # ": The radiated frequency is out of the restricted band.

802.11n (HT20)

CHANNEL	TX Channel 149	DETECTOR FUNCTION	Peak (PK)
FREQUENCY RANGE	1GHz ~ 40GHz		Average (AV)

ANTENNA POLARITY & TEST DISTANCE: HORIZONTAL AT 3 M								
NO.	FREQ. (MHz)	EMISSION LEVEL (dBuV/m)	LIMIT (dBuV/m)	MARGIN (dB)	ANTENNA HEIGHT (m)	TABLE ANGLE (Degree)	RAW VALUE (dBuV)	CORRECTION FACTOR (dB/m)
1	#5715.00	56.6 PK	74.0	-17.4	2.22 H	309	45.13	11.47
2	#5715.00	43.7 AV	54.0	-10.3	2.22 H	309	32.23	11.47
3	#5725.00	66.7 PK	78.2	-11.5	2.22 H	309	55.19	11.51
4	*5745.00	102.5 PK			2.22 H	309	90.89	11.61
5	*5745.00	90.1 AV			2.22 H	309	78.49	11.61
6	11490.00	58.2 PK	74.0	-15.8	1.41 H	214	40.28	17.92
7	11490.00	46.0 AV	54.0	-8.0	1.41 H	214	28.08	17.92
8	#17235.00	60.8 PK	74.0	-13.2	1.40 H	196	33.59	27.21
9	#17235.00	48.2 AV	54.0	-5.8	1.40 H	196	20.99	27.21

ANTENNA POLARITY & TEST DISTANCE: VERTICAL AT 3 M								
NO.	FREQ. (MHz)	EMISSION LEVEL (dBuV/m)	LIMIT (dBuV/m)	MARGIN (dB)	ANTENNA HEIGHT (m)	TABLE ANGLE (Degree)	RAW VALUE (dBuV)	CORRECTION FACTOR (dB/m)
1	#5715.00	67.5 PK	74.0	-6.5	2.18 V	104	56.03	11.47
2	#5715.00	47.4 AV	54.0	-6.6	2.18 V	104	35.93	11.47
3	#5725.00	76.5 PK	78.2	-1.7	2.18 V	104	64.99	11.51
4	*5745.00	112.4 PK			2.18 V	104	100.79	11.61
5	*5745.00	98.8 AV			2.18 V	104	87.19	11.61
6	11490.00	58.7 PK	74.0	-15.3	1.57 V	116	40.78	17.92
7	11490.00	46.4 AV	54.0	-7.6	1.57 V	116	28.48	17.92
8	#17235.00	61.4 PK	74.0	-12.6	1.45 V	147	34.19	27.21
9	#17235.00	48.5 AV	54.0	-5.5	1.45 V	147	21.29	27.21

REMARKS:

1. Emission Level(dBuV/m) = Raw Value(dBuV) + Correction Factor(dB/m)
2. Correction Factor(dB/m) = Antenna Factor(dB/m) + Cable Factor(dB) – Pre-Amplifier Factor(dB)
3. The other emission levels were very low against the limit.
4. Margin value = Emission Level – Limit value
5. " * ": Fundamental frequency.
6. " # ": The radiated frequency is out of the restricted band.

CHANNEL	TX Channel 157	DETECTOR FUNCTION	Peak (PK)
FREQUENCY RANGE	1GHz ~ 40GHz		Average (AV)

ANTENNA POLARITY & TEST DISTANCE: HORIZONTAL AT 3 M

NO.	FREQ. (MHz)	EMISSION LEVEL (dBuV/m)	LIMIT (dBuV/m)	MARGIN (dB)	ANTENNA HEIGHT (m)	TABLE ANGLE (Degree)	RAW VALUE (dBuV)	CORRECTION FACTOR (dB/m)
1	#5715.00	61.8 PK	74.0	-12.2	2.15 H	314	50.33	11.47
2	#5715.00	48.2 AV	54.0	-5.8	2.15 H	314	36.73	11.47
3	#5725.00	62.8 PK	78.2	-15.4	2.15 H	314	51.29	11.51
4	*5785.00	107.9 PK			2.15 H	314	96.09	11.81
5	*5785.00	96.1 AV			2.15 H	314	84.29	11.81
6	#5850.00	60.9 PK	78.2	-17.3	2.15 H	314	48.87	12.03
7	#5860.00	58.5 PK	74.0	-15.5	2.15 H	314	46.45	12.05
8	#5860.00	46.1 AV	54.0	-7.9	2.15 H	314	34.05	12.05
9	11570.00	58.5 PK	74.0	-15.5	1.38 H	232	40.46	18.04
10	11570.00	46.2 AV	54.0	-7.8	1.38 H	232	28.16	18.04
11	#17355.00	60.8 PK	74.0	-13.2	1.36 H	203	33.47	27.33
12	#17355.00	48.2 AV	54.0	-5.8	1.36 H	203	20.87	27.33

ANTENNA POLARITY & TEST DISTANCE: VERTICAL AT 3 M

NO.	FREQ. (MHz)	EMISSION LEVEL (dBuV/m)	LIMIT (dBuV/m)	MARGIN (dB)	ANTENNA HEIGHT (m)	TABLE ANGLE (Degree)	RAW VALUE (dBuV)	CORRECTION FACTOR (dB/m)
1	#5715.00	70.8 PK	74.0	-3.2	2.12 V	102	59.33	11.47
2	#5715.00	51.3 AV	54.0	-2.7	2.12 V	102	39.83	11.47
3	#5725.00	72.5 PK	78.2	-5.7	2.12 V	102	60.99	11.51
4	*5785.00	117.8 PK			2.12 V	102	105.99	11.81
5	*5785.00	104.8 AV			2.12 V	102	92.99	11.81
6	#5850.00	67.0 PK	78.2	-11.2	2.12 V	102	54.97	12.03
7	#5860.00	63.6 PK	74.0	-10.4	2.12 V	102	51.55	12.05
8	#5860.00	48.6 AV	54.0	-5.4	2.12 V	102	36.55	12.05
9	11570.00	58.4 PK	74.0	-15.6	1.62 V	111	40.36	18.04
10	11570.00	46.0 AV	54.0	-8.0	1.62 V	111	27.96	18.04
11	#17355.00	61.2 PK	74.0	-12.8	1.50 V	133	33.87	27.33
12	#17355.00	48.2 AV	54.0	-5.8	1.50 V	133	20.87	27.33

REMARKS:

1. Emission Level(dBuV/m) = Raw Value(dBuV) + Correction Factor(dB/m)
2. Correction Factor(dB/m) = Antenna Factor(dB/m) + Cable Factor(dB) – Pre-Amplifier Factor(dB)
3. The other emission levels were very low against the limit.
4. Margin value = Emission Level – Limit value
5. " * ": Fundamental frequency.
6. " # ": The radiated frequency is out of the restricted band.

CHANNEL	TX Channel 165	DETECTOR FUNCTION	Peak (PK)
FREQUENCY RANGE	1GHz ~ 40GHz		Average (AV)

ANTENNA POLARITY & TEST DISTANCE: HORIZONTAL AT 3 M

NO.	FREQ. (MHz)	EMISSION LEVEL (dBuV/m)	LIMIT (dBuV/m)	MARGIN (dB)	ANTENNA HEIGHT (m)	TABLE ANGLE (Degree)	RAW VALUE (dBuV)	CORRECTION FACTOR (dB/m)
1	*5825.00	104.7 PK			2.16 H	312	92.73	11.97
2	*5825.00	93.2 AV			2.16 H	312	81.23	11.97
3	#5850.00	66.5 PK	78.2	-11.7	2.16 H	312	54.47	12.03
4	#5860.00	60.6 PK	74.0	-13.4	2.16 H	312	48.55	12.05
5	#5860.00	47.2 AV	54.0	-6.8	2.16 H	312	35.15	12.05
6	11650.00	58.9 PK	74.0	-15.1	1.45 H	220	40.95	17.95
7	11650.00	46.5 AV	54.0	-7.5	1.45 H	220	28.55	17.95
8	#17475.00	61.0 PK	74.0	-13.0	1.41 H	203	33.24	27.76
9	#17475.00	48.4 AV	54.0	-5.6	1.41 H	203	20.64	27.76

ANTENNA POLARITY & TEST DISTANCE: VERTICAL AT 3 M

NO.	FREQ. (MHz)	EMISSION LEVEL (dBuV/m)	LIMIT (dBuV/m)	MARGIN (dB)	ANTENNA HEIGHT (m)	TABLE ANGLE (Degree)	RAW VALUE (dBuV)	CORRECTION FACTOR (dB/m)
1	*5825.00	114.6 PK			2.19 V	105	102.63	11.97
2	*5825.00	101.8 AV			2.19 V	105	89.83	11.97
3	#5850.00	76.3 PK	78.2	-1.9	2.19 V	105	64.27	12.03
4	#5860.00	68.1 PK	74.0	-5.9	2.19 V	105	56.05	12.05
5	#5860.00	51.2 AV	54.0	-2.8	2.19 V	105	39.15	12.05
6	11650.00	58.7 PK	74.0	-15.3	1.64 V	108	40.75	17.95
7	11650.00	46.2 AV	54.0	-7.8	1.64 V	108	28.25	17.95
8	#17475.00	61.8 PK	74.0	-12.2	1.54 V	124	34.04	27.76
9	#17475.00	48.6 AV	54.0	-5.4	1.54 V	124	20.84	27.76

REMARKS:

1. Emission Level(dBuV/m) = Raw Value(dBuV) + Correction Factor(dB/m)
2. Correction Factor(dB/m) = Antenna Factor(dB/m) + Cable Factor(dB) – Pre-Amplifier Factor(dB)
3. The other emission levels were very low against the limit.
4. Margin value = Emission Level – Limit value
5. " * ": Fundamental frequency.
6. " # ": The radiated frequency is out of the restricted band.

Below 1GHz Data:
802.11a

CHANNEL	TX Channel 157	DETECTOR FUNCTION	Quasi-Peak (QP)
FREQUENCY RANGE	30MHz ~ 1GHz		

ANTENNA POLARITY & TEST DISTANCE: HORIZONTAL AT 3 M

NO.	FREQ. (MHz)	EMISSION LEVEL (dBuV/m)	LIMIT (dBuV/m)	MARGIN (dB)	ANTENNA HEIGHT (m)	TABLE ANGLE (Degree)	RAW VALUE (dBuV)	CORRECTION FACTOR (dB/m)
1	72.00	26.9 QP	40.0	-13.1	2.50 H	96	37.64	-10.73
2	119.97	29.0 QP	43.5	-14.5	1.00 H	360	38.89	-9.93
3	255.36	30.9 QP	46.0	-15.1	1.00 H	60	39.43	-8.54
4	480.01	31.8 QP	46.0	-14.3	1.50 H	106	33.60	-1.85
5	597.57	36.6 QP	46.0	-9.4	1.50 H	330	35.76	0.86
6	911.56	35.7 QP	46.0	-10.3	2.50 H	360	29.36	6.32

ANTENNA POLARITY & TEST DISTANCE: VERTICAL AT 3 M

NO.	FREQ. (MHz)	EMISSION LEVEL (dBuV/m)	LIMIT (dBuV/m)	MARGIN (dB)	ANTENNA HEIGHT (m)	TABLE ANGLE (Degree)	RAW VALUE (dBuV)	CORRECTION FACTOR (dB/m)
1	48.79	34.0 QP	40.0	-6.0	1.00 V	360	42.23	-8.25
2	69.16	35.5 QP	40.0	-4.5	1.00 V	350	45.55	-10.03
3	123.39	29.9 QP	43.5	-13.6	1.00 V	25	39.49	-9.62
4	599.41	34.6 QP	46.0	-11.4	1.50 V	80	33.65	0.93
5	666.10	31.5 QP	46.0	-14.5	1.00 V	186	29.58	1.91
6	700.00	32.5 QP	46.0	-13.5	1.00 V	202	30.10	2.40

REMARKS:

1. Emission Level(dBuV/m) = Raw Value(dBuV) + Correction Factor(dB/m)
2. Correction Factor(dB/m) = Antenna Factor(dB/m) + Cable Factor(dB) – Pre-Amplifier Factor(dB)
3. The other emission levels were very low against the limit.
4. Margin value = Emission Level – Limit value

4.2 Transmit Power Measurement

4.2.1 Limits of Transmit Power Measurement

Operation Band	EUT Category		LIMIT
U-NII-1		Outdoor Access Point	1 Watt (30 dBm) (Max. e.i.r.p \leq 125mW(21 dBm) at any elevation angle above 30 degrees as measured from the horizon)
		Fixed point-to-point Access Point	1 Watt (30 dBm)
		Indoor Access Point	1 Watt (30 dBm)
		Mobile and Portable client device	250mW (24 dBm)
U-NII-2A			250mW (24 dBm) or 11 dBm+10 log B*
U-NII-2C			250mW (24 dBm) or 11 dBm+10 log B*
U-NII-3	√		1 Watt (30 dBm)

*B is the 26 dB emission bandwidth in megahertz

4.2.2 Test Setup

FOR POWER OUTPUT MEASUREMENT

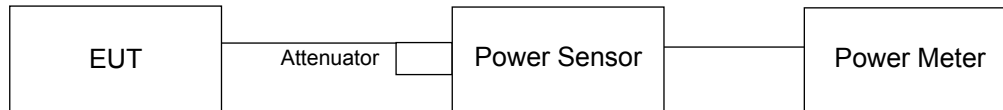

4.2.3 Test Instruments

Refer to section 4.1.2 to get information of above instrument.

4.2.4 Test Procedure

FOR POWER OUTPUT MEASUREMENT

Method PM is used to perform output power measurement, trigger and gating function of wide band power meter is enabled to measure max output power of TX on burst. Duty factor is not added to measured value.

4.2.5 Deviation from Test Standard

No deviation.

4.2.6 EUT Operating Condition

The software provided by client to enable the EUT under transmission condition continuously at lowest, middle and highest channel frequencies individually.

4.2.7 Test Result

Average Power Output:

802.11a

Chan.	Chan. Freq. (MHz)	Average Power (mW)	Average Power (dBm)	Limit (dBm)	Pass / Fail
149	5745	20.23	13.06	30	Pass
157	5785	72.277	18.59	30	Pass
165	5825	44.875	16.52	30	Pass

802.11n (HT20)

Chan.	Chan. Freq. (MHz)	Average Power (mW)	Average Power (dBm)	Limit (dBm)	Pass / Fail
149	5745	19.999	13.01	30	Pass
157	5785	73.961	18.69	30	Pass
165	5825	40.458	16.07	30	Pass

Peak Power Output (For reference):

802.11a

Chan.	Chan. Freq. (MHz)	Maximum Peak Power (mW)	Maximum Peak Power (dBm)
149	5745	107.647	20.32
157	5785	130.017	21.14
165	5825	127.057	21.04

802.11a

Chan.	Chan. Freq. (MHz)	Maximum Peak Power (mW)	Maximum Peak Power (dBm)
149	5745	105.682	20.24
157	5785	127.644	21.06
165	5825	122.18	20.87

※Add test for each data rate output power (require by manufacturer):

802.11a

Channel	Frequency (MHz)	Average power (dbm)							
		Data rate							
		6Mbps	9Mbps	12Mbps	18Mbps	24Mbps	36Mbps	48Mbps	54Mbps
149	5745	13.06	13.03	12.81	12.80	12.98	12.77	12.82	12.82
157	5785	18.59	18.43	18.22	18.31	18.41	18.56	18.47	18.31
165	5825	16.52	16.40	16.49	16.49	16.49	16.35	16.32	16.5

802.11n (HT20)

Channel	Frequency (MHz)	Average power (dbm)							
		Data rate							
		MCS0	MCS1	MCS2	MCS3	MCS4	MCS5	MCS6	MCS7
149	5745	13.01	12.86	12.70	12.89	12.87	12.95	12.83	12.98
157	5785	18.69	18.66	18.57	18.59	18.5	18.48	18.65	18.6
165	5825	16.07	15.96	16.02	15.97	15.82	15.87	15.99	15.77

4.3 Peak Power Spectral Density Measurement

4.3.1 Limits of Peak Power Spectral Density Measurement

Operation Band	EUT Category		LIMIT
U-NII-1		Outdoor Access Point	17dBm/ MHz
		Fixed point-to-point Access Point	
		Indoor Access Point	
		Mobile and Portable client device	11dBm/ MHz
U-NII-2A			11dBm/ MHz
U-NII-2C			11dBm/ MHz
U-NII-3	√		30dBm/ 500kHz

4.3.2 Test Setup

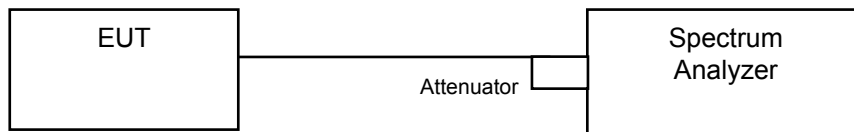

4.3.3 Test Instruments

Refer to section 4.1.2 to get information of above instrument.

4.3.4 Test Procedure

1. Set span to encompass the entire emission bandwidth (EBW) of the signal.
2. Set RBW = 300 kHz, Set VBW ≥ 1 MHz, Detector = RMS
3. Use the peak marker function to determine the maximum power level in any 300 kHz band segment within the fundamental EBW.
4. Scale the observed power level to an equivalent value in 500 kHz by adjusting (reducing) the measured power by a bandwidth correction factor (BWCF) where $BWCF = 10\log(500\text{ kHz}/300\text{kHz})$
5. Sweep time = auto, trigger set to "free run".
6. Trace average at least 100 traces in power averaging mode.
7. Record the max value and add $10\log(1/\text{duty cycle})$

4.3.5 Deviation from Test Standard

No deviation.

4.3.6 EUT Operating Condition

Same as Item 4.2.6.

4.3.7 Test Results

802.11a

Chan.	Chan. Freq. (MHz)	PSD W/O Duty Factor		Duty Factor (dB)	Total PSD With Duty Factor (dBm/500kHz)	Limit (dBm/500kHz)	Pass /Fail
		(dBm/300kHz)	(dBm/500kHz)				
149	5745	-7.45	-5.23	0.46	-4.77	30	Pass
157	5785	-5.31	-3.09	0.46	-2.63	30	Pass
165	5825	-4.87	-2.65	0.46	-2.19	30	Pass

Note: 1. Refer to section 3.3 for duty cycle spectrum plot.

802.11n (HT20)

Chan.	Chan. Freq. (MHz)	PSD W/O Duty Factor		Duty Factor (dB)	Total PSD With Duty Factor (dBm/500kHz)	Limit (dBm/500kHz)	Pass /Fail
		(dBm/300kHz)	(dBm/500kHz)				
149	5745	-7.43	-5.21	0.50	-4.71	30	Pass
157	5785	-5.81	-3.59	0.50	-3.09	30	Pass
165	5825	-5.61	-3.39	0.50	-2.89	30	Pass

Note: 1. Refer to section 3.3 for duty cycle spectrum plot.

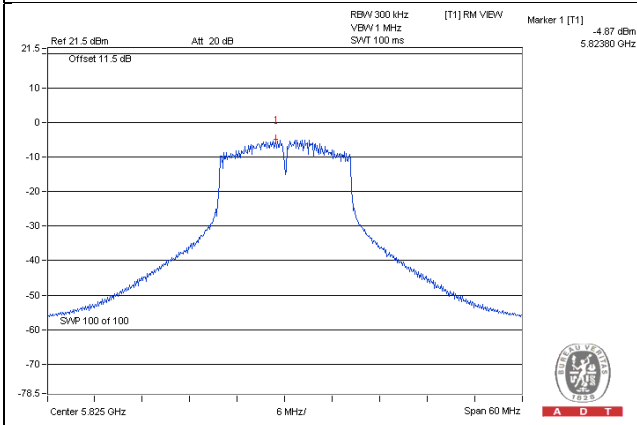
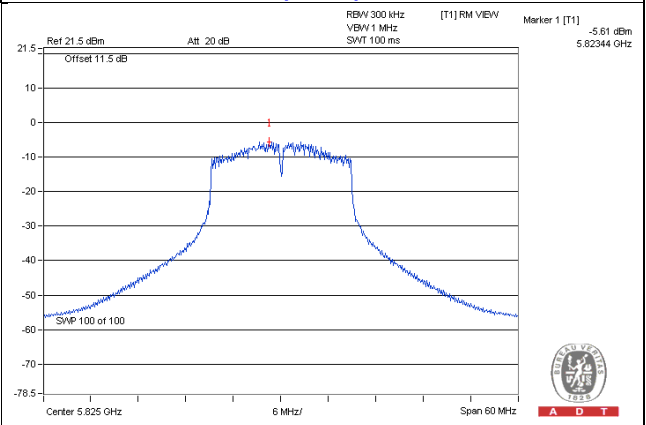
C**802.11a / CH165****802.11n (HT20) / CH165**

4.4 Frequency Stability Measurement

4.4.1 Limits of Frequency Stability Measurement

The frequency of the carrier signal shall be maintained within band of operation

4.4.2 Test Setup

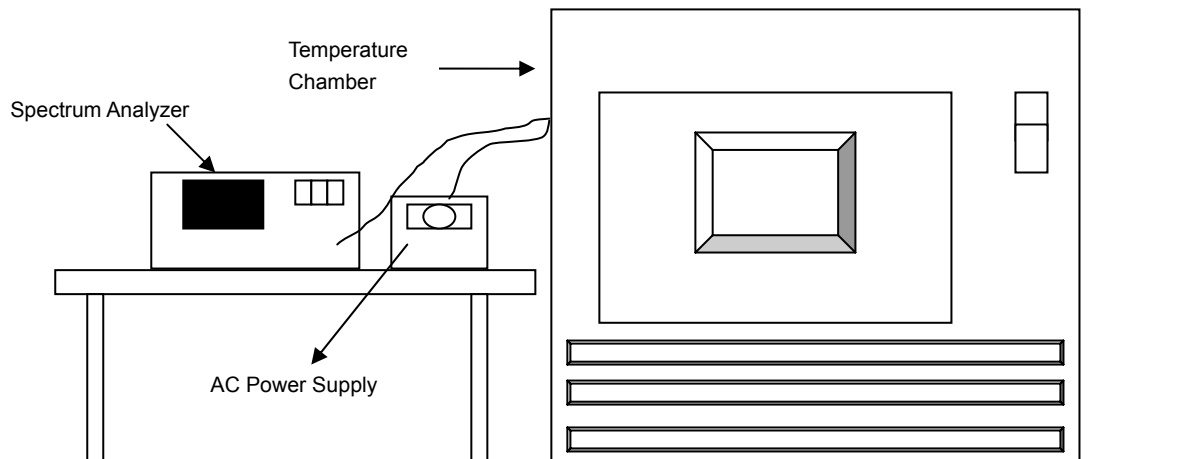

4.4.3 Test Instruments

Refer to section 4.1.2 to get information of above instrument.

4.4.4 Test Procedure

- The EUT was placed inside the environmental test chamber and powered by nominal AC voltage.
- Turn the EUT on and couple its output to a spectrum analyzer.
- Turn the EUT off and set the chamber to the highest temperature specified.
- Allow sufficient time (approximately 30 min) for the temperature of the chamber to stabilize, turn the EUT on and measure the operating frequency after 2, 5, and 10 minutes.
- Repeat step 2 and 3 with the temperature chamber set to the lowest temperature.
- The test chamber was allowed to stabilize at +20 degree C for a minimum of 30 minutes. The supply voltage was then adjusted on the EUT from 85% to 115% and the frequency record.

4.4.5 Deviation from Test Standard

No deviation.

4.4.6 EUT Operating Condition

Set the EUT transmit at un-modulation mode to test frequency stability.

4.4.7 Test Results

FREQUENCY STABILITY VERSUS TEMP.									
OPERATING FREQUENCY: 5745MHz									
TEMP. (°C)	POWER SUPPLY (Vac)	0 MINUTE		2 MINUTE		5 MINUTE		10 MINUTE	
		Measured Frequency (MHz)	Frequency Drift (%)	Measured Frequency (MHz)	Frequency Drift (%)	Measured Frequency (MHz)	Frequency Drift (%)	Measured Frequency (MHz)	Frequency Drift (%)
50	120	5745.0117	0.00020	5745.0109	0.00019	5745.0146	0.00025	5745.0152	0.00026
40	120	5744.9938	-0.00011	5744.996	-0.00007	5744.9961	-0.00007	5744.9925	-0.00013
30	120	5745.0149	0.00026	5745.0156	0.00027	5745.0171	0.00030	5745.0141	0.00025
20	120	5744.9903	-0.00017	5744.9922	-0.00014	5744.9941	-0.00010	5744.9912	-0.00015
10	120	5745.0289	0.00050	5745.0281	0.00049	5745.0293	0.00051	5745.028	0.00049
0	120	5744.9698	-0.00053	5744.9698	-0.00053	5744.9732	-0.00047	5744.97	-0.00052
-10	120	5744.9927	-0.00013	5744.9881	-0.00021	5744.991	-0.00016	5744.9937	-0.00011
-20	120	5744.9712	-0.00050	5744.9744	-0.00045	5744.9705	-0.00051	5744.9732	-0.00047
-30	120	5744.9986	-0.00002	5744.9949	-0.00009	5744.9989	-0.00002	5744.9952	-0.00008

FREQUENCY STABILITY VERSUS VOLTAGE									
OPERATING FREQUENCY: 5745MHz									
TEMP. (°C)	POWER SUPPLY (Vac)	0 MINUTE		2 MINUTE		5 MINUTE		10 MINUTE	
		Measured Frequency (MHz)	Frequency Drift (%)	Measured Frequency (MHz)	Frequency Drift (%)	Measured Frequency (MHz)	Frequency Drift (%)	Measured Frequency (MHz)	Frequency Drift (%)
20	138	5744.9907	-0.00016	5744.9933	-0.00012	5744.9939	-0.00011	5744.9919	-0.00014
	120	5744.9903	-0.00017	5744.9922	-0.00014	5744.9941	-0.00010	5744.9912	-0.00015
	102	5744.9904	-0.00017	5744.9913	-0.00015	5744.9949	-0.00009	5744.9923	-0.00013

4.5 6dB Bandwidth Measurement

4.5.1 Limits of 6dB Bandwidth Measurement

The minimum of 6dB Bandwidth Measurement is 0.5MHz.

4.5.2 Test Setup

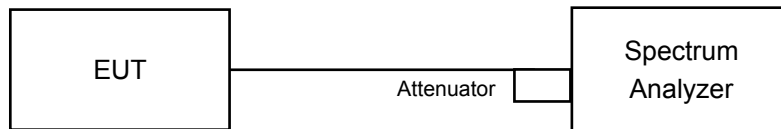

4.5.3 Test Instruments

Refer to section 4.1.2 to get information of above instrument.

4.5.4 Test Procedure

MEASUREMENT PROCEDURE REF

- a. Set resolution bandwidth (RBW) = 100kHz
- b. Set the video bandwidth (VBW) $\geq 3 \times$ RBW, Detector = Peak.
- c. Trace mode = max hold.
- d. Sweep = auto couple.
- e. Measure the maximum width of the emission that is constrained by the frequencies associated with the two amplitude points (upper and lower) that are attenuated by 6 dB relative to the maximum level measured in the fundamental emission

4.5.5 Deviation from Test Standard

No deviation.

4.5.6 EUT Operating Condition

The software provided by client to enable the EUT under transmission condition continuously at lowest, middle and highest channel frequencies individually.

4.5.7 Test Results

802.11a

Channel	Frequency (MHz)	6dB Bandwidth (MHz)	Minimum Limit (MHz)	Pass / Fail
149	5745	15.18	0.5	Pass
157	5785	15.05	0.5	Pass
165	5825	15.14	0.5	Pass

802.11n (HT20)

Channel	Frequency (MHz)	6dB Bandwidth (MHz)	Minimum Limit (MHz)	Pass / Fail
149	5745	15.19	0.5	Pass
157	5785	15.16	0.5	Pass
165	5825	15.17	0.5	Pass

Spectrum Plot of Worst Value

802.11a / CH157

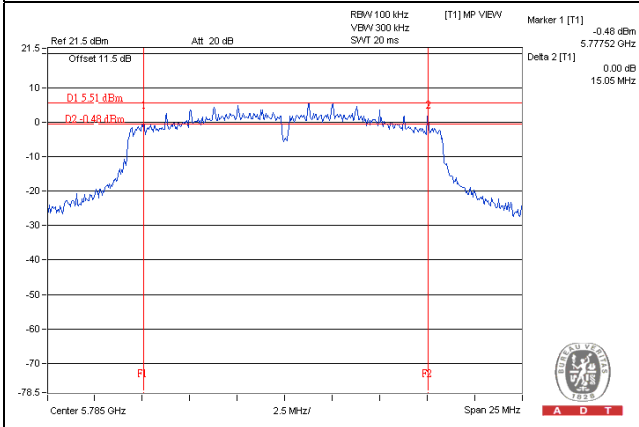

802.11n (HT20) / CH157

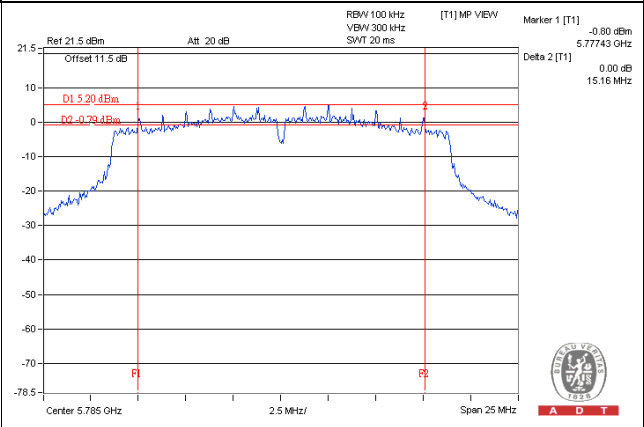

5 Pictures of Test Arrangements

Please refer to the attached file (Test Setup Photo).

Appendix – Information on the Testing Laboratories

We, Bureau Veritas Consumer Products Services (H.K.) Ltd., Taoyuan Branch, were founded in 1988 to provide our best service in EMC, Radio, Telecom and Safety consultation. Our laboratories are accredited and approved according to ISO/IEC 17025.

If you have any comments, please feel free to contact us at the following:

Linko EMC/RF Lab

Tel: 886-2-26052180

Fax: 886-2-26051924

Hsin Chu EMC/RF/Telecom Lab

Tel: 886-3-6668565

Fax: 886-3-6668323

Hwa Ya EMC/RF/Safety Lab

Tel: 886-3-3183232

Fax: 886-3-3270892

Email: service.adt@tw.bureauveritas.com

Web Site: www.bureauveritas-adt.com

The address and road map of all our labs can be found in our web site also.

--- END ---