



# FCC TEST REPORT (15.407)

**REPORT NO.:** RF111028C08-1

**MODEL NO.:** 21-148603-0A

**FCC ID:** UZ7211486030A

**RECEIVED:** Oct. 28, 2011

**TESTED:** Nov. 14 to 30, 2011

**ISSUED:** Mar. 09, 2012

**APPLICANT:** Motorola Solutions, Inc.

**ADDRESS:** 1 Motorola Plaza, Holtsville, NY 11742-1300  
USA

**ISSUED BY:** Bureau Veritas Consumer Products Services (H.K.)  
Ltd., Taoyuan Branch Hsin Chu Laboratory

**LAB ADDRESS:** No. 81-1, Lu Liao Keng, 9th Ling, Wu Lung Tsuen,  
Chiung Lin Hsiang, Hsin Chu Hsien 307, Taiwan

**TEST LOCATION (1):** No. 81-1, Lu Liao Keng, 9th Ling, Wu Lung Tsuen,  
Chiung Lin Hsiang, Hsin Chu Hsien 307, Taiwan

**TEST LOCATION (2):** No. 49, Ln. 206, Wende Rd., Shangshan Tsuen,  
Chiung Lin Hsiang, Hsin Chu Hsien 307, Taiwan

This test report consists of 93 pages in total. It may be duplicated completely for legal use with the approval of the applicant. It should not be reproduced except in full, without the written approval of our laboratory. The client should not use it to claim product certification, approval, or endorsement by TAF or any government agencies. The test results in the report only apply to the tested sample.





A D T

## Table of Contents

RELEASE CONTROL RECORD .....	4
1. CERTIFICATION .....	5
2. SUMMARY OF TEST RESULTS .....	6
2.1 MEASUREMENT UNCERTAINTY .....	7
3. GENERAL INFORMATION .....	8
3.1 GENERAL DESCRIPTION OF EUT .....	8
3.2 DESCRIPTION OF TEST MODES .....	10
3.2.1 TEST MODE APPLICABILITY AND TESTED CHANNEL DETAIL .....	11
3.3 GENERAL DESCRIPTION OF APPLIED STANDARDS .....	14
3.4 DESCRIPTION OF SUPPORT UNITS.....	15
3.5 CONFIGURATION OF SYSTEM UNDER TEST .....	16
4. TEST TYPES AND RESULTS .....	17
4.1 CONDUCTED EMISSION MEASUREMENT .....	17
4.1.1 LIMITS OF CONDUCTED EMISSION MEASUREMENT .....	17
4.1.2 TEST INSTRUMENTS.....	17
4.1.3 TEST PROCEDURES .....	18
4.1.4 DEVIATION FROM TEST STANDARD .....	18
4.1.5 TEST SETUP .....	19
4.1.6 EUT OPERATING CONDITIONS .....	19
4.1.7 TEST RESULTS .....	20
4.2 RADIATED EMISSION MEASUREMENT .....	22
4.2.1 LIMITS OF RADIATED EMISSION MEASUREMENT .....	22
4.2.2 LIMITS OF UNWANTED EMISSION OUT OF THE RESTRICTED BANDS.....	23
4.2.3 TEST INSTRUMENTS.....	24
4.2.4 TEST PROCEDURES .....	26
4.2.5 DEVIATION FROM TEST STANDARD .....	26
4.2.6 TEST SETUP .....	27
4.2.7 EUT OPERATING CONDITION .....	27
4.2.8 TEST RESULTS .....	28
4.3 OUTPUT TRANSMIT POWER MEASUREMENT .....	61
4.3.1 LIMITS OF OUTPUT TRANSMIT POWER MEASUREMENT .....	61
4.3.2 TEST INSTRUMENTS.....	61
4.3.3 TEST PROCEDURE.....	62
4.3.4 DEVIATION FROM TEST STANDARD .....	62
4.3.5 TEST SETUP .....	62
4.3.6 EUT OPERATING CONDITIONS .....	62
4.3.7 TEST RESULTS .....	63
4.4 PEAK POWER EXCURSION MEASUREMENT .....	68
4.4.1 LIMITS OF PEAK POWER EXCURSION MEASUREMENT .....	68
4.4.2 TEST INSTRUMENTS.....	68



A D T

4.4.3	TEST PROCEDURE.....	68
4.4.4	DEVIATION FROM TEST STANDARD.....	68
4.4.5	TEST SETUP .....	69
4.4.6	EUT OPERATING CONDITIONS .....	69
4.4.7	TEST RESULTS .....	70
4.5	PEAK POWER SPECTRAL DENSITY MEASUREMENT .....	74
4.5.1	LIMITS OF PEAK POWER SPECTRAL DENSITY MEASUREMENT .....	74
4.5.2	TEST INSTRUMENTS.....	74
4.5.3	TEST PROCEDURES .....	74
4.5.4	DEVIATION FROM TEST STANDARD.....	74
4.5.5	TEST SETUP .....	74
4.5.6	EUT OPERATING CONDITIONS .....	74
4.5.7	TEST RESULTS .....	75
4.6	FREQUENCY STABILITY.....	79
4.6.1	LIMITS OF FREQUENCY STABILITY MEASUREMENT .....	79
4.6.2	TEST INSTRUMENTS.....	79
4.6.3	TEST PROCEDURE.....	79
4.6.4	DEVIATION FROM TEST STANDARD.....	80
4.6.5	TEST SETUP .....	80
4.6.6	EUT OPERATING CONDITION.....	80
4.6.7	TEST RESULTS .....	81
4.7	CONDUCTED OUT-BAND EMISSION MEASUREMENT.....	82
4.7.1	TEST INSTRUMENTS.....	82
4.7.2	TEST PROCEDURE.....	82
4.7.3	EUT OPERATING CONDITION.....	82
4.7.4	TEST RESULTS .....	82
5.	INFORMATION ON THE TESTING LABORATORIES .....	92
6.	APPENDIX A - MODIFICATIONS RECORDERS FOR ENGINEERING CHANGES TO THE EUT BY THE LAB.....	93



A D T

## RELEASE CONTROL RECORD

ISSUE NO.	REASON FOR CHANGE	DATE ISSUED
RF111028C08-1	Original release	Mar. 09, 2012



A D T

## 1. CERTIFICATION

**PRODUCT:** Radio Module  
**BRAND NAME:** Motorola  
**MODEL NO.:** 21-148603-0A  
**TEST SAMPLE:** ENGINEERING SAMPLE  
**APPLICANT:** Motorola Solutions, Inc.  
**TESTED:** Nov. 14 to 30, 2011  
**STANDARDS:** FCC Part 15, Subpart E (Section 15.407)  
ANSI C63.4-2003  
ANSI C63.10-2009

The above equipment (Model: 21-148603-0A) has been tested by **Bureau Veritas Consumer Products Services (H.K.) Ltd., Taoyuan Branch**, and found compliance with the requirement of the above standards. The test record, data evaluation & Equipment Under Test (EUT) configurations represented herein are true and accurate accounts of the measurements of the sample's EMC characteristics under the conditions specified in this report.

**PREPARED BY** : , **DATE:** Mar. 09, 2012  
( Midoli Peng, Specialist )

**APPROVED BY** : , **DATE:** Mar. 09, 2012  
( May Chen, Deputy Manager )

## 2. SUMMARY OF TEST RESULTS

The EUT has been tested according to the following specifications:

For 5GHz, 5150~5350MHz & 5470~5600 & 5650~5725MHz

<b>APPLIED STANDARD: FCC Part 15, Subpart E (Section 15.407)</b>			
<b>Standard Section</b>	<b>Test Type</b>	<b>Result</b>	<b>Remark</b>
15.407(b)(5)	AC Power Conducted Emission	PASS	Meet the requirement of limit. Minimum passing margin is -25.52dB at 9.215MHz
15.407(b/1/2/3) (b)(5)	Electric Field Strength Spurious Emissions, 30MHz ~ 40000MHz	PASS	Meet the requirement of limit. Minimum passing margin is -1.1dB at 5150.0MHz & 5350.0MHz
15.407(a/1/2/3)	Output Transmit Power	PASS	Meet the requirement of limit.
15.407(a)(6)	Peak Power Excursion	PASS	Meet the requirement of limit.
15.407(a/1/2/3)	Peak Power Spectral Density	PASS	Meet the requirement of limit.
15.407(g)	Frequency Stability	PASS	Meet the requirement of limit.
15.203	Antenna Requirement	PASS	Antenna connector is Reverse SMA not a standard connector.

### NOTE:

1. The EUT was operating in 2400 ~ 2483.5MHz, 5.15~5.35GHz, 5.47~5.6GHz & 5.65~5.725GHz and 5.725~5.850GHz frequencies band. This report was recorded the RF parameters including 5.15~5.35GHz and 5.47~5.6GHz & 5.65~5.725GHz. For the 2400 ~ 2483.5MHz and 5.725~5.85GHz RF parameters was recorded in another test report.
2. The DFS report was recorded in another test report.



A D T

## 2.1 MEASUREMENT UNCERTAINTY

Where relevant, the following measurement uncertainty levels have been estimated for tests performed on the EUT as specified in CISPR 16-4-2:

This uncertainty represents an expanded uncertainty expressed at approximately the 95% confidence level using a coverage factor of  $k=2$ .

Measurement	Value
Conducted emissions	2.45 dB
Radiated emissions (30MHz-1GHz)	3.89 dB
Radiated emissions (1GHz -18GHz)	2.19 dB
Radiated emissions (18GHz -40GHz)	2.56 dB



A D T

### 3. GENERAL INFORMATION

#### 3.1 GENERAL DESCRIPTION OF EUT

<b>PRODUCT</b>	Radio Module
<b>MODEL NO.</b>	21-148603-0A
<b>FCC ID</b>	UZ7211486030A
<b>POWER SUPPLY</b>	DC 3.3V
<b>MODULATION TYPE</b>	CCK, DQPSK, DBPSK for DSSS 64QAM, 16QAM, QPSK, BPSK for OFDM
<b>MODULATION TECHNOLOGY</b>	DSSS, OFDM
<b>TRANSFER RATE</b>	802.11b: up to 11Mbps 802.11g: up to 54Mbps 802.11n (20MHz, 800ns GI): up to 72.2Mbps 802.11n (20MHz, 400ns GI): up to 65Mbps
<b>OPERATING FREQUENCY</b>	<b>For 15.407</b> 802.11a: 5.18 ~ 5.24GHz, 5.26 ~ 5.32GHz, 5.5~5.58GHz & 5.66~5.7GHz
	<b>For 15.247</b> 802.11b & 802.11g: 2.412 ~ 2.472GHz 802.11a: 5.745 ~ 5.825GHz
<b>NUMBER OF CHANNEL</b>	<b>For 15.407</b> 16 for 802.11a, 802.11n (20MHz)
	<b>For 15.247(2.4GHz)</b> 13 for 802.11b, 802.11g, 802.11n (20MHz)
	<b>For 15.247(5GHz)</b> 5 for 802.11a, 802.11n (20MHz)
<b>MAXIMUM OUTPUT POWER</b>	<b>For 15.407</b> 802.11a: 102.3mW 802.11n (20MHz): 89.1mW
	<b>For 15.247(2.4GHz)</b> 802.11b: 208.9mW 802.11g: 257.0mW 802.11n (20MHz): 251.2mW
	<b>For 15.247(5GHz)</b> 802.11a: 158.5mW 802.11n (20MHz): 154.9mW
<b>ANTENNA TYPE</b>	Please see note
<b>DATA CABLE</b>	NA





A D T

<b>I/O PORTS</b>	NA
<b>ASSOCIATED DEVICES</b>	NA

**NOTE:**

1. There are Bluetooth technology, GPS technology and WLAN technology used for the EUT. and the functions of EUT listed as below table:

Function	Report No.
WLAN	RF111028C08 (FCC Part15C) RF111028C08-1(FCC Part15E)
Bluetooth	RF111028C08-2

2. The antennas provided to the EUT, please refer to the following table:

No.	Type	Connector	Model	Peak Gain (dBi)	Cable loss (dB)	Net Peak Gain (dBi)	Trace
1	Dipole	Reverse SMA	ML-2452-APA2-01 Rev C	2.4GHz : 3 5GHz : 5	2.4GHz : 0.75 5GHz : 1.3	2.4GHz : 2.25 5GHz : 3.7	WiFi + BT
2	Chip	Reverse SMA	NA	-	-		GPS

3. The EUT was included two SKU, which are identical to each other in all aspects except for the following table:

	P/N	Description
SKU #1	21-148603-01	Diversity version with WLAN and BT on SHARED RF paths
SKU #2	21-148603-03	NON-Diversity version with WLAN and BT on SHARED RF paths

**SKU #1**, the worse case one, was chosen for final test.

4. Spurious Emission of the simultaneous operation (WiFi & Bluetooth) have been evaluated and no non-compliance found. (The device can transmit simultaneously on WLAN (5GHz) mode and Bluetooth mode; other modes can't support simultaneously ability.)
5. The EUT is 1 \* 1 spatial SISO (1Tx & 1Rx) without beam forming function.
6. The above EUT information was declared by the manufacturer and for more detailed features description, please refer to the manufacturer's specifications or User's manual.



A D T

### 3.2 DESCRIPTION OF TEST MODES

#### Operated in 5150MHz ~ 5350MHz bands:

Eight channels are provided for 802.11a and 802.11n (20MHz):

CHANNEL	FREQUENCY
36	5180 MHz
40	5200 MHz
44	5220 MHz
48	5240 MHz
52	5260 MHz
56	5280 MHz
60	5300 MHz
64	5320 MHz

#### Operated in 5470MHz ~ 5600MHz & 5650MHz ~ 5725MHz bands:

Eight channels are provided for 802.11a and 802.11n (20MHz):

CHANNEL	FREQUENCY
100	5500 MHz
104	5520 MHz
108	5540 MHz
112	5560 MHz
116	5580 MHz
132	5660 MHz
136	5680 MHz
140	5700 MHz



A D T

### 3.2.1 TEST MODE APPLICABILITY AND TESTED CHANNEL DETAIL

EUT CONFIGURE MODE	APPLICABLE TO					DESCRIPTION
	PLC	RE < 1G	RE ≥ 1G	APCM	OB	
	√	√	√	√	√	-

Where **PLC**: Power Line Conducted Emission      **RE < 1G**: Radiated Emission below 1GHz  
**RE ≥ 1G**: Radiated Emission above 1GHz      **APCM**: Antenna Port Conducted Measurement  
**OB**: Conducted Out-Band Emission Measurement

#### **POWER LINE CONDUCTED EMISSION TEST:**

- Pre-Scan has been conducted to determine the worst-case mode from all possible combinations between available modulations, data rates and antenna ports (if EUT with antenna diversity architecture).
- Following channel(s) was (were) selected for the final test as listed below.

MODE	AVAILABLE CHANNEL	TESTED CHANNEL	MODULATION TECHNOLOGY	MODULATION TYPE	DATA RATE (Mbps)
802.11a	36 to 140	52	OFDM	BPSK	6

#### **RADIATED EMISSION TEST (BELOW 1 GHz):**

- Pre-Scan has been conducted to determine the worst-case mode from all possible combinations between available modulations, data rates and antenna ports (if EUT with antenna diversity architecture).
- Following channel(s) was (were) selected for the final test as listed below.

MODE	AVAILABLE CHANNEL	TESTED CHANNEL	MODULATION TECHNOLOGY	MODULATION TYPE	DATA RATE (Mbps)
802.11a	36 to 140	52	OFDM	BPSK	6



**RADIATED EMISSION TEST (ABOVE 1 GHz):**

- Pre-Scan has been conducted to determine the worst-case mode from all possible combinations between available modulations, data rates and antenna ports (if EUT with antenna diversity architecture).
- Following channel(s) was (were) selected for the final test as listed below.

MODE	AVAILABLE CHANNEL	TESTED CHANNEL	MODULATION TECHNOLOGY	MODULATION TYPE	DATA RATE (Mbps)
802.11a	36 to 140	36, 40, 48, 52, 60, 64, 100, 116, 132, 140	OFDM	BPSK	6
For 5 GHz 802.11n (20MHz)	36 to 140	36, 40, 48, 52, 60, 64, 100, 116, 132, 140	OFDM	BPSK	6.5

**ANTENNA PORT CONDUCTED MEASUREMENT:**

- This item includes all test value of each mode, but only includes spectrum plot of worst value of each mode.
- Pre-Scan has been conducted to determine the worst-case mode from all possible combinations between available modulations, data rates and antenna ports (if EUT with antenna diversity architecture).
- Following channel(s) was (were) selected for the final test as listed below.

MODE	AVAILABLE CHANNEL	TESTED CHANNEL	MODULATION TECHNOLOGY	MODULATION TYPE	DATA RATE (Mbps)
802.11a	36 to 140	36, 40, 48, 52, 60, 64, 100, 116, 132, 140	OFDM	BPSK	6
For 5 GHz 802.11n (20MHz)	36 to 140	36, 40, 48, 52, 60, 64, 100, 116, 132, 140	OFDM	BPSK	6.5



A D T

**CONDUCTED OUT-BAND EMISSION MEASUREMENT:**

- Pre-Scan has been conducted to determine the worst-case mode from all possible combinations between available modulations, data rates and antenna ports (if EUT with antenna diversity architecture).
- Following channel(s) was (were) selected for the final test as listed below.

MODE	AVAILABLE CHANNEL	TESTED CHANNEL	MODULATION TECHNOLOGY	MODULATION TYPE	DATA RATE (Mbps)
802.11a	36 to 140	36, 64, 100, 140	OFDM	BPSK	6
For 5 GHz 802.11n (20MHz)	36 to 140	36, 64, 100, 140	OFDM	BPSK	6.5

**TEST CONDITION:**

APPLICABLE TO	ENVIRONMENTAL CONDITIONS	INPUT POWER	TESTED BY
PLC	26deg. C, 68%RH	120Vac, 60Hz(system)	Andy Ho
RE<1G	18deg. C, 64%RH	DC 3.3V	Nick Chang
RE <sup>3</sup> 1G	21deg. C, 66%RH	DC 3.3V	Kent Liu
APCM	25deg. C, 60%RH	DC 3.3V	Kent Liu
OB	25deg. C, 60%RH	DC 3.3V	Kent Liu

### **3.3 GENERAL DESCRIPTION OF APPLIED STANDARDS**

The EUT is a RF product. According to the specifications of the manufacturer, it must comply with the requirements of the following standards:

**FCC Part 15, Subpart E (Section 15.407)**

**ANSI C63.4-2003**

**ANSI C63.10-2009**

All test items have been performed and recorded as per the above standards.

**NOTE:** The EUT is also considered as a kind of computer peripheral, because the connection to computer is necessary for typical use. It has been verified to comply with the requirements of FCC Part 15, Subpart B, Class B (DoC). The test report has been issued separately.



A D T

### 3.4 DESCRIPTION OF SUPPORT UNITS

The EUT has been tested as an independent unit together with other necessary accessories or support units. The following support units or accessories were used to form a representative test configuration during the tests.

No.	Product	Brand	Model No.	Serial No.	FCC ID
1	NOTEBOOK COMPUTER	DELL	PP32LA	FSLB32S	FCC DoC
2	DC POWER SUPPLY	Topward	6603D	795558	NA

No.	Signal cable description
1	USB cable (1.8m with one core)
2	DC line (2m)

Note: 1. All power cords of the above support units are unshielded (1.8m).

### 3.5 CONFIGURATION OF SYSTEM UNDER TEST

For Conducted Emission test:

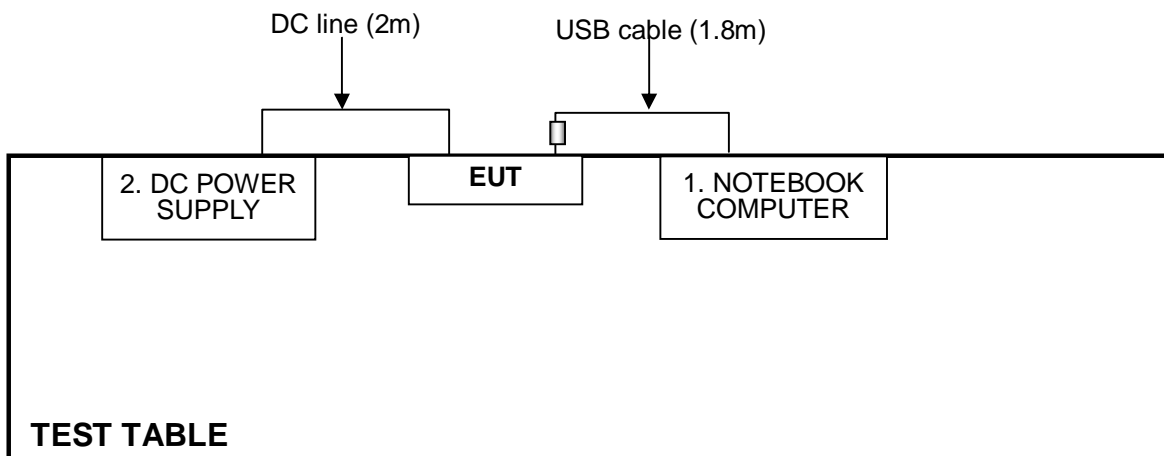

For other test items:

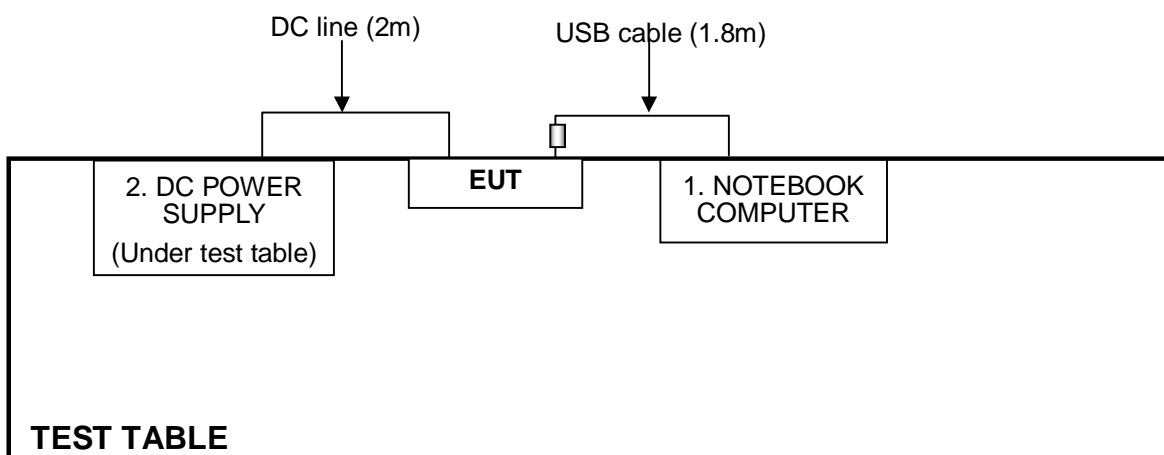



## 4. TEST TYPES AND RESULTS

### 4.1 CONDUCTED EMISSION MEASUREMENT

#### 4.1.1 LIMITS OF CONDUCTED EMISSION MEASUREMENT

FREQUENCY OF EMISSION (MHz)	CONDUCTED LIMIT (dB $\mu$ V)	
	Quasi-peak	Average
0.15-0.5	66 to 56	56 to 46
0.5-5	56	46
5-30	60	50

- NOTE:**
1. The lower limit shall apply at the transition frequencies.
  2. The limit decreases in line with the logarithm of the frequency in the range of 0.15 to 0.50 MHz.

#### 4.1.2 TEST INSTRUMENTS

Test date: Nov. 14, 2011

DESCRIPTION & MANUFACTURER	MODEL NO.	SERIAL NO.	CALIBRATED DATE	CALIBRATED UNTIL
Test Receiver	ESCS 30	100375	Mar. 09, 2011	Mar. 08, 2012
Line-Impedance Stabilization Network (for EUT)	NSLK8127	8127-522	Sep. 07, 2011	Sep. 06, 2012
Line-Impedance Stabilization Network (for Peripheral)	ESH3-Z5	848773/004	Nov. 01, 2011	Oct. 31, 2012
RF Cable (JYEBAO)	5DFB	COCCAB-002	Aug. 29, 2011	Aug. 28, 2012
50 ohms Terminator	50	3	Nov. 02, 2011	Nov. 01, 2012
Software	BV ADT_Cond_V7.3.7	NA	NA	NA

**Note:**

1. The calibration interval of the above test instruments is 12 months and the calibrations are traceable to NML/ROC and NIST/USA.
2. The test was performed in Shielded Room No. C.
3. The VCCI Con C Registration No. is C-3611.



A D T

#### 4.1.3 TEST PROCEDURES

- a. The EUT was placed 0.4 meters from the conducting wall of the shielded room with EUT being connected to the power mains through a line impedance stabilization network (LISN). Other support units were connected to the power mains through another LISN.
- b. The two LISNs provide 50 ohm/ 50uH of coupling impedance for the measuring instrument.
- c. Both lines of the power mains connected to the EUT were checked for maximum conducted interference.
- d. The frequency range from 150kHz to 30MHz was searched. Emission level under (Limit – 20dB) was not recorded.

#### 4.1.4 DEVIATION FROM TEST STANDARD

No deviation

#### 4.1.5 TEST SETUP

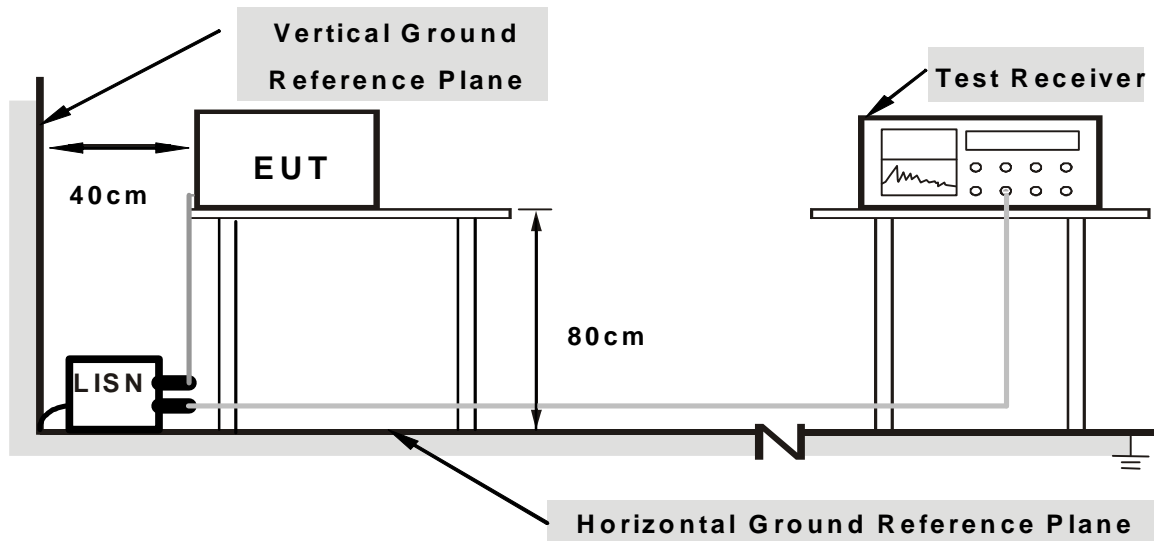

**Note: 1.Support units were connected to second LISN.**

**2.Both of LISNs (AMN) are 80 cm from EUT and at least 80 from other units and other metal planes**

For the actual test configuration, please refer to the related item – Photographs of the Test Configuration.

#### 4.1.6 EUT OPERATING CONDITIONS

1. Connect the EUT with the support unit 1 (Notebook Computer) which is placed on a testing table.
2. The communication partner run test program “RTTT.exe” to enable EUT under transmission/receiving condition continuously at specific channel frequency.

### 4.1.7 TEST RESULTS

<b>PHASE</b>	Line (L)	<b>6dB BANDWIDTH</b>	9 kHz
--------------	----------	----------------------	-------

No	Freq. [MHz]	Corr. Factor (dB)	Reading Value [dB (uV)]		Emission Level [dB (uV)]		Limit [dB (uV)]		Margin (dB)	
			Q.P.	AV.	Q.P.	AV.	Q.P.	AV.	Q.P.	AV.
1	0.177	0.09	15.97	3.91	16.06	4.00	64.61	54.61	-48.55	-50.61
2	0.224	0.10	9.99	4.47	10.09	4.57	62.66	52.66	-52.57	-48.09
3	0.295	0.10	8.69	7.34	8.79	7.44	60.40	50.40	-51.60	-42.95
4	0.373	0.11	7.92	3.64	8.03	3.75	58.44	48.44	-50.41	-44.69
5	5.207	0.37	21.62	15.86	21.99	16.23	60.00	50.00	-38.01	-33.77
<b>6</b>	<b>9.215</b>	<b>0.52</b>	<b>28.08</b>	<b>23.96</b>	<b>28.60</b>	<b>24.48</b>	<b>60.00</b>	<b>50.00</b>	<b>-31.40</b>	<b>-25.52</b>
7	9.898	0.55	23.21	19.28	23.76	19.83	60.00	50.00	-36.24	-30.17
8	11.949	0.59	26.61	21.82	27.20	22.41	60.00	50.00	-32.80	-27.59
9	15.360	0.67	25.62	21.88	26.29	22.55	60.00	50.00	-33.71	-27.45

- REMARKS:**
1. Q.P. and AV. are abbreviations of quasi-peak and average individually.
  2. The emission levels of other frequencies were very low against the limit.
  3. Margin value = Emission level - Limit value
  4. Correction factor = Insertion loss + Cable loss
  5. Emission Level = Correction Factor + Reading Value.

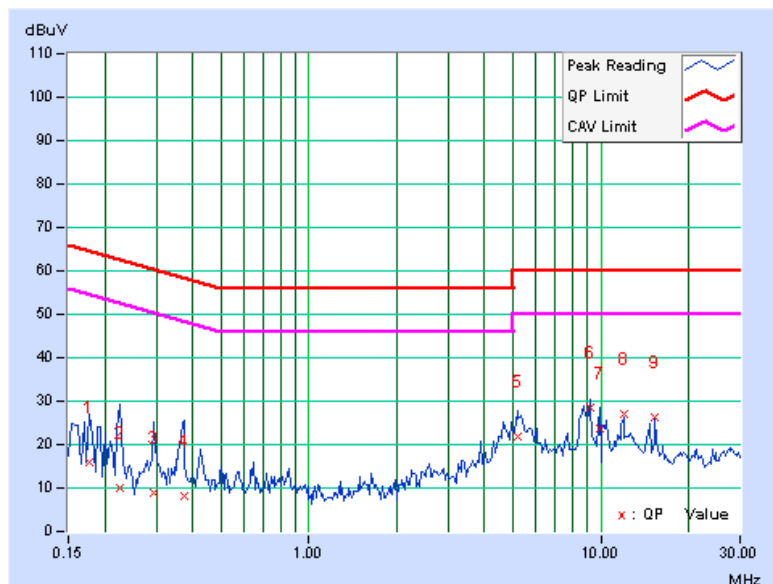

<b>PHASE</b>	Neutral (N)	<b>6dB BANDWIDTH</b>	9 kHz
--------------	-------------	----------------------	-------

No	Freq. [MHz]	Corr. Factor (dB)	Reading Value		Emission Level		Limit		Margin	
			[dB (uV)]		[dB (uV)]		[dB (uV)]		(dB)	
			Q.P.	AV.	Q.P.	AV.	Q.P.	AV.	Q.P.	AV.
1	0.150	0.07	14.93	4.74	15.00	4.81	66.00	56.00	-51.00	-51.19
2	0.275	0.10	8.61	7.83	8.71	7.93	60.97	50.97	-52.26	-43.04
3	0.412	0.11	8.10	7.58	8.21	7.69	57.61	47.61	-49.40	-39.92
4	5.234	0.27	21.00	14.58	21.27	14.85	60.00	50.00	-38.73	-35.15
5	9.223	0.39	25.97	21.37	26.36	21.76	60.00	50.00	-33.64	-28.24
6	11.953	0.46	25.90	21.48	26.36	21.94	60.00	50.00	-33.64	-28.06
7	15.362	0.54	25.70	22.03	26.24	22.57	60.00	50.00	-33.76	-27.43

- REMARKS:**
1. Q.P. and AV. are abbreviations of quasi-peak and average individually.
  2. The emission levels of other frequencies were very low against the limit.
  3. Margin value = Emission level - Limit value
  4. Correction factor = Insertion loss + Cable loss
  5. Emission Level = Correction Factor + Reading Value.

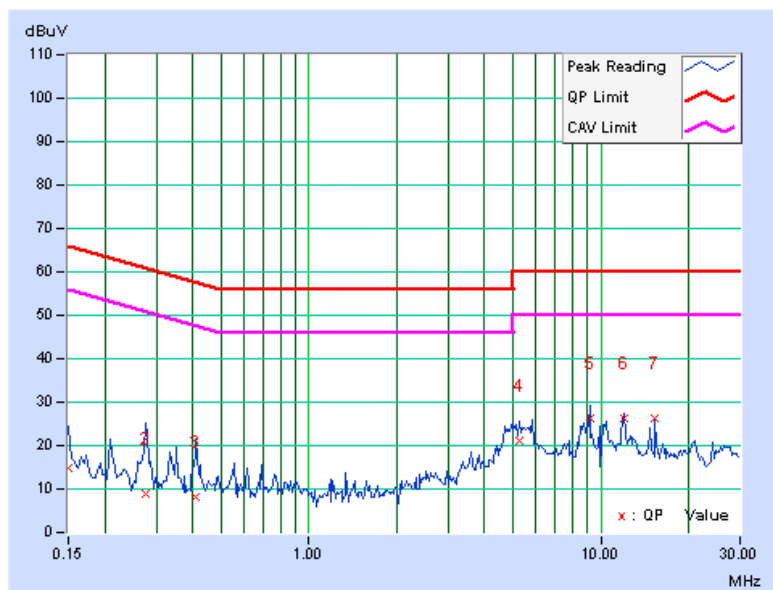

## 4.2 RADIATED EMISSION MEASUREMENT

### 4.2.1 LIMITS OF RADIATED EMISSION MEASUREMENT

Emissions radiated outside of the specified bands, shall be according to the general radiated limits in 15.209 as following:

Frequencies (MHz)	Field strength (microvolts/meter)	Measurement distance (meters)
0.009-0.490	2400/F(kHz)	300
0.490-1.705	24000/F(kHz)	30
1.705-30.0	30	30
30-88	100	3
88-216	150	3
216-960	200	3
Above 960	500	3

**NOTE:**

1. The lower limit shall apply at the transition frequencies.
2. Emission level (dBuV/m) = 20 log Emission level (uV/m).
3. As shown in 15.35(b), for frequencies above 1000MHz, the field strength limits are based on average detector, however, the peak field strength of any emission shall not exceed the maximum permitted average limits, specified above by more than 20dB under any condition of modulation.
4. Section 15.205 restricted bands of operation shall compliance with the limits in Section 15.209.



A D T

#### 4.2.2 LIMITS OF UNWANTED EMISSION OUT OF THE RESTRICTED BANDS

Frequencies (MHz)	EIRP Limit (dBm)	Equivalent Field Strength at 3m (dB $\mu$ V/m) *note 3
5150~5250	-27	68.3
5250~5350	-27	68.3
5470~5725	-27	68.3
5725~5825	-27 *note 1	68.3
	-17 *note 2	78.3

**NOTE:**

1. For frequencies 10MHz or greater above or below the band edge.
2. All emissions within the frequency range from the band edge to 10MHz above or below the band edge.
3. The following formula is used to convert the equipment isotropic radiated power (eirp) to field strength

$$E = \frac{1000000\sqrt{30P}}{3} \mu\text{V/m, where P is the eirp (Watts)}$$



A D T

#### 4.2.3 TEST INSTRUMENTS

**For below 1GHz: Test date: Nov. 26, 2011**

DESCRIPTION & MANUFACTURER	MODEL NO.	SERIAL NO.	CALIBRATED DATE	CALIBRATED UNTIL
Agilent Spectrum Analyzer	E4446A	MY48250253	Aug. 29, 2011	Aug. 28, 2012
Agilent Pre-Selector	N9039A	MY46520310	Aug. 29, 2011	Aug. 28, 2012
Agilent Signal Generator	N5181A	MY49060347	July 25, 2011	July 24, 2012
Mini-Circuits Pre-Amplifier	ZFL-1000VH2B	AMP-ZFL-04	Nov. 15, 2011	Nov. 14, 2012
Agilent Pre-Amplifier	8449B	3008A02465	Feb. 28, 2011	Feb. 27, 2012
SPACEK LABS	SLKKa-48-6	9K16	Nov. 15, 2011	Nov. 14, 2012
SCHWARZBECK Trilog Broadband Antenna	VULB 9168	9168-361	Apr. 14, 2011	Apr. 13, 2012
AISI Horn_Antenna	AIH.8018	0000220091110	Nov. 22, 2011	Nov. 21, 2012
SCHWARZBECK Horn_Antenna	BBHA 9170	9170-424	Oct. 07, 2011	Oct. 06, 2012
RF CABLE	NA	RF104-205 RF104-207 RF104-202	Dec. 28, 2010	Dec. 27, 2011
RF Cable	NA	CHHCAB_001	Oct. 08, 2011	Oct. 07, 2012
Software	ADT_Radiated_V8.7.05	NA	NA	NA
CT Antenna Tower & Turn Table	NA	NA	NA	NA

Note: 1. The calibration interval of the above test instruments is 12 months and the calibrations are traceable to NML/ROC and NIST/USA.

2. The horn antenna, preamplifier (model: 8449B) are used only for the measurement of emission frequency above 1GHz if tested.

3. The test was performed in 966 Chamber No. H.

4. The FCC Site Registration No. is 797305.

5. The CANADA Site Registration No. is IC 7450H-3.





A D T

**For above 1GHz: Test date: Nov. 30, 2011**

DESCRIPTION & MANUFACTURER	MODEL NO.	SERIAL NO.	CALIBRATED DATE	CALIBRATED UNTIL
Agilent Spectrum Analyzer	E4446A	MY48250254	July 12, 2011	July 11, 2012
Agilent Pre-Selector	N9039A	MY46520311	July 12, 2011	July 11, 2012
Agilent Signal Generator	N5181A	MY49060517	July 12, 2011	July 11, 2012
Mini-Circuits Pre-Amplifier	ZFL-1000VH2B	AMP-ZFL-03	Nov. 15, 2011	Nov. 14, 2012
Agilent Pre-Amplifier	8449B	3008A02578	July 04, 2011	July 03, 2012
SPACEK LABS	SLKKa-48-6	9K16	Nov. 15, 2011	Nov. 14, 2012
SCHWARZBECK Trilog Broadband Antenna	VULB 9168	9168-360	Apr. 14, 2011	Apr. 13, 2012
AISI Horn_Antenna	AIH.8018	0000320091110	Nov. 14, 2011	Nov. 13, 2012
SCHWARZBECK Horn_Antenna	BBHA 9170	9170-424	Oct. 07, 2011	Oct. 06, 2012
RF CABLE	NA	RF104-201 RF104-203 RF104-204	Dec. 27, 2010	Dec. 26, 2011
RF Cable	NA	CHGCAB_001	Oct. 07, 2011	Oct. 06, 2012
Software	ADT_Radiated_V8.7.05	NA	NA	NA
CT Antenna Tower & Turn Table	NA	NA	NA	NA

- Note: 1. The calibration interval of the above test instruments is 12 months and the calibrations are traceable to NML/ROC and NIST/USA.  
2. The horn antenna, preamplifier (model: 8449B) are used only for the measurement of emission frequency above 1GHz if tested.  
3. The test was performed in 966 Chamber No. G.  
4. The FCC Site Registration No. is 966073.  
5. The VCCI Site Registration No. is G-137.  
6. The CANADA Site Registration No. is IC 7450H-2.



A D T

#### 4.2.4 TEST PROCEDURES

- a. The EUT was placed on the top of a rotating table 0.8 meters above the ground at a 3 meters chamber room. The table was rotated 360 degrees to determine the position of the highest radiation.
- b. The EUT was set 3 meters away from the interference-receiving antenna, which was mounted on the top of a variable-height antenna tower.
- c. The height of antenna is varied from one meter to four meters above the ground to determine the maximum value of the field strength. Both horizontal and vertical polarizations of the antenna are set to make the measurement.
- d. For each suspected emission, the EUT was arranged to its worst case and then the antenna was tuned to heights from 1 meter to 4 meters and the rotatable table was turned from 0 degrees to 360 degrees to find the maximum reading.
- e. The test-receiver system was set to quasi-peak detect function and specified bandwidth with maximum hold mode when the test frequency is below 1 GHz.
- f. The test-receiver system was set to peak and average detect function and specified bandwidth with maximum hold mode when the test frequency is above 1 GHz. If the peak reading value also meets average limit, measurement with the average detector is unnecessary.

**NOTE:**

1. The resolution bandwidth and video bandwidth of test receiver/spectrum analyzer is 120kHz for Quasi-peak detection (QP) at frequency below 1GHz.
2. The resolution bandwidth of test receiver/spectrum analyzer is 1 MHz and the video bandwidth is 3 MHz for Peak detection (PK) at frequency above 1GHz.
3. The resolution bandwidth of test receiver/spectrum analyzer is 1 MHz and the video bandwidth is 10 Hz for Average detection (AV) at frequency above 1GHz.

#### 4.2.5 DEVIATION FROM TEST STANDARD

No deviation

#### 4.2.6 TEST SETUP

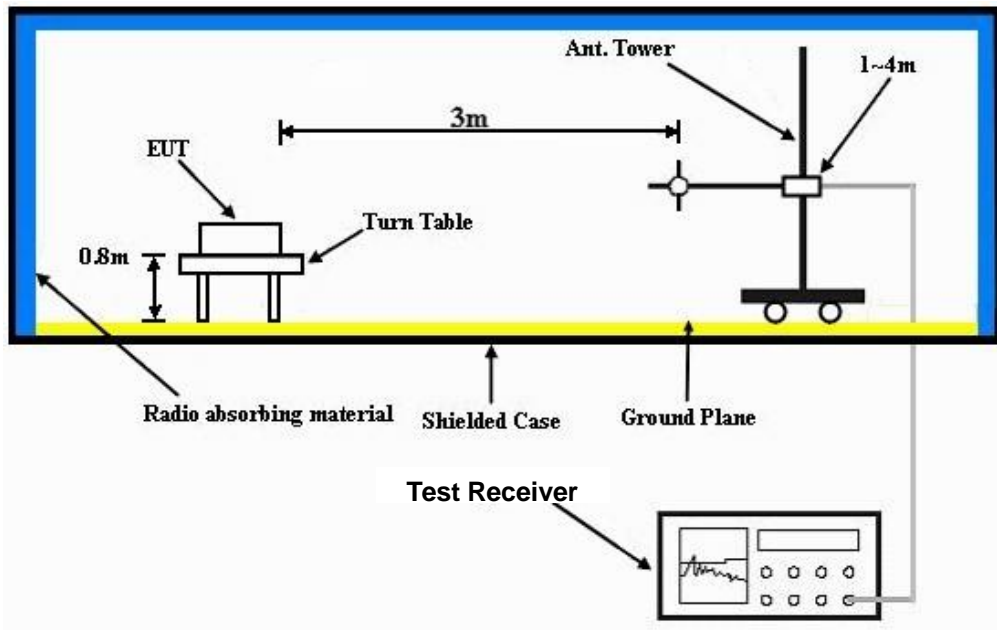

For the actual test configuration, please refer to the related item – Photographs of the Test Configuration.

#### 4.2.7 EUT OPERATING CONDITION

Same as 4.1.6



A D T

## 4.2.8 TEST RESULTS

## BELOW 1GHz WORST-CASE DATA : 802.11a OFDM MODULATION

EUT TEST CONDITION		MEASUREMENT DETAIL	
CHANNEL	Channel 52	FREQUENCY RANGE	Below 1000MHz
INPUT POWER	DC 3.3V	DETECTOR FUNCTION	Quasi-Peak
ENVIRONMENTAL CONDITIONS	18deg. C, 64%RH	TESTED BY	Nick Chang

ANTENNA POLARITY & TEST DISTANCE: HORIZONTAL AT 3 M								
NO.	FREQ. (MHz)	EMISSION LEVEL (dBuV/m)	LIMIT (dBuV/m)	MARGIN (dB)	ANTENNA HEIGHT (m)	TABLE ANGLE (Degree)	RAW VALUE (dBuV)	CORRECTION FACTOR (dB/m)
1	33.91	24.8 QP	40.0	-15.2	1.50 H	245	11.43	13.35
2	160.98	34.4 QP	43.5	-9.1	1.50 H	229	19.93	14.46
3	360.04	31.2 QP	46.0	-14.8	1.00 H	172	14.41	16.75
4	480.01	30.0 QP	46.0	-16.0	1.50 H	249	10.42	19.58
5	722.18	23.2 QP	46.0	-22.8	1.00 H	226	-0.37	23.61
6	844.16	33.5 QP	46.0	-12.5	1.00 H	55	7.40	26.14
ANTENNA POLARITY & TEST DISTANCE: VERTICAL AT 3 M								
NO.	FREQ. (MHz)	EMISSION LEVEL (dBuV/m)	LIMIT (dBuV/m)	MARGIN (dB)	ANTENNA HEIGHT (m)	TABLE ANGLE (Degree)	RAW VALUE (dBuV)	CORRECTION FACTOR (dB/m)
1	42.55	28.9 QP	40.0	-11.1	1.00 V	147	14.68	14.23
2	150.08	33.1 QP	43.5	-10.4	1.00 V	279	18.41	14.66
3	308.53	28.0 QP	46.0	-18.0	1.50 V	232	12.43	15.59
4	480.01	26.7 QP	46.0	-19.4	1.50 V	285	7.07	19.58
5	856.83	34.2 QP	46.0	-11.8	1.00 V	137	7.86	26.32
6	940.67	33.1 QP	46.0	-12.9	1.50 V	360	5.52	27.54

- REMARKS:**
1. Emission level (dBuV/m) = Raw Value (dBuV) + Correction Factor (dB/m).
  2. Correction Factor (dB/m) = Antenna Factor (dB/m) + Cable Factor (dB).
  3. The other emission levels were very low against the limit.
  4. Margin value = Emission level – Limit value.



A D T

**ABOVE 1GHz WORST-CASE DATA**

**802.11a OFDM MODULATION**

EUT TEST CONDITION		MEASUREMENT DETAIL	
CHANNEL	Channel 36	FREQUENCY RANGE	1 ~ 40GHz
INPUT POWER	DC 3.3V	DETECTOR FUNCTION	Peak (PK) Average (AV)
ENVIRONMENTAL CONDITIONS	21deg. C, 66%RH	TESTED BY	Kent Liu

ANTENNA POLARITY & TEST DISTANCE: HORIZONTAL AT 3 M								
NO.	FREQ. (MHz)	EMISSION LEVEL (dBuV/m)	LIMIT (dBuV/m)	MARGIN (dB)	ANTENNA HEIGHT (m)	TABLE ANGLE (Degree)	RAW VALUE (dBuV)	CORRECTION FACTOR (dB/m)
1	5150.00	57.5 PK	74.0	-16.5	1.25 H	88	17.56	39.94
2	5150.00	45.8 AV	54.0	-8.2	1.25 H	88	5.86	39.94
3	*5180.00	100.1 PK			1.25 H	88	60.08	40.02
4	*5180.00	87.2 AV			1.25 H	88	47.18	40.02
5	#10360.00	54.8 PK	68.3	-13.5	1.40 H	6	8.27	46.53

ANTENNA POLARITY & TEST DISTANCE: VERTICAL AT 3 M								
NO.	FREQ. (MHz)	EMISSION LEVEL (dBuV/m)	LIMIT (dBuV/m)	MARGIN (dB)	ANTENNA HEIGHT (m)	TABLE ANGLE (Degree)	RAW VALUE (dBuV)	CORRECTION FACTOR (dB/m)
1	5150.00	70.1 PK	74.0	-3.9	1.00 V	126	30.16	39.94
2	<b>5150.00</b>	<b>52.9 AV</b>	<b>54.0</b>	<b>-1.1</b>	<b>1.00 V</b>	<b>126</b>	<b>12.96</b>	<b>39.94</b>
3	*5180.00	112.2 PK			1.00 V	126	72.18	40.02
4	*5180.00	97.6 AV			1.00 V	126	57.58	40.02
5	#10360.00	56.9 PK	68.3	-11.4	1.36 V	307	10.37	46.53

- REMARKS:**
1. Emission level (dBuV/m) = Raw Value (dBuV) + Correction Factor (dB/m).
  2. Correction Factor (dB/m) = Antenna Factor (dB/m) + Cable Factor (dB).
  3. The other emission levels were very low against the limit.
  4. Margin value = Emission level – Limit value.
  5. “ \* “: Fundamental frequency.
  6. “#”:The radiated frequency is out the restricted band.



A D T

EUT TEST CONDITION		MEASUREMENT DETAIL	
CHANNEL	Channel 40	FREQUENCY RANGE	1 ~ 40GHz
INPUT POWER	DC 3.3V	DETECTOR FUNCTION	Peak (PK) Average (AV)
ENVIRONMENTAL CONDITIONS	21deg. C, 66%RH	TESTED BY	Kent Liu

ANTENNA POLARITY & TEST DISTANCE: HORIZONTAL AT 3 M								
NO.	FREQ. (MHz)	EMISSION LEVEL (dBuV/m)	LIMIT (dBuV/m)	MARGIN (dB)	ANTENNA HEIGHT (m)	TABLE ANGLE (Degree)	RAW VALUE (dBuV)	CORRECTION FACTOR (dB/m)
1	*5200.00	100.1 PK			1.30 H	95	60.03	40.07
2	*5200.00	87.3 AV			1.30 H	95	47.23	40.07
3	#10400.00	54.9 PK	68.3	-13.4	1.41 H	0	8.33	46.57
ANTENNA POLARITY & TEST DISTANCE: VERTICAL AT 3 M								
NO.	FREQ. (MHz)	EMISSION LEVEL (dBuV/m)	LIMIT (dBuV/m)	MARGIN (dB)	ANTENNA HEIGHT (m)	TABLE ANGLE (Degree)	RAW VALUE (dBuV)	CORRECTION FACTOR (dB/m)
1	*5200.00	112.5 PK			1.50 V	85	72.43	40.07
2	*5200.00	98.3 AV			1.50 V	85	58.23	40.07
3	#10400.00	57.5 PK	68.3	-10.8	1.41 V	315	10.93	46.57

- REMARKS:**
1. Emission level (dBuV/m) = Raw Value (dBuV) + Correction Factor (dB/m).
  2. Correction Factor (dB/m) = Antenna Factor (dB/m) + Cable Factor (dB).
  3. The other emission levels were very low against the limit.
  4. Margin value = Emission level – Limit value.
  5. “ \* “: Fundamental frequency.
  6. “ # “: The radiated frequency is out the restricted band.



A D T

EUT TEST CONDITION		MEASUREMENT DETAIL	
CHANNEL	Channel 48	FREQUENCY RANGE	1 ~ 40GHz
INPUT POWER	DC 3.3V	DETECTOR FUNCTION	Peak (PK) Average (AV)
ENVIRONMENTAL CONDITIONS	21deg. C, 66%RH	TESTED BY	Kent Liu

ANTENNA POLARITY & TEST DISTANCE: HORIZONTAL AT 3 M								
NO.	FREQ. (MHz)	EMISSION LEVEL (dBuV/m)	LIMIT (dBuV/m)	MARGIN (dB)	ANTENNA HEIGHT (m)	TABLE ANGLE (Degree)	RAW VALUE (dBuV)	CORRECTION FACTOR (dB/m)
1	*5240.00	100.2 PK			1.33 H	79	60.03	40.17
2	*5240.00	87.5 AV			1.33 H	79	47.33	40.17
3	#10480.00	54.5 PK	68.3	-13.8	1.39 H	12	7.83	46.67
ANTENNA POLARITY & TEST DISTANCE: VERTICAL AT 3 M								
NO.	FREQ. (MHz)	EMISSION LEVEL (dBuV/m)	LIMIT (dBuV/m)	MARGIN (dB)	ANTENNA HEIGHT (m)	TABLE ANGLE (Degree)	RAW VALUE (dBuV)	CORRECTION FACTOR (dB/m)
1	*5240.00	112.1 PK			1.48 V	76	71.93	40.17
2	*5240.00	98.2 AV			1.48 V	76	58.03	40.17
3	#10480.00	57.1 PK	68.3	-11.2	1.46 V	311	10.43	46.67

- REMARKS:**
1. Emission level (dBuV/m) = Raw Value (dBuV) + Correction Factor (dB/m).
  2. Correction Factor (dB/m) = Antenna Factor (dB/m) + Cable Factor (dB).
  3. The other emission levels were very low against the limit.
  4. Margin value = Emission level – Limit value.
  5. “ \* “: Fundamental frequency.
  6. "#":The radiated frequency is out the restricted band.



A D T

EUT TEST CONDITION		MEASUREMENT DETAIL	
CHANNEL	Channel 52	FREQUENCY RANGE	1 ~ 40GHz
INPUT POWER	DC 3.3V	DETECTOR FUNCTION	Peak (PK) Average (AV)
ENVIRONMENTAL CONDITIONS	21deg. C, 66%RH	TESTED BY	Kent Liu

ANTENNA POLARITY & TEST DISTANCE: HORIZONTAL AT 3 M								
NO.	FREQ. (MHz)	EMISSION LEVEL (dBuV/m)	LIMIT (dBuV/m)	MARGIN (dB)	ANTENNA HEIGHT (m)	TABLE ANGLE (Degree)	RAW VALUE (dBuV)	CORRECTION FACTOR (dB/m)
1	*5260.00	102.5 PK			1.24 H	107	62.27	40.23
2	*5260.00	88.9 AV			1.24 H	107	48.67	40.23
3	#10520.00	54.7 PK	68.3	-13.6	1.36 H	4	7.98	46.72
ANTENNA POLARITY & TEST DISTANCE: VERTICAL AT 3 M								
NO.	FREQ. (MHz)	EMISSION LEVEL (dBuV/m)	LIMIT (dBuV/m)	MARGIN (dB)	ANTENNA HEIGHT (m)	TABLE ANGLE (Degree)	RAW VALUE (dBuV)	CORRECTION FACTOR (dB/m)
1	*5260.00	114.6 PK			1.19 V	111	74.37	40.23
2	*5260.00	100.1 AV			1.19 V	111	59.87	40.23
3	#10520.00	57.2 PK	68.3	-11.1	1.37 V	316	10.48	46.72

- REMARKS:**
1. Emission level (dBuV/m) = Raw Value (dBuV) + Correction Factor (dB/m).
  2. Correction Factor (dB/m) = Antenna Factor (dB/m) + Cable Factor (dB).
  3. The other emission levels were very low against the limit.
  4. Margin value = Emission level – Limit value.
  5. “ \* “: Fundamental frequency.
  6. “ # “: The radiated frequency is out the restricted band.





A D T

EUT TEST CONDITION		MEASUREMENT DETAIL	
CHANNEL	Channel 60	FREQUENCY RANGE	1 ~ 40GHz
INPUT POWER	DC 3.3V	DETECTOR FUNCTION	Peak (PK) Average (AV)
ENVIRONMENTAL CONDITIONS	21deg. C, 66%RH	TESTED BY	Kent Liu

ANTENNA POLARITY & TEST DISTANCE: HORIZONTAL AT 3 M								
NO.	FREQ. (MHz)	EMISSION LEVEL (dBuV/m)	LIMIT (dBuV/m)	MARGIN (dB)	ANTENNA HEIGHT (m)	TABLE ANGLE (Degree)	RAW VALUE (dBuV)	CORRECTION FACTOR (dB/m)
1	*5300.00	102.3 PK			1.27 H	118	61.97	40.33
2	*5300.00	88.7 AV			1.27 H	118	48.37	40.33
3	10600.00	56.8 PK	74.0	-17.2	1.34 H	16	9.98	46.82
4	10600.00	44.9 AV	54.0	-9.1	1.34 H	16	-1.92	46.82
ANTENNA POLARITY & TEST DISTANCE: VERTICAL AT 3 M								
NO.	FREQ. (MHz)	EMISSION LEVEL (dBuV/m)	LIMIT (dBuV/m)	MARGIN (dB)	ANTENNA HEIGHT (m)	TABLE ANGLE (Degree)	RAW VALUE (dBuV)	CORRECTION FACTOR (dB/m)
1	*5300.00	114.9 PK			1.24 V	105	74.57	40.33
2	*5300.00	100.2 AV			1.24 V	105	59.87	40.33
3	10600.00	57.2 PK	74.0	-16.8	1.39 V	321	10.38	46.82
4	10600.00	45.8 AV	54.0	-8.2	1.39 V	321	-1.02	46.82

- REMARKS:**
1. Emission level (dBuV/m) = Raw Value (dBuV) + Correction Factor (dB/m).
  2. Correction Factor (dB/m) = Antenna Factor (dB/m) + Cable Factor (dB).
  3. The other emission levels were very low against the limit.
  4. Margin value = Emission level – Limit value.
  5. “ \* ”: Fundamental frequency.



A D T

EUT TEST CONDITION		MEASUREMENT DETAIL	
CHANNEL	Channel 64	FREQUENCY RANGE	1 ~ 40GHz
INPUT POWER	DC 3.3V	DETECTOR FUNCTION	Peak (PK) Average (AV)
ENVIRONMENTAL CONDITIONS	21deg. C, 66%RH	TESTED BY	Kent Liu

ANTENNA POLARITY & TEST DISTANCE: HORIZONTAL AT 3 M								
NO.	FREQ. (MHz)	EMISSION LEVEL (dBuV/m)	LIMIT (dBuV/m)	MARGIN (dB)	ANTENNA HEIGHT (m)	TABLE ANGLE (Degree)	RAW VALUE (dBuV)	CORRECTION FACTOR (dB/m)
1	*5320.00	100.1 PK			1.12 H	67	59.71	40.39
2	*5320.00	86.7 AV			1.12 H	67	46.31	40.39
3	5350.00	59.8 PK	74.0	-14.2	1.06 H	76	19.33	40.47
4	5350.00	47.0 AV	54.0	-7.0	1.06 H	76	6.53	40.47
5	10640.00	55.9 PK	74.0	-18.1	1.46 H	308	9.03	46.87
6	10640.00	44.6 AV	54.0	-9.4	1.46 H	308	-2.27	46.87
ANTENNA POLARITY & TEST DISTANCE: VERTICAL AT 3 M								
NO.	FREQ. (MHz)	EMISSION LEVEL (dBuV/m)	LIMIT (dBuV/m)	MARGIN (dB)	ANTENNA HEIGHT (m)	TABLE ANGLE (Degree)	RAW VALUE (dBuV)	CORRECTION FACTOR (dB/m)
1	*5320.00	112.2 PK			1.00 V	132	71.81	40.39
2	*5320.00	97.8 AV			1.00 V	132	57.41	40.39
3	5350.00	68.2 PK	74.0	-5.8	1.00 V	133	27.73	40.47
4	<b>5350.00</b>	<b>52.9 AV</b>	<b>54.0</b>	<b>-1.1</b>	<b>1.00 V</b>	<b>133</b>	<b>12.43</b>	<b>40.47</b>
5	10640.00	56.5 PK	74.0	-17.5	1.43 V	320	9.63	46.87
6	10640.00	45.1 AV	54.0	-8.9	1.43 V	320	-1.77	46.87

- REMARKS:**
1. Emission level (dBuV/m) = Raw Value (dBuV) + Correction Factor (dB/m).
  2. Correction Factor (dB/m) = Antenna Factor (dB/m) + Cable Factor (dB).
  3. The other emission levels were very low against the limit.
  4. Margin value = Emission level – Limit value.
  5. “ \* “: Fundamental frequency.



A D T

EUT TEST CONDITION		MEASUREMENT DETAIL	
CHANNEL	Channel 100	FREQUENCY RANGE	1 ~ 40GHz
INPUT POWER	DC 3.3V	DETECTOR FUNCTION	Peak (PK) Average (AV)
ENVIRONMENTAL CONDITIONS	21deg. C, 66%RH	TESTED BY	Kent Liu

**ANTENNA POLARITY & TEST DISTANCE: HORIZONTAL AT 3 M**

NO.	FREQ. (MHz)	EMISSION LEVEL (dBuV/m)	LIMIT (dBuV/m)	MARGIN (dB)	ANTENNA HEIGHT (m)	TABLE ANGLE (Degree)	RAW VALUE (dBuV)	CORRECTION FACTOR (dB/m)
1	5460.00	57.9 PK	74.0	-16.1	1.04 H	107	17.14	40.76
2	5460.00	45.7 AV	54.0	-8.3	1.04 H	107	4.94	40.76
3	#5470.00	58.3 PK	68.3	-10.0	1.03 H	114	17.52	40.78
4	*5500.00	94.9 PK			1.04 H	107	54.04	40.86
5	*5500.00	82.6 AV			1.04 H	107	41.74	40.86
6	11000.00	56.4 PK	74.0	-17.6	1.37 H	338	9.12	47.28
7	11000.00	44.9 AV	54.0	-9.1	1.37 H	338	-2.38	47.28
8	#16500.00	63.0 PK	68.3	-5.3	1.25 H	184	9.97	53.03

**ANTENNA POLARITY & TEST DISTANCE: VERTICAL AT 3 M**

NO.	FREQ. (MHz)	EMISSION LEVEL (dBuV/m)	LIMIT (dBuV/m)	MARGIN (dB)	ANTENNA HEIGHT (m)	TABLE ANGLE (Degree)	RAW VALUE (dBuV)	CORRECTION FACTOR (dB/m)
1	5460.00	61.8 PK	74.0	-12.2	1.00 V	68	21.04	40.76
2	5460.00	47.4 AV	54.0	-6.6	1.00 V	68	6.64	40.76
3	#5470.00	66.8 PK	68.3	-1.5	1.00 V	68	26.02	40.78
4	*5500.00	109.1 PK			1.00 V	68	68.24	40.86
5	*5500.00	94.3 AV			1.00 V	68	53.44	40.86
6	11000.00	56.3 PK	74.0	-17.7	1.37 V	343	9.02	47.28
7	11000.00	44.9 AV	54.0	-9.1	1.37 V	343	-2.38	47.28
8	#16500.00	63.4 PK	68.3	-4.9	1.22 V	187	10.37	53.03

- REMARKS:**
1. Emission level (dBuV/m) = Raw Value (dBuV) + Correction Factor (dB/m).
  2. Correction Factor (dB/m) = Antenna Factor (dB/m) + Cable Factor (dB).
  3. The other emission levels were very low against the limit.
  4. Margin value = Emission level – Limit value.
  5. “ \* “: Fundamental frequency.
  6. “#”:The radiated frequency is out the restricted band.



A D T

EUT TEST CONDITION		MEASUREMENT DETAIL	
CHANNEL	Channel 116	FREQUENCY RANGE	1 ~ 40GHz
INPUT POWER	DC 3.3V	DETECTOR FUNCTION	Peak (PK) Average (AV)
ENVIRONMENTAL CONDITIONS	21deg. C, 66%RH	TESTED BY	Kent Liu

ANTENNA POLARITY & TEST DISTANCE: HORIZONTAL AT 3 M								
NO.	FREQ. (MHz)	EMISSION LEVEL (dBuV/m)	LIMIT (dBuV/m)	MARGIN (dB)	ANTENNA HEIGHT (m)	TABLE ANGLE (Degree)	RAW VALUE (dBuV)	CORRECTION FACTOR (dB/m)
1	*5580.00	102.1 PK			1.26 H	114	61.01	41.09
2	*5580.00	88.7 AV			1.26 H	114	47.61	41.09
3	11160.00	56.6 PK	74.0	-17.4	1.34 H	358	9.21	47.39
4	11160.00	45.3 AV	54.0	-8.7	1.34 H	358	-2.09	47.39
5	#16740.00	64.2 PK	68.3	-4.1	1.31 H	188	10.71	53.49
ANTENNA POLARITY & TEST DISTANCE: VERTICAL AT 3 M								
NO.	FREQ. (MHz)	EMISSION LEVEL (dBuV/m)	LIMIT (dBuV/m)	MARGIN (dB)	ANTENNA HEIGHT (m)	TABLE ANGLE (Degree)	RAW VALUE (dBuV)	CORRECTION FACTOR (dB/m)
1	*5580.00	115.6 PK			1.21 V	55	74.51	41.09
2	*5580.00	100.7 AV			1.21 V	55	59.61	41.09
3	11160.00	56.4 PK	74.0	-17.6	1.35 V	351	9.01	47.39
4	11160.00	45.1 AV	54.0	-8.9	1.35 V	351	-2.29	47.39
5	#16740.00	64.3 PK	68.3	-4.0	1.19 V	200	10.81	53.49

- REMARKS:**
1. Emission level (dBuV/m) = Raw Value (dBuV) + Correction Factor (dB/m).
  2. Correction Factor (dB/m) = Antenna Factor (dB/m) + Cable Factor (dB).
  3. The other emission levels were very low against the limit.
  4. Margin value = Emission level – Limit value.
  5. “ \* “: Fundamental frequency.
  6. "#":The radiated frequency is out the restricted band.



A D T

EUT TEST CONDITION		MEASUREMENT DETAIL	
CHANNEL	Channel 132	FREQUENCY RANGE	1 ~ 40GHz
INPUT POWER	DC 3.3V	DETECTOR FUNCTION	Peak (PK) Average (AV)
ENVIRONMENTAL CONDITIONS	21deg. C, 66%RH	TESTED BY	Kent Liu

**ANTENNA POLARITY & TEST DISTANCE: HORIZONTAL AT 3 M**

NO.	FREQ. (MHz)	EMISSION LEVEL (dBuV/m)	LIMIT (dBuV/m)	MARGIN (dB)	ANTENNA HEIGHT (m)	TABLE ANGLE (Degree)	RAW VALUE (dBuV)	CORRECTION FACTOR (dB/m)
1	*5660.00	102.0 PK			1.25 H	125	60.69	41.31
2	*5660.00	88.5 AV			1.25 H	125	47.19	41.31
3	11320.00	55.2 PK	74.0	-18.8	1.36 H	10	7.65	47.55
4	11320.00	44.6 AV	54.0	-9.4	1.36 H	10	-2.95	47.55
5	#16980.00	63.9 PK	68.3	-4.4	1.20 H	80	9.88	54.02

**ANTENNA POLARITY & TEST DISTANCE: VERTICAL AT 3 M**

NO.	FREQ. (MHz)	EMISSION LEVEL (dBuV/m)	LIMIT (dBuV/m)	MARGIN (dB)	ANTENNA HEIGHT (m)	TABLE ANGLE (Degree)	RAW VALUE (dBuV)	CORRECTION FACTOR (dB/m)
1	*5660.00	115.4 PK			1.24 V	64	74.09	41.31
2	*5660.00	100.8 AV			1.24 V	64	59.49	41.31
3	11320.00	56.3 PK	74.0	-17.7	1.46 V	290	8.75	47.55
4	11320.00	45.1 AV	54.0	-8.9	1.46 V	290	-2.45	47.55
5	#16980.00	65.0 PK	68.3	-3.3	1.18 V	197	10.98	54.02

- REMARKS:**
1. Emission level (dBuV/m) = Raw Value (dBuV) + Correction Factor (dB/m).
  2. Correction Factor (dB/m) = Antenna Factor (dB/m) + Cable Factor (dB).
  3. The other emission levels were very low against the limit.
  4. Margin value = Emission level – Limit value.
  5. “ \* “: Fundamental frequency.
  6. “#”:The radiated frequency is out the restricted band.



A D T

EUT TEST CONDITION		MEASUREMENT DETAIL	
CHANNEL	Channel 140	FREQUENCY RANGE	1 ~ 40GHz
INPUT POWER	DC 3.3V	DETECTOR FUNCTION	Peak (PK) Average (AV)
ENVIRONMENTAL CONDITIONS	21deg. C, 66%RH	TESTED BY	Kent Liu

**ANTENNA POLARITY & TEST DISTANCE: HORIZONTAL AT 3 M**

NO.	FREQ. (MHz)	EMISSION LEVEL (dBuV/m)	LIMIT (dBuV/m)	MARGIN (dB)	ANTENNA HEIGHT (m)	TABLE ANGLE (Degree)	RAW VALUE (dBuV)	CORRECTION FACTOR (dB/m)
1	*5700.00	94.3 PK			1.47 H	77	52.88	41.42
2	*5700.00	81.7 AV			1.47 H	77	40.28	41.42
3	#5725.00	58.3 PK	68.3	-10.0	1.51 H	81	16.81	41.49
4	11400.00	55.2 PK	74.0	-18.8	1.31 H	10	7.58	47.62
5	11400.00	44.5 AV	54.0	-9.5	1.31 H	10	-3.12	47.62
6	#17100.00	64.1 PK	68.3	-4.2	1.21 H	90	9.90	54.20

**ANTENNA POLARITY & TEST DISTANCE: VERTICAL AT 3 M**

NO.	FREQ. (MHz)	EMISSION LEVEL (dBuV/m)	LIMIT (dBuV/m)	MARGIN (dB)	ANTENNA HEIGHT (m)	TABLE ANGLE (Degree)	RAW VALUE (dBuV)	CORRECTION FACTOR (dB/m)
1	*5700.00	109.5 PK			1.19 V	16	68.08	41.42
2	*5700.00	95.0 AV			1.19 V	16	53.58	41.42
3	#5725.00	67.0 PK	68.3	-1.3	1.19 V	16	25.51	41.49
4	11400.00	55.7 PK	74.0	-18.3	1.41 V	302	8.08	47.62
5	11400.00	44.8 AV	54.0	-9.2	1.41 V	302	-2.82	47.62
6	#17100.00	64.4 PK	68.3	-3.9	1.22 V	182	10.20	54.20

- REMARKS:**
1. Emission level (dBuV/m) = Raw Value (dBuV) + Correction Factor (dB/m).
  2. Correction Factor (dB/m) = Antenna Factor (dB/m) + Cable Factor (dB).
  3. The other emission levels were very low against the limit.
  4. Margin value = Emission level – Limit value.
  5. “ \* “: Fundamental frequency.
  6. “#”:The radiated frequency is out the restricted band.



A D T

RESTRICTED BANDEDGE (802.11a MODE, CH36, HORIZONTAL)

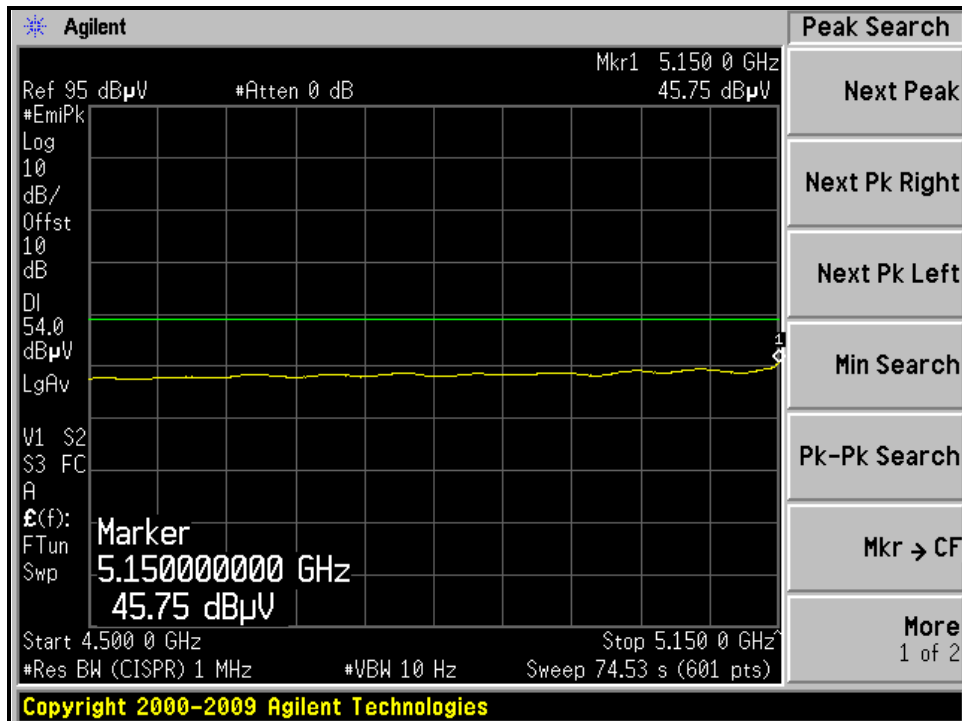
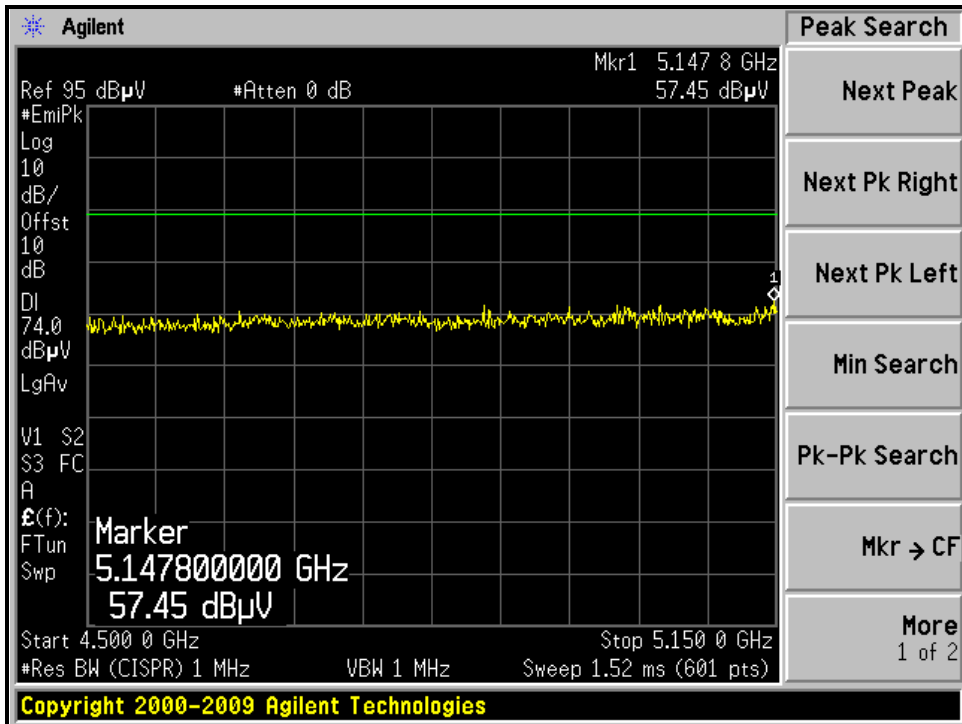



A D T

RESTRICTED BANDEDGE (802.11a MODE, CH36, VERTICAL)

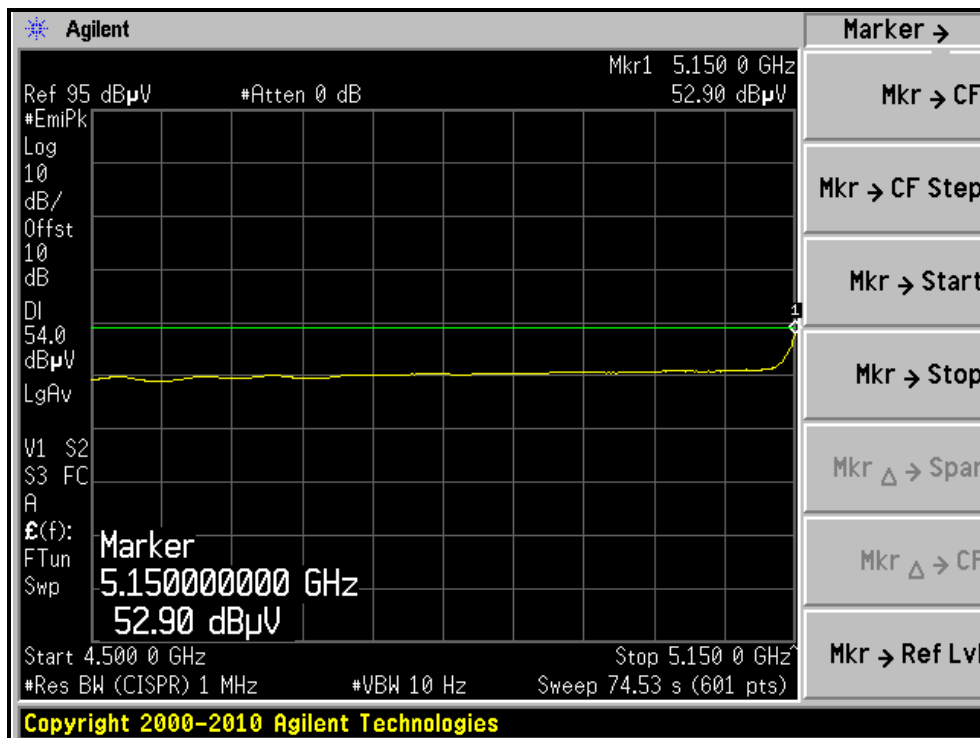
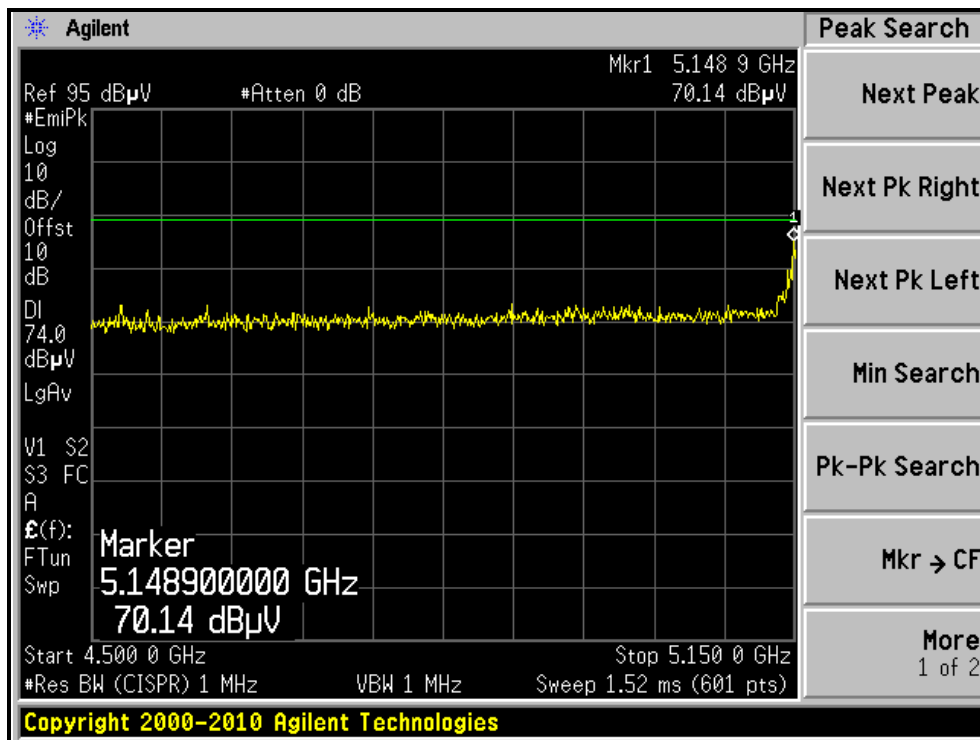





A D T

RESTRICTED BANDEDGE (802.11a MODE, CH64, HORIZONTAL)

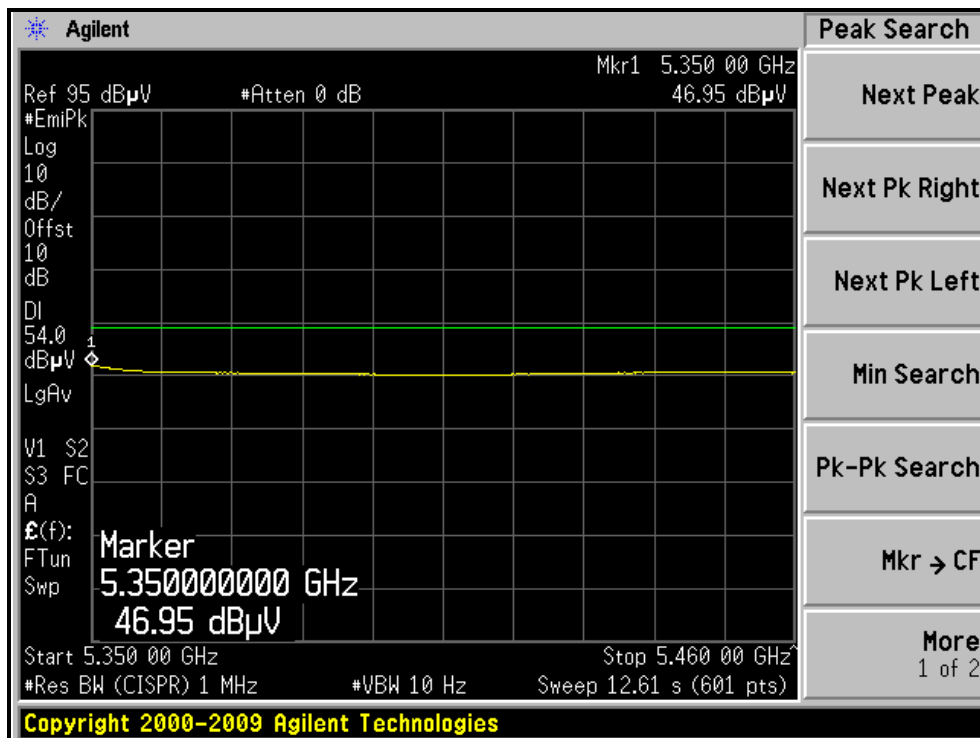
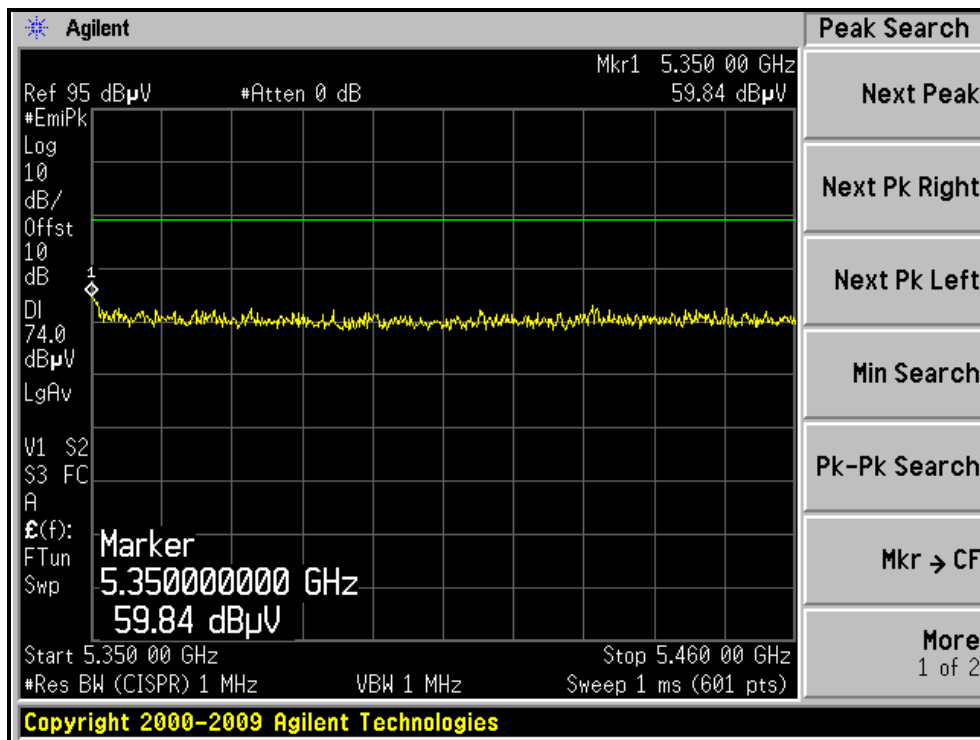



A D T

RESTRICTED BANDEDGE (802.11a MODE, CH64, VERTICAL)

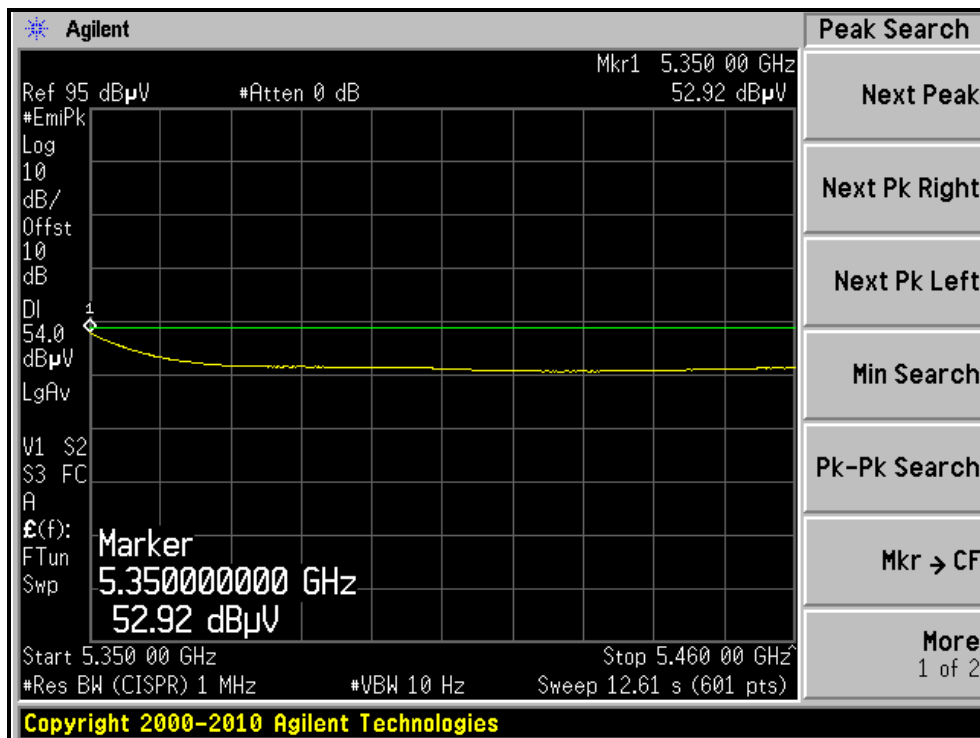
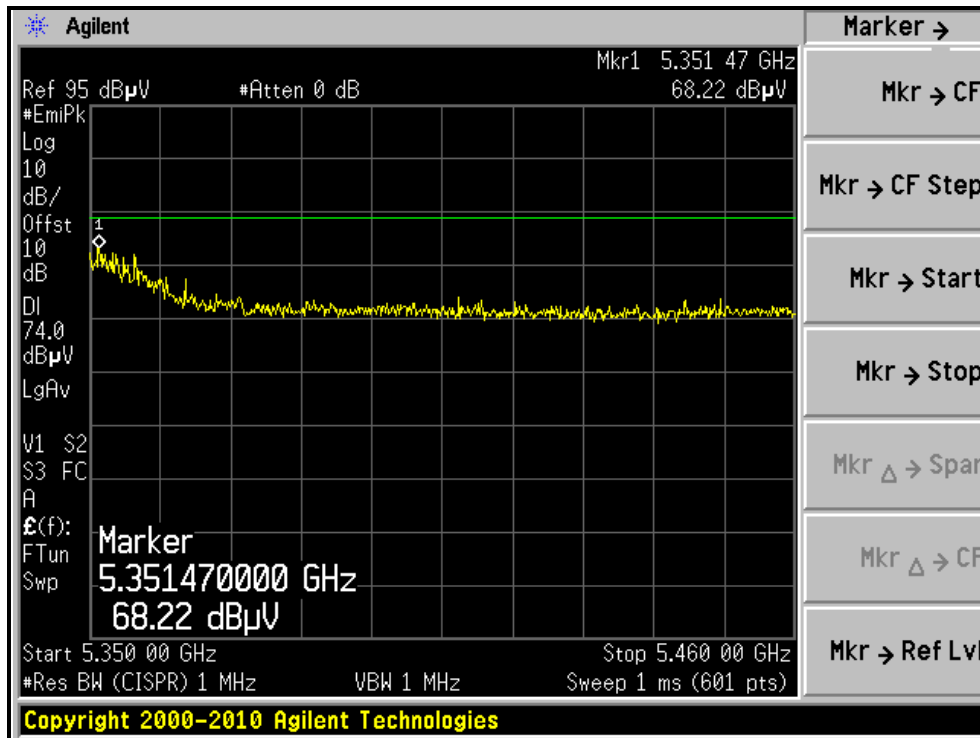



A D T

RESTRICTED BANDEDGE (802.11a MODE, CH100, HORIZONTAL)

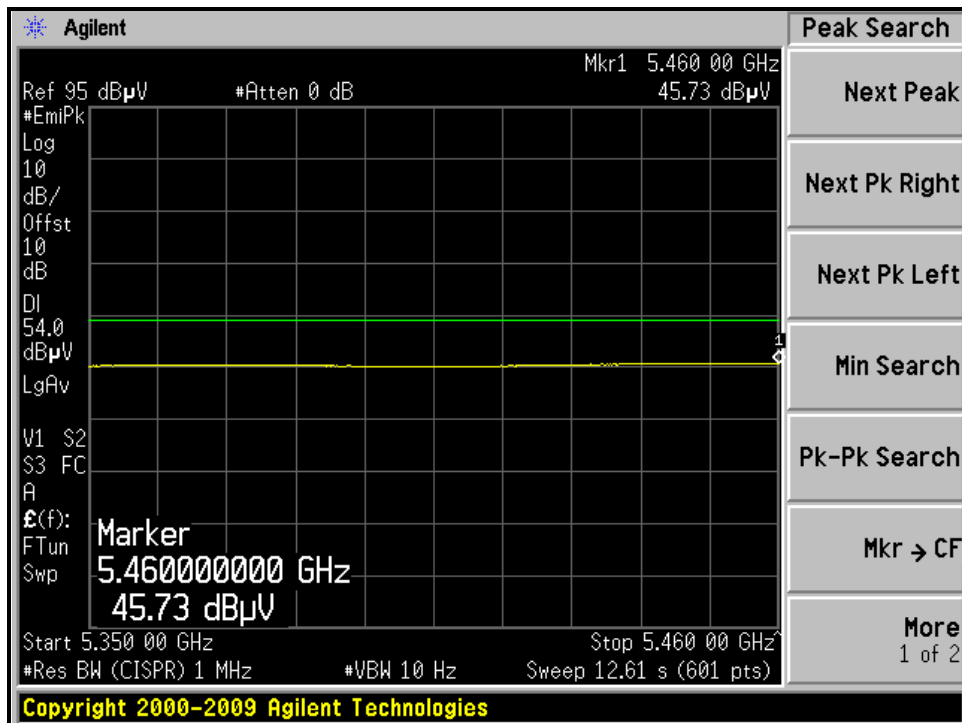
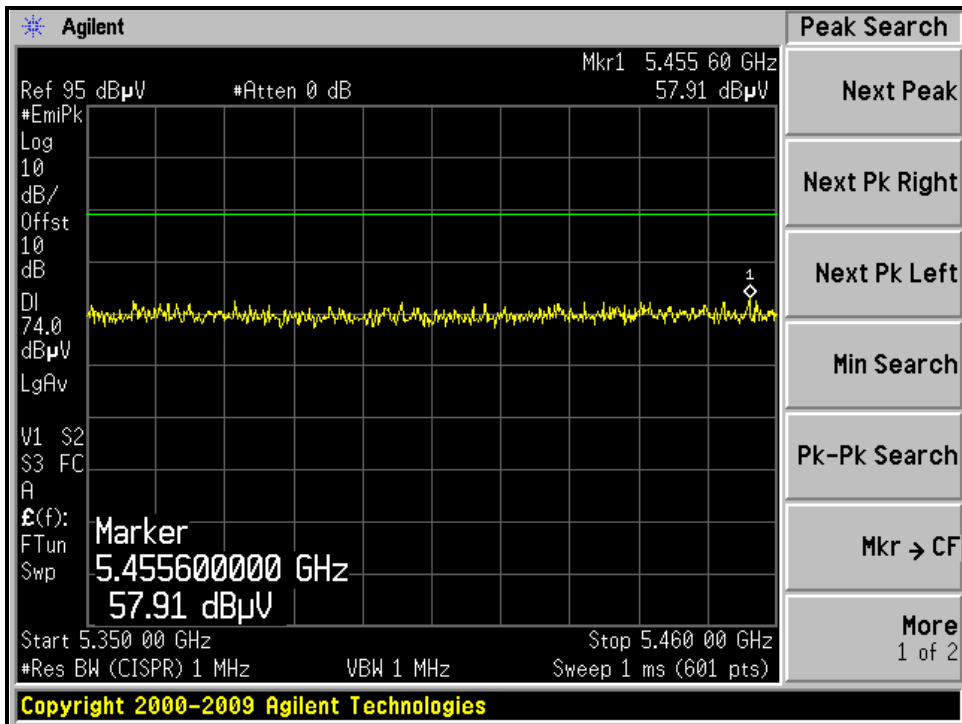

RESTRICTED BANDEDGE (802.11a MODE, CH100, VERTICAL)

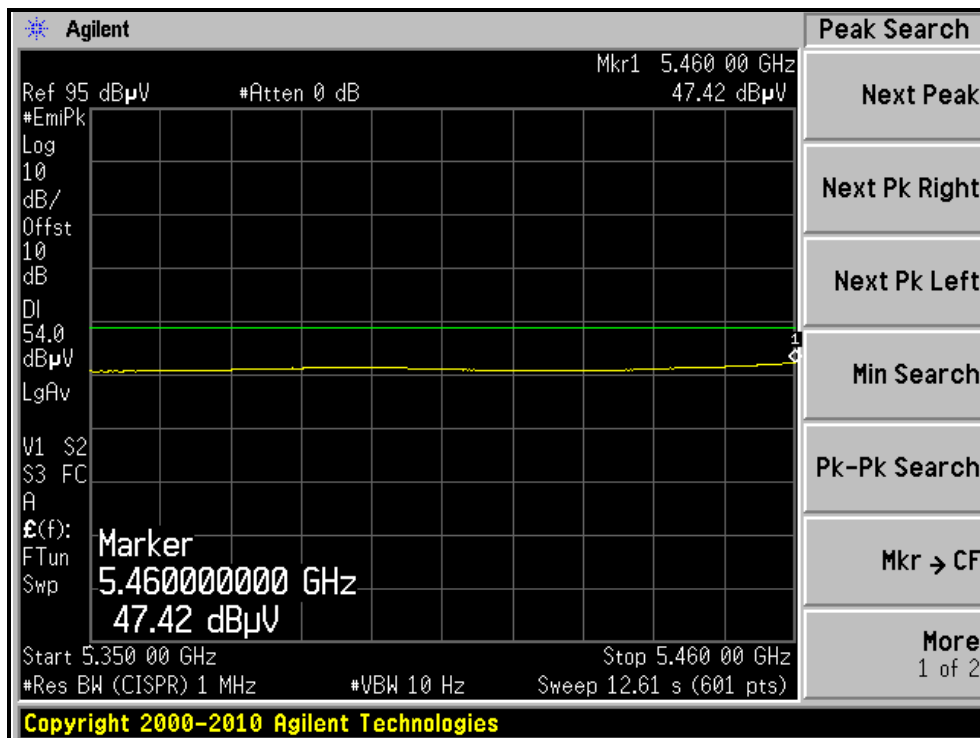
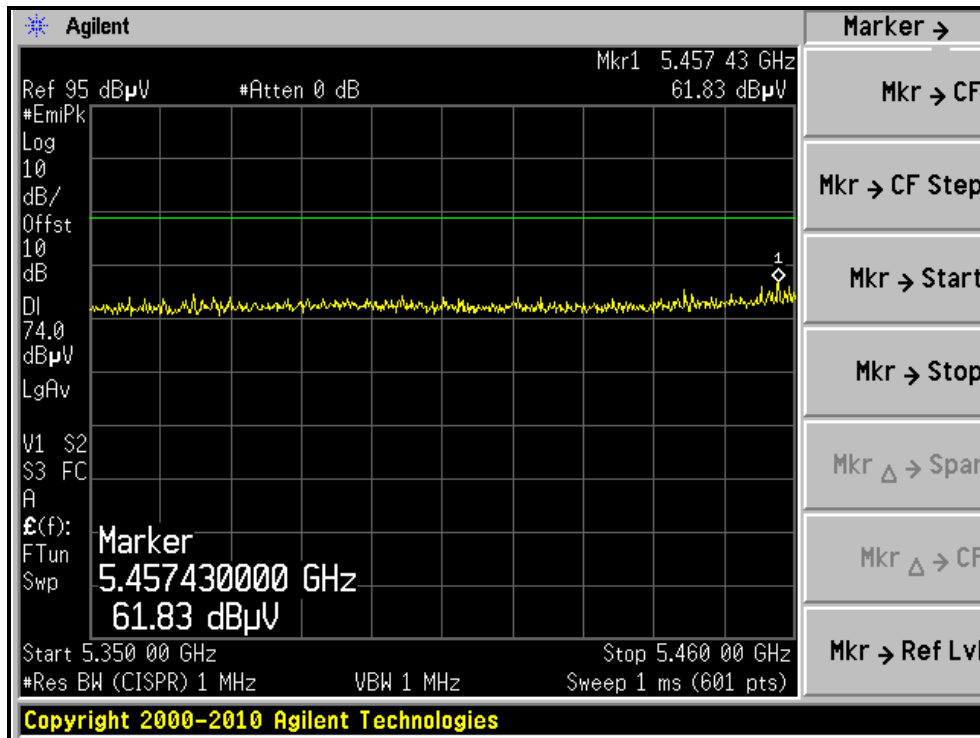



A D T

**802.11n (20MHz) OFDM MODULATION**

EUT TEST CONDITION		MEASUREMENT DETAIL	
CHANNEL	Channel 36	FREQUENCY RANGE	1 ~ 40GHz
INPUT POWER	DC 3.3V	DETECTOR FUNCTION	Peak (PK) Average (AV)
ENVIRONMENTAL CONDITIONS	21deg. C, 66%RH	TESTED BY	Kent Liu

ANTENNA POLARITY & TEST DISTANCE: HORIZONTAL AT 3 M								
NO.	FREQ. (MHz)	EMISSION LEVEL (dBuV/m)	LIMIT (dBuV/m)	MARGIN (dB)	ANTENNA HEIGHT (m)	TABLE ANGLE (Degree)	RAW VALUE (dBuV)	CORRECTION FACTOR (dB/m)
1	5150.00	57.8 PK	74.0	-16.2	1.25 H	90	17.86	39.94
2	5150.00	46.3 AV	54.0	-7.7	1.25 H	90	6.36	39.94
3	*5180.00	100.0 PK			1.24 H	88	59.98	40.02
4	*5180.00	85.6 AV			1.24 H	88	45.58	40.02
5	#10360.00	56.0 PK	68.3	-12.3	1.26 H	11	9.47	46.53
ANTENNA POLARITY & TEST DISTANCE: VERTICAL AT 3 M								
NO.	FREQ. (MHz)	EMISSION LEVEL (dBuV/m)	LIMIT (dBuV/m)	MARGIN (dB)	ANTENNA HEIGHT (m)	TABLE ANGLE (Degree)	RAW VALUE (dBuV)	CORRECTION FACTOR (dB/m)
1	5150.00	68.8 PK	74.0	-5.2	1.00 V	129	28.86	39.94
2	5150.00	52.4 AV	54.0	-1.6	1.00 V	129	12.46	39.94
3	*5180.00	111.2 PK			1.00 V	129	71.18	40.02
4	*5180.00	96.6 AV			1.00 V	129	56.58	40.02
5	#10360.00	56.4 PK	68.3	-11.9	1.40 V	297	9.87	46.53

- REMARKS:**
1. Emission level (dBuV/m) = Raw Value (dBuV) + Correction Factor (dB/m).
  2. Correction Factor (dB/m) = Antenna Factor (dB/m) + Cable Factor (dB).
  3. The other emission levels were very low against the limit.
  4. Margin value = Emission level – Limit value.
  5. “ \* “: Fundamental frequency.
  6. “#”:The radiated frequency is out the restricted band.



A D T

EUT TEST CONDITION		MEASUREMENT DETAIL	
CHANNEL	Channel 40	FREQUENCY RANGE	1 ~ 40GHz
INPUT POWER	DC 3.3V	DETECTOR FUNCTION	Peak (PK) Average (AV)
ENVIRONMENTAL CONDITIONS	21deg. C, 66%RH	TESTED BY	Kent Liu

ANTENNA POLARITY & TEST DISTANCE: HORIZONTAL AT 3 M								
NO.	FREQ. (MHz)	EMISSION LEVEL (dBuV/m)	LIMIT (dBuV/m)	MARGIN (dB)	ANTENNA HEIGHT (m)	TABLE ANGLE (Degree)	RAW VALUE (dBuV)	CORRECTION FACTOR (dB/m)
1	*5200.00	100.4 PK			1.20 H	89	60.33	40.07
2	*5200.00	85.9 AV			1.20 H	89	45.83	40.07
3	#10400.00	56.4 PK	68.3	-11.9	1.28 H	6	9.83	46.57
ANTENNA POLARITY & TEST DISTANCE: VERTICAL AT 3 M								
NO.	FREQ. (MHz)	EMISSION LEVEL (dBuV/m)	LIMIT (dBuV/m)	MARGIN (dB)	ANTENNA HEIGHT (m)	TABLE ANGLE (Degree)	RAW VALUE (dBuV)	CORRECTION FACTOR (dB/m)
1	*5200.00	111.0 PK			1.00 V	169	70.93	40.07
2	*5200.00	95.6 AV			1.00 V	169	55.53	40.07
3	#10400.00	56.7 PK	68.3	-11.6	1.36 V	353	10.13	46.57

- REMARKS:**
1. Emission level (dBuV/m) = Raw Value (dBuV) + Correction Factor (dB/m).
  2. Correction Factor (dB/m) = Antenna Factor (dB/m) + Cable Factor (dB).
  3. The other emission levels were very low against the limit.
  4. Margin value = Emission level – Limit value.
  5. “ \* “: Fundamental frequency.
  6. “ # “: The radiated frequency is out the restricted band.



A D T

EUT TEST CONDITION		MEASUREMENT DETAIL	
CHANNEL	Channel 48	FREQUENCY RANGE	1 ~ 40GHz
INPUT POWER	DC 3.3V	DETECTOR FUNCTION	Peak (PK) Average (AV)
ENVIRONMENTAL CONDITIONS	21deg. C, 66%RH	TESTED BY	Kent Liu

ANTENNA POLARITY & TEST DISTANCE: HORIZONTAL AT 3 M								
NO.	FREQ. (MHz)	EMISSION LEVEL (dBuV/m)	LIMIT (dBuV/m)	MARGIN (dB)	ANTENNA HEIGHT (m)	TABLE ANGLE (Degree)	RAW VALUE (dBuV)	CORRECTION FACTOR (dB/m)
1	*5240.00	101.0 PK			1.19 H	88	60.83	40.17
2	*5240.00	86.3 AV			1.19 H	88	46.13	40.17
3	#10480.00	56.8 PK	68.3	-11.5	1.26 H	0	10.13	46.67
ANTENNA POLARITY & TEST DISTANCE: VERTICAL AT 3 M								
NO.	FREQ. (MHz)	EMISSION LEVEL (dBuV/m)	LIMIT (dBuV/m)	MARGIN (dB)	ANTENNA HEIGHT (m)	TABLE ANGLE (Degree)	RAW VALUE (dBuV)	CORRECTION FACTOR (dB/m)
1	*5240.00	110.9 PK			1.00 V	158	70.73	40.17
2	*5240.00	95.8 AV			1.00 V	158	55.63	40.17
3	#10480.00	57.0 PK	68.3	-11.3	1.39 V	307	10.33	46.67

- REMARKS:**
1. Emission level (dBuV/m) = Raw Value (dBuV) + Correction Factor (dB/m).
  2. Correction Factor (dB/m) = Antenna Factor (dB/m) + Cable Factor (dB).
  3. The other emission levels were very low against the limit.
  4. Margin value = Emission level – Limit value.
  5. “ \* “: Fundamental frequency.
  6. “ # “: The radiated frequency is out the restricted band.



A D T

EUT TEST CONDITION		MEASUREMENT DETAIL	
CHANNEL	Channel 52	FREQUENCY RANGE	1 ~ 40GHz
INPUT POWER	DC 3.3V	DETECTOR FUNCTION	Peak (PK) Average (AV)
ENVIRONMENTAL CONDITIONS	21deg. C, 66%RH	TESTED BY	Kent Liu

ANTENNA POLARITY & TEST DISTANCE: HORIZONTAL AT 3 M								
NO.	FREQ. (MHz)	EMISSION LEVEL (dBuV/m)	LIMIT (dBuV/m)	MARGIN (dB)	ANTENNA HEIGHT (m)	TABLE ANGLE (Degree)	RAW VALUE (dBuV)	CORRECTION FACTOR (dB/m)
1	*5260.00	103.1 PK			1.20 H	77	62.87	40.23
2	*5260.00	89.0 AV			1.20 H	77	48.77	40.23
3	#10520.00	56.9 PK	68.3	-11.4	1.34 H	9	10.18	46.72
ANTENNA POLARITY & TEST DISTANCE: VERTICAL AT 3 M								
NO.	FREQ. (MHz)	EMISSION LEVEL (dBuV/m)	LIMIT (dBuV/m)	MARGIN (dB)	ANTENNA HEIGHT (m)	TABLE ANGLE (Degree)	RAW VALUE (dBuV)	CORRECTION FACTOR (dB/m)
1	*5260.00	111.3 PK			1.00 V	143	71.07	40.23
2	*5260.00	96.7 AV			1.00 V	143	56.47	40.23
3	#10520.00	56.9 PK	68.3	-11.4	1.36 V	302	10.18	46.72

- REMARKS:**
1. Emission level (dBuV/m) = Raw Value (dBuV) + Correction Factor (dB/m).
  2. Correction Factor (dB/m) = Antenna Factor (dB/m) + Cable Factor (dB).
  3. The other emission levels were very low against the limit.
  4. Margin value = Emission level – Limit value.
  5. “ \* “: Fundamental frequency.
  6. “ # “: The radiated frequency is out the restricted band.





A D T

EUT TEST CONDITION		MEASUREMENT DETAIL	
CHANNEL	Channel 60	FREQUENCY RANGE	1 ~ 40GHz
INPUT POWER	DC 3.3V	DETECTOR FUNCTION	Peak (PK) Average (AV)
ENVIRONMENTAL CONDITIONS	21deg. C, 66%RH	TESTED BY	Kent Liu

ANTENNA POLARITY & TEST DISTANCE: HORIZONTAL AT 3 M								
NO.	FREQ. (MHz)	EMISSION LEVEL (dBuV/m)	LIMIT (dBuV/m)	MARGIN (dB)	ANTENNA HEIGHT (m)	TABLE ANGLE (Degree)	RAW VALUE (dBuV)	CORRECTION FACTOR (dB/m)
1	*5300.00	102.5 PK			1.18 H	72	62.17	40.33
2	*5300.00	88.6 AV			1.18 H	72	48.27	40.33
3	10600.00	56.5 PK	74.0	-17.5	1.38 H	32	9.68	46.82
4	10600.00	45.1 AV	54.0	-8.9	1.38 H	32	-1.72	46.82

ANTENNA POLARITY & TEST DISTANCE: VERTICAL AT 3 M								
NO.	FREQ. (MHz)	EMISSION LEVEL (dBuV/m)	LIMIT (dBuV/m)	MARGIN (dB)	ANTENNA HEIGHT (m)	TABLE ANGLE (Degree)	RAW VALUE (dBuV)	CORRECTION FACTOR (dB/m)
1	*5300.00	111.4 PK			1.00 V	144	71.07	40.33
2	*5300.00	96.4 AV			1.00 V	144	56.07	40.33
3	10600.00	56.8 PK	74.0	-17.2	1.39 V	317	9.98	46.82
4	10600.00	45.1 AV	54.0	-8.9	1.39 V	317	-1.72	46.82

- REMARKS:**
1. Emission level (dBuV/m) = Raw Value (dBuV) + Correction Factor (dB/m).
  2. Correction Factor (dB/m) = Antenna Factor (dB/m) + Cable Factor (dB).
  3. The other emission levels were very low against the limit.
  4. Margin value = Emission level – Limit value.
  5. “ \* “: Fundamental frequency.



A D T

EUT TEST CONDITION		MEASUREMENT DETAIL	
CHANNEL	Channel 64	FREQUENCY RANGE	1 ~ 40GHz
INPUT POWER	DC 3.3V	DETECTOR FUNCTION	Peak (PK) Average (AV)
ENVIRONMENTAL CONDITIONS	21deg. C, 66%RH	TESTED BY	Kent Liu

ANTENNA POLARITY & TEST DISTANCE: HORIZONTAL AT 3 M								
NO.	FREQ. (MHz)	EMISSION LEVEL (dBuV/m)	LIMIT (dBuV/m)	MARGIN (dB)	ANTENNA HEIGHT (m)	TABLE ANGLE (Degree)	RAW VALUE (dBuV)	CORRECTION FACTOR (dB/m)
1	*5320.00	99.9 PK			1.06 H	75	59.51	40.39
2	*5320.00	85.8 AV			1.06 H	75	45.41	40.39
3	5350.00	59.9 PK	74.0	-14.1	1.06 H	76	19.43	40.47
4	5350.00	46.7 AV	54.0	-7.3	1.06 H	76	6.23	40.47
5	10640.00	56.0 PK	74.0	-18.0	1.32 H	19	9.13	46.87
6	10640.00	44.4 AV	54.0	-9.6	1.32 H	19	-2.47	46.87
ANTENNA POLARITY & TEST DISTANCE: VERTICAL AT 3 M								
NO.	FREQ. (MHz)	EMISSION LEVEL (dBuV/m)	LIMIT (dBuV/m)	MARGIN (dB)	ANTENNA HEIGHT (m)	TABLE ANGLE (Degree)	RAW VALUE (dBuV)	CORRECTION FACTOR (dB/m)
1	*5320.00	109.8 PK			1.00 V	132	69.41	40.39
2	*5320.00	94.6 AV			1.00 V	132	54.21	40.39
3	5350.00	66.2 PK	74.0	-7.8	1.00 V	132	25.73	40.47
4	5350.00	52.5 AV	54.0	-1.5	1.00 V	132	12.03	40.47
5	10640.00	56.1 PK	74.0	-17.9	1.33 V	308	9.23	46.87
6	10640.00	44.6 AV	54.0	-9.4	1.33 V	308	-2.27	46.87

- REMARKS:**
1. Emission level (dBuV/m) = Raw Value (dBuV) + Correction Factor (dB/m).
  2. Correction Factor (dB/m) = Antenna Factor (dB/m) + Cable Factor (dB).
  3. The other emission levels were very low against the limit.
  4. Margin value = Emission level – Limit value.
  5. “ \* “: Fundamental frequency.



A D T

EUT TEST CONDITION		MEASUREMENT DETAIL	
CHANNEL	Channel 100	FREQUENCY RANGE	1 ~ 40GHz
INPUT POWER	DC 3.3V	DETECTOR FUNCTION	Peak (PK) Average (AV)
ENVIRONMENTAL CONDITIONS	21deg. C, 66%RH	TESTED BY	Kent Liu

ANTENNA POLARITY & TEST DISTANCE: HORIZONTAL AT 3 M								
NO.	FREQ. (MHz)	EMISSION LEVEL (dBuV/m)	LIMIT (dBuV/m)	MARGIN (dB)	ANTENNA HEIGHT (m)	TABLE ANGLE (Degree)	RAW VALUE (dBuV)	CORRECTION FACTOR (dB/m)
1	5460.00	58.9 PK	74.0	-15.1	1.12 H	103	18.14	40.76
2	5460.00	45.7 AV	54.0	-8.3	1.12 H	103	4.94	40.76
3	#5470.00	59.4 PK	68.3	-8.9	1.04 H	100	18.62	40.78
4	*5500.00	96.1 PK			1.16 H	83	55.24	40.86
5	*5500.00	82.4 AV			1.16 H	83	41.54	40.86
6	11000.00	55.8 PK	74.0	-18.2	1.33 H	22	8.52	47.28
7	11000.00	44.2 AV	54.0	-9.8	1.33 H	22	-3.08	47.28
8	#16500.00	62.8 PK	68.3	-5.5	1.20 H	217	9.77	53.03
ANTENNA POLARITY & TEST DISTANCE: VERTICAL AT 3 M								
NO.	FREQ. (MHz)	EMISSION LEVEL (dBuV/m)	LIMIT (dBuV/m)	MARGIN (dB)	ANTENNA HEIGHT (m)	TABLE ANGLE (Degree)	RAW VALUE (dBuV)	CORRECTION FACTOR (dB/m)
1	5460.00	60.3 PK	74.0	-13.7	1.00 V	68	19.54	40.76
2	5460.00	47.5 AV	54.0	-6.5	1.00 V	68	6.74	40.76
3	#5470.00	66.9 PK	68.3	-1.4	1.00 V	68	26.12	40.78
4	*5500.00	108.6 PK			1.00 V	68	67.74	40.86
5	*5500.00	94.3 AV			1.00 V	68	53.44	40.86
6	11000.00	56.2 PK	74.0	-17.8	1.30 V	303	8.92	47.28
7	11000.00	44.7 AV	54.0	-9.3	1.30 V	303	-2.58	47.28
8	#16500.00	63.2 PK	68.3	-5.1	1.25 V	214	10.17	53.03

- REMARKS:**
1. Emission level (dBuV/m) = Raw Value (dBuV) + Correction Factor (dB/m).
  2. Correction Factor (dB/m) = Antenna Factor (dB/m) + Cable Factor (dB).
  3. The other emission levels were very low against the limit.
  4. Margin value = Emission level – Limit value.
  5. “ \* “: Fundamental frequency.
  6. “#”:The radiated frequency is out the restricted band.



A D T

EUT TEST CONDITION		MEASUREMENT DETAIL	
CHANNEL	Channel 116	FREQUENCY RANGE	1 ~ 40GHz
INPUT POWER	DC 3.3V	DETECTOR FUNCTION	Peak (PK) Average (AV)
ENVIRONMENTAL CONDITIONS	21deg. C, 66%RH	TESTED BY	Kent Liu

**ANTENNA POLARITY & TEST DISTANCE: HORIZONTAL AT 3 M**

NO.	FREQ. (MHz)	EMISSION LEVEL (dBuV/m)	LIMIT (dBuV/m)	MARGIN (dB)	ANTENNA HEIGHT (m)	TABLE ANGLE (Degree)	RAW VALUE (dBuV)	CORRECTION FACTOR (dB/m)
1	*5580.00	102.7 PK			1.25 H	82	61.61	41.09
2	*5580.00	88.8 AV			1.25 H	82	47.71	41.09
3	11160.00	55.8 PK	74.0	-18.2	1.28 H	11	8.41	47.39
4	11160.00	44.7 AV	54.0	-9.3	1.28 H	11	-2.69	47.39
5	#16740.00	63.6 PK	68.3	-4.7	1.22 H	210	10.11	53.49

**ANTENNA POLARITY & TEST DISTANCE: VERTICAL AT 3 M**

NO.	FREQ. (MHz)	EMISSION LEVEL (dBuV/m)	LIMIT (dBuV/m)	MARGIN (dB)	ANTENNA HEIGHT (m)	TABLE ANGLE (Degree)	RAW VALUE (dBuV)	CORRECTION FACTOR (dB/m)
1	*5580.00	111.5 PK			1.00 V	154	70.41	41.09
2	*5580.00	96.2 AV			1.00 V	154	55.11	41.09
3	11160.00	56.6 PK	74.0	-17.4	1.28 V	311	9.21	47.39
4	11160.00	44.7 AV	54.0	-9.3	1.28 V	311	-2.69	47.39
5	#16740.00	63.5 PK	68.3	-4.8	1.29 V	212	10.01	53.49

- REMARKS:**
1. Emission level (dBuV/m) = Raw Value (dBuV) + Correction Factor (dB/m).
  2. Correction Factor (dB/m) = Antenna Factor (dB/m) + Cable Factor (dB).
  3. The other emission levels were very low against the limit.
  4. Margin value = Emission level – Limit value.
  5. “ \* “: Fundamental frequency.
  6. “#”:The radiated frequency is out the restricted band.



A D T

EUT TEST CONDITION		MEASUREMENT DETAIL	
CHANNEL	Channel 132	FREQUENCY RANGE	1 ~ 40GHz
INPUT POWER	DC 3.3V	DETECTOR FUNCTION	Peak (PK) Average (AV)
ENVIRONMENTAL CONDITIONS	21deg. C, 66%RH	TESTED BY	Kent Liu

ANTENNA POLARITY & TEST DISTANCE: HORIZONTAL AT 3 M								
NO.	FREQ. (MHz)	EMISSION LEVEL (dBuV/m)	LIMIT (dBuV/m)	MARGIN (dB)	ANTENNA HEIGHT (m)	TABLE ANGLE (Degree)	RAW VALUE (dBuV)	CORRECTION FACTOR (dB/m)
1	*5660.00	103.2 PK			1.31 H	82	61.89	41.31
2	*5660.00	89.1 AV			1.31 H	82	47.79	41.31
3	11320.00	55.8 PK	74.0	-18.2	1.23 H	18	8.25	47.55
4	11320.00	44.9 AV	54.0	-9.1	1.23 H	18	-2.65	47.55
5	#16980.00	63.5 PK	68.3	-4.8	1.25 H	221	9.48	54.02

ANTENNA POLARITY & TEST DISTANCE: VERTICAL AT 3 M								
NO.	FREQ. (MHz)	EMISSION LEVEL (dBuV/m)	LIMIT (dBuV/m)	MARGIN (dB)	ANTENNA HEIGHT (m)	TABLE ANGLE (Degree)	RAW VALUE (dBuV)	CORRECTION FACTOR (dB/m)
1	*5660.00	110.9 PK			1.00 V	167	69.59	41.31
2	*5660.00	95.8 AV			1.00 V	167	54.49	41.31
3	11320.00	56.5 PK	74.0	-17.5	1.36 V	302	8.95	47.55
4	11320.00	45.3 AV	54.0	-8.7	1.36 V	302	-2.25	47.55
5	#16980.00	64.0 PK	68.3	-4.3	1.30 V	194	9.98	54.02

- REMARKS:**
1. Emission level (dBuV/m) = Raw Value (dBuV) + Correction Factor (dB/m).
  2. Correction Factor (dB/m) = Antenna Factor (dB/m) + Cable Factor (dB).
  3. The other emission levels were very low against the limit.
  4. Margin value = Emission level – Limit value.
  5. “ \* “: Fundamental frequency.
  6. "#":The radiated frequency is out the restricted band.

EUT TEST CONDITION		MEASUREMENT DETAIL	
CHANNEL	Channel 140	FREQUENCY RANGE	1 ~ 40GHz
INPUT POWER	DC 3.3V	DETECTOR FUNCTION	Peak (PK) Average (AV)
ENVIRONMENTAL CONDITIONS	21deg. C, 66%RH	TESTED BY	Kent Liu

ANTENNA POLARITY & TEST DISTANCE: HORIZONTAL AT 3 M								
NO.	FREQ. (MHz)	EMISSION LEVEL (dBuV/m)	LIMIT (dBuV/m)	MARGIN (dB)	ANTENNA HEIGHT (m)	TABLE ANGLE (Degree)	RAW VALUE (dBuV)	CORRECTION FACTOR (dB/m)
1	*5700.00	95.0 PK			1.51 H	77	53.58	41.42
2	*5700.00	81.9 AV			1.51 H	77	40.48	41.42
3	#5725.00	58.4 PK	68.3	-9.9	1.51 H	81	16.91	41.49
4	11400.00	55.2 PK	74.0	-18.8	1.28 H	319	7.58	47.62
5	11400.00	43.7 AV	54.0	-10.3	1.28 H	319	-3.92	47.62
6	#17100.00	62.7 PK	68.3	-5.6	1.25 H	33	8.50	54.20
ANTENNA POLARITY & TEST DISTANCE: VERTICAL AT 3 M								
NO.	FREQ. (MHz)	EMISSION LEVEL (dBuV/m)	LIMIT (dBuV/m)	MARGIN (dB)	ANTENNA HEIGHT (m)	TABLE ANGLE (Degree)	RAW VALUE (dBuV)	CORRECTION FACTOR (dB/m)
1	*5700.00	108.4 PK			1.18 V	15	66.98	41.42
2	*5700.00	94.2 AV			1.18 V	15	52.78	41.42
3	#5725.00	67.1 PK	68.3	-1.2	1.18 V	15	25.61	41.49
4	11400.00	55.4 PK	74.0	-18.6	1.31 V	310	7.78	47.62
5	11400.00	44.1 AV	54.0	-9.9	1.31 V	310	-3.52	47.62
6	#17100.00	63.6 PK	68.3	-4.7	1.30 V	209	9.40	54.20

- REMARKS:**
1. Emission level (dBuV/m) = Raw Value (dBuV) + Correction Factor (dB/m).
  2. Correction Factor (dB/m) = Antenna Factor (dB/m) + Cable Factor (dB).
  3. The other emission levels were very low against the limit.
  4. Margin value = Emission level – Limit value.
  5. “ \* “: Fundamental frequency.
  6. “#”:The radiated frequency is out the restricted band.

RESTRICTED BANDEDGE (802.11n (20MHz) MODE,CH36, HORIZONTAL )

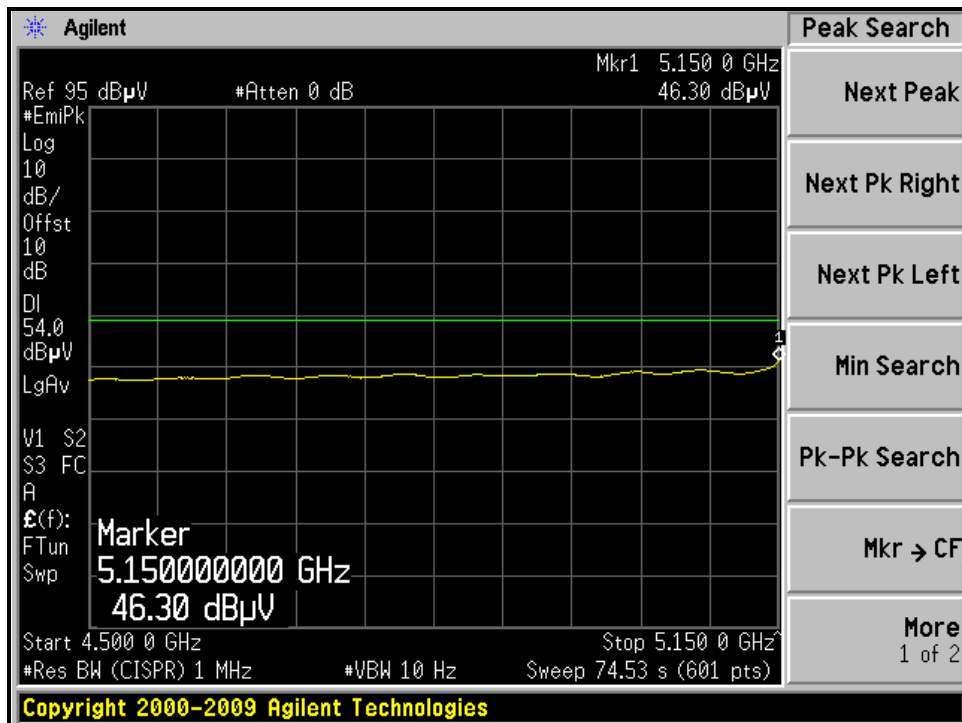
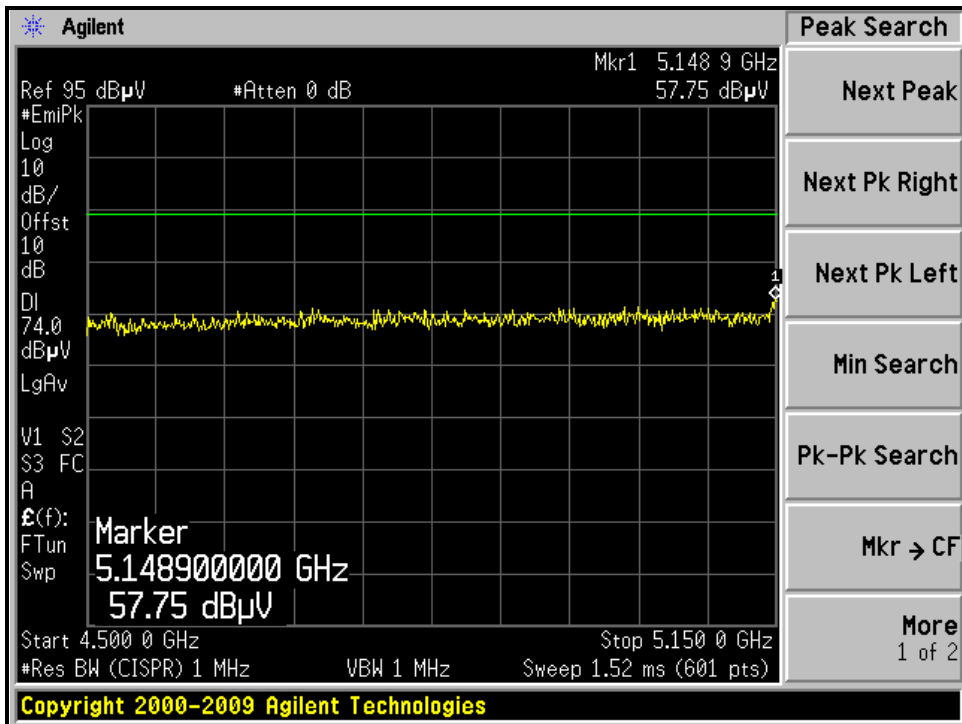

RESTRICTED BANDEDGE (802.11n (20MHz) MODE,CH36, VERTICAL )

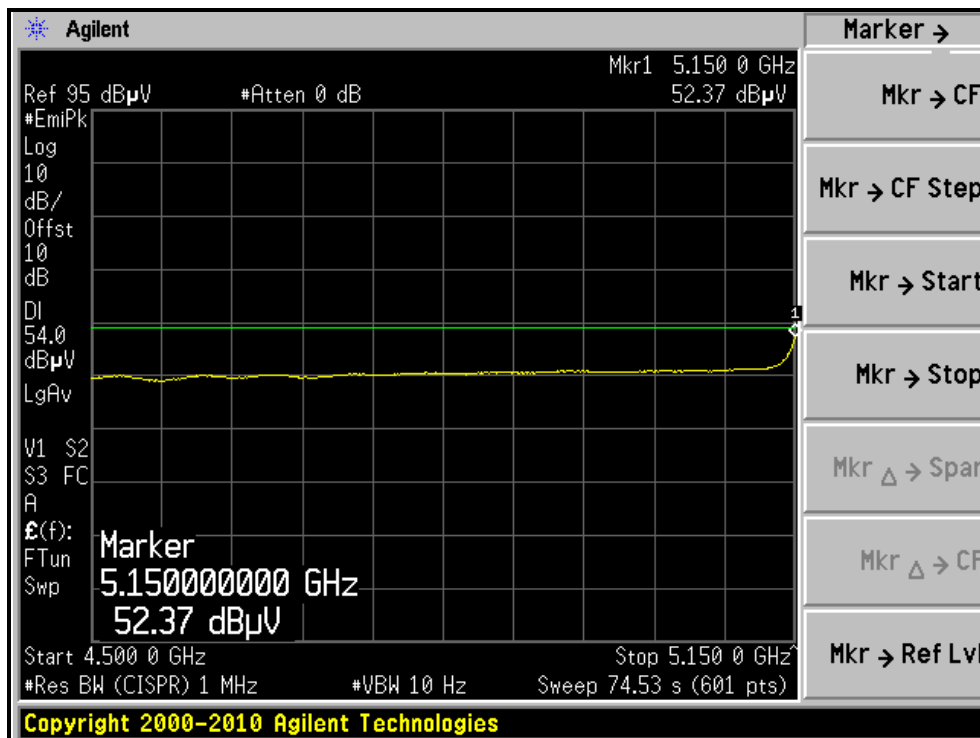
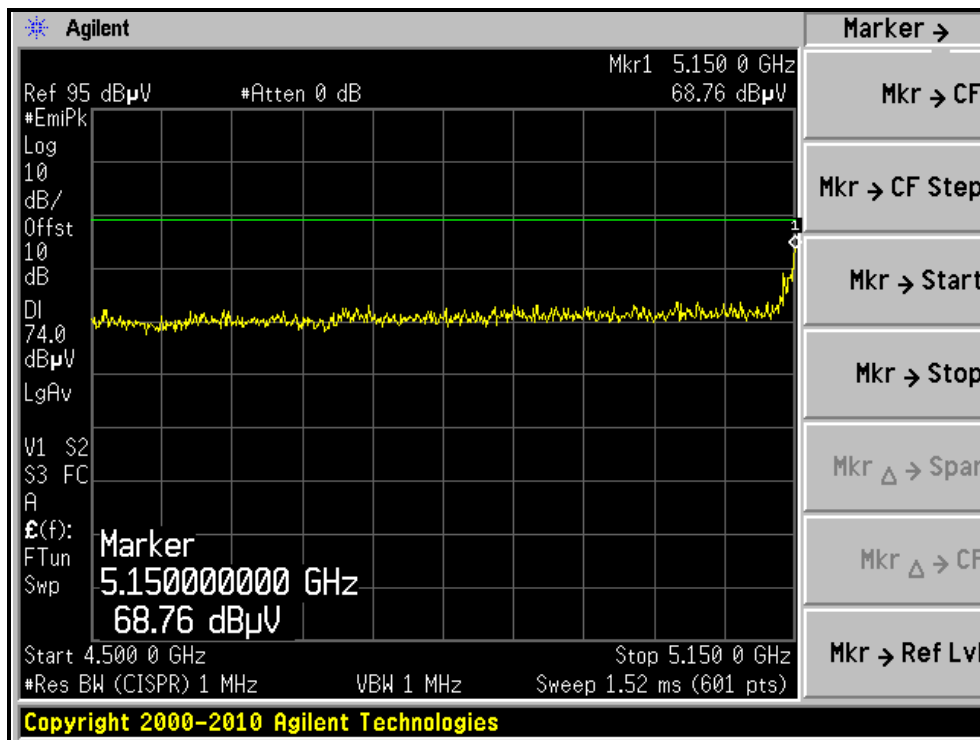





A D T

RESTRICTED BANDEDGE (802.11n (20MHz) MODE,CH 64, HORIZONTAL )

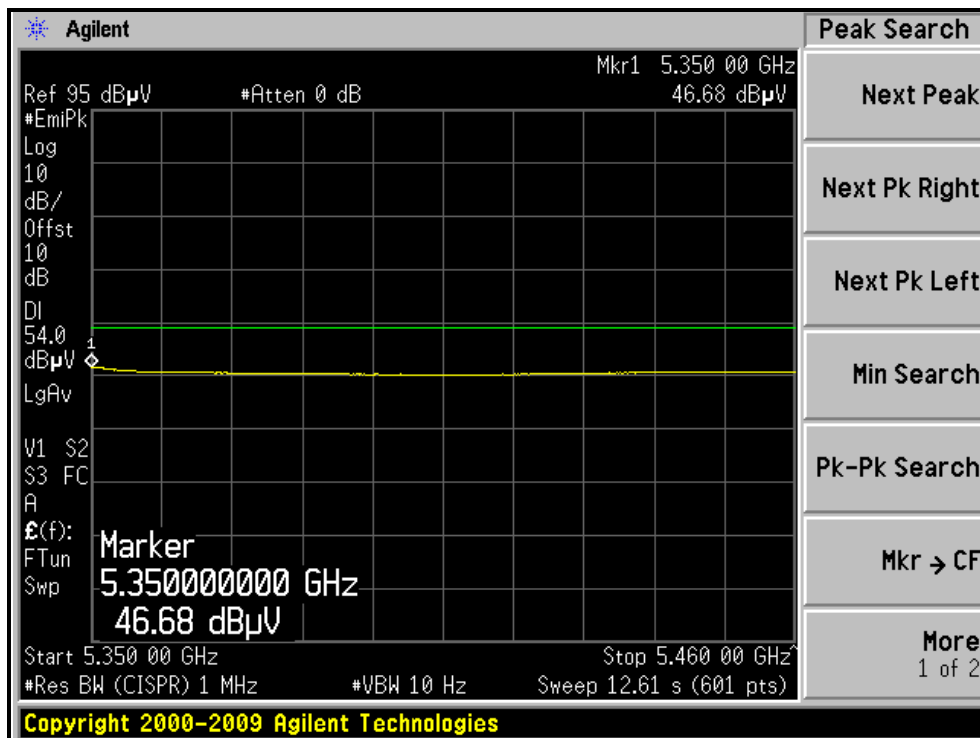
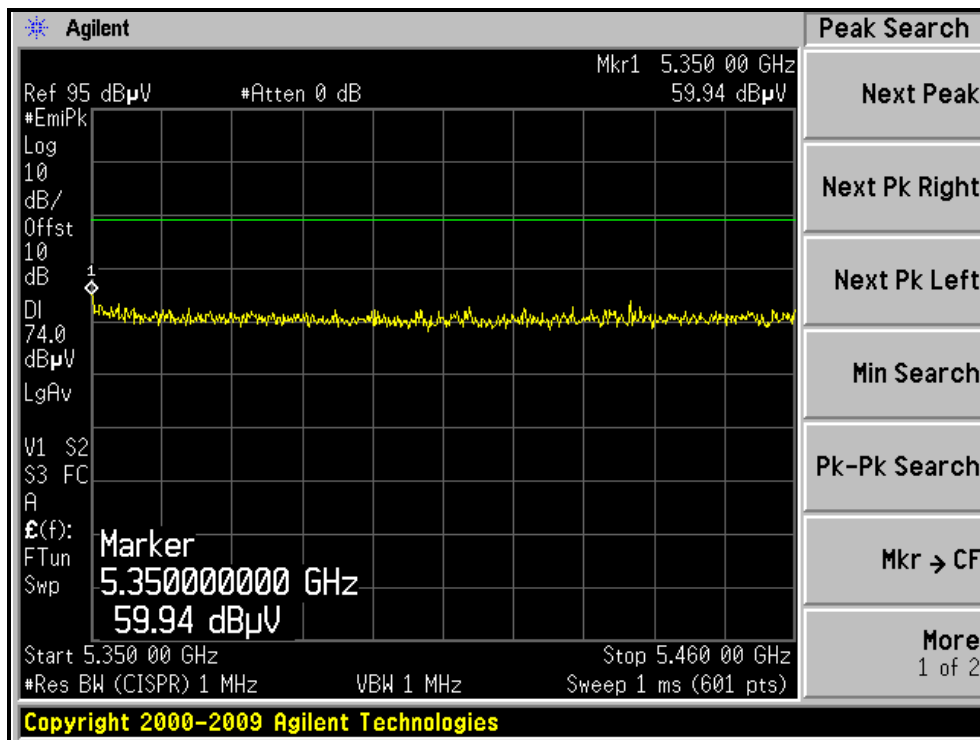

RESTRICTED BANDEDGE (802.11n (20MHz) MODE,CH 64, VERTICAL )

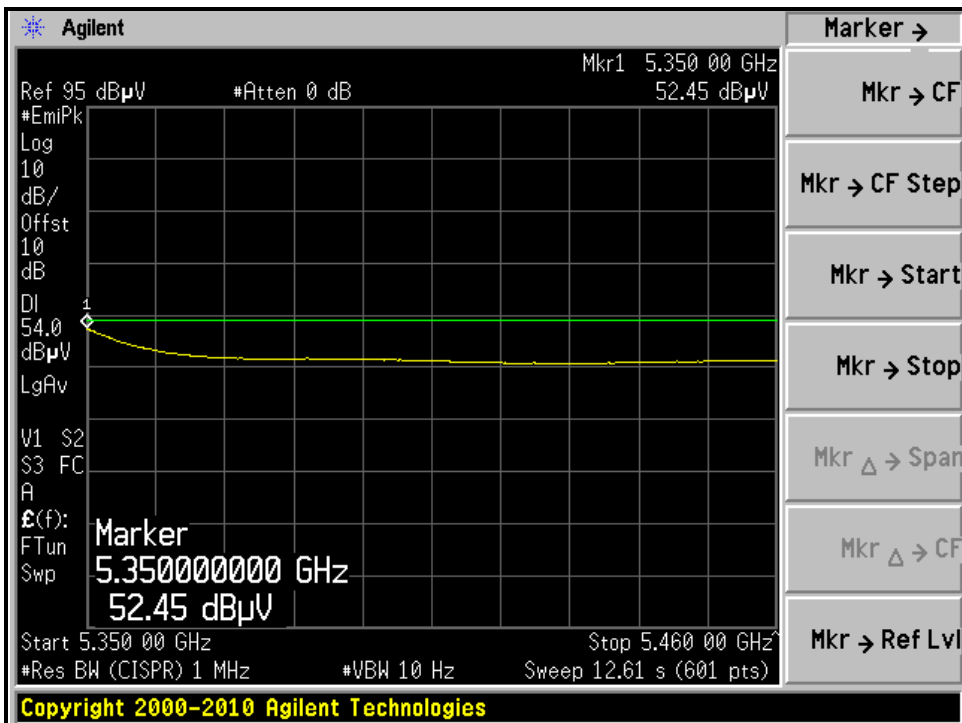
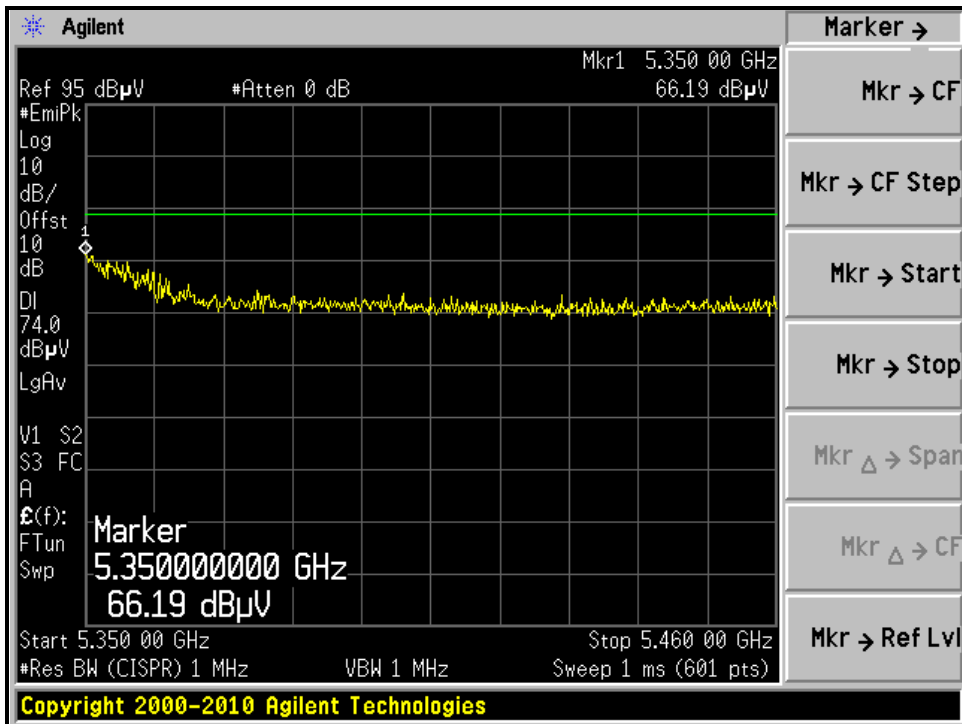



A D T

RESTRICTED BANDEDGE (802.11n (20MHz) MODE,CH 100, HORIZONTAL )

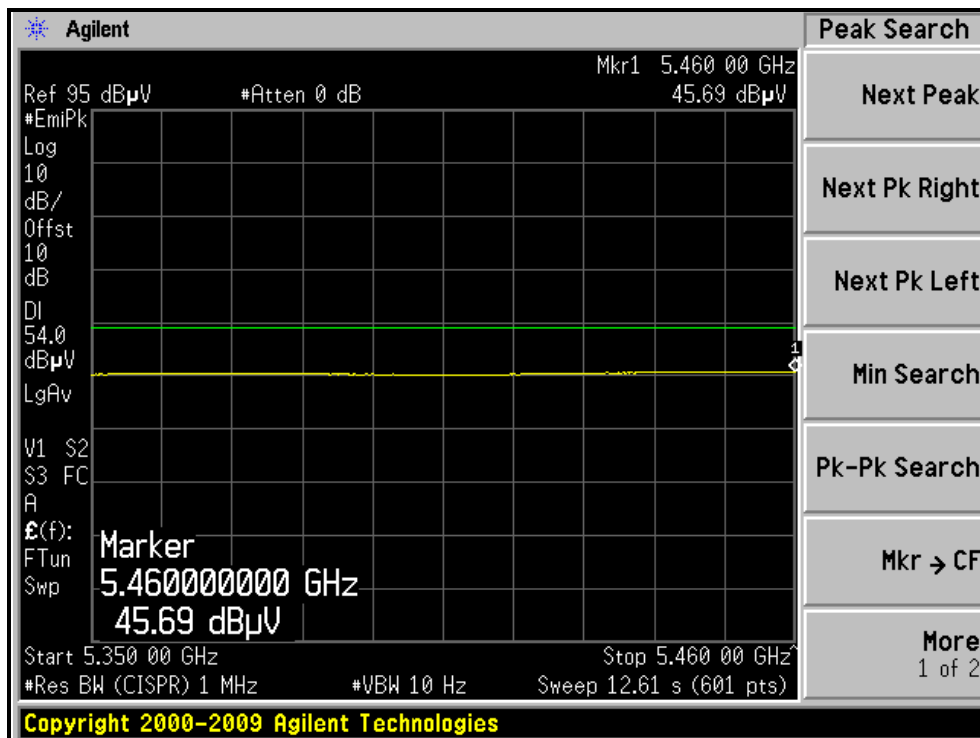
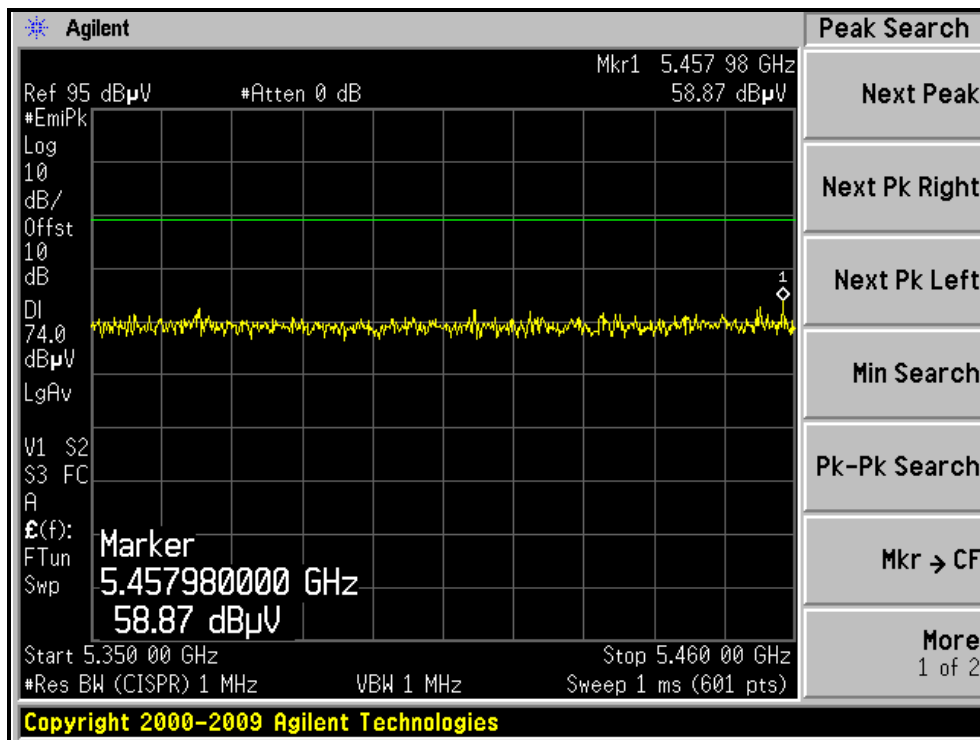



A D T

RESTRICTED BANDEDGE (802.11n (20MHz) MODE,CH 100, VERTICAL)

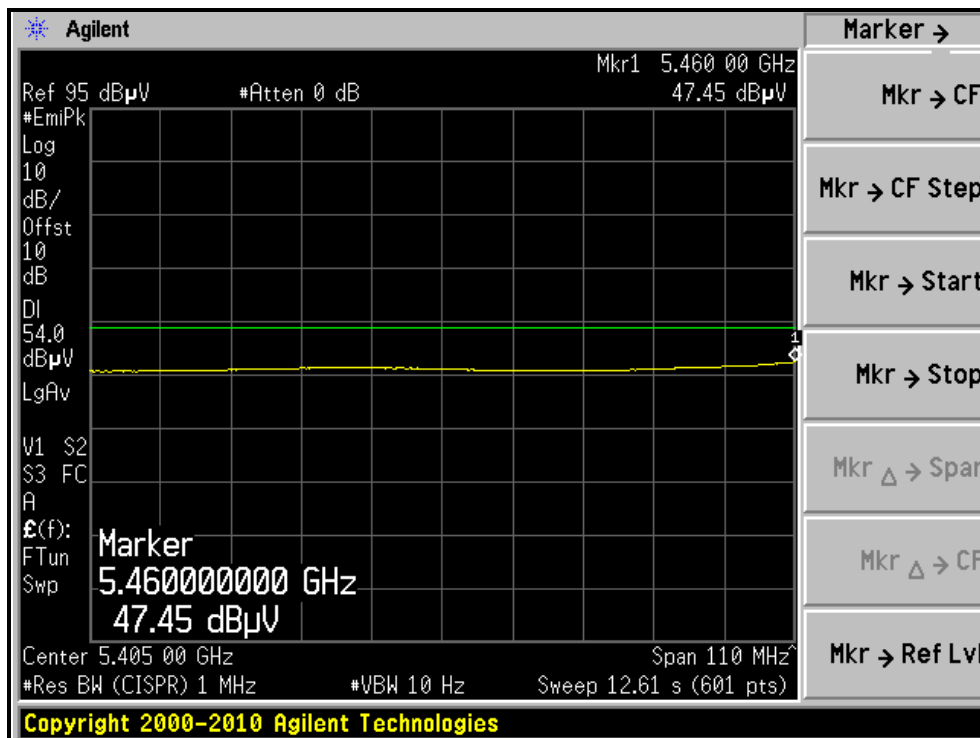
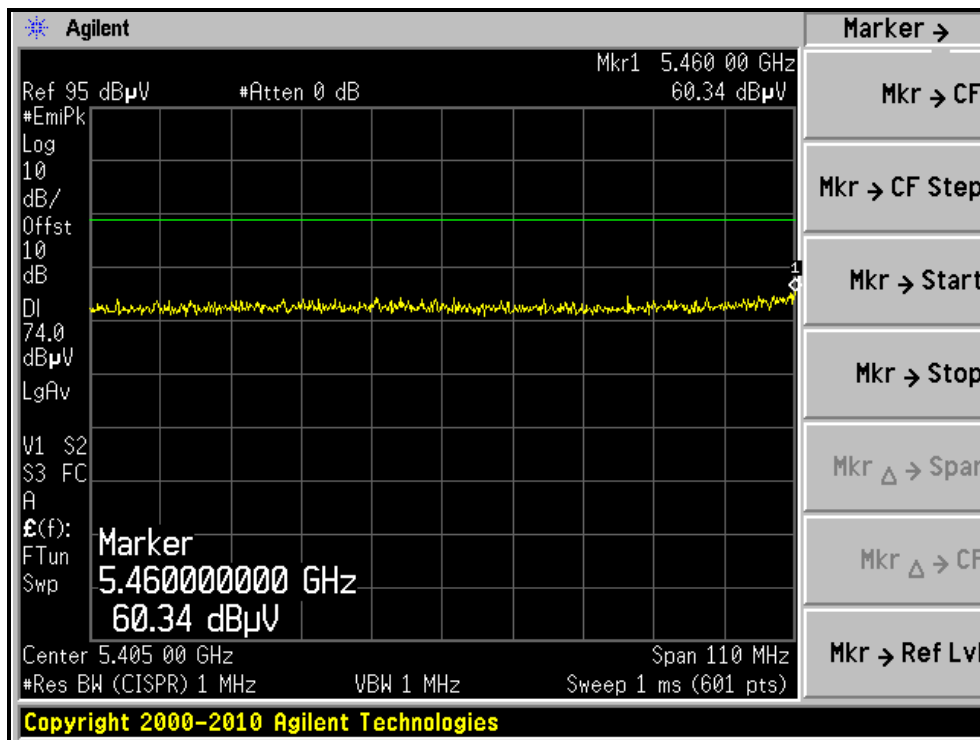



A D T

### 4.3 OUTPUT TRANSMIT POWER MEASUREMENT

#### 4.3.1 LIMITS OF OUTPUT TRANSMIT POWER MEASUREMENT

Frequency Band	Limit
5.15 – 5.25GHz	The lesser of 50mW (17dBm) or 4dBm + 10logB
5.25 – 5.35GHz	The lesser of 250mW (24dBm) or 11dBm + 10logB
5.47 – 5.725GHz	The lesser of 250mW (24dBm) or 11dBm + 10logB
5.725 – 5.825GHz	The lesser of 1W (30dBm) or 17dBm + 10logB

**NOTE:** Where B is the 26dB emission bandwidth in MHz.

#### 4.3.2 TEST INSTRUMENTS

##### FOR POWER OUTPUT MEASUREMENT

**Test date: Nov. 26, 2011**

DESCRIPTION & MANUFACTURER	MODEL NO.	SERIAL NO.	CALIBRATED DATE	CALIBRATED UNTIL
Peak Power Meter	ML2495A	0824006	May 04, 2011	May 03, 2012
Power Sensor	MA2411B	0738172	May 03, 2011	May 02, 2012

**NOTE:** The calibration interval of the above test instruments is 12 months and the calibrations are traceable to NML/ROC and NIST/USA.

##### FOR 26dB OCCUPIED BANDWIDTH

**Test date: Oct. 18, 2011**

DESCRIPTION & MANUFACTURER	MODEL NO.	SERIAL NO.	CALIBRATED DATE	CALIBRATED UNTIL
Spectrum Analyzer	E4446A	MY48250254	July 12, 2011	July 11, 2012

**NOTE:** The calibration interval of the above test instruments is 12 months and the calibrations are traceable to NML/ROC and NIST/USA.

### 4.3.3 TEST PROCEDURE

#### FOR POWER OUTPUT MEASUREMENT

A power sensor was used on the output port of the EUT. A power meter was used to read the response of the power sensor. Record the power level.

#### FOR 26dB OCCUPIED BANDWIDTH

The transmitter output was connected to the spectrum analyzer through an attenuator. The bandwidth of the fundamental frequency was measured by spectrum analyzer with 300kHz RBW and 1MHz VBW. The 26dB bandwidth is defined as the total spectrum the power of which is higher than peak power minus 26dB.

### 4.3.4 DEVIATION FROM TEST STANDARD

No deviation

### 4.3.5 TEST SETUP

#### FOR POWER OUTPUT MEASUREMENT

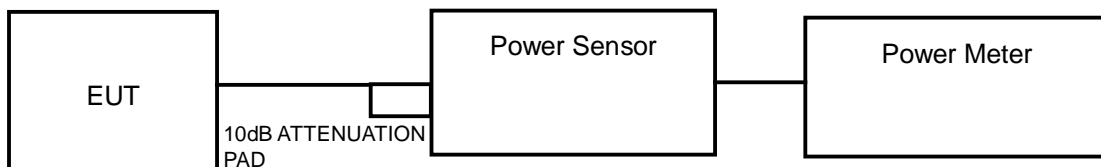

#### FOR 26dB OCCUPIED BANDWIDTH

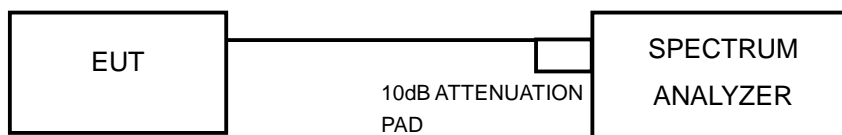

### 4.3.6 EUT OPERATING CONDITIONS

The software provided by client to enable the EUT under transmission condition continuously at specific channel frequencies individually.



A D T

### 4.3.7 TEST RESULTS

#### POWER OUTPUT: 802.11a

CHANNEL	CHANNEL FREQUENCY (MHz)	OUTPUT POWER (mW)	OUTPUT POWER (dBm)	OUTPUT POWER LIMIT (dBm)	PASS/FAIL
36	5180	<b>31.6</b>	15.0	17	PASS
40	5200	30.9	14.9	17	PASS
48	5240	31.6	15.0	17	PASS
52	5260	<b>102.3</b>	20.1	24	PASS
60	5300	100.0	20.0	24	PASS
64	5320	53.7	17.3	24	PASS
100	5500	39.8	16.0	24	PASS
116	5580	95.5	19.8	24	PASS
132	5660	<b>97.7</b>	19.9	24	PASS
140	5700	35.5	15.5	24	PASS

Note: Output Power = Measurement PWR + Trace loss (1.3dB)

#### POWER OUTPUT: 802.11n (20MHz)

CHANNEL	CHANNEL FREQUENCY (MHz)	OUTPUT POWER (mW)	OUTPUT POWER (dBm)	OUTPUT POWER LIMIT (dBm)	PASS/FAIL
36	5180	<b>32.4</b>	15.1	17	PASS
40	5200	31.6	15.0	17	PASS
48	5240	32.4	15.1	17	PASS
52	5260	<b>89.1</b>	19.5	24	PASS
60	5300	85.1	19.3	24	PASS
64	5320	47.9	16.8	24	PASS
100	5500	37.2	15.7	24	PASS
116	5580	<b>89.1</b>	19.5	24	PASS
132	5660	89.1	19.5	24	PASS
140	5700	33.9	15.3	24	PASS

Note: Output Power = Measurement PWR + Trace loss (1.3dB)



A D T

26dB OCCUPIED BANDWIDTH: 802.11a

CHANNEL	CHANNEL FREQUENCY (MHz)	26dBc OCCUPIED BANDWIDTH (MHz)
36	5180	24.36
40	5200	21.66
48	5240	22.74
52	5260	32.86
60	5300	34.12
64	5320	28.06
100	5500	23.13
116	5580	36.87
132	5660	33.75
140	5700	23.90

CH36

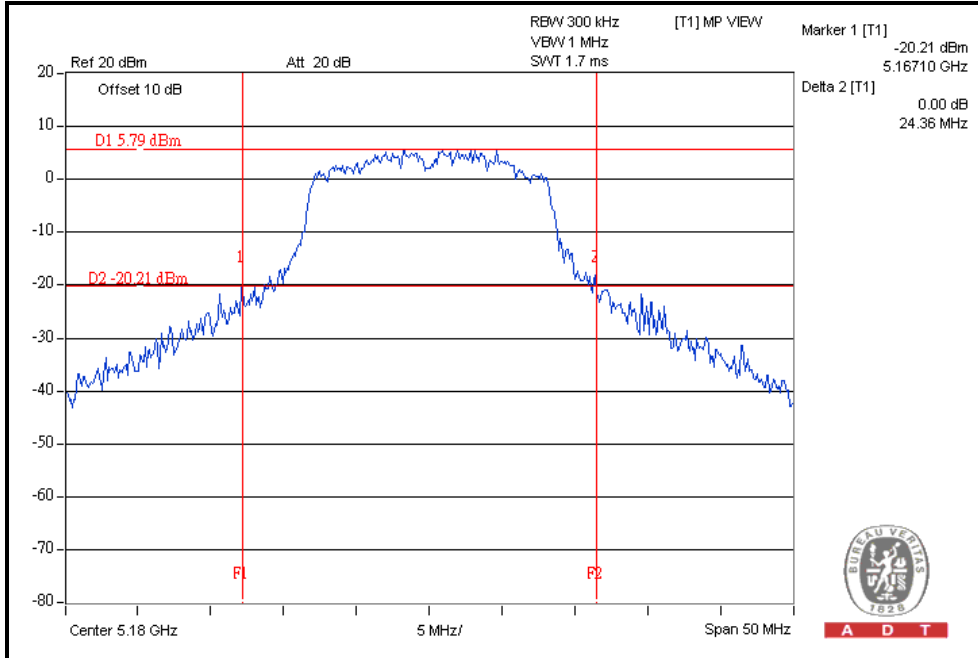





A D T

### CH52

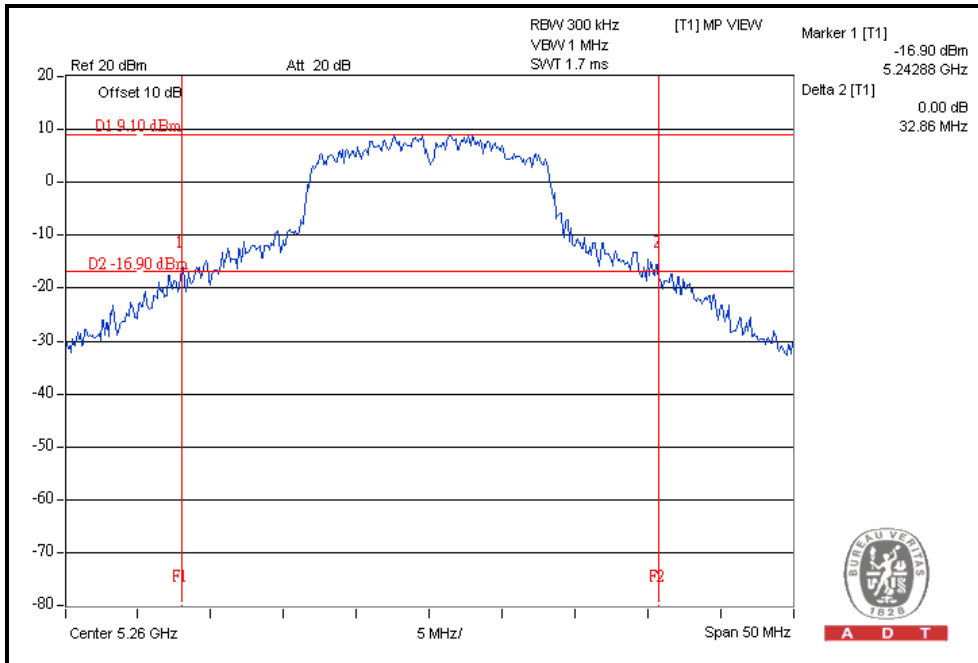

### CH132

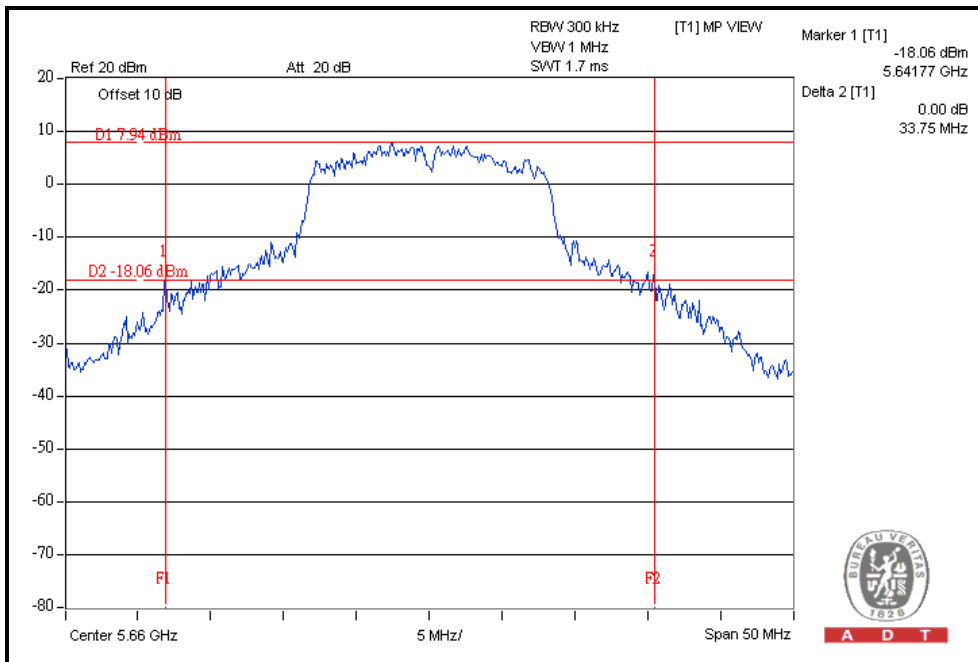



A D T

26dB OCCUPIED BANDWIDTH: 802.11n (20MHz)

CHANNEL	CHANNEL FREQUENCY (MHz)	26dBc OCCUPIED BANDWIDTH (MHz)
36	5180	24.52
40	5200	22.87
48	5240	23.68
52	5260	32.85
60	5300	34.72
64	5320	32.14
100	5500	24.48
116	5580	36.16
132	5660	31.43
140	5700	25.52

CH36

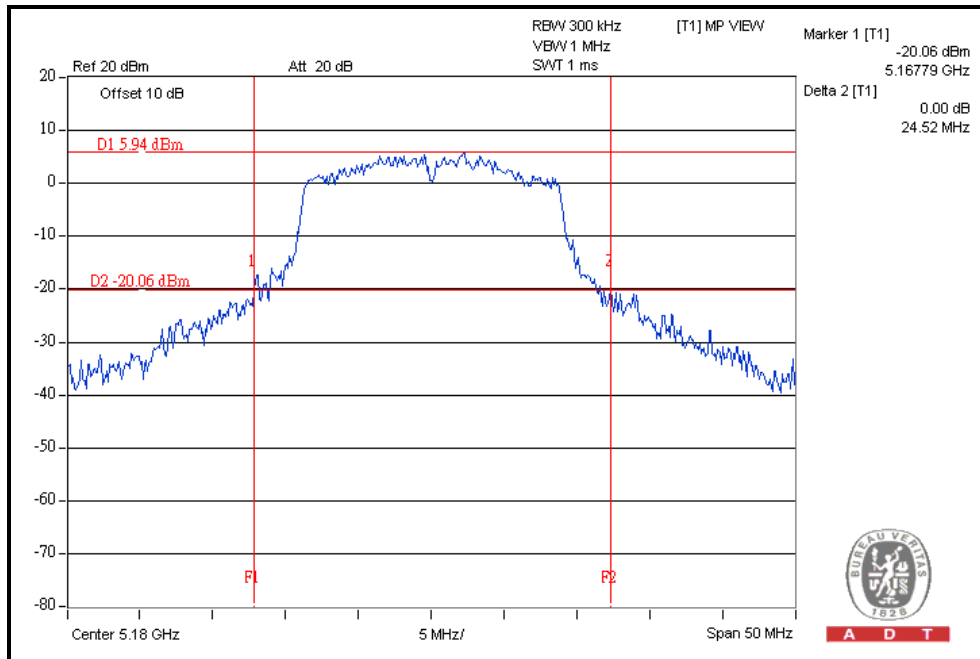



A D T

### CH52

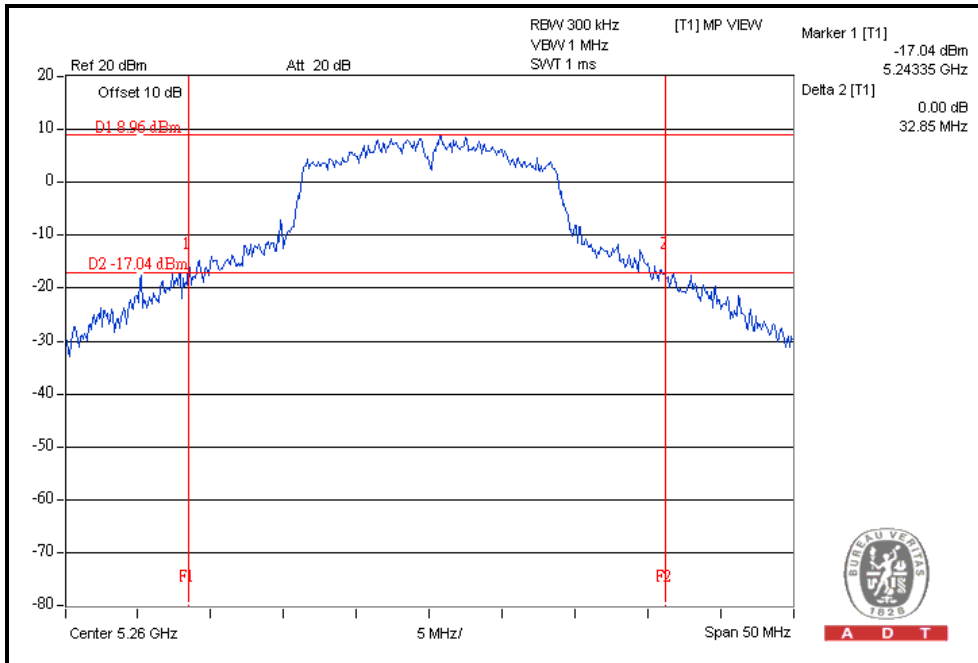

### CH116

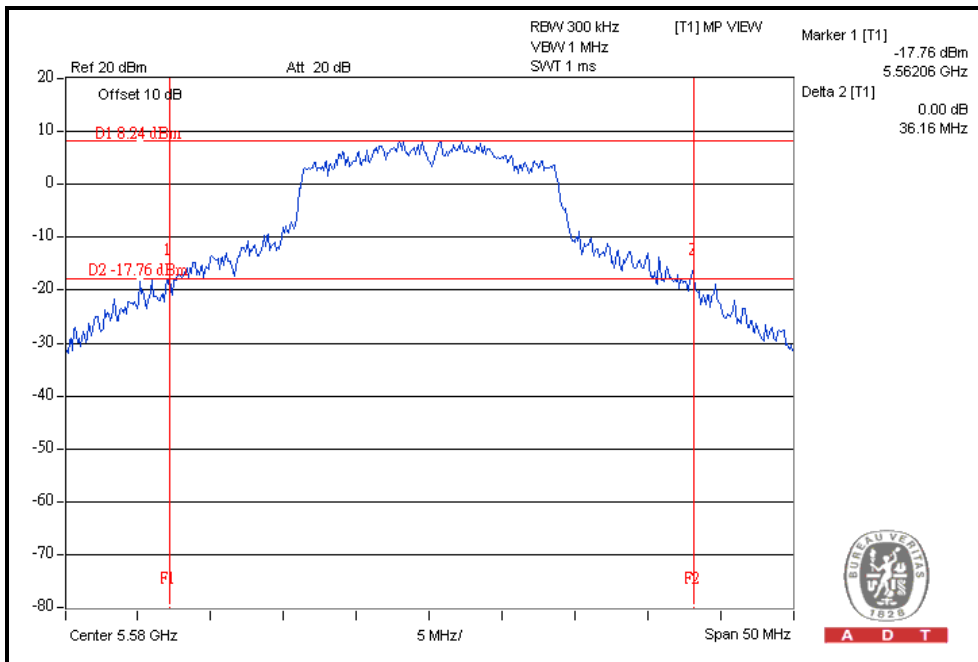

## 4.4 PEAK POWER EXCURSION MEASUREMENT

### 4.4.1 LIMITS OF PEAK POWER EXCURSION MEASUREMENT

Frequency Band	Limit
5.15 – 5.25 GHz	13dB
5.25 – 5.35 GHz	13dB
5.47 – 5.725GHz	13dB
5.725 – 5.825 GHz	13dB

### 4.4.2 TEST INSTRUMENTS

Test date: Nov. 26, 2011

DESCRIPTION & MANUFACTURER	MODEL NO.	SERIAL NO.	CALIBRATED DATE	CALIBRATED UNTIL
Spectrum Analyzer	E4446A	MY48250254	July 12, 2011	July 11, 2012

**NOTE:** The calibration interval of the above test instruments is 12 months and the calibrations are traceable to NML/ROC and NIST/USA.

### 4.4.3 TEST PROCEDURE

1. Connect the cable from the spectrum analyzer to the EUT antenna port using an appropriate RF attenuator.
2. Verify the antenna port selected is the active one if the system has more than one antenna.
3. Verify the unlicensed wireless device is set to operate at 100 % duty cycle at the maximum allowed power for operation.
4. Testing shall be done on the center frequency of each U-NII band.
5. Set the spectrum analyzer span to view the entire emission bandwidth. The largest difference between the following two traces must be 13 dB for all frequencies across the emission bandwidth.
  - a. First trace: set RBW = 1 MHz, VBW = 3 MHz with peak detector and max hold settings.
  - b. Second trace: set RBW = 1 MHz, VBW = 3 MHz with sample detector and trace average across 100 traces in power averaging mode.

### 4.4.4 DEVIATION FROM TEST STANDARD

No deviation

#### 4.4.5 TEST SETUP

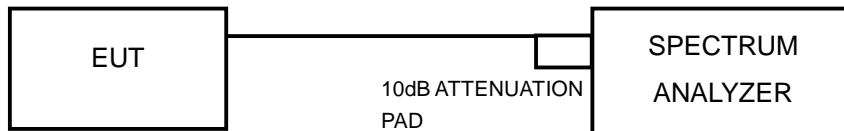

#### 4.4.6 EUT OPERATING CONDITIONS

The software provided by client to enable the EUT under transmission condition continuously at specific channel frequencies individually.



A D T

### 4.4.7 TEST RESULTS

#### 802.11a OFDM MODULATION

CHANNEL	CHANNEL FREQUENCY (MHz)	PEAK POWER EXCURSION (dB)	PEAK to AVERAGE EXCURSION LIMIT (dB)	PASS/FAIL
36	5180	9.1	13	PASS
40	5200	8.1	13	PASS
48	5240	9.2	13	PASS
52	5260	9.1	13	PASS
60	5300	9.0	13	PASS
64	5320	8.8	13	PASS
100	5500	8.1	13	PASS
116	5580	9.8	13	PASS
132	5660	8.1	13	PASS
140	5700	8.3	13	PASS

#### CH48

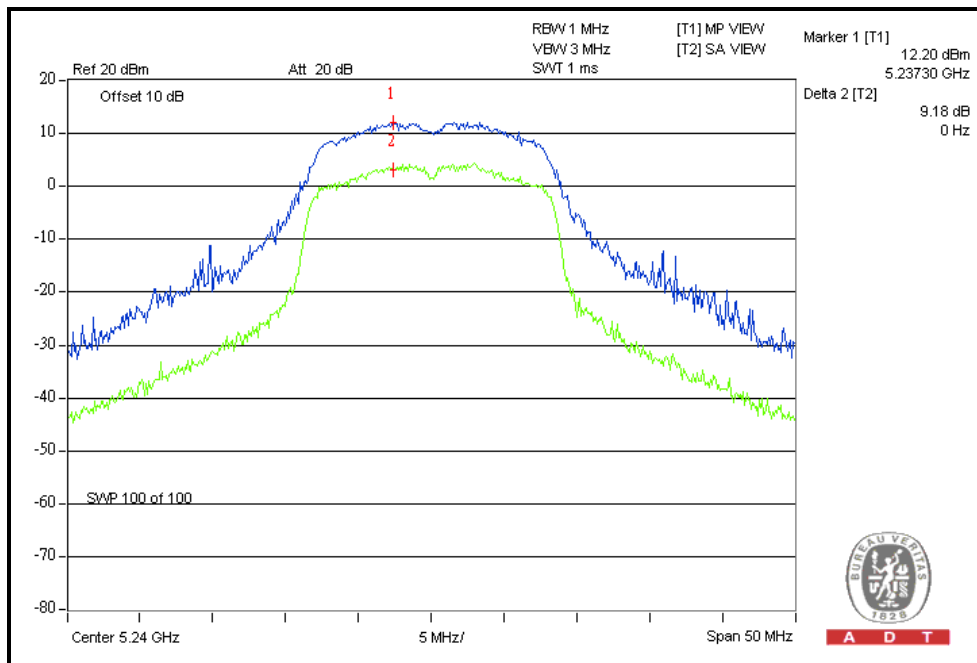



A D T

### CH52

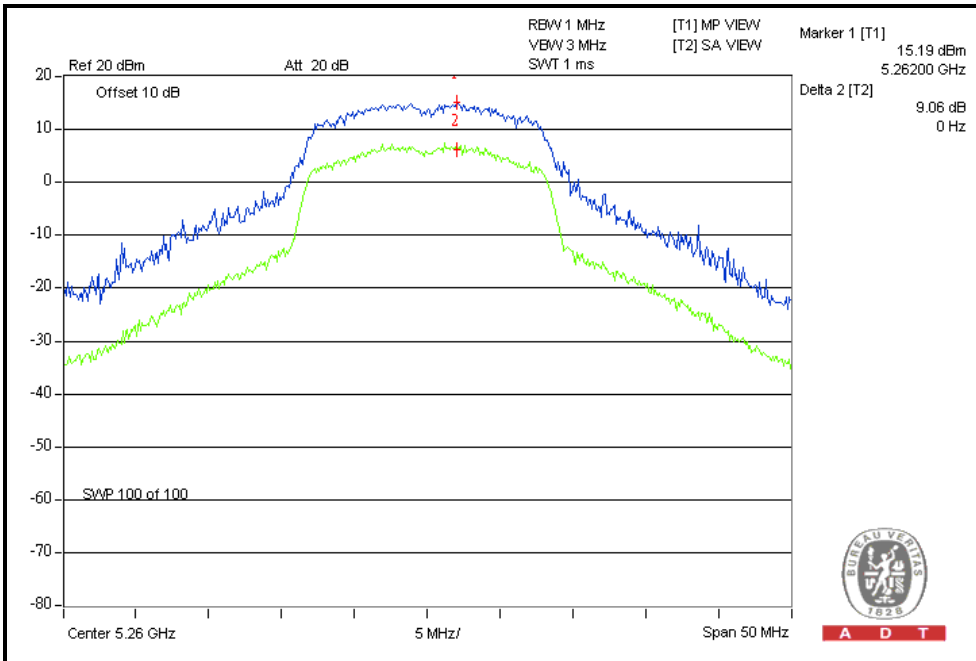

### CH116

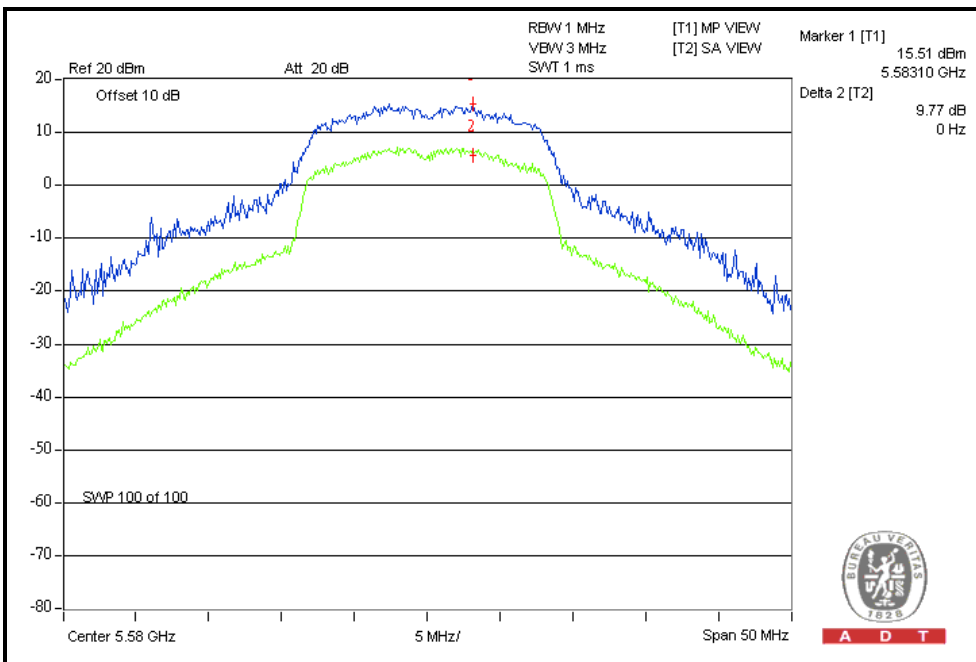



A D T

### 802.11n (20MHz) OFDM MODULATION:

CHANNEL	CHANNEL FREQUENCY (MHz)	PEAK POWER EXCURSION (dB)	PEAK to AVERAGE EXCURSION LIMIT (dB)	PASS/FAIL
36	5180	8.4	13	PASS
40	5200	9.5	13	PASS
48	5240	9.4	13	PASS
52	5260	8.7	13	PASS
60	5300	8.5	13	PASS
64	5320	9.5	13	PASS
100	5500	8.2	13	PASS
116	5580	8.9	13	PASS
132	5660	8.3	13	PASS
140	5700	8.7	13	PASS

### CH40

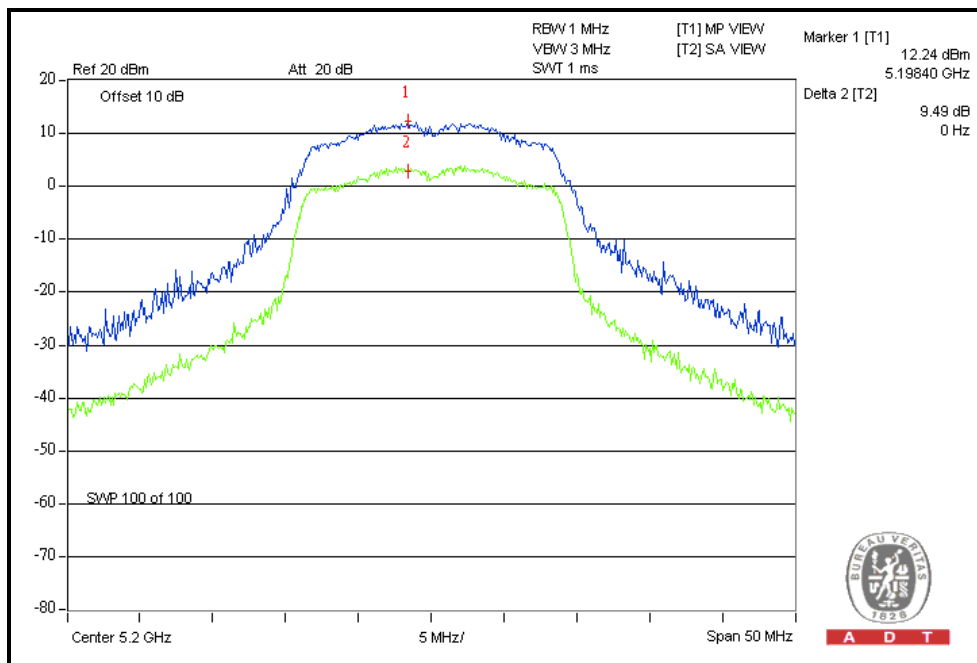





A D T

### CH64

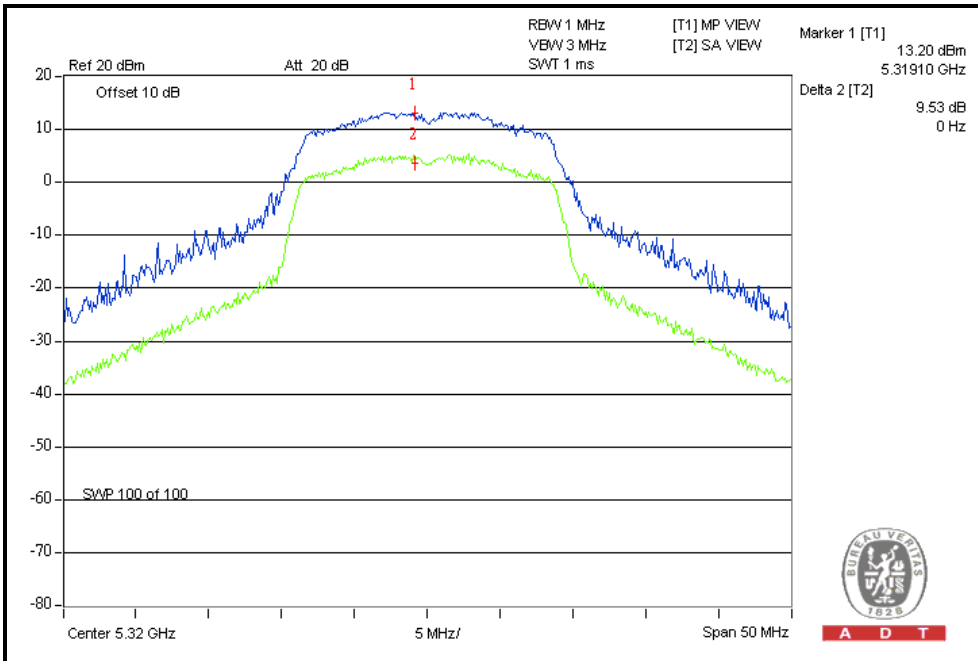

### CH116

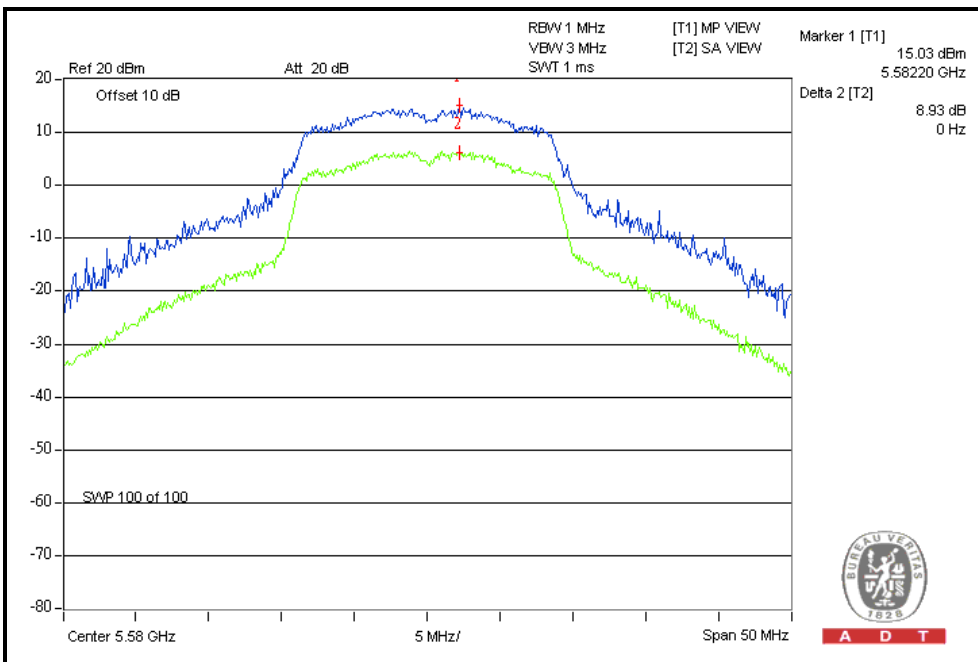

## 4.5 PEAK POWER SPECTRAL DENSITY MEASUREMENT

### 4.5.1 LIMITS OF PEAK POWER SPECTRAL DENSITY MEASUREMENT

Frequency Band	Limit
5.15 ~ 5.25GHz	4dBm
5.25 ~ 5.35GHz	11dBm
5.47 ~ 5.725GHz	11dBm
5.725 ~ 5.825GHz	17dBm

### 4.5.2 TEST INSTRUMENTS

Test date: Nov. 26, 2011

DESCRIPTION & MANUFACTURER	MODEL NO.	SERIAL NO.	CALIBRATED DATE	CALIBRATED UNTIL
Spectrum Analyzer	E4446A	MY48250254	July 12, 2011	July 11, 2012

**NOTE:** The calibration interval of the above test instruments is 12 months and the calibrations are traceable to NML/ROC and NIST/USA.

### 4.5.3 TEST PROCEDURES

1. The transmitter output was connected to the spectrum analyzer.
2. Set RBW=1MHz, VBW=3MHz. The PPSD is the highest level found across the emission in any 1MHz band.

### 4.5.4 DEVIATION FROM TEST STANDARD

No deviation

### 4.5.5 TEST SETUP

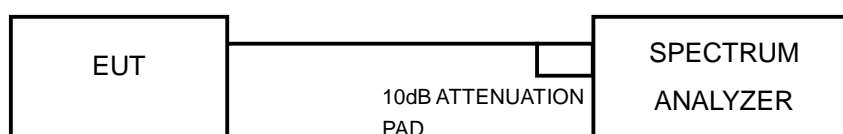

### 4.5.6 EUT OPERATING CONDITIONS

Same as 4.3.6



A D T

### 4.5.7 TEST RESULTS

#### 802.11a OFDM MODULATION

CHANNEL	CHANNEL FREQUENCY (MHz)	RF POWER LEVEL IN 3kHz BW (dBm)	MAXIMUM LIMIT (dBm)	PASS / FAIL
36	5180	3.6	4	PASS
40	5200	3.9	4	PASS
48	5240	3.7	4	PASS
52	5260	7.0	11	PASS
60	5300	7.1	11	PASS
64	5320	6.6	11	PASS
100	5500	3.8	11	PASS
116	5580	7.1	11	PASS
132	5660	5.7	11	PASS
140	5700	4.6	11	PASS

Note: PSD = Measurement PWR + Trace loss (1.3dB)

#### CH40

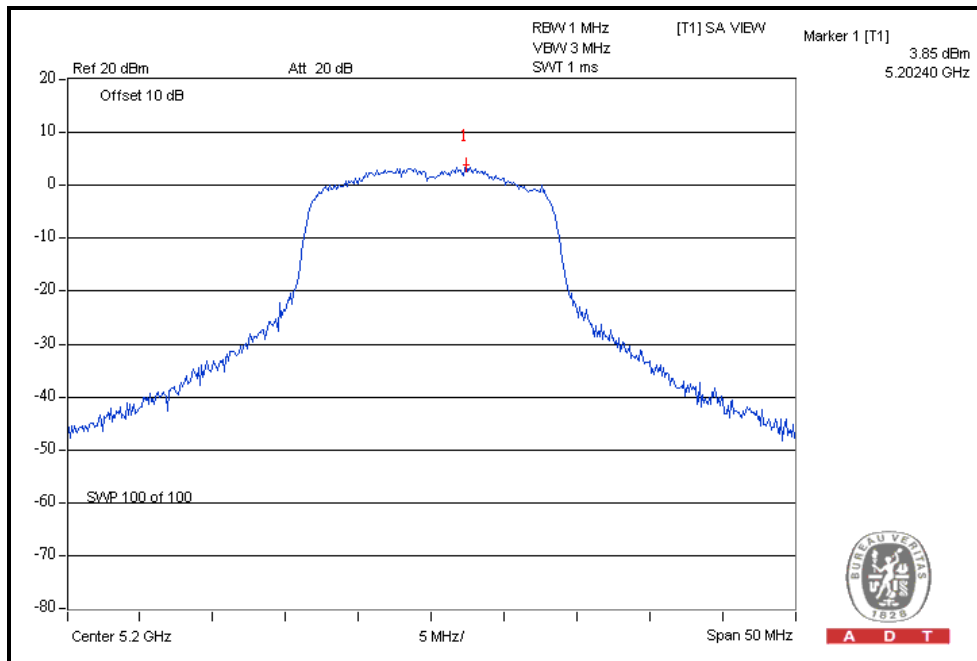



A D T

### CH60

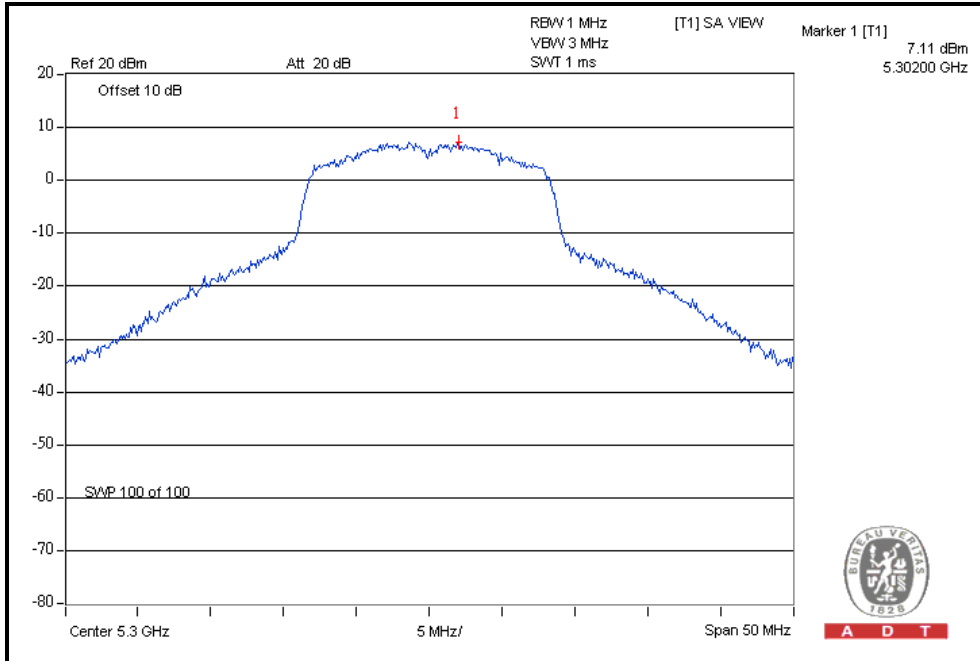

### CH116

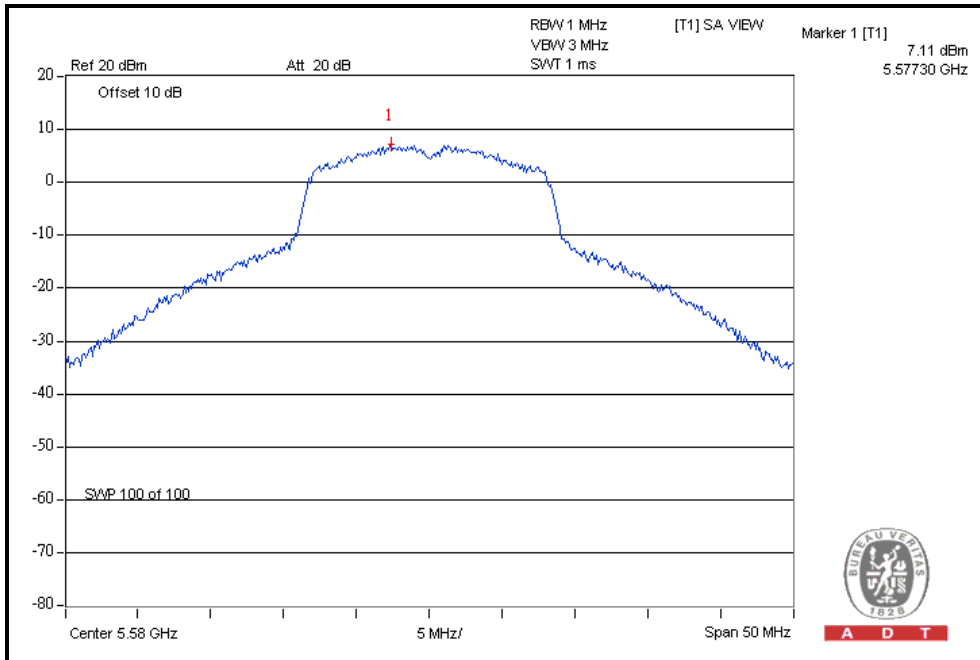



A D T

### 802.11n (20MHz) OFDM MODULATION:

CHANNEL	CHANNEL FREQUENCY (MHz)	RF POWER LEVEL IN 3kHz BW (dBm)	MAXIMUM LIMIT (dBm)	PASS / FAIL
36	5180	3.3	4	PASS
40	5200	3.4	4	PASS
48	5240	3.2	4	PASS
52	5260	6.6	11	PASS
60	5300	6.7	11	PASS
64	5320	5.5	11	PASS
100	5500	3.9	11	PASS
116	5580	6.6	11	PASS
132	5660	5.8	11	PASS
140	5700	3.8	11	PASS

Note: PSD = Measurement PWR + Trace loss (1.3dB)

### CH40

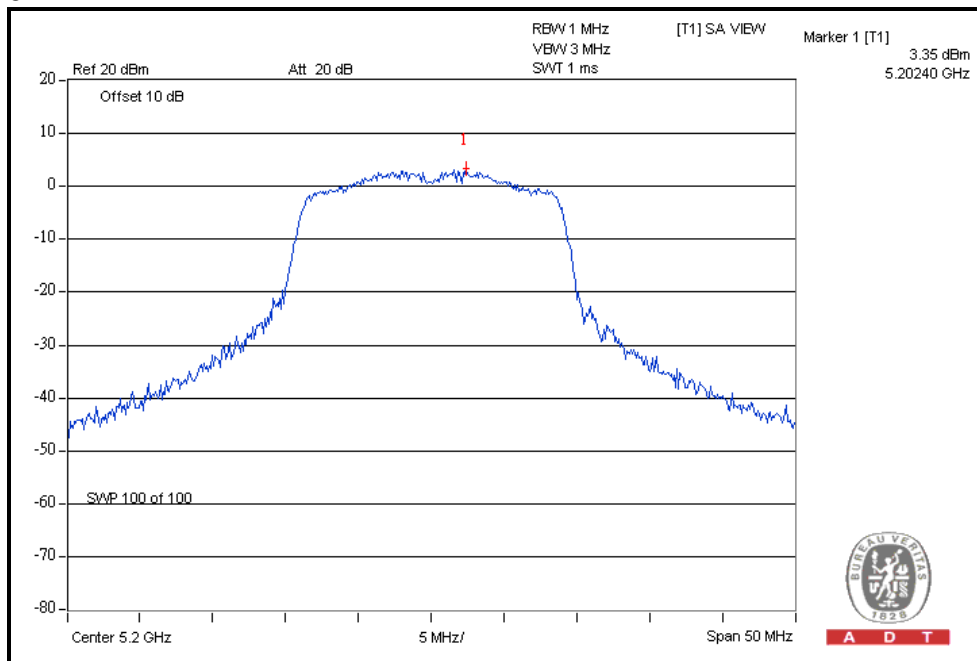

A D T



A D T

### CH60

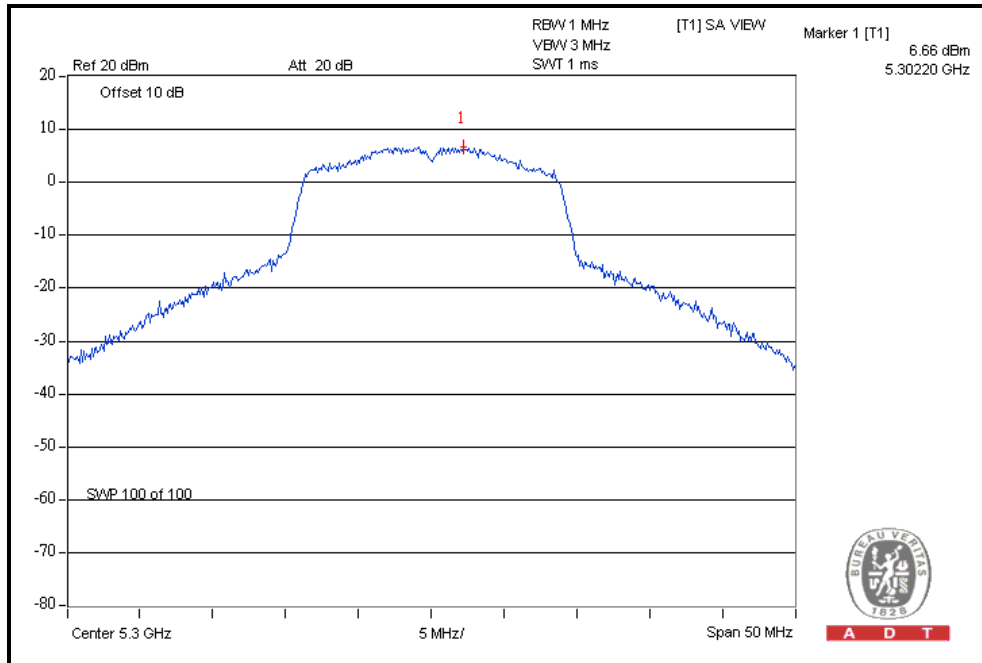

### CH116

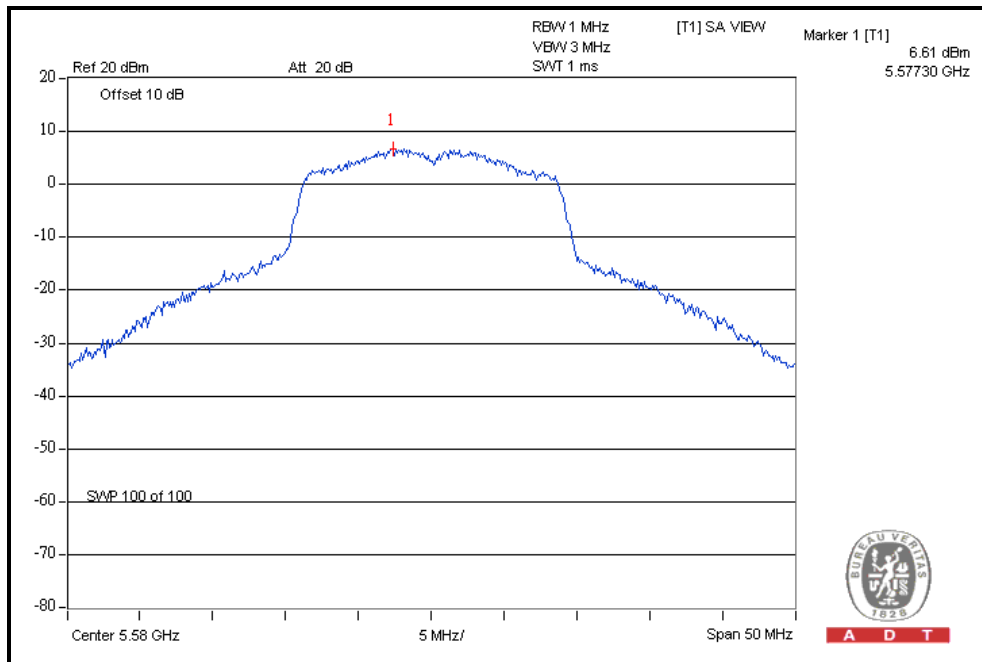

## 4.6 FREQUENCY STABILITY

### 4.6.1 LIMITS OF FREQUENCY STABILITY MEASUREMENT

The frequency tolerance of the carrier signal shall be maintained within the band of the operating frequency over a temperature variation of –30 degrees to 50 degrees C at normal supply voltage, and for a variation in the primary supply voltage from 85% to 115% of the rated supply voltage at a temperature of 20 degrees C.

### 4.6.2 TEST INSTRUMENTS

**Test date: Nov. 26, 2011**

DESCRIPTION & MANUFACTURER	MODEL NO.	SERIAL NO.	CALIBRATED DATE	CALIBRATED UNTIL
R&S Spectrum Analyzer	FSP40	100036	Dec. 08, 2010	Dec. 07, 2011

**NOTE:** The calibration interval of the above test instruments is 12 months and the calibrations are traceable to NML/ROC and NIST/USA.

### 4.6.3 TEST PROCEDURE

1. The EUT was placed inside the environmental test chamber and powered by nominal DC voltage.
2. Turn the EUT on and couple its output to a spectrum analyzer.
3. Turn the EUT off and set the chamber to the highest temperature specified.
4. Allow sufficient time (approximately 30 min) for the temperature of the chamber to stabilize, turn the EUT on and measure the operating frequency after 2, 5, and 10 minutes.
5. Repeat step 2 and 3 with the temperature chamber set to the lowest temperature.
6. The test chamber was allowed to stabilize at +20 degree C for a minimum of 30 minutes. The supply voltage was then adjusted on the EUT from 85% to 115% and the frequency record.

#### 4.6.4 DEVIATION FROM TEST STANDARD

No deviation

#### 4.6.5 TEST SETUP

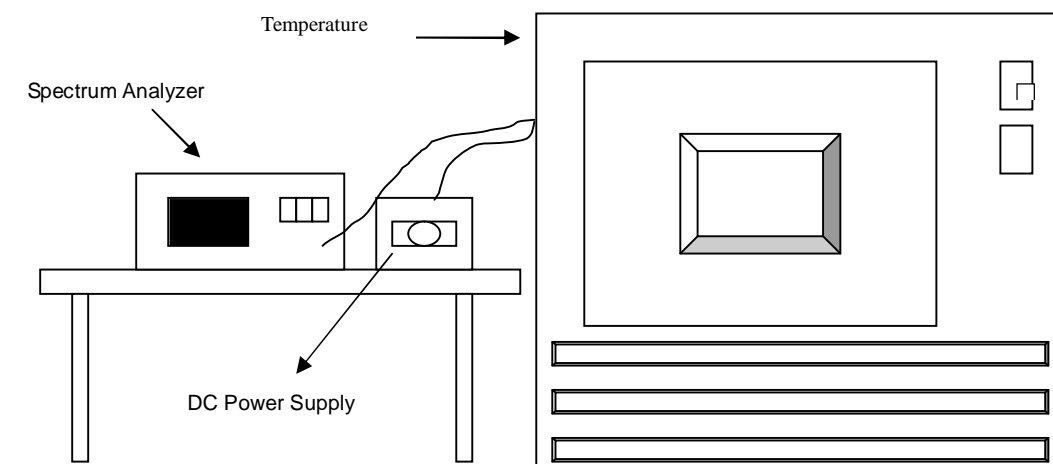

#### 4.6.6 EUT OPERATING CONDITION

The software provided by client to enable the EUT under transmission condition continuously at specific channel frequencies individually.





A D T

#### 4.6.7 TEST RESULTS

Operating frequency: 5320MHz									
Temp. (°C)	Power supply (Vdc)	0 minute		2 minute		5 minute		10 minute	
		(MHz)	ppm	(MHz)	ppm	(MHz)	ppm	(MHz)	ppm
50	3.795	5319.9903	-1.8233	5319.9938	-1.1654	5319.9921	-1.4850	5319.9881	-2.2368
	3.3	5319.9901	-1.8609	5319.9931	-1.2970	5319.992	-1.5038	5319.9888	-2.1053
	2.805	5319.9907	-1.7481	5319.9935	-1.2218	5319.991	-1.6917	5319.9897	-1.9361
40	3.795	5320.0077	1.4474	5320.0103	1.9361	5320.0105	1.9737	5320.0119	2.2368
	3.3	5320.0064	1.2030	5320.0088	1.6541	5320.0111	2.0865	5320.0106	1.9925
	2.805	5320.0066	1.2406	5320.009	1.6917	5320.0099	1.8609	5320.0108	2.0301
30	3.795	5320.0102	1.9173	5320.0066	1.2406	5320.0066	1.2406	5320.0089	1.6729
	3.3	5320.0103	1.9361	5320.0064	1.2030	5320.0057	1.0714	5320.0089	1.6729
	2.805	5320.01	1.8797	5320.0054	1.0150	5320.0053	0.9962	5320.0098	1.8421
20	3.795	5320.0036	0.6767	5319.9984	-0.3008	5319.9977	-0.4323	5319.9967	-0.6203
	3.3	5320.0025	0.4699	5319.9983	-0.3195	5319.997	-0.5639	5319.9969	-0.5827
	2.805	5320.0037	0.6955	5319.9982	-0.3383	5319.9968	-0.6015	5319.9977	-0.4323
10	3.795	5319.9834	-3.1203	5319.983	-3.1955	5319.9812	-3.5338	5319.9787	-4.0038
	3.3	5319.9826	-3.2707	5319.9832	-3.1579	5319.9808	-3.6090	5319.978	-4.1353
	2.805	5319.9839	-3.0263	5319.9836	-3.0827	5319.9808	-3.6090	5319.9777	-4.1917
0	3.795	5319.9937	-1.1842	5319.9899	-1.8985	5319.995	-0.9398	5319.9903	-1.8233
	3.3	5319.9929	-1.3346	5319.99	-1.8797	5319.9964	-0.6767	5319.9903	-1.8233
	2.805	5319.9932	-1.2782	5319.99	-1.8797	5319.9955	-0.8459	5319.9912	-1.6541
-10	3.795	5319.9894	-1.9925	5319.9928	-1.3534	5319.9898	-1.9173	5319.9878	-2.2932
	3.3	5319.9904	-1.8045	5319.9915	-1.5977	5319.9898	-1.9173	5319.9878	-2.2932
	2.805	5319.9892	-2.0301	5319.9912	-1.6541	5319.989	-2.0677	5319.9894	-1.9925
-20	3.795	5320.0099	1.8609	5320.0057	1.0714	5320.0096	1.8045	5320.0124	2.3308
	3.3	5320.0097	1.8233	5320.0051	0.9586	5320.0095	1.7857	5320.0118	2.2180
	2.805	5320.0099	1.8609	5320.0061	1.1466	5320.0103	1.9361	5320.0121	2.2744
-30	3.795	5319.9981	-0.3571	5319.9973	-0.5075	5319.9945	-1.0338	5319.9941	-1.1090
	3.3	5319.998	-0.3759	5319.9957	-0.8083	5319.9949	-0.9586	5319.9942	-1.0902
	2.805	5319.9993	-0.1316	5319.9969	-0.5827	5319.9946	-1.0150	5319.994	-1.1278

## 4.7 CONDUCTED OUT-BAND EMISSION MEASUREMENT

### 4.7.1 TEST INSTRUMENTS

Test date : Nov. 26, 2011

DESCRIPTION & MANUFACTURER	MODEL NO.	SERIAL NO.	CALIBRATED DATE	CALIBRATED UNTIL
R&S Spectrum Analyzer	FSP40	100036	Dec. 08, 2010	Dec. 07, 2011

**NOTE:** The calibration interval of the above test instruments is 12 months and the calibrations are traceable to NML/ROC and NIST/USA.

### 4.7.2 TEST PROCEDURE

The transmitter output was connected to the spectrum analyzer via a low loss cable. Set RBW of spectrum analyzer to 1MHz with suitable frequency span including 100 MHz or 200 MHz bandwidth from band edge. The band edges was measured and recorded.

### 4.7.3 EUT OPERATING CONDITION

The software provided by client to enable the EUT under transmission condition continuously at specific channel frequencies individually.

### 4.7.4 TEST RESULTS

For 5.15 to 5.35GHz band:

The spectrum plots (Peak RBW=1MHz, VBW=3MHz) are attached on the following pages.



A D T

## 802.11a OFDM MODULATION

CH36

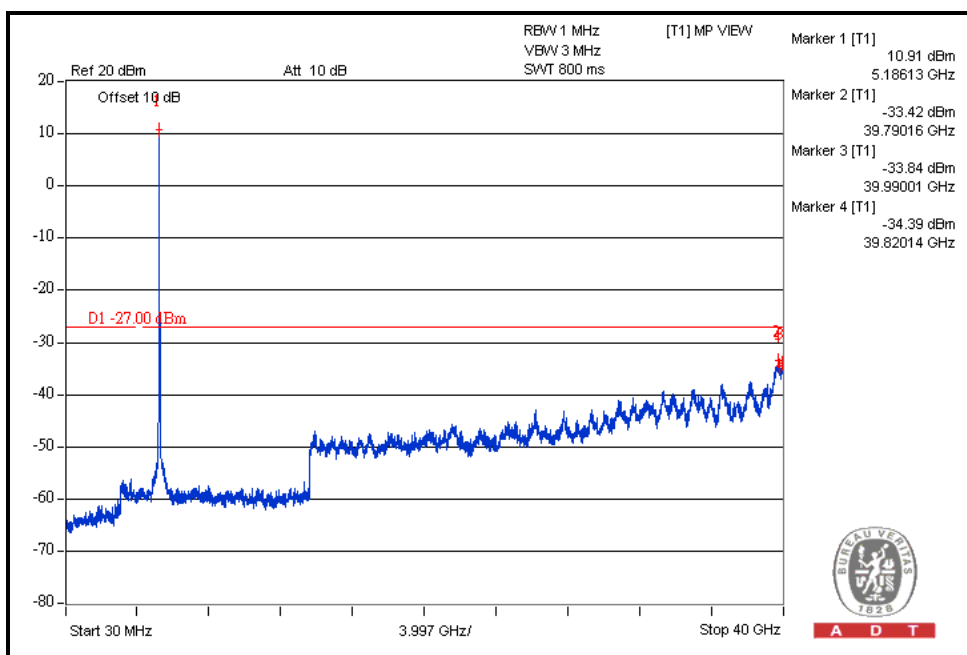
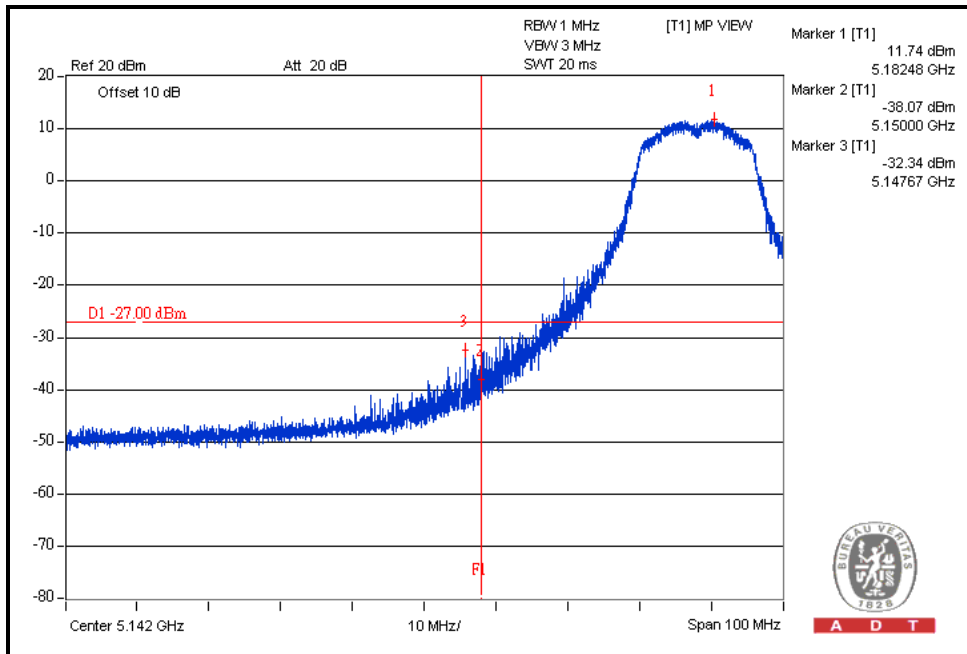



A D T

# CH64

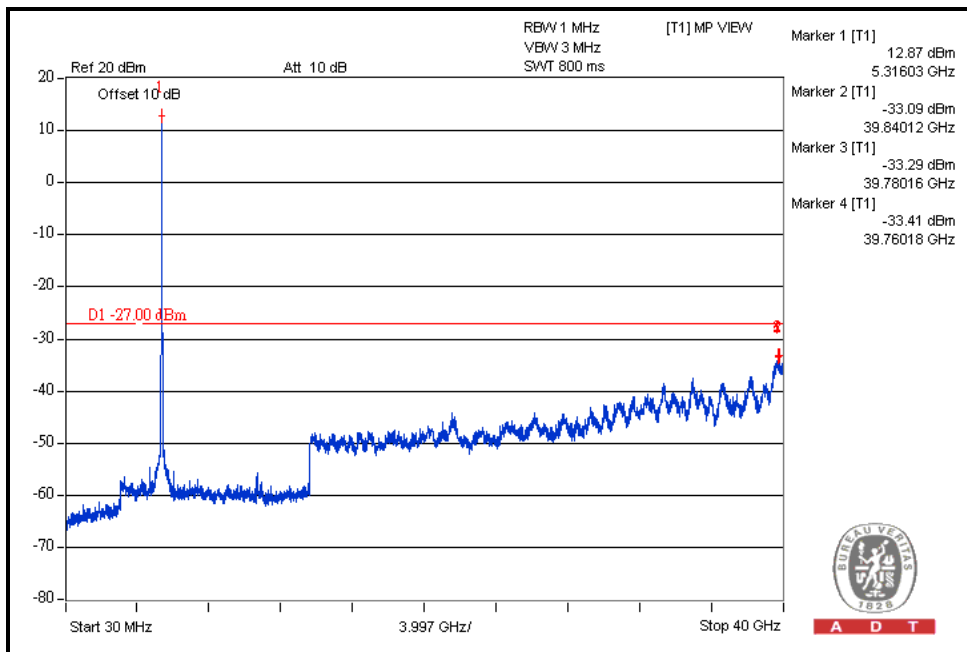
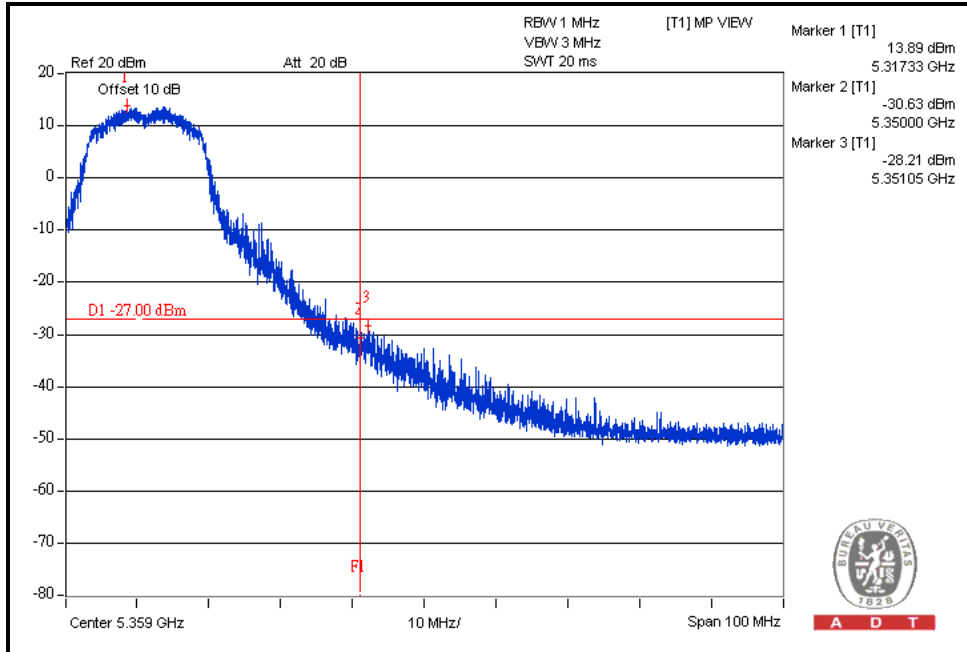



A D T

### 802.11n (20MHz) OFDM MODULATION:

CH36

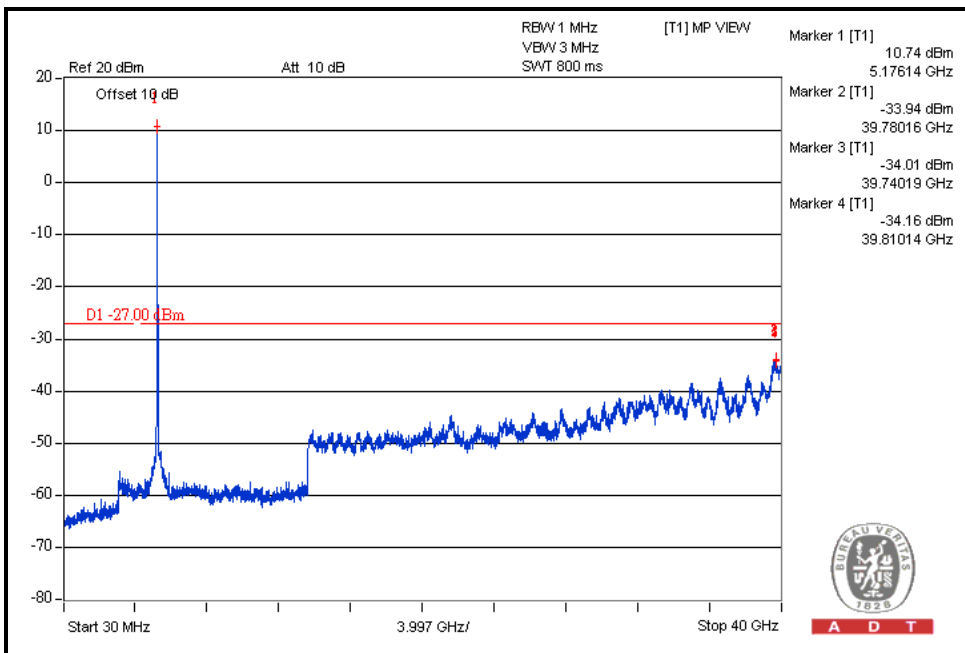
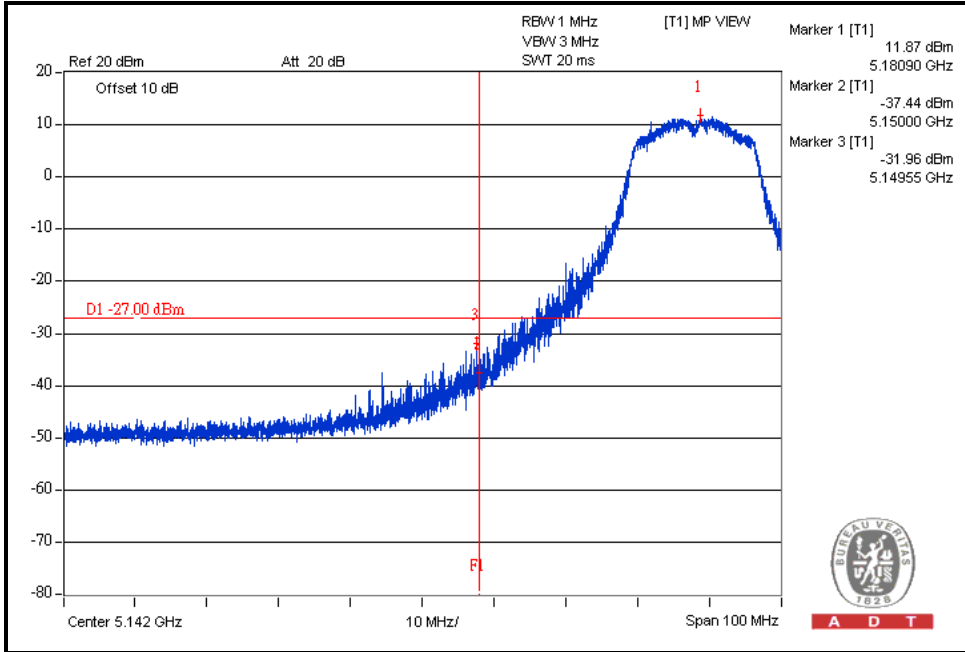



A D T

# CH64

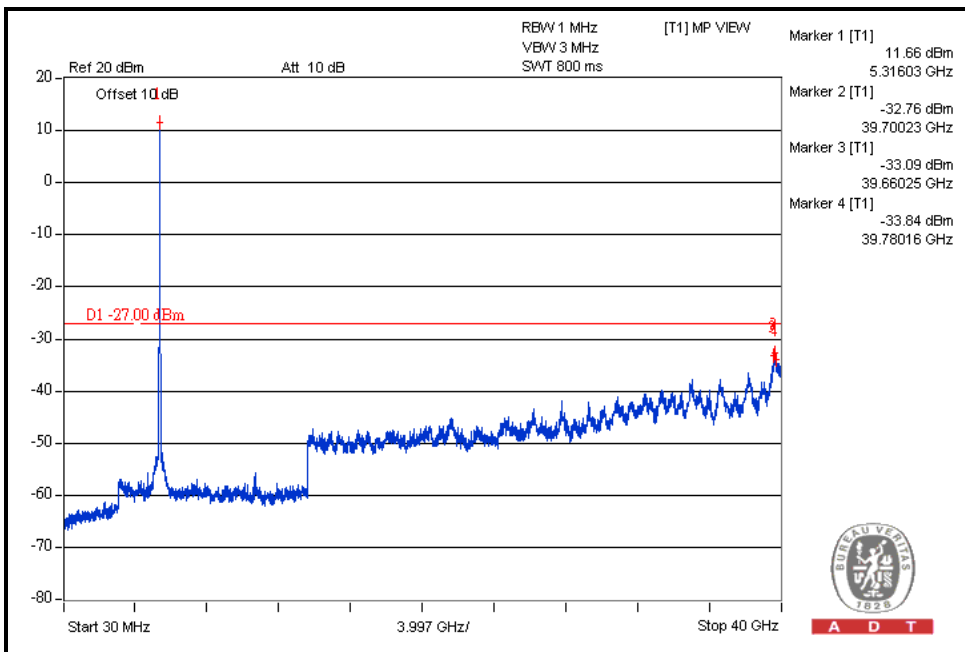
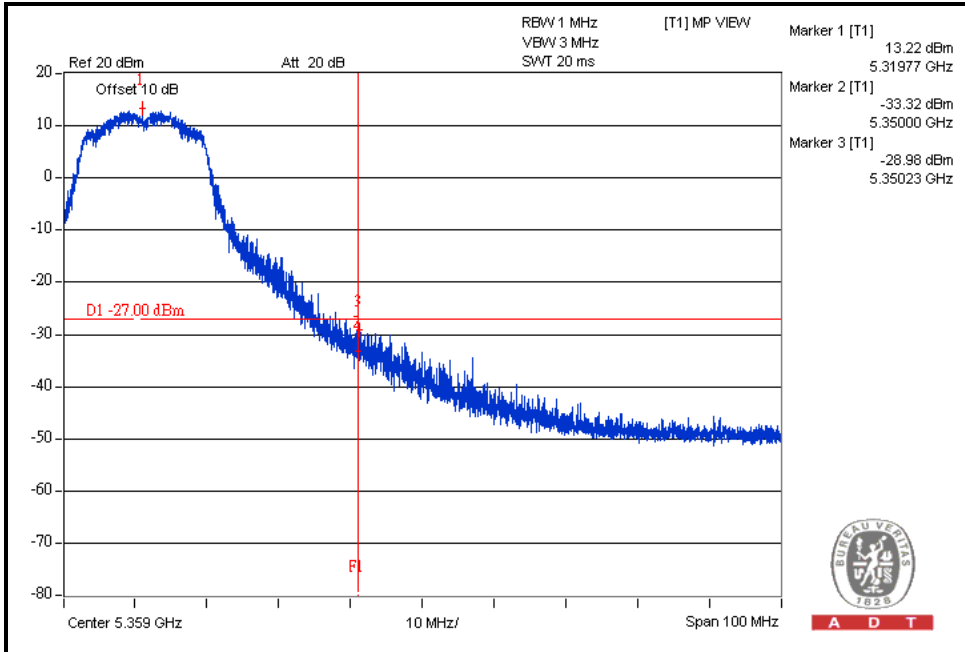



A D T

For 5.47 to 5.725GHz band:

The spectrum plots (Peak RBW=1MHz, VBW=3MHz) are attached on the following pages.





A D T

## 802.11a OFDM MODULATION

CH100

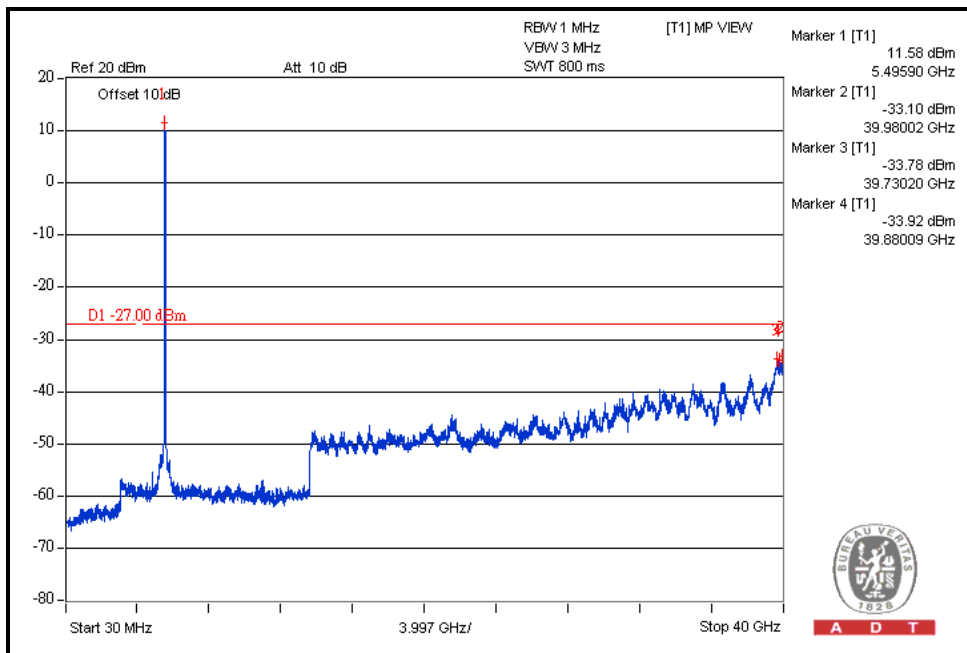
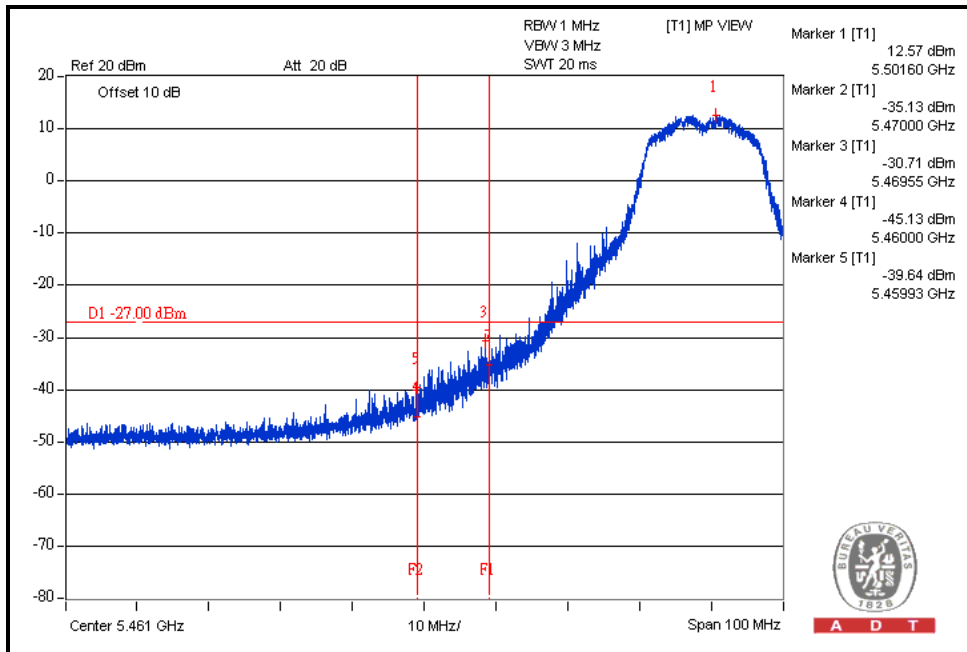





A D T

# CH140

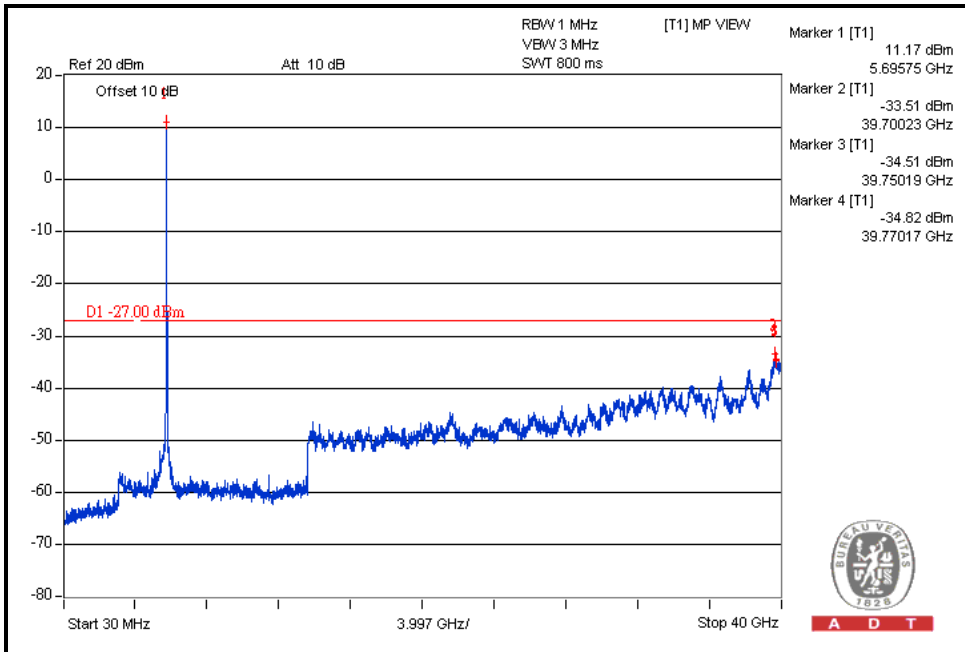
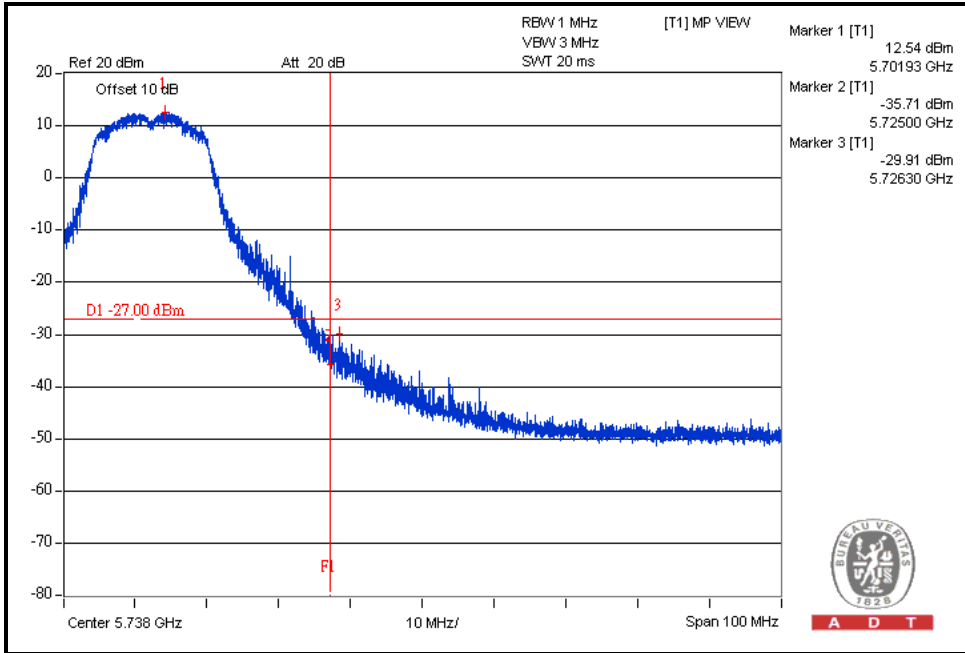



A D T

## 802.11n (20MHz) OFDM MODULATION:

CH100

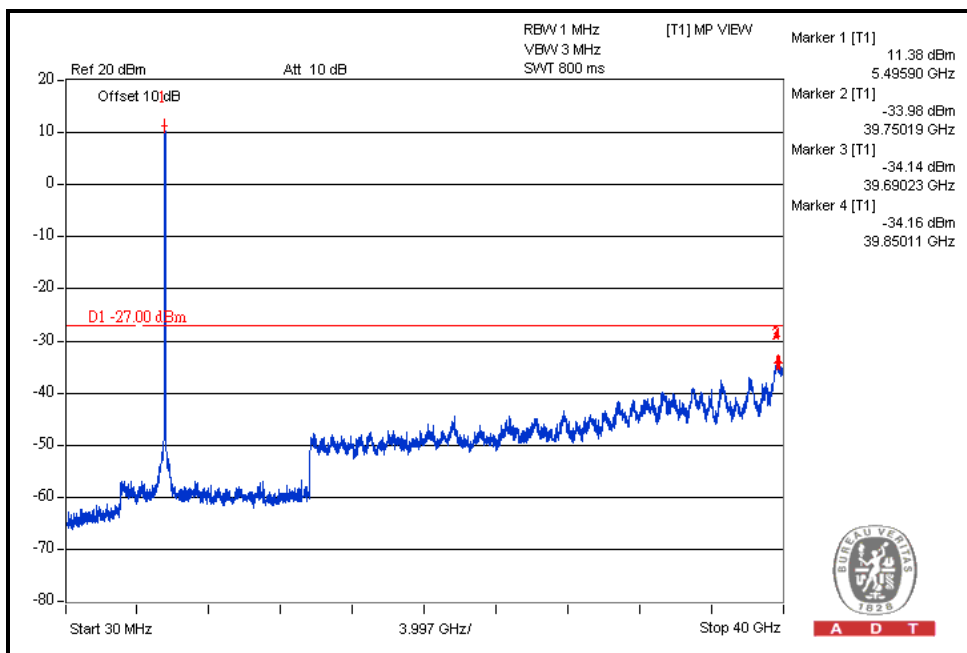
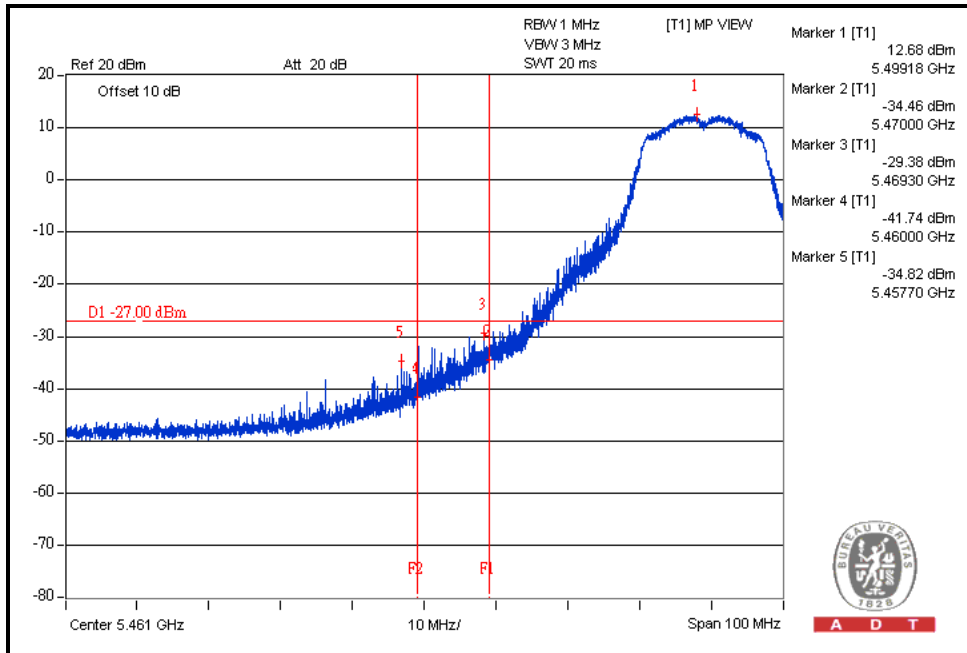



A D T

# CH140

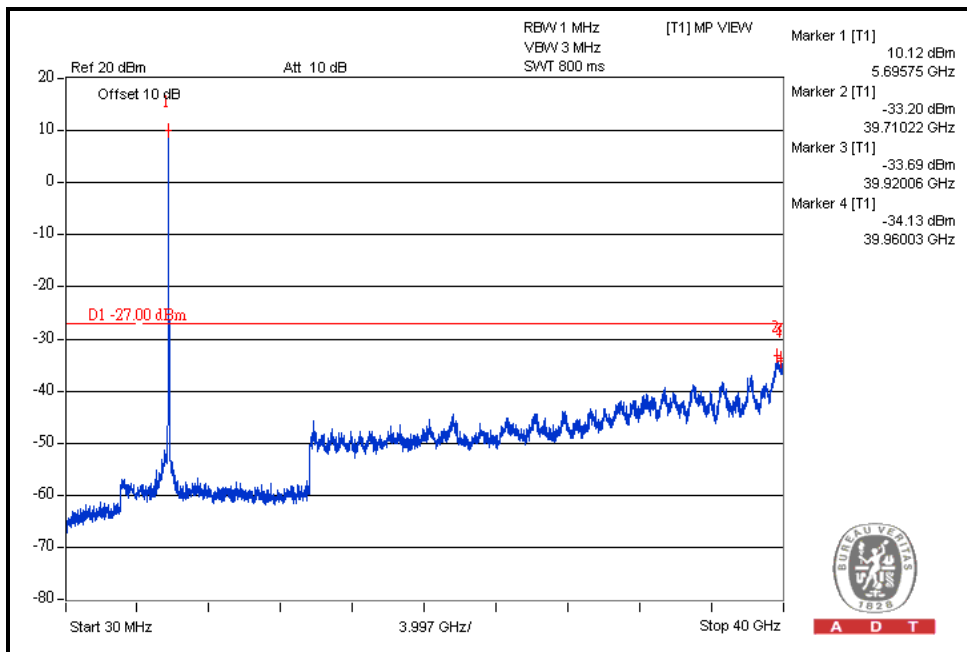
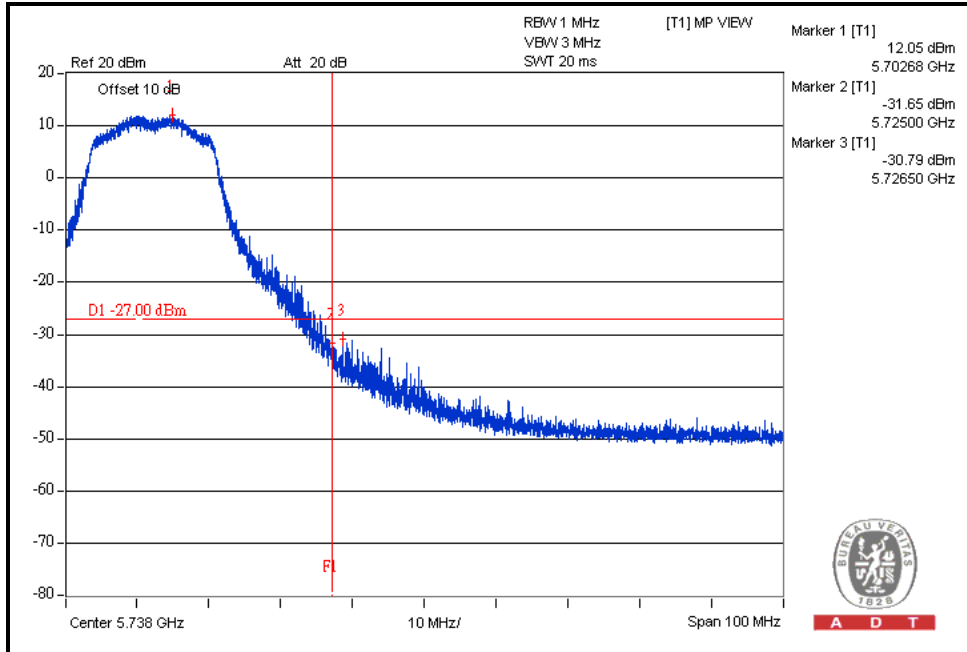



## 5. INFORMATION ON THE TESTING LABORATORIES

We, Bureau Veritas Consumer Products Services (H.K.) Ltd., Taoyuan Branch, were founded in 1988 to provide our best service in EMC, Radio, Telecom and Safety consultation. Our laboratories are accredited and approved according to ISO/IEC 17025.

Copies of accreditation and authorization certificates of our laboratories obtained from approval agencies can be downloaded from our web site:

[www.adt.com.tw/index.5.phtml](http://www.adt.com.tw/index.5.phtml).

If you have any comments, please feel free to contact us at the following:

**Linko EMC/RF Lab:**

Tel: 886-2-26052180

Fax: 886-2-26052943

**Hsin Chu EMC/RF Lab:**

Tel: 886-3-5935343

Fax: 886-3-5935342

**Hwa Ya EMC/RF/Safety/Telecom Lab:**

Tel: 886-3-3183232

Fax: 886-3-3185050

**Email:** [service.adt@tw.bureauveritas.com](mailto:service.adt@tw.bureauveritas.com)

**Web Site:** [www.adt.com.tw](http://www.adt.com.tw)

The address and road map of all our labs can be found in our web site also.



A D T

## **6.APPENDIX A - MODIFICATIONS RECORDERS FOR ENGINEERING CHANGES TO THE EUT BY THE LAB**

No modifications were made to the EUT by the lab during the test.

**--- END ---**