

# AIS Class B transceiver

Installation and operation manual



**Thank you for purchasing this AIS Class B transceiver**

This product has been engineered to offer you the highest level of performance and durability and we hope that it will provide many years of reliable service. We constantly strive to achieve the highest possible quality standards, should you encounter any problems with this product, please contact your dealer who will be pleased to offer any assistance you require.

## List of abbreviations

AIS	Automatic Identification System
AIS SART	AIS Search and Rescue Transmitter
AP	Access Point (Relating to WiFi behaviour)
AtoN	AIS Aid to Navigation
CD	Compact Disc
CE	European Declaration of Conformity
COG	Course Over Ground
COM	Common (electrical)
CPA	Closest Point of Approach
CS	Carrier Sense
DC	Direct Current
Dec	Decimal
DGPS	Differential GPS
DGNSS	Differential GNSS
DHCP	Dynamic Host Configuration Protocol
DOP	Dilution of Precision
DSC	Digital Selective Calling
DTM	Datum
ECDIS	Electronic Chart Display and Information System
ENI	Unique European Vessel Identification Number
EPFS	Electronic Position Fixing System
EPIRB	Emergency Position Indicating Radio Beacon
ERI	Electronic Reporting International

## List of abbreviations

---

ETA	Estimated Time of Arrival
EXT	External
FCC	Federal Communications Committee
GBS	GNSS satellite fault detection message
GFA	GNSS fix accuracy and integrity message
GGA	Global positioning system (GPS) fix data message
GLL	Geographic position - Latitude/longitude message
GLONASS	Globalnaya Navigazionnaya Sputnikovaya Sistema (Russian GNSS)
GND	Electrical Ground
GNS	GNSS fix data message
GNSS	Global Navigation Satellite System
GPS	Global Positioning System
GRS	GNSS range residuals message
GSA	GNSS DOP and active satellites message
GSV	GNSS satellites in view message
HDT	Heading true message
Hex	Hexadecimal
IEC	International Electrotechnical Commission
IMO	International Maritime Organisation
INT	Internal
IPx6	Ingress Protection (to powerful water jets)
IPx7	Ingress Protection (1m immersion for 30 minutes)
ISO	International Standards Organisation
Kt	Knots

LAT	Latitude
LCD	Liquid Crystal Display
LON	Longitude
LR	Long Range
MKD	Minimum Keyboard and Display
MMSI	Maritime Mobile Service Identity
MOB	Man Overboard
NC	Normally Closed (electrical)
NAV	Navigation
NM	Nautical Miles
NMEA	National Marine Electronics Association
PDF	Portable Document Format
PGN	Parameter Group Number
PI	Presentation Interface
R&TTE	Radio and Telecommunications Terminal Equipment Directive
RAIM	Receiver Autonomous Integrity Monitoring
RF	Radio Frequency
RMC	Recommended minimum specific GNSS data message
ROT	Rate of Turn
RX	Receive
SD	Secure Digital
SOG	Speed Over Ground
SOLAS	Safety of Life at Sea
SRM	Safety Related Message

## List of abbreviations

---

TCP	Transmission Control Protocol
TCPA	Time to Closest Point of Approach
TDMA	Time Division Multiple Access
THS	True heading and status message
TNC	Threaded Neill–Concelman (a type of connector)
TPI	Threads per Inch
TX	Transmit
UDP	User Datagram Protocol
UHF	Ultra High Frequency
UTC	Co-ordinated Universal Time
VBW	Dual ground/water speed message
VDM	All VDL AIS messages received
VDO	AIS own-ship broadcast data
VHF	Very High Frequency
VSWR	Voltage Standing Wave Ratio
VTG	Course over ground and ground speed message
WGS84	World Geodetic System 1984
WEEE	Waste Electrical & Electronic Equipment
WiFi	Wireless networking technology

## Table of contents

<b>1</b>	<b>Notices .....</b>	<b>9</b>
1.1	Safety warnings .....	9
1.2	General notices.....	10
1.3	Regulatory statements.....	11
<b>2</b>	<b>Introduction .....</b>	<b>15</b>
2.1	About AIS.....	15
<b>3</b>	<b>Installation and configuration.....</b>	<b>17</b>
3.1	What's in the box? .....	17
3.2	Preparing for installation .....	17
3.3	Installation procedures.....	18
3.4	Connecting the equipment.....	27
3.5	Grounding the AIS transceiver.....	36
3.6	Connection to an NMEA2000 network (optional).....	37
3.7	USB Connection .....	37
3.8	Turning the AIS transceiver on .....	37
3.9	Passwords and security .....	38
<b>4</b>	<b>Operation .....</b>	<b>39</b>
4.1	Using the AIS transceiver .....	39
4.2	Display and controls.....	40
4.3	Button functions .....	40
4.4	Adjusting display brightness .....	41
4.5	Menu navigation.....	42
4.6	Information displayed.....	44
4.7	Configuring vessel information.....	50
4.8	Confirming correct operation.....	52
4.9	Displaying AIS targets.....	53

4.10	Micro SD card data input.....	55
4.11	WiFi Feature.....	57
<b>5</b>	<b>Technical information.....</b>	<b>59</b>
5.1	AIS Transceiver overall dimensions.....	59
5.2	GNSS Antenna drawing.....	60
5.3	Troubleshooting.....	61
<b>6</b>	<b>Technical specification .....</b>	<b>65</b>
6.1	Applicable equipment standards.....	65
6.2	Product category.....	66
6.3	Physical.....	66
6.4	Environmental.....	67
6.5	Electrical.....	67
6.6	Display and user interface.....	67
6.7	Internal GNSS.....	68
6.8	TDMA Transmitter.....	68
6.9	TDMA Receiver.....	68
6.10	DSC Receiver.....	69
6.11	RF Connections.....	69
6.12	Data interface.....	70
6.13	Power and data connector information.....	71
6.14	Open source licences.....	71



## List of figures and tables

Figure 1	The AIS network .....	15
Figure 2	What's in the box? .....	17
Figure 3	Typical AIS transceiver connection.....	19
Figure 4	Mounting the AIS transceiver.....	21
Figure 5	Desk mounting the AIS transceiver .....	22
Figure 6	Panel mounting the AIS transceiver .....	23
Figure 7	GNSS Antenna location.....	24
Figure 8	GNSS Antenna connection.....	25
Figure 9	VHF Antenna location.....	26
Figure 10	VHF Antenna connection.....	27
Table 1	Accessory cable.....	28
Figure 11	Using the accessory cable.....	29
Figure 12	Serial input port connection .....	30
Figure 13	14 Way connector cable wiring connections.....	31
Table 2	14 Way connector serial data ports .....	31
Figure 14	Serial bi-directional port connection.....	32
Figure 15	18 Way connector cable wiring connections.....	33
Table 3	18 Way connector serial data ports .....	33
Table 4	Alarm relay connections .....	34
Figure 16	Power connection .....	35
Table 5	Power supply connections .....	35
Figure 17	Grounding the AIS transceiver.....	36
Figure 18	Enter password screen .....	38
Figure 19	AIS Transceiver front panel .....	40
Figure 20	Home page menu screen .....	42
Figure 21	Main menu structure .....	43
Figure 22	Display layout .....	44
Figure 23	GNSS Icons .....	45
Figure 24	Alarm icons .....	46
Table 6	Alarms list .....	48
Figure 25	Vessel dimension measurement.....	52
Figure 26	Target list screen .....	53
Figure 27	AIS target symbols displayed .....	54
Figure 28	Micro SD card Socket .....	56

Figure 29	AIS Transceiver dimensions .....	59
Figure 30	GNSS Antenna .....	60
Table 7	Troubleshooting .....	63

# 1 Notices

---



**When reading this manual please pay particular attention to warnings marked with the warning triangle symbol shown on the left. These are important messages for safety, installation and usage of the AIS transceiver.**

## 1.1 Safety warnings



This equipment must be installed in accordance with the instructions provided in this manual. Failure to do so may seriously affect its performance and reliability. It is strongly recommended that a trained technician installs and configures this product.



This product must be connected to protective ground via the ground connection point. It is essential that the ground connection point is used in all installations, regardless of what other equipment is connected. The ground connection point must be bonded to protective ground using as short a connection as possible.



This equipment is intended as an aid to navigation and is not a replacement for proper navigational judgement. Information provided by the equipment must not be relied upon as accurate. User decisions based upon information provided by the equipment are done so entirely at the users own risk.



Do not install this equipment in a flammable atmosphere such as in an engine room or near to fuel tanks.



It is recommended that this product is not installed in direct sunlight or under a windshield where it may be subject to excessive solar heating.



Do not attempt to service this equipment as doing so may cause fire, electric shock or malfunction and will invalidate the warranty. If any malfunctions are detected contact your supplier or service agent.



**NOT ALL SHIPS CARRY AIS.** The Officer of the Watch should always be aware that other ships and, in particular, leisure craft, fishing vessels and warships may not be fitted with AIS. Any AIS equipment fitted on other ships as a mandatory requirement may also be switched off based on the Master's professional judgement.

## 1.2 General notices

### 1.2.1 Position source

All marine AIS transceivers utilise a satellite based location system such as the GLONASS or GPS.



The accuracy of a GNSS position fix is variable and affected by factors such as the antenna positioning, how many satellites are used to determine a position and for how long satellite information has been received.

### 1.2.2 Compass safe distance

The compass safe distance of this AIS transceiver is 0.5m or greater for a 0.3° deviation.

### 1.2.3 Safe operating distance

The safe operating distance of this AIS transceiver is 20cm from the antenna.

### 1.2.4 Product category

This product is categorized as 'protected' in accordance with the definitions provided in IEC 60945.

### 1.2.5 Disposal of AIS transceiver and packaging

Please dispose of this AIS transceiver in accordance with the European WEEE Directive or with the applicable local regulations for disposal of

electrical equipment. Please dispose of the packaging in an environmentally friendly manner.

### **1.2.6 Accuracy of this manual**

This manual is intended as a guide to the installation, setup and use of this product. If you are in any doubt about any aspect of this product, please contact your dealer.

## **1.3 Regulatory statements**

### **1.3.1 Declaration of conformity - R&TTE**

The manufacturer of this product declares that this product is in compliance with the essential requirements and other provisions of the R&TTE directive. The declaration of conformity is provided as a PDF file on the product CD supplied with the product. The product carries the CE mark, notified body number and alert symbol as required by the R&TTE directive. The product is intended for sale in the following member states: Great Britain, France, Spain, Sweden, Austria, Netherlands, Portugal, Denmark, Norway, Belgium, Italy, Finland, Ireland, Luxembourg, Germany and Czech Republic.

### 1.3.2 FCC Notice



This equipment has been tested and found to comply with the limits for a class B digital device, pursuant to part 15 of the FCC Rules. These limits are designed to provide reasonable protection against harmful interference in a residential installation. This equipment generates, uses and can radiate radio frequency energy and, if not installed and used in accordance with the instructions, may cause harmful interference to radio communications.

This device complies with part 15 of the FCC Rules. Operation is subject to the following two conditions:

- (1) This device may not cause harmful interference, and
- (2) This device must accept any interference received, including interference that may cause undesired operation.

Changes or modifications not expressly approved by the party responsible for compliance could void the user's authority to operate the equipment.

### 1.3.3 Industry Canada Notice



This device complies with Industry Canada licence-exempt RSS standard(s). Operation is subject to the following two conditions:

1. This device may not cause interference, and
2. This device must accept any interference, including interference that may cause undesired operation of the device.

This Class B digital apparatus complies with Canadian ICES-003.

Le présent appareil est conforme aux CNR d'Industrie Canada applicables aux appareils radio exempts de licence. L'exploitation est autorisée aux deux conditions suivantes:

1. L'appareil ne doit pas produire de brouillage, et
2. L'utilisateur de l'appareil doit accepter tout brouillage radioélectrique subi, même si le brouillage est susceptible d'en compromettre le Fonctionnement.

Cet appareil numérique de la classe B est conforme à la norme NMB-003 du Canada.







---

## 2 Introduction

---

### 2.1 About AIS

The marine Automatic Identification System (AIS) is a location and vessel information reporting system. It allows vessels equipped with AIS to automatically and dynamically share and regularly update their position, speed, course and other information such as vessel identity with similarly equipped vessels. Position is derived from GLONASS or GPS and communication between vessels is by VHF digital transmissions.

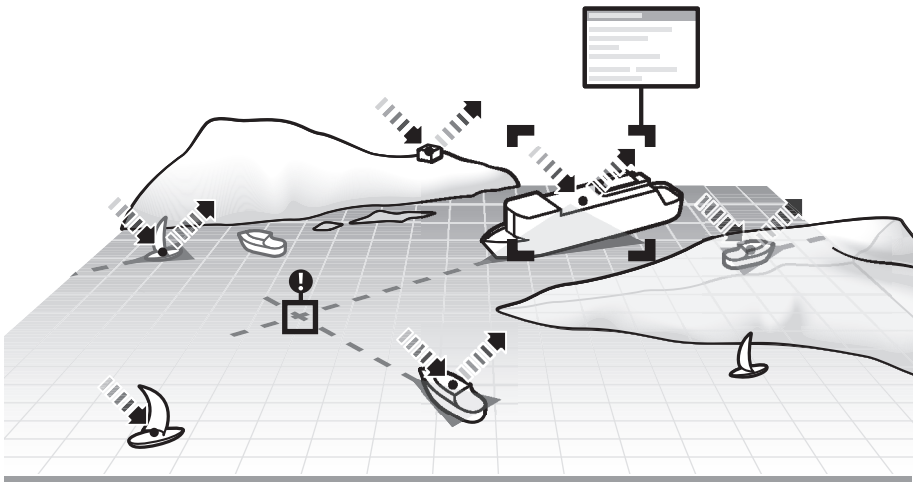

Figure 1 The AIS network



## 3 Installation and configuration

### 3.1 What's in the box?

Please ensure all items are present and if any of the items are missing please contact your dealer.

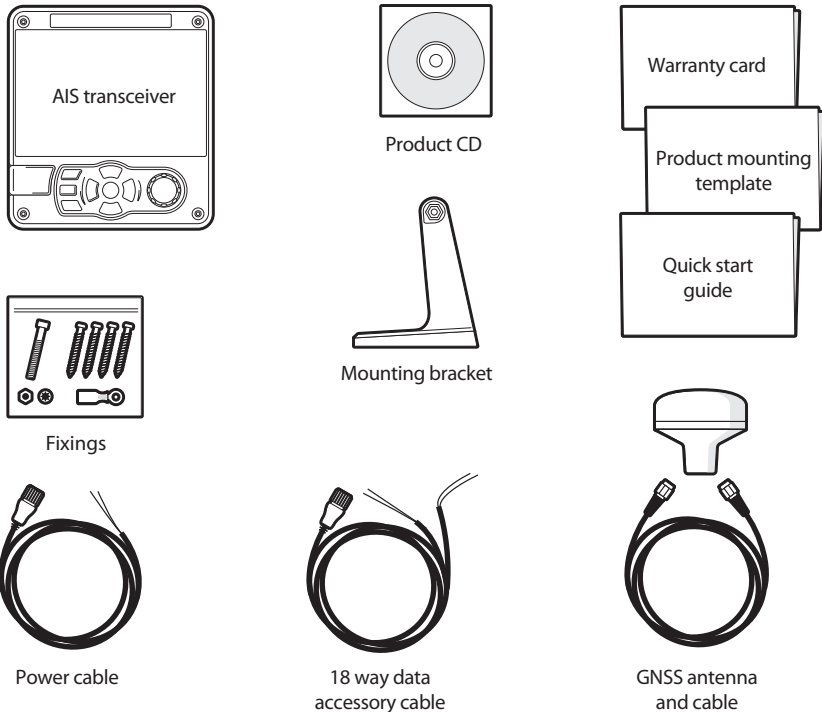

Figure 2 What's in the box?

### 3.2 Preparing for installation

In addition to the items provided with the AIS transceiver the following items will be required to complete the installation:

### **3.2.1 VHF Antenna**

Connection of a suitable VHF antenna will be required for the AIS transceiver to operate. The antenna cable should be terminated with a PL-259 (or UHF) connector. A surge arrester should be fitted in line with VHF antenna connector. See section 3.3.3 for more information.

Please take note of the warnings listed at the start of this manual regarding the installation and use of antennas.

### **3.2.2 Antenna cables**

The supplied GNSS antenna is provided with 10 metres (32.8ft) of cable. If this is not sufficient to reach between the desired GNSS antenna location and the AIS transceiver you will require an extension cable. Please contact your dealer for details.

### **3.2.3 GNSS Antenna mount**

A mounting bracket is required for the supplied GNSS antenna.

### **3.2.4 Data interface cables**

Suitable screened, multi core cable will be required to connect the ships sensor (DGPS, Gyro etc.) data ports to the AIS transceiver.

## **3.3 Installation procedures**

Before beginning installation of your AIS transceiver, please ensure that you read all of the instructions in this manual.

The following sections explain the installation process step by step for each of the main system elements. A typical system and connection diagram is provided in Figure 3.

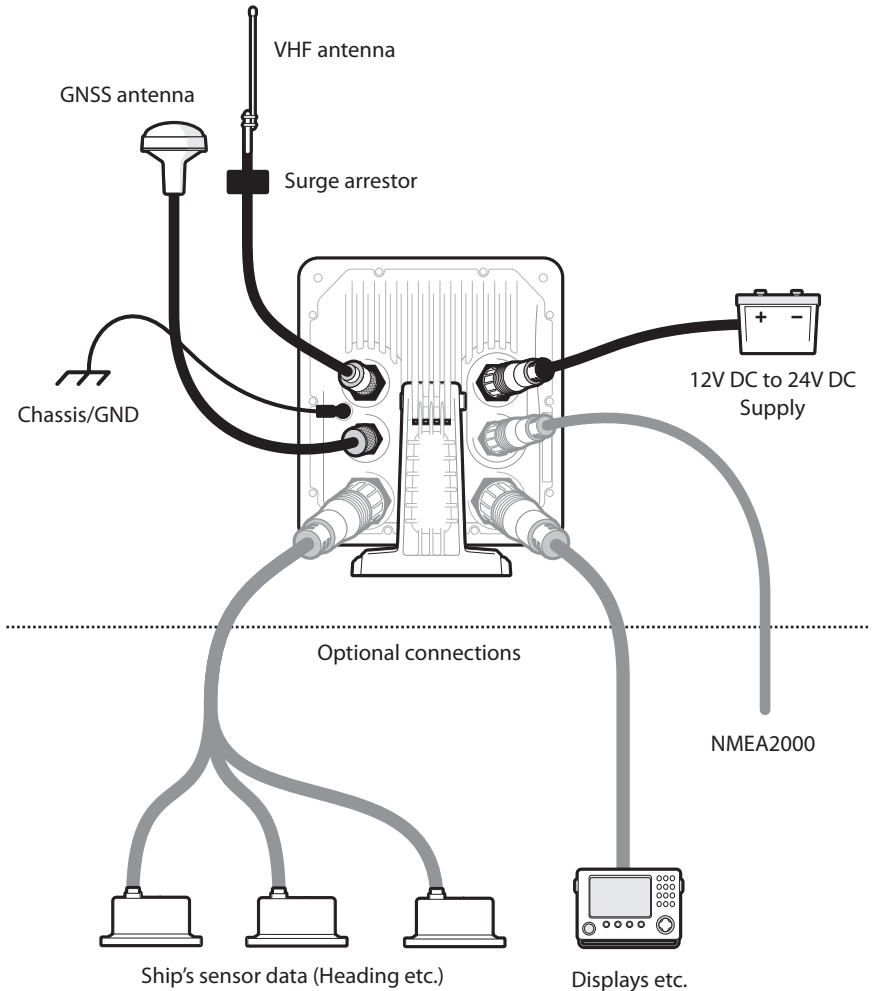
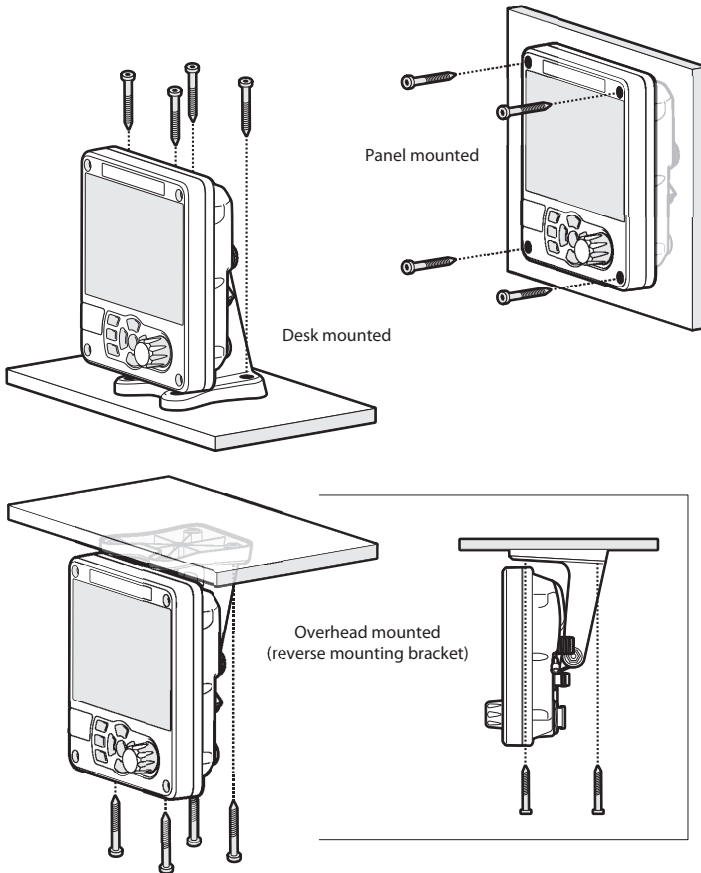

Figure 3 Typical AIS transceiver connection

### 3.3.1 Step 1 - Installing the AIS transceiver

Please note the following guidelines when selecting a location for your AIS transceiver:

- The AIS transceiver must be fitted in a location where it is at least 0.5m (1ft 8ins) from a compass or any magnetic device.
- There should be adequate space around the AIS transceiver for routing of cables. See Figure 29. for details of the AIS transceiver dimensions.
- The ambient temperature around the AIS transceiver should be maintained between -15°C and +55°C (5°F to 131°F). Ensure adequate ventilation is present when panel mounting the AIS transceiver.
- It is recommended that the AIS transceiver be installed in a 'below decks' environment protected from the weather.
- The AIS transceiver is supplied with four self tapping screws for attachment of the AIS transceiver to a suitable surface using the supplied bracket. Please refer to Figure 5. for guidance.
- The AIS transceiver can be panel mounted using the four self tapping screws provided. Please refer to Figure 6. for guidance. Access behind the panel is required when using this mounting option.
- The AIS transceiver should be mounted in a location where the display is visible to the user at the position from which the vessel is normally operated.



**Figure 4** Mounting the AIS transceiver

Refer to Figure 29. for dimensions. A drilling and cutting template is provided with the AIS transceiver.

To panel mount the unit it is necessary to remove the 4 off socket cap screws recessed in front of the unit. See Figure 6.

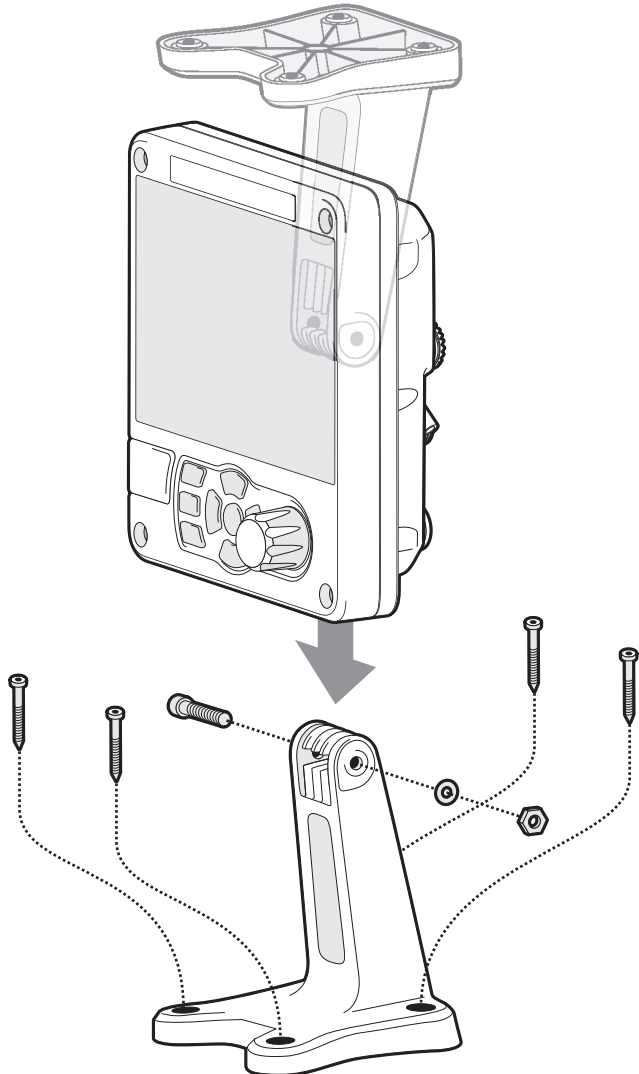
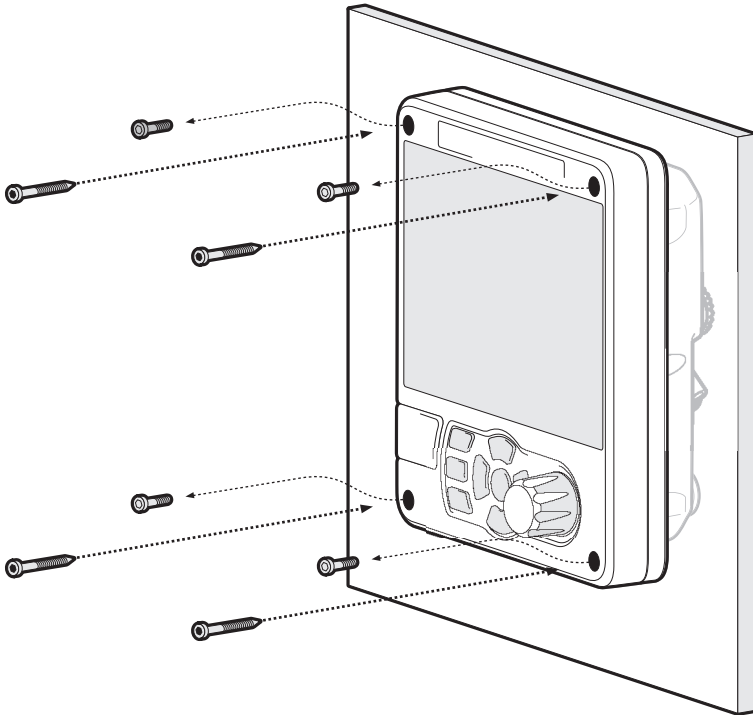

Figure 5 Desk mounting the AIS transceiver





*Figure 6 Panel mounting the AIS transceiver*

### **3.3.2 Installing the GNSS antenna**

For mounting the GNSS antenna supplied with your AIS transceiver you will require a one inch 14 TPI pole mount. Contact your dealer to source a mount suitable for the installation location.

Please note the following guidelines when selecting a location for the GNSS antenna:

- The GNSS antenna mount should be secured to a rigid surface.

- The GNSS antenna should be located where it has a clear, unobstructed view of the sky overhead.
- The GNSS antenna should be mounted as high as possible, however it is not recommended to mount the antenna on the top of a high mast where the motion of the vessel will cause the antenna to move and potentially reduce the accuracy of the GNSS position.
- Route the GNSS antenna cable to the AIS transceiver. If extension cables are required all junctions should be made using appropriate co-axial connectors and made watertight.

Connect the GNSS antenna cable to the GNSS connector on the AIS transceiver.

GNSS Antenna should be at least 5m (16ft) from radar or satellite communication antennas. It should also be away from the radar beam path and mounted on a rigid surface.

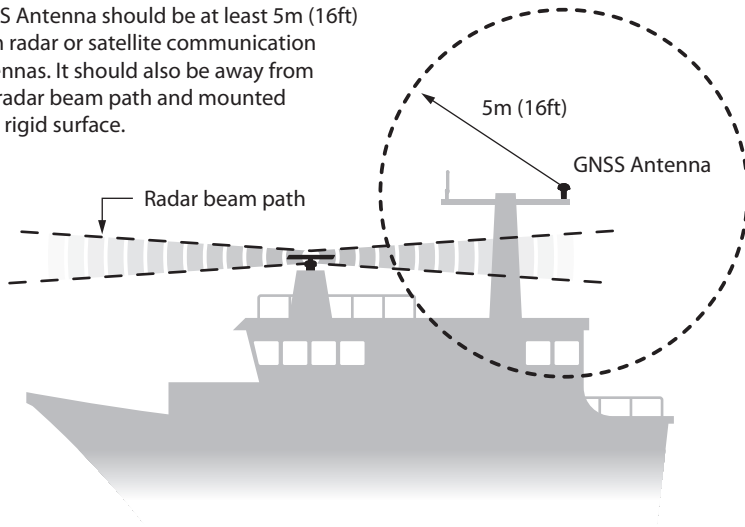

*Figure 7 GNSS Antenna location*

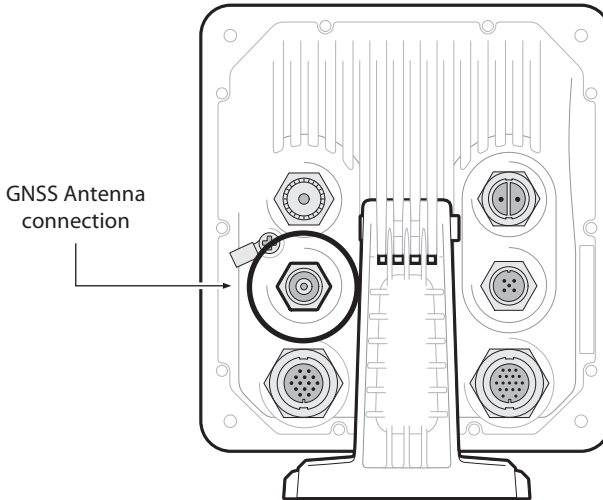

*Figure 8 GNSS Antenna connection*

### **3.3.3 Installing the VHF antenna**

Please note the following guidelines when selecting and locating the AIS VHF antenna:

- The VHF antenna should be located as high as possible and positioned as far from other antennas as possible.
- The VHF antenna should have omnidirectional vertical polarization.
- Where possible the VHF antenna should be installed at least 3m (10ft) away from other transmitting radio, satellite and radar antennas.
- Ideally the AIS VHF antenna should be mounted directly above or below the ship's primary VHF radiotelephone antenna, with no horizontal separation and with a minimum of 2m vertical separation. Refer to Figure 9. for further guidance.

- The VHF antenna cable should be kept as short as possible to minimize signal loss. High quality, low loss co-axial cable appropriate to the installation location should be used.
- The VHF antenna cable should be terminated in a PL-259 co-axial connector for connection to the AIS transceiver.
- Any outdoor installed connectors in the antenna cables should be waterproof by design.
- Antenna cables should be installed in separate signal cable channels at least 10cm (4ins) away from power supply cables. Crossing of cables should be done at right angles and sharp bends in the antenna cables should be avoided.
- It is recommended that a suitable surge arrestor is fitted in-line with the VHF antenna connector.

Connect the VHF antenna cable to the VHF connector on the AIS transceiver as shown in Figure 10.

VHF Antenna should be at least 3m (10ft) from other transmitting radio, satellite and radar antennas.

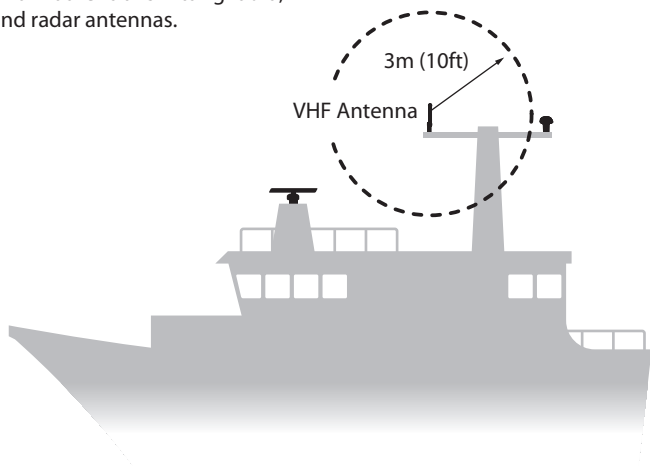

*Figure 9 VHF Antenna location*

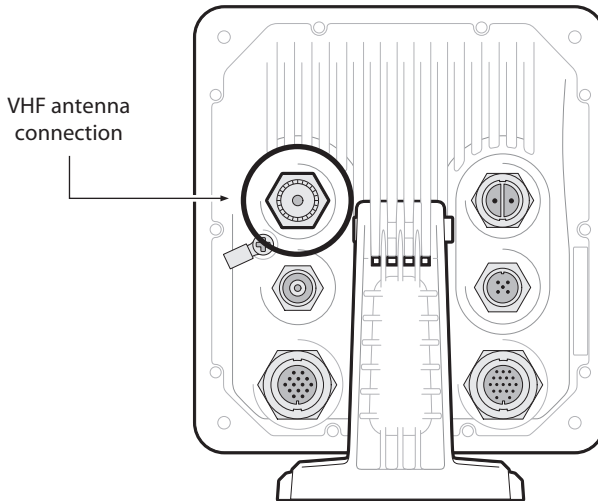

Figure 10 VHF Antenna connection

## 3.4 Connecting the equipment

### 3.4.1 Data connections

The accessory cable provides a simple method of implementing a typical Class B installation with minimum difficulty. If the planned installation is more complex it is recommended to use the optional fully wired cables and Junction box for greater flexibility

An accessory cable is supplied with the product to provide connections to the NMEA0183 bi-directional data ports. The cable has a pre-moulded connector at one end which should be connected to the 18-way connector on the rear of the unit.

The other end of the cable has colour coded wires ready for connection. The table in Table 1 lists the function of each colour coded wire for reference.

Decription	Port Name in MKD	Wire Colour	Pin	Function
NMEA0183 Port 1 COM	External display 2	Black	1	High speed NMEA0183 output (38,400baud) intended for chart plotters
NMEA0183 Port 1 Tx+	External display 2	Blue/White	3	
NMEA0183 Port 1 Tx-	External Display 2	White/Blue	4	
NMEA0183 Port 2 Rx+	Bi-directional serial port	Red/White	6	Can be set to low speed (4,800 baud) intended for connection to other NMEA0183 compatible sensors for multiplexing of data to the chart plotter
NMEA0183 Port 2 Rx-	Bi-directional serial port	Orange/White	10	
NMEA0183 Port 2 COM	Bi-directional serial port	Black	11	

*Table 1 Accessory cable*

The Accessory Cable provides independent connection to the transmit side of one NMEA0183 port and to the receive side of another NMEA0183 port. This permits independent setting of transmit and receive baud rates, enabling flexible connection to two external pieces of NMEA equipment.

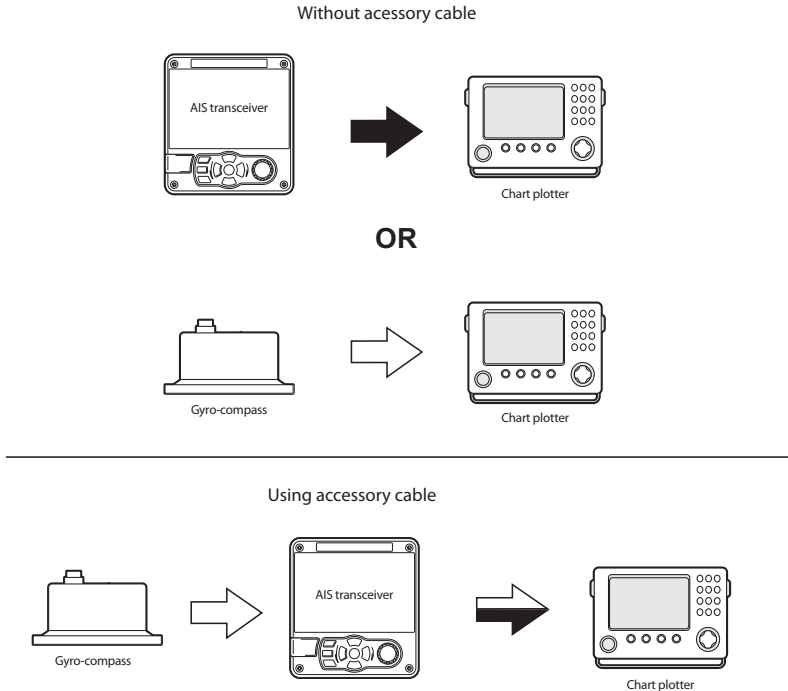

*Figure 11 Using the accessory cable*

A multiplexing feature is provided, which means any messages which are received via the NMEA 2 port are automatically re-transmitted via the NMEA 1 port. Thus two independent NMEA data streams, AIS and external data are merged into one. This is particularly useful when using a chart plotter having only a single NMEA0183 port, for example: An additional sensor such as a gyro-compass can be connected to the AIS transceiver via the input port and the AIS transceiver can be connected via the output port to the chart plotter resulting in the chart plotter receiving both AIS information and heading information simultaneously.

It is important to ensure that the equipment is configured to use the matching baud rates.

### 3.4.2 Sensor configuration

For more complex installations the AIS transceiver has six NMEA0183 (IEC61162-1/2) data ports for connection of ship's sensors and display equipment as described in Table 2. and Table 3.

There are three input only ports for ship's sensor data and three bi-directional high speed ports for connection of display equipment. These can be connected using an accessory cable pack purchased through your dealer.

### 3.4.3 Data input ports (14 way connector)

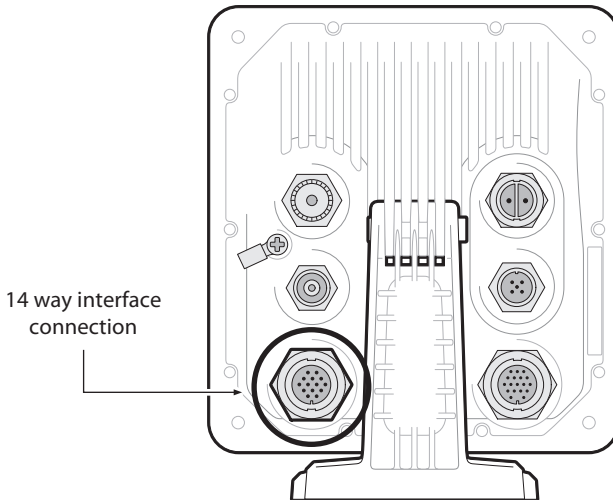

*Figure 12 Serial input port connection*



SIGNAL	WIRE COLOUR	PIN
NOT USED	BLACK	1
NOT USED	BROWN	3
SILENT N	BLUE	6
SILENT P	RED	7
SENSOR 1 RX A	ORANGE	2
SENSOR 1 RX B	PURPLE	5
SENSOR 1 COM	GREEN	8
SENSOR 2 RX A	WHITE	9
SENSOR 2 RX B	WHITE / BLACK	12
SENSOR 2 COM	GREY	11
SENSOR 3 RX A	YELLOW	14
SENSOR 3 RX B	RED / BLACK	13
SENSOR 3 COM	PINK	10
CHASSIS	DRAIN WIRE	4

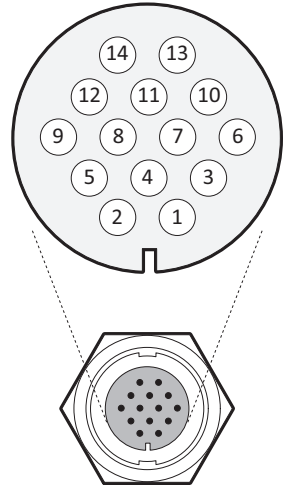

Figure 13 14 Way connector cable wiring connections

Data port	Function	Type	Default baud rate
1	Sensor 1 input	Receive only	4800
2	Sensor 2 input	Receive only	4800
3	Sensor 3 input	Receive only	4800

Table 2 14 Way connector serial data ports

**Note:** Any unused ports should be terminated by a 120 Ohm resistor across RX A and RX B signals.

### 3.4.4 Silent mode switch

To activate the Silent mode switch, apply a voltage of between 2V and 30V to the SILENT P (Pin 7) and SILENT N (Pin 6) terminals of the 14 way connector.

### 3.4.5 Data bi-directional ports (18 way connector)

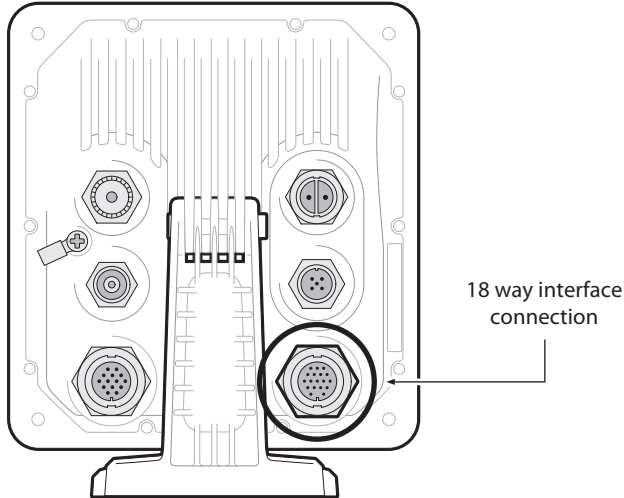

*Figure 14 Serial bi-directional port connection*

SIGNAL	WIRE COLOUR	PIN
SERIAL PORT TX A	ORANGE	3
SERIAL PORT TX B	BROWN	4
SERIAL PORT RX A	PURPLE	7
SERIAL PORT RX B	BLUE	8
SERIAL PORT COM	BLACK	1
EXT DISPLAY 2 TX A	RED	2
EXT DISPLAY 2 TX B	RED / WHITE	5
EXT DISPLAY 2 RX A	PINK	6
EXT DISPLAY 2 RX B	YELLOW	10
EXT DISPLAY 2 COM	GREEN	11
ALARM NC	GREY	16
ALARM COM	WHITE	12
EXT DISPLAY 1 TX A	ORANGE / WHITE	13
EXT DISPLAY 1 TX B	BLACK / WHITE	17
EXT DISPLAY 1 RX A	BROWN / WHITE	14
EXT DISPLAY 1 RX B	YELLOW / WHITE	18
EXT DISPLAY 1 COM	GREEN / WHITE	15
CHASSIS	DRAIN WIRE	9

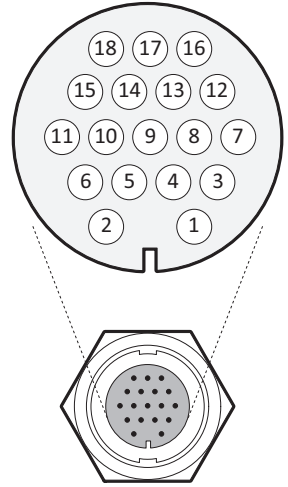

Figure 15 18 Way connector cable wiring connections

Data port	Function	Type	Default Baud rate
4	External display / ECDIS	Bi-directional	38400
5	Pilot port	Bi-directional	38400
6	Serial port	Bi-directional	38400

Table 3 18 Way connector serial data ports

**Note:** Any unused ports should be terminated by a 120 Ohm resistor across RX A and RX B signals.

All sensor ports can be configured via the Interface settings menu which can be found under the 'Home' > 'System settings' > 'Interfaces' menu option.

### 3.4.6 Alarm connections

The AIS transceiver also provides connections to the alarm relay contacts. The alarm relay connections are described in Table 4.

Alarm connection	Function	Contact rating
COM	Alarm relay common connection	2A at 220VDC or 60W maximum
NC	Alarm relay normally closed connection	

*Table 4 Alarm relay connections*

### 3.4.7 Power connection

Power is connected to the AIS transceiver via the supplied 2 way power cable as shown in Figure 16.

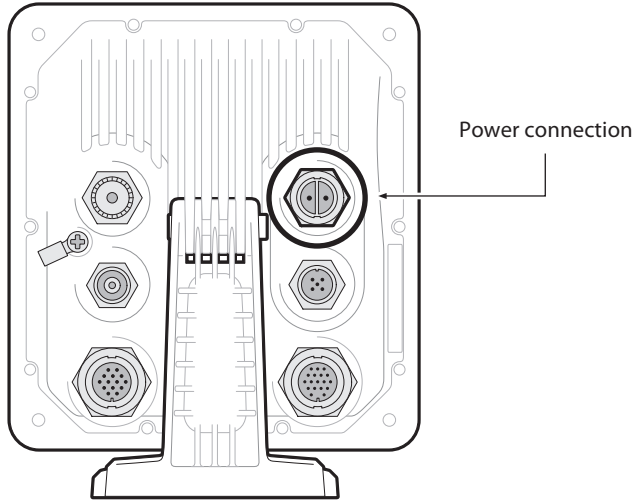

Figure 16 Power connection

Wire colour	Function	Connect to
Red	Power supply +	12VDC to 24VDC power supply
Black	Power supply -	Power supply ground

Table 5 Power supply connections

The power supply current ratings and recommended fusing or circuit breaker currents are as follows:

- A 12VDC supply should be able to provide a peak current of 4.0A and be fused at 6.3A.
- A 24VDC supply should be able to provide a peak current of 3.0A and should be fused at 5.0A.

### 3.5 Grounding the AIS transceiver

An M4 grounding screw and ring crimp are provided in the fixing kit to allow connection to the grounding point on the rear of the AIS transceiver chassis as indicated in Figure 17.

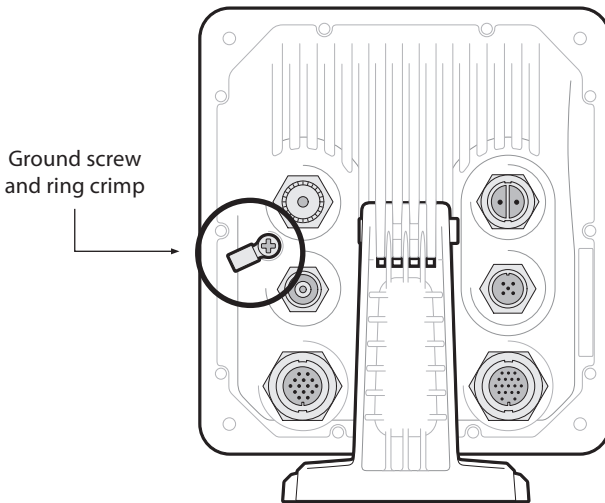

Figure 17 Grounding the AIS transceiver



**This product must be connected to protective ground via the ground connection point. It is essential that the ground connection point is used in all installations, regardless of what other equipment is connected. The ground connection point must be bonded to protective ground using as short a connection as possible.**

### 3.6 Connection to an NMEA2000 network (optional)

The AIS transceiver can be connected to an NMEA2000 network by a suitable NMEA2000 network cable available from your local dealer. If your vessel has an NMEA2000 network please refer to the relevant documentation for your NMEA2000 equipment. Once connected, and with your chart plotter also connected you will be able to receive AIS targets on your chart plotter.

### 3.7 USB Connection

A USB cable is available for connection to a PC or Mac. The USB connector can be connected directly to the USB port on the PC or Mac via the optional USB cable. To enable connection of the AIS transceiver to a PC the USB drivers, supplied on the product CD, must first be installed. Driver installation is typically not required for use with a Mac.

To install the drivers please follow the steps below:

1. Insert the CD into the PC and navigate to the USB drivers folder.
2. Double click on the setup.exe file to launch the installer.
3. Follow the on screen installation instructions to complete installation.
4. Once installed the AIS unit can be connected to the PC. The USB drivers will be installed automatically and the AIS will appear as a new COM port device.
5. Select the AIS COM port and a baud rate of 38,400 in PC based navigation software to make use of the AIS data.



**If the USB connection is removed from the PC or Mac during use you must reset the connection before further use. To reset the connection, disconnect then reapply power to the AIS before closing and relaunching any PC or Mac applications using the USB connection. Finally, reconnect the USB cable between the PC or Mac and the AIS transceiver**

### 3.8 Turning the AIS transceiver on

The AIS transceiver does not have an On / Off switch and will operate immediately that power is applied to the unit.

### 3.9 Passwords and security

The WiFi feature in this AIS transceiver may require a password to be entered. In order to do this, you will be prompted by a password entry screen.

The password entry screen is shown in Figure 18. Highlight the required character, then press 'Select' to enter that character. When all characters of the password have been entered, select 'OK'.

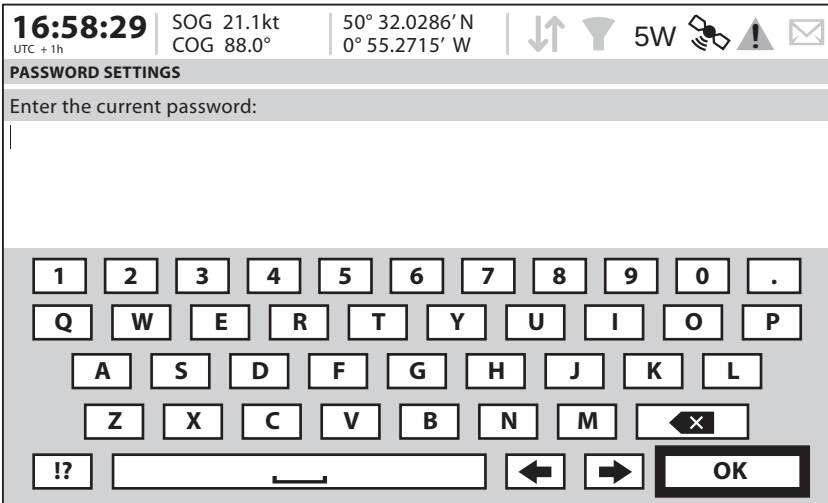

Figure 18 Enter password screen



## 4 Operation

---

Please read the warning notices at the front of this manual before operating the AIS transceiver.

### 4.1 Using the AIS transceiver

Once the unit has been configured it is ready for use. Providing other vessels with AIS transceivers installed are within radio range of your vessel you should see their details appear on your target list.

These vessels will also be able to see your vessel on their chart plotter or PC. It may take up to six minutes for your full vessel details to be visible to others. Specific details of how to configure your chart plotter to make use of the AIS transceiver features will be given in your chart plotter manual.

If you are using charting software running on a PC, please refer to the instructions provided with your chart plotting software for details of how to configure it to display AIS information.

## 4.2 Display and controls

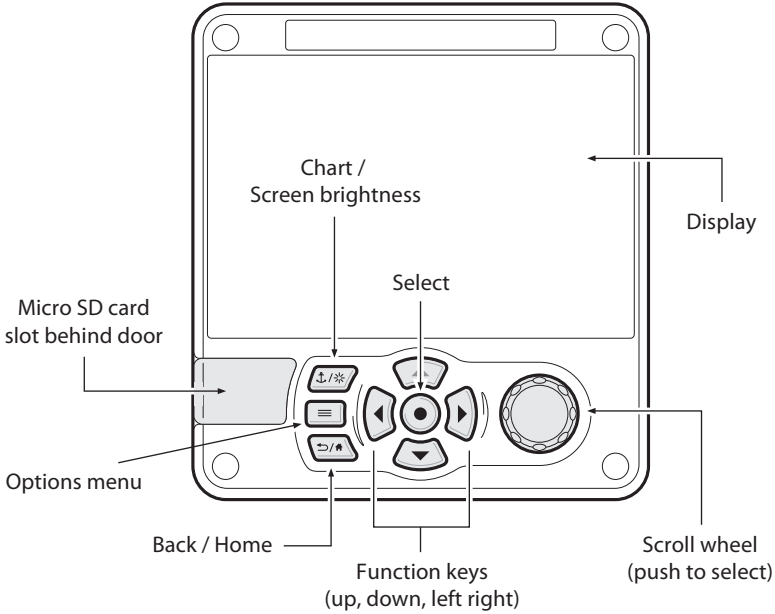

Figure 19 AIS Transceiver front panel

The front panel of the AIS transceiver is shown in Figure 19. with each control marked.

## 4.3 Button functions

**Scroll wheel.** This is used to highlight information presented on the display. The scroll wheel can also be pressed to confirm data entry or select information.

**Chart / Screen brightness key.** When pressed with a short press will go to the Chart screen. When pressed and held it will go to the 'Display brightness' screen.

**Options menu key.** Provides access to additional features and relevant shortcuts on certain screens.

**Back / Home key.** When pressed with a short press cancels the current operation and moves to the previous menu or if pressed and held will return to the home screen.

**Select key.** When pressed selects the current option highlighted on the screen.

**Up, down, left and right function keys.** Provide an alternative means of navigating around the screen.

**Speaker.** The speaker is located behind the 'Scroll' wheel and can provide an audible sound when a key is pressed, a message is received, or an alarm is activated. Sounds can be enabled or disabled via the Sound Settings menu.

**Micro SD card.** The Micro SD card socket (behind the door) is provided to allow uploading of new software to the AIS transceiver.

**Display.** The display shows essential AIS operating information and allows for configuration of the AIS transceiver via the menus.

#### **4.4 Adjusting display brightness**

Press and hold the '*Chart / Screen brightness*' key. The screen will change to the '*Display Settings*' screen.

## 4.5 Menu navigation

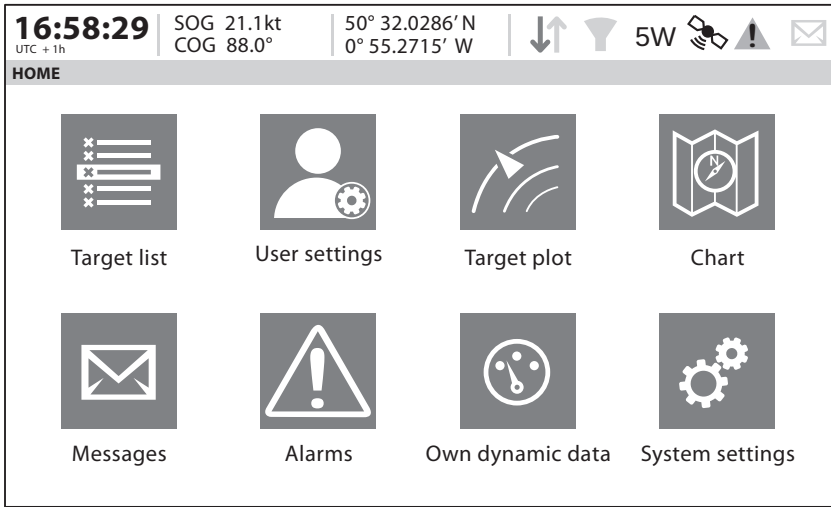

Figure 20 Home page menu screen

### 4.5.1 Main / Sub menus

Menus are displayed as a set of icons which can be navigated by using the controls. Selection of an icon will then display the information beneath in accordance with Figure 21. Pressing the 'Back / Home' key will exit the menu.

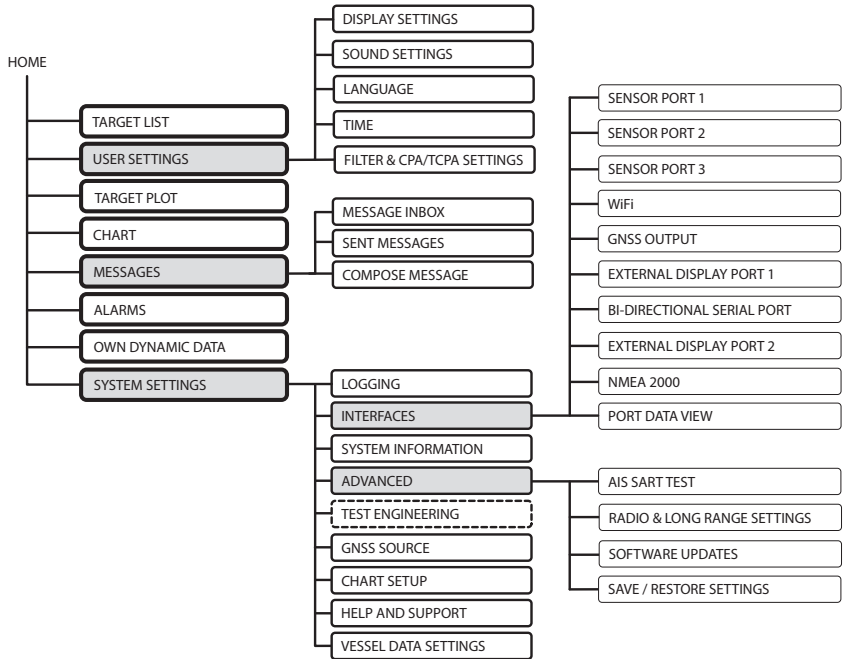

Figure 21 Main menu structure

### 4.5.2 Data entry screens

Some screens allow you to enter data, such as vessel parameters. On these screens you navigate to the desired field and select the appropriate menu item. Pressing the 'Back / Home' key will exit these menus.

### 4.5.3 Keyboard / Keypad screens

Some screens require text or numeric entry. When these are selected, a virtual keyboard is displayed which can be used to enter text or numbers.

#### 4.5.4 Options menu

On certain screens, the Options Menu will bring up a further list of functions specific to that screen. This is indicated by this icon. ☰

### 4.6 Information displayed

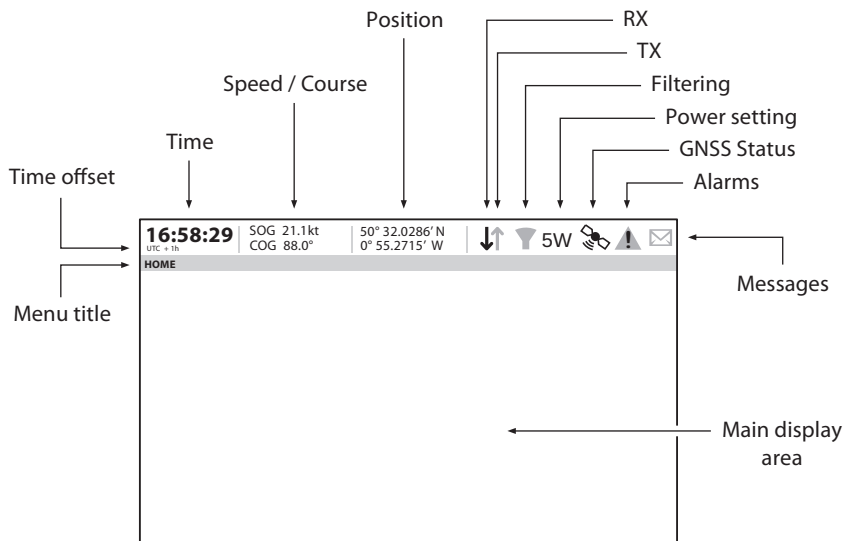

Figure 22 Display layout

#### 4.6.1 Menu title

Refers to the current menu displayed from Figure 21.

#### 4.6.2 Time

Time derived from GNSS satellites or AIS Base Stations.

#### 4.6.3 Time offset

Offset from UTC, set on the 'Time' menu.

#### 4.6.4 Speed / Course

Vessel speed and course as taken from GNSS satellite data.

#### 4.6.5 Position

Vessel position taken from GNSS source.

#### 4.6.6 Icons

**RX** - Illuminates to show receiving an AIS message.

**TX** - Illuminates to show transmission of an AIS message.

**Filtering** - Illuminated to show that target filter settings apply.

**Alarms** - Displays an alarm icon to show the presence of acknowledged or unacknowledged AIS alarms.

**Messages** - Displays an envelope icon with a number to show the presence of AIS messages received See menu '*Messages*'.

**GNSS Status** - Displays an icon to show if GNSS data is being received.

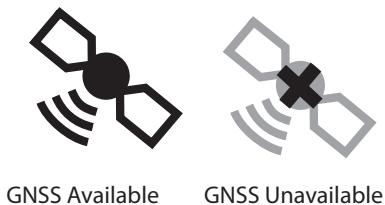

Figure 23 GNSS Icons

**Power** - Displays “1W” or “5W” to indicate the current radio power output.

#### 4.6.7 Alarms

The AIS transceiver performs self checking functions continuously. If a self check fails a display will appear on the screen notifying the operator of this. This will be accompanied by a sound. The alarm can be acknowledged via an on-screen message. The list of currently active AIS Alarms can be displayed by accessing the 'Alarms' menu. Certain AIS Alarms can be switched off in the 'Alarm Settings' menu. This is available from the 'Options' menu.

The alarm conditions are displayed at the top of the screen and are represented as follows:



*New unacknowledged alarm, this will flash.*



*New acknowledged alarm.*



*No active alarms.*

*Figure 24 Alarm icons*

If any alarm condition persists, contact your dealer or installer.



Possible alarm conditions are listed Table 6.

Alarm	Description
TX Malfunction	<p><b>This alarm will occur if the MMSI has not been configured.</b></p> <p>This alarm can also occur if the radio hardware has failed to select the correct frequency, that the output power is too low or a transmitter shutdown has occurred. In this situation, ALR 001 is output. The alarm will be cleared if the transmitter recovers normal operation.</p>
RX Channel x malfunction	<p>This alarm occurs should the receiver hardware malfunction. The receiver is identified by the value of x (as shown below). The following alarms will be generated in this condition:</p> <p>ALR 003 - Rx Channel 1  ALR 004 - Rx Channel 2  ALR 005 - DSC (Channel 70)</p> <p>If the receiver returns to normal operation this alarm will be cleared.</p>
Antenna VSWR exceeds limit	<p>This alarm occurs if there is a problem with your antenna or antenna connection.</p>
No valid COG information	<p>This alarm occurs if the AIS transceiver has no valid Course Over Ground information from any connected sensor.</p>
No valid SOG information	<p>This alarm occurs if the AIS transceiver has no valid Speed Over Ground information from any connected sensor.</p>

Alarm	Description
Heading lost or invalid	This alarm occurs if the AIS transceiver has no valid heading information from any connected sensor, or if the heading is undefined.
No sensor position in use	This alarm occurs if the AIS transceiver has no valid position information from any connected sensor.
UTC Sync Invalid	This alarm indicates that the transmitter is no longer directly synchronized with the GNSS receiver. This may be because the GNSS receiver cannot receive sufficient satellites.
Heading sensor offset	This alarm occurs if the difference between the course over ground and heading data is greater than 45° for more than 5 minutes. This alarm only occurs if the vessel speed over ground is greater than 5 knots.

*Table 6 Alarms list*

#### **4.6.8 Messages**

Messages can be received from other AIS equipped vessels and also sent to specific vessels (addressed messages) or sent to all vessels in range (broadcast messages).

Reception of an AIS text message is indicated by the presence of the message icon at the top of the screen. This icon is shown whenever there are unread AIS text messages. Messages can be reviewed and replied to via the Inbox. The AIS transceiver can store up to a maximum of 20 messages in the Inbox and 20 messages in the Sent folder. If the number of messages exceeds 20 then the oldest message will be overwritten.

When a Safety Related Message is received the user will be notified immediately with a pop-up showing the message. Standard text messages are

not displayed on receipt, however the message icon will be displayed at the top of the screen.

AIS messages can be viewed, created and transmitted from the 'Messages' menu.

The available options are:

Compose - takes you to the message composition screen

Inbox - takes you to the received message list view

Sent - shows a list of recently sent messages.

To compose a new message, select the type of message from the drop down menu and the destination. This can be by directly entering the MMSI, or by selecting from a list of visible targets.

The message text is entered using the on screen keyboard. Messages are limited to 80 characters in length.



**Class B AIS transceivers are permitted to receive broadcast SRMs and broadcast text messages, however this function is not mandatory. Class B AIS transceivers are not able to receive addressed SRM or text messages. There is therefore no guarantee that text messages or SRMs sent to a Class B AIS transceiver will be received.**

#### 4.6.9 Chart

The AIS transceiver contains an application which will display AIS targets received, along with its own vessel position on a chart style plot.

The chart can be scrolled up, down, left, and right using the 'Function' keys. Zooming in and out is via the 'Scroll' wheel.

Targets can be selected by moving the cross hairs over a target and pressing the 'Select' key.

The 'Options' menu is also available for more advanced features.

Within the 'Options' menu, the chart can be oriented to either North, Heading, or Course Up. The chart can be set so that the own vessel position is always in the centre of the screen.

The chart can be de-cluttered by hiding filtered targets, or vessel names from the display.

SOG vectors can also be displayed on the screen if this item is selected from the *'Options'* menu.

Some of the layers displayed on the chart can be removed to provide more clarity on the display. The *'Chart Settings'* screen provides a way of modifying these.

The chart feature is an aid for the display of information only and should not be used for vessel navigation.

### **4.6.10 Help and support screen**

This screen is available from the *'Home'* > *'System Settings'* menu and provides contact information for the product manufacturer.

It also provides relevant information from the User Manual.

### **4.6.11 User settings screen**

From this screen, it is possible to set the display brightness, set the display to a day or night colour scheme, and configure the sounds emitted by the device. It is also possible from this screen to set the UTC time offset, change the filter settings and display the menus in a number of non-English languages.

## **4.7 Configuring vessel information**

### **4.7.1 Pre-configuration checks**

To proceed with configuration the steps in Section 3. should already have been completed.

### **4.7.2 Configuring vessel identification information**

The AIS transceiver must be configured with information about the vessel on which it is installed prior to operation. The following information is required to be entered in the *'Home'* > *'system settings'* > *'Vessel data settings'* menu:

- MMSI - Vessel MMSI number, this can usually be found on the ships VHF radio license and should be the same MMSI as used for the VHF / DSC radio.
- Ship name (limited to 20 characters)
- Callsign - Vessel radio call sign (limited to 7 characters)

- Ship type - Selected from the menu provided.
- Reference dimensions of the location of the GNSS antenna connected directly to the AIS transceiver.



**Please ensure that you enter all vessel data accurately. Failure to do so could result in other vessels failing to identify your vessel correctly. The vessel MMSI can only be programmed once, please take care to program your MMSI correctly. If you need to change the MMSI for any reason, please contact your dealer who will arrange to have the MMSI reset.**

#### **4.7.3 Configuring the GNSS receiver**

The GNSS receiver can be configured to operate in one of three modes:

- GLONASS and GPS – in this mode the position fix is derived from both the GLONASS and GPS network in parallel. This mode is the default setting and gives the best performance.
- GPS – in this mode only GPS satellites are used for the position fix.
- GLONASS – in this mode only GLONASS satellites are used for the position fix.

The operating mode can be selected from the '*GNSS source*' option in the '*Home*' > '*System settings*' settings menu.

The antenna dimensions should be entered in metres according to the diagram provided in Figure 25.

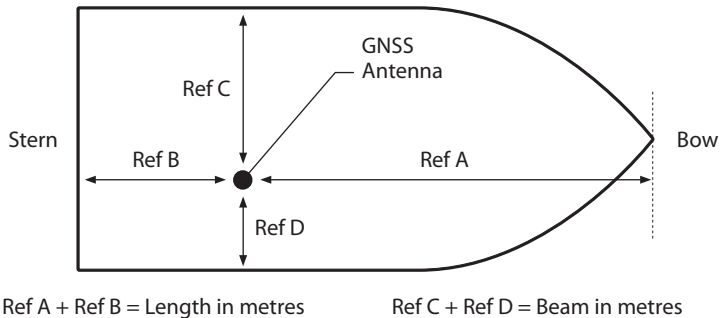

Figure 25 Vessel dimension measurement

## 4.8 Confirming correct operation









Following entry of the vessel information the AIS transceiver will commence normal operation. Correct operation should be verified as follows:

1. Select the 'Own dynamic data' option from the 'Home' menu.
2. Check that the displayed position, course, speed and heading (if appropriate) are correct by comparing the displayed position to other data sources.
3. Check that the 'TX' icon flashes periodically.
4. If the vessel is in an area where other AIS equipped vessels are present press the 'Back / Home' key and select 'Target list' to check that data from other AIS equipped vessels is displayed.
5. Go to the 'Home' > 'System settings' > 'System Information' screen and select 'Hardware status', check that the supply voltage and antenna VSWR are correct.

## 4.9 Displaying AIS targets

### 4.9.1 Target list

The *'Target list'* screen is the primary screen for displaying AIS targets received. This is the first screen displayed when the unit is switched on, but can also be accessed from the *'Target list'* option on the *'Home'* menu.

16:58:29 UTC + 1h		SOG 21.1kt COG 88.0°		50° 32.0286' N 0° 55.2715' W			
TARGET LIST							
NAME/MMSI	Range	Bearing	CPA	TCPA	Type	Age	
DUBLIN FISHER	3.15NM	120.8°	3.15NM	-		1m 50s	
PROXIMITY CRAFT	15.5NM	22.6°	15.5NM	-		1m 47s	
ATLANTIC PRIDE	6.9NM	37.20	6.9NM	-		0m 1s	
212222222	6.7NM	313.4°	6.7NM	-		0m 36s	
EMSLAKE	-	-	-	-		0m 45s	
PIER 4	5.2NM	86.6°	5.2NM	5h 38m		0m 6s	
444110175	35.8NM	167.3°	35.8NM	-		0m 5s	

Visible: 12 Filtered out: 0

Figure 26 Target list screen

By default the *'Target list'* is sorted by range but can be sorted on any column by using the left and right *'Function'* keys to select a column and pressing the *'Select'* key to sort either in ascending or descending order. Navigation up and down the list is via the up and down arrow keys or scroll wheel. Selecting a highlighted target using the Select key will bring up more details of that target. The *Options* menu on this screen provides additional actions which can be performed on the *'Target list'*.

Different symbols are shown for an AIS target depending on the type of target and its status, these are shown in Figure 27. These symbols are common to the *'Target list'* and *'Target plot'* displays.

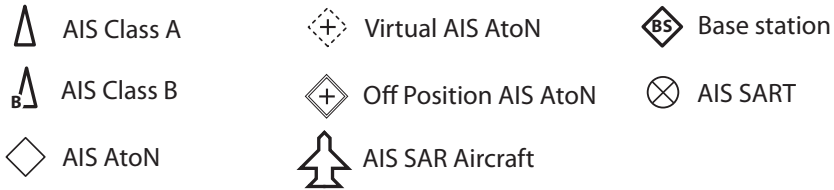

Figure 27 AIS target symbols displayed

### 4.9.2 Target filtering

From the *'Target list'* options menu, if *'Show Filter Settings'* is selected, a screen is displayed indicating which filter parameters can be set to reduce the amount of data displayed on screen. This screen can also be accessed through *'Home' > 'System settings' > 'User settings'*.



Filters can be toggled on and off on the *'Target list'* by pressing the *'Options menu'* key and selecting *'Toggle Filters On / Off'*. The bottom line of the *'Target list'* shows how many targets are visible or filtered out. If a filter is set, the filter icon is displayed at the top of the screen.

The Filters icon does not represent CPA/TCPA settings.

### 4.9.3 CPA/TCPA Settings

The AIS transceiver can be configured to identify approaching vessels which fall within certain limits. The Closest Point of Approach (CPA) defines a boundary around the own vessel upon which, if breached, will trigger an alert. Time to Closest Point of Approach (TCPA) can only be set if CPA is set, and will trigger the alert if the time to the CPA limit is breached.

These parameters are set on the *'Home' > 'System settings' > 'User settings' > 'Filtering and CPA/TCPA Settings'* menu.

The target list shows targets which trigger the CPA/TCPA alert in red.



These CPA/TCPA figures are calculated solely on AIS data and should not be used for anti-collision purposes.

**Note:** Setting the CPA/TCPA filter will not activate the Filters Icon.

#### **4.9.4 Target plot**

The '*Target plot*' screen shows the location of other AIS equipped vessels and shore stations relative to your own vessel. The '*Target plot*' screen provides a basic overview of AIS targets and should not be regarded as a substitute for display of AIS information on a dedicated electronic chart display system (ECDIS).

The plot range can be adjusted by rotating the scroll wheel which cycles through the ranges 0.1NM up to 100NM. The range relates to the radius of the outer range ring shown on the screen.

Individual targets can be selected by using the arrow keys. When selected a square outline will appear around the target and the vessel details will be shown on the left hand side of the screen.

By pressing the options menu key, additional display features can be selected. If the Own Vessel Details option is selected the left hand side of the screen will change to show own vessel dynamic data.

If the MOB Details Display option is selected, the target plot will change to show only AIS-MOB, AIS-SART, and AIS-EPIRB devices. The left hand side of the screen will show the range and relative bearing to whichever target is currently highlighted using the arrow keys.

#### **4.10 Micro SD card data input**

On the front of the AIS transceiver under the cover on the lower left hand side is a socket for a Micro SD memory card. See Figure 28. This can be used to upgrade the unit firmware, display detailed charts or to log port data. Note the orientation of the Micro SD card, which is critical to ensure the product is not damaged.

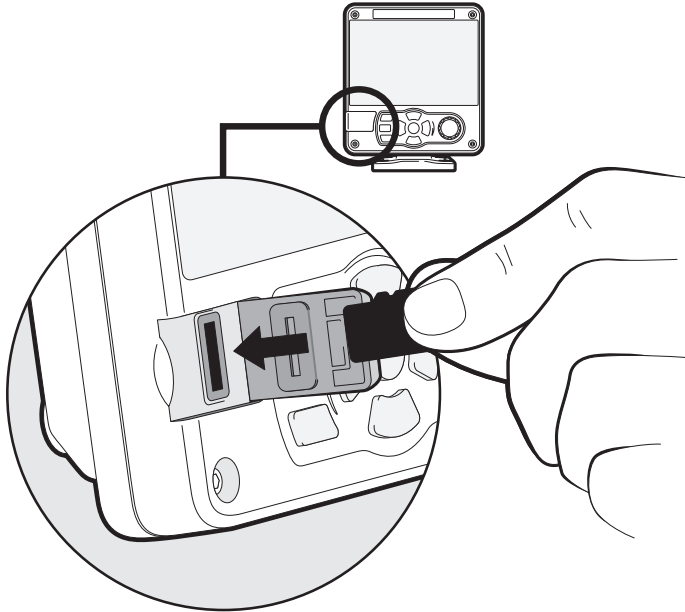

*Figure 28 Micro SD card Socket*

#### **4.10.1 Loading new charts**

The AIS transceiver always contains a basic low resolution world chart. More detailed resolution charts can be purchased and overlaid onto the AIS transceiver's chart display.

The AIS transceiver will read only Jeppesen C-MAP MAX format Micro SD cards. See your dealer for available charts for your region.

Insert a C-MAP Micro SD card into the Micro SD card socket. The AIS transceiver will then automatically overlay that higher resolution chart region onto the relevant region on the AIS transceiver's world chart.

Remove the Micro SD card and the region will revert back to the basic world chart.

### **4.10.2 Upgrading the unit firmware**

If a Micro SD card that contains valid upgrade firmware is inserted into the card socket, the unit will recognize the new firmware and will display a message asking you if you want to install it. The system will guide you to the appropriate menu screen, where the firmware update can be applied.

### **4.10.3 Logging ports to the Micro SD card**

If a Micro SD card is inserted into the card socket, the AIS transceiver can be configured to output specific data to the card. This is accessed from the individual port menu (from the *'Home' > 'System settings' > 'Interfaces' menu.*) If the *'Log port to SD'* option is set to *'On'*, data will be output from that port to the Micro SD card, if one is inserted into the card socket. Only one port can be logged to the Micro SD card at a time.

### **4.10.4 Saving / Loading settings**

From the *'Home' > 'System Settings' > 'Advanced' > 'Save / Restore settings'* menu, all system settings and AIS transceiver configuration data can be saved to the Micro SD card, if one is inserted into the card socket. Settings previously saved can be restored, thus restoring the AIS transceiver to a previous configuration.

## **4.11 WiFi Feature**

The AIS transceiver provides features to operate with vessel WiFi networks, or to create its own network. Access the WiFi menu through *'Home' > 'System settings' > 'Interfaces' > 'WiFi'*.

### **4.11.1 Client mode**

If client mode is selected, the AIS transceiver will search for available WiFi networks to connect to. If one is selected a password may be required, and upon connection the details of the connection will be shown in the bottom right corner of the screen. Once a WiFi connection is made, the AIS transceiver will output a range of NMEA0183 sentences over the selected WiFi port to any connected devices.

#### **4.11.2 Access point mode**

If the AIS transceiver is configured as a WiFi access point (AP) it will create its own WiFi network, allowing other WiFi enabled devices to connect to it. Once connections are made, a range of NMEA0183 sentences will be transmitted from the AIS transceiver to any connected devices.

#### **4.11.3 Advanced WiFi features**

Within the *'WiFi'* screen, certain parameters can be changed such as Channel Number, Protocol, Port, Encryption, etc. These are recommended for advanced users only.

WiFi is switched off by selecting *'Disable'* in the *'Select operating mode'* box.

## 5 Technical information

### 5.1 AIS Transceiver overall dimensions

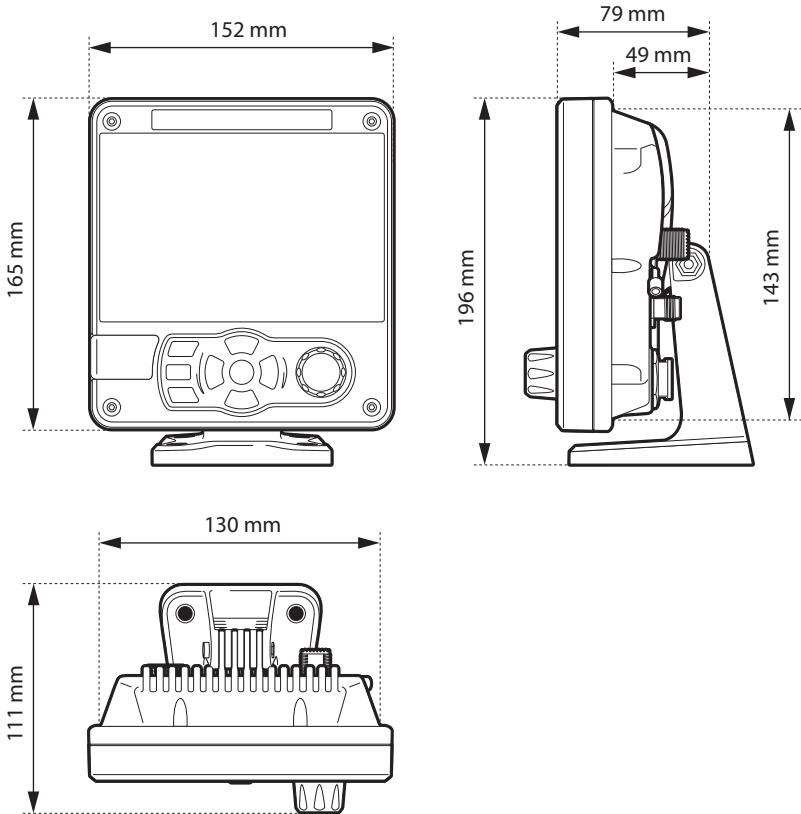

Figure 29 AIS Transceiver dimensions

## 5.2 GNSS Antenna drawing

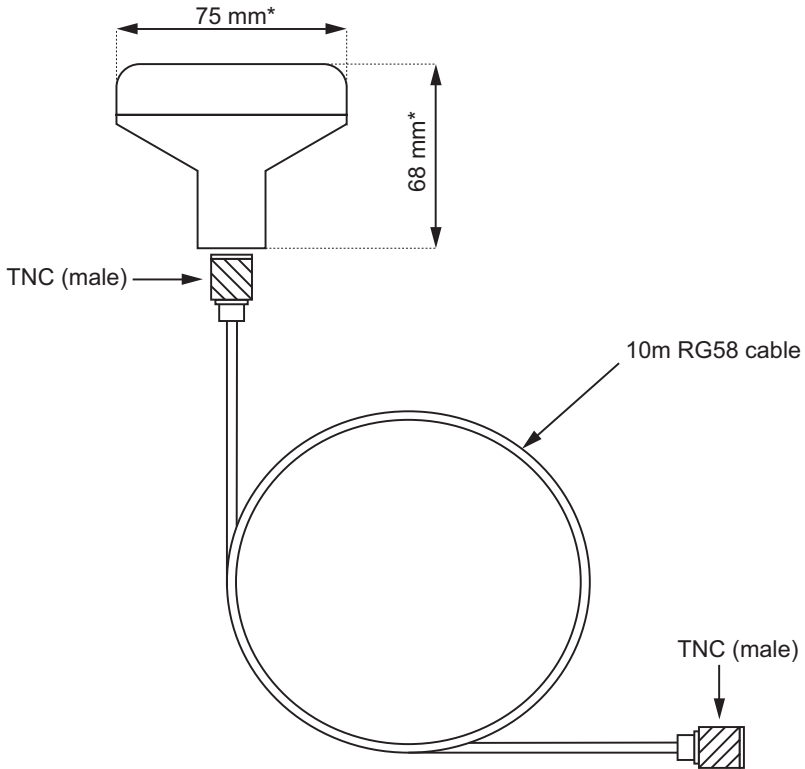

Figure 30 GNSS Antenna

\* The dimensions of the supplied antenna may vary from those shown here.

### 5.3 Troubleshooting

Issues	Possible cause and remedy
No data is being received by a connected chart plotter	<ul style="list-style-type: none"><li>● Check that the power supply is connected correctly.</li><li>● Check that the power supply is a 12VDC or 24VDC supply.</li><li>● Check that the connections to the chart plotter are correct.</li></ul>
The screen is not illuminated	<ul style="list-style-type: none"><li>● Check that the power supply is connected correctly.</li><li>● Check that the power supply is a 12VDC or 24VDC supply.</li><li>● Press and hold the <i>Chart / Screen brightness</i> button for at least 5 second. The display should return to maximum brightness.</li></ul>

The RED 'Alarm' icon is illuminated or flashing

- The unit may not have a valid MMSI. Check that the AIS transceiver is correctly configured with a valid MMSI.
- The VHF antenna may be faulty. Please check the connection to the VHF antenna and that the VHF antenna is not damaged. The alarm icon may illuminate briefly if the VHF antenna characteristics are briefly affected.
- No GPS position fix can be obtained. Please check the AIS transceiver is located where the internal GPS antenna has a clear sky view or that an external GPS antenna is properly connected and installed. Review the GPS signal strength graph in '*Home*' > '*System settings*' > '*Advanced*' > '*GNSS Source*'.
- The power supply is outside the allowable range. Check that the power supply is within the range 10.8VDC to 31.2VDC
- If none of the above correct the error condition please contact your dealer for advice.
- Check for error and alarm messages in the '*Alarms*' menu.



<p>My MMSI is being received by other vessels but my vessel name is not shown on their chart plotter or PC.</p>	<ul style="list-style-type: none"> <li>• Some older AIS devices and chart plotters do not process the specific class B message which provides the vessel name (message 24). This is not a fault of your AIS transceiver. Software upgrades are available for many older chart plotters which will correct this issue. The other vessel should update its AIS unit and / or chart plotting software to receive AIS message 24.</li> </ul>
---	--

*Table 7 Troubleshooting*

If the guidance given in the table above does not rectify the problem you are experiencing, please contact your dealer for further assistance.



## 6 Technical specification

### 6.1 Applicable equipment standards

<p>IEC62287-2 Ed. 1.0 2013-03</p>	<p>Maritime navigation and radiocommunication equipment and systems - Class B shipborne equipment of the universal automatic identification system (AIS) – Part 2: Self-organising time division multiple access (SOTDMA) techniques</p>
<p>IEC60945 4th Ed. 2002-08</p>	<p>Maritime navigation and radio communication equipment and systems – General requirements – Methods of testing and required test results</p>
<p>IEC61162-1 Ed. 4.0 2010-11</p>	<p>Maritime navigation and radio communication equipment and systems – Digital interfaces - Single talker and multiple listeners</p>
<p>IEC61162-2 Ed. 1.0 1998-09</p>	<p>Maritime navigation and radio communication equipment and systems – Digital interfaces - Single talker and multiple listeners, high speed transmission</p>
<p>IEC61162-3 2008+A2:2014</p>	<p>Maritime navigation and radio communication equipment and systems - Digital interfaces - Part 3: Serial data instrument network</p>

ITU-R M.1371-5 02/2014	Technical characteristics for an automatic identification system using time division multiple access in the VHF maritime mobile band
IEC61108-1 2nd Ed. 2003-07	Global Navigation Satellite Systems (GNSS) – Part 1: Global positioning system (GPS) - Receiver equipment - Performance standards, methods of testing and required test results
IEC6118-02 1st Ed. 1998-06	Global navigation satellite systems (GNSS) - Part 2: Global navigation satellite system (GLONASS) - Receiver equipment - Performance standards, methods of testing and required test results

## 6.2 Product category

Product category	This product is categorised as ‘protected’ in accordance with the definitions provided in IEC 60945
------------------	---

## 6.3 Physical

AIS Transceiver dimensions	152mm x 165mm x 111mm (WxHxD), see Figure 29. for drawing)
AIS Transceiver weight	1.5kg
Compass safe distance	0.5m (AIS Transceiver)
Safe operating distance	20cm from the antenna

## 6.4 Environmental

Operating temperature range	-15°C to +55°C
Maximum operating humidity	90% at +40°C, non-condensing
Water ingress rating	IPx6, IPx7

## 6.5 Electrical

Supply voltage	12VDC to 24VDC (absolute min 10.8V, absolute max 31.2 V)
Power consumption	< 12W
Current consumption @12 VDC supply	0.9A typical, 4.0A peak
Current consumption @24 VDC supply	0.5A typical, 3.0A peak

## 6.6 Display and user interface

Display	800 x 480 pixel colour LCD with adjustable backlight
Luminance	500cd/m <sup>2</sup> max, 75cd/m <sup>2</sup> default
Recommended viewing distance	45cm
Keypad	Five function keys and three menu keys with adjustable backlight
Rotary control	Encoder with push function
Speaker	600mW@750Hz 11mm x 15mm

## 6.7 Internal GNSS

Receiver channels	32 channels GPS and GLONASS operating modes
Time to first fix	Typically 26 seconds
Frequency	L1 GPS band, 1575.42MHz and L1 GLONASS band 1597.1 - 1609.5MHz
Accuracy	2.5m CEP / 5.0m SEP without differential correction 2.0m CEP / 3.0m SEP with SBAS or RTCM DGPS correction
Antenna requirement	Active antenna (5V bias) with gain >15dB

## 6.8 TDMA Transmitter

Frequency range	156.025MHz to 162.025MHz
Channel bandwidth	25kHz
Output power	1W or 5W (automatic selection)
Data transmission rate	9600 bits/s
Modulation mode	25kHz GMSK

## 6.9 TDMA Receiver

Number of receivers	3
Frequency range	156.025MHz to 162.025MHz
Channel bandwidth	25kHz
Sensitivity	<-107dBm for 20% PER

Modulation mode	25kHz GMSK
Adjacent channel selectivity	70dB
Spurious response rejection	70dB

## 6.10 DSC Receiver

Number of receivers	1
Frequency	156.525MHz (Channel 70)
Channel bandwidth	25kHz
Sensitivity	-107dBm @ BER <math>10^{-2}</math>
Modulation mode	25kHz AFSK
Adjacent channel selectivity	70dB
Spurious response rejection	70dB

## 6.11 RF Connections

VHF Antenna connection	SO-239 / UHF
VHF Port impedance	50 Ohms
GNSS Antenna connections	TNC female
GNSS Port impedance	50 Ohms

## 6.12 Data interface

Sensor data input ports	
Number of ports	3
Standard	IEC61162-1 / -2
Baud rate	4800 baud or 38400 baud
Port impedance	54K Ohms
Bi-directional data ports (including pilot port)	
Number of ports	3
Standard	IEC61162-1 / -2
Baud rate	4800 or 38400 baud
Port impedance	54K Ohms



Silent Mode port	
Port impedance	10K Ohms
NMEA 2000 Port:	
Load equivalency number (LEN)	1

### 6.13 Power and data connector information

Power connector	Chogori 22002525-04-RC	Mating Half	Chogori 22002221-01
18 way data connector	Chogori 23018525-04-RC	Mating Half	Chogori 23018221-01
14 way data connector	Chogori 23014525-05-RC	Mating Half	Chogori 23014221-01

### 6.14 Open source licences

This product contains open source software. For details please see the 'System information' screen.





Manufacturer's code: 427  
NMEA 2000 Product code: xxxxx



201-0707:1