



Neon 2 Class B AIS transceiver instruction manual

Thank you for buying this AIS Class B transceiver.

This product has been engineered to offer you the highest level of performance and durability and we hope that it will provide many years of reliable service. We constantly strive to achieve the highest possible quality standards, should you encounter any problems with this product, please contact your dealer who will be pleased to offer whatever assistance you require.

Table of contents

1	Notices	1
1.1	Safety warnings	1
1.2	General notices	1
2	About your AIS class B transceiver	4
2.1	About AIS	4
2.2	Static and dynamic vessel data	4
2.3	Important information for US customers	5
2.4	What's in the box?	6
3	Installation	10
3.1	Preparing for Installation	10
3.2	Installation procedures	12
4	Configuring your AIS transceiver	23
4.1	Switching on your AIS transceiver for the first time	23
4.2	Configuring your AIS transceiver	23
4.3	Introduction to proAIS2	24
4.4	Installing proAIS2	24
4.5	Configuration using proAIS2	24
5	Operation	25
5.1	Using the AIS transceiver	25
5.2	Switch functions	25
5.3	Using proAIS2 with your AIS transceiver	25
5.4	Indicator functions	26
6	Troubleshooting	28
7	Specifications	29

Table of figures

Figure 1	Items included with the product	6
Figure 2	AIS transceiver overview	8
Figure 3	Electrical connections to the AIS transceiver	9
Figure 4	Typical installation configuration	10
Figure 5	AIS transceiver dimensions	13
Figure 6	AIS transceiver mounting	14
Figure 7	GPS antenna mounting	15
Figure 8	Position of the GPS antenna connector	16
Figure 9	Position of the VHF antenna connector	17
Figure 10	Connecting an external switch	19
Figure 11	Connecting to the NMEA0183 data port	20
Figure 12	Connecting the power supply	22
Figure 13	Indicator functions	23
Figure 14	Indicator location on the AIS transceiver unit	26

1 Notices



When reading this manual please pay attention to warnings marked with the warning triangle shown on the left. These are important messages for safety, installation and usage of the product.

1.1 Safety warnings



This equipment must be installed in accordance with the instructions provided in this manual.



This AIS transceiver is an aid to navigation and must not be relied upon to provide accurate navigation information. AIS is not a replacement for vigilant human lookouts and other navigation aids such as RADAR. The performance of the transceiver may be seriously impaired if not installed as instructed in the user manual, or due to other factors such as weather and or nearby transmitting devices. Compatibility with other systems may vary and is reliant on the third party systems recognising the standard outputs from the transceiver. The manufacturer reserves the right to update and change these specifications at any time and without notice.



Do not install this equipment in a flammable atmosphere such as in an engine room or near to fuel tanks.

1.2 General notices

Position source

All marine Automatic Identification System (AIS) transceivers utilise a satellite based location system such as the Global Positioning Satellite (GPS) network.

The accuracy of a GPS position fix is variable and is affected by factors such as the antenna positioning, how many satellites are used to determine a position and how long satellite information has been received for.

Compass safe distance

The compass safe distance of this unit is 0.2m or greater for 0.3° deviation.

RF emissions notice

Caution: The AIS transceiver generates and radiates radio frequency electromagnetic energy. This equipment must be installed and operated according to the instructions contained in this manual. Failure to do so can result in personal injury and / or AIS transceiver malfunction.

Caution: Never operate the AIS transceiver unless it is connected to a VHF antenna.

To maximise performance and minimise human exposure to radio frequency electromagnetic energy you must make sure that the antenna is mounted at least 1.5 metres away from the AIS transceiver and is connected to the AIS transceiver before power is applied. The system has a Maximum Permissible Exposure (MPE) radius of 1.5m. This has been determined assuming the maximum power of the AIS transceiver and using antennas with a maximum gain of 3dBi. The antenna should be mounted 3.5m above the deck in order to meet RF exposure requirements. Higher gain antennas will require a greater MPE radius. Do not operate the unit when anyone is within the MPE radius of the antenna (unless they are shielded from the antenna field by a grounded metallic barrier). The antenna should not be co-located or operated in conjunction with any other transmitting antenna. The required antenna impedance is 50 Ohms.

Warranty

This product is supplied with standard warranty as defined in the accompanying warranty information.



Any attempt to tamper with or damage this product will invalidate the warranty.

Disposal of this product and packaging

Please dispose of the AIS transceiver in accordance with the European WEEE Directive or with the applicable local regulations for disposal of electrical equipment.

Every effort has been made to ensure the packaging for this product is recyclable. Please dispose of the packaging in an environmentally friendly manner.

Accuracy of this manual

The AIS transceiver may be upgraded from time to time and future versions of the AIS transceiver may therefore not correspond exactly with this manual. Information contained in this manual is liable to change without notice. The manufacturer of this product disclaims any liability for consequences arising from omissions or inaccuracies in this manual and any other documentation provided with this product.

Radio Equipment Directive

The manufacturer of this product declares that this product is in compliance with the essential requirements and other provisions of the Radio Equipment Directive 2014/53/EU and as such, displays the CE mark. The RED declaration of conformity is provided as part of this documentation pack



FCC notice

This equipment has been tested and found to comply with the limits for a class B digital device, pursuant to part 15 of the FCC Rules. These limits are designed to provide reasonable protection against harmful interference in a residential installation. This equipment generates, uses and can radiate radio frequency energy and, if not installed and used in accordance with the instructions, may cause harmful interference to radio communications.

This device complies with part 15 of the FCC Rules. Operation is subject to the following two conditions: (1) This device may not cause harmful interference, and (2) this device must accept any interference received, including interference that may cause undesired operation.

Changes or modifications not expressly approved by the party responsible for compliance could void the user's authority to operate the equipment.

 **WARNING: It is a violation of the rules of the Federal Communications Commission to input an MMSI that has not been properly assigned to the end user, or to otherwise input any inaccurate data in this device.**

Industry Canada notice

This device complies with Industry Canada licence-exempt RSS standard(s). Operation is subject to the following two conditions:

1. This device may not cause interference, and
 2. This device must accept any interference, including interference that may cause undesired operation of the device.
- This Class B digital apparatus complies with Canadian ICES-003.

Le présent appareil est conforme aux CNR d'Industrie Canada applicables aux appareils radio exempts de licence. L'exploitation est autorisée aux deux conditions suivantes :

1. L'appareil ne doit pas produire de brouillage, et
2. L'utilisateur de l'appareil doit accepter tout brouillage radioélectrique subi, même si le brouillage est susceptible d'en compromettre le Fonctionnement.

Cet appareil numérique de la classe B est conforme à la norme NMB-003 du Canada.

2 About your AIS class B transceiver

2.1 About AIS

The marine Automatic Identification System (AIS) is a location and vessel information reporting system. It allows vessels equipped with AIS to automatically and dynamically share and regularly update their position, speed, course and other information such as vessel identity with similarly equipped vessels. Position is derived from the Global Positioning System (GPS) and communication between vessels is by Very High Frequency (VHF) digital transmissions.

There are a number of types of AIS device as follows:

- **Class A transceivers.** These are similar to class B transceivers, but are designed to be fitted to large vessels such as cargo ships and large passenger vessels. Class A transceivers transmit at a higher VHF signal power than class B transceivers and therefore can be received by more distant vessels. They also transmit Class A transceivers are mandatory on all vessels over 300 gross tonnes on international voyages and certain types of passenger vessels under SOLAS regulations.
- **Class B transceivers.** Similar to class A transceivers in many ways, but are normally lower cost due to the less stringent performance requirements. Class B transceivers transmit at a lower power and at a lower reporting rate than class A transceivers.
- **AIS base stations.** AIS base stations are used by Vessel Traffic Systems to monitor and control the transmissions of AIS transceivers.
- **Aids to Navigation (AtoN) transceivers.** AtoNs are transceivers mounted on buoys or other hazards to shipping which transmit details of their location to the surrounding vessels.
- **AIS receivers.** AIS receivers will generally receive transmissions from class A transceivers, class B transceivers, AtoNs and AIS base stations but do not transmit any information about the vessel on which they are installed.

This product is an AIS Class B transceiver.

2.2 Static and dynamic vessel data

There are two categories of information transmitted by an AIS transceiver: static and dynamic data.

The vessel's dynamic data, which includes location, speed over ground (SOG) and course over ground (COG), is calculated automatically using the internal GPS receiver.

Static data is information about the vessel which must be programmed into the AIS transceiver. This includes:

- Maritime Mobile Service Identity (MMSI)
- Vessel name
- Vessel call sign (if available)
- Vessel type
- Vessel dimensions

In most countries the operation of an AIS transceiver is included under the vessel's marine VHF licence provisions. The vessel on to which the AIS unit is to be installed must therefore possess a current VHF radiotelephone licence which lists the AIS system, vessel Call Sign and MMSI number.

 **An MMSI number is required in order for the AIS transceiver to operate. Please contact the relevant authority in your country for more information.**

2.3 Important information for US customers

There are specific laws in the USA regarding the configuration of AIS class B transceivers.

If you are a US resident and intend to use your AIS class B transceiver in US waters, you should make sure that your retailer has configured your product prior to supplying it to you. If your AIS transceiver has not been pre-configured please contact your dealer for details of how to have it configured.

 **In the United States of America, the MMSI and static data must only be entered by a competent installer. The end user of the equipment is not authorised to enter their own vessel data.**

2.4 What's in the box?

Figure 1 shows the items included with your AIS transceiver purchase. The following sections give a brief overview of each item. Please ensure all items are present and if any of the items are not present contact your dealer.

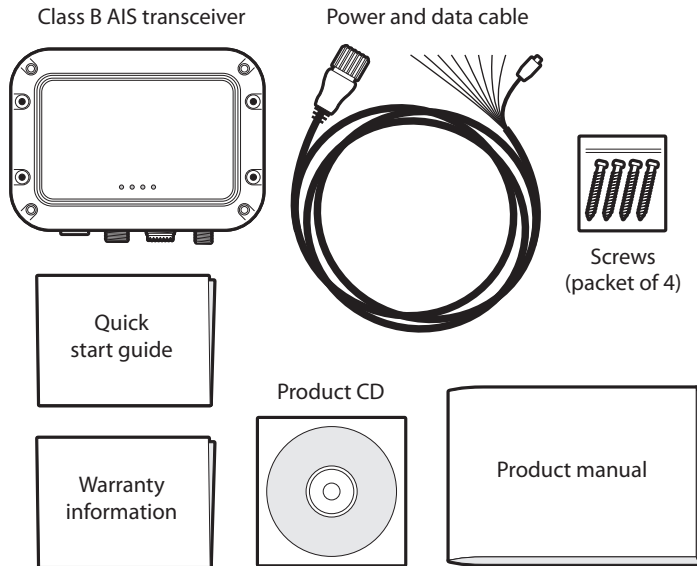

Figure 1 Items included with the product

Support tools CD

The CD supplied with the package contains the following:

- proAIS2 software tool necessary to configure the AIS transceiver. Please refer to section 4 for details of the configuration process and how to use the proAIS2 tool.
- USB drivers required to connect to the AIS transceiver via USB.
- Alternative language versions of this manual.

Quick start guide

The quick start guide gives a handy one page reference for the installation process.

Product manual

This document is the product manual and should be read thoroughly prior to any attempt to install or use the AIS transceiver.

Fixing screws

Four fixing screws are provided with the product for mounting of the AIS transceiver. Please refer to section 3.2 for details of how to mount the AIS transceiver.

AIS transceiver unit

Figure 2 shows an overview of the AIS transceiver unit.

The AIS transceiver has a number of indicators which provide information to the user about the status of the AIS transceiver. Please refer to section 5.4 for more details of indicator functions.

The AIS transceiver has an internal GPS antenna. You should ensure that the transceiver is mounted where it has a clear view of the sky, or alternatively connect an external GPS antenna which is available from your dealer as an accessory.

Power, data and USB cable

The power and data cable connects to the AIS transceiver and enables connection to power, NMEA0183, external silent mode switch and USB.



Do not attempt to adjust or remove the fixings next to each of the four mounting holes. These fixings form part of the sealing of the AIS transceiver and any modification could affect the product's performance and will invalidate the product's warranty.

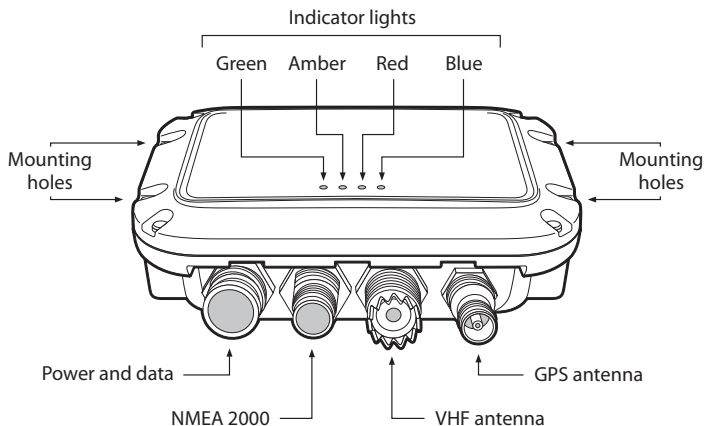

Figure 2 AIS transceiver overview

Electrical connections

The AIS transceiver has the following electrical connections:

- Power supply
- Two independent NMEA0183 data ports for connection to chart plotters and other NMEA0183 compatible equipment
- USB for connection to a PC or Mac
- External switch input for silent mode control
- NMEA2000 port for connection to NMEA2000 compatible equipment

In addition there are two other connections for the VHF antenna and an optional external GPS antenna. Figure 3 shows an overview of the electrical connections to the AIS transceiver.

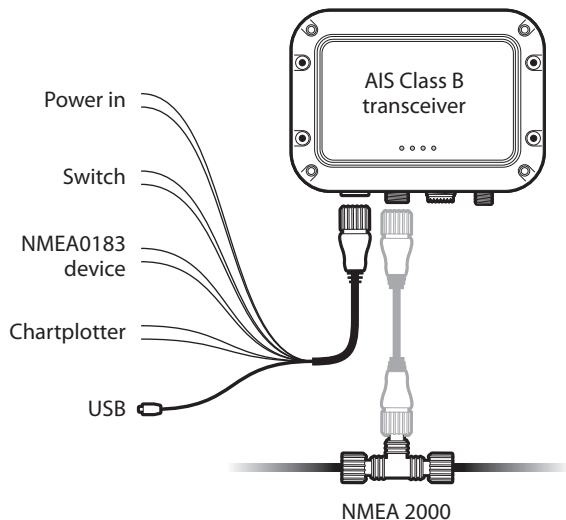

Figure 3 Electrical connections to the AIS transceiver

3 Installation

3.1 Preparing for Installation

Figure 4 shows a typical installation configuration for the AIS transceiver. Please take the time to familiarise yourself with the system elements and their connections prior to attempting installation.

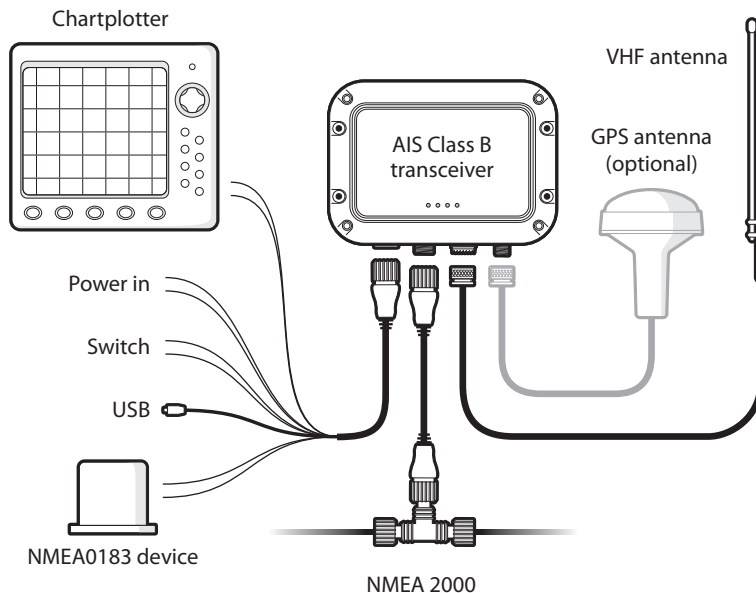

Figure 4 Typical installation configuration

In addition to the items provided with your AIS transceiver the following items will be required for installation:

VHF antenna

Connection to a suitable VHF antenna will be required for the AIS transceiver to operate. A standard marine band VHF antenna such as that used with VHF voice radios will be sufficient. Please take note of the warnings in section 1 regarding the use of antennas.

Alternatively, if you wish to use an existing VHF antenna, antenna splitter products are available which allow the existing antenna to be used with two radio devices, such as a VHF voice radio and the AIS transceiver.



When selecting an AIS antenna splitter make sure it is capable of operation with an AIS transceiver. Some AIS antenna splitters are designed to work only with AIS receivers. Please check with your dealer to ensure you purchase the correct type of antenna splitter.

Optional external GPS antenna

The transceiver has an internal GPS antenna. When the transceiver is mounted in a location with a clear sky view (for example, beneath a windshield or other non-metallic structure) an external GPS antenna is not required. Should it not be possible to mount the transceiver in a suitable location then an external GPS antenna can be connected. A compatible GPS antenna is available from your dealer as an accessory.

Optional switch

A switch can be connected to the transceiver to enable and disable 'silent mode' (see section 3.2). A latching toggle switch is required to use this feature.

VHF antenna cable

Please check that the VHF antenna you intend to use has sufficient cable to reach between the VHF antenna and the AIS transceiver unit. If it is not sufficient you will need an extension cable. Please contact your dealer for details of suitable products. For reference the VHF antenna connector type on the AIS transceiver unit is SO 239, and is intended to mate with a PL 259 connector.

Power and data cable

The AIS transceiver unit is supplied with a two metre long power and data cable as an accessory. If you require longer cables to reach your power supply, please ensure the cables are capable of carrying currents of up to 2A peak and 200mA on average. Means of connecting the cables together will also be required. The use of Scotchlok™ connectors is recommended for this purpose.

Chart plotter

To display received AIS messages as other vessels on your chart plotter, you will need to connect your AIS transceiver to your chart plotter. Please refer to the user manual supplied with your chart plotter for details of how to connect and configure your chart plotter for use with AIS devices. For general guidance your chart plotter should be configured to accept NMEA data at 38400 baud (sometimes referred to as 'NMEA HS' in the plotter configuration menu). You may also need to enable the display of AIS targets in the chart options. Alternatively if you use an NMEA2000 network on your vessel it is possible to connect the AIS transceiver to the NMEA2000 network via a suitable cable. Please refer to your dealer for details of NMEA2000 cables.

Connection to a PC or Mac

If you choose to use a PC or Mac with suitable charting software to display received AIS messages as other vessels, this can be accomplished by connecting the USB connector on the supplied power and data cable.

3.2 Installation procedures

Before beginning installation of your AIS transceiver, please ensure you have the necessary additional items as detailed in section 3.1. It is strongly recommended that you read all of the instructions in this manual prior to installation.

If after reading this manual you are unsure about any element of the installation process please contact your dealer for advice.

The following sections explain the installation process step by step for each of the main elements of the system.

Step 1 - Installing the AIS transceiver

Please note the following guidelines when selecting a location for your AIS transceiver:

- The AIS transceiver must be fitted in a location where it is at least 0.2m from a compass or any magnetic device.
- There should be adequate space around the AIS transceiver for routing of cables. See Figure 5 for details of the AIS transceiver dimensions.
- The ambient temperature around the AIS transceiver should be maintained between -25°C and +55°C.
- The AIS transceiver should not be located in a flammable or hazardous atmosphere such as in an engine room or near to fuel tanks.
- The AIS transceiver is fully waterproof to ingress protection rating IPx7, however it is recommended that the AIS transceiver is not subjected to extended periods of exposure to spray or submersion.
- It is recommended that the AIS transceiver is installed in a 'below decks' environment.
- It is acceptable to mount the AIS transceiver either vertically or horizontally.
- The product is supplied with four self tapping screws for attachment of the AIS transceiver to a suitable surface. Please refer to Figure 6 for guidance.
- The AIS transceiver should be mounted in a location where the indicators are readily visible as these provide important information on the status of the AIS transceiver.
- If the internal GPS antenna is used the AIS transceiver should be mounted in a location with a clear sky view. The internal GPS antenna is mounted below the top surface of the transceiver enclosure.

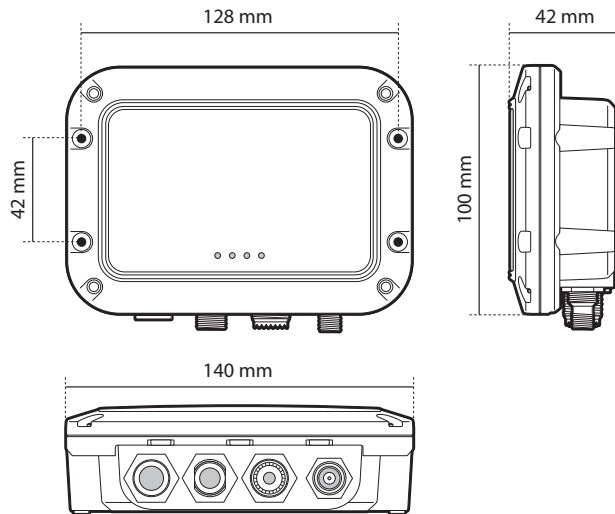

Figure 5 AIS transceiver dimensions

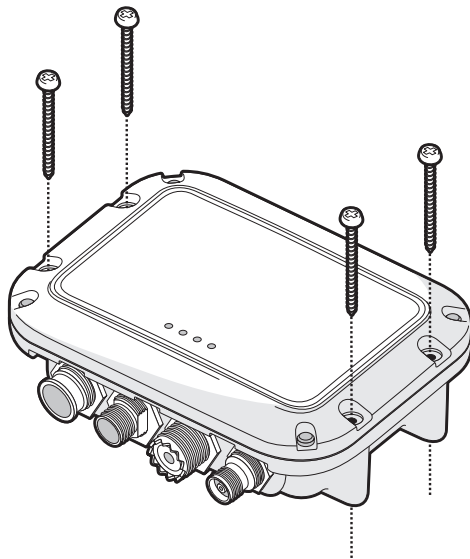

Figure 6 AIS transceiver mounting

Step 2 - Installing an optional external GPS antenna

For mounting of the optional external GPS antenna you will require a one inch 14 TPI thread pole.

You should ensure the GPS antenna has a good clear view of the entire sky.

It is not recommended that the GPS antenna is mounted up a mast where the motion of the vessel will cause the antenna to swing and potentially reduce the accuracy of the GPS position.

Do not mount your antenna in the direct path of a radar transmitter.

Feed the ten metre long cable attached to the GPS antenna through the pole and screw the antenna onto the pole mount as shown in Figure 7.

Route the cable to your AIS transceiver unit, adding any necessary extension cables.

Connect the cable from the GPS antenna to the GPS connector on the AIS transceiver as shown in Figure 8.

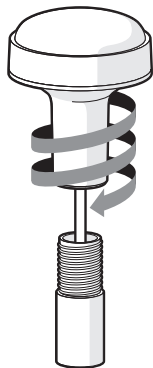

Figure 7 GPS antenna mounting

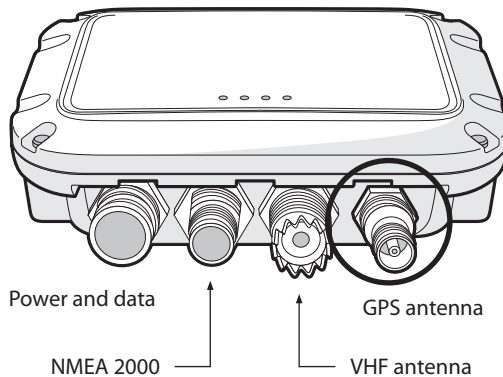

Figure 8 Position of the GPS antenna connector

Step 3 - Connecting the VHF antenna

Route the cable from the VHF antenna to the AIS transceiver and connect to the VHF connector on the AIS transceiver as shown in Figure 9.

A standard marine band VHF antenna or AIS antenna should be used with the AIS transceiver. The connector type on the AIS transceiver is SO239. Your chosen VHF antenna requires a PL259 connector to mate with this. If your VHF antenna does not use this type of connector please contact your dealer for details of available adaptors.

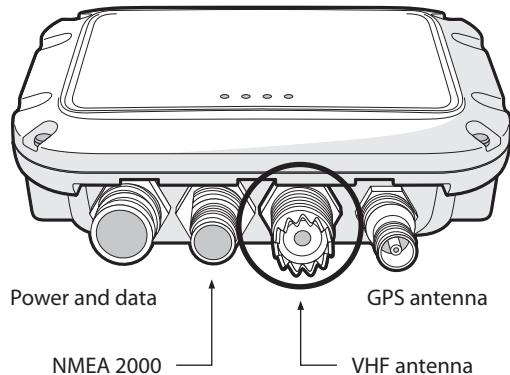

Figure 9 Position of the VHF antenna connector

Step 4 - Connecting the accessory cable

An accessory cable is supplied with the product to provide connections to power, the external switch, the NMEA0183 data ports and USB. The cable has a pre-moulded connector at one end which should be connected to the connector on the unit marked 'PWR/DATA'. The other end of the cable has eight colour coded bare wires ready for connection and a USB connector for use with a PC or Mac. The table below in Figure 1 lists the function of each colour coded wire for reference.

Wire colour	Description	Function
Red	Power in +	Power supply connections
Black	Power in -	
Green	Switch input-	External switch connection for silent mode
Orange	Switch input+	
Brown	NMEA0183 port 1 TX+	High speed NMEA0183 output (38,400baud) intended for connection to chart plotters
Blue	NMEA0183 port 1 TX-	
Purple	NMEA0183 port 2 RX+	Low speed NMEA0183 input (4,800baud) intended for connection to other NMEA0183 compatible sensors for multiplexing of data to the chart plotter
Yellow	NMEA0183 port 2 RX-	

Table 1 Colour coding of wires in the accessory cable



Please check your wiring very carefully before applying power to the product. Failure to wire the product correctly could result in permanent damage.

Step 5 - Connecting an external switch

A toggle switch can be connected to the AIS transceiver to provide remote control of silent mode.

Connect the toggle switch between the light green and orange wires as shown in Figure 10. Connection of an external switch to toggle silent mode is optional and not essential for normal operation of the product.



Do not connect a voltage source across the switch inputs as this may damage the transceiver.

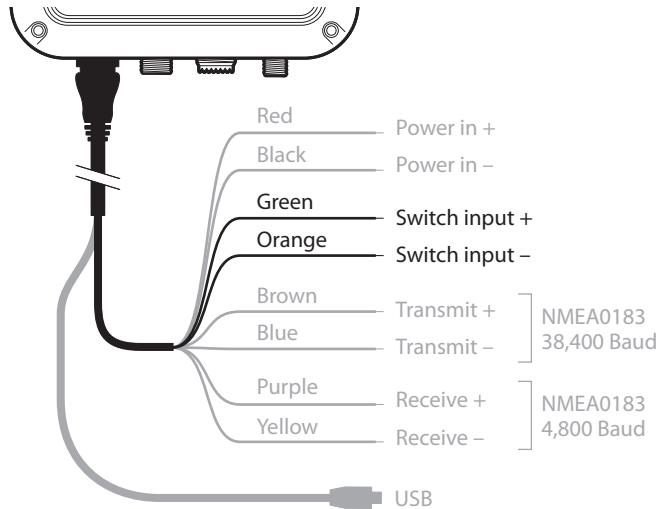

Figure 10 Connecting an external switch

Step 6 - Connecting to NMEA0183 compatible equipment

The two independent NMEA0183 data ports provide connection to your chart plotter and other NMEA0183 compatible equipment. Each port consists of two wires colour coded as shown in the table in Figure 11 and in the diagram in Figure 11. Connect the wires to the appropriate connections on your NMEA0183 compatible equipment. Please refer to your equipment manual for more information.

The AIS transceiver has a high speed output port which operates at 38,400baud and a low speed input port which operates at 4,800baud. The high speed port is intended primarily to connect to a chart plotter, while the low speed port is intended to connect to other NMEA0183 devices. A multiplexing feature is provided, which means any messages which are received via the low speed port are automatically transmitted via the high speed port. This is particularly useful when using a chart plotter having only a single NMEA0183 port. An additional sensor such as a gyro-compass can be connected to the AIS transceiver via the low speed port and the AIS transceiver can be connected via the high speed port to the chart plotter resulting in the chart plotter receiving both AIS information and heading information simultaneously. Please ensure your equipment is configured to use the correct baud rate for the port it is connected to.

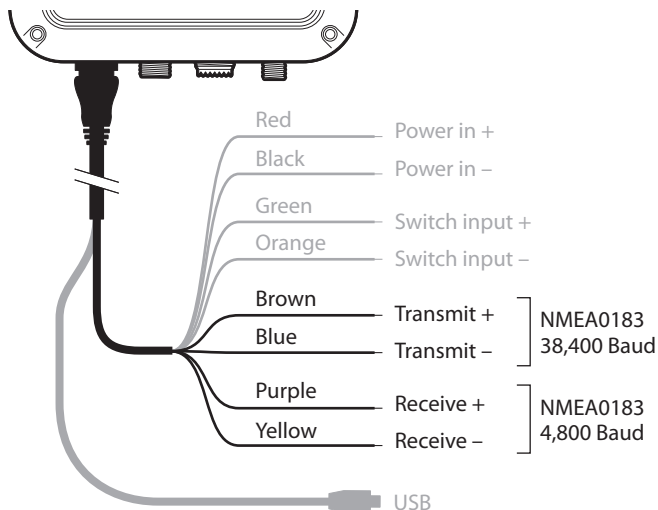



Figure 11 Connecting to the NMEA0183 data port

Step 7- Connection to an NMEA2000 network (optional)

The AIS transceiver can be connected to an NMEA2000 network by a suitable NMEA2000 network cable available from your local dealer. If your vessel has an NMEA2000 network please refer to the relevant documentation for your NMEA2000 equipment. Once connected, and with your chart plotter also connected to your NMEA2000 network you will be able to receive AIS targets on your chart plotter.

Step 8 - USB Connection (optional)

The AIS transceiver is supplied with a USB port for connection to a computer. The USB connector can be connected directly to the USB port on the computer via the supplied USB cable. To enable connection of the AIS transceiver to a computer the USB drivers must first be installed. This is done automatically when installing proAIS2 or by using Windows update. Driver installation is typically not required for use with OSX.

 **If the USB connection is removed from the computer during use you must reset the connection before further use. To reset the connection, disconnect then reapply power to the AIS before closing and relaunching any computer applications using the USB connection. Finally, reconnect the USB cable between the computer and the AIS transceiver.**

Step 9 - Connecting to a power supply

The AIS transceiver requires a 12V or 24V power supply typically provided by the vessel's battery.

It is recommended that crimped and soldered lugs are used to connect the AIS transceiver to the power source. It is recommended that the power supply is connected via a suitable circuit breaker and/or 3A fuse block.

1. Connect the red wire to a 12V or 24V power supply positive terminal.
2. Connect the black wire to the supply negative terminal.

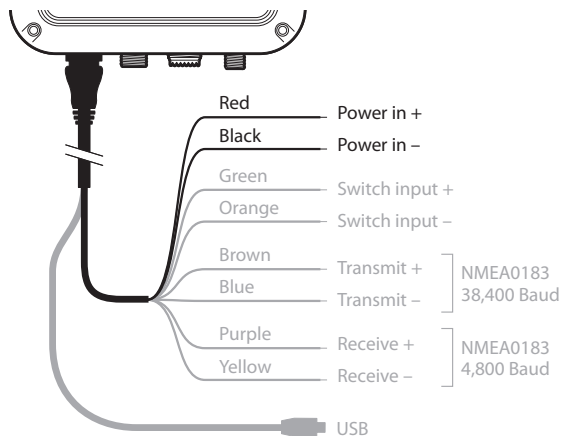

Figure 12 Connecting the power supply

4 Configuring your AIS transceiver

Until correctly configured your AIS class B transceiver will only receive AIS messages and will not transmit AIS messages.

4.1 Switching on your AIS transceiver for the first time

A few seconds after power is applied to the AIS transceiver, the indicators on unit will illuminate in a pattern dependent on the configuration state of the unit. Figure 13 shows the functions of the four indicators.

Indicator	Function
Green	Unit is powered up and operating normally
Amber	Unit is in a 'transmit timeout' period
Red	Unit has experienced an error
Blue	Silent mode is activated

Figure 13 Indicator functions

If the AIS transceiver has been pre-configured the amber indicator will illuminate until a transmission has been sent by the unit. This may take several minutes as the transceiver must acquire a GPS position fix prior to transmitting its first message.

If the transceiver has not been pre-configured the amber and red indicators will be illuminated until the configuration process has been completed.

4.2 Configuring your AIS transceiver

There are two potential ways in which your AIS transceiver can be configured:

1. Configuration in advance by your dealer or installer.

If your AIS transceiver has been configured for you by your dealer or installer you can proceed to section 5.

2. Configuration using proAIS2

Providing it is acceptable to do so under your local legislation it is possible to configure your AIS transceiver yourself using the proAIS2 software provided with the product.



US Customers only: It is a violation of the rules of the Federal Communications Commission for the end user to programme the vessel data. The vessel data must only be programmed by a competent installer. If your AIS transceiver has not been pre-configured for you please refer to your dealer for advice on how to have the AIS transceiver configured by a competent installer.

4.3 Introduction to proAIS2

Included in the CD supplied with your product is a software tool called 'proAIS2'. proAIS2 provides the facility to configure, monitor and diagnose issues with your AIS transceiver. proAIS2 can provide assistance when ensuring that a satisfactory GPS signal is being received. It can also display alarm messages generated by the transceiver regarding poor VHF antenna quality or that the power being supplied is outside the range specified for operation. proAIS2 can also be used to activate 'silent mode' which disables AIS transmissions.

Section 4.4 provides instructions on how to install proAIS2. Section 4.5 provides instructions on how to configure the AIS transceiver using proAIS2. Further help on how to use the features of proAIS2 can be found in the 'Help menu within the proAIS2 tool.

proAIS2 is designed to be installed and used with a PC or Mac connected to the AIS transceiver via USB using the supplied USB cable.

4.4 Installing proAIS2

1. Insert the CD into your PC or Mac then locate and run the setup.exe file on the CD and then follow the on-screen prompts.
2. If a security warning appears, click 'Install' to continue with the installation.
3. Once installation is complete, proAIS2 will launch automatically and a start menu folder and shortcut will be created for future use.

4.5 Configuration using proAIS2

For configuration purposes only, it is possible to power the AIS transceiver via its USB connection. This is useful if you wish to configure your AIS transceiver away from the vessel power supply. The AIS transceiver will not transmit any data or acquire a GPS position fix whilst powered by USB.

You will require the following information in order to configure your AIS transceiver:

- MMSI
- Vessel name
- Vessel type
- Call sign

Vessel dimensions and position of your GPS antenna installation.

For further assistance in configuring your AIS transceiver please refer to the Help menu within proAIS2.



Please ensure that you enter all vessel data accurately. Failure to do so could result in other vessels failing to identify your vessel correctly. The vessel MMSI can only be programmed once using proAIS2, please take care to programme your MMSI correctly. If you need to change the MMSI for any reason, please contact your dealer who will arrange to have the MMSI reset.

5 Operation

5.1 Using the AIS transceiver

Once the unit has been configured it is ready for use. Providing other vessels with AIS transceivers installed are within radio range of your vessel you should see their details appear on your chart plotter or PC. These vessels will also be able to see your vessel on their chart plotter or PC. It may take up to six minutes for your full vessel details to be visible to others.

Specific details of how to configure your chart plotter to make use of the AIS transceiver features will be given in your chart plotter manual. If you are using charting software running on a PC, please refer to the instructions provided with your chart plotting software for details of how to configure it to display AIS information.

5.2 Switch functions

When connected to the AIS transceiver following the instructions in section 3.2 an external switch provides the ability to set the AIS transceiver into 'silent mode'. In silent mode the transmission of your own vessel position ceases, whilst the reception of other vessel's AIS position continues. You should use silent mode if you do not wish your vessel data to be received by other AIS devices. When silent mode is active the blue indicator will be illuminated.

 **When silent mode is active other vessels will not be able to receive your vessel information on their AIS devices. Your navigational safety may be compromised as a result.**

5.3 Using proAIS2 with your AIS transceiver

The proAIS2 tool has a range of features to help monitor the performance of your AIS transceiver. To use the full range of features your AIS transceiver must be installed as described in section 3 and connected to a PC running the proAIS2 application. Follow the instructions provided in the help menu within proAIS2.

5.4 Indicator functions

The AIS transceiver includes four coloured indicators as shown in Figure 14. The state of the indicators provides information regarding the status of the AIS transceiver.

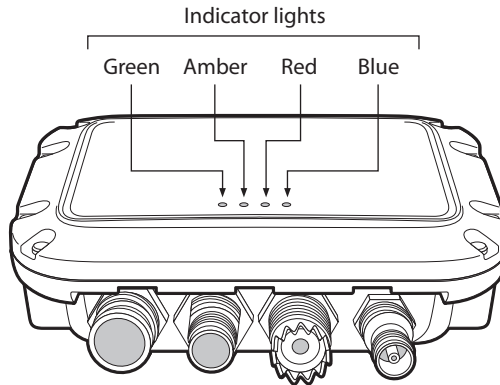

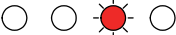
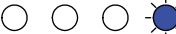



Figure 14 Indicator location on the AIS transceiver unit

The meaning of typical indicator configurations is shown in the table below and Figure 14 shows the orientation of the AIS transceiver.

	<p>Green indicator only The AIS transceiver is powered up, has a position fix and has transmitted at least one vessel information report.</p>
	<p>Red indicator only The AIS transceiver has detected a system error. The likely causes of this are detailed in the troubleshooting guide in section 6. Diagnostic messages displayed in proAIS² may also help troubleshoot the cause of the error.</p>
	<p>Blue indicator When silent mode is activated using the optional silent mode switch the blue indicator is illuminated to show that the transmitter is disabled.</p>
	<p>Amber indicator only The AIS transceiver is in 'transmit timeout' mode. This can be for a number of reasons:</p> <ul style="list-style-type: none"> • The unit has only recently been powered on and is obtaining a position fix prior to transmitting its first vessel information report. (This process can take several minutes). • Position fix has been lost. The AIS transceiver will attempt to regain position fix for 30 minutes before entering an error state. • The AIS radio channels are exceptionally busy so there is currently no available timeslot for transmission. • The unit has been in silent mode and after deactivating silent mode this amber indicator will illuminate until the first AIS message has been sent • The AIS transceiver has been commanded by the local authority (via an AIS base station) to cease transmissions.

6 Troubleshooting

Issue	Possible cause and remedy
No data is being received by the chart plotter	<ul style="list-style-type: none"> • Check that the power supply is connected correctly. • Check that the power supply is a 12V or 24V supply. • Check that the connections to the chart plotter are correct.
No indicators are illuminated	<ul style="list-style-type: none"> • Check that the power supply is connected correctly. • Check that the power supply is a 12V or 24V supply.
The Red 'error' indicator is illuminated	<ul style="list-style-type: none"> • The unit may not have a valid MMSI. Check that the AIS transceiver is correctly configured with a valid MMSI. • The VHF antenna may be faulty. Please check the connection to the VHF antenna and that the VHF antenna is not damaged. The red indicator may illuminate briefly if the power supply is interrupted or the VHF antenna characteristics are briefly affected. • No GPS position fix can be obtained. Please check the transceiver is located where the internal GPS antenna has a clear sky view or that an external GPS antenna is properly connected and installed. Review the GPS signal strength graph available in proAIS2. • The power supply is outside the allowable range. Check that the power supply is within the range 9.6V to 31.2V. • If none of the above correct the error condition please contact your dealer for advice. • Check for error and alarm messages in proAIS²
My MMSI is being received by other vessels but my vessel name is not shown on their chart plotter or PC	<ul style="list-style-type: none"> • Some older AIS devices and chart plotters do not process the specific class B AIS message which provides the vessel name (message 24). This is not a fault of your AIS transceiver. Software upgrades are available for many older chart plotters which will correct this issue. The other vessel should update its AIS unit and/or chart plotting software to receive AIS message 24.

If the guidance given in the table above does not rectify the problem you are experiencing, please contact your dealer for further assistance.

7 Specifications

Parameter	Value
Dimensions	140 x 100 x 42 mm (L x W x H)
Weight	250g
Power	DC (9.6V - 31.2V)
	Average power consumption 170mA at 12VDC
	Peak current rating 2A
GPS Receiver (AIS Internal)	50 channel IEC 61108-1 compliant
Electrical Interfaces	USB
	NMEA0183 38,400kBaud output
	NMEA0183 4,800kBaud input
	NMEA2000 LEN=1
Connectors	VHF antenna connector (SO-239)
	External GPS antenna connector (TNC)
	USB type A plug
	NMEA2000 standard connector
	12 way power input / NMEA0183/External switch

VHF Transceiver	Transmitter x 1
	Receiver x 2 (One receiver time shared between AIS and DSC)
	Frequency: 156.025 to 162.025 MHz in 25 kHz steps
Output Power	33dBm \pm 1.5 dB
Channel Bandwidth	25kHz
Channel Step	25kHz
Modulation Modes	25kHz GMSK (AIS, TX and RX)
	25kHz AFSK (DSC, RX only)
Bit rate	9600 b/s \pm 50 ppm (GMSK)
	1200 b/s \pm 30 ppm (FSK)
RX Sensitivity	Less than -107dBm at 20% PER
	Co-channel 10dB
	Adjacent channel 70dB
	IMD 65dB
	Blocking 84dB
Environmental	Water resistant to IPx7
	Operating temperature: -25°C to +55°C
	Tested to IEC 60945 'Protected' category
Indicators	Power, TX timeout, error, silent mode status

