

FCC Test Report (WLAN)

Report No.: RF170929E01-1

FCC ID: UXX-S5A803A

Test Model: S5A803A

Series Model: S5A808A, S5A804A, S5A809A

Received Date: Sep. 29, 2017

Test Date: Oct. 20 to 31, 2017

Issued Date: Nov. 10, 2017

Applicant: Cradlepoint, Inc

Address: 1111 W. Jefferson Street Suite 400 Boise, ID 83702 USA

Issued By: Bureau Veritas Consumer Products Services (H.K.) Ltd., Taoyuan Branch
Hsin Chu Laboratory

Lab Address: E-2, No.1, Li Hsin 1st Road, Hsinchu Science Park, Hsinchu City 300,
Taiwan R.O.C.

Test Location : E-2, No.1, Li Hsin 1st Road, Hsinchu Science Park, Hsinchu City 300,
Taiwan R.O.C.



This report is for your exclusive use. Any copying or replication of this report to or for any other person or entity, or use of our name or trademark, is permitted only with our prior written permission. This report sets forth our findings solely with respect to the test samples identified herein. The results set forth in this report are not indicative or representative of the quality or characteristics of the lot from which a test sample was taken or any similar or identical product unless specifically and expressly noted. Our report includes all of the tests requested by you and the results thereof based upon the information that you provided to us. You have 60 days from date of issuance of this report to notify us of any material error or omission caused by our negligence, provided, however, that such notice shall be in writing and shall specifically address the issue you wish to raise. A failure to raise such issue within the prescribed time shall constitute your unqualified acceptance of the completeness of this report, the tests conducted and the correctness of the report contents. Unless specific mention, the uncertainty of measurement has been explicitly taken into account to declare the compliance or non-compliance to the specification. The report must not be used by the client to claim product certification, approval, or endorsement by TAF or any government agencies.

Table of Contents

Release Control Record	4
1 Certificate of Conformity	5
2 Summary of Test Results	6
2.1 Measurement Uncertainty	6
2.2 Modification Record	6
3 General Information	7
3.1 General Description of EUT (WLAN)	7
3.2 Description of Test Modes	11
3.2.1 Test Mode Applicability and Tested Channel Detail	12
3.3 Duty Cycle of Test Signal	15
3.4 Description of Support Units	16
3.4.1 Configuration of System under Test	17
3.5 General Description of Applied Standard	19
4 Test Types and Results	20
4.1 Radiated Emission and Bandedge Measurement	20
4.1.1 Limits of Radiated Emission and Bandedge Measurement	20
4.1.2 Test Instruments	21
4.1.3 Test Procedure	22
4.1.4 Deviation from Test Standard	22
4.1.5 Test Setup	23
4.1.6 EUT Operating Condition	24
4.1.7 Test Results	25
4.2 Conducted Emission Measurement	45
4.2.1 Limits of Conducted Emission Measurement	45
4.2.2 Test Instruments	45
4.2.3 Test Procedure	46
4.2.4 Deviation from Test Standard	46
4.2.5 Test Setup	46
4.2.6 EUT Operating Condition	46
4.2.7 Test Results (Mode 1)	47
4.2.8 Test Results (Mode 2)	49
4.2.9 Test Results (Mode 3)	51
4.3 Transmit Power Measurement	53
4.3.1 Limits of Transmit Power Measurement	53
4.3.2 Test Setup	53
4.3.3 Test Instruments	53
4.3.4 Test Procedure	53
4.3.5 Deviation from Test Standard	53
4.3.6 EUT Operating Condition	53
4.3.7 Test Result	54
4.4 Occupied Bandwidth Measurement	62
4.4.1 Test Setup	62
4.4.2 Test Instruments	62
4.4.3 Test Procedure	62
4.4.4 Test Results	63
4.5 Peak Power Spectral Density Measurement	73
4.5.1 Limits of Peak Power Spectral Density Measurement	73
4.5.2 Test Setup	73
4.5.3 Test Instruments	73
4.5.4 Test Procedure	74
4.5.5 Deviation from Test Standard	74
4.5.6 EUT Operating Condition	74
4.5.7 Test Results	75

4.6	Frequency Stability Measurement.....	89
4.6.1	Limits of Frequency Stability Measurement	89
4.6.2	Test Setup.....	89
4.6.3	Test Instruments	89
4.6.4	Test Procedure	89
4.6.5	Deviation from Test Standard	89
4.6.6	EUT Operating Condition	89
4.6.7	Test Results	90
4.7	6dB Bandwidth Measurement.....	91
4.7.1	Limits of 6dB Bandwidth Measurement.....	91
4.7.2	Test Setup.....	91
4.7.3	Test Instruments	91
4.7.4	Test Procedure	91
4.7.5	Deviation from Test Standard	91
4.7.6	EUT Operating Condition	91
4.7.7	Test Results	92
5	Pictures of Test Arrangements.....	94
	Annex A- Radiated Out of Band Emission (OOBE) Measurement (For U-NII-3 band).....	95
	Appendix – Information on the Testing Laboratories	99

Release Control Record

Issue No.	Description	Date Issued
RF170929E01-1	Original release.	Nov. 10, 2017

1 Certificate of Conformity

Product: Integrated Mobile Broadband Router

Brand: cradlepoint

Test Model: S5A803A

Series Model: S5A808A, S5A804A, S5A809A

Sample Status: ENGINEERING SAMPLE

Applicant: Cradlepoint, Inc

Test Date: Oct. 20 to 31, 2017

Standard: 47 CFR FCC Part 15, Subpart E (Section 15.407)
ANSI C63.10: 2013

The above equipment has been tested by **Bureau Veritas Consumer Products Services (H.K.) Ltd., Taoyuan Branch**, and found compliance with the requirement of the above standards. The test record, data evaluation & Equipment Under Test (EUT) configurations represented herein are true and accurate accounts of the measurements of the sample's EMC characteristics under the conditions specified in this report.

Prepared by :

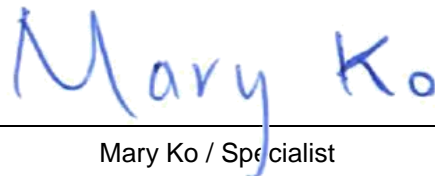
Mary Ko / Specialist

Date:

Nov. 10, 2017

Approved by :

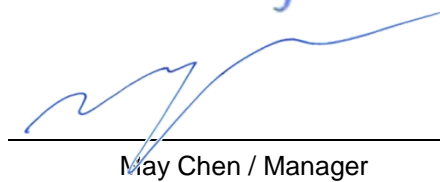
May Chen / Manager

Date:

Nov. 10, 2017

2 Summary of Test Results

47 CFR FCC Part 15, Subpart E (Section 15.407)			
FCC Clause	Test Item	Result	Remarks
15.407(b)(6)	AC Power Conducted Emissions	Pass	Meet the requirement of limit. Minimum passing margin is -3.90dB at 0.44053MHz.
15.407(b) (1/2/3/4(i/ii)/6)	Radiated Emissions & Band Edge Measurement*	Pass	Meet the requirement of limit. Minimum passing margin is -0.1dB at 5150.00MHz.
15.407(a)(1/2/3)	Max Average Transmit Power	Pass	Meet the requirement of limit.
---	Occupied Bandwidth Measurement	-	Reference only.
15.407(a)(1/2/3)	Peak Power Spectral Density	Pass	Meet the requirement of limit.
15.407(e)	6dB bandwidth	Pass	Meet the requirement of limit. (U-NII-3 Band only)
15.407(g)	Frequency Stability	Pass	Meet the requirement of limit.
15.203	Antenna Requirement	Pass	Antenna connector is R-SMA not a standard connector.

*For U-NII-3 band compliance with rule part 15.407(b)(4)(i), the OOB test plots were recorded in Annex A.

2.1 Measurement Uncertainty

Where relevant, the following measurement uncertainty levels have been estimated for tests performed on the EUT as specified in CISPR 16-4-2:

Measurement	Frequency	Expanded Uncertainty (k=2) (±)
Conducted Emissions at mains ports	150kHz ~ 30MHz	1.84 dB
Radiated Emissions up to 1 GHz	30MHz ~ 1GHz	5.32 dB
Radiated Emissions above 1 GHz	1GHz ~ 6GHz	5.14 dB
	6GHz ~ 18GHz	5.04 dB
	18GHz ~ 40GHz	5.25 dB

2.2 Modification Record

There were no modifications required for compliance.

3 General Information

3.1 General Description of EUT (WLAN)

Product	Integrated Mobile Broadband Router
Brand	cradlepoint
Test Model	S5A803A
Series Model	S5A808A, S5A804A, S5A809A
Status of EUT	ENGINEERING SAMPLE
Power Supply Rating	DC 54V from power adapter
Modulation Type	CCK, DQPSK, DBPSK for DSSS 64QAM, 16QAM, QPSK, BPSK for OFDM 256QAM for OFDM in 11ac mode and VHT20/40 mode in 2.4GHz band
Modulation Technology	DSSS, OFDM
Transfer Rate	802.11b: up to 11Mbps 802.11a/g: up to 54Mbps 802.11n: up to 600Mbps 802.11ac: up to 1733.3Mbps 802.11ac (80+80): up to 3466.7Mbps
Operating Frequency	2.4GHz: 2.412 ~ 2.462GHz 5GHz: 5.18 ~ 5.24GHz, 5.745 ~ 5.825GHz
Number of Channel	2.4GHz: 802.11b/g, 802.11n (HT20), VHT20 : 11 802.11n (HT40), VHT40: 7 5GHz: 802.11a, 802.11n (HT20), 802.11ac (VHT20): 9 802.11n (HT40), 802.11ac (VHT40): 4 802.11ac (VHT80): 2 802.11ac (VHT80+80): 1 set
Output Power	Radio 1 2.4GHz: CDD Mode: 670.981mW Beamforming Mode: 659.725mW Radio 2 5.18 ~ 5.24GHz: Master Mode CDD Mode: 810.23mW Beamforming Mode: 417.221mW Client Mode CDD Mode: 244.827mW Beamforming Mode: 106.522mW 5.745 ~ 5.825GHz: Master Mode CDD Mode: 994.535mW Beamforming Mode: 427.651mW Client Mode CDD Mode: 994.535mW Beamforming Mode: 427.651mW
Antenna Type	Refer to Note
Antenna Connector	Refer to Note
Accessory Device	Adapter x 1
Data Cable Supplied	NA

Note:

1. The EUT has four model names, which are identical to each other in all aspects except for the following:

Brand	Model	Product name	Function	
			Wifi	LTE
cradlepoint	S5A803A	Integrated Mobile Broadband Router	√	√
	S5A808A		-	√
	S5A804A		√	-
	S5A809A		-	-

From the above models, model: **S5A803A** was selected as representative model for the test and its data was recorded in this report.

2. There are WLAN, 3G/LTE and GPS technology used for the EUT. The EUT has three radios as following table:

Radio 1	Radio 2	Radio 3
WLAN - 2.4GHz	WLAN - 5GHz	WWAN - 3G/LTE

3. The EUT contains certified 3G/LTE modular which FCC ID:RI7LM940. (Brand: Sierra Wireless; Model No.: RI7LM940).

4. The EUT must be supplied with power adapters and following different models could be chosen as following table:

No.	Brand	Model No.	Spec.
1	UMEC	UP0651S-54PB	AC Input: 100-240Vac, 1.3A, 50/60Hz AC input cable: Unshielded, 1.8m DC Output: 54V, 1.2A DC Output cable: Unshielded, 1m
2	FSP GROUP INC.	FSP065-DWAN2	AC Input: 100-240Vac, 1.8A, 50/60Hz AC input cable: Unshielded, 1.9m DC Output: 54V, 1.2A DC Output cable: Unshielded with one core, 1m
3	FSP GROUP INC.	FSP120-AWAN2	AC Input: 100-240Vac, 1.8A, 50/60Hz AC input cable: Unshielded, 1.9m DC Output: 54V, 2.22A DC Output cable: Unshielded with one core, 1m

Note:

1. From the above adapters, the worse emissions was found in Adapter 2. Therefore only the test data of the mode was recorded in this report.

5. Simultaneously transmission condition.

Condition	Technology		
1	WLAN (Radio 1) (2.4GHz)	WLAN (Radio 2) (5GHz)	WWAN (Radio 3) 3G/LTE

Note: The emission of the simultaneous operation has been evaluated and no non-compliance was found.

6. The antennas provided to the EUT, please refer to the following table:

WLAN									
Antenna Set	Transmitter Circuit		Model	excluding cable loss Antenna Gain (dBi)	Frequency Range (GHz)	Antenna Type	Connector Type	Cable Length (mm)	Cable Loss(dB)
	Radio 1 (2.4G)	Radio 2 (5G)							
1	Chain (0)	Chain (1)	RFA-25-F17M3-B70-25	2.5	2.4~2.4835	Dipole	R-SMA	230	0.8
				3.5	5.15~5.85				1.4
	-	Chain (0)		2.5	2.4~2.4835	Dipole	R-SMA	230	0.8
				3.5	5.15~5.85				1.4
	-	Chain (3)		2.5	2.4~2.4835	Dipole	R-SMA	230	0.8
				3.5	5.15~5.85				1.4
	Chain (1)	Chain (2)		2.5	2.4~2.4835	Dipole	R-SMA	230	0.8
3.5			5.15~5.85	1.4					
2	Chain (0)	Chain (1)	TWX-1513RSXX-711	5	2.4~2.4835	Dipole	R-SMA	230	0.8
				5	5.15~5.85				1.4
	-	Chain (0)		5	2.4~2.4835	Dipole	R-SMA	230	0.8
				5	5.15~5.85				1.4
	-	Chain (3)		5	2.4~2.4835	Dipole	R-SMA	230	0.8
				5	5.15~5.85				1.4
	Chain (1)	Chain (2)		5	2.4~2.4835	Dipole	R-SMA	230	0.8
				5	5.15~5.85				1.4
WWAN – 3G / LTE									
Antenna Set	Transmitter Circuit		Model	Antenna Gain including cable loss (dBi)	Frequency Range (MHz)	Antenna Type	Connector Type	Cable Length (mm)	Cable Loss(dB)
1	Main	YWX-6252SABX-711	2	698~960	Dipole	SMA	100	0.2	
			3	1710~2700				0.4	
	Aux		2	698~960	Dipole	SMA	100	0.2	
			3	1710~2700				0.4	
2	Main	YWX-6241SAXX-711D	2	698~960	Dipole	SMA	100	0.2	
			3	1710~2700				0.4	
	Aux		2	698~960	Dipole	SMA	100	0.2	
			3	1710~2700				0.4	
GPS (only for test not for sale)									
Antenna Gain including cable loss (dBi)		Frequency Range (MHz)		Antenna Type		Connector Type			
GPS	1.36	1574.42±3		Dipole		SMA			
GLONASS	0.09	1602±0.5							
Note: 1. For WLAN: Ant set 2 was selected for the final test.									

7. The EUT incorporates a MIMO function:

2.4GHz Band (Radio 1)			
MODULATION MODE	DATA RATE (MCS)	TX & RX CONFIGURATION	
802.11b	1 ~ 11Mbps	2TX	2RX
802.11g	6 ~ 54Mbps	2TX	2RX
802.11n (HT20)	MCS 0~7	2TX	2RX
	MCS 8~15	2TX	2RX
802.11n (HT40)	MCS 0~7	2TX	2RX
	MCS 8~15	2TX	2RX
VHT20	MCS0~8 Nss=1	2TX	2RX
	MCS0~8 Nss=2	2TX	2RX
VHT40	MCS0~9 Nss=1	2TX	2RX
	MCS0~9 Nss=2	2TX	2RX
5GHz Band (Radio 2)			
MODULATION MODE	DATA RATE (MCS)	TX & RX CONFIGURATION	
802.11a	6 ~ 54Mbps	4TX	4RX
802.11n (HT20)	MCS 0~7	4TX	4RX
	MCS 8~15	4TX	4RX
	MCS 16~23	4TX	4RX
	MCS 24~31	4TX	4RX
802.11n (HT40)	MCS 0~7	4TX	4RX
	MCS 8~15	4TX	4RX
	MCS 16~23	4TX	4RX
	MCS 24~31	4TX	4RX
802.11ac (VHT20)	MCS 0~8, Nss=1	4TX	4RX
	MCS 0~8, Nss=2	4TX	4RX
	MCS 0~9, Nss=3	4TX	4RX
	MCS 0~8, Nss=4	4TX	4RX
802.11ac (VHT40)	MCS 0~9, Nss=1	4TX	4RX
	MCS 0~9, Nss=2	4TX	4RX
	MCS 0~9, Nss=3	4TX	4RX
	MCS 0~9, Nss=4	4TX	4RX
802.11ac (VHT80)	MCS 0~9, Nss=1	4TX	4RX
	MCS 0~9, Nss=2	4TX	4RX
	MCS 0~9, Nss=3	4TX	4RX
	MCS 0~9, Nss=4	4TX	4RX

Note:

- All of modulation mode support beamforming function except 802.11a/b/g modulation mode.
- The EUT support Beamforming and CDD mode, therefore both mode were investigated and the worst case scenario was identified. The worst case data were presented in test report.
- The modulation and bandwidth are similar for 802.11n mode for 20MHz (40MHz) and 802.11ac mode for 20MHz (40MHz), therefore investigated worst case to representative mode in test report. (Final test mode refer section 3.2.1)

- This device can support different category application which switched by access point mode and client mode by software.
- The above EUT information is declared by manufacturer and for more detailed features description, please refer to the manufacturer's specifications or user's manual.

3.2 Description of Test Modes

FOR 5180 ~ 5240MHz

4 channels are provided for 802.11a, 802.11n (HT20), 802.11ac (VHT20):

Channel	Frequency	Channel	Frequency
36	5180 MHz	44	5220 MHz
40	5200 MHz	48	5240 MHz

2 channels are provided for 802.11n (HT40), 802.11ac (VHT40):

Channel	Frequency	Channel	Frequency
38	5190 MHz	46	5230 MHz

1 channel is provided for 802.11ac (VHT80):

Channel	Frequency
42	5210 MHz

FOR 5745 ~ 5825MHz:

5 channels are provided for 802.11a, 802.11n (HT20), 802.11ac (VHT20):

Channel	Frequency	Channel	Frequency
149	5745 MHz	161	5805 MHz
153	5765 MHz	165	5825 MHz
157	5785 MHz		

2 channels are provided for 802.11n (HT40), 802.11ac (VHT40):

Channel	Frequency	Channel	Frequency
151	5755 MHz	159	5795 MHz

1 channel is provided for 802.11ac (VHT80):

Channel	Frequency
155	5775 MHz

For simultaneous transmission:

1 set is provided for 802.11ac (VHT80+80):

Channel	Frequency
42+155	5210MHz + 5775MHz

Note: The transmission is for noncontiguous transmission using two nonadjacent 80MHz channels.

3.2.1 Test Mode Applicability and Tested Channel Detail

EUT Configure Mode	Applicable To				Description
	RE \geq 1G	RE $<$ 1G	PLC	APCM	
1	-	-	√	-	With adapter 1
2	√	√	√	√	With adapter 2
3	-	-	√	-	With adapter 3

Where **RE \geq 1G**: Radiated Emission above 1GHz **RE $<$ 1G**: Radiated Emission below 1GHz
PLC: Power Line Conducted Emission **APCM**: Antenna Port Conducted Measurement

NOTE:

1. The EUT had been pre-tested on the positioned of each 2 axis. The worst case was found when positioned on **X-plane**.
2. "-" means no effect.

Radiated Emission Test (Above 1GHz):

- Pre-Scan has been conducted to determine the worst-case mode from all possible combinations between available modulations, data rates and antenna ports (if EUT with antenna diversity architecture).
- Following channel(s) was (were) selected for the final test as listed below.

CDD Mode						
Mode	FREQ. Band (MHz)	Available Channel	Tested Channel	Modulation Technology	Modulation Type	Data Rate (Mbps)
802.11a	5180-5240	36 to 48	36, 40, 48	OFDM	BPSK	6
802.11ac (VHT20)		36 to 48	36, 40, 48	OFDM	BPSK	6.5
802.11ac (VHT40)		38 to 46	38, 46	OFDM	BPSK	13.5
802.11ac (VHT80)		42	42	OFDM	BPSK	29.3
802.11a	5745-5825	149 to 165	149, 157, 165	OFDM	BPSK	6
802.11ac (VHT20)		149 to 165	149, 157, 165	OFDM	BPSK	6.5
802.11ac (VHT40)		151 to 159	151, 159	OFDM	BPSK	13.5
802.11ac (VHT80)		155	155	OFDM	BPSK	29.3
802.11ac (VHT80+80)	5180-5240 5745-5825	42 to 155	42 + 155	OFDM	BPSK	58.5

Radiated Emission Test (Below 1GHz):

- Pre-Scan has been conducted to determine the worst-case mode from all possible combinations between available modulations, data rates and antenna ports (if EUT with antenna diversity architecture).
- Following channel(s) was (were) selected for the final test as listed below.

CDD Mode						
Mode	FREQ. Band (MHz)	Available Channel	Tested Channel	Modulation Technology	Modulation Type	Data Rate (Mbps)
802.11a	5180-5240 5745-5825	36 to 48 149 to 165	157	OFDM	BPSK	6

Power Line Conducted Emission Test:

- Pre-Scan has been conducted to determine the worst-case mode from all possible combinations between available modulations, data rates and antenna ports (if EUT with antenna diversity architecture).
- Following channel(s) was (were) selected for the final test as listed below.

CDD Mode						
Mode	FREQ. Band (MHz)	Available Channel	Tested Channel	Modulation Technology	Modulation Type	Data Rate (Mbps)
802.11a	5180-5240 5745-5825	36 to 48 149 to 165	157	OFDM	BPSK	6

Antenna Port Conducted Measurement:

- This item includes all test value of each mode, but only includes spectrum plot of worst value of each mode.
- Pre-Scan has been conducted to determine the worst-case mode from all possible combinations between available modulations, data rates and antenna ports (if EUT with antenna diversity architecture).
- Following channel(s) was (were) selected for the final test as listed below.

CDD Mode						
Mode	FREQ. Band (MHz)	Available Channel	Tested Channel	Modulation Technology	Modulation Type	Data Rate (Mbps)
802.11a	5180-5240	36 to 48	36, 40, 48	OFDM	BPSK	6
802.11ac (VHT20)		36 to 48	36, 40, 48	OFDM	BPSK	6.5
802.11ac (VHT40)		38 to 46	38, 46	OFDM	BPSK	13.5
802.11ac (VHT80)		42	42	OFDM	BPSK	29.3
802.11a	5745-5825	149 to 165	149, 157, 165	OFDM	BPSK	6
802.11ac (VHT20)		149 to 165	149, 157, 165	OFDM	BPSK	6.5
802.11ac (VHT40)		151 to 159	151, 159	OFDM	BPSK	13.5
802.11ac (VHT80)		155	155	OFDM	BPSK	29.3
802.11ac (VHT80+80)	5180-5240 5745-5825	42 to 155	42 + 155	OFDM	BPSK	58.5
Beamforming Mode (output power only)						
Mode	FREQ. Band (MHz)	Available Channel	Tested Channel	Modulation Technology	Modulation Type	Data Rate (Mbps)
802.11ac (VHT20)	5180-5240	36 to 48	36, 40, 48	OFDM	BPSK	6.5
802.11ac (VHT40)		38 to 46	38, 46	OFDM	BPSK	13.5
802.11ac (VHT80)		42	42	OFDM	BPSK	29.3
802.11ac (VHT20)	5745-5825	149 to 165	149, 157, 165	OFDM	BPSK	6.5
802.11ac (VHT40)		151 to 159	151, 159	OFDM	BPSK	13.5
802.11ac (VHT80)		155	155	OFDM	BPSK	29.3
802.11ac (VHT80+80)	5180-5240 5745-5825	42 to 155	42 + 155	OFDM	BPSK	58.5

Test Condition:

Applicable To	Environmental Conditions	Input Power	Tested By
RE \geq 1G	22deg. C, 67%RH	120Vac, 60Hz	Eason Tseng
RE<1G	25deg. C, 68%RH	120Vac, 60Hz	Eason Tseng
PLC	25deg. C, 73%RH	120Vac, 60Hz	Andy Ho
APCM	25deg. C, 60%RH	120Vac, 60Hz	Anderson Chen
	24deg. C, 66%RH		

3.3 Duty Cycle of Test Signal

If duty cycle of test signal is $\geq 98\%$, duty factor is not required.

If duty cycle of test signal is $< 98\%$, duty factor shall be considered.

802.11a: Duty cycle = $2.018 \text{ ms} / 2.101 \text{ ms} = 0.96$, Duty factor = $10 * \log(1/0.96) = 0.18$

802.11ac (VHT20): Duty cycle = $4.96 \text{ ms} / 5.05 \text{ ms} = 0.982$

802.11ac (VHT40): Duty cycle = $2.409 \text{ ms} / 2.481 \text{ ms} = 0.971$, Duty factor = $10 * \log(1/0.971) = 0.13$

802.11ac (VHT80): Duty cycle = $1.132 \text{ ms} / 1.192 \text{ ms} = 0.95$, Duty factor = $10 * \log(1/0.95) = 0.22$

802.11ac (VHT80+80): Duty cycle = $2.234 / 2.305 = 0.969$, Duty factor = $10 * \log(1/0.969) = 0.14$

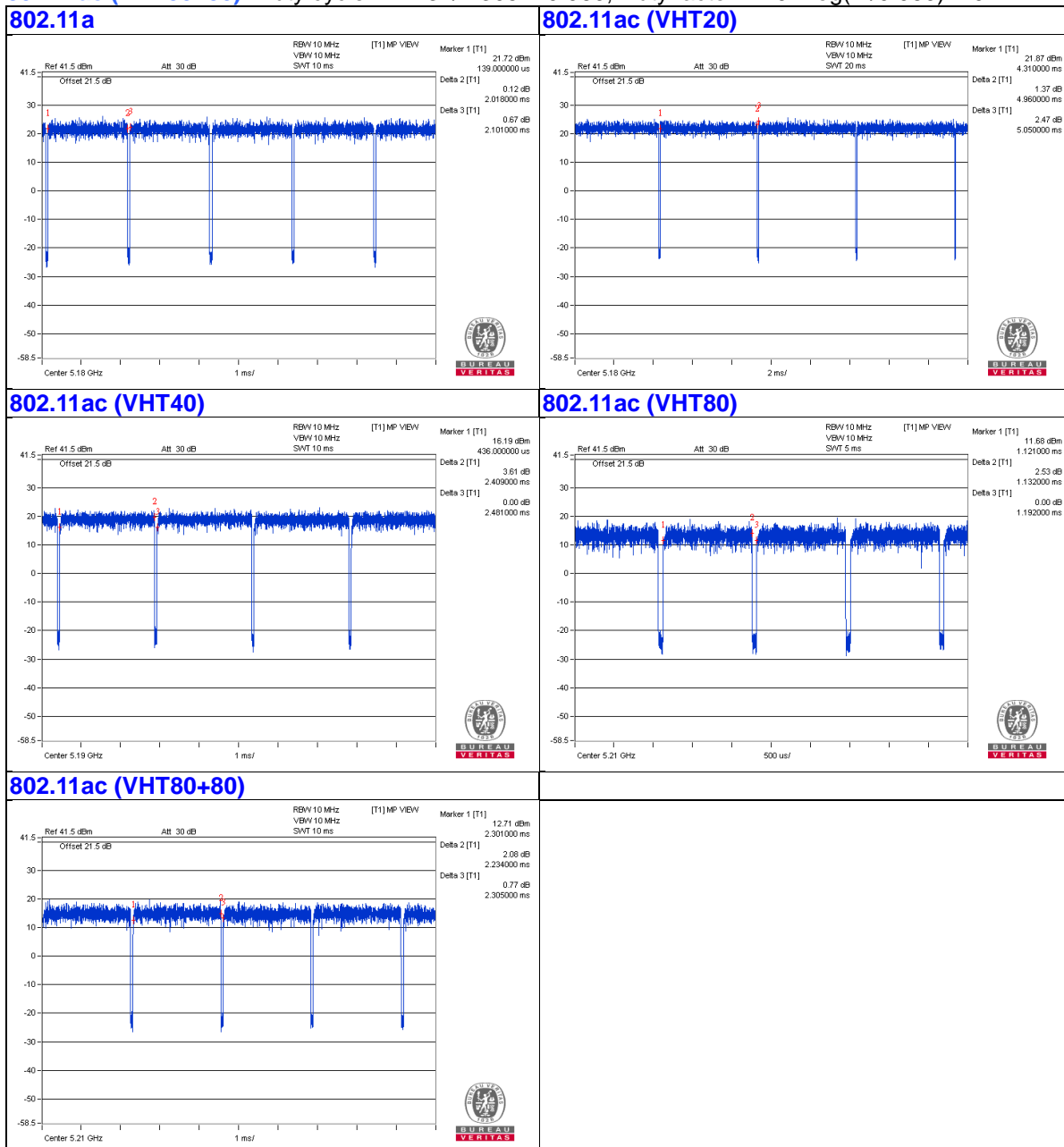

3.4 Description of Support Units

The EUT has been tested as an independent unit together with other necessary accessories or support units. The following support units or accessories were used to form a representative test configuration during the tests.

ID	Product	Brand	Model No.	Serial No.	FCC ID	Remarks
A.	Laptop	DELL	E6420	B92T3R1	FCC DoC	Provided by Lab
B.	Laptop	DELL	E6420	482T3R1	FCC DoC	Provided by Lab
C.	iPod	Apple	MD778TA/A	CC4JMH7LF4T1	NA	Provided by Lab
D.	3G/LTE Modem	NA	NA	NA	NA	Supplied by client
E.	SIM Card	NA	NA	NA	NA	Provided by Lab

Note:

1. All power cords of the above support units are non-shielded (1.8m).

ID	Descriptions	Qty.	Length (m)	Shielding (Yes/No)	Cores (Qty.)	Remarks
1.	DC Cable	1	1	No	1	Supplied by client
2.	RJ-45 Cable	1	3	No	0	Provided by Lab
3.	RJ-45 Cable	1	10	No	0	Provided by Lab
4.	RJ-45 Cable	1	10	No	0	Provided by Lab
5.	DC Cable	1	3	No	0	Provided by Lab
6.	USB Cable	1	0.1	Yes	0	Provided by Lab
7.	GPS Cable	2	3	No	0	Supplied by client
8.	AC Cable	1	1.9	No	0	Supplied by client

3.4.1 Configuration of System under Test

For Conducted Emission Test (Mode 1):

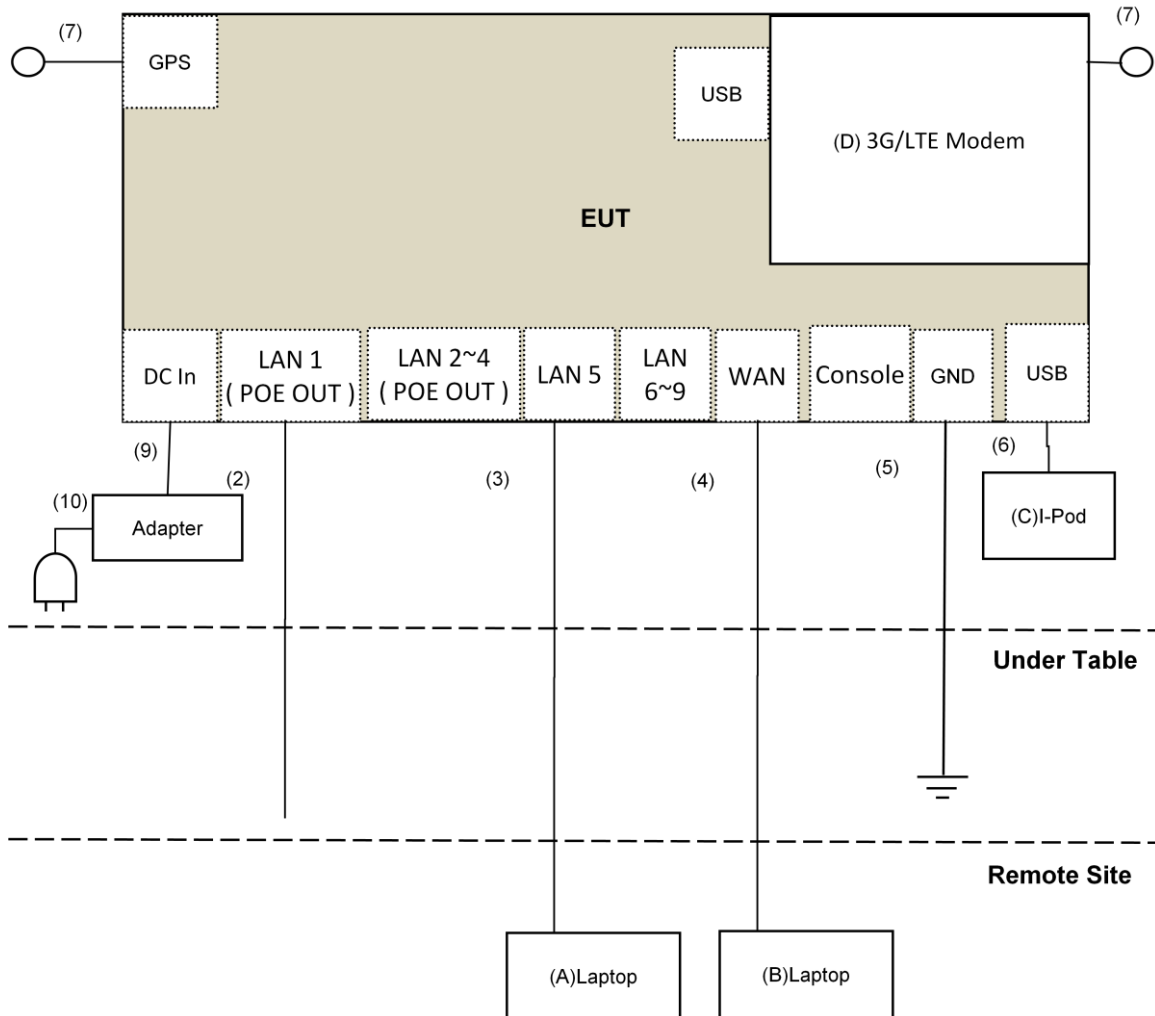

For other test:

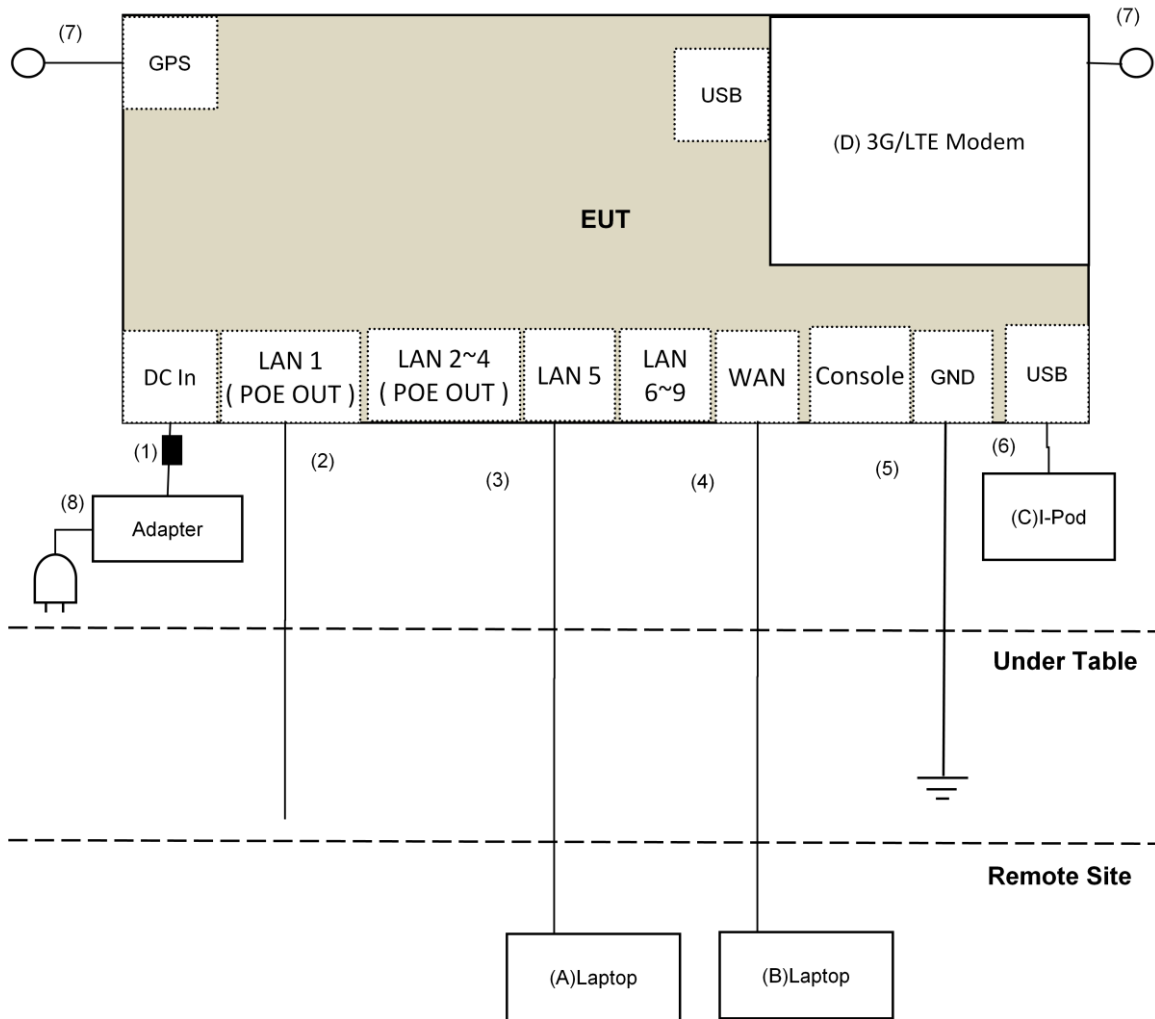

3.5 General Description of Applied Standard

The EUT is a RF Product. According to the specifications of the manufacturer, it must comply with the requirements of the following standards:

FCC Part 15, Subpart E (15.407)
KDB 789033 D02 General UNII Test Procedure New Rules v01r04
KDB 662911 D01 Multiple Transmitter Output v02r01
ANSI C63.10-2013

All test items have been performed and recorded as per the above standards.

NOTE: The EUT has been verified to comply with the requirements of FCC Part 15, Subpart B, Class B (DoC). The test report has been issued separately.

4 Test Types and Results

4.1 Radiated Emission and Bandedge Measurement

4.1.1 Limits of Radiated Emission and Bandedge Measurement

Radiated emissions which fall in the restricted bands must comply with the radiated emission limits specified as below table.

Frequencies (MHz)	Field Strength (microvolts/meter)	Measurement Distance (meters)
0.009 ~ 0.490	2400/F(kHz)	300
0.490 ~ 1.705	24000/F(kHz)	30
1.705 ~ 30.0	30	30
30 ~ 88	100	3
88 ~ 216	150	3
216 ~ 960	200	3
Above 960	500	3

NOTE:

1. The lower limit shall apply at the transition frequencies.
2. Emission level (dBuV/m) = 20 log Emission level (uV/m).
3. For frequencies above 1000MHz, the field strength limits are based on average detector, however, the peak field strength of any emission shall not exceed the maximum permitted average limits, specified above by more than 20dB under any condition of modulation.

Limits of unwanted emission out of the restricted bands

Applicable To		Limit	
789033 D02 General UNII Test Procedure New Rules v01r04		Field Strength at 3m	
		PK:74 (dBuV/m)	AV:54 (dBuV/m)
Frequency Band	Applicable To	EIRP Limit	Equivalent Field Strength at 3m
5150~5250 MHz	15.407(b)(1)	PK:-27 (dBm/MHz)	PK:68.2(dBuV/m)
5250~5350 MHz	15.407(b)(2)		
5470~5725 MHz	15.407(b)(3)		
5725~5850 MHz	<input checked="" type="checkbox"/> 15.407(b)(4)(i)	PK:-27 (dBm/MHz) ^{*1} PK:10 (dBm/MHz) ^{*2} PK:15.6 (dBm/MHz) ^{*3} PK:27 (dBm/MHz) ^{*4}	PK: 68.2(dBuV/m) ^{*1} PK:105.2 (dBuV/m) ^{*2} PK: 110.8(dBuV/m) ^{*3} PK:122.2 (dBuV/m) ^{*4}
	<input type="checkbox"/> 15.407(b)(4)(ii)	Emission limits in section 15.247(d)	
^{*1} beyond 75 MHz or more above of the band edge.		^{*2} below the band edge increasing linearly to 10 dBm/MHz at 25 MHz above.	
^{*3} below the band edge increasing linearly to a level of 15.6 dBm/MHz at 5 MHz above.		^{*4} from 5 MHz above or below the band edge increasing linearly to a level of 27 dBm/MHz at the band edge.	

Note:

The following formula is used to convert the equipment isotropic radiated power (eirp) to field strength:

$$E = \frac{1000000\sqrt{30P}}{3} \mu\text{V/m, where } P \text{ is the eirp (Watts).}$$

4.1.2 Test Instruments

DESCRIPTION & MANUFACTURER	MODEL NO.	SERIAL NO.	CALIBRATED DATE	CALIBRATED UNTIL
Test Receiver Agilent	N9038A	MY50010156	July 12, 2017	July 11, 2018
Pre-Amplifier ^(*) EMCI	EMC001340	980142	Jan. 20, 2016	Jan. 19, 2018
Loop Antenna ^(*) Electro-Metrics	EM-6879	264	Dec. 16, 2016	Dec. 15, 2018
RF Cable	NA	LOOPCAB-001 LOOPCAB-002	Jan. 17, 2017	Jan. 16, 2018
Pre-Amplifier Mini-Circuits	ZFL-1000VH2B	AMP-ZFL-05	May 06, 2017	May 05, 2018
Trilog Broadband Antenna SCHWARZBECK	VULB 9168	9168-361	Dec. 29, 2016	Dec. 28, 2017
RF Cable	8D	966-3-1 966-3-2 966-3-3	Apr. 01, 2017	Mar. 31, 2018
Fixed attenuator Mini-Circuits	UNAT-5+	PAD-3m-3-01	Oct. 03, 2017	Oct. 02, 2018
Horn_Antenna SCHWARZBECK	BBHA9120-D	9120D-406	Dec. 28, 2016	Dec. 27, 2017
Pre-Amplifier EMCI	EMC12630SE	980384	Feb. 02, 2017	Feb. 01, 2018
RF Cable	EMC104-SM-SM-1200 EMC104-SM-SM-2000 EMC104-SM-SM-5000	160922 150317 150322	Feb. 02, 2017 Mar. 29, 2017 Mar. 29, 2017	Feb. 01, 2018 Mar. 28, 2018 Mar. 28, 2018
Spectrum Analyzer Keysight	N9030A	MY54490679	July 25, 2017	July 24, 2018
Pre-Amplifier EMCI	EMC184045SE	980386	Feb. 02, 2017	Feb. 01, 2018
Horn_Antenna SCHWARZBECK	BBHA 9170	BBHA9170608	Dec. 15, 2016	Dec. 14, 2017
RF Cable	SUCOFLEX 102	36432/2 36433/2	Jan. 15, 2017	Jan. 14, 2018
Software	ADT_Radiated_V8.7.08	NA	NA	NA
Antenna Tower & Turn Table Max-Full	MF-7802	MF780208406	NA	NA
Boresight Antenna Fixture	FBA-01	FBA-SIP01	NA	NA
Spectrum Analyzer R&S	FSV40	100964	July 1, 2017	June 30, 2018
Power meter Anritsu	ML2495A	1014008	May 11, 2017	May 10, 2018
Power sensor Anritsu	MA2411B	0917122	May 11, 2017	May 10, 2018
AC Power Source Extech Electronics	6205	1440452	NA	NA
Temperature & Humidity Chamber Giant Force	GTH-150-40-SP-AR	MAA0812-008	Jan. 11, 2017	Jan. 10, 2018
Digital Multimeter FLUKE	87III	73680266	Nov. 10, 2016	Nov. 09, 2017

Note:

1. The calibration interval of the above test instruments is 12 months and the calibrations are traceable to NML/ROC and NIST/USA.
2. *The calibration interval of the above test instruments is 24 months and the calibrations are traceable to NML/ROC and NIST/USA.
3. The test was performed in 966 Chamber No. 3.
4. Loop antenna was used for all emissions below 30 MHz.
5. The FCC Designation Number is TW2022.
6. The CANADA Site Registration No. is 20331-1
7. Tested Date: Oct. 20 to 31, 2017

4.1.3 Test Procedure

For Radiated emission below 30MHz

- a. The EUT was placed on the top of a rotating table 0.8 meters above the ground at a 3 meter chamber room. The table was rotated 360 degrees to determine the position of the highest radiation.
- b. The EUT was set 3 meters away from the interference-receiving antenna, which was mounted on the top of a variable-height antenna tower.
- c. Both X and Y axes of the antenna are set to make the measurement.
- d. For each suspected emission, the EUT was arranged to its worst case and the rotatable table was turned from 0 degrees to 360 degrees to find the maximum reading.
- e. The test-receiver system was set to Quasi-Peak Detect Function and Specified Bandwidth with Maximum Hold Mode.

NOTE:

1. The resolution bandwidth and video bandwidth of test receiver/spectrum analyzer is 9kHz at frequency below 30MHz.

For Radiated emission above 30MHz

- a. The EUT was placed on the top of a rotating table 0.8 meters (for 30MHz ~ 1GHz) / 1.5 meters (for above 1GHz) above the ground at 3 meter chamber room for test. The table was rotated 360 degrees to determine the position of the highest radiation.
- b. The EUT was set 3 meters away from the interference-receiving antenna, which was mounted on the top of a variable-height antenna tower.
- c. The height of antenna is varied from one meter to four meters above the ground to determine the maximum value of the field strength. Both horizontal and vertical polarizations of the antenna are set to make the measurement.
- d. For each suspected emission, the EUT was arranged to its worst case and then the antenna was tuned to heights from 1 meter to 4 meters and the rotatable table was turned from 0 degrees to 360 degrees to find the maximum reading.
- e. The test-receiver system was set to quasi-peak detect function and specified bandwidth with maximum hold mode when the test frequency is below 1 GHz.
- f. The test-receiver system was set to peak and average detect function and specified bandwidth with maximum hold mode when the test frequency is above 1 GHz. If the peak reading value also meets average limit, measurement with the average detector is unnecessary.

Note:

1. The resolution bandwidth and video bandwidth of test receiver/spectrum analyzer is 120kHz for Quasi-peak detection (QP) at frequency below 1GHz.
2. The resolution bandwidth of test receiver/spectrum analyzer is 1 MHz and the video bandwidth is 3 MHz for Peak detection (PK) at frequency above 1GHz.
3. The resolution bandwidth of test receiver/spectrum analyzer is 1MHz and the video bandwidth is $\geq 1/T$ (Duty cycle < 98%) or 10Hz (Duty cycle $\geq 98\%$) for Average detection (AV) at frequency above 1GHz.
4. All modes of operation were investigated and the worst-case emissions are reported.

4.1.4 Deviation from Test Standard

No deviation.

4.1.5 Test Setup

For Radiated emission below 30MHz

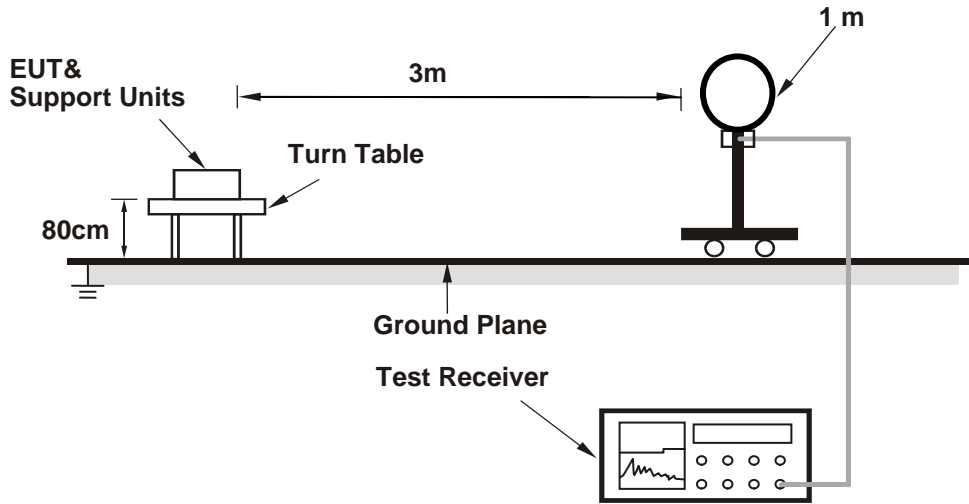

For Radiated emission 30MHz to 1GHz

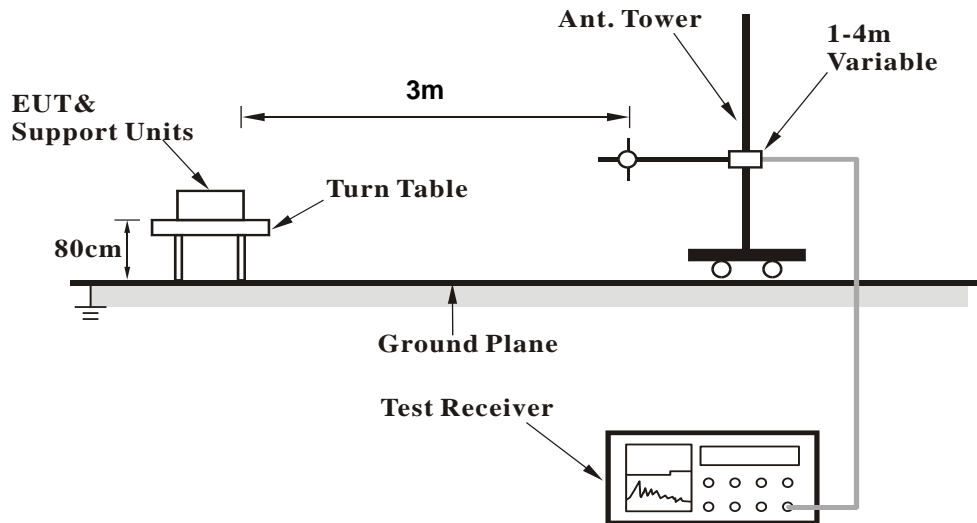

For Radiated emission above 1GHz

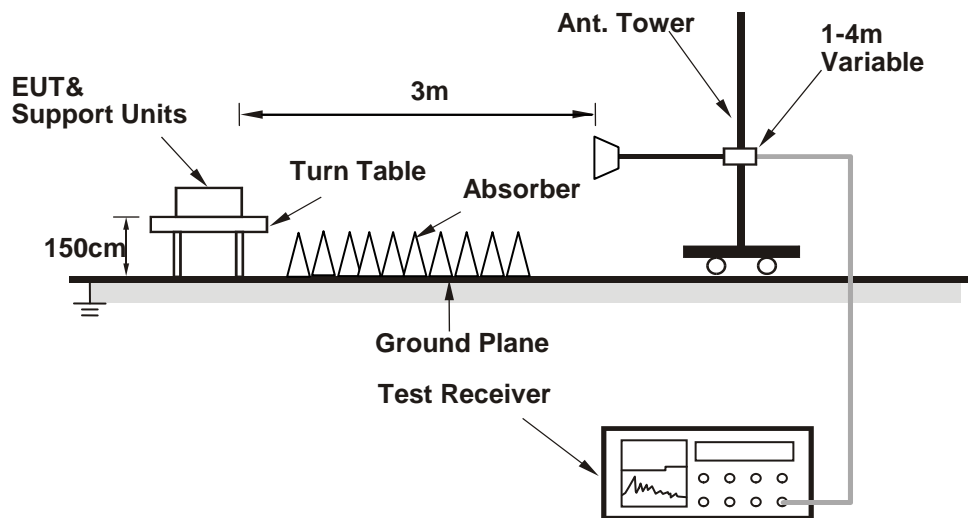

For the actual test configuration, please refer to the attached file (Test Setup Photo).

4.1.6 EUT Operating Condition

- a. Connected the EUT with the Laptop which is placed on remote site.
- b. Controlling software (QCA Radio Control Toolkit Version 3.0.210.0) has been activated to set the EUT on specific status.

4.1.7 Test Results

Above 1GHz Data:

802.11a

CHANNEL	TX Channel 36	DETECTOR FUNCTION	Peak (PK)
FREQUENCY RANGE	1GHz ~ 40GHz		Average (AV)

ANTENNA POLARITY & TEST DISTANCE: HORIZONTAL AT 3 M								
NO.	FREQ. (MHz)	EMISSION LEVEL (dBuV/m)	LIMIT (dBuV/m)	MARGIN (dB)	ANTENNA HEIGHT (m)	TABLE ANGLE (Degree)	RAW VALUE (dBuV)	CORRECTION FACTOR (dB/m)
1	5150.00	60.3 PK	74.0	-13.7	2.25 H	64	56.6	3.7
2	5150.00	49.6 AV	54.0	-4.4	2.25 H	64	45.9	3.7
3	*5180.00	109.4 PK			2.25 H	64	105.7	3.7
4	*5180.00	99.4 AV			2.25 H	64	95.7	3.7
5	#10360.00	39.4 PK	74.0	-34.6	1.14 H	200	26.4	13.0
6	#10360.00	29.5 AV	54.0	-24.5	1.14 H	200	16.5	13.0
7	15540.00	39.8 PK	74.0	-34.2	2.31 H	137	26.7	13.1
8	15540.00	30.2 AV	54.0	-23.8	2.31 H	137	17.1	13.1

ANTENNA POLARITY & TEST DISTANCE: VERTICAL AT 3 M								
NO.	FREQ. (MHz)	EMISSION LEVEL (dBuV/m)	LIMIT (dBuV/m)	MARGIN (dB)	ANTENNA HEIGHT (m)	TABLE ANGLE (Degree)	RAW VALUE (dBuV)	CORRECTION FACTOR (dB/m)
1	5150.00	66.2 PK	74.0	-7.8	2.30 V	196	62.5	3.7
2	5150.00	53.9 AV	54.0	-0.1	2.30 V	196	50.2	3.7
3	*5180.00	119.5 PK			2.30 V	196	115.8	3.7
4	*5180.00	109.1 AV			2.30 V	196	105.4	3.7
5	#10360.00	41.5 PK	74.0	-32.5	1.56 V	181	28.5	13.0
6	#10360.00	32.8 AV	54.0	-21.2	1.56 V	181	19.8	13.0
7	15540.00	44.5 PK	74.0	-29.5	1.97 V	137	31.4	13.1
8	15540.00	34.2 AV	54.0	-19.8	1.97 V	137	21.1	13.1

REMARKS:

- Emission Level(dBuV/m) = Raw Value(dBuV) + Correction Factor(dB/m)
- Correction Factor(dB/m) = Antenna Factor(dB/m) + Cable Factor(dB) – Pre-Amplifier Factor(dB)
- The other emission levels were very low against the limit.
- Margin value = Emission Level – Limit value
- " * ": Fundamental frequency.
- " # ": The radiated frequency is out of the restricted band.

CHANNEL	TX Channel 40	DETECTOR FUNCTION	Peak (PK)
FREQUENCY RANGE	1GHz ~ 40GHz		Average (AV)

ANTENNA POLARITY & TEST DISTANCE: HORIZONTAL AT 3 M

NO.	FREQ. (MHz)	EMISSION LEVEL (dBuV/m)	LIMIT (dBuV/m)	MARGIN (dB)	ANTENNA HEIGHT (m)	TABLE ANGLE (Degree)	RAW VALUE (dBuV)	CORRECTION FACTOR (dB/m)
1	5150.00	50.4 PK	74.0	-23.6	1.49 H	128	46.7	3.7
2	5150.00	38.6 AV	54.0	-15.4	1.49 H	128	34.9	3.7
3	*5200.00	111.4 PK			1.49 H	128	107.7	3.7
4	*5200.00	101.9 AV			1.49 H	128	98.2	3.7
5	5350.00	50.9 PK	74.0	-23.1	1.49 H	128	46.8	4.1
6	5350.00	39.7 AV	54.0	-14.3	1.49 H	128	35.6	4.1
7	#10400.00	41.2 PK	74.0	-32.8	1.22 H	207	28.2	13.0
8	#10400.00	31.1 AV	54.0	-22.9	1.22 H	207	18.1	13.0
9	15600.00	42.5 PK	74.0	-31.5	2.30 H	137	29.2	13.3
10	15600.00	32.1 AV	54.0	-21.9	2.30 H	137	18.8	13.3

ANTENNA POLARITY & TEST DISTANCE: VERTICAL AT 3 M

NO.	FREQ. (MHz)	EMISSION LEVEL (dBuV/m)	LIMIT (dBuV/m)	MARGIN (dB)	ANTENNA HEIGHT (m)	TABLE ANGLE (Degree)	RAW VALUE (dBuV)	CORRECTION FACTOR (dB/m)
1	5150.00	66.8 PK	74.0	-7.2	2.32 V	198	63.1	3.7
2	5150.00	53.9 AV	54.0	-0.1	2.32 V	198	50.2	3.7
3	*5200.00	122.7 PK			2.32 V	198	119.0	3.7
4	*5200.00	111.4 AV			2.32 V	198	107.7	3.7
5	5350.00	53.9 PK	74.0	-20.1	2.32 V	198	49.8	4.1
6	5350.00	40.9 AV	54.0	-13.1	2.32 V	198	36.8	4.1
7	#10400.00	44.2 PK	74.0	-29.8	1.55 V	184	31.2	13.0
8	#10400.00	35.1 AV	54.0	-18.9	1.55 V	184	22.1	13.0
9	15600.00	46.0 PK	74.0	-28.0	2.01 V	152	32.7	13.3
10	15600.00	36.1 AV	54.0	-17.9	2.01 V	152	22.8	13.3

REMARKS:

- Emission Level(dBuV/m) = Raw Value(dBuV) + Correction Factor(dB/m)
- Correction Factor(dB/m) = Antenna Factor(dB/m) + Cable Factor(dB) – Pre-Amplifier Factor(dB)
- The other emission levels were very low against the limit.
- Margin value = Emission Level – Limit value
- " * ": Fundamental frequency.
- " # ": The radiated frequency is out of the restricted band.

CHANNEL	TX Channel 48	DETECTOR FUNCTION	Peak (PK)
FREQUENCY RANGE	1GHz ~ 40GHz		Average (AV)

ANTENNA POLARITY & TEST DISTANCE: HORIZONTAL AT 3 M

NO.	FREQ. (MHz)	EMISSION LEVEL (dBuV/m)	LIMIT (dBuV/m)	MARGIN (dB)	ANTENNA HEIGHT (m)	TABLE ANGLE (Degree)	RAW VALUE (dBuV)	CORRECTION FACTOR (dB/m)
1	*5240.00	111.1 PK			1.49 H	116	107.3	3.8
2	*5240.00	101.5 AV			1.49 H	116	97.7	3.8
3	5350.00	50.5 PK	74.0	-23.5	1.49 H	116	46.4	4.1
4	5350.00	38.9 AV	54.0	-15.1	1.49 H	116	34.8	4.1
5	#10480.00	41.2 PK	74.0	-32.8	1.19 H	203	28.0	13.2
6	#10480.00	32.1 AV	54.0	-21.9	1.19 H	203	18.9	13.2
7	15720.00	43.5 PK	74.0	-30.5	2.33 H	142	29.9	13.6
8	15720.00	33.2 AV	54.0	-20.8	2.33 H	142	19.6	13.6

ANTENNA POLARITY & TEST DISTANCE: VERTICAL AT 3 M

NO.	FREQ. (MHz)	EMISSION LEVEL (dBuV/m)	LIMIT (dBuV/m)	MARGIN (dB)	ANTENNA HEIGHT (m)	TABLE ANGLE (Degree)	RAW VALUE (dBuV)	CORRECTION FACTOR (dB/m)
1	*5240.00	122.5 PK			2.34 V	199	118.7	3.8
2	*5240.00	111.3 AV			2.34 V	199	107.5	3.8
3	5350.00	54.2 PK	74.0	-19.8	2.34 V	199	50.1	4.1
4	5350.00	41.4 AV	54.0	-12.6	2.34 V	199	37.3	4.1
5	#10480.00	46.8 PK	74.0	-27.2	1.60 V	171	33.6	13.2
6	#10480.00	36.1 AV	54.0	-17.9	1.60 V	171	22.9	13.2
7	15720.00	48.9 PK	74.0	-25.1	1.99 V	152	35.3	13.6
8	15720.00	37.8 AV	54.0	-16.2	1.99 V	152	24.2	13.6

REMARKS:

1. Emission Level(dBuV/m) = Raw Value(dBuV) + Correction Factor(dB/m)
2. Correction Factor(dB/m) = Antenna Factor(dB/m) + Cable Factor(dB) – Pre-Amplifier Factor(dB)
3. The other emission levels were very low against the limit.
4. Margin value = Emission Level – Limit value
5. " * ": Fundamental frequency.
6. " # ": The radiated frequency is out of the restricted band.

CHANNEL	TX Channel 149	DETECTOR FUNCTION	Peak (PK)
FREQUENCY RANGE	1GHz ~ 40GHz		Average (AV)

ANTENNA POLARITY & TEST DISTANCE: HORIZONTAL AT 3 M

NO.	FREQ. (MHz)	EMISSION LEVEL (dBuV/m)	LIMIT (dBuV/m)	MARGIN (dB)	ANTENNA HEIGHT (m)	TABLE ANGLE (Degree)	RAW VALUE (dBuV)	CORRECTION FACTOR (dB/m)
1	*5745.00	113.1 PK			1.10 H	87	108.7	4.4
2	*5745.00	102.9 AV			1.10 H	87	98.5	4.4
3	11490.00	44.8 PK	74.0	-29.2	1.77 H	228	31.3	13.5
4	11490.00	32.2 AV	54.0	-21.8	1.77 H	228	18.7	13.5
5	#17235.00	48.4 PK	74.0	-25.6	1.65 H	165	31.1	17.3
6	#17235.00	35.6 AV	54.0	-18.4	1.65 H	165	18.3	17.3

ANTENNA POLARITY & TEST DISTANCE: VERTICAL AT 3 M

NO.	FREQ. (MHz)	EMISSION LEVEL (dBuV/m)	LIMIT (dBuV/m)	MARGIN (dB)	ANTENNA HEIGHT (m)	TABLE ANGLE (Degree)	RAW VALUE (dBuV)	CORRECTION FACTOR (dB/m)
1	*5745.00	126.1 PK			2.49 V	194	121.7	4.4
2	*5745.00	115.0 AV			2.49 V	194	110.6	4.4
3	11490.00	47.4 PK	74.0	-26.6	1.55 V	164	33.9	13.5
4	11490.00	35.9 AV	54.0	-18.1	1.55 V	164	22.4	13.5
5	#17235.00	51.8 PK	74.0	-22.2	2.01 V	153	34.5	17.3
6	#17235.00	39.2 AV	54.0	-14.8	2.01 V	153	21.9	17.3

REMARKS:

1. Emission Level(dBuV/m) = Raw Value(dBuV) + Correction Factor(dB/m)
2. Correction Factor(dB/m) = Antenna Factor(dB/m) + Cable Factor(dB) – Pre-Amplifier Factor(dB)
3. The other emission levels were very low against the limit.
4. Margin value = Emission Level – Limit value
5. " * ": Fundamental frequency.
6. " # ": The radiated frequency is out of the restricted band.

CHANNEL	TX Channel 157	DETECTOR FUNCTION	Peak (PK)
FREQUENCY RANGE	1GHz ~ 40GHz		Average (AV)

ANTENNA POLARITY & TEST DISTANCE: HORIZONTAL AT 3 M

NO.	FREQ. (MHz)	EMISSION LEVEL (dBuV/m)	LIMIT (dBuV/m)	MARGIN (dB)	ANTENNA HEIGHT (m)	TABLE ANGLE (Degree)	RAW VALUE (dBuV)	CORRECTION FACTOR (dB/m)
1	*5785.00	113.5 PK			1.09 H	101	109.1	4.4
2	*5785.00	103.2 AV			1.09 H	101	98.8	4.4
3	11570.00	44.9 PK	74.0	-29.1	1.72 H	234	31.4	13.5
4	11570.00	32.4 AV	54.0	-21.6	1.72 H	234	18.9	13.5
5	#17355.00	50.8 PK	74.0	-23.2	1.65 H	167	32.8	18.0
6	#17355.00	38.6 AV	54.0	-15.4	1.65 H	167	20.6	18.0

ANTENNA POLARITY & TEST DISTANCE: VERTICAL AT 3 M

NO.	FREQ. (MHz)	EMISSION LEVEL (dBuV/m)	LIMIT (dBuV/m)	MARGIN (dB)	ANTENNA HEIGHT (m)	TABLE ANGLE (Degree)	RAW VALUE (dBuV)	CORRECTION FACTOR (dB/m)
1	*5785.00	126.4 PK			2.48 V	193	122.0	4.4
2	*5785.00	115.4 AV			2.48 V	193	111.0	4.4
3	11570.00	47.6 PK	74.0	-26.4	1.53 V	160	34.1	13.5
4	11570.00	36.1 AV	54.0	-17.9	1.53 V	160	22.6	13.5
5	#17355.00	52.1 PK	74.0	-21.9	2.01 V	150	34.1	18.0
6	#17355.00	39.6 AV	54.0	-14.4	2.01 V	150	21.6	18.0

REMARKS:

1. Emission Level(dBuV/m) = Raw Value(dBuV) + Correction Factor(dB/m)
2. Correction Factor(dB/m) = Antenna Factor(dB/m) + Cable Factor(dB) – Pre-Amplifier Factor(dB)
3. The other emission levels were very low against the limit.
4. Margin value = Emission Level – Limit value
5. " * ": Fundamental frequency.
6. " # ": The radiated frequency is out of the restricted band.

CHANNEL	TX Channel 165	DETECTOR FUNCTION	Peak (PK)
FREQUENCY RANGE	1GHz ~ 40GHz		Average (AV)

ANTENNA POLARITY & TEST DISTANCE: HORIZONTAL AT 3 M

NO.	FREQ. (MHz)	EMISSION LEVEL (dBuV/m)	LIMIT (dBuV/m)	MARGIN (dB)	ANTENNA HEIGHT (m)	TABLE ANGLE (Degree)	RAW VALUE (dBuV)	CORRECTION FACTOR (dB/m)
1	*5825.00	113.4 PK			1.04 H	80	109.0	4.4
2	*5825.00	103.1 AV			1.04 H	80	98.7	4.4
3	11650.00	45.4 PK	74.0	-28.6	1.72 H	237	31.7	13.7
4	11650.00	32.8 AV	54.0	-21.2	1.72 H	237	19.1	13.7
5	#17475.00	51.4 PK	74.0	-22.6	1.61 H	151	32.8	18.6
6	#17475.00	39.2 AV	54.0	-14.8	1.61 H	151	20.6	18.6

ANTENNA POLARITY & TEST DISTANCE: VERTICAL AT 3 M

NO.	FREQ. (MHz)	EMISSION LEVEL (dBuV/m)	LIMIT (dBuV/m)	MARGIN (dB)	ANTENNA HEIGHT (m)	TABLE ANGLE (Degree)	RAW VALUE (dBuV)	CORRECTION FACTOR (dB/m)
1	*5825.00	126.2 PK			2.45 V	192	121.8	4.4
2	*5825.00	115.1 AV			2.45 V	192	110.7	4.4
3	11650.00	47.8 PK	74.0	-26.2	1.51 V	166	34.1	13.7
4	11650.00	36.7 AV	54.0	-17.3	1.51 V	166	23.0	13.7
5	#17475.00	52.4 PK	74.0	-21.6	2.03 V	166	33.8	18.6
6	#17475.00	39.9 AV	54.0	-14.1	2.03 V	166	21.3	18.6

REMARKS:

1. Emission Level(dBuV/m) = Raw Value(dBuV) + Correction Factor(dB/m)
2. Correction Factor(dB/m) = Antenna Factor(dB/m) + Cable Factor(dB) – Pre-Amplifier Factor(dB)
3. The other emission levels were very low against the limit.
4. Margin value = Emission Level – Limit value
5. " * ": Fundamental frequency.
6. " # ": The radiated frequency is out of the restricted band.

802.11ac (VHT20)

CHANNEL	TX Channel 36	DETECTOR FUNCTION	Peak (PK)
FREQUENCY RANGE	1GHz ~ 40GHz		Average (AV)

ANTENNA POLARITY & TEST DISTANCE: HORIZONTAL AT 3 M

NO.	FREQ. (MHz)	EMISSION LEVEL (dBuV/m)	LIMIT (dBuV/m)	MARGIN (dB)	ANTENNA HEIGHT (m)	TABLE ANGLE (Degree)	RAW VALUE (dBuV)	CORRECTION FACTOR (dB/m)
1	5150.00	66.1 PK	74.0	-7.9	1.05 H	70	62.4	3.7
2	5150.00	49.7 AV	54.0	-4.3	1.05 H	70	46.0	3.7
3	*5180.00	99.7 PK			1.05 H	70	96.0	3.7
4	*5180.00	89.3 AV			1.05 H	70	85.6	3.7
5	#10360.00	47.5 PK	74.0	-26.5	1.63 H	248	34.5	13.0
6	#10360.00	36.7 AV	54.0	-17.3	1.63 H	248	23.7	13.0
7	15540.00	51.4 PK	74.0	-22.6	1.59 H	171	38.3	13.1
8	15540.00	39.8 AV	54.0	-14.2	1.59 H	171	26.7	13.1

ANTENNA POLARITY & TEST DISTANCE: VERTICAL AT 3 M

NO.	FREQ. (MHz)	EMISSION LEVEL (dBuV/m)	LIMIT (dBuV/m)	MARGIN (dB)	ANTENNA HEIGHT (m)	TABLE ANGLE (Degree)	RAW VALUE (dBuV)	CORRECTION FACTOR (dB/m)
1	5150.00	69.2 PK	74.0	-4.8	2.55 V	196	65.5	3.7
2	5150.00	53.9 AV	54.0	-0.1	2.55 V	196	50.2	3.7
3	*5180.00	109.8 PK			2.55 V	196	106.1	3.7
4	*5180.00	99.1 AV			2.55 V	196	95.4	3.7
5	#10360.00	45.4 PK	74.0	-28.6	1.48 V	157	32.4	13.0
6	#10360.00	34.9 AV	54.0	-19.1	1.48 V	157	21.9	13.0
7	15540.00	49.8 PK	74.0	-24.2	2.05 V	161	36.7	13.1
8	15540.00	37.2 AV	54.0	-16.8	2.05 V	161	24.1	13.1

REMARKS:

- Emission Level(dBuV/m) = Raw Value(dBuV) + Correction Factor(dB/m)
- Correction Factor(dB/m) = Antenna Factor(dB/m) + Cable Factor(dB) – Pre-Amplifier Factor(dB)
- The other emission levels were very low against the limit.
- Margin value = Emission Level – Limit value
- " * ": Fundamental frequency.
- " # ": The radiated frequency is out of the restricted band.

CHANNEL	TX Channel 40	DETECTOR FUNCTION	Peak (PK)
FREQUENCY RANGE	1GHz ~ 40GHz		Average (AV)

ANTENNA POLARITY & TEST DISTANCE: HORIZONTAL AT 3 M

NO.	FREQ. (MHz)	EMISSION LEVEL (dBuV/m)	LIMIT (dBuV/m)	MARGIN (dB)	ANTENNA HEIGHT (m)	TABLE ANGLE (Degree)	RAW VALUE (dBuV)	CORRECTION FACTOR (dB/m)
1	5150.00	63.9 PK	74.0	-10.1	1.03 H	85	60.2	3.7
2	5150.00	49.6 AV	54.0	-4.4	1.03 H	85	45.9	3.7
3	*5200.00	109.7 PK			1.03 H	85	106.0	3.7
4	*5200.00	99.8 AV			1.03 H	85	96.1	3.7
5	5350.00	49.6 PK	74.0	-24.4	1.03 H	85	45.5	4.1
6	5350.00	37.9 AV	54.0	-16.1	1.03 H	85	33.8	4.1
7	#10400.00	46.8 PK	74.0	-27.2	1.64 H	243	33.8	13.0
8	#10400.00	36.3 AV	54.0	-17.7	1.64 H	243	23.3	13.0
9	15600.00	51.7 PK	74.0	-22.3	1.64 H	159	38.4	13.3
10	15600.00	39.8 AV	54.0	-14.2	1.64 H	159	26.5	13.3

ANTENNA POLARITY & TEST DISTANCE: VERTICAL AT 3 M

NO.	FREQ. (MHz)	EMISSION LEVEL (dBuV/m)	LIMIT (dBuV/m)	MARGIN (dB)	ANTENNA HEIGHT (m)	TABLE ANGLE (Degree)	RAW VALUE (dBuV)	CORRECTION FACTOR (dB/m)
1	5150.00	67.9 PK	74.0	-6.1	2.39 V	197	64.2	3.7
2	5150.00	53.9 AV	54.0	-0.1	2.39 V	197	50.2	3.7
3	*5200.00	119.9 PK			2.39 V	197	116.2	3.7
4	*5200.00	109.8 AV			2.39 V	197	106.1	3.7
5	5350.00	52.6 PK	74.0	-21.4	2.39 V	197	48.5	4.1
6	5350.00	40.3 AV	54.0	-13.7	2.39 V	197	36.2	4.1
7	#10400.00	47.6 PK	74.0	-26.4	1.50 V	160	34.6	13.0
8	#10400.00	36.4 AV	54.0	-17.6	1.50 V	160	23.4	13.0
9	15600.00	51.7 PK	74.0	-22.3	2.02 V	153	38.4	13.3
10	15600.00	39.4 AV	54.0	-14.6	2.02 V	153	26.1	13.3

REMARKS:

1. Emission Level(dBuV/m) = Raw Value(dBuV) + Correction Factor(dB/m)
2. Correction Factor(dB/m) = Antenna Factor(dB/m) + Cable Factor(dB) – Pre-Amplifier Factor(dB)
3. The other emission levels were very low against the limit.
4. Margin value = Emission Level – Limit value
5. " * ": Fundamental frequency.
6. " # ": The radiated frequency is out of the restricted band.

CHANNEL	TX Channel 48	DETECTOR FUNCTION	Peak (PK)
FREQUENCY RANGE	1GHz ~ 40GHz		Average (AV)

ANTENNA POLARITY & TEST DISTANCE: HORIZONTAL AT 3 M

NO.	FREQ. (MHz)	EMISSION LEVEL (dBuV/m)	LIMIT (dBuV/m)	MARGIN (dB)	ANTENNA HEIGHT (m)	TABLE ANGLE (Degree)	RAW VALUE (dBuV)	CORRECTION FACTOR (dB/m)
1	*5240.00	109.5 PK			1.01 H	78	105.7	3.8
2	*5240.00	99.1 AV			1.01 H	78	95.3	3.8
3	5350.00	49.1 PK	74.0	-24.9	1.01 H	78	45.0	4.1
4	5350.00	37.8 AV	54.0	-16.2	1.01 H	78	33.7	4.1
5	#10480.00	46.8 PK	74.0	-27.2	1.68 H	248	33.6	13.2
6	#10480.00	36.1 AV	54.0	-17.9	1.68 H	248	22.9	13.2
7	15720.00	51.7 PK	74.0	-22.3	1.66 H	152	38.1	13.6
8	15720.00	39.7 AV	54.0	-14.3	1.66 H	152	26.1	13.6

ANTENNA POLARITY & TEST DISTANCE: VERTICAL AT 3 M

NO.	FREQ. (MHz)	EMISSION LEVEL (dBuV/m)	LIMIT (dBuV/m)	MARGIN (dB)	ANTENNA HEIGHT (m)	TABLE ANGLE (Degree)	RAW VALUE (dBuV)	CORRECTION FACTOR (dB/m)
1	*5240.00	119.7 PK			2.27 V	195	115.9	3.8
2	*5240.00	109.4 AV			2.27 V	195	105.6	3.8
3	5350.00	51.9 PK	74.0	-22.1	2.27 V	195	47.8	4.1
4	5350.00	40.5 AV	54.0	-13.5	2.27 V	195	36.4	4.1
5	#10480.00	47.4 PK	74.0	-26.6	1.51 V	148	34.2	13.2
6	#10480.00	36.2 AV	54.0	-17.8	1.51 V	148	23.0	13.2
7	15720.00	51.9 PK	74.0	-22.1	1.99 V	163	38.3	13.6
8	15720.00	39.8 AV	54.0	-14.2	1.99 V	163	26.2	13.6

REMARKS:

1. Emission Level(dBuV/m) = Raw Value(dBuV) + Correction Factor(dB/m)
2. Correction Factor(dB/m) = Antenna Factor(dB/m) + Cable Factor(dB) – Pre-Amplifier Factor(dB)
3. The other emission levels were very low against the limit.
4. Margin value = Emission Level – Limit value
5. " * ": Fundamental frequency.
6. " # ": The radiated frequency is out of the restricted band.

CHANNEL	TX Channel 149	DETECTOR FUNCTION	Peak (PK)
FREQUENCY RANGE	1GHz ~ 40GHz		Average (AV)

ANTENNA POLARITY & TEST DISTANCE: HORIZONTAL AT 3 M

NO.	FREQ. (MHz)	EMISSION LEVEL (dBuV/m)	LIMIT (dBuV/m)	MARGIN (dB)	ANTENNA HEIGHT (m)	TABLE ANGLE (Degree)	RAW VALUE (dBuV)	CORRECTION FACTOR (dB/m)
1	*5745.00	112.6 PK			1.08 H	18	108.2	4.4
2	*5745.00	102.2 AV			1.08 H	18	97.8	4.4
3	11490.00	46.8 PK	74.0	-27.2	1.68 H	257	33.3	13.5
4	11490.00	35.9 AV	54.0	-18.1	1.68 H	257	22.4	13.5
5	#17235.00	51.9 PK	74.0	-22.1	1.73 H	145	34.6	17.3
6	#17235.00	39.9 AV	54.0	-14.1	1.73 H	145	22.6	17.3

ANTENNA POLARITY & TEST DISTANCE: VERTICAL AT 3 M

NO.	FREQ. (MHz)	EMISSION LEVEL (dBuV/m)	LIMIT (dBuV/m)	MARGIN (dB)	ANTENNA HEIGHT (m)	TABLE ANGLE (Degree)	RAW VALUE (dBuV)	CORRECTION FACTOR (dB/m)
1	*5745.00	112.8 PK			2.44 V	193	108.4	4.4
2	*5745.00	112.4 AV			2.44 V	193	108.0	4.4
3	11490.00	48.1 PK	74.0	-25.9	1.54 V	142	34.6	13.5
4	11490.00	36.8 AV	54.0	-17.2	1.54 V	142	23.3	13.5
5	#17235.00	43.4 PK	74.0	-30.6	1.94 V	180	26.1	17.3
6	#17235.00	41.1 AV	54.0	-12.9	1.94 V	180	23.8	17.3

REMARKS:

1. Emission Level(dBuV/m) = Raw Value(dBuV) + Correction Factor(dB/m)
2. Correction Factor(dB/m) = Antenna Factor(dB/m) + Cable Factor(dB) – Pre-Amplifier Factor(dB)
3. The other emission levels were very low against the limit.
4. Margin value = Emission Level – Limit value
5. " * ": Fundamental frequency.
6. " # ": The radiated frequency is out of the restricted band.

CHANNEL	TX Channel 157	DETECTOR FUNCTION	Peak (PK)
FREQUENCY RANGE	1GHz ~ 40GHz		Average (AV)

ANTENNA POLARITY & TEST DISTANCE: HORIZONTAL AT 3 M

NO.	FREQ. (MHz)	EMISSION LEVEL (dBuV/m)	LIMIT (dBuV/m)	MARGIN (dB)	ANTENNA HEIGHT (m)	TABLE ANGLE (Degree)	RAW VALUE (dBuV)	CORRECTION FACTOR (dB/m)
1	*5785.00	113.8 PK			1.05 H	31	109.4	4.4
2	*5785.00	103.4 AV			1.05 H	31	99.0	4.4
3	11570.00	46.6 PK	74.0	-27.4	1.73 H	250	33.1	13.5
4	11570.00	36.0 AV	54.0	-18.0	1.73 H	250	22.5	13.5
5	#17355.00	51.4 PK	74.0	-22.6	1.75 H	158	33.4	18.0
6	#17355.00	39.3 AV	54.0	-14.7	1.75 H	158	21.3	18.0

ANTENNA POLARITY & TEST DISTANCE: VERTICAL AT 3 M

NO.	FREQ. (MHz)	EMISSION LEVEL (dBuV/m)	LIMIT (dBuV/m)	MARGIN (dB)	ANTENNA HEIGHT (m)	TABLE ANGLE (Degree)	RAW VALUE (dBuV)	CORRECTION FACTOR (dB/m)
1	*5785.00	123.9 PK			2.45 V	192	119.5	4.4
2	*5785.00	113.6 AV			2.45 V	192	109.2	4.4
3	11570.00	48.2 PK	74.0	-25.8	1.46 V	151	34.7	13.5
4	11570.00	36.9 AV	54.0	-17.1	1.46 V	151	23.4	13.5
5	#17355.00	43.5 PK	74.0	-30.5	2.03 V	178	25.5	18.0
6	#17355.00	41.4 AV	54.0	-12.6	2.03 V	178	23.4	18.0

REMARKS:

1. Emission Level(dBuV/m) = Raw Value(dBuV) + Correction Factor(dB/m)
2. Correction Factor(dB/m) = Antenna Factor(dB/m) + Cable Factor(dB) – Pre-Amplifier Factor(dB)
3. The other emission levels were very low against the limit.
4. Margin value = Emission Level – Limit value
5. " * ": Fundamental frequency.
6. " # ": The radiated frequency is out of the restricted band.

CHANNEL	TX Channel 165	DETECTOR FUNCTION	Peak (PK)
FREQUENCY RANGE	1GHz ~ 40GHz		Average (AV)

ANTENNA POLARITY & TEST DISTANCE: HORIZONTAL AT 3 M

NO.	FREQ. (MHz)	EMISSION LEVEL (dBuV/m)	LIMIT (dBuV/m)	MARGIN (dB)	ANTENNA HEIGHT (m)	TABLE ANGLE (Degree)	RAW VALUE (dBuV)	CORRECTION FACTOR (dB/m)
1	*5825.00	113.7 PK			1.10 H	39	109.3	4.4
2	*5825.00	103.1 AV			1.10 H	39	98.7	4.4
3	11650.00	46.5 PK	74.0	-27.5	1.68 H	255	32.8	13.7
4	11650.00	35.7 AV	54.0	-18.3	1.68 H	255	22.0	13.7
5	#17475.00	51.7 PK	74.0	-22.3	1.71 H	156	33.1	18.6
6	#17475.00	39.7 AV	54.0	-14.3	1.71 H	156	21.1	18.6

ANTENNA POLARITY & TEST DISTANCE: VERTICAL AT 3 M

NO.	FREQ. (MHz)	EMISSION LEVEL (dBuV/m)	LIMIT (dBuV/m)	MARGIN (dB)	ANTENNA HEIGHT (m)	TABLE ANGLE (Degree)	RAW VALUE (dBuV)	CORRECTION FACTOR (dB/m)
1	*5825.00	123.7 PK			2.55 V	195	119.3	4.4
2	*5825.00	113.2 AV			2.55 V	195	108.8	4.4
3	11650.00	48.1 PK	74.0	-25.9	1.49 V	154	34.4	13.7
4	11650.00	36.9 AV	54.0	-17.1	1.49 V	154	23.2	13.7
5	#17475.00	43.5 PK	74.0	-30.5	1.97 V	178	24.9	18.6
6	#17475.00	41.2 AV	54.0	-12.8	1.97 V	178	22.6	18.6

REMARKS:

1. Emission Level(dBuV/m) = Raw Value(dBuV) + Correction Factor(dB/m)
2. Correction Factor(dB/m) = Antenna Factor(dB/m) + Cable Factor(dB) – Pre-Amplifier Factor(dB)
3. The other emission levels were very low against the limit.
4. Margin value = Emission Level – Limit value
5. " * ": Fundamental frequency.
6. " # ": The radiated frequency is out of the restricted band.

802.11ac (VHT40)

CHANNEL	TX Channel 38	DETECTOR FUNCTION	Peak (PK)
FREQUENCY RANGE	1GHz ~ 40GHz		Average (AV)

ANTENNA POLARITY & TEST DISTANCE: HORIZONTAL AT 3 M

NO.	FREQ. (MHz)	EMISSION LEVEL (dBuV/m)	LIMIT (dBuV/m)	MARGIN (dB)	ANTENNA HEIGHT (m)	TABLE ANGLE (Degree)	RAW VALUE (dBuV)	CORRECTION FACTOR (dB/m)
1	5150.00	64.2 PK	74.0	-9.8	1.07 H	37	60.5	3.7
2	5150.00	49.8 AV	54.0	-4.2	1.07 H	37	46.1	3.7
3	*5190.00	107.5 PK			1.07 H	37	103.8	3.7
4	*5190.00	97.8 AV			1.07 H	37	94.1	3.7
5	5350.00	49.8 PK	74.0	-24.2	1.07 H	37	45.7	4.1
6	5350.00	45.1 AV	54.0	-8.9	1.07 H	37	41.0	4.1
7	#10380.00	43.8 PK	74.0	-30.2	1.72 H	254	30.7	13.1
8	#10380.00	31.5 AV	54.0	-22.5	1.72 H	254	18.4	13.1
9	15570.00	46.8 PK	74.0	-27.2	1.73 H	166	33.5	13.3
10	15570.00	34.9 AV	54.0	-19.1	1.73 H	166	21.6	13.3

ANTENNA POLARITY & TEST DISTANCE: VERTICAL AT 3 M

NO.	FREQ. (MHz)	EMISSION LEVEL (dBuV/m)	LIMIT (dBuV/m)	MARGIN (dB)	ANTENNA HEIGHT (m)	TABLE ANGLE (Degree)	RAW VALUE (dBuV)	CORRECTION FACTOR (dB/m)
1	5150.00	67.8 PK	74.0	-6.2	2.52 V	164	64.1	3.7
2	5150.00	53.9 AV	54.0	-0.1	2.52 V	164	50.2	3.7
3	*5190.00	117.9 PK			2.52 V	164	114.2	3.7
4	*5190.00	107.6 AV			2.52 V	164	103.9	3.7
5	5350.00	52.7 PK	74.0	-21.3	2.52 V	164	48.6	4.1
6	5350.00	48.1 AV	54.0	-5.9	2.52 V	164	44.0	4.1
7	#10380.00	46.7 PK	74.0	-27.3	1.59 V	150	33.6	13.1
8	#10380.00	34.6 AV	54.0	-19.4	1.59 V	150	21.5	13.1
9	15570.00	50.8 PK	74.0	-23.2	1.95 V	164	37.5	13.3
10	15570.00	38.4 AV	54.0	-15.6	1.95 V	164	25.1	13.3

REMARKS:

- Emission Level(dBuV/m) = Raw Value(dBuV) + Correction Factor(dB/m)
- Correction Factor(dB/m) = Antenna Factor(dB/m) + Cable Factor(dB) – Pre-Amplifier Factor(dB)
- The other emission levels were very low against the limit.
- Margin value = Emission Level – Limit value
- " * ": Fundamental frequency.
- " # ": The radiated frequency is out of the restricted band.

CHANNEL	TX Channel 46	DETECTOR FUNCTION	Peak (PK)
FREQUENCY RANGE	1GHz ~ 40GHz		Average (AV)

ANTENNA POLARITY & TEST DISTANCE: HORIZONTAL AT 3 M

NO.	FREQ. (MHz)	EMISSION LEVEL (dBuV/m)	LIMIT (dBuV/m)	MARGIN (dB)	ANTENNA HEIGHT (m)	TABLE ANGLE (Degree)	RAW VALUE (dBuV)	CORRECTION FACTOR (dB/m)
1	*5230.00	117.8 PK			1.06 H	37	114.0	3.8
2	*5230.00	107.5 AV			1.06 H	37	103.7	3.8
3	5350.00	62.1 PK	74.0	-11.9	1.06 H	37	58.0	4.1
4	5350.00	47.3 AV	54.0	-6.7	1.06 H	37	43.2	4.1
5	#10460.00	47.9 PK	74.0	-26.1	1.73 H	266	34.8	13.1
6	#10460.00	35.6 AV	54.0	-18.4	1.73 H	266	22.5	13.1
7	15690.00	51.1 PK	74.0	-22.9	1.70 H	161	37.3	13.8
8	15690.00	39.5 AV	54.0	-14.5	1.70 H	161	25.7	13.8

ANTENNA POLARITY & TEST DISTANCE: VERTICAL AT 3 M

NO.	FREQ. (MHz)	EMISSION LEVEL (dBuV/m)	LIMIT (dBuV/m)	MARGIN (dB)	ANTENNA HEIGHT (m)	TABLE ANGLE (Degree)	RAW VALUE (dBuV)	CORRECTION FACTOR (dB/m)
1	*5230.00	122.9 PK			2.55 V	195	119.1	3.8
2	*5230.00	121.1 AV			2.55 V	195	117.3	3.8
3	5350.00	65.1 PK	74.0	-8.9	2.55 V	195	61.0	4.1
4	5350.00	50.0 AV	54.0	-4.0	2.55 V	195	45.9	4.1
5	#10460.00	50.1 PK	74.0	-23.9	1.53 V	146	37.0	13.1
6	#10460.00	38.9 AV	54.0	-15.1	1.53 V	146	25.8	13.1
7	15690.00	54.7 PK	74.0	-19.3	1.96 V	177	40.9	13.8
8	15690.00	42.8 AV	54.0	-11.2	1.96 V	177	29.0	13.8

REMARKS:

1. Emission Level(dBuV/m) = Raw Value(dBuV) + Correction Factor(dB/m)
2. Correction Factor(dB/m) = Antenna Factor(dB/m) + Cable Factor(dB) – Pre-Amplifier Factor(dB)
3. The other emission levels were very low against the limit.
4. Margin value = Emission Level – Limit value
5. " * ": Fundamental frequency.
6. " # ": The radiated frequency is out of the restricted band.

CHANNEL	TX Channel 151	DETECTOR FUNCTION	Peak (PK)
FREQUENCY RANGE	1GHz ~ 40GHz		Average (AV)

ANTENNA POLARITY & TEST DISTANCE: HORIZONTAL AT 3 M

NO.	FREQ. (MHz)	EMISSION LEVEL (dBuV/m)	LIMIT (dBuV/m)	MARGIN (dB)	ANTENNA HEIGHT (m)	TABLE ANGLE (Degree)	RAW VALUE (dBuV)	CORRECTION FACTOR (dB/m)
1	*5755.00	111.9 PK			1.33 H	72	107.5	4.4
2	*5755.00	101.1 AV			1.33 H	72	96.7	4.4
3	11510.00	47.5 PK	74.0	-26.5	1.74 H	262	33.9	13.6
4	11510.00	36.1 AV	54.0	-17.9	1.74 H	262	22.5	13.6
5	#17265.00	50.5 PK	74.0	-23.5	1.75 H	155	32.9	17.6
6	#17265.00	39.8 AV	54.0	-14.2	1.75 H	155	22.2	17.6

ANTENNA POLARITY & TEST DISTANCE: VERTICAL AT 3 M

NO.	FREQ. (MHz)	EMISSION LEVEL (dBuV/m)	LIMIT (dBuV/m)	MARGIN (dB)	ANTENNA HEIGHT (m)	TABLE ANGLE (Degree)	RAW VALUE (dBuV)	CORRECTION FACTOR (dB/m)
1	*5755.00	123.8 PK			2.62 V	194	119.4	4.4
2	*5755.00	113.7 AV			2.62 V	194	109.3	4.4
3	11510.00	50.4 PK	74.0	-23.6	1.54 V	130	36.8	13.6
4	11510.00	39.0 AV	54.0	-15.0	1.54 V	130	25.4	13.6
5	#17265.00	54.5 PK	74.0	-19.5	1.99 V	181	36.9	17.6
6	#17265.00	42.8 AV	54.0	-11.2	1.99 V	181	25.2	17.6

REMARKS:

1. Emission Level(dBuV/m) = Raw Value(dBuV) + Correction Factor(dB/m)
2. Correction Factor(dB/m) = Antenna Factor(dB/m) + Cable Factor(dB) – Pre-Amplifier Factor(dB)
3. The other emission levels were very low against the limit.
4. Margin value = Emission Level – Limit value
5. " * ": Fundamental frequency.
6. " # ": The radiated frequency is out of the restricted band.

CHANNEL	TX Channel 159	DETECTOR FUNCTION	Peak (PK)
FREQUENCY RANGE	1GHz ~ 40GHz		Average (AV)

ANTENNA POLARITY & TEST DISTANCE: HORIZONTAL AT 3 M

NO.	FREQ. (MHz)	EMISSION LEVEL (dBuV/m)	LIMIT (dBuV/m)	MARGIN (dB)	ANTENNA HEIGHT (m)	TABLE ANGLE (Degree)	RAW VALUE (dBuV)	CORRECTION FACTOR (dB/m)
1	*5795.00	112.6 PK			1.38 H	80	108.2	4.4
2	*5795.00	102.3 AV			1.38 H	80	97.9	4.4
3	11590.00	49.6 PK	74.0	-24.4	1.78 H	259	36.1	13.5
4	11590.00	38.2 AV	54.0	-15.8	1.78 H	259	24.7	13.5
5	#17385.00	52.9 PK	74.0	-21.1	1.68 H	149	34.6	18.3
6	#17385.00	42.1 AV	54.0	-11.9	1.68 H	149	23.8	18.3

ANTENNA POLARITY & TEST DISTANCE: VERTICAL AT 3 M

NO.	FREQ. (MHz)	EMISSION LEVEL (dBuV/m)	LIMIT (dBuV/m)	MARGIN (dB)	ANTENNA HEIGHT (m)	TABLE ANGLE (Degree)	RAW VALUE (dBuV)	CORRECTION FACTOR (dB/m)
1	*5795.00	123.9 PK			2.61 V	195	119.5	4.4
2	*5795.00	113.4 AV			2.61 V	195	109.0	4.4
3	11590.00	52.6 PK	74.0	-21.4	1.49 V	143	39.1	13.5
4	11590.00	41.2 AV	54.0	-12.8	1.49 V	143	27.7	13.5
5	#17385.00	55.9 PK	74.0	-18.1	1.96 V	184	37.6	18.3
6	#17385.00	44.8 AV	54.0	-9.2	1.96 V	184	26.5	18.3

REMARKS:

1. Emission Level(dBuV/m) = Raw Value(dBuV) + Correction Factor(dB/m)
2. Correction Factor(dB/m) = Antenna Factor(dB/m) + Cable Factor(dB) – Pre-Amplifier Factor(dB)
3. The other emission levels were very low against the limit.
4. Margin value = Emission Level – Limit value
5. " * ": Fundamental frequency.
6. " # ": The radiated frequency is out of the restricted band.

802.11ac (VHT80)

CHANNEL	TX Channel 42	DETECTOR FUNCTION	Peak (PK)
FREQUENCY RANGE	1GHz ~ 40GHz		Average (AV)

ANTENNA POLARITY & TEST DISTANCE: HORIZONTAL AT 3 M

NO.	FREQ. (MHz)	EMISSION LEVEL (dBuV/m)	LIMIT (dBuV/m)	MARGIN (dB)	ANTENNA HEIGHT (m)	TABLE ANGLE (Degree)	RAW VALUE (dBuV)	CORRECTION FACTOR (dB/m)
1	5150.00	60.2 PK	74.0	-13.8	1.43 H	71	56.5	3.7
2	5150.00	49.1 AV	54.0	-4.9	1.43 H	71	45.4	3.7
3	*5210.00	104.5 PK			1.43 H	71	100.8	3.7
4	*5210.00	94.6 AV			1.43 H	71	90.9	3.7
5	5350.00	54.6 PK	74.0	-19.4	1.43 H	71	50.5	4.1
6	5350.00	44.2 AV	54.0	-9.8	1.43 H	71	40.1	4.1
7	#10420.00	42.4 PK	74.0	-31.6	1.79 H	270	29.3	13.1
8	#10420.00	31.6 AV	54.0	-22.4	1.79 H	270	18.5	13.1
9	15630.00	45.8 PK	74.0	-28.2	1.69 H	154	32.2	13.6
10	15630.00	34.2 AV	54.0	-19.8	1.69 H	154	20.6	13.6

ANTENNA POLARITY & TEST DISTANCE: VERTICAL AT 3 M

NO.	FREQ. (MHz)	EMISSION LEVEL (dBuV/m)	LIMIT (dBuV/m)	MARGIN (dB)	ANTENNA HEIGHT (m)	TABLE ANGLE (Degree)	RAW VALUE (dBuV)	CORRECTION FACTOR (dB/m)
1	5150.00	63.7 PK	74.0	-10.3	2.48 V	164	60.0	3.7
2	5150.00	53.9 AV	54.0	-0.1	2.48 V	164	50.2	3.7
3	*5210.00	111.4 PK			2.48 V	164	107.7	3.7
4	*5210.00	102.7 AV			2.48 V	164	99.0	3.7
5	5350.00	61.4 PK	74.0	-12.6	2.48 V	164	57.3	4.1
6	5350.00	47.8 AV	54.0	-6.2	2.48 V	164	43.7	4.1
7	#10420.00	45.9 PK	74.0	-28.1	1.48 V	136	32.8	13.1
8	#10420.00	34.1 AV	54.0	-19.9	1.48 V	136	21.0	13.1
9	15630.00	48.2 PK	74.0	-25.8	1.99 V	185	34.6	13.6
10	15630.00	37.5 AV	54.0	-16.5	1.99 V	185	23.9	13.6

REMARKS:

- Emission Level(dBuV/m) = Raw Value(dBuV) + Correction Factor(dB/m)
- Correction Factor(dB/m) = Antenna Factor(dB/m) + Cable Factor(dB) – Pre-Amplifier Factor(dB)
- The other emission levels were very low against the limit.
- Margin value = Emission Level – Limit value
- " * ": Fundamental frequency.
- " # ": The radiated frequency is out of the restricted band.

CHANNEL	TX Channel 155	DETECTOR FUNCTION	Peak (PK)
FREQUENCY RANGE	1GHz ~ 40GHz		Average (AV)

ANTENNA POLARITY & TEST DISTANCE: HORIZONTAL AT 3 M

NO.	FREQ. (MHz)	EMISSION LEVEL (dBuV/m)	LIMIT (dBuV/m)	MARGIN (dB)	ANTENNA HEIGHT (m)	TABLE ANGLE (Degree)	RAW VALUE (dBuV)	CORRECTION FACTOR (dB/m)
1	*5775.00	105.4 PK			1.26 H	88	101.0	4.4
2	*5775.00	95.8 AV			1.26 H	88	91.4	4.4
3	11550.00	43.1 PK	74.0	-30.9	1.74 H	260	29.6	13.5
4	11550.00	32.8 AV	54.0	-21.2	1.74 H	260	19.3	13.5
5	#17325.00	46.9 PK	74.0	-27.1	1.64 H	161	29.1	17.8
6	#17325.00	35.1 AV	54.0	-18.9	1.64 H	161	17.3	17.8

ANTENNA POLARITY & TEST DISTANCE: VERTICAL AT 3 M

NO.	FREQ. (MHz)	EMISSION LEVEL (dBuV/m)	LIMIT (dBuV/m)	MARGIN (dB)	ANTENNA HEIGHT (m)	TABLE ANGLE (Degree)	RAW VALUE (dBuV)	CORRECTION FACTOR (dB/m)
1	*5775.00	115.9 PK			2.62 V	193	111.5	4.4
2	*5775.00	105.6 AV			2.62 V	193	101.2	4.4
3	11550.00	46.2 PK	74.0	-27.8	1.50 V	129	32.7	13.5
4	11550.00	35.1 AV	54.0	-18.9	1.50 V	129	21.6	13.5
5	#17325.00	49.7 PK	74.0	-24.3	2.02 V	200	31.9	17.8
6	#17325.00	38.6 AV	54.0	-15.4	2.02 V	200	20.8	17.8

REMARKS:

1. Emission Level(dBuV/m) = Raw Value(dBuV) + Correction Factor(dB/m)
2. Correction Factor(dB/m) = Antenna Factor(dB/m) + Cable Factor(dB) – Pre-Amplifier Factor(dB)
3. The other emission levels were very low against the limit.
4. Margin value = Emission Level – Limit value
5. " * ": Fundamental frequency.
6. " # ": The radiated frequency is out of the restricted band.

802.11ac (VHT80+80)

CHANNEL	TX Channel 42+155	DETECTOR FUNCTION	Peak (PK)
FREQUENCY RANGE	1GHz ~ 40GHz		Average (AV)

ANTENNA POLARITY & TEST DISTANCE: HORIZONTAL AT 3 M

NO.	FREQ. (MHz)	EMISSION LEVEL (dBuV/m)	LIMIT (dBuV/m)	MARGIN (dB)	ANTENNA HEIGHT (m)	TABLE ANGLE (Degree)	RAW VALUE (dBuV)	CORRECTION FACTOR (dB/m)
1	5150.00	58.5 PK	74.0	-15.5	1.59 H	43	54.8	3.7
2	5150.00	44.7 AV	54.0	-9.3	1.59 H	43	41.0	3.7
3	*5210.00	110.2 PK			1.59 H	43	106.5	3.7
4	*5210.00	89.9 AV			1.59 H	43	86.2	3.7
5	5350.00	49.2 PK	74.0	-24.8	1.59 H	43	45.1	4.1
6	5350.00	36.8 AV	54.0	-17.2	1.59 H	43	32.7	4.1
7	*5775.00	102.5 PK			1.42 H	72	98.1	4.4
8	*5775.00	92.1 AV			1.42 H	72	87.7	4.4
9	#10420.00	44.6 PK	74.0	-29.4	1.72 H	256	31.5	13.1
10	#10420.00	33.5 AV	54.0	-20.5	1.72 H	256	20.4	13.1
11	11550.00	47.5 PK	74.0	-26.5	1.69 H	270	34.0	13.5
12	11550.00	36.1 AV	54.0	-17.9	1.69 H	270	22.6	13.5
13	15630.00	47.9 PK	74.0	-26.1	1.59 H	145	34.3	13.6
14	15630.00	36.7 AV	54.0	-17.3	1.59 H	145	23.1	13.6
15	#17325.00	48.1 PK	74.0	-25.9	1.59 H	175	30.3	17.8
16	#17325.00	37.8 AV	54.0	-16.2	1.59 H	175	20.0	17.8

ANTENNA POLARITY & TEST DISTANCE: VERTICAL AT 3 M

NO.	FREQ. (MHz)	EMISSION LEVEL (dBuV/m)	LIMIT (dBuV/m)	MARGIN (dB)	ANTENNA HEIGHT (m)	TABLE ANGLE (Degree)	RAW VALUE (dBuV)	CORRECTION FACTOR (dB/m)
1	5150.00	66.2 PK	74.0	-7.8	2.39 V	168	62.5	3.7
2	5150.00	53.9 AV	54.0	-0.1	2.39 V	168	50.2	3.7
3	*5210.00	110.1 PK			2.39 V	168	106.4	3.7
4	*5210.00	100.7 AV			2.39 V	168	97.0	3.7
5	5350.00	57.9 PK	74.0	-16.1	2.39 V	168	53.8	4.1
6	5350.00	45.4 AV	54.0	-8.6	2.39 V	168	41.3	4.1
7	*5775.00	112.3 PK			2.37 V	172	107.9	4.4
8	*5775.00	102.2 AV			2.37 V	172	97.8	4.4
9	#10420.00	46.9 PK	74.0	-27.1	1.46 V	115	33.8	13.1
10	#10420.00	35.8 AV	54.0	-18.2	1.46 V	115	22.7	13.1
11	11550.00	50.8 PK	74.0	-23.2	1.45 V	112	37.3	13.5
12	11550.00	39.2 AV	54.0	-14.8	1.45 V	112	25.7	13.5
13	15630.00	59.1 PK	74.0	-14.9	1.99 V	194	45.5	13.6
14	15630.00	39.5 AV	54.0	-14.5	1.99 V	194	25.9	13.6
15	#17325.00	52.6 PK	74.0	-21.4	1.98 V	189	34.8	17.8
16	#17325.00	41.2 AV	54.0	-12.8	1.98 V	189	23.4	17.8

REMARKS:

1. Emission Level(dBuV/m) = Raw Value(dBuV) + Correction Factor(dB/m)
2. Correction Factor(dB/m) = Antenna Factor(dB/m) + Cable Factor(dB) – Pre-Amplifier Factor(dB)
3. The other emission levels were very low against the limit.
4. Margin value = Emission Level – Limit value
5. " * ": Fundamental frequency.
6. " # ": The radiated frequency is out of the restricted band.

Below 1GHz Data:

802.11a

CHANNEL	TX Channel 157	DETECTOR FUNCTION	Quasi-Peak (QP)
FREQUENCY RANGE	9kHz ~ 1GHz		

ANTENNA POLARITY & TEST DISTANCE: HORIZONTAL AT 3 M

NO.	FREQ. (MHz)	EMISSION LEVEL (dBuV/m)	LIMIT (dBuV/m)	MARGIN (dB)	ANTENNA HEIGHT (m)	TABLE ANGLE (Degree)	RAW VALUE (dBuV)	CORRECTION FACTOR (dB/m)
1	133.50	34.5 QP	43.5	-9.0	2.50 H	274	43.7	-9.2
2	368.00	35.1 QP	46.0	-10.9	1.50 H	74	41.2	-6.1
3	466.51	34.1 QP	46.0	-11.9	2.50 H	301	37.7	-3.6
4	584.51	29.9 QP	46.0	-16.1	1.50 H	36	31.2	-1.3
5	751.20	31.2 QP	46.0	-14.8	1.50 H	274	29.6	1.6
6	889.50	36.1 QP	46.0	-9.9	1.00 H	132	33.3	2.8

ANTENNA POLARITY & TEST DISTANCE: VERTICAL AT 3 M

NO.	FREQ. (MHz)	EMISSION LEVEL (dBuV/m)	LIMIT (dBuV/m)	MARGIN (dB)	ANTENNA HEIGHT (m)	TABLE ANGLE (Degree)	RAW VALUE (dBuV)	CORRECTION FACTOR (dB/m)
1	56.12	27.9 QP	40.0	-12.1	3.00 V	291	36.2	-8.3
2	200.51	32.6 QP	43.5	-10.9	2.50 V	137	43.9	-11.3
3	295.64	36.2 QP	46.0	-9.8	1.50 V	24	43.8	-7.6
4	416.13	36.3 QP	46.0	-9.7	1.00 V	352	41.2	-4.9
5	635.00	34.9 QP	46.0	-11.1	1.00 V	312	35.2	-0.3
6	874.99	32.1 QP	46.0	-13.9	2.50 V	360	29.5	2.6

REMARKS:

1. Emission Level(dBuV/m) = Raw Value(dBuV) + Correction Factor(dB/m)
2. Correction Factor(dB/m) = Antenna Factor(dB/m) + Cable Factor(dB) – Pre-Amplifier Factor(dB)
3. The other emission levels were very low against the limit.
4. Margin value = Emission Level – Limit value

4.2 Conducted Emission Measurement

4.2.1 Limits of Conducted Emission Measurement

Frequency (MHz)	Conducted Limit (dBuV)	
	Quasi-peak	Average
0.15 - 0.5	66 - 56	56 - 46
0.50 - 5.0	56	46
5.0 - 30.0	60	50

Note: 1. The lower limit shall apply at the transition frequencies.

2. The limit decreases in line with the logarithm of the frequency in the range of 0.15 to 0.50MHz.

4.2.2 Test Instruments

DESCRIPTION & MANUFACTURER	MODEL NO.	SERIAL NO.	CALIBRATED DATE	CALIBRATED UNTIL
Test Receiver R&S	ESCS 30	847124/029	Oct. 24, 2016	Oct. 23, 2017
Line-Impedance Stabilization Network (for EUT) R&S	ESH3-Z5	848773/004	Oct. 26, 2016	Oct. 25, 2017
Line-Impedance Stabilization Network (for Peripheral) R&S	ENV216	100072	June 03, 2017	June 02, 2018
50 ohms Terminator	N/A	EMC-02	Sep. 22, 2017	Sep. 21, 2018
RF Cable	5D-FB	COCCAB-001	Sep. 29, 2017	Sep. 28, 2018
10 dB PAD Mini-Circuits	HAT-10+	CONATT-004	June 18, 2017	June 17, 2018
Software BVADT	BVADT_Cond_ V7.3.7.4	NA	NA	NA

Note:

1. The calibration interval of the above test instruments are 12 months and the calibrations are traceable to NML/ROC and NIST/USA.
2. The test was performed in Shielded Room No. 1.
- 3 Tested Date: Oct. 23, 2017

4.2.3 Test Procedure

- The EUT was placed 0.4 meters from the conducting wall of the shielded room with EUT being connected to the power mains through a line impedance stabilization network (LISN). Other support units were connected to the power mains through another LISN. The two LISNs provide 50 ohm/ 50uH of coupling impedance for the measuring instrument.
- Both lines of the power mains connected to the EUT were checked for maximum conducted interference.
- The frequency range from 150kHz to 30MHz was searched. Emission levels under (Limit - 20dB) was not recorded.

NOTE: All modes of operation were investigated and the worst-case emissions are reported.

4.2.4 Deviation from Test Standard

No deviation.

4.2.5 Test Setup

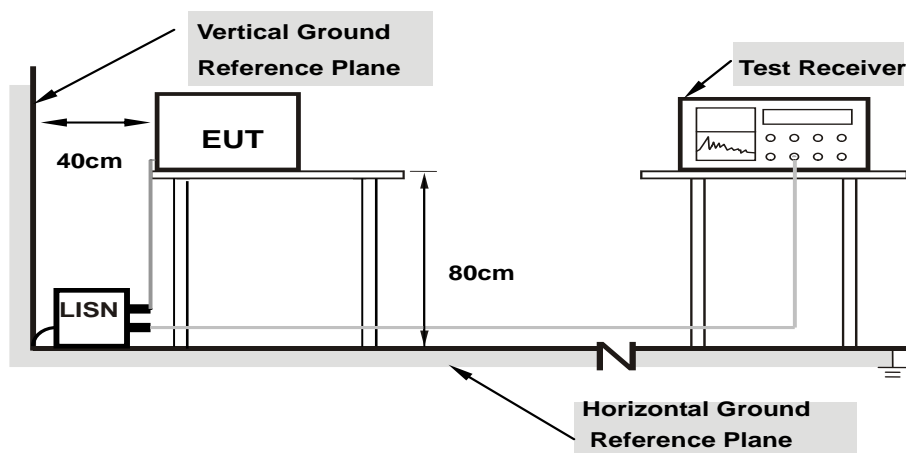

Note: 1.Support units were connected to second LISN.

For the actual test configuration, please refer to the attached file (Test Setup Photo).

4.2.6 EUT Operating Condition

Same as 4.1.6.

4.2.7 Test Results (Mode 1)

Phase	Line (L)	Detector Function	Quasi-Peak (QP) / Average (AV)
-------	----------	-------------------	--------------------------------

No	Freq. [MHz]	Corr. Factor	Reading Value [dB (uV)]		Emission Level [dB (uV)]		Limit [dB (uV)]		Margin (dB)	
		(dB)	Q.P.	AV.	Q.P.	AV.	Q.P.	AV.	Q.P.	AV.
	1	0.15000	10.07	37.17	23.47	47.24	33.54	66.00	56.00	-18.76
2	0.21250	10.06	25.39	14.67	35.45	24.73	63.11	53.11	-27.66	-28.38
3	0.44434	10.11	38.80	32.40	48.91	42.51	56.98	46.98	-8.07	-4.47
4	0.76719	10.13	26.25	20.77	36.38	30.90	56.00	46.00	-19.62	-15.10
5	2.61719	10.19	26.95	18.69	37.14	28.88	56.00	46.00	-18.86	-17.12
6	6.37500	10.42	28.32	23.10	38.74	33.52	60.00	50.00	-21.26	-16.48

REMARKS:

1. Q.P. and AV. are abbreviations of quasi-peak and average individually.
2. The emission levels of other frequencies were very low against the limit.
3. Margin value = Emission level - Limit value
4. Correction factor = Insertion loss + Cable loss
5. Emission Level = Correction Factor + Reading Value.

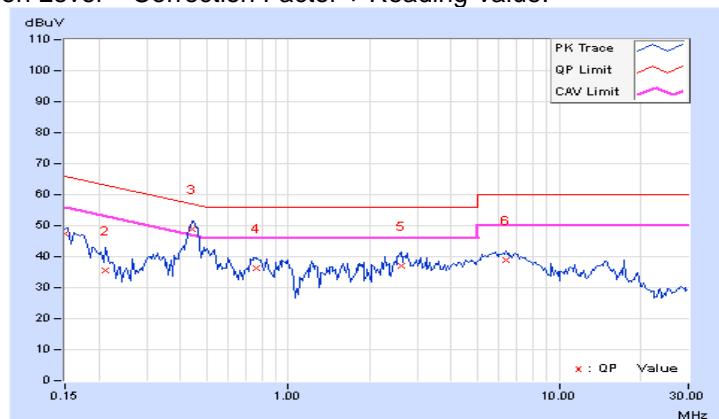

Phase	Neutral (N)	Detector Function	Quasi-Peak (QP) / Average (AV)
-------	-------------	-------------------	--------------------------------

No	Freq. [MHz]	Corr.	Reading Value		Emission Level		Limit		Margin	
		Factor	[dB (uV)]		[dB (uV)]		[dB (uV)]		(dB)	
	(dB)	Q.P.	AV.	Q.P.	AV.	Q.P.	AV.	Q.P.	AV.	
1	0.15000	10.06	36.77	23.83	46.83	33.89	66.00	56.00	-19.17	-22.11
2	0.31797	10.07	28.31	21.60	38.38	31.67	59.76	49.76	-21.38	-18.09
3	0.44053	10.10	38.88	33.05	48.98	43.15	57.05	47.05	-8.07	-3.90
4	0.79453	10.11	25.20	18.77	35.31	28.88	56.00	46.00	-20.69	-17.12
5	2.67578	10.19	28.06	20.48	38.25	30.67	56.00	46.00	-17.75	-15.33
6	14.68359	10.77	22.40	16.17	33.17	26.94	60.00	50.00	-26.83	-23.06

REMARKS:

1. Q.P. and AV. are abbreviations of quasi-peak and average individually.
2. The emission levels of other frequencies were very low against the limit.
3. Margin value = Emission level - Limit value
4. Correction factor = Insertion loss + Cable loss
5. Emission Level = Correction Factor + Reading Value.

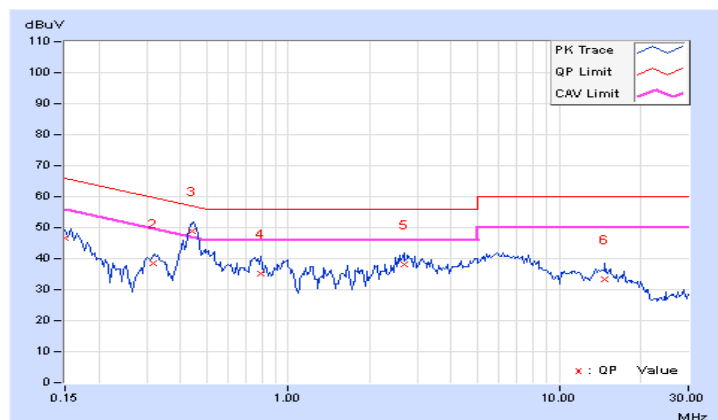

4.2.8 Test Results (Mode 2)

Phase	Line (L)	Detector Function	Quasi-Peak (QP) / Average (AV)
-------	----------	-------------------	--------------------------------

No	Freq. [MHz]	Corr. Factor	Reading Value [dB (uV)]		Emission Level [dB (uV)]		Limit [dB (uV)]		Margin (dB)	
		(dB)	Q.P.	AV.	Q.P.	AV.	Q.P.	AV.	Q.P.	AV.
	1	0.15000	10.07	31.43	17.74	41.50	27.81	66.00	56.00	-24.50
2	0.17734	10.06	33.82	21.90	43.88	31.96	64.61	54.61	-20.73	-22.65
3	0.39219	10.11	31.44	29.80	41.55	39.91	58.02	48.02	-16.47	-8.11
4	3.00781	10.22	21.66	11.27	31.88	21.49	56.00	46.00	-24.12	-24.51
5	15.01172	10.96	27.29	19.14	38.25	30.10	60.00	50.00	-21.75	-19.90
6	16.50781	11.06	26.18	18.16	37.24	29.22	60.00	50.00	-22.76	-20.78

REMARKS:

1. Q.P. and AV. are abbreviations of quasi-peak and average individually.
2. The emission levels of other frequencies were very low against the limit.
3. Margin value = Emission level - Limit value
4. Correction factor = Insertion loss + Cable loss
5. Emission Level = Correction Factor + Reading Value.

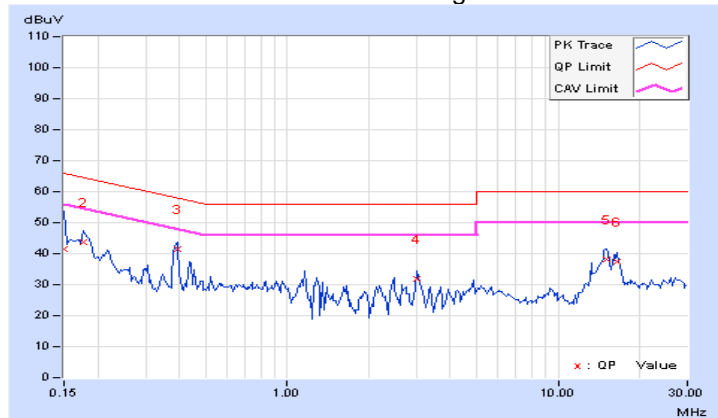

Phase	Neutral (N)	Detector Function	Quasi-Peak (QP) / Average (AV)
-------	-------------	-------------------	--------------------------------

No	Freq. [MHz]	Corr. Factor	Reading Value [dB (uV)]		Emission Level [dB (uV)]		Limit [dB (uV)]		Margin (dB)	
		(dB)	Q.P.	AV.	Q.P.	AV.	Q.P.	AV.	Q.P.	AV.
	1	0.15391	10.06	29.96	17.81	40.02	27.87	65.79	55.79	-25.77
2	0.17734	10.04	31.64	21.71	41.68	31.75	64.61	54.61	-22.93	-22.86
3	0.38925	10.10	29.86	27.23	39.96	37.33	58.08	48.08	-18.12	-10.75
4	0.43906	10.10	23.53	20.71	33.63	30.81	57.08	47.08	-23.45	-16.27
5	15.02344	10.79	28.77	21.24	39.56	32.03	60.00	50.00	-20.44	-17.97
6	16.26953	10.85	24.27	16.29	35.12	27.14	60.00	50.00	-24.88	-22.86

REMARKS:

1. Q.P. and AV. are abbreviations of quasi-peak and average individually.
2. The emission levels of other frequencies were very low against the limit.
3. Margin value = Emission level - Limit value
4. Correction factor = Insertion loss + Cable loss
5. Emission Level = Correction Factor + Reading Value.

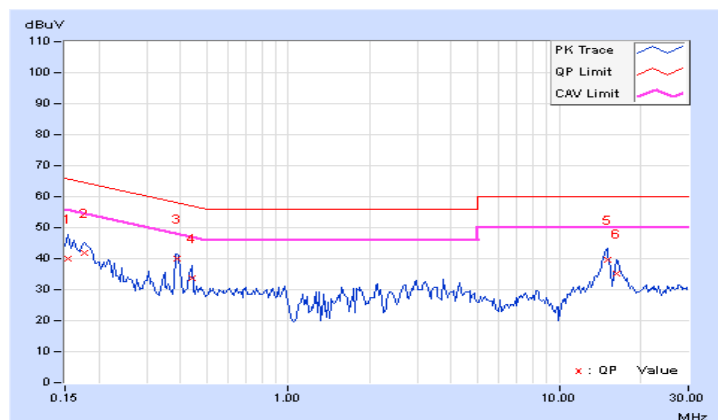

4.2.9 Test Results (Mode 3)

Phase	Line (L)	Detector Function	Quasi-Peak (QP) / Average (AV)
-------	----------	-------------------	--------------------------------

No	Freq. [MHz]	Corr. Factor	Reading Value [dB (uV)]		Emission Level [dB (uV)]		Limit [dB (uV)]		Margin (dB)	
		(dB)	Q.P.	AV.	Q.P.	AV.	Q.P.	AV.	Q.P.	AV.
	1	0.15391	10.07	27.82	16.10	37.89	26.17	65.79	55.79	-27.90
2	0.26328	10.08	27.68	21.51	37.76	31.59	61.33	51.33	-23.57	-19.74
3	0.34141	10.10	33.83	28.10	43.93	38.20	59.17	49.17	-15.24	-10.97
4	0.37656	10.10	33.22	27.19	43.32	37.29	58.35	48.35	-15.03	-11.06
5	7.03516	10.46	32.30	19.27	42.76	29.73	60.00	50.00	-17.24	-20.27
6	9.74219	10.60	35.56	23.70	46.16	34.30	60.00	50.00	-13.84	-15.70

REMARKS:

1. Q.P. and AV. are abbreviations of quasi-peak and average individually.
2. The emission levels of other frequencies were very low against the limit.
3. Margin value = Emission level - Limit value
4. Correction factor = Insertion loss + Cable loss
5. Emission Level = Correction Factor + Reading Value.

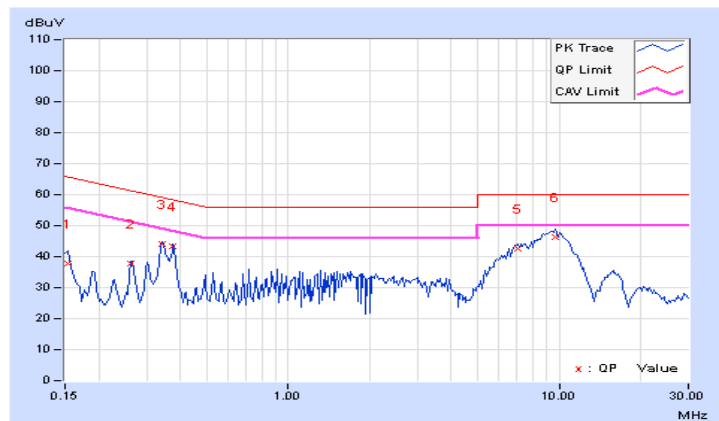

Phase	Neutral (N)	Detector Function	Quasi-Peak (QP) / Average (AV)
-------	-------------	-------------------	--------------------------------

No	Freq. [MHz]	Corr.	Reading Value		Emission Level		Limit		Margin	
		Factor (dB)	[dB (uV)]		[dB (uV)]		[dB (uV)]		(dB)	
			Q.P.	AV.	Q.P.	AV.	Q.P.	AV.	Q.P.	AV.
1	0.15781	10.06	22.35	10.82	32.41	20.88	65.58	55.58	-33.17	-34.70
2	0.26328	10.05	28.00	21.61	38.05	31.66	61.33	51.33	-23.28	-19.67
3	0.34141	10.08	33.83	28.20	43.91	38.28	59.17	49.17	-15.26	-10.89
4	0.37656	10.09	33.10	26.93	43.19	37.02	58.35	48.35	-15.16	-11.33
5	7.18359	10.40	32.47	16.94	42.87	27.34	60.00	50.00	-17.13	-22.66
6	9.80078	10.54	35.76	21.23	46.30	31.77	60.00	50.00	-13.70	-18.23

REMARKS:

1. Q.P. and AV. are abbreviations of quasi-peak and average individually.
2. The emission levels of other frequencies were very low against the limit.
3. Margin value = Emission level - Limit value
4. Correction factor = Insertion loss + Cable loss
5. Emission Level = Correction Factor + Reading Value.

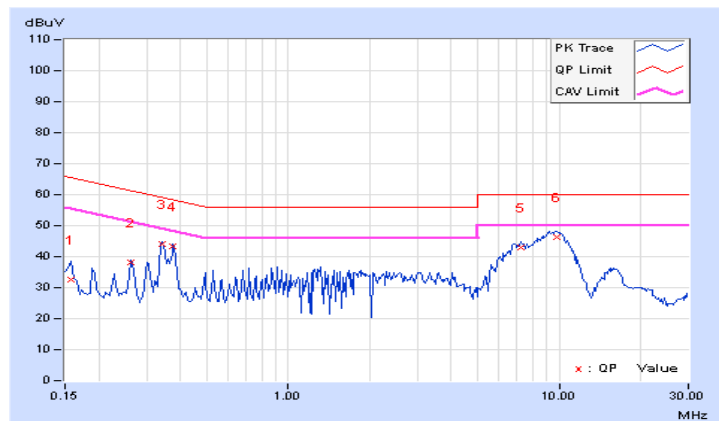

4.3 Transmit Power Measurement

4.3.1 Limits of Transmit Power Measurement

Operation Band	EUT Category		Limit
U-NII-1		Outdoor Access Point	1 Watt (30 dBm) (Max. e.i.r.p \leq 125mW(21 dBm) at any elevation angle above 30 degrees as measured from the horizon)
		Fixed point-to-point Access Point	1 Watt (30 dBm)
	√	Indoor Access Point	1 Watt (30 dBm)
	√	Client device	250mW (24 dBm)
U-NII-2A			250mW (24 dBm) or 11 dBm+10 log B*
U-NII-2C			250mW (24 dBm) or 11 dBm+10 log B*
U-NII-3	√		1 Watt (30 dBm)

*B is the 26 dB emission bandwidth in megahertz

Per KDB 662911 Method of conducted output power measurement on IEEE 802.11 devices,

Array Gain = 0 dB (i.e., no array gain) for $N_{ANT} \leq 4$;

Array Gain = 0 dB (i.e., no array gain) for channel widths ≥ 40 MHz for any N_{ANT} ;

Array Gain = $5 \log(N_{ANT}/N_{SS})$ dB or 3 dB, whichever is less for 20-MHz channel widths with $N_{ANT} \geq 5$.

For power measurements on all other devices: Array Gain = $10 \log(N_{ANT}/N_{SS})$ dB.

4.3.2 Test Setup

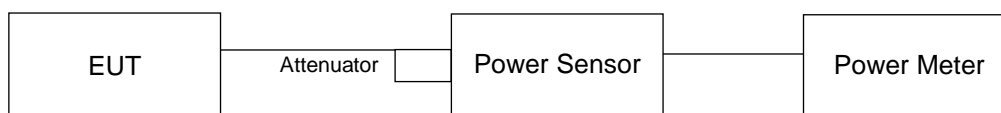

4.3.3 Test Instruments

Refer to section 4.1.2 to get information of above instrument.

4.3.4 Test Procedure

Method PM is used to perform output power measurement, trigger and gating function of wide band power meter is enabled to measure max output power of TX on burst. Duty factor is not added to measured value.

4.3.5 Deviation from Test Standard

No deviation.

4.3.6 EUT Operating Condition

The software provided by client to enable the EUT under transmission condition continuously at lowest, middle and highest channel frequencies individually.

4.3.7 Test Result

Master
CDD Mode
802.11a

Chan.	Chan. Freq. (MHz)	Maximum Conducted Power (dBm)				Total Power (mW)	Total Power (dBm)	Limit (dBm)	Pass / Fail
		Chain 0	Chain 1	Chain 2	Chain 3				
36	5180	19.86	19.96	20.27	20.76	421.449	26.25	30.00	Pass
40	5200	19.94	20.07	20.25	20.77	425.577	26.29	30.00	Pass
48	5240	19.94	19.88	20.29	20.61	417.888	26.21	30.00	Pass
149	5745	23.91	23.98	23.47	23.95	966.716	29.85	30.00	Pass
157	5785	24.02	24.03	23.67	24.09	994.535	29.98	30.00	Pass
165	5825	23.87	23.89	23.41	23.87	951.748	29.79	30.00	Pass

802.11ac (VHT20)

Chan.	Chan. Freq. (MHz)	Maximum Conducted Power (dBm)				Total Power (mW)	Total Power (dBm)	Limit (dBm)	Pass / Fail
		Chain 0	Chain 1	Chain 2	Chain 3				
36	5180	19.82	19.92	20.19	20.73	416.891	26.20	30.00	Pass
40	5200	19.82	20.01	20.23	20.63	417.221	26.20	30.00	Pass
48	5240	19.74	19.90	20.22	20.52	409.829	26.13	30.00	Pass
149	5745	23.85	23.87	23.34	23.85	944.877	29.75	30.00	Pass
157	5785	23.99	24.01	23.62	23.84	974.626	29.89	30.00	Pass
165	5825	23.79	23.80	23.21	23.79	927.958	29.68	30.00	Pass

802.11ac (VHT40)

Chan.	Chan. Freq. (MHz)	Maximum Conducted Power (dBm)				Total Power (mW)	Total Power (dBm)	Limit (dBm)	Pass / Fail
		Chain 0	Chain 1	Chain 2	Chain 3				
38	5190	20.31	20.42	20.71	21.19	466.836	26.69	30.00	Pass
46	5230	22.91	22.86	22.88	23.57	810.23	29.09	30.00	Pass
151	5755	23.81	23.82	23.29	23.77	932.963	29.70	30.00	Pass
159	5795	23.95	23.94	23.48	23.77	957.131	29.81	30.00	Pass

802.11ac (VHT80)

Chan.	Chan. Freq. (MHz)	Maximum Conducted Power (dBm)				Total Power (mW)	Total Power (dBm)	Limit (dBm)	Pass / Fail
		Chain 0	Chain 1	Chain 2	Chain 3				
42	5210	18.52	18.84	19.04	19.36	314.147	24.97	30.00	Pass
155	5775	19.44	20.04	19.64	20.47	392.301	25.94	30.00	Pass

802.11ac (VHT80+80)

Chan.	Chan. Freq. (MHz)	Maximum Conducted Power (dBm)				Total Power (mW)	Total Power (dBm)	Limit (dBm)	Pass / Fail
		Chain 0	Chain 1	Chain 2	Chain 3				
42 +155	5210	19.68	19.62	-	-	184.519	22.66	30.00	Pass
	5775	-	-	19.77	21.39	232.563	23.67	30.00	Pass

Client
CDD Mode
802.11a

Chan.	Chan. Freq. (MHz)	Maximum Conducted Power (dBm)				Total Power (mW)	Total Power (dBm)	Limit (dBm)	Pass / Fail
		Chain 0	Chain 1	Chain 2	Chain 3				
36	5180	13.72	13.94	14.19	14.74	104.351	20.18	24.00	Pass
40	5200	13.83	13.87	14.21	14.68	104.272	20.18	24.00	Pass
48	5240	13.89	13.86	14.23	14.56	103.874	20.17	24.00	Pass
149	5745	23.91	23.98	23.47	23.95	966.716	29.85	30.00	Pass
157	5785	24.02	24.03	23.67	24.09	994.535	29.98	30.00	Pass
165	5825	23.87	23.89	23.41	23.87	951.748	29.79	30.00	Pass

802.11ac (VHT20)

Chan.	Chan. Freq. (MHz)	Maximum Conducted Power (dBm)				Total Power (mW)	Total Power (dBm)	Limit (dBm)	Pass / Fail
		Chain 0	Chain 1	Chain 2	Chain 3				
36	5180	13.81	13.87	14.15	14.66	103.666	20.16	24.00	Pass
40	5200	13.79	13.98	14.19	14.56	103.754	20.16	24.00	Pass
48	5240	13.68	13.90	14.15	14.49	102.003	20.09	24.00	Pass
149	5745	23.85	23.87	23.34	23.85	944.877	29.75	30.00	Pass
157	5785	23.99	24.01	23.62	23.84	974.626	29.89	30.00	Pass
165	5825	23.79	23.80	23.21	23.79	927.958	29.68	30.00	Pass

802.11ac (VHT40)

Chan.	Chan. Freq. (MHz)	Maximum Conducted Power (dBm)				Total Power (mW)	Total Power (dBm)	Limit (dBm)	Pass / Fail
		Chain 0	Chain 1	Chain 2	Chain 3				
38	5190	17.01	17.06	17.24	17.55	210.901	23.24	24.00	Pass
46	5230	17.02	16.96	16.93	17.56	206.342	23.15	24.00	Pass
151	5755	23.81	23.82	23.29	23.77	932.963	29.70	30.00	Pass
159	5795	23.95	23.94	23.48	23.77	957.131	29.81	30.00	Pass

802.11ac (VHT80)

Chan.	Chan. Freq. (MHz)	Maximum Conducted Power (dBm)				Total Power (mW)	Total Power (dBm)	Limit (dBm)	Pass / Fail
		Chain 0	Chain 1	Chain 2	Chain 3				
42	5210	17.53	17.82	17.98	18.12	244.827	23.89	24.00	Pass
155	5775	19.44	20.04	19.64	20.47	392.301	25.94	30.00	Pass

802.11ac (VHT80+80)

Chan.	Chan. Freq. (MHz)	Maximum Conducted Power (dBm)				Total Power (mW)	Total Power (dBm)	Limit (dBm)	Pass / Fail
		Chain 0	Chain 1	Chain 2	Chain 3				
42 +155	5210	19.68	19.62	-	-	184.519	22.66	24.00	Pass
	5775	-	-	19.77	21.39	232.563	23.67	30.00	Pass

Master
Beamforming Mode
802.11ac (VHT20)

Chan.	Chan. Freq. (MHz)	Maximum Conducted Power (dBm)				Total Power (mW)	Total Power (dBm)	Limit (dBm)	Pass / Fail
		Chain 0	Chain 1	Chain 2	Chain 3				
36	5180	19.82	19.92	20.19	20.73	416.891	26.20	26.38	Pass
40	5200	19.82	20.01	20.23	20.63	417.221	26.20	26.38	Pass
48	5240	19.74	19.90	20.22	20.52	409.829	26.13	26.38	Pass
149	5745	20.29	20.24	19.81	20.29	415.211	26.18	26.38	Pass
157	5785	20.37	20.46	20.04	20.28	427.651	26.31	26.38	Pass
165	5825	20.26	20.28	19.69	20.26	412.111	26.15	26.38	Pass

Note: 1. Directional gain = $3.6\text{dBi} + 10\log(4) = 9.62\text{dBi} > 6\text{dBi}$, so the power limit shall be reduced to $30-(9.62-6) = 26.38\text{dBm}$

802.11ac (VHT40)

Chan.	Chan. Freq. (MHz)	Maximum Conducted Power (dBm)				Total Power (mW)	Total Power (dBm)	Limit (dBm)	Pass / Fail
		Chain 0	Chain 1	Chain 2	Chain 3				
38	5190	19.76	19.84	20.12	20.54	407.049	26.10	26.38	Pass
46	5230	19.89	19.84	19.87	20.56	404.696	26.07	26.38	Pass
151	5755	20.29	20.31	19.80	20.19	414.275	26.17	26.38	Pass
159	5795	20.42	20.38	19.86	20.18	420.358	26.24	26.38	Pass

Note: 1. Directional gain = $3.6\text{dBi} + 10\log(4) = 9.62\text{dBi} > 6\text{dBi}$, so the power limit shall be reduced to $30-(9.62-6) = 26.38\text{dBm}$

802.11ac (VHT80)

Chan.	Chan. Freq. (MHz)	Maximum Conducted Power (dBm)				Total Power (mW)	Total Power (dBm)	Limit (dBm)	Pass / Fail
		Chain 0	Chain 1	Chain 2	Chain 3				
42	5210	18.52	18.84	19.04	19.36	314.147	24.97	26.38	Pass
155	5775	19.44	20.04	19.64	20.47	392.301	25.94	26.38	Pass

Note: 1. Directional gain = $3.6\text{dBi} + 10\log(4) = 9.62\text{dBi} > 6\text{dBi}$, so the power limit shall be reduced to $30-(9.62-6) = 26.38\text{dBm}$

802.11ac (VHT80+80)

Chan.	Chan. Freq. (MHz)	Maximum Conducted Power (dBm)				Total Power (mW)	Total Power (dBm)	Limit (dBm)	Pass / Fail
		Chain 0	Chain 1	Chain 2	Chain 3				
42+155	5210	19.68	19.62	-	-	184.519	22.66	29.39	Pass
	5775	-	-	19.77	21.39	232.563	23.67	29.39	Pass

- Note:**
1. For UNII-1: Directional gain = $3.6\text{dBi} + 10\log(2) = 6.61\text{dBi} > 6\text{dBi}$, so the power limit shall be reduced to $30 - (6.61 - 6) = 29.39\text{dBm}$.
 2. For UNII-3: Directional gain = $3.6\text{dBi} + 10\log(2) = 6.61\text{dBi} > 6\text{dBi}$, so the power limit shall be reduced to $30 - (6.61 - 6) = 29.39\text{dBm}$.

Client Mode
Beamforming Mode

802.11ac (VHT20)

Chan.	Chan. Freq. (MHz)	Maximum Conducted Power (dBm)				Total Power (mW)	Total Power (dBm)	Limit (dBm)	Pass / Fail
		Chain 0	Chain 1	Chain 2	Chain 3				
36	5180	13.81	13.87	14.15	14.66	103.666	20.16	20.38	Pass
40	5200	13.79	13.98	14.19	14.56	103.754	20.16	20.38	Pass
48	5240	13.68	13.90	14.15	14.49	102.003	20.09	20.38	Pass
149	5745	20.29	20.24	19.81	20.29	415.211	26.18	26.38	Pass
157	5785	20.37	20.46	20.04	20.28	427.651	26.31	26.38	Pass
165	5825	20.26	20.28	19.69	20.26	412.111	26.15	26.38	Pass

Note: 1. For UNII-1: Directional gain = $3.6\text{dBi} + 10\log(4) = 9.62\text{dBi} > 6\text{dBi}$, so the power limit shall be reduced to $24 - (9.62 - 6) = 20.38\text{dBm}$
 2 For UNII-3: Directional gain = $3.6\text{dBi} + 10\log(4) = 9.62\text{dBi} > 6\text{dBi}$, so the power limit shall be reduced to $30 - (9.62 - 6) = 26.38\text{dBm}$

802.11ac (VHT40)

Chan.	Chan. Freq. (MHz)	Maximum Conducted Power (dBm)				Total Power (mW)	Total Power (dBm)	Limit (dBm)	Pass / Fail
		Chain 0	Chain 1	Chain 2	Chain 3				
38	5190	14.09	14.11	14.26	14.54	106.522	20.27	20.38	Pass
46	5230	14.11	14.01	14.02	14.55	104.685	20.20	20.38	Pass
151	5755	20.29	20.31	19.80	20.19	414.275	26.17	26.38	Pass
159	5795	20.42	20.38	19.86	20.18	420.358	26.24	26.38	Pass

Note: 1. For UNII-1: Directional gain = $3.6\text{dBi} + 10\log(4) = 9.62\text{dBi} > 6\text{dBi}$, so the power limit shall be reduced to $24 - (9.62 - 6) = 20.38\text{dBm}$
 2 For UNII-3: Directional gain = $3.6\text{dBi} + 10\log(4) = 9.62\text{dBi} > 6\text{dBi}$, so the power limit shall be reduced to $30 - (9.62 - 6) = 26.38\text{dBm}$

802.11ac (VHT80)

Chan.	Chan. Freq. (MHz)	Maximum Conducted Power (dBm)				Total Power (mW)	Total Power (dBm)	Limit (dBm)	Pass / Fail
		Chain 0	Chain 1	Chain 2	Chain 3				
42	5210	13.13	14.32	14.48	14.51	103.902	20.17	20.38	Pass
155	5775	19.44	20.04	19.64	20.47	392.301	25.94	26.38	Pass

Note: 1. For UNII-1: Directional gain = $3.6\text{dBi} + 10\log(4) = 9.62\text{dBi} > 6\text{dBi}$, so the power limit shall be reduced to $24 - (9.62 - 6) = 20.38\text{dBm}$
 2 For UNII-3: Directional gain = $3.6\text{dBi} + 10\log(4) = 9.62\text{dBi} > 6\text{dBi}$, so the power limit shall be reduced to $30 - (9.62 - 6) = 26.38\text{dBm}$

802.11ac (VHT80+80)

Chan.	Chan. Freq. (MHz)	Maximum Conducted Power (dBm)				Total Power (mW)	Total Power (dBm)	Limit (dBm)	Pass / Fail
		Chain 0	Chain 1	Chain 2	Chain 3				
42+155	5210	13.19	13.15	-	-	41.499	16.18	23.39	Pass
	5775	-	-	19.77	21.39	232.563	23.67	29.39	Pass

- Note:** 1. For UNII-1: Directional gain = $3.6\text{dBi} + 10\log(2) = 6.61\text{dBi} > 6\text{dBi}$, so the power limit shall be reduced to $30 - (6.61 - 6) = 29.39\text{dBm}$.
2. For UNII-3: Directional gain = $3.6\text{dBi} + 10\log(2) = 6.61\text{dBi} > 6\text{dBi}$, so the power limit shall be reduced to $30 - (6.61 - 6) = 29.39\text{dBm}$.

4.4 Occupied Bandwidth Measurement

4.4.1 Test Setup

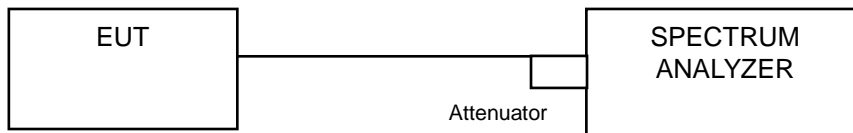

4.4.2 Test Instruments

Refer to section 4.1.2 to get information of above instrument.

4.4.3 Test Procedure

The transmitter output was connected to the spectrum analyzer through an attenuator. The bandwidth of the fundamental frequency was measured by spectrum analyzer with resolution bandwidth in the range of 1% to 5% of the anticipated emission bandwidth, and a video bandwidth at least 3x the resolution bandwidth and set the detector to SAMPLE. The width of a frequency band such that, below the lower and above the upper frequency limits, the mean powers emitted are each equal to a specified percentage 0.5 %of the total mean power of a given emission.

4.4.4 Test Results

Master Mode

802.11a

Channel	Channel Frequency (MHz)	Occupied Bandwidth (MHz)			
		Chain 0	Chain 1	Chain 2	Chain 3
36	5180	16.44	16.56	16.56	16.56
40	5200	16.56	16.68	16.56	16.56
48	5240	16.44	16.44	16.56	16.44
149	5745	16.68	16.44	16.44	16.44
157	5785	16.56	16.56	16.56	16.56
165	5825	16.56	16.56	16.56	16.56

802.11ac (VHT20)

Channel	Channel Frequency (MHz)	Occupied Bandwidth (MHz)			
		Chain 0	Chain 1	Chain 2	Chain 3
36	5180	17.64	17.76	17.64	17.76
40	5200	17.76	17.64	17.64	17.64
48	5240	17.64	17.76	17.64	17.76
149	5745	17.76	17.64	17.64	17.64
157	5785	17.76	17.76	17.76	17.76
165	5825	17.76	17.76	17.76	17.76

802.11ac (VHT40)

Channel	Channel Frequency (MHz)	Occupied Bandwidth (MHz)			
		Chain 0	Chain 1	Chain 2	Chain 3
38	5190	36.24	36.24	36.24	36.24
46	5230	36.24	36.24	36.24	36.24
151	5755	36.24	36.24	36.24	36.48
159	5795	36.48	36.48	36.24	36.48

802.11ac (VHT80)

Channel	Channel Frequency (MHz)	Occupied Bandwidth (MHz)			
		Chain 0	Chain 1	Chain 2	Chain 3
42	5210	76.32	76.32	76.32	76.32
155	5775	75.84	75.84	75.84	76.32

802.11ac (VHT80+80)

Channel	Channel Frequency (MHz)	Occupied Bandwidth (MHz)			
		Chain 0	Chain 1	Chain 2	Chain 3
42+155	5210	75.84	76.32	-	-
	5775	-	-	75.84	75.84

Spectrum Plot of Worst Value

802.11a / Chain 0 : CH149

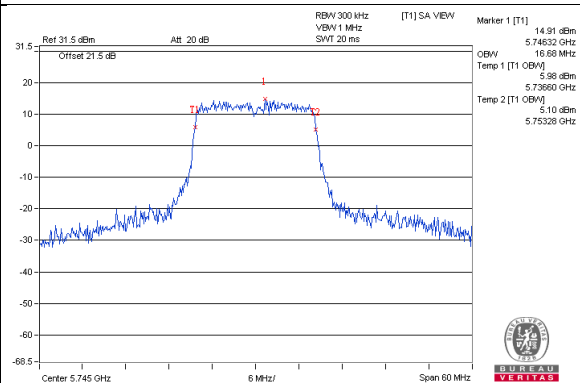

802.11ac (VHT20) / Chain 0 : CH40

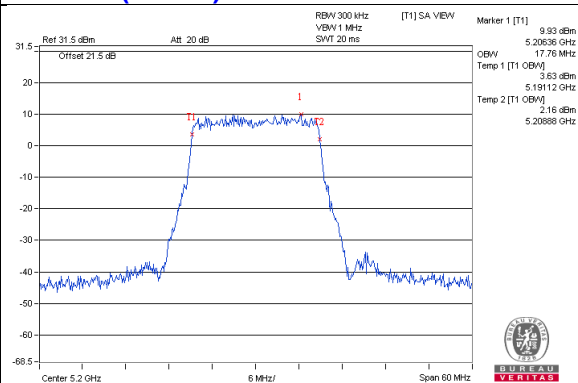

802.11ac (VHT40) / Chain 0: CH159

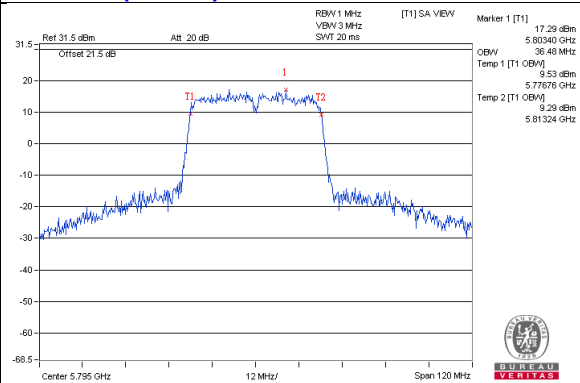

802.11ac (VHT80) / Chain 0 : CH42

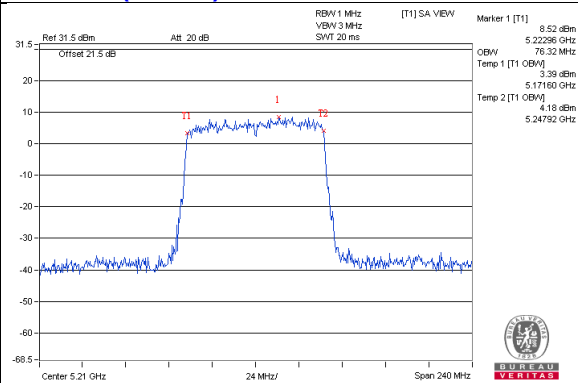

802.11ac (VHT80+80) / Chain 1: CH42

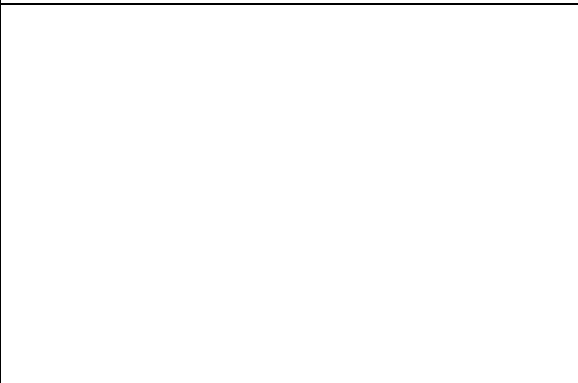
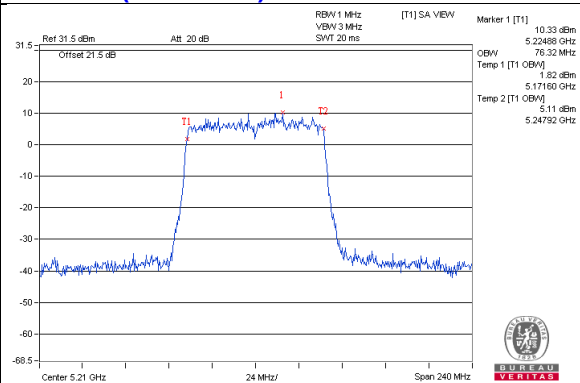

Client Mode
802.11a

Channel	Channel Frequency (MHz)	Occupied Bandwidth (MHz)			
		Chain 0	Chain 1	Chain 2	Chain 3
36	5180	16.44	16.68	16.56	16.44
40	5200	16.44	16.44	16.44	16.56
48	5240	16.44	16.44	16.44	16.44
149	5745	16.68	16.44	16.44	16.44
157	5785	16.56	16.56	16.56	16.56
165	5825	16.56	16.56	16.56	16.56

802.11ac (VHT20)

Channel	Channel Frequency (MHz)	Occupied Bandwidth (MHz)			
		Chain 0	Chain 1	Chain 2	Chain 3
36	5180	17.64	17.64	17.64	17.64
40	5200	17.64	17.64	17.64	17.64
48	5240	17.64	17.64	17.64	17.76
149	5745	17.76	17.64	17.64	17.64
157	5785	17.76	17.76	17.76	17.76
165	5825	17.76	17.76	17.76	17.76

802.11ac (VHT40)

Channel	Channel Frequency (MHz)	Occupied Bandwidth (MHz)			
		Chain 0	Chain 1	Chain 2	Chain 3
38	5190	36.24	36.24	36.24	36.24
46	5230	36.24	36.24	36.48	36.24
151	5755	36.24	36.24	36.24	36.48
159	5795	36.48	36.48	36.24	36.48

802.11ac (VHT80)

Channel	Channel Frequency (MHz)	Occupied Bandwidth (MHz)			
		Chain 0	Chain 1	Chain 2	Chain 3
42	5210	76.32	76.32	75.84	75.84
155	5775	75.84	75.84	75.84	76.32

802.11ac (VHT80+80)

Channel	Channel Frequency (MHz)	Occupied Bandwidth (MHz)			
		Chain 0	Chain 1	Chain 2	Chain 3
42+155	5210	75.84	76.32	-	-
	5775	-	-	75.84	75.84

Spectrum Plot of Worst Value

802.11a / Chain 0 : CH149

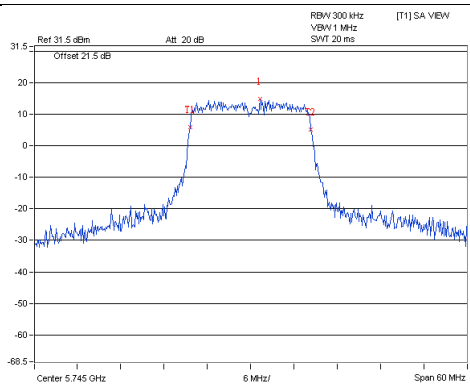

802.11a (VHT20) / Chain 0 : CH149

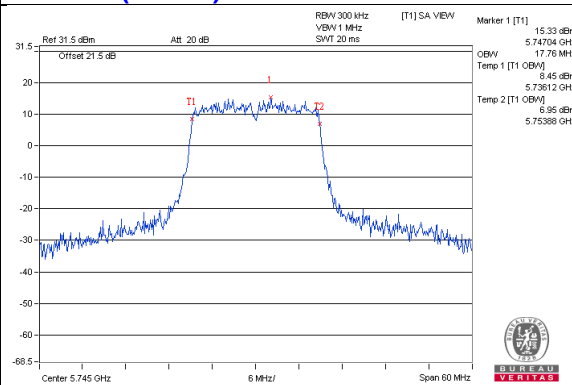

802.11ac (VHT40) / Chain 0: CH159

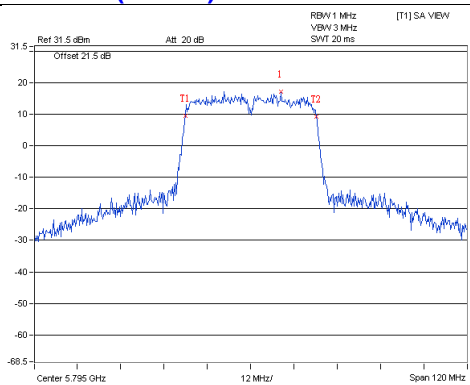

802.11ac (VHT80) / Chain 0 : CH42

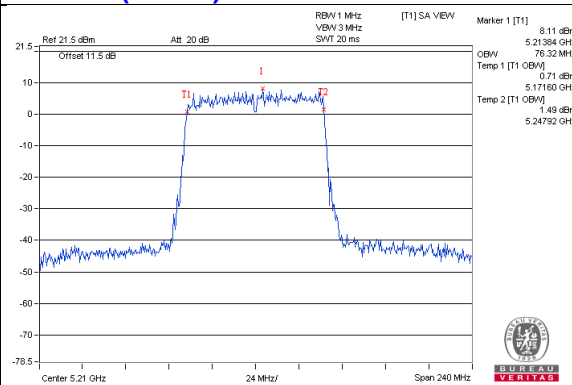

802.11ac (VHT80+80) / Chain 1: CH42

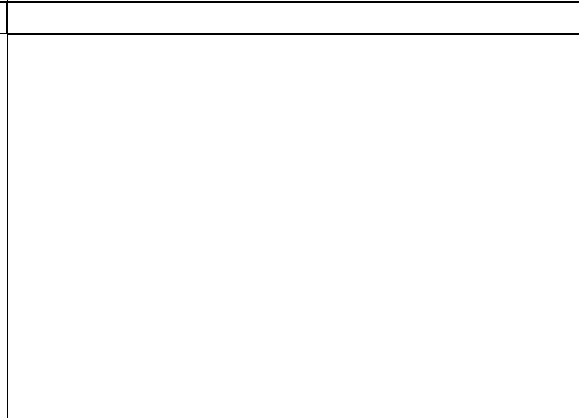
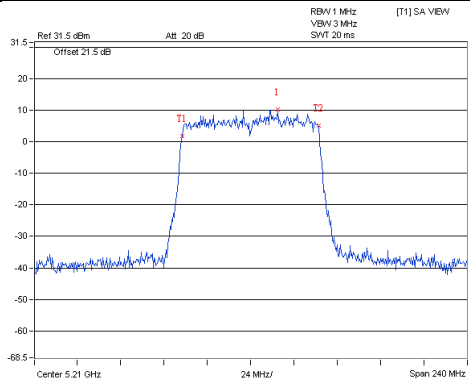

Spectrum Plot for near by DFS band (DFS is required, if 99% OCP straddle into U-NII-2A band)

802.11a / Chain 0 : CH48

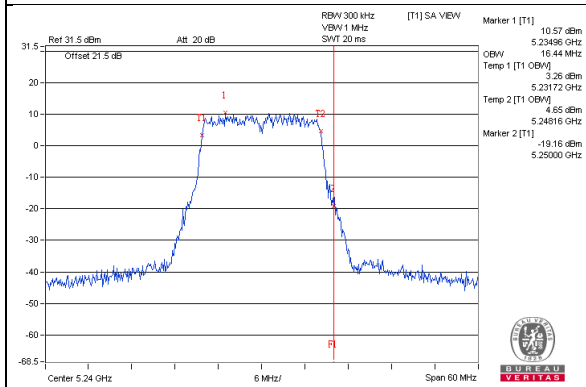

802.11a / Chain 1 : CH48

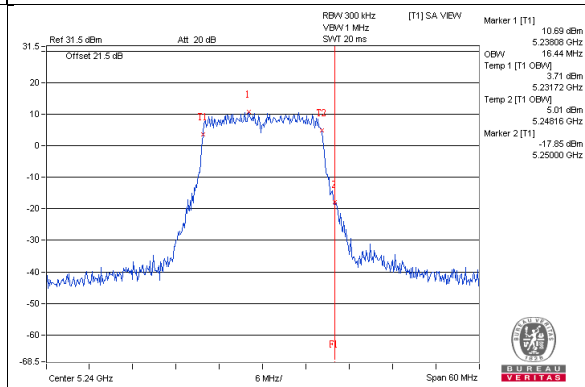

802.11a / Chain 2 : CH48

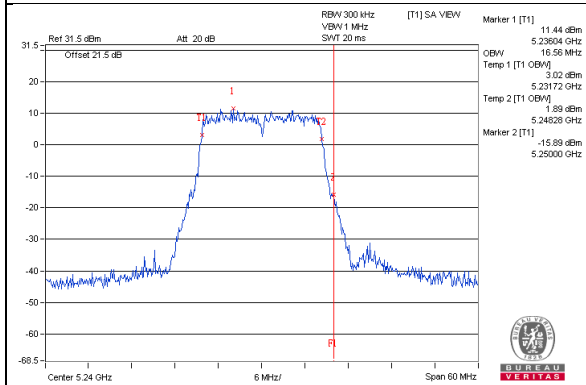

802.11a / Chain 3 : CH48

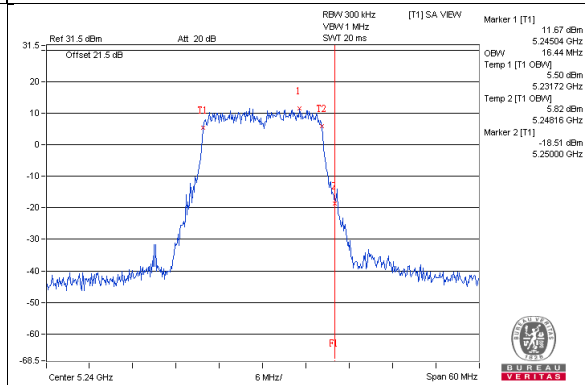

802.11ac (VHT20) / Chain 0 : CH48

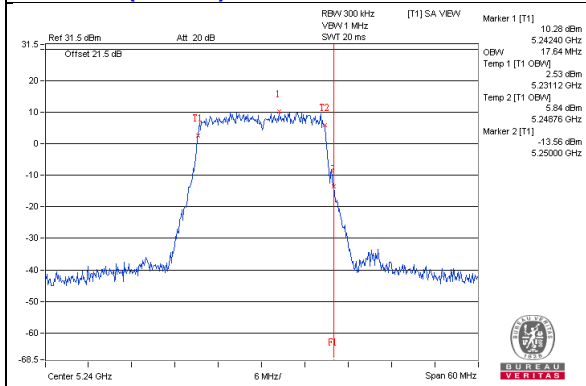

802.11ac (VHT20) / Chain 1 : CH48

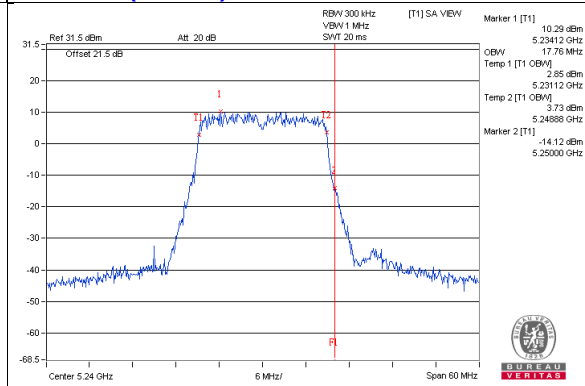

802.11ac (VHT20) / Chain 2 : CH48

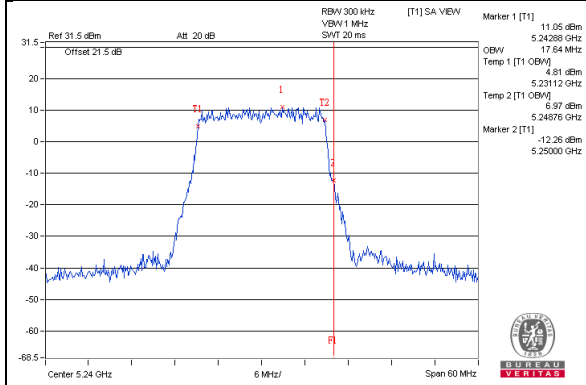

802.11ac (VHT20) / Chain 3 : CH48

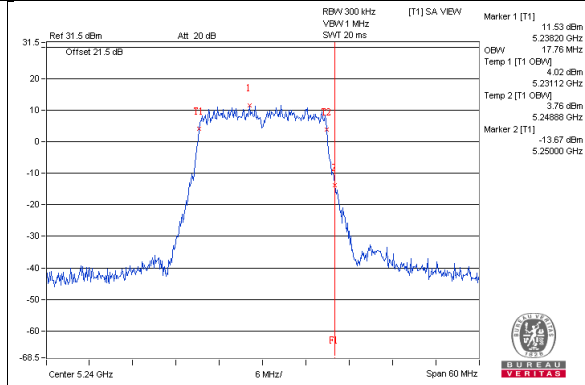

Spectrum Plot for near by DFS band (DFS is required, if 99% OCP straddle into U-NII-2A band)

802.11ac (VHT40) / Chain 0 : CH46

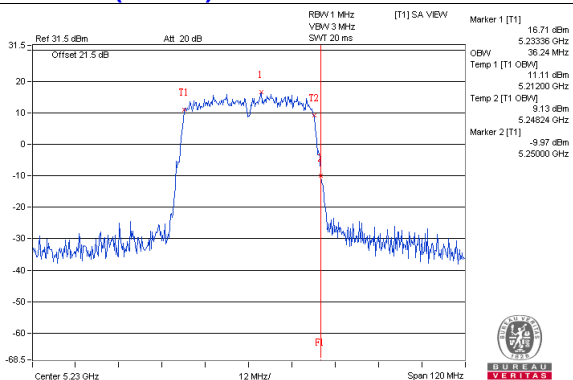

802.11ac (VHT40) / Chain 1 : CH46

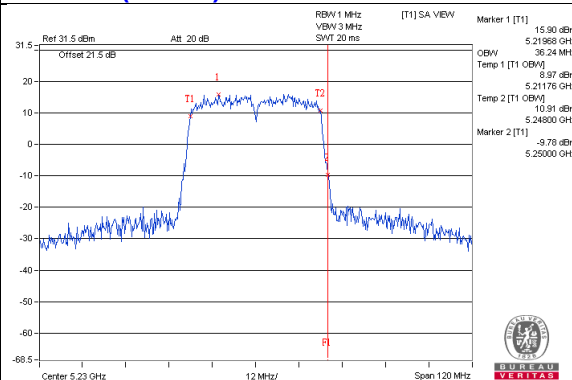

802.11ac (VHT40) / Chain 2 : CH46

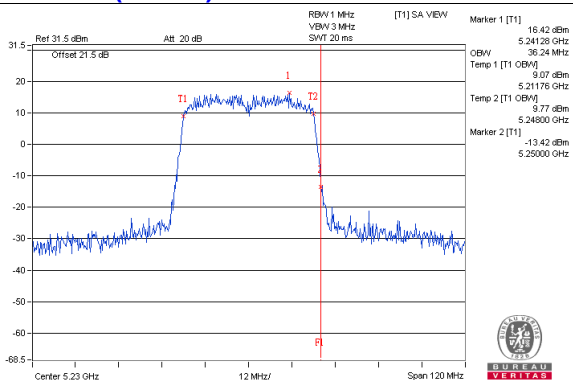

802.11ac (VHT40) / Chain 3 : CH46

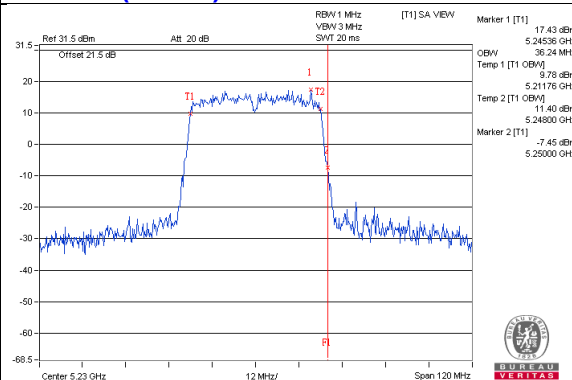

802.11ac (VHT80) / Chain 0 : CH42

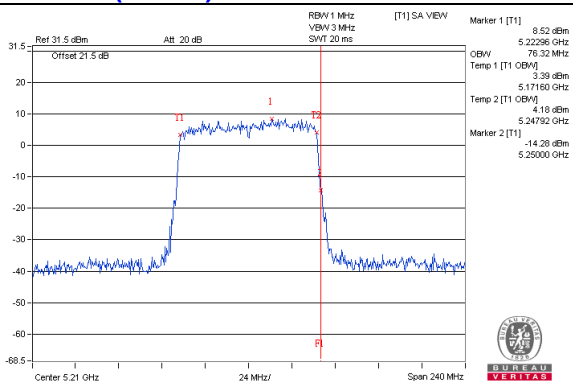

802.11ac (VHT80) / Chain 1 : CH42

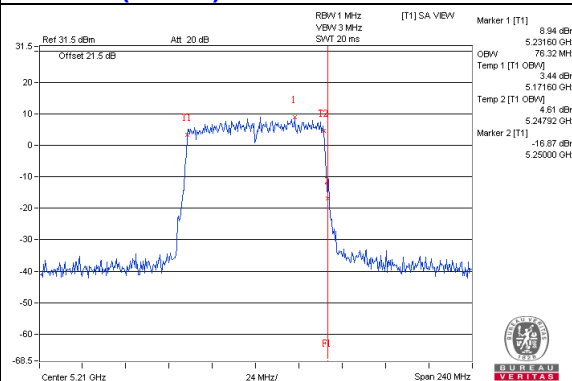

802.11ac (VHT80) / Chain 2 : CH42

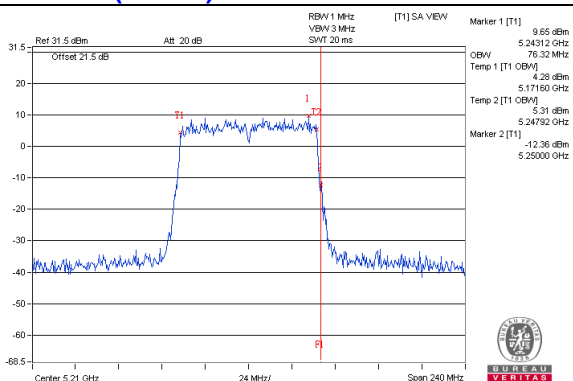

802.11ac (VHT80) / Chain 3 : CH42

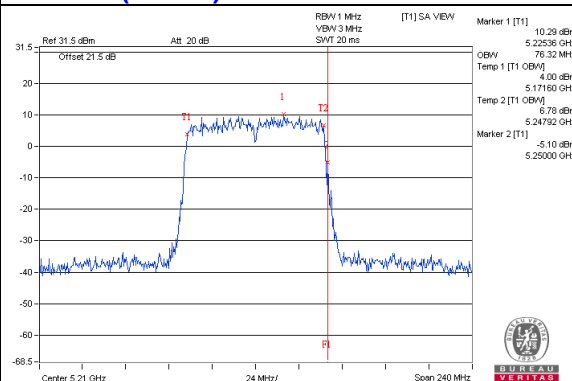

Spectrum Plot for near by DFS band (DFS is required, if 99% OCP straddle into U-NII-2A band)

802.11ac(VHT80+80) / Chain 0 : CH42

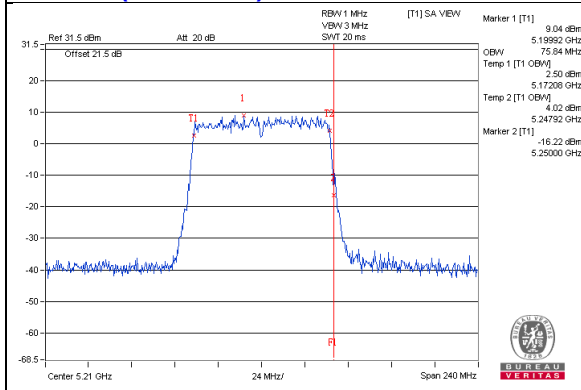

802.11ac(VHT80+80) / Chain 1 : CH42

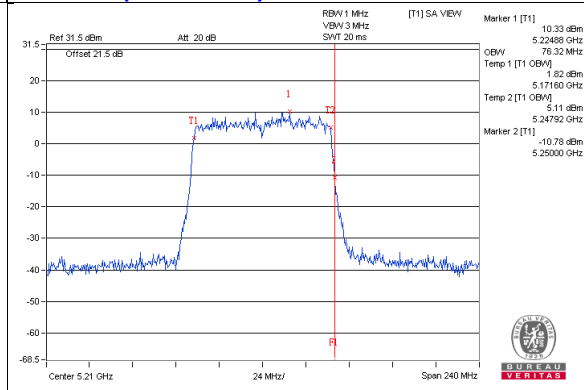

Spectrum Plot for near by DFS band (DFS is required, if 99% OCP straddle into U-NII-2C band)

802.11a / Chain 0 : CH149

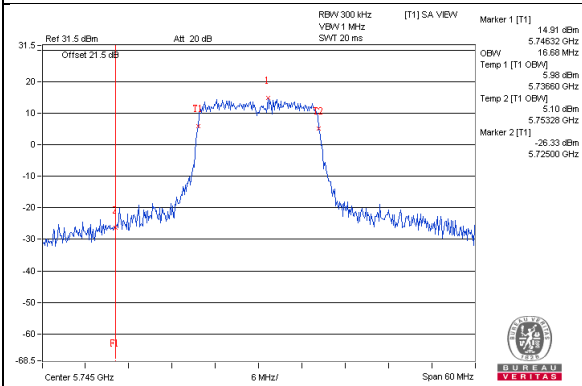

802.11a / Chain 1 : CH149

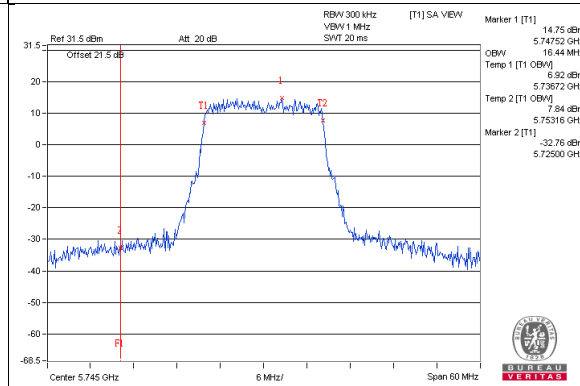

802.11a / Chain 2 : CH149

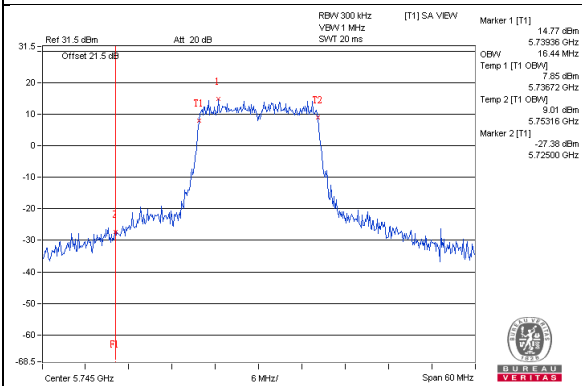

802.11a / Chain 3 : CH149

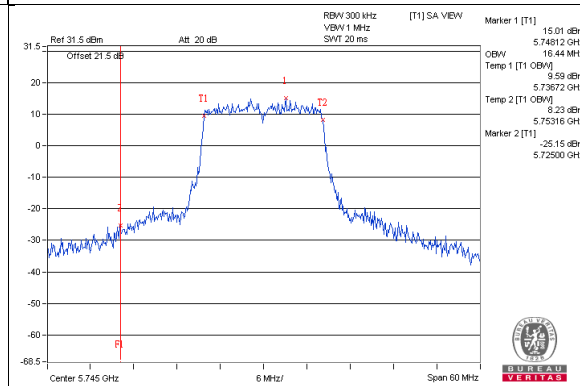

802.11ac (VHT20) / Chain 0 : CH149

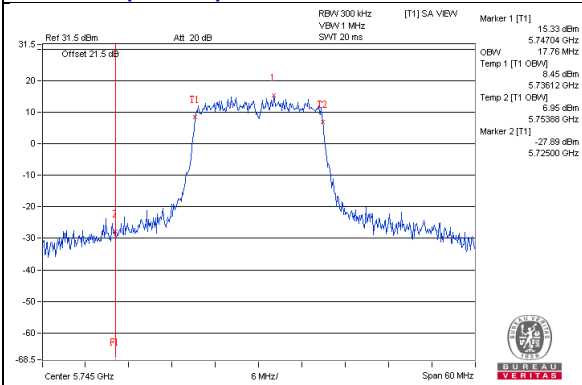

802.11ac (VHT20) / Chain 1 : CH149

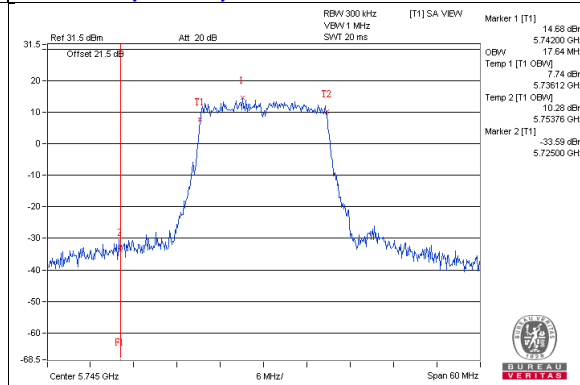

802.11ac (VHT20) / Chain 2 : CH149

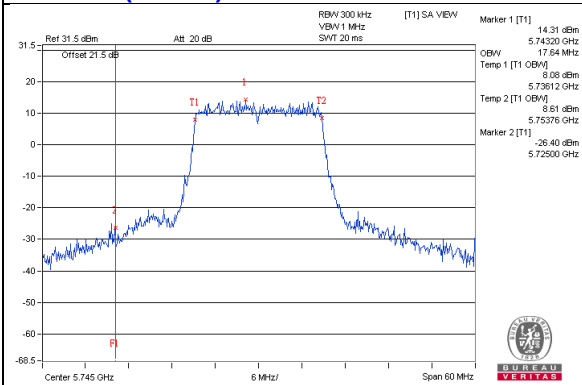

802.11ac (VHT20) / Chain 3 : CH149

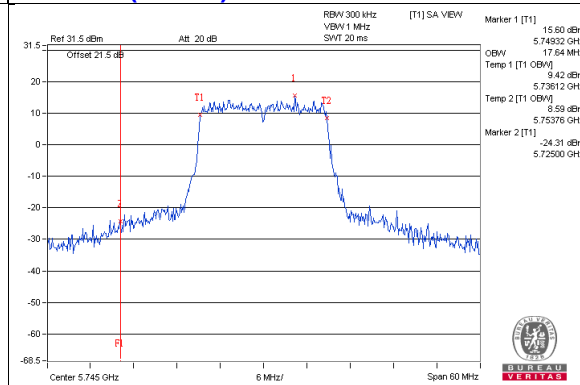

Spectrum Plot for near by DFS band (DFS is required, if 99% OCP straddle into U-NII-2C band)

802.11ac (VHT40) / Chain 0 : CH151

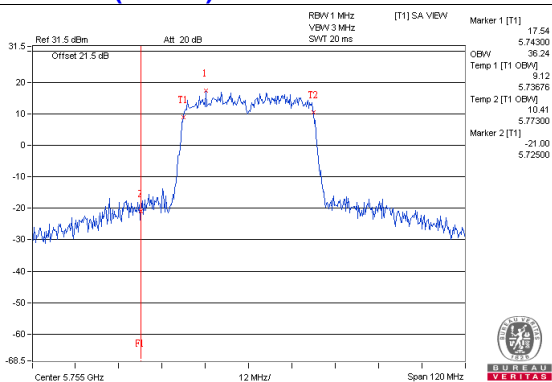

802.11ac (VHT40) / Chain 1 : CH151

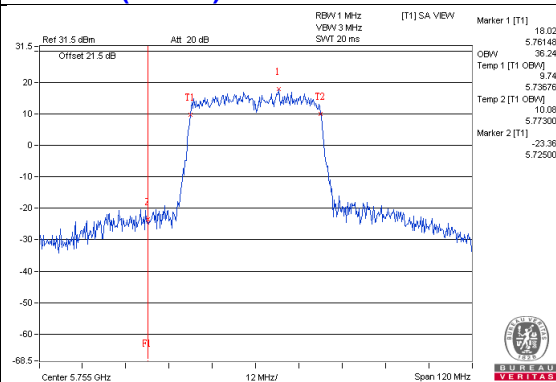

802.11ac (VHT40) / Chain 2 : CH151

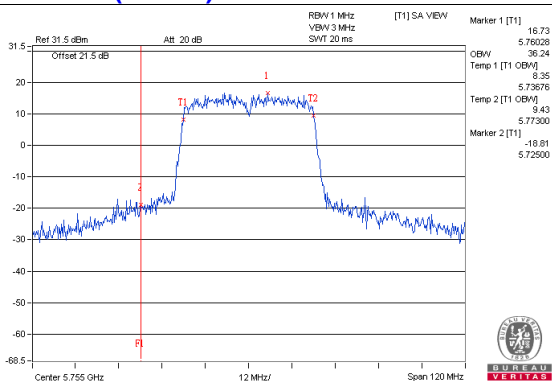

802.11ac (VHT40) / Chain 3 : CH151

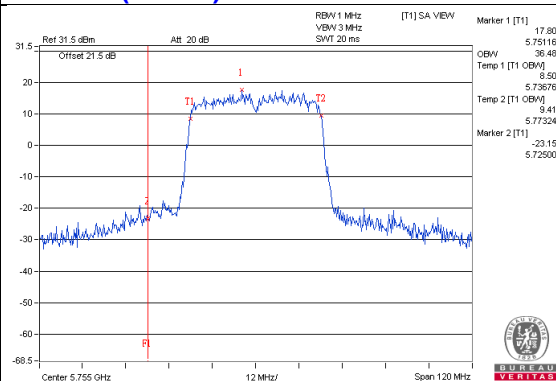

802.11ac (VHT80) / Chain 0 : CH155

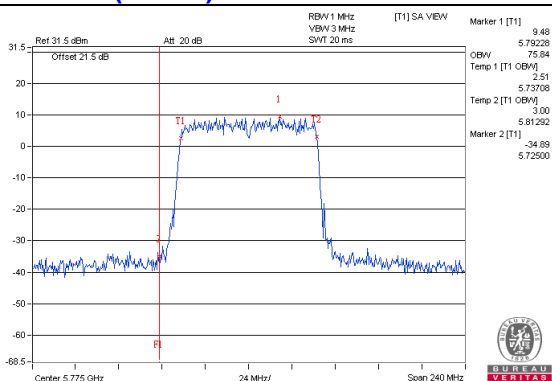

802.11ac (VHT80) / Chain 1 : CH155

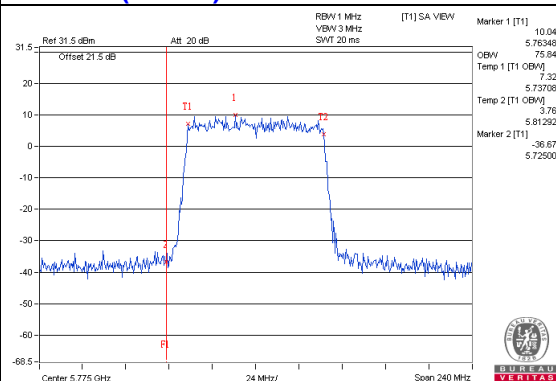

802.11ac (VHT80) / Chain 2 : CH155

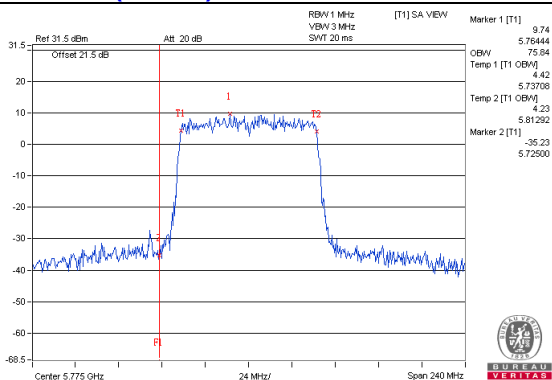

802.11ac (VHT80) / Chain 3 : CH155

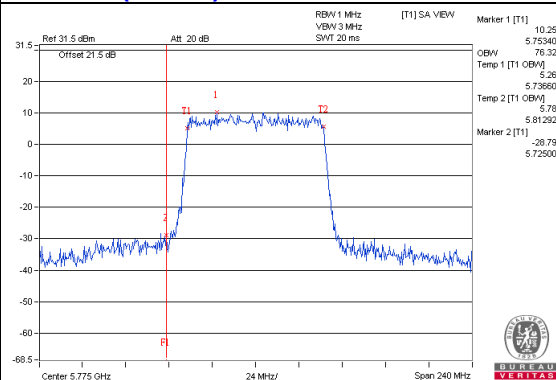

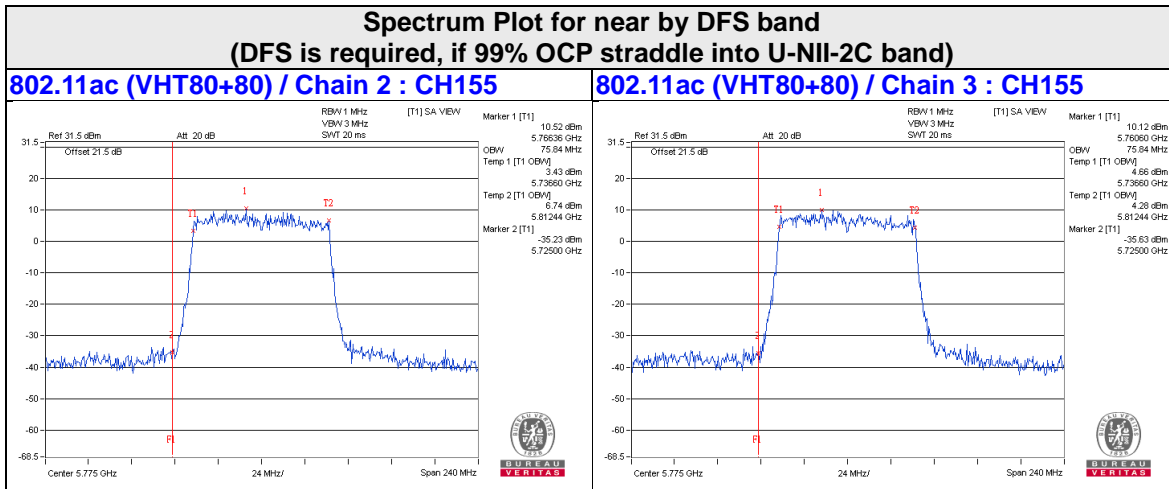

4.5 Peak Power Spectral Density Measurement

4.5.1 Limits of Peak Power Spectral Density Measurement

Operation Band	EUT Category		Limit
U-NII-1		Outdoor Access Point	17dBm/ MHz
		Fixed point-to-point Access Point	
	√	Indoor Access Point	11dBm/ MHz
	√	Client device	
U-NII-2A			11dBm/ MHz
U-NII-2C			11dBm/ MHz
U-NII-3	√		30dBm/ 500kHz

4.5.2 Test Setup

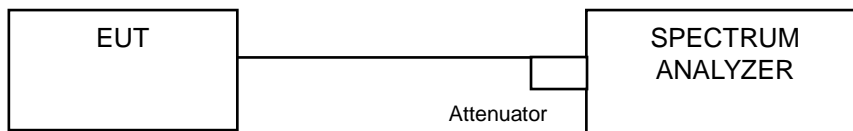

4.5.3 Test Instruments

Refer to section 4.1.2 to get information of above instrument.

4.5.4 Test Procedure

802.11ac (VHT20)

For U-NII-1:

Using method SA-1

1. Set span to encompass the entire emission bandwidth (EBW) of the signal.
2. Set RBW = 1 MHz, Set VBW \geq 3 MHz, Detector = RMS
3. Sweep time = auto, trigger set to "free run".
4. Trace average at least 100 traces in power averaging mode.
5. Record the max value

For U-NII-3:

1. Set span to encompass the entire emission bandwidth (EBW) of the signal.
2. Set RBW = 300 kHz, Set VBW \geq 1 MHz, Detector = RMS
3. Use the peak marker function to determine the maximum power level in any 300 kHz band segment within the fundamental EBW.
4. Scale the observed power level to an equivalent value in 500 kHz by adjusting (reducing) the measured power by a bandwidth correction factor (BWCF) where $BWCF = 10\log(500 \text{ kHz}/300\text{kHz})$
5. Sweep time = auto, trigger set to "free run".
6. Trace average at least 100 traces in power averaging mode.
7. Record the max value

802.11a, 802.11ac (VHT40), 802.11ac (VHT80), 802.11ac (VHT80+80)

For U-NII-1:

Using method SA-2

1. Set span to encompass the entire emission bandwidth (EBW) of the signal.
2. Set RBW = 1 MHz, Set VBW \geq 3 MHz, Detector = RMS
3. Sweep time = auto, trigger set to "free run".
4. Trace average at least 100 traces in power averaging mode.
5. Record the max value and add $10 \log (1/\text{duty cycle})$

For U-NII-3:

1. Set span to encompass the entire emission bandwidth (EBW) of the signal.
2. Set RBW = 300 kHz, Set VBW \geq 1 MHz, Detector = RMS
3. Use the peak marker function to determine the maximum power level in any 300 kHz band segment within the fundamental EBW.
4. Scale the observed power level to an equivalent value in 500 kHz by adjusting (reducing) the measured power by a bandwidth correction factor (BWCF) where $BWCF = 10\log(500 \text{ kHz}/300\text{kHz})$
5. Sweep time = auto, trigger set to "free run".
6. Trace average at least 100 traces in power averaging mode.
7. Record the max value and add $10 \log (1/\text{duty cycle})$

4.5.5 Deviation from Test Standard

No deviation.

4.5.6 EUT Operating Condition

Same as Item 4.3.6.

4.5.7 Test Results

Master Mode

For U-NII-1: 802.11a

Chan.	Chan. Freq. (MHz)	PSD W/O Duty Factor (dBm)				Duty Factor (dB)	Total PSD With Duty Factor (dBm)	MAX. Limit (dBm/MHz)	Pass / Fail
		Chain 0	Chain 1	Chain 2	Chain 3				
36	5180	5.57	6.29	6.45	6.96	0.18	12.54	13.38	Pass
40	5200	5.70	6.59	6.46	6.75	0.18	12.59	13.38	Pass
48	5240	6.24	6.23	6.39	6.87	0.18	12.64	13.38	Pass

- Note:**
- Method a) of power density measurement of KDB 662911 is using for calculating total power density. Total power density is summing entire spectra across corresponding frequency bins on the various outputs by computer.
 - Directional gain = $3.6\text{dBi} + 10\log(4) = 9.62\text{dBi} > 6\text{dBi}$, so the power density limit shall be reduced to $17 - (9.62 - 6) = 13.38\text{dBm}$.
 - Refer to section 3.3 for duty cycle spectrum plot.

802.11ac (VHT20)

Chan.	Chan. Freq. (MHz)	PSD (dBm/MHz)				Total Power Density (dBm/MHz)	MAX. Limit (dBm/MHz)	Pass / Fail
		Chain 0	Chain 1	Chain 2	Chain 3			
36	5180	5.79	6.03	6.48	6.56	12.25	13.38	Pass
40	5200	5.84	6.13	6.23	6.80	12.28	13.38	Pass
48	5240	5.87	5.82	6.51	6.60	12.24	13.38	Pass

- Note:**
- Method a) of power density measurement of KDB 662911 is using for calculating total power density. Total power density is summing entire spectra across corresponding frequency bins on the various outputs by computer.
 - Directional gain = $3.6\text{dBi} + 10\log(4) = 9.62\text{dBi} > 6\text{dBi}$, so the power density limit shall be reduced to $17 - (9.62 - 6) = 13.38\text{dBm}$.

802.11ac (VHT40)

Chan.	Chan. Freq. (MHz)	PSD W/O Duty Factor (dBm)				Duty Factor (dB)	Total PSD With Duty Factor (dBm)	MAX. Limit (dBm/MHz)	Pass / Fail
		Chain 0	Chain 1	Chain 2	Chain 3				
38	5190	3.75	3.95	3.60	4.72	0.13	10.18	13.38	Pass
46	5230	6.24	6.22	5.90	6.92	0.13	12.48	13.38	Pass

- Note:**
- Method a) of power density measurement of KDB 662911 is using for calculating total power density. Total power density is summing entire spectra across corresponding frequency bins on the various outputs by computer.
 - Directional gain = $3.6\text{dBi} + 10\log(4) = 9.62\text{dBi} > 6\text{dBi}$, so the power density limit shall be reduced to $17 - (9.62 - 6) = 13.38\text{dBm}$.
 - Refer to section 3.3 for duty cycle spectrum plot.

802.11ac (VHT80)

Chan.	Chan. Freq. (MHz)	PSD W/O Duty Factor (dBm)				Duty Factor (dB)	Total PSD With Duty Factor (dBm)	MAX. Limit (dBm/MHz)	Pass / Fail
		Chain 0	Chain 1	Chain 2	Chain 3				
42	5210	-1.32	-1.28	-1.29	-0.45	0.22	5.18	13.38	Pass

- Note:**
- Method a) of power density measurement of KDB 662911 is using for calculating total power density. Total power density is summing entire spectra across corresponding frequency bins on the various outputs by computer.
 - Directional gain = $3.6\text{dBi} + 10\log(4) = 9.62\text{dBi} > 6\text{dBi}$, so the power density limit shall be reduced to $17-(9.62-6) = 13.38\text{dBm}$.
 - Refer to section 3.3 for duty cycle spectrum plot.

802.11ac (VHT80+80)

Chan.	Chan. Freq. (MHz)	PSD W/O Duty Factor (dBm)				Duty Factor (dB)	Total Power Density (dBm/MHz)	MAX. Limit (dBm/MHz)	Pass / Fail
		Chain 0	Chain 1	Chain 2	Chain 3				
42+ 155	5210	-0.40	-0.50	-	-	0.14	2.70	16.39	Pass
	5775	Test results refer to U_NII-3 data							

- Note:**
- Method a) of power density measurement of KDB 662911 is using for calculating total power density. Total power density is summing entire spectra across corresponding frequency bins on the various outputs by computer.
 - Directional gain = $3.6\text{dBi} + 10\log(2) = 6.61\text{dBi} > 6\text{dBi}$, so the power density limit shall be reduced to $17-(6.61-6) = 16.39\text{dBm}$.
 - Refer to section 3.3 for duty cycle spectrum plot.

Spectrum Plot of Worst Value

802.11a / Chain 3 : CH36

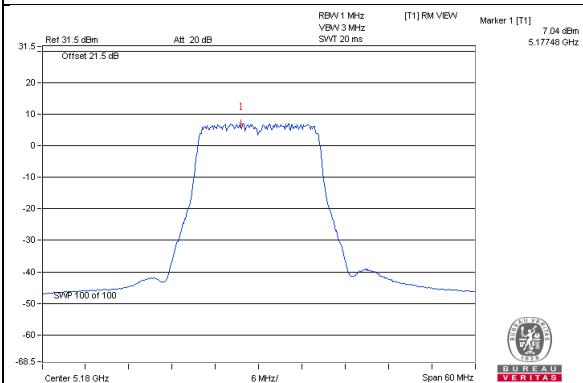

802.11a (VHT20) / Chain 3 : CH40

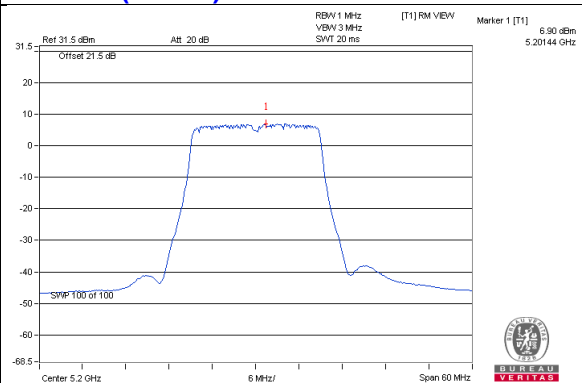

802.11ac (VHT40) / Chain 3: CH46

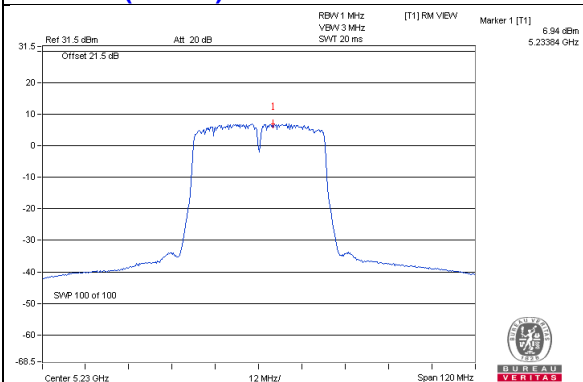

802.11ac (VHT80) / Chain 3 : CH42

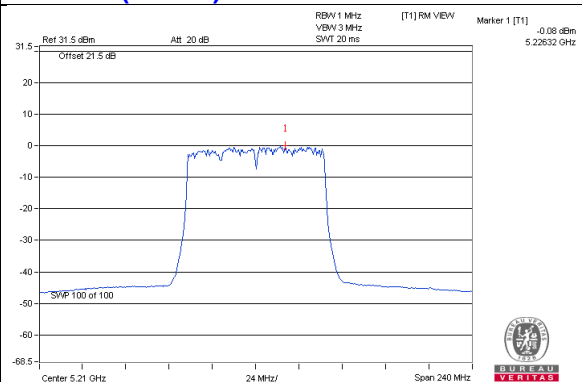

802.11ac (VHT80+80) / Chain 0: CH42

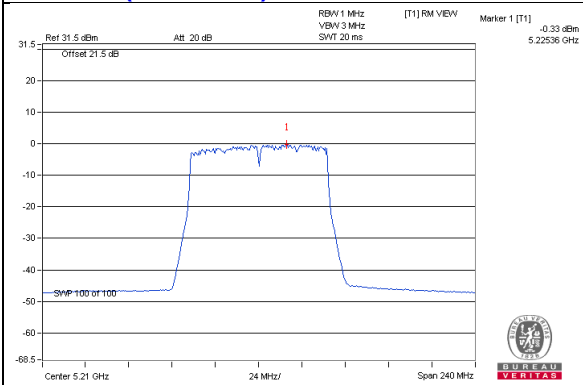

For U-NII-3:

802.11a

TX chain	Chan.	Chan. Freq. (MHz)	PSD W/O Duty Factor		10 log (N=4) dB	Duty Factor (dB)	Total PSD With Duty Factor (dBm/500kHz)	Limit (dBm/500kHz)	Pass /Fail
			(dBm/300kHz)	(dBm/500kHz)					
0	149	5745	2.46	4.68	6.02	0.18	10.88	26.38	Pass
	157	5785	2.14	4.36	6.02	0.18	10.56	26.38	Pass
	165	5825	2.05	4.27	6.02	0.18	10.47	26.38	Pass
1	149	5745	2.05	4.27	6.02	0.18	10.47	26.38	Pass
	157	5785	2.49	4.71	6.02	0.18	10.91	26.38	Pass
	165	5825	1.89	4.11	6.02	0.18	10.31	26.38	Pass
2	149	5745	1.68	3.90	6.02	0.18	10.10	26.38	Pass
	157	5785	1.91	4.13	6.02	0.18	10.33	26.38	Pass
	165	5825	1.29	3.51	6.02	0.18	9.71	26.38	Pass
3	149	5745	1.63	3.85	6.02	0.18	10.05	26.38	Pass
	157	5785	2.43	4.65	6.02	0.18	10.85	26.38	Pass
	165	5825	1.93	4.15	6.02	0.18	10.35	26.38	Pass

Note: 1. Directional gain = $3.6\text{dBi} + 10\log(4) = 9.62\text{dBi} > 6\text{dBi}$, so the power density limit shall be reduced to $30 - (9.62 - 6) = 26.38\text{dBm}$.

2. Refer to section 3.3 for duty cycle spectrum plot.

802.11ac (VHT20)

TX chain	Channel	Freq. (MHz)	PSD (dBm/300kHz)	PSD (dBm/500kHz)	10 log (N=4) dB	Total PSD (dBm/500kHz)	Limit (dBm/500kHz)	Pass /Fail
0	149	5745	1.98	4.20	6.02	10.22	26.38	Pass
	157	5785	1.84	4.06	6.02	10.08	26.38	Pass
	165	5825	1.37	3.59	6.02	9.61	26.38	Pass
1	149	5745	1.96	4.18	6.02	10.20	26.38	Pass
	157	5785	2.06	4.28	6.02	10.30	26.38	Pass
	165	5825	1.63	3.85	6.02	9.87	26.38	Pass
2	149	5745	1.26	3.48	6.02	9.50	26.38	Pass
	157	5785	1.60	3.82	6.02	9.84	26.38	Pass
	165	5825	0.93	3.15	6.02	9.17	26.38	Pass
3	149	5745	2.13	4.35	6.02	10.37	26.38	Pass
	157	5785	1.73	3.95	6.02	9.97	26.38	Pass
	165	5825	1.88	4.10	6.02	10.12	26.38	Pass

Note: 1. Directional gain = $3.6\text{dBi} + 10\log(4) = 9.62\text{dBi} > 6\text{dBi}$, so the power density limit shall be reduced to $30-(9.62-6) = 26.38\text{dBm}$.

802.11ac (VHT40)

TX chain	Chan.	Chan. Freq. (MHz)	PSD W/O Duty Factor		10 log (N=4) dB	Duty Factor (dB)	Total PSD With Duty Factor (dBm/500kHz)	Limit (dBm/500kHz)	Pass /Fail
			(dBm/300kHz)	(dBm/500kHz)					
0	151	5755	-1.43	0.79	6.02	0.13	6.94	26.38	Pass
	159	5795	-1.52	0.70	6.02	0.13	6.85	26.38	Pass
1	151	5755	-1.38	0.84	6.02	0.13	6.99	26.38	Pass
	159	5795	-1.16	1.06	6.02	0.13	7.21	26.38	Pass
2	151	5755	-2.12	0.10	6.02	0.13	6.25	26.38	Pass
	159	5795	-2.03	0.19	6.02	0.13	6.34	26.38	Pass
3	151	5755	-1.51	0.71	6.02	0.13	6.86	26.38	Pass
	159	5795	-1.82	0.40	6.02	0.13	6.55	26.38	Pass

Note: 1. Directional gain = $3.6\text{dBi} + 10\log(4) = 9.62\text{dBi} > 6\text{dBi}$, so the power density limit shall be reduced to $30-(9.62-6) = 26.38\text{dBm}$.

2. Refer to section 3.3 for duty cycle spectrum plot.

802.11ac (VHT80)

TX chain	Chan.	Chan. Freq. (MHz)	PSD W/O Duty Factor		10 log (N=4) dB	Duty Factor (dB)	Total PSD With Duty Factor (dBm/500kHz)	Limit (dBm/500kHz)	Pass /Fail
			(dBm/300kHz)	(dBm/500kHz)					
0	155	5775	-9.20	-6.98	6.02	0.22	-0.74	26.38	Pass
1	155	5775	-8.80	-6.58	6.02	0.22	-0.34	26.38	Pass
2	155	5775	-9.04	-6.82	6.02	0.22	-0.58	26.38	Pass
3	155	5775	-8.18	-5.96	6.02	0.22	0.28	26.38	Pass

Note: 1. Directional gain = $3.6\text{dBi} + 10\log(4) = 9.62\text{dBi} > 6\text{dBi}$, so the power density limit shall be reduced to $30 - (9.62 - 6) = 26.38\text{dBm}$.

2. Refer to section 3.3 for duty cycle spectrum plot.

802.11ac (VHT80+80)

TX chain	Chan.	Chan. Freq. (MHz)	PSD W/O Duty Factor		10 log (N=2) dB	Duty Factor (dB)	Total PSD With Duty Factor (dBm/500kHz)	Limit (dBm/500kHz)	Pass /Fail
			(dBm/300kHz)	(dBm/500kHz)					
0	42	5210	Test results refer to U_NII-1 data						
1	42	5210	Test results refer to U_NII-1 data						
2	155	5775	-9.11	-6.89	3.01	0.14	-3.74	29.39	Pass
3	155	5775	-8.71	-6.49	3.01	0.14	-3.34	29.39	Pass

Note: 1. Directional gain = $3.6\text{dBi} + 10\log(2) = 6.61\text{dBi} > 6\text{dBi}$, so the power density limit shall be reduced to $30 - (6.61 - 6) = 29.39\text{dBm}$.

2. Refer to section 3.3 for duty cycle spectrum plot.

Spectrum Plot of Worst Value

802.11a / Chain 1 : CH157

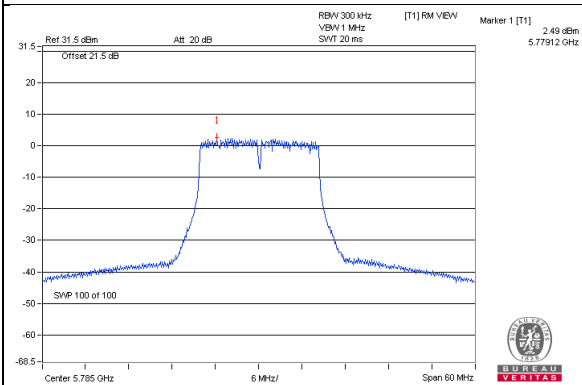

802.11ac (VHT20) / Chain 3 : CH149

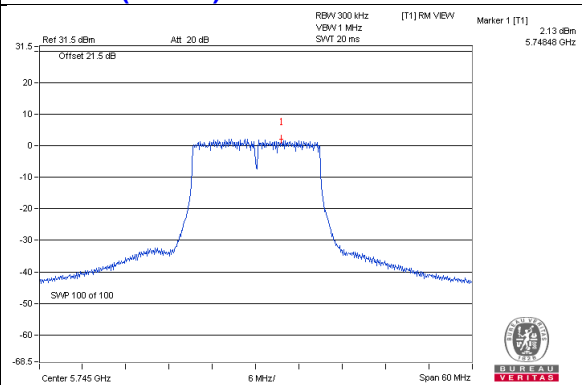

802.11ac (VHT40) / Chain 1: CH159

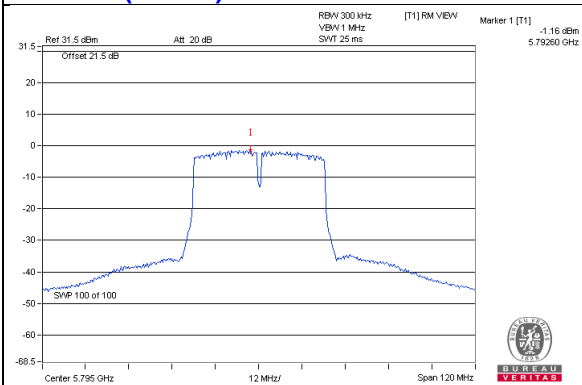

802.11ac (VHT80) / Chain 3 : CH155

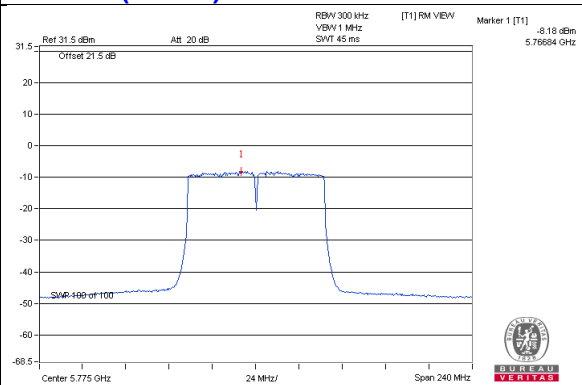

802.11ac (VHT80+80) / Chain 3: CH155

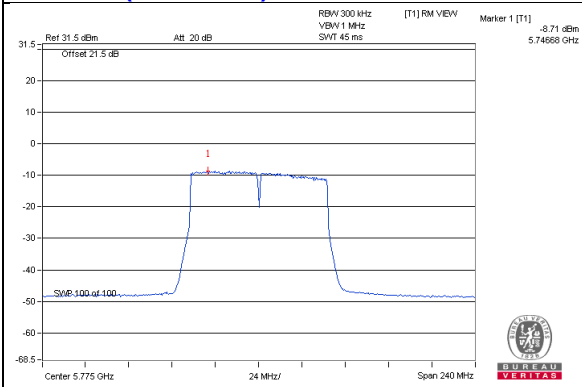

Client Mode
For U-NII-1:
802.11a

Chan.	Chan. Freq. (MHz)	PSD W/O Duty Factor (dBm)				Duty Factor (dB)	Total PSD With Duty Factor (dBm)	MAX. Limit (dBm/MHz)	Pass / Fail
		Chain 0	Chain 1	Chain 2	Chain 3				
36	5180	0.01	0.25	0.50	0.93	0.18	6.63	7.38	Pass
40	5200	0.26	-0.11	0.64	0.35	0.18	6.49	7.38	Pass
48	5240	0.33	0.30	0.92	0.24	0.18	6.65	7.38	Pass

- Note:**
- Method a) of power density measurement of KDB 662911 is using for calculating total power density. Total power density is summing entire spectra across corresponding frequency bins on the various outputs by computer.
 - Directional gain = $3.6\text{dBi} + 10\log(4) = 9.62\text{dBi} > 6\text{dBi}$, so the power density limit shall be reduced to $11-(9.62-6) = 7.38\text{dBm}$.
 - Refer to section 3.3 for duty cycle spectrum plot.

802.11ac (VHT20)

Chan.	Chan. Freq. (MHz)	PSD (dBm/MHz)				Total Power Density (dBm/MHz)	MAX. Limit (dBm/MHz)	Pass / Fail
		Chain 0	Chain 1	Chain 2	Chain 3			
36	5180	-0.06	-0.26	0.21	0.42	6.11	7.38	Pass
40	5200	-0.10	-0.09	0.30	0.61	6.21	7.38	Pass
48	5240	-0.10	0.40	0.29	0.77	6.37	7.38	Pass

- Note:**
- Method a) of power density measurement of KDB 662911 is using for calculating total power density. Total power density is summing entire spectra across corresponding frequency bins on the various outputs by computer.
 - Directional gain = $3.6\text{dBi} + 10\log(4) = 9.62\text{dBi} > 6\text{dBi}$, so the power density limit shall be reduced to $11-(9.62-6) = 7.38\text{dBm}$.

802.11ac (VHT40)

Chan.	Chan. Freq. (MHz)	PSD W/O Duty Factor (dBm)				Duty Factor (dB)	Total PSD With Duty Factor (dBm)	MAX. Limit (dBm/MHz)	Pass / Fail
		Chain 0	Chain 1	Chain 2	Chain 3				
38	5190	-0.23	0.41	0.40	0.68	0.13	6.48	7.38	Pass
46	5230	0.22	0.52	-0.09	0.95	0.13	6.57	7.38	Pass

- Note:**
- Method a) of power density measurement of KDB 662911 is using for calculating total power density. Total power density is summing entire spectra across corresponding frequency bins on the various outputs by computer.
 - Directional gain = $3.6\text{dBi} + 10\log(4) = 9.62\text{dBi} > 6\text{dBi}$, so the power density limit shall be reduced to $11-(9.62-6) = 7.38\text{dBm}$.
 - Refer to section 3.3 for duty cycle spectrum plot.

802.11ac (VHT80)

Chan.	Chan. Freq. (MHz)	PSD W/O Duty Factor (dBm)				Duty Factor (dB)	Total PSD With Duty Factor (dBm)	MAX. Limit (dBm/MHz)	Pass / Fail
		Chain 0	Chain 1	Chain 2	Chain 3				
42	5210	-2.46	-2.40	-2.76	-1.85	0.22	3.89	7.38	Pass

- Note:**
- Method a) of power density measurement of KDB 662911 is using for calculating total power density. Total power density is summing entire spectra across corresponding frequency bins on the various outputs by computer.
 - Directional gain = $3.6\text{dBi} + 10\log(4) = 9.62\text{dBi} > 6\text{dBi}$, so the power density limit shall be reduced to $11-(9.62-6) = 7.38\text{dBm}$.
 - Refer to section 3.3 for duty cycle spectrum plot.

802.11ac (VHT80+80)

Chan.	Chan. Freq. (MHz)	PSD W/O Duty Factor (dBm)				Duty Factor (dB)	Total Power Density (dBm/MHz)	MAX. Limit (dBm/MHz)	Pass / Fail
		Chain 0	Chain 1	Chain 2	Chain 3				
42+ 155	5210	-0.40	-0.50	-	-	0.14	2.70	10.39	Pass
	5775	Test results refer to U_NII-3 data							

- Note:**
- Method a) of power density measurement of KDB 662911 is using for calculating total power density. Total power density is summing entire spectra across corresponding frequency bins on the various outputs by computer.
 - Directional gain = $3.6\text{dBi} + 10\log(2) = 6.61\text{dBi} > 6\text{dBi}$, so the power density limit shall be reduced to $11-(6.61-6) = 10.39\text{dBm}$.
 - Refer to section 3.3 for duty cycle spectrum plot.

Spectrum Plot of Worst Value

802.11a / Chain 3 : CH36

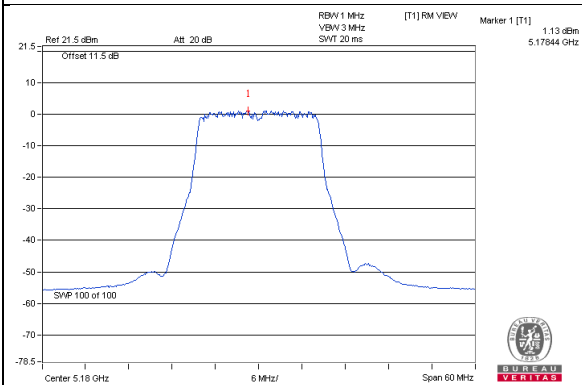

802.11a (VHT20) / Chain 3 : CH48

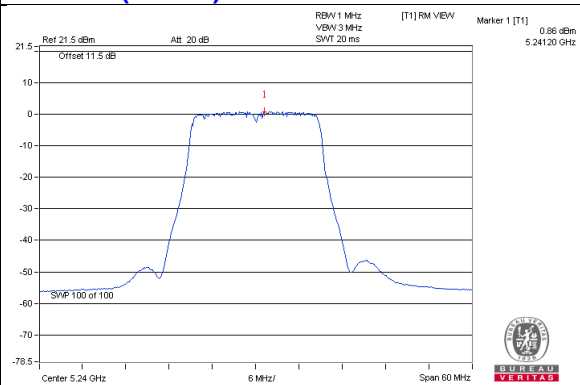

802.11ac (VHT40) / Chain 3: CH46

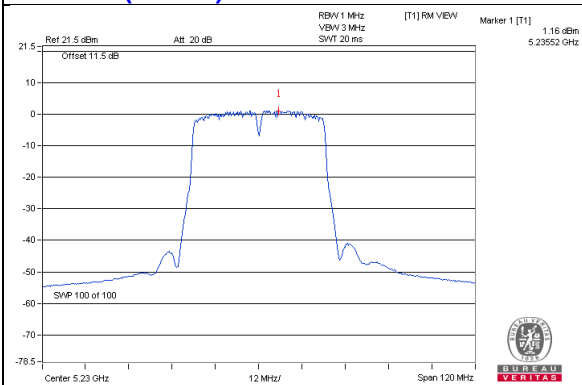

802.11ac (VHT80) / Chain 3 : CH42

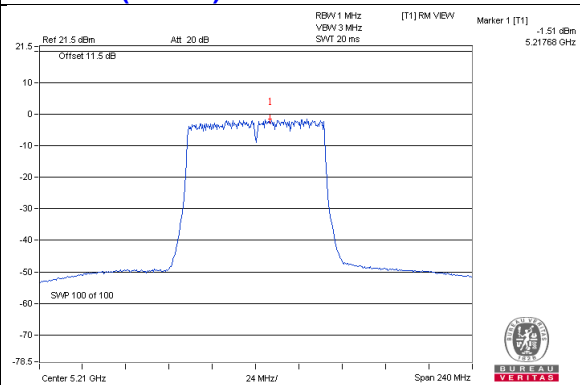

802.11ac (VHT80+80) / Chain 0: CH42

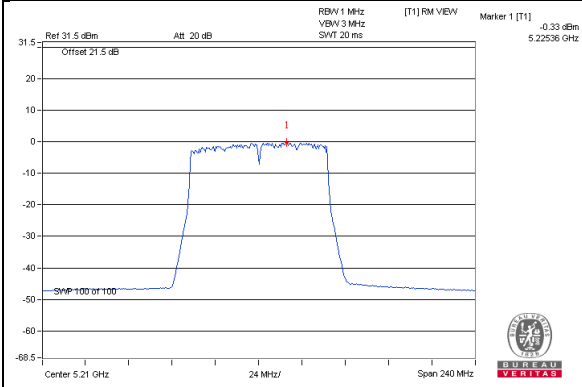

For U-NII-3:

802.11a

TX chain	Chan.	Chan. Freq. (MHz)	PSD W/O Duty Factor		10 log (N=4) dB	Duty Factor (dB)	Total PSD With Duty Factor (dBm/500kHz)	Limit (dBm/500kHz)	Pass /Fail
			(dBm/300kHz)	(dBm/500kHz)					
0	149	5745	2.46	4.68	6.02	0.18	10.88	26.38	Pass
	157	5785	2.14	4.36	6.02	0.18	10.56	26.38	Pass
	165	5825	2.05	4.27	6.02	0.18	10.47	26.38	Pass
1	149	5745	2.05	4.27	6.02	0.18	10.47	26.38	Pass
	157	5785	2.49	4.71	6.02	0.18	10.91	26.38	Pass
	165	5825	1.89	4.11	6.02	0.18	10.31	26.38	Pass
2	149	5745	1.68	3.90	6.02	0.18	10.10	26.38	Pass
	157	5785	1.91	4.13	6.02	0.18	10.33	26.38	Pass
	165	5825	1.29	3.51	6.02	0.18	9.71	26.38	Pass
3	149	5745	1.63	3.85	6.02	0.18	10.05	26.38	Pass
	157	5785	2.43	4.65	6.02	0.18	10.85	26.38	Pass
	165	5825	1.93	4.15	6.02	0.18	10.35	26.38	Pass

Note: 1. Directional gain = $3.6\text{dBi} + 10\log(4) = 9.62\text{dBi} > 6\text{dBi}$, so the power density limit shall be reduced to $30 - (9.62 - 6) = 26.38\text{dBm}$.

2. Refer to section 3.3 for duty cycle spectrum plot.

802.11ac (VHT20)

TX chain	Channel	Freq. (MHz)	PSD (dBm/300kHz)	PSD (dBm/500kHz)	10 log (N=4) dB	Total PSD (dBm/500kHz)	Limit (dBm/500kHz)	Pass /Fail
0	149	5745	1.98	4.20	6.02	10.22	26.38	Pass
	157	5785	1.84	4.06	6.02	10.08	26.38	Pass
	165	5825	1.37	3.59	6.02	9.61	26.38	Pass
1	149	5745	1.96	4.18	6.02	10.20	26.38	Pass
	157	5785	2.06	4.28	6.02	10.30	26.38	Pass
	165	5825	1.63	3.85	6.02	9.87	26.38	Pass
2	149	5745	1.26	3.48	6.02	9.50	26.38	Pass
	157	5785	1.60	3.82	6.02	9.84	26.38	Pass
	165	5825	0.93	3.15	6.02	9.17	26.38	Pass
3	149	5745	2.13	4.35	6.02	10.37	26.38	Pass
	157	5785	1.73	3.95	6.02	9.97	26.38	Pass
	165	5825	1.88	4.10	6.02	10.12	26.38	Pass

Note: 1. Directional gain = $3.6\text{dBi} + 10\log(4) = 9.62\text{dBi} > 6\text{dBi}$, so the power density limit shall be reduced to $30-(9.62-6) = 26.38\text{dBm}$.

802.11ac (VHT40)

TX chain	Chan.	Chan. Freq. (MHz)	PSD W/O Duty Factor		10 log (N=4) dB	Duty Factor (dB)	Total PSD With Duty Factor (dBm/500kHz)	Limit (dBm/500kHz)	Pass /Fail
			(dBm/300kHz)	(dBm/500kHz)					
0	151	5755	-1.43	0.79	6.02	0.13	6.94	26.38	Pass
	159	5795	-1.52	0.70	6.02	0.13	6.85	26.38	Pass
1	151	5755	-1.38	0.84	6.02	0.13	6.99	26.38	Pass
	159	5795	-1.16	1.06	6.02	0.13	7.21	26.38	Pass
2	151	5755	-2.12	0.10	6.02	0.13	6.25	26.38	Pass
	159	5795	-2.03	0.19	6.02	0.13	6.34	26.38	Pass
3	151	5755	-1.51	0.71	6.02	0.13	6.86	26.38	Pass
	159	5795	-1.82	0.40	6.02	0.13	6.55	26.38	Pass

Note: 1. Directional gain = $3.6\text{dBi} + 10\log(4) = 9.62\text{dBi} > 6\text{dBi}$, so the power density limit shall be reduced to $30-(9.62-6) = 26.38\text{dBm}$.

2. Refer to section 3.3 for duty cycle spectrum plot.

802.11ac (VHT80)

TX chain	Chan.	Chan. Freq. (MHz)	PSD W/O Duty Factor		10 log (N=4) dB	Duty Factor (dB)	Total PSD With Duty Factor (dBm/500kHz)	Limit (dBm/500kHz)	Pass /Fail
			(dBm/300kHz)	(dBm/500kHz)					
0	155	5775	-9.20	-6.98	6.02	0.22	-0.74	26.38	Pass
1	155	5775	-8.80	-6.58	6.02	0.22	-0.34	26.38	Pass
2	155	5775	-9.04	-6.82	6.02	0.22	-0.58	26.38	Pass
3	155	5775	-8.18	-5.96	6.02	0.22	0.28	26.38	Pass

Note: 1. Directional gain = $3.6\text{dBi} + 10\log(4) = 9.62\text{dBi} > 6\text{dBi}$, so the power density limit shall be reduced to $30 - (9.62 - 6) = 26.38\text{dBm}$.

2. Refer to section 3.3 for duty cycle spectrum plot.

802.11ac (VHT80+80)

TX chain	Chan.	Chan. Freq. (MHz)	PSD W/O Duty Factor		10 log (N=2) dB	Duty Factor (dB)	Total PSD With Duty Factor (dBm/500kHz)	Limit (dBm/500kHz)	Pass /Fail
			(dBm/300kHz)	(dBm/500kHz)					
0	42	5210	Test results refer to U_NII-1 data						
1	42	5210	Test results refer to U_NII-1 data						
2	155	5775	-9.11	-6.89	3.01	0.14	-3.74	29.39	Pass
3	155	5775	-8.71	-6.49	3.01	0.14	-3.34	29.39	Pass

Note: 1. Directional gain = $3.6\text{dBi} + 10\log(2) = 6.61\text{dBi} > 6\text{dBi}$, so the power density limit shall be reduced to $30 - (6.61 - 6) = 29.39\text{dBm}$.

2. Refer to section 3.3 for duty cycle spectrum plot.

Spectrum Plot of Worst Value

802.11a / Chain 1 : CH157

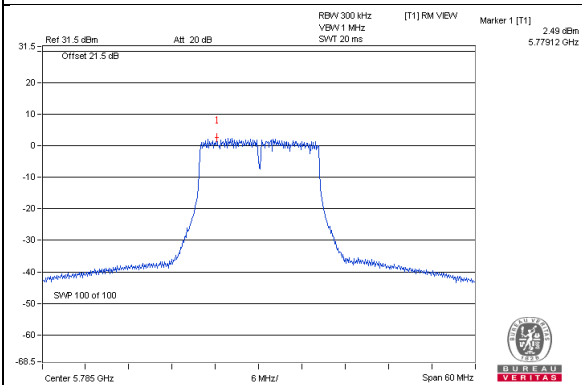

802.11ac (VHT20) / Chain 3 : CH149

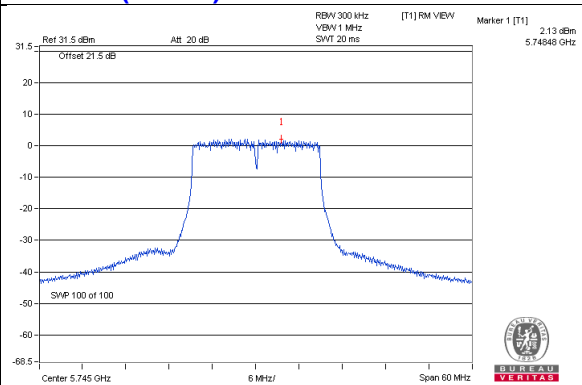

802.11ac (VHT40) / Chain 1: CH159

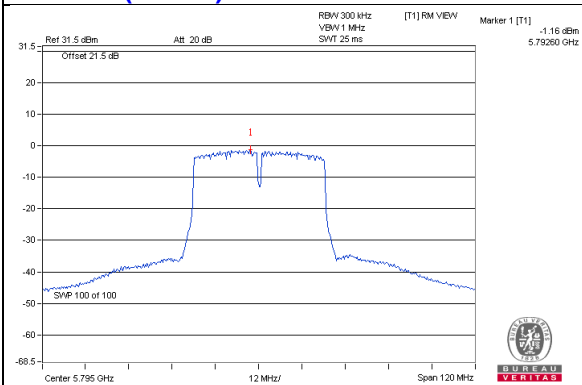

802.11ac (VHT80) / Chain 3 : CH155

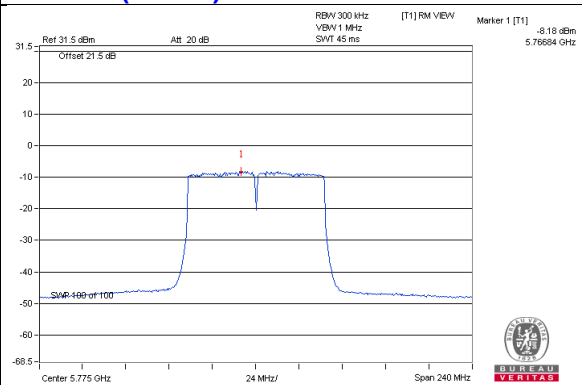

802.11ac (VHT80+80) / Chain 3: CH155

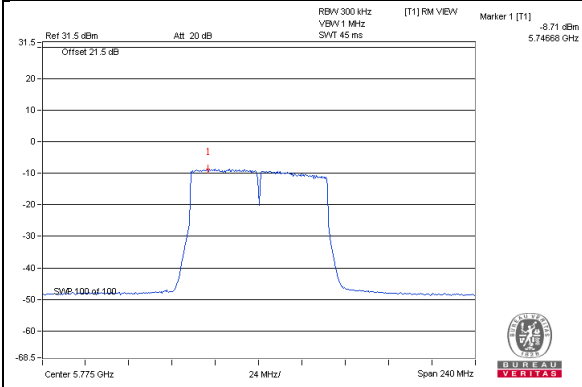

4.6 Frequency Stability Measurement

4.6.1 Limits of Frequency Stability Measurement

The frequency of the carrier signal shall be maintained within band of operation

4.6.2 Test Setup

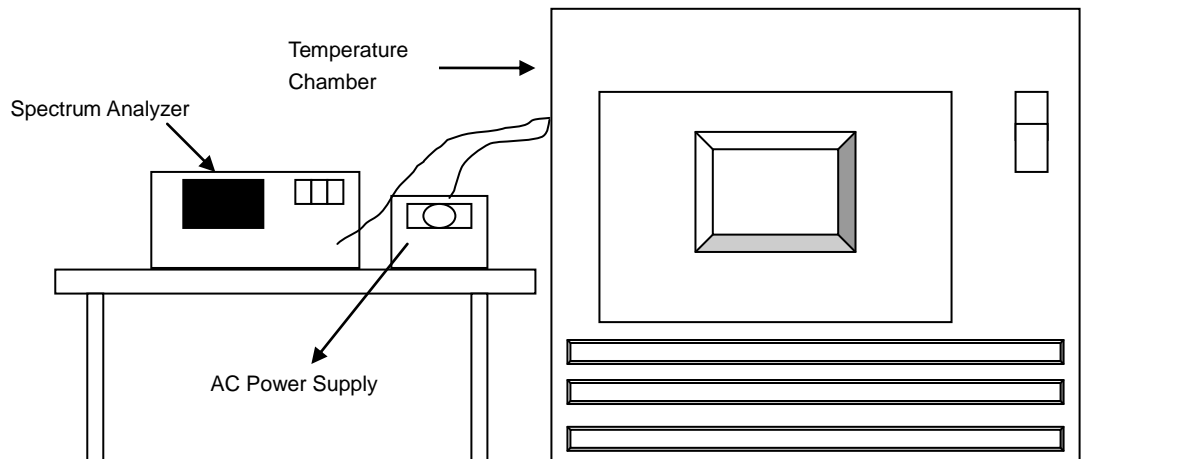

4.6.3 Test Instruments

Refer to section 4.1.2 to get information of above instrument.

4.6.4 Test Procedure

- The EUT was placed inside the environmental test chamber and powered by nominal AC voltage.
- Turn the EUT on and couple its output to a spectrum analyzer.
- Turn the EUT off and set the chamber to the highest temperature specified.
- Allow sufficient time (approximately 30 min) for the temperature of the chamber to stabilize, turn the EUT on and measure the operating frequency after 2, 5, and 10 Minutes.
- Repeat step 2 and 3 with the temperature chamber set to the lowest temperature.
- The test chamber was allowed to stabilize at +20 degree C for a minimum of 30 Minutes. The supply voltage was then adjusted on the EUT from 85% to 115% and the frequency record.

4.6.5 Deviation from Test Standard

No deviation.

4.6.6 EUT Operating Condition

Set the EUT transmit at un-modulation mode to test frequency stability.

4.6.7 Test Results

Frequency Stability Versus Temp.									
Operating Frequency: 5180 MHz									
TEMP. (°C)	Power Supply (Vac)	0 Minute		2 Minutes		5 Minutes		10 Minutes	
		Measured Frequency (MHz)	Pass/Fail	Measured Frequency (MHz)	Pass/Fail	Measured Frequency (MHz)	Pass/Fail	Measured Frequency (MHz)	Pass/Fail
50	120	5179.9995	PASS	5179.9976	PASS	5179.9973	PASS	5179.9989	PASS
40	120	5179.9847	PASS	5179.9894	PASS	5179.9874	PASS	5179.9883	PASS
30	120	5179.9872	PASS	5179.9862	PASS	5179.9907	PASS	5179.9895	PASS
20	120	5180.0078	PASS	5180.0092	PASS	5180.0072	PASS	5180.0086	PASS
10	120	5180.0263	PASS	5180.0264	PASS	5180.0228	PASS	5180.0258	PASS
0	120	5180.0039	PASS	5180.0049	PASS	5180.0054	PASS	5180.0032	PASS
-10	120	5180.02	PASS	5180.0227	PASS	5180.0233	PASS	5180.0221	PASS
-20	120	5179.9839	PASS	5179.9873	PASS	5179.9828	PASS	5179.9864	PASS
-30	120	5179.9793	PASS	5179.9797	PASS	5179.9804	PASS	5179.9813	PASS

Frequency Stability Versus Voltage									
Operating Frequency: 5180 MHz									
TEMP. (°C)	Power Supply (Vac)	0 Minute		2 Minutes		5 Minutes		10 Minutes	
		Measured Frequency (MHz)	Pass/Fail	Measured Frequency (MHz)	Pass/Fail	Measured Frequency (MHz)	Pass/Fail	Measured Frequency (MHz)	Pass/Fail
20	138	5180.008	PASS	5180.0091	PASS	5180.0081	PASS	5180.0083	PASS
	120	5180.0078	PASS	5180.0092	PASS	5180.0072	PASS	5180.0086	PASS
	102	5180.0069	PASS	5180.0099	PASS	5180.0065	PASS	5180.0095	PASS

4.7 6dB Bandwidth Measurement

4.7.1 Limits of 6dB Bandwidth Measurement

The minimum of 6dB Bandwidth Measurement is 0.5MHz.

4.7.2 Test Setup

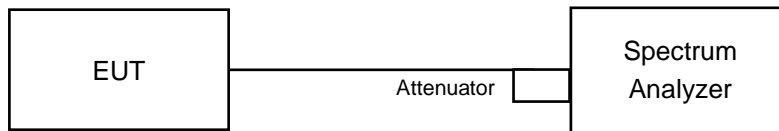

4.7.3 Test Instruments

Refer to section 4.1.2 to get information of above instrument.

4.7.4 Test Procedure

MEASUREMENT PROCEDURE REF

- a. Set resolution bandwidth (RBW) = 100kHz
- b. Set the video bandwidth (VBW) $\geq 3 \times$ RBW, Detector = Peak.
- c. Trace mode = max hold.
- d. Sweep = auto couple.
- e. Measure the maximum width of the emission that is constrained by the frequencies associated with the two amplitude points (upper and lower) that are attenuated by 6 dB relative to the maximum level measured in the fundamental emission

4.7.5 Deviation from Test Standard

No deviation.

4.7.6 EUT Operating Condition

The software provided by client to enable the EUT under transmission condition continuously at lowest, middle and highest channel frequencies individually.

4.7.7 Test Results
Master / Client Mode
802.11a

Channel	Frequency (MHz)	6dB Bandwidth (MHz)				Minimum Limit (MHz)	Pass / Fail
		Chain 0	Chain 1	Chain 2	Chain 3		
149	5745	16.40	16.38	16.39	16.42	0.5	PASS
157	5785	16.38	16.37	16.39	16.39	0.5	PASS
165	5825	16.37	16.37	16.38	16.38	0.5	PASS

802.11ac (VHT20)

Channel	Frequency (MHz)	6dB Bandwidth (MHz)				Minimum Limit (MHz)	Pass / Fail
		Chain 0	Chain 1	Chain 2	Chain 3		
149	5745	17.62	17.62	17.63	17.66	0.5	PASS
157	5785	17.60	17.61	17.63	17.62	0.5	PASS
165	5825	17.63	17.62	17.66	17.63	0.5	PASS

802.11ac (VHT40)

Channel	Frequency (MHz)	6dB Bandwidth (MHz)				Minimum Limit (MHz)	Pass / Fail
		Chain 0	Chain 1	Chain 2	Chain 3		
151	5755	35.15	35.18	36.04	34.58	0.5	PASS
159	5795	36.42	35.13	35.23	35.05	0.5	PASS

802.11ac (VHT80)

Channel	Frequency (MHz)	6dB Bandwidth (MHz)				Minimum Limit (MHz)	Pass / Fail
		Chain 0	Chain 1	Chain 2	Chain 3		
155	5775	76.42	76.45	76.52	76.46	0.5	PASS

802.11ac (VHT80+80)

Channel	Frequency (MHz)	6dB Bandwidth (MHz)				Minimum Limit (MHz)	Pass / Fail
		Chain 0	Chain 1	Chain 2	Chain 3		
42+155	5210	-					
	5775	-	-	76.00	75.98	0.5	PASS

Spectrum Plot of Worst Value

802.11a_Chain 0 / CH165

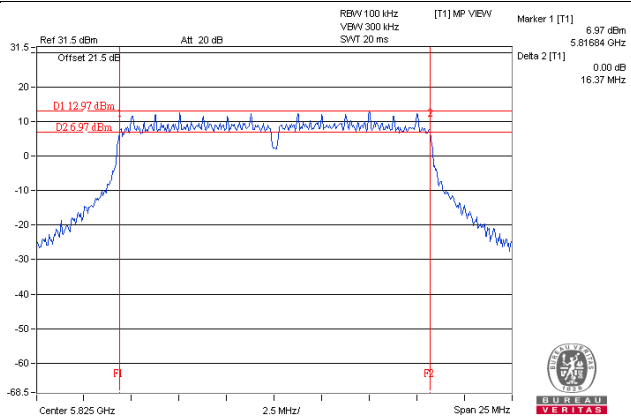

802.11ac (VHT20)_Chain 0 / CH157

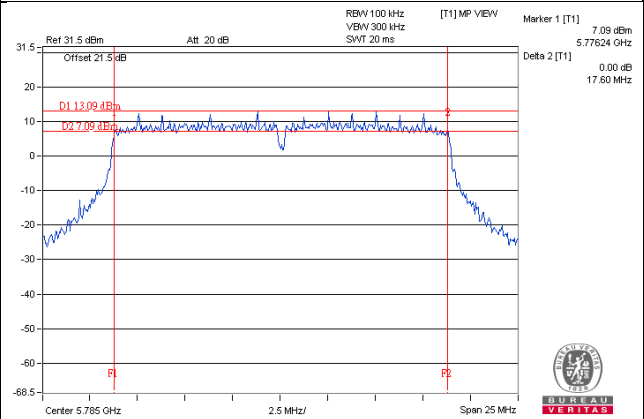

802.11ac (VHT40)_Chain 3 / CH151

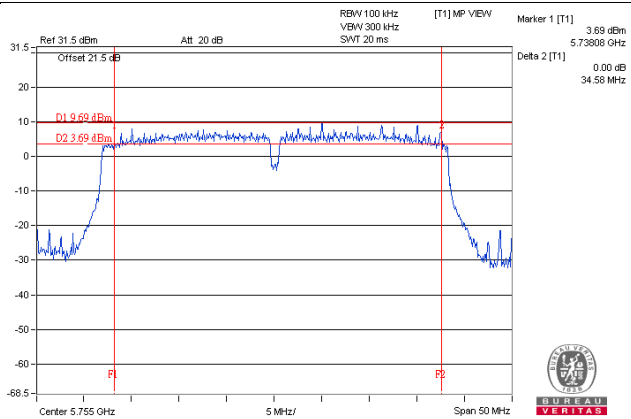

802.11ac (VHT80)_Chain 0 / CH155

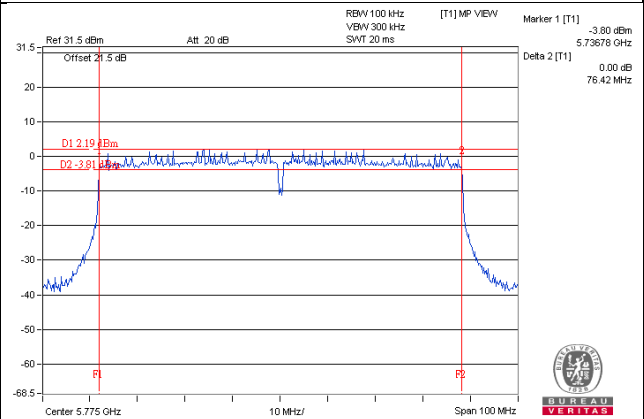

802.11ac (VHT80+80)_Chain 3 / CH155

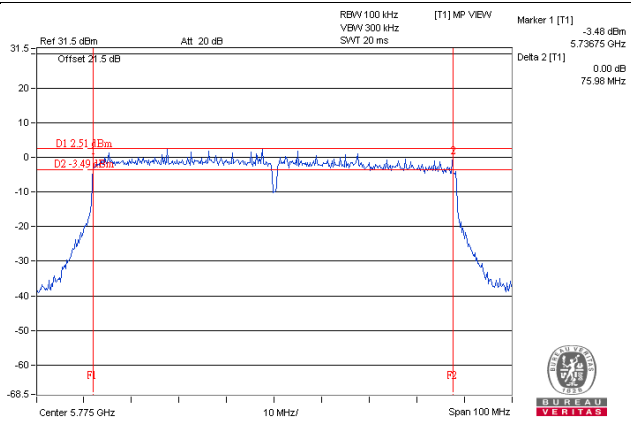

5 Pictures of Test Arrangements

Please refer to the attached file (Test Setup Photo).

Annex A- Radiated Out of Band Emission (OOBE) Measurement (For U-NII-3 band)

802.11a

CH 149 5745 MHz

Horizontal

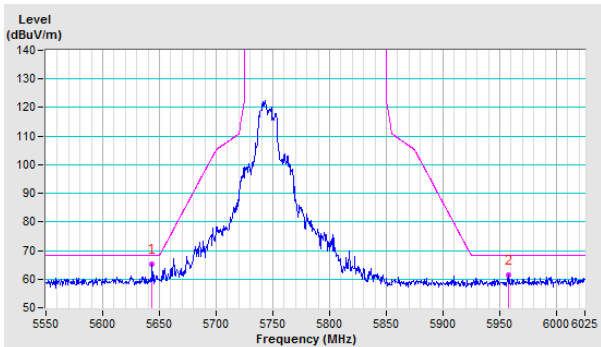

Vertical

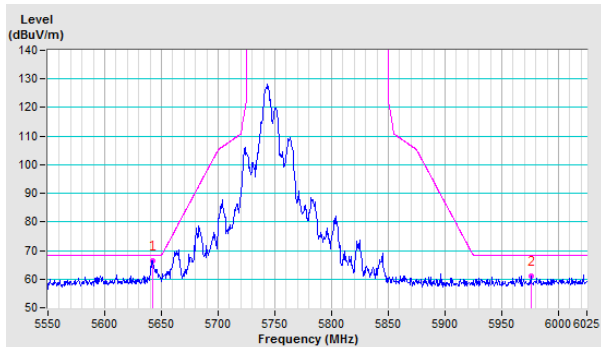

CH 157 5785 MHz

Horizontal

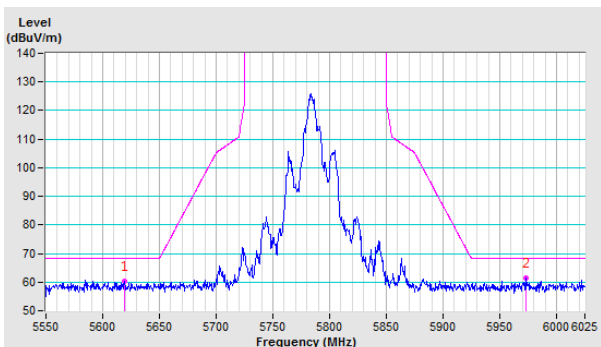

Vertical

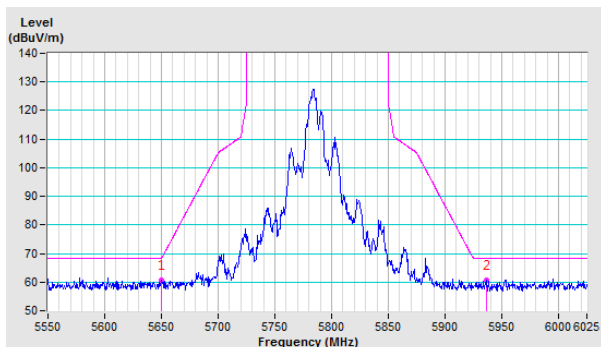

CH 165 5825 MHz

Horizontal

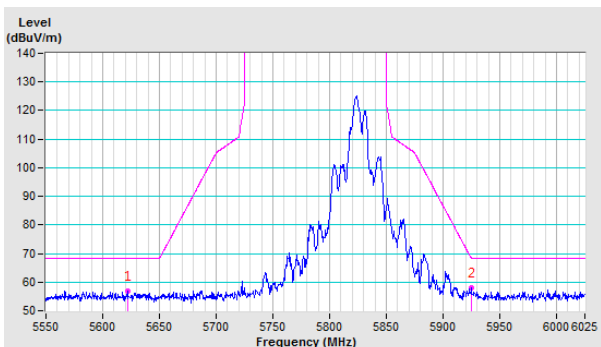

Vertical

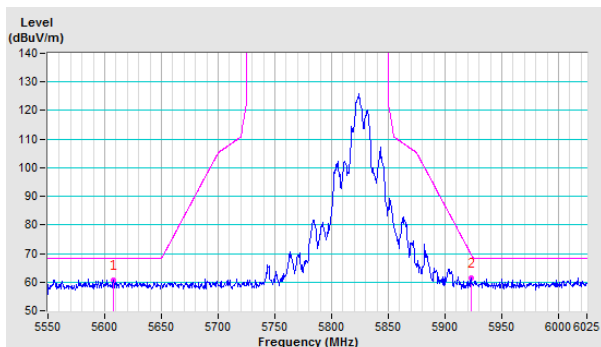

802.11ac (VHT20)

CH 149 5745 MHz

Horizontal

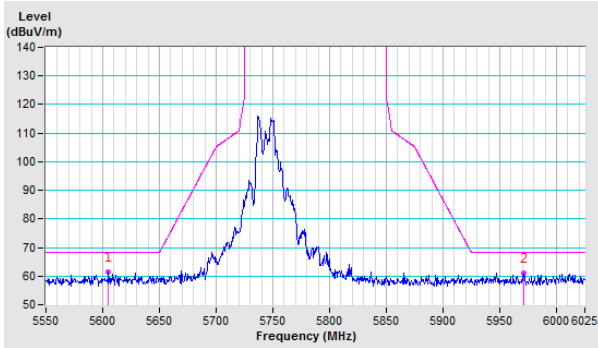

Vertical

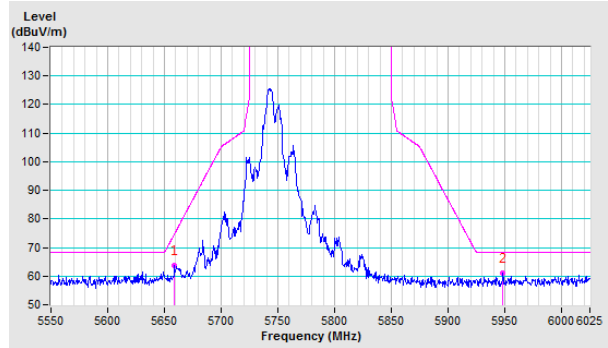

CH 157 5785 MHz

Horizontal

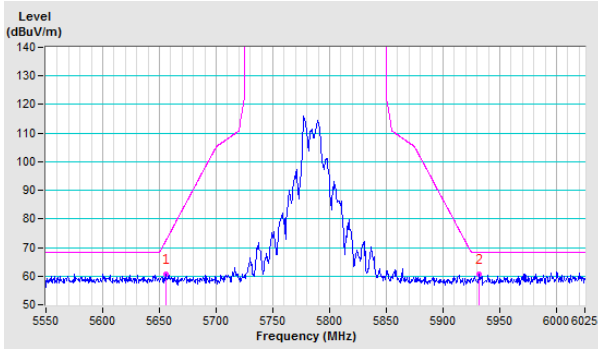

Vertical

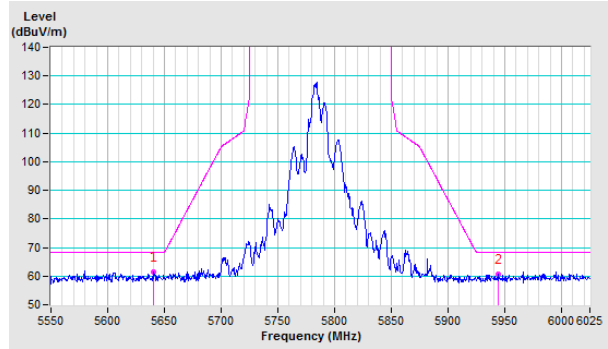

CH 165 5825 MHz

Horizontal

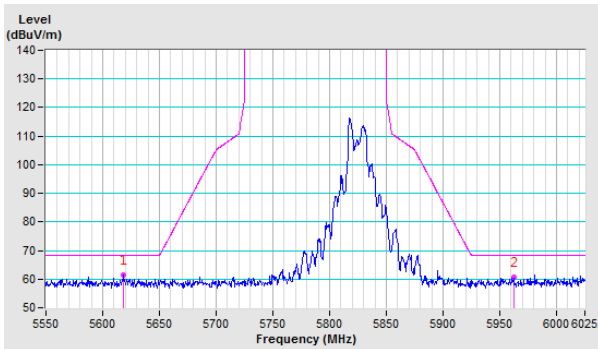

Vertical

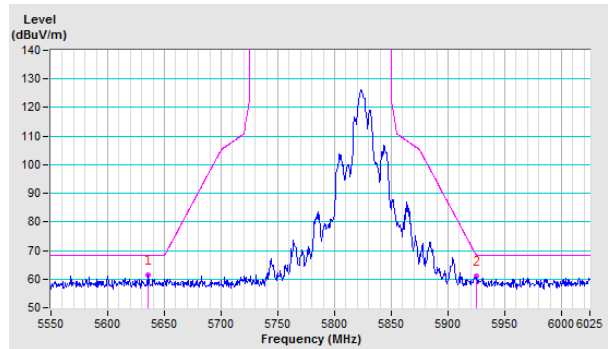

802.11ac (VHT40)

CH 151 5755 MHz

Horizontal

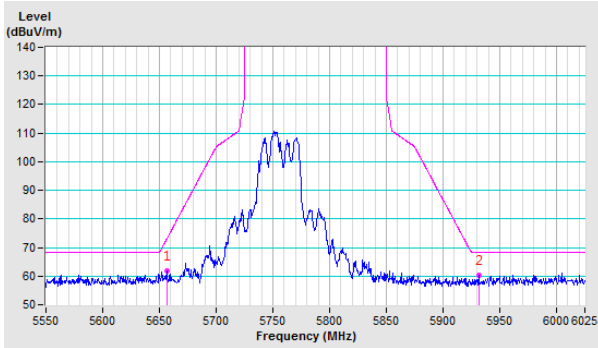

Vertical

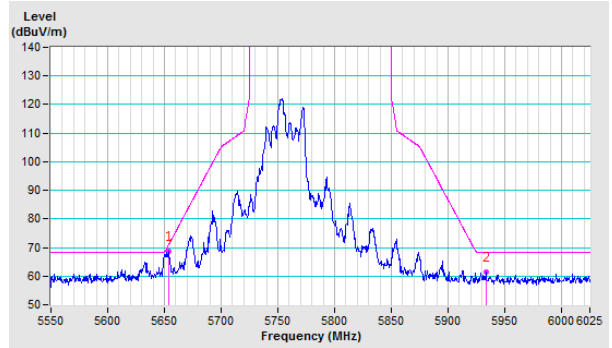

CH 159 5795 MHz

Horizontal

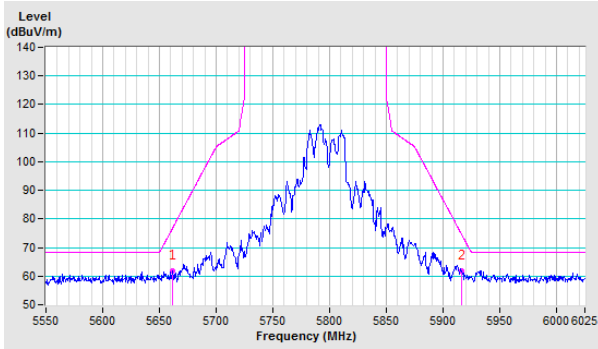

Vertical

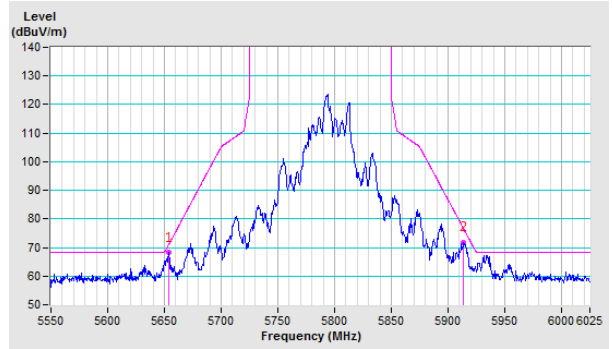

802.11ac (VHT80)

CH 155 5775 MHz

Horizontal

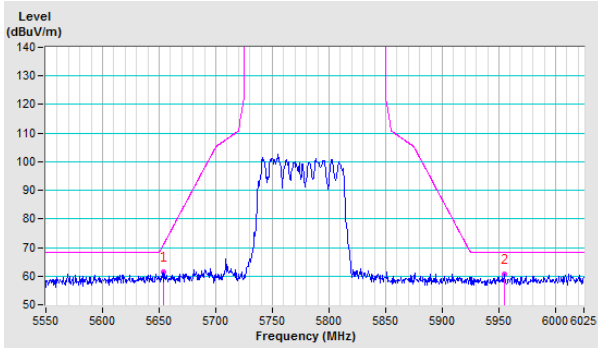

Vertical

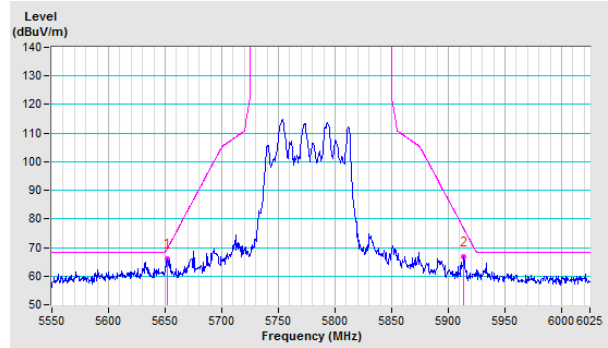

802.11ac (VHT80+80)

CH 42+155 5210+5775 MHz

Horizontal

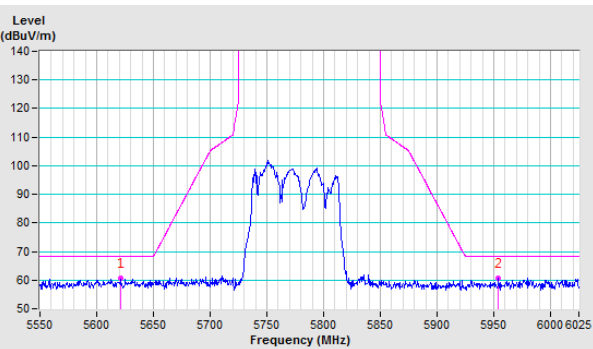

Vertical

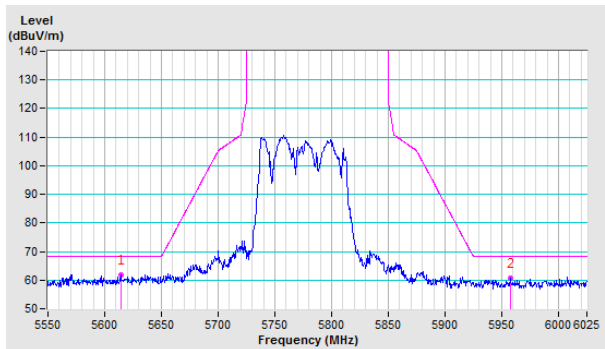

Appendix – Information on the Testing Laboratories

We, Bureau Veritas Consumer Products Services (H.K.) Ltd., Taoyuan Branch, were founded in 1988 to provide our best service in EMC, Radio, Telecom and Safety consultation. Our laboratories are FCC recognized accredited test firms and accredited according to ISO/IEC 17025.

If you have any comments, please feel free to contact us at the following:

Linko EMC/RF Lab

Tel: 886-2-26052180

Fax: 886-2-26051924

Hsin Chu EMC/RF/Telecom Lab

Tel: 886-3-6668565

Fax: 886-3-6668323

Hwa Ya EMC/RF/Safety Lab

Tel: 886-3-3183232

Fax: 886-3-3270892

Email: service.adt@tw.bureauveritas.com

Web Site: www.bureauveritas-adt.com

The address and road map of all our labs can be found in our web site also.

--- END ---