

## FCC Test Report (DFS Band)

**Report No.:** RF171011E02A-1

**FCC ID:** UXX-S5A750A

**Test Model:** S5A750A

**Received Date:** Oct. 13, 2017

**Test Date:** Nov. 28 to Dec. 08, 2017

**Issued Date:** Apr. 20, 2018

**Applicant:** Cradlepoint, Inc.

**Address:** 1111 W. Jefferson Street, Suite 400, Boise, ID 83702 USA

**Issued By:** Bureau Veritas Consumer Products Services (H.K.) Ltd., Taoyuan Branch  
Hsin Chu Laboratory

**Lab Address:** E-2, No.1, Li Hsin 1st Road, Hsinchu Science Park, Hsinchu City 300,  
Taiwan R.O.C.

**Test Location:** E-2, No.1, Li Hsin 1st Road, Hsinchu Science Park, Hsinchu City 300,  
Taiwan R.O.C.

**FCC Registration /  
Designation Number:** 723255 / TW2022



This report is for your exclusive use. Any copying or replication of this report to or for any other person or entity, or use of our name or trademark, is permitted only with our prior written permission. This report sets forth our findings solely with respect to the test samples identified herein. The results set forth in this report are not indicative or representative of the quality or characteristics of the lot from which a test sample was taken or any similar or identical product unless specifically and expressly noted. Our report includes all of the tests requested by you and the results thereof based upon the information that you provided to us. You have 60 days from date of issuance of this report to notify us of any material error or omission caused by our negligence, provided, however, that such notice shall be in writing and shall specifically address the issue you wish to raise. A failure to raise such issue within the prescribed time shall constitute your unqualified acceptance of the completeness of this report, the tests conducted and the correctness of the report contents. Unless specific mention, the uncertainty of measurement has been explicitly taken into account to declare the compliance or non-compliance to the specification. The report must not be used by the client to claim product certification, approval, or endorsement by TAF or any government agencies.

## Table of Contents

<b>Release Control Record</b> .....	<b>4</b>
<b>1 Certificate of Conformity</b> .....	<b>5</b>
<b>2 Summary of Test Results</b> .....	<b>6</b>
2.1 Measurement Uncertainty .....	6
2.2 Modification Record .....	6
<b>3 General Information</b> .....	<b>7</b>
3.1 General Description of EUT (DFS Band) .....	7
3.2 Description of Test Modes .....	10
3.2.1 Test Mode Applicability and Tested Channel Detail .....	11
3.3 Duty Cycle of Test Signal .....	14
3.4 Description of Support Units .....	16
3.4.1 Configuration of System under Test .....	17
3.5 General Description of Applied Standard .....	18
<b>4 Test Types and Results</b> .....	<b>19</b>
4.1 Radiated Emission and Bandedge Measurement .....	19
4.1.1 Limits of Radiated Emission and Bandedge Measurement .....	19
4.1.2 Test Instruments .....	20
4.1.3 Test Procedure .....	21
4.1.4 Deviation from Test Standard .....	21
4.1.5 Test Setup .....	22
4.1.6 EUT Operating Condition .....	23
4.1.7 Test Results (Mode 1) .....	24
4.1.8 Test Results (Mode 2) .....	45
4.2 Conducted Emission Measurement .....	66
4.2.1 Limits of Conducted Emission Measurement .....	66
4.2.2 Test Instruments .....	66
4.2.3 Test Procedure .....	67
4.2.4 Deviation from Test Standard .....	67
4.2.5 Test Setup .....	67
4.2.6 EUT Operating Condition .....	67
4.2.7 Test Results (Mode 1) .....	68
4.2.8 Test Results (Mode 2) .....	70
4.3 Transmit Power Measurement .....	72
4.3.1 Limits of Transmit Power Measurement .....	72
4.3.2 Test Setup .....	73
4.3.3 Test Instruments .....	73
4.3.4 Test Procedure .....	74
4.3.5 Deviation from Test Standard .....	74
4.3.6 EUT Operating Condition .....	74
4.3.7 Test Result (Mode 1) .....	75
4.3.8 Test Result (Mode 2) .....	85
4.4 Occupied Bandwidth Measurement .....	90
4.4.1 Test Setup .....	90
4.4.2 Test Instruments .....	90
4.4.3 Test Procedure .....	90
4.4.4 Test Results (Mode 1) .....	91
4.4.5 Test Results (Mode 2) .....	93
4.5 Peak Power Spectral Density Measurement .....	95
4.5.1 Limits of Peak Power Spectral Density Measurement .....	95
4.5.2 Test Setup .....	95
4.5.3 Test Instruments .....	95
4.5.4 Test Procedure .....	96
4.5.5 Deviation from Test Standard .....	96

4.5.6 EUT Operating Condition .....	96
4.5.7 Test Results (Mode 1).....	97
4.5.8 Test Results (Mode 2).....	100
4.6 Frequency Stability Measurement.....	103
4.6.1 Limits of Frequency Stability Measurement .....	103
4.6.2 Test Setup.....	103
4.6.3 Test Instruments .....	103
4.6.4 Test Procedure .....	103
4.6.5 Deviation from Test Standard .....	103
4.6.6 EUT Operating Condition .....	103
4.6.7 Test Results (Mode 1).....	104
4.6.8 Test Results (Mode 2).....	105
<b>5 Pictures of Test Arrangements.....</b>	<b>106</b>
<b>Appendix – Information on the Testing Laboratories .....</b>	<b>107</b>

### Release Control Record

Issue No.	Description	Date Issued
RF171011E02A-1	Original release.	Apr. 20, 2018

## 1 Certificate of Conformity

**Product:** WiFi Access Point

**Brand:** cradlepoint

**Test Model:** S5A750A

**Sample Status:** ENGINEERING SAMPLE

**Applicant:** Cradlepoint, Inc.

**Test Date:** Nov. 28 to Dec. 08, 2017

**Standard:** 47 CFR FCC Part 15, Subpart E (Section 15.407)  
ANSI C63.10: 2013

The above equipment has been tested by **Bureau Veritas Consumer Products Services (H.K.) Ltd., Taoyuan Branch**, and found compliance with the requirement of the above standards. The test record, data evaluation & Equipment Under Test (EUT) configurations represented herein are true and accurate accounts of the measurements of the sample's EMC characteristics under the conditions specified in this report.

**Prepared by :** Mary Ko , **Date:** Apr. 20, 2018  
Mary Ko / Specialist

**Approved by :** May Chen , **Date:** Apr. 20, 2018  
May Chen / Manager

## 2 Summary of Test Results

47 CFR FCC Part 15, Subpart E (Section 15.407)			
FCC Clause	Test Item	Result	Remarks
15.407(b)(6)	AC Power Conducted Emissions	Pass	Meet the requirement of limit. Minimum passing margin is -7.16dB at 0.15000MHz.
15.407(b) (1/2/3/4(i/ii)/6)	Radiated Emissions & Band Edge Measurement*	Pass	Meet the requirement of limit. Minimum passing margin is -0.1dB at 5350.00MHz, 5356.00MHz, 5456.00MHz, 5470.00MHz, 5725.00MHz.
15.407(a)(1/2/3)	Max Average Transmit Power	Pass	Meet the requirement of limit.
---	Occupied Bandwidth Measurement	-	Reference only.
15.407(a)(1/2/3)	Peak Power Spectral Density	Pass	Meet the requirement of limit.
15.407(g)	Frequency Stability	Pass	Meet the requirement of limit.
15.203	Antenna Requirement	Pass	Antenna connector is i-pex(MHF) not a standard connector.

### 2.1 Measurement Uncertainty

Where relevant, the following measurement uncertainty levels have been estimated for tests performed on the EUT as specified in CISPR 16-4-2:

Measurement	Frequency	Expanded Uncertainty (k=2) (±)
Conducted Emissions at mains ports	150kHz ~ 30MHz	1.84 dB
Radiated Emissions up to 1 GHz	30MHz ~ 1GHz	5.30 dB
Radiated Emissions above 1 GHz	1GHz ~ 6GHz	5.16 dB
	6GHz ~ 18GHz	4.91 dB
	18GHz ~ 40GHz	5.30 dB

### 2.2 Modification Record

There were no modifications required for compliance.

### 3 General Information

#### 3.1 General Description of EUT (DFS Band)

Product	WiFi Access Point
Brand	cradlepoint
Test Model	S5A750A
Status of EUT	ENGINEERING SAMPLE
Power Supply Rating	DC 48V from POE
Modulation Type	64QAM, 16QAM, QPSK, BPSK for OFDM 256QAM for OFDM in 11ac mode only
Modulation Technology	OFDM
Transfer Rate	802.11a: up to 11Mbps 802.11n: up to 300Mbps 802.11ac: up to 866.7Mbps
Operating Frequency	5.26GHz ~ 5.32GHz, 5.50GHz ~ 5.70GHz
Number of Channel	802.11a, 802.11n (HT20), 802.11ac (VHT20): 15 802.11n (HT40), 802.11ac (VHT40): 7 802.11ac (VHT80): 3
Output Power	<b>Radio 2</b> <b>5.26 ~ 5.32GHz:</b> <b>CDD Mode:</b> 187.485mW <b>Beamforming Mode:</b> 109.175mW <b>5.50 ~ 5.70GHz:</b> <b>CDD Mode:</b> 196.249mW <b>Beamforming Mode:</b> 104.748mW <b>Radio 3</b> <b>5.26 ~ 5.32GHz:</b> 56.624mW <b>5.50 ~ 5.70GHz:</b> 66.374mW
Antenna Type	Refer to Note
Antenna Connector	Refer to Note
Accessory Device	NA
Data Cable Supplied	NA

Note:

- This report is prepared for FCC class II permissive change. The difference compared with the Report No.: RF171011E02 as the following:
  - ◆ Add DFS band <5.26 ~ 5.32GHz, 5.50 ~ 5.70GHz>
- According to above condition, all test items need to be performed. And all data weres verified to meet the requirements.
- The EUT has three radios as following table:

Radio 1	Radio 2	Radio 3
WLAN - 2.4GHz	WLAN - 5GHz	WLAN - 2.4GHz+5 GHz

4. Simultaneously transmission condition.

Condition	Technology		
1	WLAN (Radio 1) (2.4GHz-2TX)	WLAN (Radio 2) (5GHz-2TX)	WLAN (Radio 3) (5GHz-1TX)
2	WLAN (Radio 1) (2.4GHz-2TX)	WLAN (Radio 2) (5GHz-2TX)	WLAN (Radio 3) (2.4GHz-1TX)

**Note:** The emission of the simultaneous operation has been evaluated and no non-compliance was found.

5. The antennas provided to the EUT, please refer to the following table:

Antenna No.	Antenna Net Gain (dBi)	Frequency Range (GHz)	Antenna Type	Connector Type
1 (Radio 1, 2)	5.19	2.4~2.4835	PIFA	i-pex(MHF)
	4.81	5.15~5.25		
	5.91	5.25~5.35		
	4.90	5.47~5.725		
	6.69	5.725~5.85		
2 (Radio 1, 2)	3.04	2.4~2.4835	PIFA	i-pex(MHF)
	7.37	5.15~5.25		
	6.90	5.25~5.35		
	6.65	5.47~5.725		
3 (Radio 3)	6.89	5.725~5.85	PIFA	i-pex(MHF)
	3.89	2.4~2.4835		
	6.58	5.15~5.25		
	6.87	5.25~5.35		
	6.27	5.47~5.725		
	7.01	5.725~5.85		



6. The EUT incorporates a MIMO function:

2.4GHz Band (Radio 1)			
MODULATION MODE	DATA RATE (MCS)	TX & RX CONFIGURATION	
802.11b	1 ~ 11Mbps	2TX	2RX
802.11g	6 ~ 54Mbps	2TX	2RX
802.11n (HT20)	MCS 0~7	2TX	2RX
	MCS 8~15	2TX	2RX
802.11n (HT40)	MCS 0~7	2TX	2RX
	MCS 8~15	2TX	2RX
5GHz Band (Radio 2)			
MODULATION MODE	DATA RATE (MCS)	TX & RX CONFIGURATION	
802.11a	6 ~ 54Mbps	2TX	2RX
802.11n (HT20)	MCS 0~7	2TX	2RX
	MCS 8~15	2TX	2RX
802.11n (HT40)	MCS 0~7	2TX	2RX
	MCS 8~15	2TX	2RX
802.11ac (VHT20)	MCS0~8 Nss=1	2TX	2RX
	MCS0~8 Nss=2	2TX	2RX
802.11ac (VHT40)	MCS0~9 Nss=1	2TX	2RX
	MCS0~9 Nss=2	2TX	2RX
802.11ac (VHT80)	MCS0~9 Nss=1	2TX	2RX
	MCS0~9 Nss=2	2TX	2RX
2.4GHz Band (Radio 3)			
MODULATION MODE	DATA RATE (MCS)	TX & RX CONFIGURATION	
802.11b	1 ~ 11Mbps	1TX	1RX
802.11g	6 ~ 54Mbps	1TX	1RX
802.11n (HT20)	MCS 0~7	1TX	1RX
802.11n (HT40)	MCS 0~7	1TX	1RX
5GHz Band (Radio 3)			
MODULATION MODE	DATA RATE (MCS)	TX & RX CONFIGURATION	
802.11a	6 ~ 54Mbps	1TX	1RX
802.11n (HT20)	MCS 0~7	1TX	1RX
802.11n (HT40)	MCS 0~7	1TX	1RX
802.11ac (VHT20)	MCS 0~8, Nss=1	1TX	1RX
802.11ac (VHT40)	MCS 0~9, Nss=1	1TX	1RX
802.11ac (VHT80)	MCS 0~9, Nss=1	1TX	1RX

Note:

- All of modulation mode support beamforming function except 802.11a/b/g modulation mode.
- The EUT support Beamforming and CDD mode, therefore both mode were investigated and the worst case scenario was identified. The worst case data were presented in test report.
- The modulation and bandwidth are similar for 802.11n mode for 20MHz (40MHz) and 802.11ac mode for 20MHz (40MHz), therefore investigated worst case to representative mode in test report. (Final test mode refer section 3.2.1)

7. This device can support access point mode and client mode, please refer to the following table:

	Radio 2	Radio 3
Device Type	access point mode	client mode

8. The above EUT information is declared by manufacturer and for more detailed features description, please refer to the manufacturer's specifications or user's manual.

### 3.2 Description of Test Modes

#### FOR 5260 ~ 5320MHz

4 channels are provided for 802.11a, 802.11n (HT20), 802.11ac (VHT20):

Channel	Frequency	Channel	Frequency
52	5260 MHz	60	5300 MHz
56	5280 MHz	64	5320 MHz

2 channels are provided for 802.11n (HT40), 802.11ac (VHT40):

Channel	Frequency	Channel	Frequency
54	5270 MHz	62	5310 MHz

1 channel is provided for 802.11ac (VHT80):

Channel	Frequency
58	5290 MHz

#### FOR 5500 ~ 5700MHz

11 channels are provided for 802.11a, 802.11n (HT20), 802.11ac (VHT20):

Channel	Frequency	Channel	Frequency
100	5500 MHz	124	5620 MHz
104	5520 MHz	128	5640 MHz
108	5540 MHz	132	5660 MHz
112	5560 MHz	136	5680 MHz
116	5580 MHz	140	5700 MHz
120	5600 MHz		

5 channels are provided for 802.11n (HT40), 802.11ac (VHT40):

Channel	Frequency	Channel	Frequency
102	5510 MHz	126	5630 MHz
110	5550 MHz	134	5670 MHz
118	5590 MHz		

2 channels are provided for 802.11ac (VHT80):

Channel	Frequency	Channel	Frequency
106	5530 MHz	122	5610 MHz

### 3.2.1 Test Mode Applicability and Tested Channel Detail

EUT Configure Mode	Applicable To				Description
	RE $\geq$ 1G	RE $<$ 1G	PLC	APCM	
1	√	√	√	√	Radio 2
2	√	√	√	√	Radio 3

Where **RE $\geq$ 1G**: Radiated Emission above 1GHz      **RE $<$ 1G**: Radiated Emission below 1GHz  
**PLC**: Power Line Conducted Emission      **APCM**: Antenna Port Conducted Measurement

**NOTE:**

1. The EUT had been pre-tested on the positioned of each 2 axis. The worst case was found when positioned on **Y-plane**.

#### **Radiated Emission Test (Above 1GHz):**

- Pre-Scan has been conducted to determine the worst-case mode from all possible combinations between available modulations, data rates and antenna ports (if EUT with antenna diversity architecture).
- Following channel(s) was (were) selected for the final test as listed below.

CDD Mode - Radio 2						
Mode	FREQ. Band (MHz)	Available Channel	Tested Channel	Modulation Technology	Modulation Type	Data Rate (Mbps)
802.11a	5260-5320	52 to 64	52, 60, 64	OFDM	BPSK	6
802.11ac (VHT20)		52 to 64	52, 60, 64	OFDM	BPSK	6.5
802.11ac (VHT40)		54 to 62	54, 62	OFDM	BPSK	13.5
802.11ac (VHT80)		58	58	OFDM	BPSK	29.3
802.11a	5500-5700	100 to 140	100, 116, 140	OFDM	BPSK	6
802.11ac (VHT20)		100 to 140	100, 116, 140	OFDM	BPSK	6.5
802.11ac (VHT40)		102 to 134	102, 110, 134	OFDM	BPSK	13.5
802.11ac (VHT80)		106 to 122	106, 122	OFDM	BPSK	29.3
Radio 3						
Mode	FREQ. Band (MHz)	Available Channel	Tested Channel	Modulation Technology	Modulation Type	Data Rate (Mbps)
802.11a	5260-5320	52 to 64	52, 60, 64	OFDM	BPSK	6
802.11ac (VHT20)		52 to 64	52, 60, 64	OFDM	BPSK	6.5
802.11ac (VHT40)		54 to 62	54, 62	OFDM	BPSK	13.5
802.11ac (VHT80)		58	58	OFDM	BPSK	29.3
802.11a	5500-5700	100 to 140	100, 116, 140	OFDM	BPSK	6
802.11ac (VHT20)		100 to 140	100, 116, 140	OFDM	BPSK	6.5
802.11ac (VHT40)		102 to 134	102, 110, 134	OFDM	BPSK	13.5
802.11ac (VHT80)		106 to 122	106, 122	OFDM	BPSK	29.3

### Radiated Emission Test (Below 1GHz):

- Pre-Scan has been conducted to determine the worst-case mode from all possible combinations between available modulations, data rates and antenna ports (if EUT with antenna diversity architecture).
- Following channel(s) was (were) selected for the final test as listed below.

CDD Mode – Radio 2						
Mode	FREQ. Band (MHz)	Available Channel	Tested Channel	Modulation Technology	Modulation Type	Data Rate (Mbps)
802.11ac (VHT40)	5260-5320 5500-5700	54 to 62 102 to 134	54	OFDM	BPSK	13.5
Radio 3						
Mode	FREQ. Band (MHz)	Available Channel	Tested Channel	Modulation Technology	Modulation Type	Data Rate (Mbps)
802.11a	5260-5320 5500-5700	52 to 64 100 to 140	100	OFDM	BPSK	6

### Power Line Conducted Emission Test:

- Pre-Scan has been conducted to determine the worst-case mode from all possible combinations between available modulations, data rates and antenna ports (if EUT with antenna diversity architecture).
- Following channel(s) was (were) selected for the final test as listed below.

CDD Mode – Radio 2						
Mode	FREQ. Band (MHz)	Available Channel	Tested Channel	Modulation Technology	Modulation Type	Data Rate (Mbps)
802.11ac (VHT40)	5260-5320 5500-5700	54 to 62 102 to 134	54	OFDM	BPSK	13.5
Radio 3						
Mode	FREQ. Band (MHz)	Available Channel	Tested Channel	Modulation Technology	Modulation Type	Data Rate (Mbps)
802.11a	5260-5320 5500-5700	52 to 64 100 to 140	100	OFDM	BPSK	6

### Antenna Port Conducted Measurement:

- This item includes all test value of each mode, but only includes spectrum plot of worst value of each mode.
- Pre-Scan has been conducted to determine the worst-case mode from all possible combinations between available modulations, data rates and antenna ports (if EUT with antenna diversity architecture).
- Following channel(s) was (were) selected for the final test as listed below.

<b>CDD Mode – Radio 2</b>						
Mode	FREQ. Band (MHz)	Available Channel	Tested Channel	Modulation Technology	Modulation Type	Data Rate (Mbps)
802.11a	5260-5320	52 to 64	52, 60, 64	OFDM	BPSK	6
802.11ac (VHT20)		52 to 64	52, 60, 64	OFDM	BPSK	6.5
802.11ac (VHT40)		54 to 62	54, 62	OFDM	BPSK	13.5
802.11ac (VHT80)		58	58	OFDM	BPSK	29.3
802.11a	5500-5700	100 to 140	100, 116, 140	OFDM	BPSK	6
802.11ac (VHT20)		100 to 140	100, 116, 140	OFDM	BPSK	6.5
802.11ac (VHT40)		102 to 134	102, 110, 134	OFDM	BPSK	13.5
802.11ac (VHT80)		106 to 122	106, 122	OFDM	BPSK	29.3
<b>Beamforming Mode (Output power only) – Radio 2</b>						
Mode	FREQ. Band (MHz)	Available Channel	Tested Channel	Modulation Technology	Modulation Type	Data Rate (Mbps)
802.11ac (VHT20)	5260-5320	52 to 64	52, 60, 64	OFDM	BPSK	6.5
802.11ac (VHT40)		54 to 62	54, 62	OFDM	BPSK	13.5
802.11ac (VHT80)		58	58	OFDM	BPSK	29.3
802.11ac (VHT20)	5500-5700	100 to 140	100, 116, 140	OFDM	BPSK	6.5
802.11ac (VHT40)		102 to 134	102, 110, 134	OFDM	BPSK	13.5
802.11ac (VHT80)		106 to 122	106, 122	OFDM	BPSK	29.3
<b>Radio 3</b>						
Mode	FREQ. Band (MHz)	Available Channel	Tested Channel	Modulation Technology	Modulation Type	Data Rate (Mbps)
802.11a	5260-5320	52 to 64	52, 60, 64	OFDM	BPSK	6
802.11ac (VHT20)		52 to 64	52, 60, 64	OFDM	BPSK	6.5
802.11ac (VHT40)		54 to 62	54, 62	OFDM	BPSK	13.5
802.11ac (VHT80)		58	58	OFDM	BPSK	29.3
802.11a	5500-5700	100 to 140	100, 116, 140	OFDM	BPSK	6
802.11ac (VHT20)		100 to 140	100, 116, 140	OFDM	BPSK	6.5
802.11ac (VHT40)		102 to 134	102, 110, 134	OFDM	BPSK	13.5
802.11ac (VHT80)		106 to 122	106, 122	OFDM	BPSK	29.3

### Test Condition:

Applicable To	Environmental Conditions	Input Power	Tested By
RE≥1G	22deg. C, 64%RH	120Vac, 60Hz	Rey Chen
RE<1G	25deg. C, 64%RH	120Vac, 60Hz	Rey Chen
PLC	25deg. C, 58%RH	120Vac, 60Hz	Andy Ho
APCM	25deg. C, 60%RH	120Vac, 60Hz	Robert Cheng

### 3.3 Duty Cycle of Test Signal

#### Radio 2

If duty cycle of test signal is  $\geq 98\%$ , duty factor is not required.

If duty cycle of test signal is  $< 98\%$ , duty factor shall be considered.

**802.11a:** Duty cycle =  $2.104 \text{ ms} / 2.14 \text{ ms} = 0.983$

**802.11ac (VHT20):** Duty cycle =  $4.97 \text{ ms} / 5.054 \text{ ms} = 0.983$

**802.11ac (VHT40):** Duty cycle =  $2.41 \text{ ms} / 2.499 \text{ ms} = 0.964$ , Duty factor =  $10 * \log(1/0.964) = 0.16$

**802.11ac (VHT80):** Duty cycle =  $1.134 \text{ ms} / 1.212 \text{ ms} = 0.936$ , Duty factor =  $10 * \log(1/0.936) = 0.29$

#### 802.11a

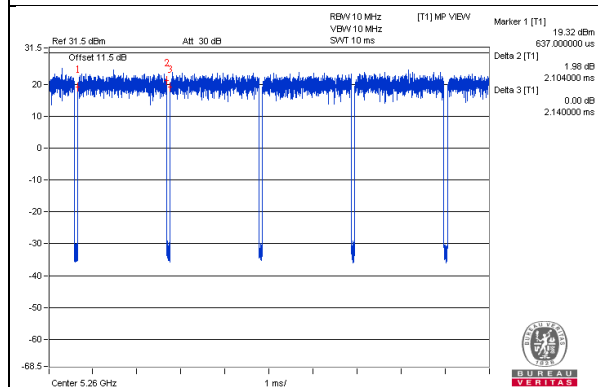

#### 802.11ac (VHT20)

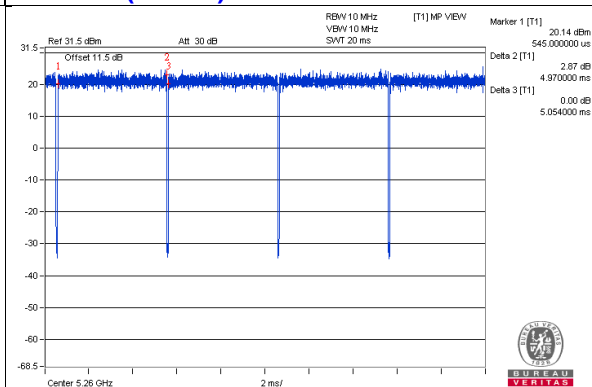

#### 802.11ac (VHT40)

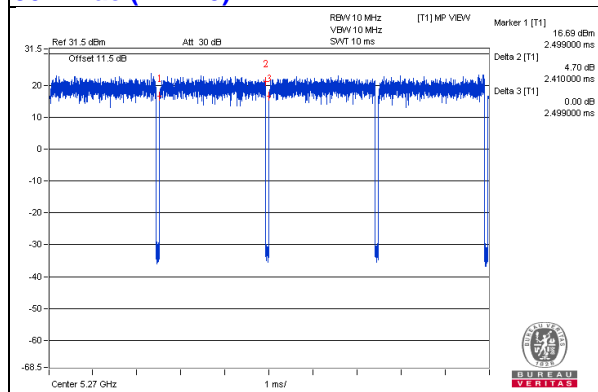

#### 802.11ac (VHT80)

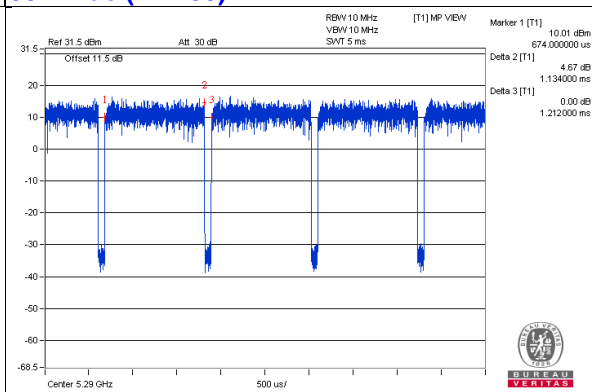

### Radio 3

If duty cycle of test signal is < 98%, duty factor shall be considered.

**802.11a:** Duty cycle = 2.004 ms/2.083 ms = 0.962, Duty factor =  $10 * \log(1/0.962) = 0.17$

**802.11ac (VHT20):** Duty cycle = 1.874 ms/1.95 ms = 0.961, Duty factor =  $10 * \log(1/0.961) = 0.17$

**802.11ac (VHT40):** Duty cycle = 0.926 ms/1 ms = 0.926, Duty factor =  $10 * \log(1/0.926) = 0.33$

**802.11ac (VHT80):** Duty cycle = 0.449 ms/0.528 ms = 0.85, Duty factor =  $10 * \log(1/0.85) = 0.7$

**802.11a**

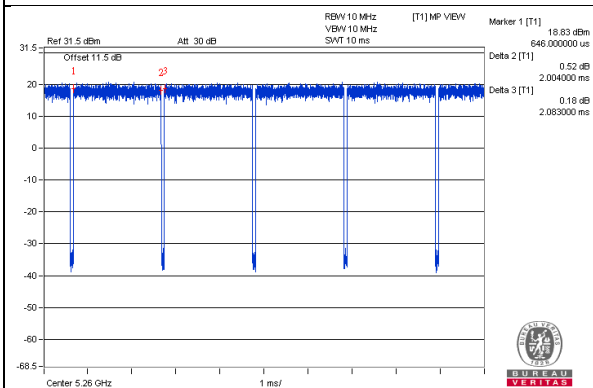

**802.11ac (VHT20)**

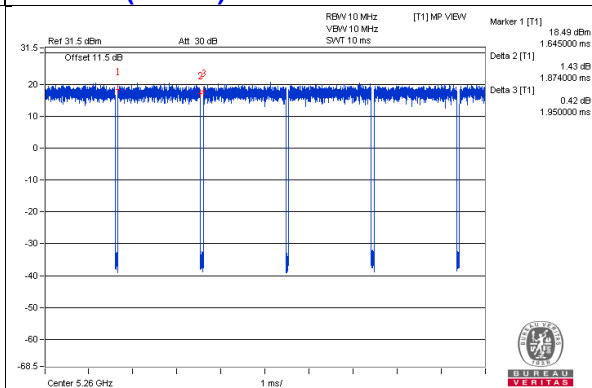

**802.11ac (VHT40)**

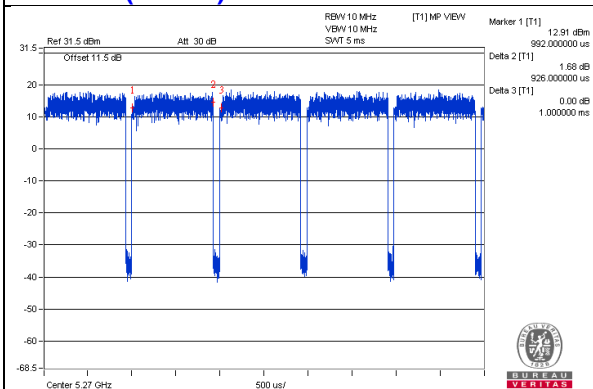

**802.11ac (VHT80)**

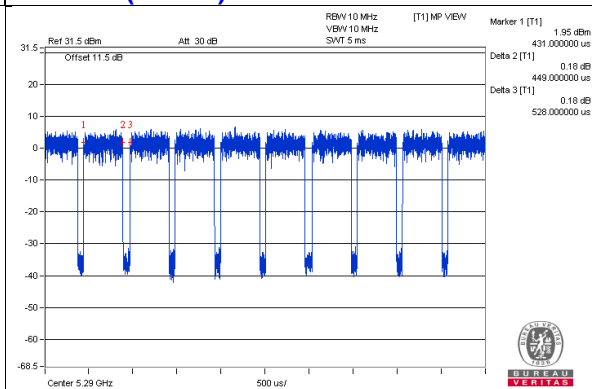

### 3.4 Description of Support Units

The EUT has been tested as an independent unit together with other necessary accessories or support units. The following support units or accessories were used to form a representative test configuration during the tests.

ID	Product	Brand	Model No.	Serial No.	FCC ID	Remarks
A.	Laptop	HP	Pavilion 14-ab023TU	5CD5340WXZ	NA	Provided by Lab
B.	POE	ELECTRONICS	PGSA20D01-480035	NA	NA	Supplied by client
C.	iPod	Apple	MD778TA/A	CC4JMH7LF4T1	NA	Provided by Lab

Note:

1. All power cords of the above support units are non-shielded (1.8m).

ID	Descriptions	Qty.	Length (m)	Shielding (Yes/No)	Cores (Qty.)	Remarks
1.	RJ-45 Cable	1	10	No	0	Provided by Lab
2.	RJ-45 Cable	1	3	No	0	Provided by Lab
3.	USB Cable	1	0.1	Yes	0	Provided by Lab



### 3.4.1 Configuration of System under Test

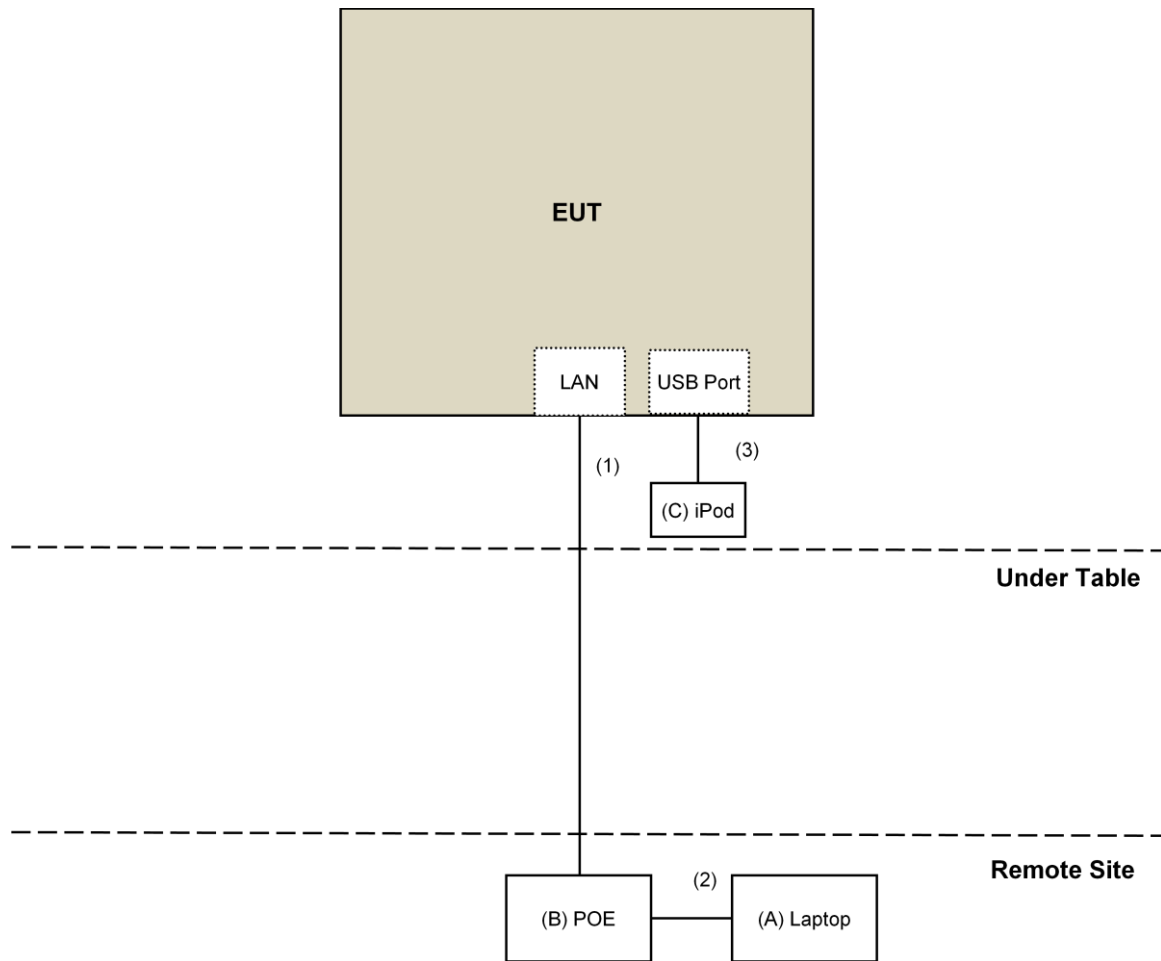

### 3.5 General Description of Applied Standard

The EUT is a RF Product. According to the specifications of the manufacturer, it must comply with the requirements of the following standards:

**FCC Part 15, Subpart E (15.407)**  
**KDB 789033 D02 General UNII Test Procedure New Rules v02r01**  
**KDB 662911 D01 Multiple Transmitter Output v02r01**  
**ANSI C63.10-2013**

All test items have been performed and recorded as per the above standards.

**NOTE:** The EUT has been verified to comply with the requirements of FCC Part 15, Subpart B, Class B (DoC). The test report has been issued separately.

## 4 Test Types and Results

### 4.1 Radiated Emission and Bandedge Measurement

#### 4.1.1 Limits of Radiated Emission and Bandedge Measurement

Radiated emissions which fall in the restricted bands must comply with the radiated emission limits specified as below table.

Frequencies (MHz)	Field Strength (microvolts/meter)	Measurement Distance (meters)
0.009 ~ 0.490	2400/F(kHz)	300
0.490 ~ 1.705	24000/F(kHz)	30
1.705 ~ 30.0	30	30
30 ~ 88	100	3
88 ~ 216	150	3
216 ~ 960	200	3
Above 960	500	3

#### NOTE:

- The lower limit shall apply at the transition frequencies.
- Emission level (dBuV/m) = 20 log Emission level (uV/m).
- For frequencies above 1000MHz, the field strength limits are based on average detector, however, the peak field strength of any emission shall not exceed the maximum permitted average limits, specified above by more than 20dB under any condition of modulation.

Limits of unwanted emission out of the restricted bands

Applicable To		Limit	
789033 D02 General UNII Test Procedure New Rules v2r01		Field Strength at 3m	
		PK:74 (dBuV/m)	AV:54 (dBuV/m)
Frequency Band	Applicable To	EIRP Limit	Equivalent Field Strength at 3m
5150~5250 MHz	15.407(b)(1)	PK:-27 (dBm/MHz)	PK:68.2(dBuV/m)
5250~5350 MHz	15.407(b)(2)		
5470~5725 MHz	15.407(b)(3)		
5725~5850 MHz	<input checked="" type="checkbox"/> 15.407(b)(4)(i)	PK:-27 (dBm/MHz) <sup>*1</sup> PK:10 (dBm/MHz) <sup>*2</sup> PK:15.6 (dBm/MHz) <sup>*3</sup> PK:27 (dBm/MHz) <sup>*4</sup>	PK: 68.2(dBuV/m) <sup>*1</sup> PK:105.2 (dBuV/m) <sup>*2</sup> PK: 110.8(dBuV/m) <sup>*3</sup> PK:122.2 (dBuV/m) <sup>*4</sup>
	<input type="checkbox"/> 15.407(b)(4)(ii)	Emission limits in section 15.247(d)	
<sup>*1</sup> beyond 75 MHz or more above of the band edge.		<sup>*2</sup> below the band edge increasing linearly to 10 dBm/MHz at 25 MHz above.	
<sup>*3</sup> below the band edge increasing linearly to a level of 15.6 dBm/MHz at 5 MHz above.		<sup>*4</sup> from 5 MHz above or below the band edge increasing linearly to a level of 27 dBm/MHz at the band edge.	

#### Note:

The following formula is used to convert the equipment isotropic radiated power (eirp) to field strength:

$$E = \frac{1000000\sqrt{30P}}{3} \mu\text{V/m, where } P \text{ is the eirp (Watts).}$$

## 4.1.2 Test Instruments

DESCRIPTION & MANUFACTURER	MODEL NO.	SERIAL NO.	CALIBRATED DATE	CALIBRATED UNTIL
Test Receiver Keysight	N9038A	MY54450088	July 08, 2017	July 07, 2018
Pre-Amplifier <sup>(*)</sup> EMCI	EMC001340	980142	Jan. 20, 2016	Jan. 19, 2018
Loop Antenna <sup>(*)</sup> Electro-Metrics	EM-6879	264	Dec. 16, 2016	Dec. 15, 2018
RF Cable	NA	LOOPCAB-001 LOOPCAB-002	Jan. 17, 2017	Jan. 16, 2018
Pre-Amplifier Mini-Circuits	ZFL-1000VH2B	AMP-ZFL-01	Nov. 09, 2017	Nov. 08, 2018
Trilog Broadband Antenna SCHWARZBECK	VULB 9168	9168-406	Dec. 13, 2016	Dec. 12, 2017
RF Cable	8D	966-4-1 966-4-2 966-4-3	Apr. 01, 2017	Mar. 31, 2018
Fixed attenuator Mini-Circuits	UNAT-5+	PAD-3m-4-01	Oct. 03, 2017	Oct. 02, 2018
Horn_Antenna SCHWARZBECK	BBHA 9120D	9120D-783	Dec. 27, 2016	Dec. 26, 2017
Pre-Amplifier EMCI	EMC12630SE	980385	Feb. 02, 2017	Feb. 01, 2018
RF Cable	EMC104-SM-SM-1200 EMC104-SM-SM-2000 EMC104-SM-SM-5000	160923 150318 150321	Feb. 02, 2017 Mar. 29, 2017 Mar. 29, 2017	Feb. 01, 2018 Mar. 28, 2018 Mar. 28, 2018
Pre-Amplifier EMCI	EMC184045SE	980387	Feb. 02, 2017	Feb. 01, 2018
Horn_Antenna SCHWARZBECK	BBHA 9170	BBHA9170608	Dec. 15, 2016	Dec. 14, 2017
RF Cable	SUCOFLEX 102	36432/2 36433/2	Jan. 15, 2017	Jan. 14, 2018
Software	ADT_Radiated_V8.7.08	NA	NA	NA
Antenna Tower & Turn Table Max-Full	MF-7802	MF780208410	NA	NA
Boresight Antenna Fixture	FBA-01	FBA-SIP02	NA	NA
Spectrum Analyzer R&S	FSV40	100964	July 1, 2017	June 30, 2018
Power meter Anritsu	ML2495A	1014008	May 11, 2017	May 10, 2018
Power sensor Anritsu	MA2411B	0917122	May 11, 2017	May 10, 2018
AC Power Source Extech Electronics	6205	1440452	NA	NA
Temperature & Humidity Chamber Giant Force	GTH-150-40-SP-AR	MAA0812-008	Jan. 11, 2017	Jan. 10, 2018
True RMS Clamp Meter FLUKE	325	31130711WS	May 29, 2017	May 28, 2018

**Note:**

1. The calibration interval of the above test instruments is 12 months and the calibrations are traceable to NML/ROC and NIST/USA.
2. \*The calibration interval of the above test instruments is 24 months and the calibrations are traceable to NML/ROC and NIST/USA.
3. The test was performed in 966 Chamber No. 4.
4. The CANADA Site Registration No. is 20331-2
5. Loop antenna was used for all emissions below 30 MHz.
6. Tested Date: Nov. 28 to Dec. 05, 2017.

#### 4.1.3 Test Procedure

##### **For Radiated emission below 30MHz**

- a. The EUT was placed on the top of a rotating table 0.8 meters above the ground at a 3 meter chamber room. The table was rotated 360 degrees to determine the position of the highest radiation.
- b. The EUT was set 3 meters away from the interference-receiving antenna, which was mounted on the top of a variable-height antenna tower.
- c. Both X and Y axes of the antenna are set to make the measurement.
- d. For each suspected emission, the EUT was arranged to its worst case and the rotatable table was turned from 0 degrees to 360 degrees to find the maximum reading.
- e. The test-receiver system was set to Quasi-Peak Detect Function and Specified Bandwidth with Maximum Hold Mode.

##### **NOTE:**

1. The resolution bandwidth and video bandwidth of test receiver/spectrum analyzer is 9kHz at frequency below 30MHz.

##### **For Radiated emission above 30MHz**

- a. The EUT was placed on the top of a rotating table 0.8 meters (for 30MHz ~ 1GHz) / 1.5 meters (for above 1GHz) above the ground at 3 meter chamber room for test. The table was rotated 360 degrees to determine the position of the highest radiation.
- b. The EUT was set 3 meters away from the interference-receiving antenna, which was mounted on the top of a variable-height antenna tower.
- c. The height of antenna is varied from one meter to four meters above the ground to determine the maximum value of the field strength. Both horizontal and vertical polarizations of the antenna are set to make the measurement.
- d. For each suspected emission, the EUT was arranged to its worst case and then the antenna was tuned to heights from 1 meter to 4 meters and the rotatable table was turned from 0 degrees to 360 degrees to find the maximum reading.
- e. The test-receiver system was set to quasi-peak detect function and specified bandwidth with maximum hold mode when the test frequency is below 1 GHz.
- f. The test-receiver system was set to peak and average detect function and specified bandwidth with maximum hold mode when the test frequency is above 1 GHz. If the peak reading value also meets average limit, measurement with the average detector is unnecessary.

##### **Note:**

1. The resolution bandwidth and video bandwidth of test receiver/spectrum analyzer is 120kHz for Quasi-peak detection (QP) at frequency below 1GHz.
2. The resolution bandwidth of test receiver/spectrum analyzer is 1 MHz and the video bandwidth is 3 MHz for Peak detection (PK) at frequency above 1GHz.
3. The resolution bandwidth of test receiver/spectrum analyzer is 1MHz and the video bandwidth is  $\geq 1/T$  (Duty cycle < 98%) or 10Hz (Duty cycle  $\geq 98\%$ ) for Average detection (AV) at frequency above 1GHz.
4. All modes of operation were investigated and the worst-case emissions are reported.

#### 4.1.4 Deviation from Test Standard

No deviation.

#### 4.1.5 Test Setup

##### For Radiated emission below 30MHz

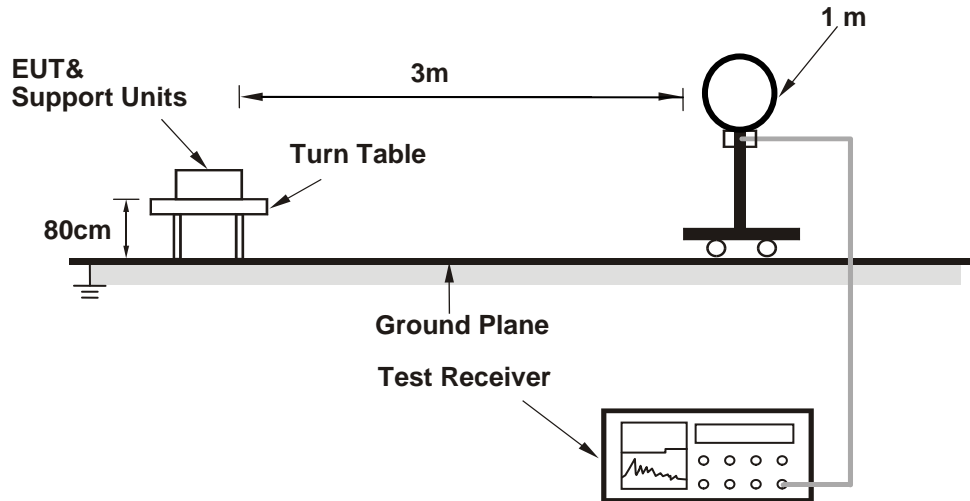

##### For Radiated emission 30MHz to 1GHz

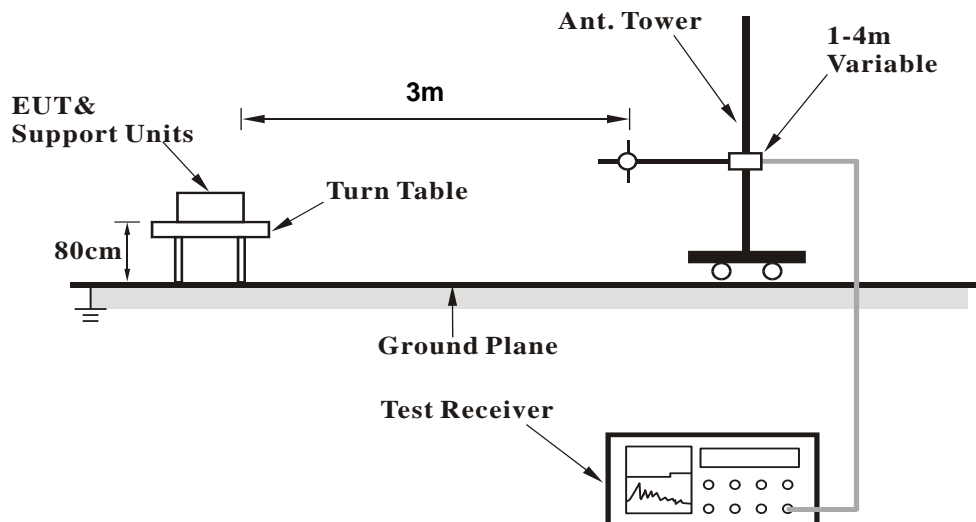

### For Radiated emission above 1GHz

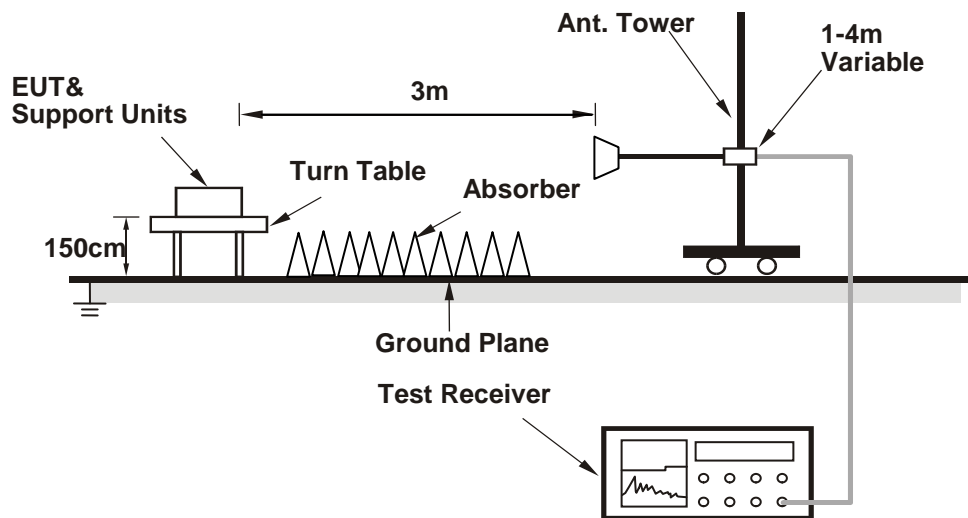

For the actual test configuration, please refer to the attached file (Test Setup Photo).

#### 4.1.6 EUT Operating Condition

- a. Connected the EUT with the Laptop which is placed on remote site.
- b. Controlling software (QRCT.EXE[Version3.0.264.0]) has been activated to set the EUT on specific status.

## 4.1.7 Test Results (Mode 1)

## Above 1GHz Data:

## 802.11a

<b>CHANNEL</b>	TX Channel 52	<b>DETECTOR FUNCTION</b>	Peak (PK)
<b>FREQUENCY RANGE</b>	1GHz ~ 40GHz		Average (AV)

ANTENNA POLARITY & TEST DISTANCE: HORIZONTAL AT 3 M								
NO.	FREQ. (MHz)	EMISSION LEVEL (dBuV/m)	LIMIT (dBuV/m)	MARGIN (dB)	ANTENNA HEIGHT (m)	TABLE ANGLE (Degree)	RAW VALUE (dBuV)	CORRECTION FACTOR (dB/m)
1	5136.00	51.0 PK	74.0	-23.0	1.42 H	23	47.0	4.0
2	5136.00	38.5 AV	54.0	-15.5	1.42 H	23	34.5	4.0
3	*5260.00	116.6 PK			1.42 H	23	112.4	4.2
4	*5260.00	106.6 AV			1.42 H	23	102.4	4.2
5	#10520.00	48.7 PK	74.0	-25.3	1.00 H	36	34.9	13.8
6	#10520.00	36.9 AV	54.0	-17.1	1.00 H	36	23.1	13.8
7	15780.00	49.3 PK	74.0	-24.7	1.00 H	322	35.2	14.1
8	15780.00	36.5 AV	54.0	-17.5	1.00 H	322	22.4	14.1

ANTENNA POLARITY & TEST DISTANCE: VERTICAL AT 3 M								
NO.	FREQ. (MHz)	EMISSION LEVEL (dBuV/m)	LIMIT (dBuV/m)	MARGIN (dB)	ANTENNA HEIGHT (m)	TABLE ANGLE (Degree)	RAW VALUE (dBuV)	CORRECTION FACTOR (dB/m)
1	5136.00	52.0 PK	74.0	-22.0	2.30 V	0	48.0	4.0
2	5136.00	39.5 AV	54.0	-14.5	2.30 V	0	35.5	4.0
3	*5260.00	117.2 PK			2.30 V	0	113.0	4.2
4	*5260.00	107.3 AV			2.30 V	0	103.1	4.2
5	#10520.00	52.1 PK	74.0	-21.9	1.44 V	18	38.3	13.8
6	#10520.00	38.9 AV	54.0	-15.1	1.44 V	18	25.1	13.8
7	15780.00	53.8 PK	74.0	-20.2	2.39 V	342	39.7	14.1
8	15780.00	41.9 AV	54.0	-12.1	2.39 V	342	27.8	14.1

## REMARKS:

- Emission Level(dBuV/m) = Raw Value(dBuV) + Correction Factor(dB/m)
- Correction Factor(dB/m) = Antenna Factor(dB/m) + Cable Factor(dB) – Pre-Amplifier Factor(dB)
- The other emission levels were very low against the limit.
- Margin value = Emission Level – Limit value
- " \* ": Fundamental frequency.
- " # ": The radiated frequency is out of the restricted band.



<b>CHANNEL</b>	TX Channel 60	<b>DETECTOR FUNCTION</b>	Peak (PK)
<b>FREQUENCY RANGE</b>	1GHz ~ 40GHz		Average (AV)

**ANTENNA POLARITY & TEST DISTANCE: HORIZONTAL AT 3 M**

NO.	FREQ. (MHz)	EMISSION LEVEL (dBuV/m)	LIMIT (dBuV/m)	MARGIN (dB)	ANTENNA HEIGHT (m)	TABLE ANGLE (Degree)	RAW VALUE (dBuV)	CORRECTION FACTOR (dB/m)
1	*5300.00	117.1 PK			1.42 H	30	112.8	4.3
2	*5300.00	106.9 AV			1.42 H	30	102.6	4.3
3	10600.00	48.6 PK	74.0	-25.4	1.02 H	40	34.8	13.8
4	10600.00	37.0 AV	54.0	-17.0	1.02 H	40	23.2	13.8
5	15900.00	49.7 PK	74.0	-24.3	1.00 H	310	36.5	13.2
6	15900.00	36.7 AV	54.0	-17.3	1.00 H	310	23.5	13.2

**ANTENNA POLARITY & TEST DISTANCE: VERTICAL AT 3 M**

NO.	FREQ. (MHz)	EMISSION LEVEL (dBuV/m)	LIMIT (dBuV/m)	MARGIN (dB)	ANTENNA HEIGHT (m)	TABLE ANGLE (Degree)	RAW VALUE (dBuV)	CORRECTION FACTOR (dB/m)
1	*5300.00	117.7 PK			2.30 V	5	113.4	4.3
2	*5300.00	107.6 AV			2.30 V	5	103.3	4.3
3	10600.00	51.2 PK	74.0	-22.8	2.53 V	337	37.4	13.8
4	10600.00	38.9 AV	54.0	-15.1	2.53 V	337	25.1	13.8
5	15900.00	50.9 PK	74.0	-23.1	2.53 V	26	37.7	13.2
6	15900.00	38.0 AV	54.0	-16.0	2.53 V	26	24.8	13.2

**REMARKS:**

1. Emission Level(dBuV/m) = Raw Value(dBuV) + Correction Factor(dB/m)
2. Correction Factor(dB/m) = Antenna Factor(dB/m) + Cable Factor(dB) – Pre-Amplifier Factor(dB)
3. The other emission levels were very low against the limit.
4. Margin value = Emission Level – Limit value
5. " \* ": Fundamental frequency.

<b>CHANNEL</b>	TX Channel 64	<b>DETECTOR FUNCTION</b>	Peak (PK)
<b>FREQUENCY RANGE</b>	1GHz ~ 40GHz		Average (AV)

**ANTENNA POLARITY & TEST DISTANCE: HORIZONTAL AT 3 M**

NO.	FREQ. (MHz)	EMISSION LEVEL (dBuV/m)	LIMIT (dBuV/m)	MARGIN (dB)	ANTENNA HEIGHT (m)	TABLE ANGLE (Degree)	RAW VALUE (dBuV)	CORRECTION FACTOR (dB/m)
1	*5320.00	114.1 PK			1.42 H	31	109.8	4.3
2	*5320.00	103.9 AV			1.42 H	31	99.6	4.3
3	5350.00	71.0 PK	74.0	-3.0	1.42 H	31	66.6	4.4
4	5350.00	52.5 AV	54.0	-1.5	1.42 H	31	48.1	4.4
5	10640.00	47.9 PK	74.0	-26.1	1.03 H	53	33.9	14.0
6	10640.00	36.1 AV	54.0	-17.9	1.03 H	53	22.1	14.0
7	15960.00	48.1 PK	74.0	-25.9	1.00 H	313	34.6	13.5
8	15960.00	35.4 AV	54.0	-18.6	1.00 H	313	21.9	13.5

**ANTENNA POLARITY & TEST DISTANCE: VERTICAL AT 3 M**

NO.	FREQ. (MHz)	EMISSION LEVEL (dBuV/m)	LIMIT (dBuV/m)	MARGIN (dB)	ANTENNA HEIGHT (m)	TABLE ANGLE (Degree)	RAW VALUE (dBuV)	CORRECTION FACTOR (dB/m)
1	*5320.00	114.7 PK			2.30 V	333	110.4	4.3
2	*5320.00	104.6 AV			2.30 V	333	100.3	4.3
3	5350.00	72.0 PK	74.0	-2.0	2.30 V	333	67.6	4.4
4	5350.00	53.5 AV	54.0	-0.5	2.30 V	333	49.1	4.4
5	10640.00	49.8 PK	74.0	-24.2	2.52 V	336	35.8	14.0
6	10640.00	37.5 AV	54.0	-16.5	2.52 V	336	23.5	14.0
7	15960.00	49.6 PK	74.0	-24.4	2.50 V	18	36.1	13.5
8	15960.00	36.5 AV	54.0	-17.5	2.50 V	18	23.0	13.5

**REMARKS:**

1. Emission Level(dBuV/m) = Raw Value(dBuV) + Correction Factor(dB/m)
2. Correction Factor(dB/m) = Antenna Factor(dB/m) + Cable Factor(dB) – Pre-Amplifier Factor(dB)
3. The other emission levels were very low against the limit.
4. Margin value = Emission Level – Limit value
5. " \* ": Fundamental frequency.

<b>CHANNEL</b>	TX Channel 100	<b>DETECTOR FUNCTION</b>	Peak (PK)
<b>FREQUENCY RANGE</b>	1GHz ~ 40GHz		Average (AV)

**ANTENNA POLARITY & TEST DISTANCE: HORIZONTAL AT 3 M**

NO.	FREQ. (MHz)	EMISSION LEVEL (dBuV/m)	LIMIT (dBuV/m)	MARGIN (dB)	ANTENNA HEIGHT (m)	TABLE ANGLE (Degree)	RAW VALUE (dBuV)	CORRECTION FACTOR (dB/m)
1	#5470.00	72.0 PK	74.0	-2.0	1.42 H	13	67.5	4.5
2	#5470.00	52.2 AV	54.0	-1.8	1.42 H	13	47.7	4.5
3	*5500.00	114.6 PK			1.42 H	13	110.1	4.5
4	*5500.00	104.5 AV			1.42 H	13	100.0	4.5
5	11000.00	47.9 PK	74.0	-26.1	1.00 H	66	33.1	14.8
6	11000.00	36.1 AV	54.0	-17.9	1.00 H	66	21.3	14.8
7	#16500.00	47.9 PK	74.0	-26.1	1.00 H	319	32.3	15.6
8	#16500.00	35.3 AV	54.0	-18.7	1.00 H	319	19.7	15.6

**ANTENNA POLARITY & TEST DISTANCE: VERTICAL AT 3 M**

NO.	FREQ. (MHz)	EMISSION LEVEL (dBuV/m)	LIMIT (dBuV/m)	MARGIN (dB)	ANTENNA HEIGHT (m)	TABLE ANGLE (Degree)	RAW VALUE (dBuV)	CORRECTION FACTOR (dB/m)
1	#5470.00	73.0 PK	74.0	-1.0	2.30 V	340	68.5	4.5
2	#5470.00	53.2 AV	54.0	-0.8	2.30 V	340	48.7	4.5
3	*5500.00	115.2 PK			2.30 V	340	110.7	4.5
4	*5500.00	105.2 AV			2.30 V	340	100.7	4.5
5	11000.00	49.7 PK	74.0	-24.3	2.48 V	340	34.9	14.8
6	11000.00	37.6 AV	54.0	-16.4	2.48 V	340	22.8	14.8
7	#16500.00	49.5 PK	74.0	-24.5	2.54 V	28	33.9	15.6
8	#16500.00	36.3 AV	54.0	-17.7	2.54 V	28	20.7	15.6

**REMARKS:**

1. Emission Level(dBuV/m) = Raw Value(dBuV) + Correction Factor(dB/m)
2. Correction Factor(dB/m) = Antenna Factor(dB/m) + Cable Factor(dB) – Pre-Amplifier Factor(dB)
3. The other emission levels were very low against the limit.
4. Margin value = Emission Level – Limit value
5. " \* ": Fundamental frequency.
6. " # ": The radiated frequency is out of the restricted band.

<b>CHANNEL</b>	TX Channel 116	<b>DETECTOR FUNCTION</b>	Peak (PK)
<b>FREQUENCY RANGE</b>	1GHz ~ 40GHz		Average (AV)

**ANTENNA POLARITY & TEST DISTANCE: HORIZONTAL AT 3 M**

NO.	FREQ. (MHz)	EMISSION LEVEL (dBuV/m)	LIMIT (dBuV/m)	MARGIN (dB)	ANTENNA HEIGHT (m)	TABLE ANGLE (Degree)	RAW VALUE (dBuV)	CORRECTION FACTOR (dB/m)
1	*5580.00	115.9 PK			1.39 H	25	111.3	4.6
2	*5580.00	105.7 AV			1.39 H	25	101.1	4.6
3	11160.00	52.4 PK	74.0	-21.6	1.00 H	330	38.0	14.4
4	11160.00	39.1 AV	54.0	-14.9	1.00 H	330	24.7	14.4
5	#16740.00	54.5 PK	74.0	-19.5	1.00 H	324	38.0	16.5
6	#16740.00	42.5 AV	54.0	-11.5	1.00 H	324	26.0	16.5

**ANTENNA POLARITY & TEST DISTANCE: VERTICAL AT 3 M**

NO.	FREQ. (MHz)	EMISSION LEVEL (dBuV/m)	LIMIT (dBuV/m)	MARGIN (dB)	ANTENNA HEIGHT (m)	TABLE ANGLE (Degree)	RAW VALUE (dBuV)	CORRECTION FACTOR (dB/m)
1	*5580.00	116.5 PK			2.30 V	342	111.9	4.6
2	*5580.00	106.4 AV			2.30 V	342	101.8	4.6
3	11160.00	51.9 PK	74.0	-22.1	1.40 V	13	37.5	14.4
4	11160.00	38.6 AV	54.0	-15.4	1.40 V	13	24.2	14.4
5	#16740.00	54.4 PK	74.0	-19.6	2.40 V	345	37.9	16.5
6	#16740.00	42.2 AV	54.0	-11.8	2.40 V	345	25.7	16.5

**REMARKS:**

1. Emission Level(dBuV/m) = Raw Value(dBuV) + Correction Factor(dB/m)
2. Correction Factor(dB/m) = Antenna Factor(dB/m) + Cable Factor(dB) – Pre-Amplifier Factor(dB)
3. The other emission levels were very low against the limit.
4. Margin value = Emission Level – Limit value
5. " \* ": Fundamental frequency.
6. " # ": The radiated frequency is out of the restricted band.

<b>CHANNEL</b>	TX Channel 140	<b>DETECTOR FUNCTION</b>	Peak (PK)
<b>FREQUENCY RANGE</b>	1GHz ~ 40GHz		Average (AV)

**ANTENNA POLARITY & TEST DISTANCE: HORIZONTAL AT 3 M**

NO.	FREQ. (MHz)	EMISSION LEVEL (dBuV/m)	LIMIT (dBuV/m)	MARGIN (dB)	ANTENNA HEIGHT (m)	TABLE ANGLE (Degree)	RAW VALUE (dBuV)	CORRECTION FACTOR (dB/m)
1	*5700.00	112.5 PK			1.44 H	38	107.7	4.8
2	*5700.00	102.2 AV			1.44 H	38	97.4	4.8
3	#5725.00	72.0 PK	74.0	-2.0	1.44 H	38	67.1	4.9
4	#5725.00	52.5 AV	54.0	-1.5	1.44 H	38	47.6	4.9
5	11400.00	47.6 PK	74.0	-26.4	1.00 H	68	33.2	14.4
6	11400.00	35.8 AV	54.0	-18.2	1.00 H	68	21.4	14.4
7	#17100.00	48.4 PK	74.0	-25.6	1.00 H	310	29.9	18.5
8	#17100.00	35.5 AV	54.0	-18.5	1.00 H	310	17.0	18.5

**ANTENNA POLARITY & TEST DISTANCE: VERTICAL AT 3 M**

NO.	FREQ. (MHz)	EMISSION LEVEL (dBuV/m)	LIMIT (dBuV/m)	MARGIN (dB)	ANTENNA HEIGHT (m)	TABLE ANGLE (Degree)	RAW VALUE (dBuV)	CORRECTION FACTOR (dB/m)
1	*5700.00	113.1 PK			2.30 V	322	108.3	4.8
2	*5700.00	102.9 AV			2.30 V	322	98.1	4.8
3	#5725.00	73.0 PK	74.0	-1.0	2.30 V	322	68.1	4.9
4	#5725.00	53.5 AV	54.0	-0.5	2.30 V	322	48.6	4.9
5	11400.00	50.1 PK	74.0	-23.9	2.46 V	348	35.7	14.4
6	11400.00	37.8 AV	54.0	-16.2	2.46 V	348	23.4	14.4
7	#17100.00	49.3 PK	74.0	-24.7	2.45 V	11	30.8	18.5
8	#17100.00	36.4 AV	54.0	-17.6	2.45 V	11	17.9	18.5

**REMARKS:**

1. Emission Level(dBuV/m) = Raw Value(dBuV) + Correction Factor(dB/m)
2. Correction Factor(dB/m) = Antenna Factor(dB/m) + Cable Factor(dB) – Pre-Amplifier Factor(dB)
3. The other emission levels were very low against the limit.
4. Margin value = Emission Level – Limit value
5. " \* ": Fundamental frequency.
6. " # ": The radiated frequency is out of the restricted band.

**802.11ac (VHT20)**

<b>CHANNEL</b>	TX Channel 52	<b>DETECTOR FUNCTION</b>	Peak (PK)
<b>FREQUENCY RANGE</b>	1GHz ~ 40GHz		Average (AV)

ANTENNA POLARITY & TEST DISTANCE: HORIZONTAL AT 3 M								
NO.	FREQ. (MHz)	EMISSION LEVEL (dBuV/m)	LIMIT (dBuV/m)	MARGIN (dB)	ANTENNA HEIGHT (m)	TABLE ANGLE (Degree)	RAW VALUE (dBuV)	CORRECTION FACTOR (dB/m)
1	5136.00	49.5 PK	74.0	-24.5	1.37 H	19	45.5	4.0
2	5136.00	37.3 AV	54.0	-16.7	1.37 H	19	33.3	4.0
3	*5260.00	115.4 PK			1.37 H	19	111.2	4.2
4	*5260.00	104.8 AV			1.37 H	19	100.6	4.2
5	#10520.00	52.2 PK	74.0	-21.8	1.00 H	344	38.4	13.8
6	#10520.00	38.9 AV	54.0	-15.1	1.00 H	344	25.1	13.8
7	15780.00	54.7 PK	74.0	-19.3	1.00 H	326	40.6	14.1
8	15780.00	42.7 AV	54.0	-11.3	1.00 H	326	28.6	14.1

ANTENNA POLARITY & TEST DISTANCE: VERTICAL AT 3 M								
NO.	FREQ. (MHz)	EMISSION LEVEL (dBuV/m)	LIMIT (dBuV/m)	MARGIN (dB)	ANTENNA HEIGHT (m)	TABLE ANGLE (Degree)	RAW VALUE (dBuV)	CORRECTION FACTOR (dB/m)
1	5136.00	50.5 PK	74.0	-23.5	2.30 V	6	46.5	4.0
2	5136.00	38.3 AV	54.0	-15.7	2.30 V	6	34.3	4.0
3	*5260.00	116.0 PK			2.30 V	6	111.8	4.2
4	*5260.00	105.5 AV			2.30 V	6	101.3	4.2
5	#10520.00	51.4 PK	74.0	-22.6	1.34 V	18	37.6	13.8
6	#10520.00	38.2 AV	54.0	-15.8	1.34 V	18	24.4	13.8
7	15780.00	54.0 PK	74.0	-20.0	2.39 V	331	39.9	14.1
8	15780.00	42.1 AV	54.0	-11.9	2.39 V	331	28.0	14.1

**REMARKS:**

1. Emission Level(dBuV/m) = Raw Value(dBuV) + Correction Factor(dB/m)
2. Correction Factor(dB/m) = Antenna Factor(dB/m) + Cable Factor(dB) – Pre-Amplifier Factor(dB)
3. The other emission levels were very low against the limit.
4. Margin value = Emission Level – Limit value
5. " \* ": Fundamental frequency.
6. " # ": The radiated frequency is out of the restricted band.

<b>CHANNEL</b>	TX Channel 60	<b>DETECTOR FUNCTION</b>	Peak (PK)
<b>FREQUENCY RANGE</b>	1GHz ~ 40GHz		Average (AV)

**ANTENNA POLARITY & TEST DISTANCE: HORIZONTAL AT 3 M**

NO.	FREQ. (MHz)	EMISSION LEVEL (dBuV/m)	LIMIT (dBuV/m)	MARGIN (dB)	ANTENNA HEIGHT (m)	TABLE ANGLE (Degree)	RAW VALUE (dBuV)	CORRECTION FACTOR (dB/m)
1	*5300.00	115.5 PK			1.36 H	29	111.2	4.3
2	*5300.00	104.8 AV			1.36 H	29	100.5	4.3
3	10600.00	51.6 PK	74.0	-22.4	1.00 H	335	37.8	13.8
4	10600.00	38.5 AV	54.0	-15.5	1.00 H	335	24.7	13.8
5	15900.00	54.7 PK	74.0	-19.3	1.00 H	342	41.5	13.2
6	15900.00	42.7 AV	54.0	-11.3	1.00 H	342	29.5	13.2

**ANTENNA POLARITY & TEST DISTANCE: VERTICAL AT 3 M**

NO.	FREQ. (MHz)	EMISSION LEVEL (dBuV/m)	LIMIT (dBuV/m)	MARGIN (dB)	ANTENNA HEIGHT (m)	TABLE ANGLE (Degree)	RAW VALUE (dBuV)	CORRECTION FACTOR (dB/m)
1	*5300.00	116.1 PK			2.31 V	6	111.8	4.3
2	*5300.00	105.5 AV			2.31 V	6	101.2	4.3
3	10600.00	51.1 PK	74.0	-22.9	1.37 V	32	37.3	13.8
4	10600.00	37.8 AV	54.0	-16.2	1.37 V	32	24.0	13.8
5	15900.00	54.6 PK	74.0	-19.4	2.36 V	335	41.4	13.2
6	15900.00	42.6 AV	54.0	-11.4	2.36 V	335	29.4	13.2

**REMARKS:**

1. Emission Level(dBuV/m) = Raw Value(dBuV) + Correction Factor(dB/m)
2. Correction Factor(dB/m) = Antenna Factor(dB/m) + Cable Factor(dB) – Pre-Amplifier Factor(dB)
3. The other emission levels were very low against the limit.
4. Margin value = Emission Level – Limit value
5. " \* ": Fundamental frequency.

<b>CHANNEL</b>	TX Channel 64	<b>DETECTOR FUNCTION</b>	Peak (PK)
<b>FREQUENCY RANGE</b>	1GHz ~ 40GHz		Average (AV)

**ANTENNA POLARITY & TEST DISTANCE: HORIZONTAL AT 3 M**

NO.	FREQ. (MHz)	EMISSION LEVEL (dBuV/m)	LIMIT (dBuV/m)	MARGIN (dB)	ANTENNA HEIGHT (m)	TABLE ANGLE (Degree)	RAW VALUE (dBuV)	CORRECTION FACTOR (dB/m)
1	*5320.00	113.6 PK			1.43 H	37	109.3	4.3
2	*5320.00	103.1 AV			1.43 H	37	98.8	4.3
3	5350.00	70.5 PK	74.0	-3.5	1.43 H	37	66.1	4.4
4	5350.00	52.9 AV	54.0	-1.1	1.43 H	37	48.5	4.4
5	10640.00	47.8 PK	74.0	-26.2	1.02 H	56	33.8	14.0
6	10640.00	35.9 AV	54.0	-18.1	1.02 H	56	21.9	14.0
7	15960.00	49.1 PK	74.0	-24.9	1.00 H	312	35.6	13.5
8	15960.00	36.0 AV	54.0	-18.0	1.00 H	312	22.5	13.5

**ANTENNA POLARITY & TEST DISTANCE: VERTICAL AT 3 M**

NO.	FREQ. (MHz)	EMISSION LEVEL (dBuV/m)	LIMIT (dBuV/m)	MARGIN (dB)	ANTENNA HEIGHT (m)	TABLE ANGLE (Degree)	RAW VALUE (dBuV)	CORRECTION FACTOR (dB/m)
1	*5320.00	114.2 PK			2.31 V	334	109.9	4.3
2	*5320.00	103.8 AV			2.31 V	334	99.5	4.3
3	5350.00	71.5 PK	74.0	-2.5	2.31 V	334	67.1	4.4
<b>4</b>	<b>5350.00</b>	<b>53.9 AV</b>	<b>54.0</b>	<b>-0.1</b>	<b>2.31 V</b>	<b>334</b>	<b>49.5</b>	<b>4.4</b>
5	10640.00	50.3 PK	74.0	-23.7	2.40 V	352	36.3	14.0
6	10640.00	37.8 AV	54.0	-16.2	2.40 V	352	23.8	14.0
7	15960.00	49.7 PK	74.0	-24.3	2.41 V	5	36.2	13.5
8	15960.00	36.8 AV	54.0	-17.2	2.41 V	5	23.3	13.5

**REMARKS:**

1. Emission Level(dBuV/m) = Raw Value(dBuV) + Correction Factor(dB/m)
2. Correction Factor(dB/m) = Antenna Factor(dB/m) + Cable Factor(dB) – Pre-Amplifier Factor(dB)
3. The other emission levels were very low against the limit.
4. Margin value = Emission Level – Limit value
5. " \* ": Fundamental frequency.



<b>CHANNEL</b>	TX Channel 100	<b>DETECTOR FUNCTION</b>	Peak (PK)
<b>FREQUENCY RANGE</b>	1GHz ~ 40GHz		Average (AV)

**ANTENNA POLARITY & TEST DISTANCE: HORIZONTAL AT 3 M**

NO.	FREQ. (MHz)	EMISSION LEVEL (dBuV/m)	LIMIT (dBuV/m)	MARGIN (dB)	ANTENNA HEIGHT (m)	TABLE ANGLE (Degree)	RAW VALUE (dBuV)	CORRECTION FACTOR (dB/m)
1	#5470.00	72.0 PK	74.0	-2.0	1.41 H	37	67.5	4.5
2	#5470.00	52.9 AV	54.0	-1.1	1.41 H	37	48.4	4.5
3	*5500.00	113.8 PK			1.41 H	37	109.3	4.5
4	*5500.00	102.8 AV			1.41 H	37	98.3	4.5
5	11000.00	48.2 PK	74.0	-25.8	1.03 H	57	33.4	14.8
6	11000.00	36.2 AV	54.0	-17.8	1.03 H	57	21.4	14.8
7	#16500.00	47.6 PK	74.0	-26.4	1.00 H	312	32.0	15.6
8	#16500.00	35.0 AV	54.0	-19.0	1.00 H	312	19.4	15.6

**ANTENNA POLARITY & TEST DISTANCE: VERTICAL AT 3 M**

NO.	FREQ. (MHz)	EMISSION LEVEL (dBuV/m)	LIMIT (dBuV/m)	MARGIN (dB)	ANTENNA HEIGHT (m)	TABLE ANGLE (Degree)	RAW VALUE (dBuV)	CORRECTION FACTOR (dB/m)
1	#5470.00	73.0 PK	74.0	-1.0	2.31 V	338	68.5	4.5
2	#5470.00	53.9 AV	54.0	-0.1	2.31 V	338	49.4	4.5
3	*5500.00	114.4 PK			2.31 V	338	109.9	4.5
4	*5500.00	103.5 AV			2.31 V	338	99.0	4.5
5	11000.00	50.3 PK	74.0	-23.7	2.41 V	343	35.5	14.8
6	11000.00	38.0 AV	54.0	-16.0	2.41 V	343	23.2	14.8
7	#16500.00	49.4 PK	74.0	-24.6	2.44 V	0	33.8	15.6
8	#16500.00	36.3 AV	54.0	-17.7	2.44 V	0	20.7	15.6

**REMARKS:**

- Emission Level(dBuV/m) = Raw Value(dBuV) + Correction Factor(dB/m)
- Correction Factor(dB/m) = Antenna Factor(dB/m) + Cable Factor(dB) – Pre-Amplifier Factor(dB)
- The other emission levels were very low against the limit.
- Margin value = Emission Level – Limit value
- " \* ": Fundamental frequency.
- " # ": The radiated frequency is out of the restricted band.

<b>CHANNEL</b>	TX Channel 116	<b>DETECTOR FUNCTION</b>	Peak (PK)
<b>FREQUENCY RANGE</b>	1GHz ~ 40GHz		Average (AV)

**ANTENNA POLARITY & TEST DISTANCE: HORIZONTAL AT 3 M**

NO.	FREQ. (MHz)	EMISSION LEVEL (dBuV/m)	LIMIT (dBuV/m)	MARGIN (dB)	ANTENNA HEIGHT (m)	TABLE ANGLE (Degree)	RAW VALUE (dBuV)	CORRECTION FACTOR (dB/m)
1	*5580.00	115.1 PK			1.48 H	9	110.5	4.6
2	*5580.00	104.3 AV			1.48 H	9	99.7	4.6
3	11160.00	51.7 PK	74.0	-22.3	1.00 H	334	37.3	14.4
4	11160.00	38.5 AV	54.0	-15.5	1.00 H	334	24.1	14.4
5	#16740.00	55.4 PK	74.0	-18.6	1.00 H	312	38.9	16.5
6	#16740.00	43.1 AV	54.0	-10.9	1.00 H	312	26.6	16.5

**ANTENNA POLARITY & TEST DISTANCE: VERTICAL AT 3 M**

NO.	FREQ. (MHz)	EMISSION LEVEL (dBuV/m)	LIMIT (dBuV/m)	MARGIN (dB)	ANTENNA HEIGHT (m)	TABLE ANGLE (Degree)	RAW VALUE (dBuV)	CORRECTION FACTOR (dB/m)
1	*5580.00	115.7 PK			2.31 V	341	111.1	4.6
2	*5580.00	105.0 AV			2.31 V	341	100.4	4.6
3	11160.00	51.1 PK	74.0	-22.9	1.39 V	9	36.7	14.4
4	11160.00	38.1 AV	54.0	-15.9	1.39 V	9	23.7	14.4
5	#16740.00	54.3 PK	74.0	-19.7	2.38 V	337	37.8	16.5
6	#16740.00	42.1 AV	54.0	-11.9	2.38 V	337	25.6	16.5

**REMARKS:**

1. Emission Level(dBuV/m) = Raw Value(dBuV) + Correction Factor(dB/m)
2. Correction Factor(dB/m) = Antenna Factor(dB/m) + Cable Factor(dB) – Pre-Amplifier Factor(dB)
3. The other emission levels were very low against the limit.
4. Margin value = Emission Level – Limit value
5. " \* ": Fundamental frequency.
6. " # ": The radiated frequency is out of the restricted band.

<b>CHANNEL</b>	TX Channel 140	<b>DETECTOR FUNCTION</b>	Peak (PK)
<b>FREQUENCY RANGE</b>	1GHz ~ 40GHz		Average (AV)

**ANTENNA POLARITY & TEST DISTANCE: HORIZONTAL AT 3 M**

NO.	FREQ. (MHz)	EMISSION LEVEL (dBuV/m)	LIMIT (dBuV/m)	MARGIN (dB)	ANTENNA HEIGHT (m)	TABLE ANGLE (Degree)	RAW VALUE (dBuV)	CORRECTION FACTOR (dB/m)
1	*5700.00	111.8 PK			1.40 H	33	107.0	4.8
2	*5700.00	100.8 AV			1.40 H	33	96.0	4.8
3	#5725.00	72.9 PK	74.0	-1.1	1.40 H	33	68.0	4.9
4	#5725.00	52.3 AV	54.0	-1.7	1.40 H	33	47.4	4.9
5	11400.00	47.8 PK	74.0	-26.2	1.00 H	79	33.4	14.4
6	11400.00	36.2 AV	54.0	-17.8	1.00 H	79	21.8	14.4
7	#17100.00	48.6 PK	74.0	-25.4	1.00 H	315	30.1	18.5
8	#17100.00	35.8 AV	54.0	-18.2	1.00 H	315	17.3	18.5

**ANTENNA POLARITY & TEST DISTANCE: VERTICAL AT 3 M**

NO.	FREQ. (MHz)	EMISSION LEVEL (dBuV/m)	LIMIT (dBuV/m)	MARGIN (dB)	ANTENNA HEIGHT (m)	TABLE ANGLE (Degree)	RAW VALUE (dBuV)	CORRECTION FACTOR (dB/m)
1	*5700.00	112.4 PK			2.31 V	328	107.6	4.8
2	*5700.00	101.5 AV			2.31 V	328	96.7	4.8
3	#5725.00	73.9 PK	74.0	-0.1	2.31 V	328	69.0	4.9
4	#5725.00	53.3 AV	54.0	-0.7	2.31 V	328	48.4	4.9
5	11400.00	49.4 PK	74.0	-24.6	2.46 V	336	35.0	14.4
6	11400.00	37.4 AV	54.0	-16.6	2.46 V	336	23.0	14.4
7	#17100.00	48.9 PK	74.0	-25.1	2.45 V	17	30.4	18.5
8	#17100.00	35.9 AV	54.0	-18.1	2.45 V	17	17.4	18.5

**REMARKS:**

1. Emission Level(dBuV/m) = Raw Value(dBuV) + Correction Factor(dB/m)
2. Correction Factor(dB/m) = Antenna Factor(dB/m) + Cable Factor(dB) – Pre-Amplifier Factor(dB)
3. The other emission levels were very low against the limit.
4. Margin value = Emission Level – Limit value
5. " \* ": Fundamental frequency.
6. " # ": The radiated frequency is out of the restricted band.

**802.11ac (VHT40)**

<b>CHANNEL</b>	TX Channel 54	<b>DETECTOR FUNCTION</b>	Peak (PK)
<b>FREQUENCY RANGE</b>	1GHz ~ 40GHz		Average (AV)

**ANTENNA POLARITY & TEST DISTANCE: HORIZONTAL AT 3 M**

NO.	FREQ. (MHz)	EMISSION LEVEL (dBuV/m)	LIMIT (dBuV/m)	MARGIN (dB)	ANTENNA HEIGHT (m)	TABLE ANGLE (Degree)	RAW VALUE (dBuV)	CORRECTION FACTOR (dB/m)
1	5150.00	55.6 PK	74.0	-18.4	1.30 H	30	51.6	4.0
2	5150.00	40.9 AV	54.0	-13.1	1.30 H	30	36.9	4.0
3	*5270.00	114.2 PK			1.30 H	30	110.0	4.2
4	*5270.00	103.5 AV			1.30 H	30	99.3	4.2
5	#10540.00	51.5 PK	74.0	-22.5	1.00 H	329	37.8	13.7
6	#10540.00	38.3 AV	54.0	-15.7	1.00 H	329	24.6	13.7
7	15810.00	55.2 PK	74.0	-18.8	1.00 H	318	41.2	14.0
8	15810.00	43.0 AV	54.0	-11.0	1.00 H	318	29.0	14.0

**ANTENNA POLARITY & TEST DISTANCE: VERTICAL AT 3 M**

NO.	FREQ. (MHz)	EMISSION LEVEL (dBuV/m)	LIMIT (dBuV/m)	MARGIN (dB)	ANTENNA HEIGHT (m)	TABLE ANGLE (Degree)	RAW VALUE (dBuV)	CORRECTION FACTOR (dB/m)
1	5150.00	56.8 PK	74.0	-17.2	2.31 V	6	52.8	4.0
2	5150.00	42.0 AV	54.0	-12.0	2.31 V	6	38.0	4.0
3	*5270.00	114.8 PK			2.31 V	6	110.6	4.2
4	*5270.00	104.2 AV			2.31 V	6	100.0	4.2
5	#10540.00	51.7 PK	74.0	-22.3	1.38 V	33	38.0	13.7
6	#10540.00	38.5 AV	54.0	-15.5	1.38 V	33	24.8	13.7
7	15810.00	54.7 PK	74.0	-19.3	2.34 V	351	40.7	14.0
8	15810.00	42.7 AV	54.0	-11.3	2.34 V	351	28.7	14.0

**REMARKS:**

- Emission Level(dBuV/m) = Raw Value(dBuV) + Correction Factor(dB/m)
- Correction Factor(dB/m) = Antenna Factor(dB/m) + Cable Factor(dB) – Pre-Amplifier Factor(dB)
- The other emission levels were very low against the limit.
- Margin value = Emission Level – Limit value
- " \* ": Fundamental frequency.
- " # ": The radiated frequency is out of the restricted band.

<b>CHANNEL</b>	TX Channel 62	<b>DETECTOR FUNCTION</b>	Peak (PK)
<b>FREQUENCY RANGE</b>	1GHz ~ 40GHz		Average (AV)

**ANTENNA POLARITY & TEST DISTANCE: HORIZONTAL AT 3 M**

NO.	FREQ. (MHz)	EMISSION LEVEL (dBuV/m)	LIMIT (dBuV/m)	MARGIN (dB)	ANTENNA HEIGHT (m)	TABLE ANGLE (Degree)	RAW VALUE (dBuV)	CORRECTION FACTOR (dB/m)
1	*5310.00	108.9 PK			1.42 H	27	104.6	4.3
2	*5310.00	99.0 AV			1.42 H	27	94.7	4.3
3	5350.00	72.3 PK	74.0	-1.7	1.42 H	27	67.9	4.4
4	5350.00	51.4 AV	54.0	-2.6	1.42 H	27	47.0	4.4
5	10620.00	48.1 PK	74.0	-25.9	1.00 H	58	34.2	13.9
6	10620.00	36.1 AV	54.0	-17.9	1.00 H	58	22.2	13.9
7	15930.00	48.1 PK	74.0	-25.9	1.00 H	306	34.8	13.3
8	15930.00	35.2 AV	54.0	-18.8	1.00 H	306	21.9	13.3

**ANTENNA POLARITY & TEST DISTANCE: VERTICAL AT 3 M**

NO.	FREQ. (MHz)	EMISSION LEVEL (dBuV/m)	LIMIT (dBuV/m)	MARGIN (dB)	ANTENNA HEIGHT (m)	TABLE ANGLE (Degree)	RAW VALUE (dBuV)	CORRECTION FACTOR (dB/m)
1	*5310.00	109.5 PK			2.31 V	10	105.2	4.3
2	*5310.00	99.7 AV			2.31 V	10	95.4	4.3
3	5350.00	73.5 PK	74.0	-0.5	2.31 V	10	69.1	4.4
4	5350.00	52.5 AV	54.0	-1.5	2.31 V	10	48.1	4.4
5	10620.00	49.7 PK	74.0	-24.3	2.47 V	360	35.8	13.9
6	10620.00	37.5 AV	54.0	-16.5	2.47 V	360	23.6	13.9
7	15930.00	49.4 PK	74.0	-24.6	2.47 V	5	36.1	13.3
8	15930.00	36.5 AV	54.0	-17.5	2.47 V	5	23.2	13.3

**REMARKS:**

1. Emission Level(dBuV/m) = Raw Value(dBuV) + Correction Factor(dB/m)
2. Correction Factor(dB/m) = Antenna Factor(dB/m) + Cable Factor(dB) – Pre-Amplifier Factor(dB)
3. The other emission levels were very low against the limit.
4. Margin value = Emission Level – Limit value
5. " \* ": Fundamental frequency.

<b>CHANNEL</b>	TX Channel 102	<b>DETECTOR FUNCTION</b>	Peak (PK)
<b>FREQUENCY RANGE</b>	1GHz ~ 40GHz		Average (AV)

**ANTENNA POLARITY & TEST DISTANCE: HORIZONTAL AT 3 M**

NO.	FREQ. (MHz)	EMISSION LEVEL (dBuV/m)	LIMIT (dBuV/m)	MARGIN (dB)	ANTENNA HEIGHT (m)	TABLE ANGLE (Degree)	RAW VALUE (dBuV)	CORRECTION FACTOR (dB/m)
1	#5470.00	68.7 PK	74.0	-5.3	1.36 H	36	64.2	4.5
2	#5470.00	52.6 AV	54.0	-1.4	1.36 H	36	48.1	4.5
3	*5510.00	107.3 PK			1.36 H	36	102.7	4.6
4	*5510.00	97.4 AV			1.36 H	36	92.8	4.6
5	11020.00	47.8 PK	74.0	-26.2	1.03 H	68	33.1	14.7
6	11020.00	36.2 AV	54.0	-17.8	1.03 H	68	21.5	14.7
7	#16530.00	47.7 PK	74.0	-26.3	1.00 H	321	31.9	15.8
8	#16530.00	35.0 AV	54.0	-19.0	1.00 H	321	19.2	15.8

**ANTENNA POLARITY & TEST DISTANCE: VERTICAL AT 3 M**

NO.	FREQ. (MHz)	EMISSION LEVEL (dBuV/m)	LIMIT (dBuV/m)	MARGIN (dB)	ANTENNA HEIGHT (m)	TABLE ANGLE (Degree)	RAW VALUE (dBuV)	CORRECTION FACTOR (dB/m)
1	#5470.00	69.9 PK	74.0	-4.1	2.31 V	338	65.4	4.5
2	#5470.00	53.7 AV	54.0	-0.3	2.31 V	338	49.2	4.5
3	*5510.00	107.9 PK			2.31 V	338	103.3	4.6
4	*5510.00	98.1 AV			2.31 V	338	93.5	4.6
5	11020.00	50.0 PK	74.0	-24.0	2.42 V	346	35.3	14.7
6	11020.00	38.0 AV	54.0	-16.0	2.42 V	346	23.3	14.7
7	#16530.00	49.9 PK	74.0	-24.1	2.40 V	0	34.1	15.8
8	#16530.00	36.7 AV	54.0	-17.3	2.40 V	0	20.9	15.8

**REMARKS:**

1. Emission Level(dBuV/m) = Raw Value(dBuV) + Correction Factor(dB/m)
2. Correction Factor(dB/m) = Antenna Factor(dB/m) + Cable Factor(dB) – Pre-Amplifier Factor(dB)
3. The other emission levels were very low against the limit.
4. Margin value = Emission Level – Limit value
5. " \* ": Fundamental frequency.
6. " # ": The radiated frequency is out of the restricted band.

<b>CHANNEL</b>	TX Channel 110	<b>DETECTOR FUNCTION</b>	Peak (PK)
<b>FREQUENCY RANGE</b>	1GHz ~ 40GHz		Average (AV)

**ANTENNA POLARITY & TEST DISTANCE: HORIZONTAL AT 3 M**

NO.	FREQ. (MHz)	EMISSION LEVEL (dBuV/m)	LIMIT (dBuV/m)	MARGIN (dB)	ANTENNA HEIGHT (m)	TABLE ANGLE (Degree)	RAW VALUE (dBuV)	CORRECTION FACTOR (dB/m)
1	*5550.00	112.4 PK			1.31 H	29	107.9	4.5
2	*5550.00	102.3 AV			1.31 H	29	97.8	4.5
3	11100.00	51.5 PK	74.0	-22.5	1.04 H	335	37.1	14.4
4	11100.00	38.3 AV	54.0	-15.7	1.04 H	335	23.9	14.4
5	#16650.00	54.8 PK	74.0	-19.2	1.00 H	303	38.4	16.4
6	#16650.00	43.0 AV	54.0	-11.0	1.00 H	303	26.6	16.4

**ANTENNA POLARITY & TEST DISTANCE: VERTICAL AT 3 M**

NO.	FREQ. (MHz)	EMISSION LEVEL (dBuV/m)	LIMIT (dBuV/m)	MARGIN (dB)	ANTENNA HEIGHT (m)	TABLE ANGLE (Degree)	RAW VALUE (dBuV)	CORRECTION FACTOR (dB/m)
1	*5550.00	113.0 PK			2.31 V	331	108.5	4.5
2	*5550.00	103.0 AV			2.31 V	331	98.5	4.5
3	11100.00	51.2 PK	74.0	-22.8	1.31 V	32	36.8	14.4
4	11100.00	38.3 AV	54.0	-15.7	1.31 V	32	23.9	14.4
5	#16650.00	54.5 PK	74.0	-19.5	2.42 V	326	38.1	16.4
6	#16650.00	42.4 AV	54.0	-11.6	2.42 V	326	26.0	16.4

**REMARKS:**

1. Emission Level(dBuV/m) = Raw Value(dBuV) + Correction Factor(dB/m)
2. Correction Factor(dB/m) = Antenna Factor(dB/m) + Cable Factor(dB) – Pre-Amplifier Factor(dB)
3. The other emission levels were very low against the limit.
4. Margin value = Emission Level – Limit value
5. " \* ": Fundamental frequency.
6. " # ": The radiated frequency is out of the restricted band.

<b>CHANNEL</b>	TX Channel 134	<b>DETECTOR FUNCTION</b>	Peak (PK)
<b>FREQUENCY RANGE</b>	1GHz ~ 40GHz		Average (AV)

**ANTENNA POLARITY & TEST DISTANCE: HORIZONTAL AT 3 M**

NO.	FREQ. (MHz)	EMISSION LEVEL (dBuV/m)	LIMIT (dBuV/m)	MARGIN (dB)	ANTENNA HEIGHT (m)	TABLE ANGLE (Degree)	RAW VALUE (dBuV)	CORRECTION FACTOR (dB/m)
1	*5670.00	110.4 PK			1.40 H	41	105.6	4.8
2	*5670.00	99.9 AV			1.40 H	41	95.1	4.8
3	#5725.00	69.1 PK	74.0	-4.9	1.40 H	41	64.2	4.9
4	#5725.00	52.8 AV	54.0	-1.2	1.40 H	41	47.9	4.9
5	11340.00	47.7 PK	74.0	-26.3	1.01 H	80	33.3	14.4
6	11340.00	36.0 AV	54.0	-18.0	1.01 H	80	21.6	14.4
7	#17010.00	48.3 PK	74.0	-25.7	1.00 H	313	30.1	18.2
8	#17010.00	35.4 AV	54.0	-18.6	1.00 H	313	17.2	18.2

**ANTENNA POLARITY & TEST DISTANCE: VERTICAL AT 3 M**

NO.	FREQ. (MHz)	EMISSION LEVEL (dBuV/m)	LIMIT (dBuV/m)	MARGIN (dB)	ANTENNA HEIGHT (m)	TABLE ANGLE (Degree)	RAW VALUE (dBuV)	CORRECTION FACTOR (dB/m)
1	*5670.00	111.0 PK			2.31 V	315	106.2	4.8
2	*5670.00	100.6 AV			2.31 V	315	95.8	4.8
3	#5725.00	70.3 PK	74.0	-3.7	2.31 V	315	65.4	4.9
4	#5725.00	<b>53.9 AV</b>	<b>54.0</b>	<b>-0.1</b>	<b>2.31 V</b>	<b>315</b>	<b>49.0</b>	<b>4.9</b>
5	11340.00	50.5 PK	74.0	-23.5	2.45 V	360	36.1	14.4
6	11340.00	38.3 AV	54.0	-15.7	2.45 V	360	23.9	14.4
7	#17010.00	49.8 PK	74.0	-24.2	2.51 V	16	31.6	18.2
8	#17010.00	36.8 AV	54.0	-17.2	2.51 V	16	18.6	18.2

**REMARKS:**

1. Emission Level(dBuV/m) = Raw Value(dBuV) + Correction Factor(dB/m)
2. Correction Factor(dB/m) = Antenna Factor(dB/m) + Cable Factor(dB) – Pre-Amplifier Factor(dB)
3. The other emission levels were very low against the limit.
4. Margin value = Emission Level – Limit value
5. " \* ": Fundamental frequency.
6. " # ": The radiated frequency is out of the restricted band.



802.11ac (VHT80)

<b>CHANNEL</b>	TX Channel 58	<b>DETECTOR FUNCTION</b>	Peak (PK)
<b>FREQUENCY RANGE</b>	1GHz ~ 40GHz		Average (AV)

**ANTENNA POLARITY & TEST DISTANCE: HORIZONTAL AT 3 M**

NO.	FREQ. (MHz)	EMISSION LEVEL (dBuV/m)	LIMIT (dBuV/m)	MARGIN (dB)	ANTENNA HEIGHT (m)	TABLE ANGLE (Degree)	RAW VALUE (dBuV)	CORRECTION FACTOR (dB/m)
1	5150.00	55.7 PK	74.0	-18.3	1.31 H	24	51.7	4.0
2	5150.00	40.1 AV	54.0	-13.9	1.31 H	24	36.1	4.0
3	*5290.00	105.9 PK			1.31 H	24	101.6	4.3
4	*5290.00	95.8 AV			1.31 H	24	91.5	4.3
5	5356.00	72.7 PK	74.0	-1.3	1.31 H	24	68.3	4.4
6	5356.00	52.7 AV	54.0	-1.3	1.31 H	24	48.3	4.4
7	#10580.00	47.7 PK	74.0	-26.3	1.03 H	68	33.8	13.9
8	#10580.00	35.8 AV	54.0	-18.2	1.03 H	68	21.9	13.9
9	15870.00	48.7 PK	74.0	-25.3	1.00 H	294	35.3	13.4
10	15870.00	35.7 AV	54.0	-18.3	1.00 H	294	22.3	13.4

**ANTENNA POLARITY & TEST DISTANCE: VERTICAL AT 3 M**

NO.	FREQ. (MHz)	EMISSION LEVEL (dBuV/m)	LIMIT (dBuV/m)	MARGIN (dB)	ANTENNA HEIGHT (m)	TABLE ANGLE (Degree)	RAW VALUE (dBuV)	CORRECTION FACTOR (dB/m)
1	5150.00	56.9 PK	74.0	-17.1	2.35 V	339	52.9	4.0
2	5150.00	41.2 AV	54.0	-12.8	2.35 V	339	37.2	4.0
3	*5290.00	106.5 PK			2.35 V	339	102.2	4.3
4	*5290.00	96.5 AV			2.35 V	339	92.2	4.3
<b>5</b>	<b>5356.00</b>	<b>73.9 PK</b>	<b>74.0</b>	<b>-0.1</b>	<b>2.35 V</b>	<b>339</b>	<b>69.5</b>	<b>4.4</b>
6	5356.00	53.8 AV	54.0	-0.2	2.35 V	339	49.4	4.4
7	#10580.00	49.9 PK	74.0	-24.1	2.47 V	341	36.0	13.9
8	#10580.00	37.6 AV	54.0	-16.4	2.47 V	341	23.7	13.9
9	15870.00	49.1 PK	74.0	-24.9	2.43 V	3	35.7	13.4
10	15870.00	36.3 AV	54.0	-17.7	2.43 V	3	22.9	13.4

**REMARKS:**

- Emission Level(dBuV/m) = Raw Value(dBuV) + Correction Factor(dB/m)
- Correction Factor(dB/m) = Antenna Factor(dB/m) + Cable Factor(dB) – Pre-Amplifier Factor(dB)
- The other emission levels were very low against the limit.
- Margin value = Emission Level – Limit value
- " \* ": Fundamental frequency.
- " # ": The radiated frequency is out of the restricted band.

<b>CHANNEL</b>	TX Channel 106	<b>DETECTOR FUNCTION</b>	Peak (PK)
<b>FREQUENCY RANGE</b>	1GHz ~ 40GHz		Average (AV)

**ANTENNA POLARITY & TEST DISTANCE: HORIZONTAL AT 3 M**

NO.	FREQ. (MHz)	EMISSION LEVEL (dBuV/m)	LIMIT (dBuV/m)	MARGIN (dB)	ANTENNA HEIGHT (m)	TABLE ANGLE (Degree)	RAW VALUE (dBuV)	CORRECTION FACTOR (dB/m)
1	5456.00	66.9 PK	74.0	-7.1	1.38 H	37	62.4	4.5
2	5456.00	52.8 AV	54.0	-1.2	1.38 H	37	48.3	4.5
3	*5530.00	103.6 PK			1.38 H	37	99.1	4.5
4	*5530.00	93.5 AV			1.38 H	37	89.0	4.5
5	#5725.00	51.3 PK	74.0	-22.7	1.38 H	37	46.4	4.9
6	#5725.00	39.1 AV	54.0	-14.9	1.38 H	37	34.2	4.9
7	11060.00	47.0 PK	74.0	-27.0	1.00 H	72	32.5	14.5
8	11060.00	35.4 AV	54.0	-18.6	1.00 H	72	20.9	14.5
9	#16590.00	48.6 PK	74.0	-25.4	1.00 H	307	32.0	16.6
10	#16590.00	35.9 AV	54.0	-18.1	1.00 H	307	19.3	16.6

**ANTENNA POLARITY & TEST DISTANCE: VERTICAL AT 3 M**

NO.	FREQ. (MHz)	EMISSION LEVEL (dBuV/m)	LIMIT (dBuV/m)	MARGIN (dB)	ANTENNA HEIGHT (m)	TABLE ANGLE (Degree)	RAW VALUE (dBuV)	CORRECTION FACTOR (dB/m)
1	5456.00	68.1 PK	74.0	-5.9	2.35 V	341	63.6	4.5
2	5456.00	53.9 AV	54.0	-0.1	2.35 V	341	49.4	4.5
3	*5530.00	104.2 PK			2.35 V	341	99.7	4.5
4	*5530.00	94.2 AV			2.35 V	341	89.7	4.5
5	#5725.00	52.5 PK	74.0	-21.5	2.35 V	341	47.6	4.9
6	#5725.00	40.2 AV	54.0	-13.8	2.35 V	341	35.3	4.9
7	11060.00	49.7 PK	74.0	-24.3	2.41 V	348	35.2	14.5
8	11060.00	37.3 AV	54.0	-16.7	2.41 V	348	22.8	14.5
9	#16590.00	49.9 PK	74.0	-24.1	2.46 V	22	33.3	16.6
10	#16590.00	36.8 AV	54.0	-17.2	2.46 V	22	20.2	16.6

**REMARKS:**

- Emission Level(dBuV/m) = Raw Value(dBuV) + Correction Factor(dB/m)
- Correction Factor(dB/m) = Antenna Factor(dB/m) + Cable Factor(dB) – Pre-Amplifier Factor(dB)
- The other emission levels were very low against the limit.
- Margin value = Emission Level – Limit value
- " \* ": Fundamental frequency.
- " # ": The radiated frequency is out of the restricted band.

<b>CHANNEL</b>	TX Channel 122	<b>DETECTOR FUNCTION</b>	Peak (PK)
<b>FREQUENCY RANGE</b>	1GHz ~ 40GHz		Average (AV)

**ANTENNA POLARITY & TEST DISTANCE: HORIZONTAL AT 3 M**

NO.	FREQ. (MHz)	EMISSION LEVEL (dBuV/m)	LIMIT (dBuV/m)	MARGIN (dB)	ANTENNA HEIGHT (m)	TABLE ANGLE (Degree)	RAW VALUE (dBuV)	CORRECTION FACTOR (dB/m)
1	*5610.00	108.2 PK			1.37 H	25	103.5	4.7
2	*5610.00	97.5 AV			1.37 H	25	92.8	4.7
3	#5725.00	67.0 PK	74.0	-7.0	1.37 H	25	62.1	4.9
4	#5725.00	52.8 AV	54.0	-1.2	1.37 H	25	47.9	4.9
5	11220.00	51.7 PK	74.0	-22.3	1.03 H	322	37.3	14.4
6	11220.00	38.4 AV	54.0	-15.6	1.03 H	322	24.0	14.4
7	#16830.00	54.8 PK	74.0	-19.2	1.00 H	305	37.8	17.0
8	#16830.00	42.9 AV	54.0	-11.1	1.00 H	305	25.9	17.0

**ANTENNA POLARITY & TEST DISTANCE: VERTICAL AT 3 M**

NO.	FREQ. (MHz)	EMISSION LEVEL (dBuV/m)	LIMIT (dBuV/m)	MARGIN (dB)	ANTENNA HEIGHT (m)	TABLE ANGLE (Degree)	RAW VALUE (dBuV)	CORRECTION FACTOR (dB/m)
1	*5610.00	108.8 PK			2.35 V	322	104.1	4.7
2	*5610.00	98.2 AV			2.35 V	322	93.5	4.7
3	#5725.00	68.2 PK	74.0	-5.8	2.35 V	322	63.3	4.9
4	#5725.00	<b>53.9 AV</b>	<b>54.0</b>	<b>-0.1</b>	<b>2.35 V</b>	<b>322</b>	<b>49.0</b>	<b>4.9</b>
5	11220.00	51.2 PK	74.0	-22.8	1.32 V	31	36.8	14.4
6	11220.00	38.1 AV	54.0	-15.9	1.32 V	31	23.7	14.4
7	#16830.00	54.7 PK	74.0	-19.3	2.43 V	336	37.7	17.0
8	#16830.00	42.7 AV	54.0	-11.3	2.43 V	336	25.7	17.0

**REMARKS:**

1. Emission Level(dBuV/m) = Raw Value(dBuV) + Correction Factor(dB/m)
2. Correction Factor(dB/m) = Antenna Factor(dB/m) + Cable Factor(dB) – Pre-Amplifier Factor(dB)
3. The other emission levels were very low against the limit.
4. Margin value = Emission Level – Limit value
5. " \* ": Fundamental frequency.
6. " # ": The radiated frequency is out of the restricted band.

**Below 1GHz Data:**

**802.11ac (VHT40)**

<b>CHANNEL</b>	TX Channel 54	<b>DETECTOR FUNCTION</b>	Quasi-Peak (QP)
<b>FREQUENCY RANGE</b>	9kHz ~ 1GHz		

**ANTENNA POLARITY & TEST DISTANCE: HORIZONTAL AT 3 M**

NO.	FREQ. (MHz)	EMISSION LEVEL (dBuV/m)	LIMIT (dBuV/m)	MARGIN (dB)	ANTENNA HEIGHT (m)	TABLE ANGLE (Degree)	RAW VALUE (dBuV)	CORRECTION FACTOR (dB/m)
1	49.50	32.9 QP	40.0	-7.1	1.00 H	144	40.9	-8.0
2	64.17	34.4 QP	40.0	-5.6	1.50 H	189	43.2	-8.8
3	85.46	34.7 QP	40.0	-5.3	2.50 H	302	48.4	-13.7
4	98.22	36.6 QP	43.5	-6.9	3.00 H	78	49.6	-13.0
5	359.97	36.4 QP	46.0	-9.6	1.00 H	170	42.6	-6.2
6	625.00	38.9 QP	46.0	-7.1	2.00 H	87	39.0	-0.1

**ANTENNA POLARITY & TEST DISTANCE: VERTICAL AT 3 M**

NO.	FREQ. (MHz)	EMISSION LEVEL (dBuV/m)	LIMIT (dBuV/m)	MARGIN (dB)	ANTENNA HEIGHT (m)	TABLE ANGLE (Degree)	RAW VALUE (dBuV)	CORRECTION FACTOR (dB/m)
1	64.75	36.2 QP	40.0	-3.8	1.00 V	177	45.1	-8.9
2	85.65	36.3 QP	40.0	-3.7	1.50 V	257	50.0	-13.7
3	137.06	33.8 QP	43.5	-9.7	2.00 V	143	42.2	-8.4
4	198.13	30.1 QP	43.5	-13.4	2.50 V	291	41.6	-11.5
5	359.99	35.9 QP	46.0	-10.1	1.00 V	54	42.1	-6.2
6	440.02	32.5 QP	46.0	-13.5	1.00 V	11	36.3	-3.8

**REMARKS:**

1. Emission Level(dBuV/m) = Raw Value(dBuV) + Correction Factor(dB/m)
2. Correction Factor(dB/m) = Antenna Factor(dB/m) + Cable Factor(dB) – Pre-Amplifier Factor(dB)
3. The other emission levels were very low against the limit.
4. Margin value = Emission Level – Limit value

#### 4.1.8 Test Results (Mode 2)

#### Above 1GHz Data:

#### 802.11a

<b>CHANNEL</b>	TX Channel 52	<b>DETECTOR FUNCTION</b>	Peak (PK)
<b>FREQUENCY RANGE</b>	1GHz ~ 40GHz		Average (AV)

ANTENNA POLARITY & TEST DISTANCE: HORIZONTAL AT 3 M								
NO.	FREQ. (MHz)	EMISSION LEVEL (dBuV/m)	LIMIT (dBuV/m)	MARGIN (dB)	ANTENNA HEIGHT (m)	TABLE ANGLE (Degree)	RAW VALUE (dBuV)	CORRECTION FACTOR (dB/m)
1	5150.00	51.9 PK	74.0	-22.1	1.00 H	296	47.9	4.0
2	5150.00	39.0 AV	54.0	-15.0	1.00 H	296	35.0	4.0
3	*5260.00	111.8 PK			1.00 H	296	107.6	4.2
4	*5260.00	101.8 AV			1.00 H	296	97.6	4.2
5	#10520.00	59.7 PK	74.0	-14.3	1.69 H	186	45.9	13.8
6	#10520.00	46.4 AV	54.0	-7.6	1.69 H	186	32.6	13.8
7	15780.00	49.4 PK	74.0	-24.6	1.06 H	87	35.3	14.1
8	15780.00	36.8 AV	54.0	-17.2	1.06 H	87	22.7	14.1

ANTENNA POLARITY & TEST DISTANCE: VERTICAL AT 3 M								
NO.	FREQ. (MHz)	EMISSION LEVEL (dBuV/m)	LIMIT (dBuV/m)	MARGIN (dB)	ANTENNA HEIGHT (m)	TABLE ANGLE (Degree)	RAW VALUE (dBuV)	CORRECTION FACTOR (dB/m)
1	5150.00	52.2 PK	74.0	-21.8	1.75 V	303	48.2	4.0
2	5150.00	39.4 AV	54.0	-14.6	1.75 V	303	35.4	4.0
3	*5260.00	112.1 PK			1.75 V	303	107.9	4.2
4	*5260.00	102.0 AV			1.75 V	303	97.8	4.2
5	#10520.00	63.9 PK	74.0	-10.1	1.44 V	342	50.1	13.8
6	#10520.00	51.2 AV	54.0	-2.8	1.44 V	342	37.4	13.8
7	15780.00	49.4 PK	74.0	-24.6	1.53 V	312	35.3	14.1
8	15780.00	36.6 AV	54.0	-17.4	1.53 V	312	22.5	14.1

#### REMARKS:

1. Emission Level(dBuV/m) = Raw Value(dBuV) + Correction Factor(dB/m)
2. Correction Factor(dB/m) = Antenna Factor(dB/m) + Cable Factor(dB) – Pre-Amplifier Factor(dB)
3. The other emission levels were very low against the limit.
4. Margin value = Emission Level – Limit value
5. " \* ": Fundamental frequency.
6. " # ": The radiated frequency is out of the restricted band.

<b>CHANNEL</b>	TX Channel 60	<b>DETECTOR FUNCTION</b>	Peak (PK)
<b>FREQUENCY RANGE</b>	1GHz ~ 40GHz		Average (AV)

**ANTENNA POLARITY & TEST DISTANCE: HORIZONTAL AT 3 M**

NO.	FREQ. (MHz)	EMISSION LEVEL (dBuV/m)	LIMIT (dBuV/m)	MARGIN (dB)	ANTENNA HEIGHT (m)	TABLE ANGLE (Degree)	RAW VALUE (dBuV)	CORRECTION FACTOR (dB/m)
1	*5300.00	112.2 PK			1.12 H	302	107.9	4.3
2	*5300.00	102.0 AV			1.12 H	302	97.7	4.3
3	10600.00	59.4 PK	74.0	-14.6	1.73 H	181	45.6	13.8
4	10600.00	46.3 AV	54.0	-7.7	1.73 H	181	32.5	13.8
5	15900.00	49.4 PK	74.0	-24.6	1.00 H	100	36.2	13.2
6	15900.00	36.7 AV	54.0	-17.3	1.00 H	100	23.5	13.2

**ANTENNA POLARITY & TEST DISTANCE: VERTICAL AT 3 M**

NO.	FREQ. (MHz)	EMISSION LEVEL (dBuV/m)	LIMIT (dBuV/m)	MARGIN (dB)	ANTENNA HEIGHT (m)	TABLE ANGLE (Degree)	RAW VALUE (dBuV)	CORRECTION FACTOR (dB/m)
1	*5300.00	112.5 PK			1.99 V	303	108.2	4.3
2	*5300.00	102.2 AV			1.99 V	303	97.9	4.3
3	10600.00	65.5 PK	74.0	-8.5	1.50 V	341	51.7	13.8
4	10600.00	52.3 AV	54.0	-1.7	1.50 V	341	38.5	13.8
5	15900.00	49.6 PK	74.0	-24.4	1.50 V	320	36.4	13.2
6	15900.00	36.8 AV	54.0	-17.2	1.50 V	320	23.6	13.2

**REMARKS:**

1. Emission Level(dBuV/m) = Raw Value(dBuV) + Correction Factor(dB/m)
2. Correction Factor(dB/m) = Antenna Factor(dB/m) + Cable Factor(dB) – Pre-Amplifier Factor(dB)
3. The other emission levels were very low against the limit.
4. Margin value = Emission Level – Limit value
5. " \* ": Fundamental frequency.

<b>CHANNEL</b>	TX Channel 64	<b>DETECTOR FUNCTION</b>	Peak (PK)
<b>FREQUENCY RANGE</b>	1GHz ~ 40GHz		Average (AV)

**ANTENNA POLARITY & TEST DISTANCE: HORIZONTAL AT 3 M**

NO.	FREQ. (MHz)	EMISSION LEVEL (dBuV/m)	LIMIT (dBuV/m)	MARGIN (dB)	ANTENNA HEIGHT (m)	TABLE ANGLE (Degree)	RAW VALUE (dBuV)	CORRECTION FACTOR (dB/m)
1	*5320.00	111.8 PK			1.03 H	217	107.5	4.3
2	*5320.00	101.8 AV			1.03 H	217	97.5	4.3
3	5350.00	64.5 PK	74.0	-9.5	1.03 H	217	60.1	4.4
4	5350.00	49.5 AV	54.0	-4.5	1.03 H	217	45.1	4.4
5	10640.00	58.7 PK	74.0	-15.3	1.76 H	188	44.7	14.0
6	10640.00	45.8 AV	54.0	-8.2	1.76 H	188	31.8	14.0
7	15960.00	49.2 PK	74.0	-24.8	1.00 H	88	35.7	13.5
8	15960.00	36.6 AV	54.0	-17.4	1.00 H	88	23.1	13.5

**ANTENNA POLARITY & TEST DISTANCE: VERTICAL AT 3 M**

NO.	FREQ. (MHz)	EMISSION LEVEL (dBuV/m)	LIMIT (dBuV/m)	MARGIN (dB)	ANTENNA HEIGHT (m)	TABLE ANGLE (Degree)	RAW VALUE (dBuV)	CORRECTION FACTOR (dB/m)
1	*5320.00	112.1 PK			1.99 V	303	107.8	4.3
2	*5320.00	102.0 AV			1.99 V	303	97.7	4.3
3	5350.00	64.8 PK	74.0	-9.2	1.99 V	303	60.4	4.4
4	5350.00	49.9 AV	54.0	-4.1	1.99 V	303	45.5	4.4
5	10640.00	64.5 PK	74.0	-9.5	1.44 V	339	50.5	14.0
6	10640.00	52.1 AV	54.0	-1.9	1.44 V	339	38.1	14.0
7	15960.00	49.7 PK	74.0	-24.3	1.54 V	319	36.2	13.5
8	15960.00	37.1 AV	54.0	-16.9	1.54 V	319	23.6	13.5

**REMARKS:**

1. Emission Level(dBuV/m) = Raw Value(dBuV) + Correction Factor(dB/m)
2. Correction Factor(dB/m) = Antenna Factor(dB/m) + Cable Factor(dB) – Pre-Amplifier Factor(dB)
3. The other emission levels were very low against the limit.
4. Margin value = Emission Level – Limit value
5. " \* ": Fundamental frequency.

<b>CHANNEL</b>	TX Channel 100	<b>DETECTOR FUNCTION</b>	Peak (PK)
<b>FREQUENCY RANGE</b>	1GHz ~ 40GHz		Average (AV)

**ANTENNA POLARITY & TEST DISTANCE: HORIZONTAL AT 3 M**

NO.	FREQ. (MHz)	EMISSION LEVEL (dBuV/m)	LIMIT (dBuV/m)	MARGIN (dB)	ANTENNA HEIGHT (m)	TABLE ANGLE (Degree)	RAW VALUE (dBuV)	CORRECTION FACTOR (dB/m)
1	#5470.00	67.0 PK	74.0	-7.0	1.00 H	293	62.5	4.5
2	#5470.00	53.2 AV	54.0	-0.8	1.00 H	293	48.7	4.5
3	*5500.00	111.5 PK			1.00 H	293	107.0	4.5
4	*5500.00	101.7 AV			1.00 H	293	97.2	4.5
5	11000.00	54.8 PK	74.0	-19.2	1.82 H	247	40.0	14.8
6	11000.00	42.1 AV	54.0	-11.9	1.82 H	247	27.3	14.8
7	#16500.00	52.8 PK	74.0	-21.2	1.50 H	300	37.2	15.6
8	#16500.00	39.3 AV	54.0	-14.7	1.50 H	300	23.7	15.6

**ANTENNA POLARITY & TEST DISTANCE: VERTICAL AT 3 M**

NO.	FREQ. (MHz)	EMISSION LEVEL (dBuV/m)	LIMIT (dBuV/m)	MARGIN (dB)	ANTENNA HEIGHT (m)	TABLE ANGLE (Degree)	RAW VALUE (dBuV)	CORRECTION FACTOR (dB/m)
1	#5470.00	67.8 PK	74.0	-6.2	1.99 V	297	63.3	4.5
2	#5470.00	53.9 AV	54.0	-0.1	1.99 V	297	49.4	4.5
3	*5500.00	112.5 PK			1.99 V	297	108.0	4.5
4	*5500.00	102.2 AV			1.99 V	297	97.7	4.5
5	11000.00	55.5 PK	74.0	-18.5	1.48 V	0	40.7	14.8
6	11000.00	42.8 AV	54.0	-11.2	1.48 V	0	28.0	14.8
7	#16500.00	52.6 PK	74.0	-21.4	1.50 V	20	37.0	15.6
8	#16500.00	39.2 AV	54.0	-14.8	1.50 V	20	23.6	15.6

**REMARKS:**

1. Emission Level(dBuV/m) = Raw Value(dBuV) + Correction Factor(dB/m)
2. Correction Factor(dB/m) = Antenna Factor(dB/m) + Cable Factor(dB) – Pre-Amplifier Factor(dB)
3. The other emission levels were very low against the limit.
4. Margin value = Emission Level – Limit value
5. " \* ": Fundamental frequency.
6. " # ": The radiated frequency is out of the restricted band.



<b>CHANNEL</b>	TX Channel 116	<b>DETECTOR FUNCTION</b>	Peak (PK)
<b>FREQUENCY RANGE</b>	1GHz ~ 40GHz		Average (AV)

**ANTENNA POLARITY & TEST DISTANCE: HORIZONTAL AT 3 M**

NO.	FREQ. (MHz)	EMISSION LEVEL (dBuV/m)	LIMIT (dBuV/m)	MARGIN (dB)	ANTENNA HEIGHT (m)	TABLE ANGLE (Degree)	RAW VALUE (dBuV)	CORRECTION FACTOR (dB/m)
1	*5580.00	111.8 PK			1.05 H	305	107.2	4.6
2	*5580.00	101.8 AV			1.05 H	305	97.2	4.6
3	11160.00	53.7 PK	74.0	-20.3	1.88 H	257	39.3	14.4
4	11160.00	40.9 AV	54.0	-13.1	1.88 H	257	26.5	14.4
5	#16740.00	51.9 PK	74.0	-22.1	1.55 H	315	35.4	16.5
6	#16740.00	38.6 AV	54.0	-15.4	1.55 H	315	22.1	16.5

**ANTENNA POLARITY & TEST DISTANCE: VERTICAL AT 3 M**

NO.	FREQ. (MHz)	EMISSION LEVEL (dBuV/m)	LIMIT (dBuV/m)	MARGIN (dB)	ANTENNA HEIGHT (m)	TABLE ANGLE (Degree)	RAW VALUE (dBuV)	CORRECTION FACTOR (dB/m)
1	*5580.00	112.8 PK			1.99 V	298	108.2	4.6
2	*5580.00	102.3 AV			1.99 V	298	97.7	4.6
3	11160.00	54.3 PK	74.0	-19.7	1.54 V	23	39.9	14.4
4	11160.00	41.9 AV	54.0	-12.1	1.54 V	23	27.5	14.4
5	#16740.00	51.9 PK	74.0	-22.1	1.45 V	22	35.4	16.5
6	#16740.00	38.3 AV	54.0	-15.7	1.45 V	22	21.8	16.5

**REMARKS:**

1. Emission Level(dBuV/m) = Raw Value(dBuV) + Correction Factor(dB/m)
2. Correction Factor(dB/m) = Antenna Factor(dB/m) + Cable Factor(dB) – Pre-Amplifier Factor(dB)
3. The other emission levels were very low against the limit.
4. Margin value = Emission Level – Limit value
5. " \* ": Fundamental frequency.
6. " # ": The radiated frequency is out of the restricted band.

<b>CHANNEL</b>	TX Channel 140	<b>DETECTOR FUNCTION</b>	Peak (PK)
<b>FREQUENCY RANGE</b>	1GHz ~ 40GHz		Average (AV)

**ANTENNA POLARITY & TEST DISTANCE: HORIZONTAL AT 3 M**

NO.	FREQ. (MHz)	EMISSION LEVEL (dBuV/m)	LIMIT (dBuV/m)	MARGIN (dB)	ANTENNA HEIGHT (m)	TABLE ANGLE (Degree)	RAW VALUE (dBuV)	CORRECTION FACTOR (dB/m)
1	*5700.00	109.7 PK			1.02 H	305	104.9	4.8
2	*5700.00	100.4 AV			1.02 H	305	95.6	4.8
3	#5725.00	68.6 PK	74.0	-5.4	1.02 H	305	63.7	4.9
4	#5725.00	53.2 AV	54.0	-0.8	1.02 H	305	48.3	4.9
5	11400.00	53.5 PK	74.0	-20.5	1.84 H	256	39.1	14.4
6	11400.00	40.7 AV	54.0	-13.3	1.84 H	256	26.3	14.4
7	#17100.00	52.4 PK	74.0	-21.6	1.50 H	308	33.9	18.5
8	#17100.00	39.1 AV	54.0	-14.9	1.50 H	308	20.6	18.5

**ANTENNA POLARITY & TEST DISTANCE: VERTICAL AT 3 M**

NO.	FREQ. (MHz)	EMISSION LEVEL (dBuV/m)	LIMIT (dBuV/m)	MARGIN (dB)	ANTENNA HEIGHT (m)	TABLE ANGLE (Degree)	RAW VALUE (dBuV)	CORRECTION FACTOR (dB/m)
1	*5700.00	110.7 PK			1.99 V	298	105.9	4.8
2	*5700.00	100.9 AV			1.99 V	298	96.1	4.8
3	#5725.00	69.4 PK	74.0	-4.6	1.99 V	298	64.5	4.9
4	#5725.00	<b>53.9 AV</b>	<b>54.0</b>	<b>-0.1</b>	<b>1.99 V</b>	<b>298</b>	<b>49.0</b>	<b>4.9</b>
5	11400.00	54.2 PK	74.0	-19.8	1.55 V	38	39.8	14.4
6	11400.00	41.9 AV	54.0	-12.1	1.55 V	38	27.5	14.4
7	#17100.00	51.9 PK	74.0	-22.1	1.45 V	20	33.4	18.5
8	#17100.00	38.5 AV	54.0	-15.5	1.45 V	20	20.0	18.5

**REMARKS:**

1. Emission Level(dBuV/m) = Raw Value(dBuV) + Correction Factor(dB/m)
2. Correction Factor(dB/m) = Antenna Factor(dB/m) + Cable Factor(dB) – Pre-Amplifier Factor(dB)
3. The other emission levels were very low against the limit.
4. Margin value = Emission Level – Limit value
5. " \* ": Fundamental frequency.
6. " # ": The radiated frequency is out of the restricted band.

**802.11ac (VHT20)**

<b>CHANNEL</b>	TX Channel 52	<b>DETECTOR FUNCTION</b>	Peak (PK)
<b>FREQUENCY RANGE</b>	1GHz ~ 40GHz		Average (AV)

**ANTENNA POLARITY & TEST DISTANCE: HORIZONTAL AT 3 M**

NO.	FREQ. (MHz)	EMISSION LEVEL (dBuV/m)	LIMIT (dBuV/m)	MARGIN (dB)	ANTENNA HEIGHT (m)	TABLE ANGLE (Degree)	RAW VALUE (dBuV)	CORRECTION FACTOR (dB/m)
1	5150.00	50.8 PK	74.0	-23.2	1.15 H	291	46.8	4.0
2	5150.00	38.4 AV	54.0	-15.6	1.15 H	291	34.4	4.0
3	*5260.00	110.5 PK			1.15 H	291	106.3	4.2
4	*5260.00	101.0 AV			1.15 H	291	96.8	4.2
5	#10520.00	58.9 PK	74.0	-15.1	1.75 H	166	45.1	13.8
6	#10520.00	45.9 AV	54.0	-8.1	1.75 H	166	32.1	13.8
7	15780.00	49.6 PK	74.0	-24.4	1.00 H	101	35.5	14.1
8	15780.00	36.7 AV	54.0	-17.3	1.00 H	101	22.6	14.1

**ANTENNA POLARITY & TEST DISTANCE: VERTICAL AT 3 M**

NO.	FREQ. (MHz)	EMISSION LEVEL (dBuV/m)	LIMIT (dBuV/m)	MARGIN (dB)	ANTENNA HEIGHT (m)	TABLE ANGLE (Degree)	RAW VALUE (dBuV)	CORRECTION FACTOR (dB/m)
1	5150.00	51.6 PK	74.0	-22.4	1.99 V	302	47.6	4.0
2	5150.00	39.1 AV	54.0	-14.9	1.99 V	302	35.1	4.0
3	*5260.00	111.5 PK			1.99 V	302	107.3	4.2
4	*5260.00	101.5 AV			1.99 V	302	97.3	4.2
5	#10520.00	64.6 PK	74.0	-9.4	1.47 V	332	50.8	13.8
6	#10520.00	52.2 AV	54.0	-1.8	1.47 V	332	38.4	13.8
7	15780.00	49.9 PK	74.0	-24.1	1.50 V	332	35.8	14.1
8	15780.00	37.2 AV	54.0	-16.8	1.50 V	332	23.1	14.1

**REMARKS:**

- Emission Level(dBuV/m) = Raw Value(dBuV) + Correction Factor(dB/m)
- Correction Factor(dB/m) = Antenna Factor(dB/m) + Cable Factor(dB) – Pre-Amplifier Factor(dB)
- The other emission levels were very low against the limit.
- Margin value = Emission Level – Limit value
- " \* ": Fundamental frequency.
- " # ": The radiated frequency is out of the restricted band.

<b>CHANNEL</b>	TX Channel 60	<b>DETECTOR FUNCTION</b>	Peak (PK)
<b>FREQUENCY RANGE</b>	1GHz ~ 40GHz		Average (AV)

**ANTENNA POLARITY & TEST DISTANCE: HORIZONTAL AT 3 M**

NO.	FREQ. (MHz)	EMISSION LEVEL (dBuV/m)	LIMIT (dBuV/m)	MARGIN (dB)	ANTENNA HEIGHT (m)	TABLE ANGLE (Degree)	RAW VALUE (dBuV)	CORRECTION FACTOR (dB/m)
1	*5300.00	110.5 PK			1.15 H	297	106.2	4.3
2	*5300.00	101.0 AV			1.15 H	297	96.7	4.3
3	10600.00	59.3 PK	74.0	-14.7	1.72 H	189	45.5	13.8
4	10600.00	45.9 AV	54.0	-8.1	1.72 H	189	32.1	13.8
5	15900.00	49.7 PK	74.0	-24.3	1.02 H	112	36.5	13.2
6	15900.00	37.1 AV	54.0	-16.9	1.02 H	112	23.9	13.2

**ANTENNA POLARITY & TEST DISTANCE: VERTICAL AT 3 M**

NO.	FREQ. (MHz)	EMISSION LEVEL (dBuV/m)	LIMIT (dBuV/m)	MARGIN (dB)	ANTENNA HEIGHT (m)	TABLE ANGLE (Degree)	RAW VALUE (dBuV)	CORRECTION FACTOR (dB/m)
1	*5300.00	111.5 PK			1.99 V	302	107.2	4.3
2	*5300.00	101.5 AV			1.99 V	302	97.2	4.3
3	10600.00	64.9 PK	74.0	-9.1	1.45 V	345	51.1	13.8
4	10600.00	52.3 AV	54.0	-1.7	1.45 V	345	38.5	13.8
5	15900.00	50.3 PK	74.0	-23.7	1.52 V	312	37.1	13.2
6	15900.00	37.4 AV	54.0	-16.6	1.52 V	312	24.2	13.2

**REMARKS:**

1. Emission Level(dBuV/m) = Raw Value(dBuV) + Correction Factor(dB/m)
2. Correction Factor(dB/m) = Antenna Factor(dB/m) + Cable Factor(dB) – Pre-Amplifier Factor(dB)
3. The other emission levels were very low against the limit.
4. Margin value = Emission Level – Limit value
5. " \* ": Fundamental frequency.

<b>CHANNEL</b>	TX Channel 64	<b>DETECTOR FUNCTION</b>	Peak (PK)
<b>FREQUENCY RANGE</b>	1GHz ~ 40GHz		Average (AV)

**ANTENNA POLARITY & TEST DISTANCE: HORIZONTAL AT 3 M**

NO.	FREQ. (MHz)	EMISSION LEVEL (dBuV/m)	LIMIT (dBuV/m)	MARGIN (dB)	ANTENNA HEIGHT (m)	TABLE ANGLE (Degree)	RAW VALUE (dBuV)	CORRECTION FACTOR (dB/m)
1	*5320.00	110.2 PK			1.09 H	288	105.9	4.3
2	*5320.00	100.7 AV			1.09 H	288	96.4	4.3
3	5350.00	60.7 PK	74.0	-13.3	1.09 H	288	56.3	4.4
4	5350.00	46.8 AV	54.0	-7.2	1.09 H	288	42.4	4.4
5	10640.00	59.6 PK	74.0	-14.4	1.73 H	173	45.6	14.0
6	10640.00	46.3 AV	54.0	-7.7	1.73 H	173	32.3	14.0
7	15960.00	49.5 PK	74.0	-24.5	1.00 H	108	36.0	13.5
8	15960.00	36.8 AV	54.0	-17.2	1.00 H	108	23.3	13.5

**ANTENNA POLARITY & TEST DISTANCE: VERTICAL AT 3 M**

NO.	FREQ. (MHz)	EMISSION LEVEL (dBuV/m)	LIMIT (dBuV/m)	MARGIN (dB)	ANTENNA HEIGHT (m)	TABLE ANGLE (Degree)	RAW VALUE (dBuV)	CORRECTION FACTOR (dB/m)
1	*5320.00	111.2 PK			1.99 V	301	106.9	4.3
2	*5320.00	101.2 AV			1.99 V	301	96.9	4.3
3	5350.00	61.5 PK	74.0	-12.5	1.99 V	301	57.1	4.4
4	5350.00	47.5 AV	54.0	-6.5	1.99 V	301	43.1	4.4
5	10640.00	64.4 PK	74.0	-9.6	1.43 V	339	50.4	14.0
6	10640.00	52.0 AV	54.0	-2.0	1.43 V	339	38.0	14.0
7	15960.00	49.9 PK	74.0	-24.1	1.59 V	324	36.4	13.5
8	15960.00	37.2 AV	54.0	-16.8	1.59 V	324	23.7	13.5

**REMARKS:**

1. Emission Level(dBuV/m) = Raw Value(dBuV) + Correction Factor(dB/m)
2. Correction Factor(dB/m) = Antenna Factor(dB/m) + Cable Factor(dB) – Pre-Amplifier Factor(dB)
3. The other emission levels were very low against the limit.
4. Margin value = Emission Level – Limit value
5. " \* ": Fundamental frequency.

<b>CHANNEL</b>	TX Channel 100	<b>DETECTOR FUNCTION</b>	Peak (PK)
<b>FREQUENCY RANGE</b>	1GHz ~ 40GHz		Average (AV)

**ANTENNA POLARITY & TEST DISTANCE: HORIZONTAL AT 3 M**

NO.	FREQ. (MHz)	EMISSION LEVEL (dBuV/m)	LIMIT (dBuV/m)	MARGIN (dB)	ANTENNA HEIGHT (m)	TABLE ANGLE (Degree)	RAW VALUE (dBuV)	CORRECTION FACTOR (dB/m)
1	#5470.00	66.7 PK	74.0	-7.3	1.17 H	285	62.2	4.5
2	#5470.00	52.9 AV	54.0	-1.1	1.17 H	285	48.4	4.5
3	*5500.00	110.3 PK			1.17 H	285	105.8	4.5
4	*5500.00	100.7 AV			1.17 H	285	96.2	4.5
5	11000.00	53.8 PK	74.0	-20.2	1.92 H	250	39.0	14.8
6	11000.00	41.2 AV	54.0	-12.8	1.92 H	250	26.4	14.8
7	#16500.00	51.7 PK	74.0	-22.3	1.56 H	305	36.1	15.6
8	#16500.00	38.2 AV	54.0	-15.8	1.56 H	305	22.6	15.6

**ANTENNA POLARITY & TEST DISTANCE: VERTICAL AT 3 M**

NO.	FREQ. (MHz)	EMISSION LEVEL (dBuV/m)	LIMIT (dBuV/m)	MARGIN (dB)	ANTENNA HEIGHT (m)	TABLE ANGLE (Degree)	RAW VALUE (dBuV)	CORRECTION FACTOR (dB/m)
1	#5470.00	67.5 PK	74.0	-6.5	1.99 V	300	63.0	4.5
2	#5470.00	53.6 AV	54.0	-0.4	1.99 V	300	49.1	4.5
3	*5500.00	111.3 PK			1.99 V	300	106.8	4.5
4	*5500.00	101.2 AV			1.99 V	300	96.7	4.5
5	11000.00	54.5 PK	74.0	-19.5	1.58 V	22	39.7	14.8
6	11000.00	42.2 AV	54.0	-11.8	1.58 V	22	27.4	14.8
7	#16500.00	51.9 PK	74.0	-22.1	1.39 V	26	36.3	15.6
8	#16500.00	38.4 AV	54.0	-15.6	1.39 V	26	22.8	15.6

**REMARKS:**

1. Emission Level(dBuV/m) = Raw Value(dBuV) + Correction Factor(dB/m)
2. Correction Factor(dB/m) = Antenna Factor(dB/m) + Cable Factor(dB) – Pre-Amplifier Factor(dB)
3. The other emission levels were very low against the limit.
4. Margin value = Emission Level – Limit value
5. " \* ": Fundamental frequency.
6. " # ": The radiated frequency is out of the restricted band.

<b>CHANNEL</b>	TX Channel 116	<b>DETECTOR FUNCTION</b>	Peak (PK)
<b>FREQUENCY RANGE</b>	1GHz ~ 40GHz		Average (AV)

**ANTENNA POLARITY & TEST DISTANCE: HORIZONTAL AT 3 M**

NO.	FREQ. (MHz)	EMISSION LEVEL (dBuV/m)	LIMIT (dBuV/m)	MARGIN (dB)	ANTENNA HEIGHT (m)	TABLE ANGLE (Degree)	RAW VALUE (dBuV)	CORRECTION FACTOR (dB/m)
1	*5580.00	110.8 PK			1.13 H	289	106.2	4.6
2	*5580.00	101.1 AV			1.13 H	289	96.5	4.6
3	11160.00	53.8 PK	74.0	-20.2	1.89 H	247	39.4	14.4
4	11160.00	41.1 AV	54.0	-12.9	1.89 H	247	26.7	14.4
5	#16740.00	52.3 PK	74.0	-21.7	1.53 H	329	35.8	16.5
6	#16740.00	38.8 AV	54.0	-15.2	1.53 H	329	22.3	16.5

**ANTENNA POLARITY & TEST DISTANCE: VERTICAL AT 3 M**

NO.	FREQ. (MHz)	EMISSION LEVEL (dBuV/m)	LIMIT (dBuV/m)	MARGIN (dB)	ANTENNA HEIGHT (m)	TABLE ANGLE (Degree)	RAW VALUE (dBuV)	CORRECTION FACTOR (dB/m)
1	*5580.00	111.8 PK			1.99 V	300	107.2	4.6
2	*5580.00	101.6 AV			1.99 V	300	97.0	4.6
3	11160.00	54.3 PK	74.0	-19.7	1.52 V	10	39.9	14.4
4	11160.00	41.7 AV	54.0	-12.3	1.52 V	10	27.3	14.4
5	#16740.00	52.0 PK	74.0	-22.0	1.49 V	31	35.5	16.5
6	#16740.00	38.1 AV	54.0	-15.9	1.49 V	31	21.6	16.5

**REMARKS:**

1. Emission Level(dBuV/m) = Raw Value(dBuV) + Correction Factor(dB/m)
2. Correction Factor(dB/m) = Antenna Factor(dB/m) + Cable Factor(dB) – Pre-Amplifier Factor(dB)
3. The other emission levels were very low against the limit.
4. Margin value = Emission Level – Limit value
5. " \* ": Fundamental frequency.
6. " # ": The radiated frequency is out of the restricted band.

<b>CHANNEL</b>	TX Channel 140	<b>DETECTOR FUNCTION</b>	Peak (PK)
<b>FREQUENCY RANGE</b>	1GHz ~ 40GHz		Average (AV)

**ANTENNA POLARITY & TEST DISTANCE: HORIZONTAL AT 3 M**

NO.	FREQ. (MHz)	EMISSION LEVEL (dBuV/m)	LIMIT (dBuV/m)	MARGIN (dB)	ANTENNA HEIGHT (m)	TABLE ANGLE (Degree)	RAW VALUE (dBuV)	CORRECTION FACTOR (dB/m)
1	*5700.00	109.5 PK			1.18 H	293	104.7	4.8
2	*5700.00	100.1 AV			1.18 H	293	95.3	4.8
3	#5725.00	69.0 PK	74.0	-5.0	1.18 H	293	64.1	4.9
4	#5725.00	53.2 AV	54.0	-0.8	1.18 H	293	48.3	4.9
5	11400.00	53.7 PK	74.0	-20.3	1.93 H	260	39.3	14.4
6	11400.00	40.6 AV	54.0	-13.4	1.93 H	260	26.2	14.4
7	#17100.00	51.8 PK	74.0	-22.2	1.60 H	330	33.3	18.5
8	#17100.00	38.5 AV	54.0	-15.5	1.60 H	330	20.0	18.5

**ANTENNA POLARITY & TEST DISTANCE: VERTICAL AT 3 M**

NO.	FREQ. (MHz)	EMISSION LEVEL (dBuV/m)	LIMIT (dBuV/m)	MARGIN (dB)	ANTENNA HEIGHT (m)	TABLE ANGLE (Degree)	RAW VALUE (dBuV)	CORRECTION FACTOR (dB/m)
1	*5700.00	110.5 PK			1.99 V	296	105.7	4.8
2	*5700.00	100.6 AV			1.99 V	296	95.8	4.8
3	#5725.00	69.8 PK	74.0	-4.2	1.99 V	296	64.9	4.9
4	#5725.00	<b>53.9 AV</b>	<b>54.0</b>	<b>-0.1</b>	<b>1.99 V</b>	<b>296</b>	<b>49.0</b>	<b>4.9</b>
5	11400.00	54.2 PK	74.0	-19.8	1.49 V	24	39.8	14.4
6	11400.00	41.8 AV	54.0	-12.2	1.49 V	24	27.4	14.4
7	#17100.00	52.0 PK	74.0	-22.0	1.43 V	37	33.5	18.5
8	#17100.00	38.1 AV	54.0	-15.9	1.43 V	37	19.6	18.5

**REMARKS:**

1. Emission Level(dBuV/m) = Raw Value(dBuV) + Correction Factor(dB/m)
2. Correction Factor(dB/m) = Antenna Factor(dB/m) + Cable Factor(dB) – Pre-Amplifier Factor(dB)
3. The other emission levels were very low against the limit.
4. Margin value = Emission Level – Limit value
5. " \* ": Fundamental frequency.
6. " # ": The radiated frequency is out of the restricted band.



**802.11ac (VHT40)**

<b>CHANNEL</b>	TX Channel 54	<b>DETECTOR FUNCTION</b>	Peak (PK)
<b>FREQUENCY RANGE</b>	1GHz ~ 40GHz		Average (AV)

**ANTENNA POLARITY & TEST DISTANCE: HORIZONTAL AT 3 M**

NO.	FREQ. (MHz)	EMISSION LEVEL (dBuV/m)	LIMIT (dBuV/m)	MARGIN (dB)	ANTENNA HEIGHT (m)	TABLE ANGLE (Degree)	RAW VALUE (dBuV)	CORRECTION FACTOR (dB/m)
1	5150.00	51.4 PK	74.0	-22.6	1.17 H	306	47.4	4.0
2	5150.00	39.2 AV	54.0	-14.8	1.17 H	306	35.2	4.0
3	*5270.00	108.9 PK			1.17 H	306	104.7	4.2
4	*5270.00	99.4 AV			1.17 H	306	95.2	4.2
5	#10540.00	54.0 PK	74.0	-20.0	1.87 H	268	40.3	13.7
6	#10540.00	41.3 AV	54.0	-12.7	1.87 H	268	27.6	13.7
7	15810.00	51.8 PK	74.0	-22.2	1.49 H	305	37.8	14.0
8	15810.00	38.6 AV	54.0	-15.4	1.49 H	305	24.6	14.0

**ANTENNA POLARITY & TEST DISTANCE: VERTICAL AT 3 M**

NO.	FREQ. (MHz)	EMISSION LEVEL (dBuV/m)	LIMIT (dBuV/m)	MARGIN (dB)	ANTENNA HEIGHT (m)	TABLE ANGLE (Degree)	RAW VALUE (dBuV)	CORRECTION FACTOR (dB/m)
1	5150.00	52.2 PK	74.0	-21.8	1.99 V	301	48.2	4.0
2	5150.00	39.9 AV	54.0	-14.1	1.99 V	301	35.9	4.0
3	*5270.00	109.9 PK			1.99 V	301	105.7	4.2
4	*5270.00	99.9 AV			1.99 V	301	95.7	4.2
5	#10540.00	54.3 PK	74.0	-19.7	1.51 V	29	40.6	13.7
6	#10540.00	41.7 AV	54.0	-12.3	1.51 V	29	28.0	13.7
7	15810.00	51.9 PK	74.0	-22.1	1.47 V	30	37.9	14.0
8	15810.00	38.1 AV	54.0	-15.9	1.47 V	30	24.1	14.0

**REMARKS:**

- Emission Level(dBuV/m) = Raw Value(dBuV) + Correction Factor(dB/m)
- Correction Factor(dB/m) = Antenna Factor(dB/m) + Cable Factor(dB) – Pre-Amplifier Factor(dB)
- The other emission levels were very low against the limit.
- Margin value = Emission Level – Limit value
- " \* ": Fundamental frequency.
- " # ": The radiated frequency is out of the restricted band.

<b>CHANNEL</b>	TX Channel 62	<b>DETECTOR FUNCTION</b>	Peak (PK)
<b>FREQUENCY RANGE</b>	1GHz ~ 40GHz		Average (AV)

**ANTENNA POLARITY & TEST DISTANCE: HORIZONTAL AT 3 M**

NO.	FREQ. (MHz)	EMISSION LEVEL (dBuV/m)	LIMIT (dBuV/m)	MARGIN (dB)	ANTENNA HEIGHT (m)	TABLE ANGLE (Degree)	RAW VALUE (dBuV)	CORRECTION FACTOR (dB/m)
1	*5310.00	103.6 PK			1.19 H	296	99.3	4.3
2	*5310.00	94.4 AV			1.19 H	296	90.1	4.3
3	5350.00	66.1 PK	74.0	-7.9	1.19 H	296	61.7	4.4
4	5350.00	53.2 AV	54.0	-0.8	1.19 H	296	48.8	4.4
5	10620.00	52.9 PK	74.0	-21.1	1.93 H	270	39.0	13.9
6	10620.00	40.7 AV	54.0	-13.3	1.93 H	270	26.8	13.9
7	15930.00	50.8 PK	74.0	-23.2	1.46 H	317	37.5	13.3
8	15930.00	37.0 AV	54.0	-17.0	1.46 H	317	23.7	13.3

**ANTENNA POLARITY & TEST DISTANCE: VERTICAL AT 3 M**

NO.	FREQ. (MHz)	EMISSION LEVEL (dBuV/m)	LIMIT (dBuV/m)	MARGIN (dB)	ANTENNA HEIGHT (m)	TABLE ANGLE (Degree)	RAW VALUE (dBuV)	CORRECTION FACTOR (dB/m)
1	*5310.00	104.6 PK			1.99 V	302	100.3	4.3
2	*5310.00	94.9 AV			1.99 V	302	90.6	4.3
3	5350.00	66.9 PK	74.0	-7.1	1.99 V	302	62.5	4.4
4	<b>5350.00</b>	<b>53.9 AV</b>	<b>54.0</b>	<b>-0.1</b>	<b>1.99 V</b>	<b>302</b>	<b>49.5</b>	<b>4.4</b>
5	10620.00	53.4 PK	74.0	-20.6	1.48 V	47	39.5	13.9
6	10620.00	41.2 AV	54.0	-12.8	1.48 V	47	27.3	13.9
7	15930.00	50.9 PK	74.0	-23.1	1.39 V	52	37.6	13.3
8	15930.00	37.3 AV	54.0	-16.7	1.39 V	52	24.0	13.3

**REMARKS:**

1. Emission Level(dBuV/m) = Raw Value(dBuV) + Correction Factor(dB/m)
2. Correction Factor(dB/m) = Antenna Factor(dB/m) + Cable Factor(dB) – Pre-Amplifier Factor(dB)
3. The other emission levels were very low against the limit.
4. Margin value = Emission Level – Limit value
5. " \* ": Fundamental frequency.

<b>CHANNEL</b>	TX Channel 102	<b>DETECTOR FUNCTION</b>	Peak (PK)
<b>FREQUENCY RANGE</b>	1GHz ~ 40GHz		Average (AV)

**ANTENNA POLARITY & TEST DISTANCE: HORIZONTAL AT 3 M**

NO.	FREQ. (MHz)	EMISSION LEVEL (dBuV/m)	LIMIT (dBuV/m)	MARGIN (dB)	ANTENNA HEIGHT (m)	TABLE ANGLE (Degree)	RAW VALUE (dBuV)	CORRECTION FACTOR (dB/m)
1	#5470.00	65.4 PK	74.0	-8.6	1.15 H	290	60.9	4.5
2	#5470.00	52.9 AV	54.0	-1.1	1.15 H	290	48.4	4.5
3	*5510.00	103.0 PK			1.15 H	290	98.4	4.6
4	*5510.00	93.7 AV			1.15 H	290	89.1	4.6
5	11020.00	52.2 PK	74.0	-21.8	1.89 H	270	37.5	14.7
6	11020.00	40.2 AV	54.0	-13.8	1.89 H	270	25.5	14.7
7	#16530.00	51.1 PK	74.0	-22.9	1.52 H	319	35.3	15.8
8	#16530.00	37.1 AV	54.0	-16.9	1.52 H	319	21.3	15.8

**ANTENNA POLARITY & TEST DISTANCE: VERTICAL AT 3 M**

NO.	FREQ. (MHz)	EMISSION LEVEL (dBuV/m)	LIMIT (dBuV/m)	MARGIN (dB)	ANTENNA HEIGHT (m)	TABLE ANGLE (Degree)	RAW VALUE (dBuV)	CORRECTION FACTOR (dB/m)
1	#5470.00	66.2 PK	74.0	-7.8	1.99 V	297	61.7	4.5
2	#5470.00	53.6 AV	54.0	-0.4	1.99 V	297	49.1	4.5
3	*5510.00	104.0 PK			1.99 V	297	99.4	4.6
4	*5510.00	94.2 AV			1.99 V	297	89.6	4.6
5	11020.00	52.8 PK	74.0	-21.2	1.54 V	45	38.1	14.7
6	11020.00	40.8 AV	54.0	-13.2	1.54 V	45	26.1	14.7
7	#16530.00	51.6 PK	74.0	-22.4	1.44 V	46	35.8	15.8
8	#16530.00	37.8 AV	54.0	-16.2	1.44 V	46	22.0	15.8

**REMARKS:**

1. Emission Level(dBuV/m) = Raw Value(dBuV) + Correction Factor(dB/m)
2. Correction Factor(dB/m) = Antenna Factor(dB/m) + Cable Factor(dB) – Pre-Amplifier Factor(dB)
3. The other emission levels were very low against the limit.
4. Margin value = Emission Level – Limit value
5. " \* ": Fundamental frequency.
6. " # ": The radiated frequency is out of the restricted band.

<b>CHANNEL</b>	TX Channel 110	<b>DETECTOR FUNCTION</b>	Peak (PK)
<b>FREQUENCY RANGE</b>	1GHz ~ 40GHz		Average (AV)

**ANTENNA POLARITY & TEST DISTANCE: HORIZONTAL AT 3 M**

NO.	FREQ. (MHz)	EMISSION LEVEL (dBuV/m)	LIMIT (dBuV/m)	MARGIN (dB)	ANTENNA HEIGHT (m)	TABLE ANGLE (Degree)	RAW VALUE (dBuV)	CORRECTION FACTOR (dB/m)
1	*5550.00	105.5 PK			1.15 H	306	101.0	4.5
2	*5550.00	96.4 AV			1.15 H	306	91.9	4.5
3	11100.00	53.5 PK	74.0	-20.5	1.92 H	259	39.1	14.4
4	11100.00	40.8 AV	54.0	-13.2	1.92 H	259	26.4	14.4
5	#16650.00	51.4 PK	74.0	-22.6	1.56 H	323	35.0	16.4
6	#16650.00	38.0 AV	54.0	-16.0	1.56 H	323	21.6	16.4

**ANTENNA POLARITY & TEST DISTANCE: VERTICAL AT 3 M**

NO.	FREQ. (MHz)	EMISSION LEVEL (dBuV/m)	LIMIT (dBuV/m)	MARGIN (dB)	ANTENNA HEIGHT (m)	TABLE ANGLE (Degree)	RAW VALUE (dBuV)	CORRECTION FACTOR (dB/m)
1	*5550.00	106.5 PK			1.99 V	298	102.0	4.5
2	*5550.00	96.9 AV			1.99 V	298	92.4	4.5
3	11100.00	54.2 PK	74.0	-19.8	1.54 V	16	39.8	14.4
4	11100.00	41.9 AV	54.0	-12.1	1.54 V	16	27.5	14.4
5	#16650.00	51.6 PK	74.0	-22.4	1.41 V	23	35.2	16.4
6	#16650.00	38.4 AV	54.0	-15.6	1.41 V	23	22.0	16.4

**REMARKS:**

1. Emission Level(dBuV/m) = Raw Value(dBuV) + Correction Factor(dB/m)
2. Correction Factor(dB/m) = Antenna Factor(dB/m) + Cable Factor(dB) – Pre-Amplifier Factor(dB)
3. The other emission levels were very low against the limit.
4. Margin value = Emission Level – Limit value
5. " \* ": Fundamental frequency.
6. " # ": The radiated frequency is out of the restricted band.

<b>CHANNEL</b>	TX Channel 134	<b>DETECTOR FUNCTION</b>	Peak (PK)
<b>FREQUENCY RANGE</b>	1GHz ~ 40GHz		Average (AV)

**ANTENNA POLARITY & TEST DISTANCE: HORIZONTAL AT 3 M**

NO.	FREQ. (MHz)	EMISSION LEVEL (dBuV/m)	LIMIT (dBuV/m)	MARGIN (dB)	ANTENNA HEIGHT (m)	TABLE ANGLE (Degree)	RAW VALUE (dBuV)	CORRECTION FACTOR (dB/m)
1	*5670.00	108.5 PK			1.18 H	296	103.7	4.8
2	*5670.00	98.8 AV			1.18 H	296	94.0	4.8
3	#5725.00	62.1 PK	74.0	-11.9	1.18 H	296	57.2	4.9
4	#5725.00	48.9 AV	54.0	-5.1	1.18 H	296	44.0	4.9
5	11340.00	53.6 PK	74.0	-20.4	1.87 H	242	39.2	14.4
6	11340.00	40.9 AV	54.0	-13.1	1.87 H	242	26.5	14.4
7	#17010.00	52.1 PK	74.0	-21.9	1.54 H	300	33.9	18.2
8	#17010.00	38.8 AV	54.0	-15.2	1.54 H	300	20.6	18.2

**ANTENNA POLARITY & TEST DISTANCE: VERTICAL AT 3 M**

NO.	FREQ. (MHz)	EMISSION LEVEL (dBuV/m)	LIMIT (dBuV/m)	MARGIN (dB)	ANTENNA HEIGHT (m)	TABLE ANGLE (Degree)	RAW VALUE (dBuV)	CORRECTION FACTOR (dB/m)
1	*5670.00	109.5 PK			1.89 V	298	104.7	4.8
2	*5670.00	99.3 AV			1.89 V	298	94.5	4.8
3	#5725.00	62.9 PK	74.0	-11.1	1.89 V	298	58.0	4.9
4	#5725.00	49.6 AV	54.0	-4.4	1.89 V	298	44.7	4.9
5	11340.00	54.7 PK	74.0	-19.3	1.54 V	10	40.3	14.4
6	11340.00	42.2 AV	54.0	-11.8	1.54 V	10	27.8	14.4
7	#17010.00	51.8 PK	74.0	-22.2	1.45 V	17	33.6	18.2
8	#17010.00	37.9 AV	54.0	-16.1	1.45 V	17	19.7	18.2

**REMARKS:**

1. Emission Level(dBuV/m) = Raw Value(dBuV) + Correction Factor(dB/m)
2. Correction Factor(dB/m) = Antenna Factor(dB/m) + Cable Factor(dB) – Pre-Amplifier Factor(dB)
3. The other emission levels were very low against the limit.
4. Margin value = Emission Level – Limit value
5. " \* ": Fundamental frequency.
6. " # ": The radiated frequency is out of the restricted band.

802.11ac (VHT80)

<b>CHANNEL</b>	TX Channel 58	<b>DETECTOR FUNCTION</b>	Peak (PK)
<b>FREQUENCY RANGE</b>	1GHz ~ 40GHz		Average (AV)

**ANTENNA POLARITY & TEST DISTANCE: HORIZONTAL AT 3 M**

NO.	FREQ. (MHz)	EMISSION LEVEL (dBuV/m)	LIMIT (dBuV/m)	MARGIN (dB)	ANTENNA HEIGHT (m)	TABLE ANGLE (Degree)	RAW VALUE (dBuV)	CORRECTION FACTOR (dB/m)
1	5150.00	51.9 PK	74.0	-22.1	1.14 H	306	47.9	4.0
2	5150.00	40.3 AV	54.0	-13.7	1.14 H	306	36.3	4.0
3	*5290.00	97.4 PK			1.14 H	306	93.1	4.3
4	*5290.00	87.1 AV			1.14 H	306	82.8	4.3
5	5350.00	66.1 PK	74.0	-7.9	1.14 H	306	61.7	4.4
6	5350.00	53.2 AV	54.0	-0.8	1.14 H	306	48.8	4.4
7	#10580.00	53.2 PK	74.0	-20.8	1.85 H	235	39.3	13.9
8	#10580.00	40.3 AV	54.0	-13.7	1.85 H	235	26.4	13.9
9	15870.00	50.8 PK	74.0	-23.2	1.49 H	310	37.4	13.4
10	15870.00	37.0 AV	54.0	-17.0	1.49 H	310	23.6	13.4

**ANTENNA POLARITY & TEST DISTANCE: VERTICAL AT 3 M**

NO.	FREQ. (MHz)	EMISSION LEVEL (dBuV/m)	LIMIT (dBuV/m)	MARGIN (dB)	ANTENNA HEIGHT (m)	TABLE ANGLE (Degree)	RAW VALUE (dBuV)	CORRECTION FACTOR (dB/m)
1	5150.00	52.7 PK	74.0	-21.3	1.89 V	302	48.7	4.0
2	5150.00	41.0 AV	54.0	-13.0	1.89 V	302	37.0	4.0
3	*5290.00	98.4 PK			1.89 V	302	94.1	4.3
4	*5290.00	87.6 AV			1.89 V	302	83.3	4.3
5	5350.00	66.9 PK	74.0	-7.1	1.89 V	302	62.5	4.4
<b>6</b>	<b>5350.00</b>	<b>53.9 AV</b>	<b>54.0</b>	<b>-0.1</b>	<b>1.89 V</b>	<b>302</b>	<b>49.5</b>	<b>4.4</b>
7	#10580.00	53.4 PK	74.0	-20.6	1.58 V	0	39.5	13.9
8	#10580.00	40.8 AV	54.0	-13.2	1.58 V	0	26.9	13.9
9	15870.00	51.3 PK	74.0	-22.7	1.45 V	11	37.9	13.4
10	15870.00	37.6 AV	54.0	-16.4	1.45 V	11	24.2	13.4

**REMARKS:**

- Emission Level(dBuV/m) = Raw Value(dBuV) + Correction Factor(dB/m)
- Correction Factor(dB/m) = Antenna Factor(dB/m) + Cable Factor(dB) – Pre-Amplifier Factor(dB)
- The other emission levels were very low against the limit.
- Margin value = Emission Level – Limit value
- " \* ": Fundamental frequency.
- " # ": The radiated frequency is out of the restricted band.

<b>CHANNEL</b>	TX Channel 106	<b>DETECTOR FUNCTION</b>	Peak (PK)
<b>FREQUENCY RANGE</b>	1GHz ~ 40GHz		Average (AV)

**ANTENNA POLARITY & TEST DISTANCE: HORIZONTAL AT 3 M**

NO.	FREQ. (MHz)	EMISSION LEVEL (dBuV/m)	LIMIT (dBuV/m)	MARGIN (dB)	ANTENNA HEIGHT (m)	TABLE ANGLE (Degree)	RAW VALUE (dBuV)	CORRECTION FACTOR (dB/m)
1	#5470.00	67.0 PK	74.0	-7.0	1.09 H	297	62.5	4.5
2	#5470.00	53.2 AV	54.0	-0.8	1.09 H	297	48.7	4.5
3	*5530.00	96.9 PK			1.09 H	297	92.4	4.5
4	*5530.00	87.2 AV			1.09 H	297	82.7	4.5
5	#5725.00	51.6 PK	74.0	-22.4	1.09 H	297	46.7	4.9
6	#5725.00	39.6 AV	54.0	-14.4	1.09 H	297	34.7	4.9
7	11060.00	52.8 PK	74.0	-21.2	1.82 H	219	38.3	14.5
8	11060.00	39.8 AV	54.0	-14.2	1.82 H	219	25.3	14.5
9	#16590.00	51.0 PK	74.0	-23.0	1.44 H	316	34.4	16.6
10	#16590.00	37.1 AV	54.0	-16.9	1.44 H	316	20.5	16.6

**ANTENNA POLARITY & TEST DISTANCE: VERTICAL AT 3 M**

NO.	FREQ. (MHz)	EMISSION LEVEL (dBuV/m)	LIMIT (dBuV/m)	MARGIN (dB)	ANTENNA HEIGHT (m)	TABLE ANGLE (Degree)	RAW VALUE (dBuV)	CORRECTION FACTOR (dB/m)
1	#5470.00	67.8 PK	74.0	-6.2	1.89 V	294	63.3	4.5
2	#5470.00	53.9 AV	54.0	-0.1	1.89 V	294	49.4	4.5
3	*5530.00	97.9 PK			1.89 V	294	93.4	4.5
4	*5530.00	87.7 AV			1.89 V	294	83.2	4.5
5	#5725.00	52.4 PK	74.0	-21.6	2.29 V	350	47.5	4.9
6	#5725.00	40.3 AV	54.0	-13.7	2.29 V	350	35.4	4.9
7	11060.00	53.3 PK	74.0	-20.7	1.62 V	0	38.8	14.5
8	11060.00	40.5 AV	54.0	-13.5	1.62 V	0	26.0	14.5
9	#16590.00	51.1 PK	74.0	-22.9	1.41 V	15	34.5	16.6
10	#16590.00	37.4 AV	54.0	-16.6	1.41 V	15	20.8	16.6

**REMARKS:**

1. Emission Level(dBuV/m) = Raw Value(dBuV) + Correction Factor(dB/m)
2. Correction Factor(dB/m) = Antenna Factor(dB/m) + Cable Factor(dB) – Pre-Amplifier Factor(dB)
3. The other emission levels were very low against the limit.
4. Margin value = Emission Level – Limit value
5. " \* ": Fundamental frequency.
6. " # ": The radiated frequency is out of the restricted band.

<b>CHANNEL</b>	TX Channel 122	<b>DETECTOR FUNCTION</b>	Peak (PK)
<b>FREQUENCY RANGE</b>	1GHz ~ 40GHz		Average (AV)

**ANTENNA POLARITY & TEST DISTANCE: HORIZONTAL AT 3 M**

NO.	FREQ. (MHz)	EMISSION LEVEL (dBuV/m)	LIMIT (dBuV/m)	MARGIN (dB)	ANTENNA HEIGHT (m)	TABLE ANGLE (Degree)	RAW VALUE (dBuV)	CORRECTION FACTOR (dB/m)
1	*5610.00	107.0 PK			1.17 H	286	102.3	4.7
2	*5610.00	96.8 AV			1.17 H	286	92.1	4.7
3	#5725.00	65.0 PK	74.0	-9.0	1.17 H	286	60.1	4.9
4	#5725.00	51.2 AV	54.0	-2.8	1.17 H	286	46.3	4.9
5	11220.00	59.5 PK	74.0	-14.5	1.68 H	169	45.1	14.4
6	11220.00	46.7 AV	54.0	-7.3	1.68 H	169	32.3	14.4
7	#16830.00	48.8 PK	74.0	-25.2	1.04 H	110	31.8	17.0
8	#16830.00	36.3 AV	54.0	-17.7	1.04 H	110	19.3	17.0

**ANTENNA POLARITY & TEST DISTANCE: VERTICAL AT 3 M**

NO.	FREQ. (MHz)	EMISSION LEVEL (dBuV/m)	LIMIT (dBuV/m)	MARGIN (dB)	ANTENNA HEIGHT (m)	TABLE ANGLE (Degree)	RAW VALUE (dBuV)	CORRECTION FACTOR (dB/m)
1	*5610.00	108.0 PK			1.89 V	299	103.3	4.7
2	*5610.00	97.3 AV			1.89 V	299	92.6	4.7
3	#5725.00	65.8 PK	74.0	-8.2	1.89 V	299	60.9	4.9
4	#5725.00	51.9 AV	54.0	-2.1	1.89 V	299	47.0	4.9
5	11220.00	64.9 PK	74.0	-9.1	1.44 V	325	50.5	14.4
6	11220.00	52.2 AV	54.0	-1.8	1.44 V	325	37.8	14.4
7	#16830.00	49.9 PK	74.0	-24.1	1.59 V	314	32.9	17.0
8	#16830.00	37.2 AV	54.0	-16.8	1.59 V	314	20.2	17.0

**REMARKS:**

1. Emission Level(dBuV/m) = Raw Value(dBuV) + Correction Factor(dB/m)
2. Correction Factor(dB/m) = Antenna Factor(dB/m) + Cable Factor(dB) – Pre-Amplifier Factor(dB)
3. The other emission levels were very low against the limit.
4. Margin value = Emission Level – Limit value
5. " \* ": Fundamental frequency.
6. " # ": The radiated frequency is out of the restricted band.



Below 1GHz Data:

802.11a

<b>CHANNEL</b>	TX Channel 100	<b>DETECTOR FUNCTION</b>	Quasi-Peak (QP)
<b>FREQUENCY RANGE</b>	30MHz ~ 1GHz		

**ANTENNA POLARITY & TEST DISTANCE: HORIZONTAL AT 3 M**

NO.	FREQ. (MHz)	EMISSION LEVEL (dBuV/m)	LIMIT (dBuV/m)	MARGIN (dB)	ANTENNA HEIGHT (m)	TABLE ANGLE (Degree)	RAW VALUE (dBuV)	CORRECTION FACTOR (dB/m)
1	31.79	36.5 QP	40.0	-3.5	1.00 H	185	45.9	-9.4
2	98.05	36.4 QP	43.5	-7.1	1.50 H	236	49.4	-13.0
3	359.97	36.6 QP	46.0	-9.4	1.50 H	217	42.8	-6.2
4	440.02	32.7 QP	46.0	-13.3	2.50 H	157	36.5	-3.8
5	480.01	32.6 QP	46.0	-13.4	1.00 H	276	35.6	-3.0
6	625.00	39.4 QP	46.0	-6.6	1.00 H	140	39.5	-0.1

**ANTENNA POLARITY & TEST DISTANCE: VERTICAL AT 3 M**

NO.	FREQ. (MHz)	EMISSION LEVEL (dBuV/m)	LIMIT (dBuV/m)	MARGIN (dB)	ANTENNA HEIGHT (m)	TABLE ANGLE (Degree)	RAW VALUE (dBuV)	CORRECTION FACTOR (dB/m)
1	65.02	36.3 QP	40.0	-3.7	1.00 V	256	45.3	-9.0
2	137.06	32.9 QP	43.5	-10.6	1.00 V	149	41.3	-8.4
3	196.86	30.6 QP	43.5	-12.9	2.00 V	294	42.0	-11.4
4	360.02	35.2 QP	46.0	-10.8	2.00 V	257	41.3	-6.1
5	439.99	31.9 QP	46.0	-14.1	1.50 V	246	35.7	-3.8
6	625.02	31.3 QP	46.0	-14.7	1.50 V	188	31.4	-0.1

**REMARKS:**

1. Emission Level(dBuV/m) = Raw Value(dBuV) + Correction Factor(dB/m)
2. Correction Factor(dB/m) = Antenna Factor(dB/m) + Cable Factor(dB) – Pre-Amplifier Factor(dB)
3. The other emission levels were very low against the limit.
4. Margin value = Emission Level – Limit value

## 4.2 Conducted Emission Measurement

### 4.2.1 Limits of Conducted Emission Measurement

Frequency (MHz)	Conducted Limit (dBuV)	
	Quasi-peak	Average
0.15 - 0.5	66 - 56	56 - 46
0.50 - 5.0	56	46
5.0 - 30.0	60	50

Note: 1. The lower limit shall apply at the transition frequencies.

2. The limit decreases in line with the logarithm of the frequency in the range of 0.15 to 0.50MHz.

### 4.2.2 Test Instruments

DESCRIPTION & MANUFACTURER	MODEL NO.	SERIAL NO.	CALIBRATED DATE	CALIBRATED UNTIL
Test Receiver R&S	ESCS 30	847124/029	Nov. 01, 2017	Oct. 31, 2018
Line-Impedance Stabilization Network (for EUT) R&S	ESH3-Z5	848773/004	<i>Nov. 15, 2017</i>	Nov. 14, 2018
Line-Impedance Stabilization Network (for Peripheral) R&S	ENV216	100072	June 03, 2017	June 02, 2018
50 ohms Terminator	N/A	EMC-02	Sep. 22, 2017	Sep. 21, 2018
RF Cable	5D-FB	COCCAB-001	Sep. 29, 2017	Sep. 28, 2018
10 dB PAD Mini-Circuits	HAT-10+	CONATT-004	June 18, 2017	June 17, 2018
Software BVADT	BVADT_Cond_ V7.3.7.4	NA	NA	NA

**Note:**

1. The calibration interval of the above test instruments are 12 months and the calibrations are traceable to NML/ROC and NIST/USA.
2. The test was performed in Shielded Room No. 1.
3. Tested Date: Nov. 29 to Dec. 08, 2017.

#### 4.2.3 Test Procedure

- The EUT was placed 0.4 meters from the conducting wall of the shielded room with EUT being connected to the power mains through a line impedance stabilization network (LISN). Other support units were connected to the power mains through another LISN. The two LISNs provide 50 ohm/ 50uH of coupling impedance for the measuring instrument.
- Both lines of the power mains connected to the EUT were checked for maximum conducted interference.
- The frequency range from 150kHz to 30MHz was searched. Emission levels under (Limit - 20dB) was not recorded.

**NOTE:** All modes of operation were investigated and the worst-case emissions are reported.

#### 4.2.4 Deviation from Test Standard

No deviation.

#### 4.2.5 Test Setup

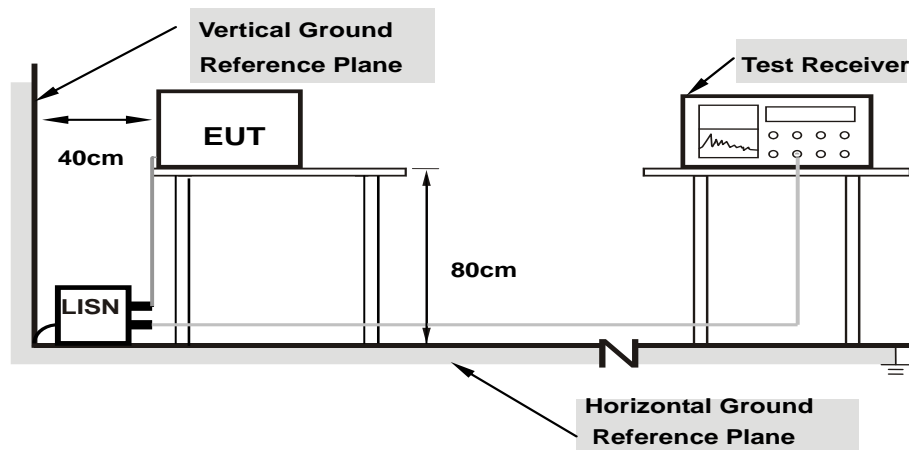

**Note: 1.Support units were connected to second LISN.**

For the actual test configuration, please refer to the attached file (Test Setup Photo).

#### 4.2.6 EUT Operating Condition

Same as 4.1.6.

#### 4.2.7 Test Results (Mode 1)

Phase	Line (L)	Detector Function	Quasi-Peak (QP) / Average (AV)
-------	----------	-------------------	--------------------------------

No	Freq. [MHz]	Corr. Factor	Reading Value [dB (uV)]		Emission Level [dB (uV)]		Limit [dB (uV)]		Margin (dB)	
		(dB)	Q.P.	AV.	Q.P.	AV.	Q.P.	AV.	Q.P.	AV.
	1	0.15781	10.07	47.05	29.97	57.12	40.04	65.58	55.58	-8.46
2	0.18516	10.06	42.88	27.01	52.94	37.07	64.25	54.25	-11.31	-17.18
3	0.50938	10.12	29.76	22.94	39.88	33.06	56.00	46.00	-16.12	-12.94
4	9.82813	10.61	25.32	19.36	35.93	29.97	60.00	50.00	-24.07	-20.03
5	15.80469	11.02	20.26	15.26	31.28	26.28	60.00	50.00	-28.72	-23.72
6	19.90234	11.29	21.20	11.70	32.49	22.99	60.00	50.00	-27.51	-27.01

#### REMARKS:

1. Q.P. and AV. are abbreviations of quasi-peak and average individually.
2. The emission levels of other frequencies were very low against the limit.
3. Margin value = Emission level - Limit value
4. Correction factor = Insertion loss + Cable loss
5. Emission Level = Correction Factor + Reading Value.

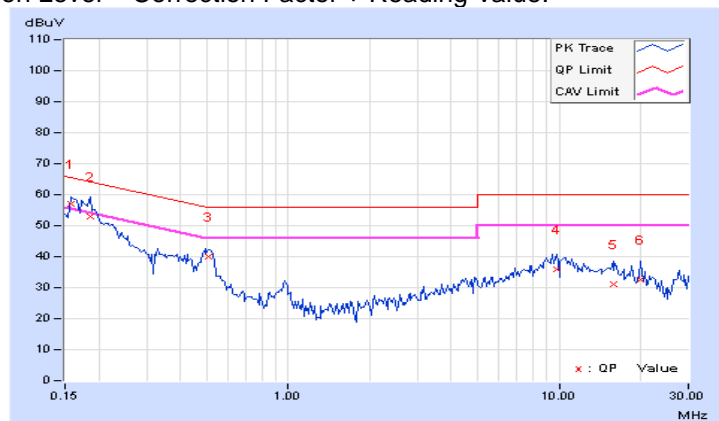

Phase	Neutral (N)	Detector Function	Quasi-Peak (QP) / Average (AV)
-------	-------------	-------------------	--------------------------------

No	Freq. [MHz]	Corr. Factor	Reading Value [dB (uV)]		Emission Level [dB (uV)]		Limit [dB (uV)]		Margin (dB)	
		(dB)	Q.P.	AV.	Q.P.	AV.	Q.P.	AV.	Q.P.	AV.
	<b>1</b>	<b>0.15000</b>	<b>10.07</b>	<b>48.77</b>	<b>31.47</b>	<b>58.84</b>	<b>41.54</b>	<b>66.00</b>	<b>56.00</b>	<b>-7.16</b>
2	0.16953	10.05	45.45	29.39	55.50	39.44	64.98	54.98	-9.48	-15.54
3	0.22031	10.04	36.61	20.20	46.65	30.24	62.81	52.81	-16.16	-22.57
4	0.50547	10.10	29.60	23.08	39.70	33.18	56.00	46.00	-16.30	-12.82
5	0.97422	10.12	16.71	9.51	26.83	19.63	56.00	46.00	-29.17	-26.37
6	9.19922	10.51	25.43	19.74	35.94	30.25	60.00	50.00	-24.06	-19.75

#### REMARKS:

1. Q.P. and AV. are abbreviations of quasi-peak and average individually.
2. The emission levels of other frequencies were very low against the limit.
3. Margin value = Emission level - Limit value
4. Correction factor = Insertion loss + Cable loss
5. Emission Level = Correction Factor + Reading Value.

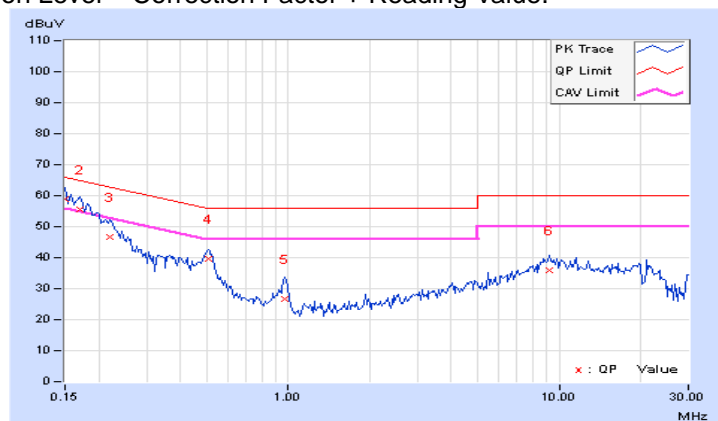

#### 4.2.8 Test Results (Mode 2)

Phase	Line (L)	Detector Function	Quasi-Peak (QP) / Average (AV)
-------	----------	-------------------	--------------------------------

No	Freq. [MHz]	Corr.	Reading Value		Emission Level		Limit		Margin	
		Factor	[dB (uV)]		[dB (uV)]		[dB (uV)]		(dB)	
	(dB)	Q.P.	AV.	Q.P.	AV.	Q.P.	AV.	Q.P.	AV.	
1	0.15000	0.14	46.12	29.43	46.26	29.57	66.00	56.00	-19.74	-26.43
2	0.17734	0.13	42.45	27.13	42.58	27.26	64.61	54.61	-22.03	-27.35
3	0.49375	0.19	27.10	21.23	27.29	21.42	56.10	46.10	-28.81	-24.68
4	0.98984	0.22	14.72	8.38	14.94	8.60	56.00	46.00	-41.06	-37.40
5	10.36719	0.69	27.05	21.05	27.74	21.74	60.00	50.00	-32.26	-28.26
6	25.87109	1.37	25.76	24.38	27.13	25.75	60.00	50.00	-32.87	-24.25

#### REMARKS:

1. Q.P. and AV. are abbreviations of quasi-peak and average individually.
2. The emission levels of other frequencies were very low against the limit.
3. Margin value = Emission level - Limit value
4. Correction factor = Insertion loss + Cable loss
5. Emission Level = Correction Factor + Reading Value.

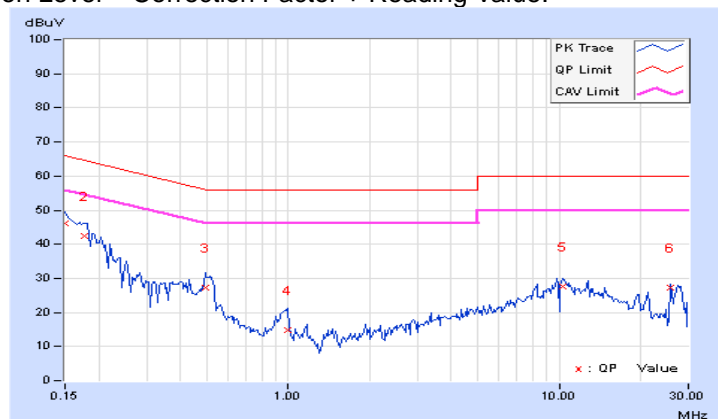

Phase	Neutral (N)	Detector Function	Quasi-Peak (QP) / Average (AV)
-------	-------------	-------------------	--------------------------------

No	Freq. [MHz]	Corr. Factor	Reading Value [dB (uV)]		Emission Level [dB (uV)]		Limit [dB (uV)]		Margin (dB)	
		(dB)	Q.P.	AV.	Q.P.	AV.	Q.P.	AV.	Q.P.	AV.
	1	0.15391	0.13	43.19	26.46	43.32	26.59	65.79	55.79	-22.47
2	0.18516	0.11	37.46	21.43	37.57	21.54	64.25	54.25	-26.68	-32.71
3	0.51328	0.17	28.18	21.54	28.35	21.71	56.00	46.00	-27.65	-24.29
4	0.96641	0.19	15.43	9.11	15.62	9.30	56.00	46.00	-40.38	-36.70
5	10.22266	0.62	24.26	18.73	24.88	19.35	60.00	50.00	-35.12	-30.65
6	28.91406	1.00	15.12	4.16	16.12	5.16	60.00	50.00	-43.88	-44.84

**REMARKS:**

1. Q.P. and AV. are abbreviations of quasi-peak and average individually.
2. The emission levels of other frequencies were very low against the limit.
3. Margin value = Emission level - Limit value
4. Correction factor = Insertion loss + Cable loss
5. Emission Level = Correction Factor + Reading Value.

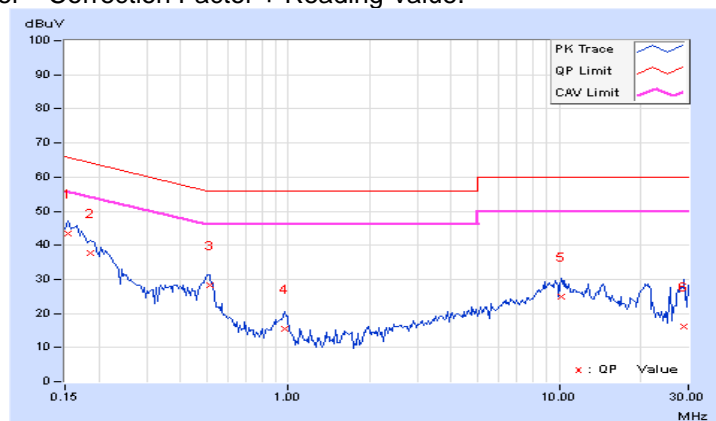

### 4.3 Transmit Power Measurement

#### 4.3.1 Limits of Transmit Power Measurement

Operation Band	EUT Category		Limit
U-NII-1		Outdoor Access Point	1 Watt (30 dBm) (Max. e.i.r.p $\leq$ 125mW(21 dBm) at any elevation angle above 30 degrees as measured from the horizon)
		Fixed point-to-point Access Point	1 Watt (30 dBm)
		Indoor Access Point	1 Watt (30 dBm)
		Mobile and Portable client device	250mW (24 dBm)
U-NII-2A		√	250mW (24 dBm) or 11 dBm+10 log B*
U-NII-2C		√	250mW (24 dBm) or 11 dBm+10 log B*
U-NII-3			1 Watt (30 dBm)

\*B is the 26 dB emission bandwidth in megahertz

Per KDB 662911 Method of conducted output power measurement on IEEE 802.11 devices,

Array Gain = 0 dB (i.e., no array gain) for  $N_{ANT} \leq 4$ ;

Array Gain = 0 dB (i.e., no array gain) for channel widths  $\geq 40$  MHz for any  $N_{ANT}$ ;

Array Gain =  $5 \log(N_{ANT}/N_{SS})$  dB or 3 dB, whichever is less for 20-MHz channel widths with  $N_{ANT} \geq 5$ .

For power measurements on all other devices: Array Gain =  $10 \log(N_{ANT}/N_{SS})$  dB.



#### 4.3.2 Test Setup

##### FOR POWER OUTPUT MEASUREMENT



##### FOR 26dB OCCUPIED BANDWIDTH

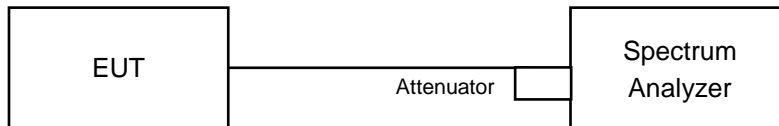

#### 4.3.3 Test Instruments

Refer to section 4.1.2 to get information of above instrument.

#### 4.3.4 Test Procedure

##### For Average Power Measurement

Method PM is used to perform output power measurement, trigger and gating function of wide band power meter is enabled to measure max output power of TX on burst. Duty factor is not added to measured value.

##### FOR 26dB OCCUPIED BANDWIDTH

1. Set RBW = approximately 1% of the emission bandwidth.
2. Set the VBW > RBW.
3. Detector = Peak.
4. Trace mode = max hold.
5. Measure the maximum width of the emission that is 26 dB down from the peak of the emission. Compare this with the RBW setting of the analyzer. Readjust RBW and repeat measurement as needed until the RBW/EBW ratio is approximately 1%.

#### 4.3.5 Deviation from Test Standard

No deviation.

#### 4.3.6 EUT Operating Condition

The software provided by client to enable the EUT under transmission condition continuously at lowest, middle and highest channel frequencies individually.

#### 4.3.7 Test Result (Mode 1)

#### CDD Mode

#### 802.11a

#### Power Output:

Chan.	Chan. Freq. (MHz)	Maximum Conducted Power (dBm)		Total Power (mW)	Total Power (dBm)	Limit (dBm)	Pass / Fail
		Chain 0	Chain 1				
52	5260	18.06	18.25	130.807	21.17	23.10	Pass
60	5300	18.13	18.45	134.997	21.30	23.10	Pass
64	5320	18.34	18.41	137.577	21.39	23.10	Pass
100	5500	17.41	16.82	103.165	20.14	23.35	Pass
116	5580	17.23	17.13	104.487	20.19	23.35	Pass
140	5700	16.98	16.83	98.083	19.92	23.35	Pass

Note: \* Test was performed in accordance with Measurement follow FCC KDB 789033 UNII test procedure Method SA-1 and use spectrum analyzer test.

1. UNII-2A: The Max. gain is 6.9dBi > 6dBi, therefore the limit needs to reduce, so the power limit shall be reduced to  $24-(6.9-6) = 23.10\text{dBm}$ .

2. UNII-2C: The Max. gain is 6.65dBi > 6dBi, therefore the limit needs to reduce, so the power limit shall be reduced to  $24-(6.65-6) = 23.35\text{dBm}$ .

#### 26dB BANDWIDTH:

Channel	Frequency (MHz)	26dBc Bandwidth (MHz)	
		Chain 0	Chain 1
52	5260	23.22	25.59
60	5300	23.60	24.53
64	5320	25.02	26.06
100	5500	24.60	22.95
116	5580	23.31	22.94
140	5700	23.34	23.66

Note: For U\_NII-2A, U\_NII-2C Band output power limitation is determined based on 26dBc bandwidth

Power Limit =  $11\text{dBm} + 10\log B < U\_NII-2A, U\_NII-2C >$

Channel Number	Freq.(MHz)	Min. B(MHz)	Determined Conducted Limit (dBm)
52	5260	23.22	24.65 > 24
60	5300	23.60	24.72 > 24
64	5320	25.02	24.98 > 24
100	5500	22.95	24.6 > 24
116	5580	22.94	24.6 > 24
140	5700	23.34	24.68 > 24

## 802.11ac (VHT20)

### POWER OUTPUT:

Chan.	Chan. Freq. (MHz)	Maximum Conducted Power (dBm)		Total Power (mW)	Total Power (dBm)	Limit (dBm)	Pass / Fail
		Chain 0	Chain 1				
52	5260	18.03	18.36	132.082	21.21	23.10	Pass
60	5300	18.18	18.44	135.589	21.32	23.10	Pass
64	5320	18.40	18.53	140.468	21.48	23.10	Pass
100	5500	17.32	16.94	103.382	20.14	23.35	Pass
116	5580	17.29	17.09	104.748	20.20	23.35	Pass
140	5700	17.03	16.78	98.109	19.92	23.35	Pass

Note: \* Test was performed in accordance with Measurement follow FCC KDB 789033 UNII test procedure Method SA-1 and use spectrum analyzer test.

1. UNII-2A: The Max. gain is 6.9dBi > 6dBi, therefore the limit needs to reduce, so the power limit shall be reduced to  $24 - (6.9 - 6) = 23.10\text{dBm}$ .

2. UNII-2C: The Max. gain is 6.65dBi > 6dBi, therefore the limit needs to reduce, so the power limit shall be reduced to  $24 - (6.65 - 6) = 23.35\text{dBm}$ .

### 26dB BANDWIDTH:

Channel	Frequency (MHz)	26dBc Bandwidth (MHz)	
		Chain 0	Chain 1
52	5260	24.42	29.66
60	5300	27.38	29.06
64	5320	29.21	26.23
100	5500	25.62	26.94
116	5580	23.80	23.78
140	5700	24.42	31.38

Note: For U-NII-2A, U-NII-2C Band output power limitation is determined based on 26dBc bandwidth

Power Limit = 11dBm + 10logB < U_NII-2A, U_NII-2C >			
Channel Number	Freq.(MHz)	Min. B(MHz)	Determined Conducted Limit (dBm)
52	5260	24.42	24.87 > 24
60	5300	27.38	25.37 > 24
64	5320	26.23	25.18 > 24
100	5500	25.62	25.08 > 24
116	5580	23.78	24.76 > 24
140	5700	24.42	24.87 > 24

### 802.11ac (VHT40)

#### POWER OUTPUT:

Chan.	Chan. Freq. (MHz)	Maximum Conducted Power (dBm)		Total Power (mW)	Total Power (dBm)	Limit (dBm)	Pass / Fail
		Chain 0	Chain 1				
54	5270	19.52	19.91	187.485	22.73	23.10	Pass
62	5310	17.16	17.25	105.088	20.22	23.10	Pass
102	5510	17.61	17.15	109.557	20.40	23.35	Pass
110	5550	20.07	19.76	196.249	22.93	23.35	Pass
134	5670	19.30	19.07	165.838	22.20	23.35	Pass

Note: \* Test was performed in accordance with Measurement follow FCC KDB 789033 UNII test procedure Method SA-2 and use spectrum analyzer test.

1. UNII-2A: The Max. gain is 6.9dBi > 6dBi, therefore the limit needs to reduce, so the power limit shall be reduced to  $24 - (6.9 - 6) = 23.10$ dBm.

2. UNII-2C: The Max. gain is 6.65dBi > 6dBi, therefore the limit needs to reduce, so the power limit shall be reduced to  $24 - (6.65 - 6) = 23.35$ dBm.

#### 26dB BANDWIDTH:

Channel	Frequency (MHz)	26dBc Bandwidth (MHz)	
		Chain 0	Chain 1
54	5270	82.40	84.09
62	5310	49.07	52.41
102	5510	49.85	47.00
110	5550	72.31	57.53
134	5670	75.69	78.07

**Note: For U\_NII-2A, U\_NII-2C Band output power limitation is determined based on 26dBc bandwidth**

Power Limit = 11dBm + 10logB < U_NII-2A, U_NII-2C >			
Channel Number	Freq.(MHz)	Min. B(MHz)	Determined Conducted Limit (dBm)
54	5270	82.40	30.15 > 24
62	5310	49.07	27.9 > 24
102	5510	47.00	27.72 > 24
110	5550	57.53	28.59 > 24
134	5670	75.69	29.79 > 24

## 802.11ac (VHT80)

### POWER OUTPUT:

Chan.	Chan. Freq. (MHz)	Maximum Conducted Power (dBm)		Total Power (mW)	Total Power (dBm)	Limit (dBm)	Pass / Fail
		Chain 0	Chain 1				
58	5290	16.82	17.06	98.9	19.95	23.10	Pass
106	5530	15.98	15.59	75.852	18.80	23.35	Pass
122	5610	20.16	19.55	193.91	22.88	23.35	Pass

Note: \* Test was performed in accordance with Measurement follow FCC KDB 789033 UNII test procedure Method SA-2 and use spectrum analyzer test.

1. UNII-2A: The Max. gain is 6.9dBi > 6dBi, therefore the limit needs to reduce, so the power limit shall be reduced to  $24 - (6.9 - 6) = 23.10\text{dBm}$ .

2. UNII-2C: The Max. gain is 6.65dBi > 6dBi, therefore the limit needs to reduce, so the power limit shall be reduced to  $24 - (6.65 - 6) = 23.35\text{dBm}$ .

### 26dB BANDWIDTH:

Channel	Frequency (MHz)	26dBc Bandwidth (MHz)	
		Chain 0	Chain 1
58	5290	89.86	90.65
106	5530	90.08	89.12
122	5610	137.36	114.46

**Note: For U\_NII-2A, U\_NII-2C Band output power limitation is determined based on 26dBc bandwidth**

Power Limit = $11\text{dBm} + 10\log B < U\_NII-2A, U\_NII-2C >$			
Channel Number	Freq.(MHz)	Min. B(MHz)	Determined Conducted Limit (dBm)
58	5290	89.86	30.53 > 24
106	5530	89.12	30.49 > 24
122	5610	114.46	31.58 > 24

### Spectrum Plot of Worst Value

#### 802.11a / Chain 1 - CH116

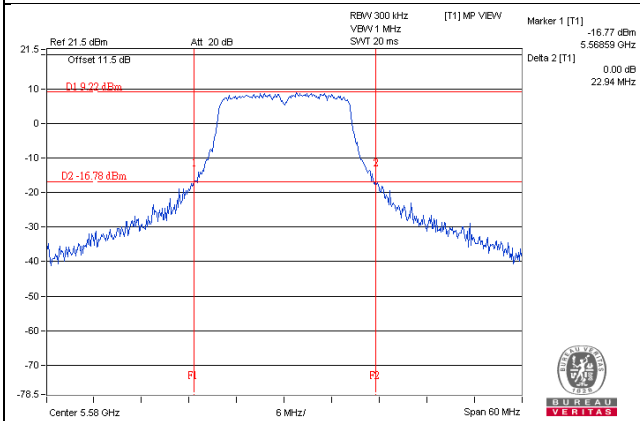

#### 802.11ac (VHT20) / Chain 1 - CH116

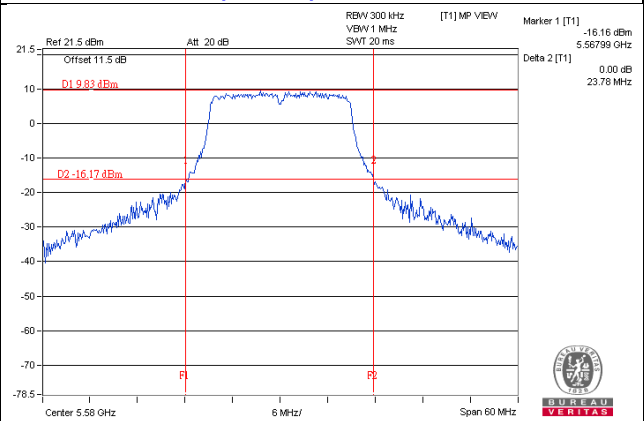

#### 802.11ac (VHT40) / Chain 1 - CH102

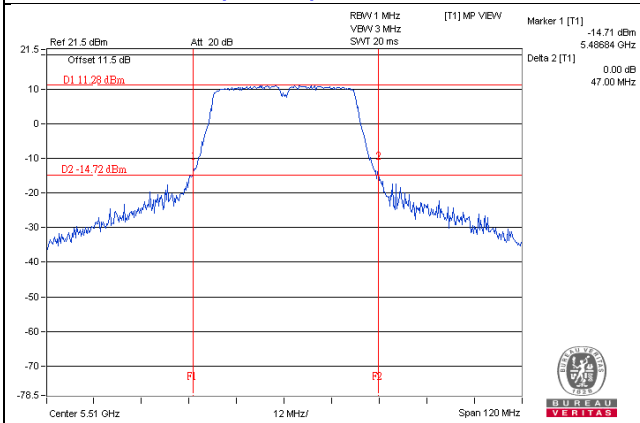

#### 802.11ac (VHT80) / Chain 1 - CH106

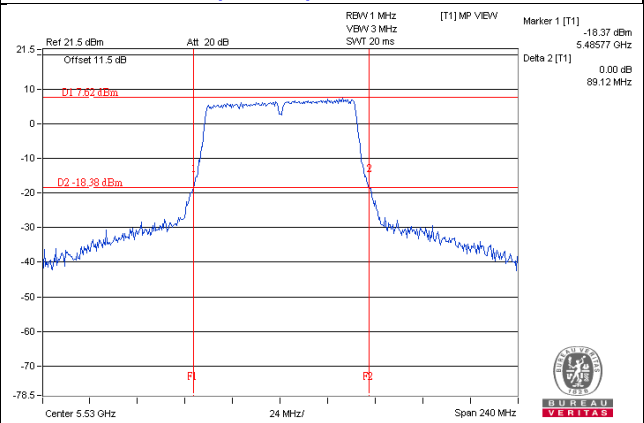



**Beamforming Mode**  
**802.11ac (VHT20)**  
**POWER OUTPUT:**

Chan.	Chan. Freq. (MHz)	Maximum Conducted Power (dBm)		Total Power (mW)	Total Power (dBm)	Limit (dBm)	Pass / Fail
		Chain 0	Chain 1				
52	5260	16.96	17.28	103.115	20.13	20.57	Pass
60	5300	17.11	17.32	105.355	20.23	20.57	Pass
64	5320	17.28	17.46	109.175	20.38	20.57	Pass
100	5500	17.32	16.94	103.382	20.14	21.17	Pass
116	5580	17.29	17.09	104.748	20.20	21.17	Pass
140	5700	17.03	16.78	98.109	19.92	21.17	Pass

Note: \* Test was performed in accordance with Measurement follow FCC KDB 789033 UNII test procedure Method SA-1 and use spectrum analyzer test.

1. UNII-2A: Directional gain =  $10 \log[(10^{G0/20} + 10^{G1/20})^2 / 2] = 9.43\text{dBi} > 6\text{dBi}$  , so the power limit shall be reduced to  $24-(9.43-6) = 20.57\text{dBm}$ .

2. UNII-2C: Directional gain =  $10 \log[(10^{G0/20} + 10^{G1/20})^2 / 2] = 8.83\text{dBi} > 6\text{dBi}$  , so the power limit shall be reduced to  $24-(8.83-6) = 21.17\text{dBm}$ .

**26dB BANDWIDTH:**

Channel	Frequency (MHz)	26dBc Bandwidth (MHz)	
		Chain 0	Chain 1
52	5260	24.42	29.66
60	5300	27.38	29.06
64	5320	29.21	26.23
100	5500	25.62	26.94
116	5580	23.80	23.78
140	5700	24.42	31.38

**Note: For U-NII-2A, U-NII-2C Band output power limitation is determined based on 26dBc bandwidth**

Power Limit = 11dBm + 10logB < U\_NII-2A, U\_NII-2C >

Channel Number	Freq.(MHz)	Min. B(MHz)	Determined Conducted Limit (dBm)
52	5260	24.42	24.87 > 24
60	5300	27.38	25.37 > 24
64	5320	26.23	25.18 > 24
100	5500	25.62	25.08 > 24
116	5580	23.78	24.76 > 24
140	5700	24.42	24.87 > 24

**802.11ac (VHT40)**
**POWER OUTPUT:**

Chan.	Chan. Freq. (MHz)	Maximum Conducted Power (dBm)		Total Power (mW)	Total Power (dBm)	Limit (dBm)	Pass / Fail
		Chain 0	Chain 1				
54	5270	17.28	17.36	107.906	20.33	20.57	Pass
62	5310	17.16	17.25	105.088	20.22	20.57	Pass
102	5510	17.13	16.73	98.74	19.94	21.17	Pass
110	5550	17.08	16.85	99.467	19.98	21.17	Pass
134	5670	17.19	17.17	104.479	20.19	21.17	Pass

Note: \* Test was performed in accordance with Measurement follow FCC KDB 789033 UNII test procedure Method SA-2 and use spectrum analyzer test.

1. UNII-2A: Directional gain =  $10 \log[(10^{G0/20} + 10^{G1/20})^2 / 2] = 9.43\text{dBi} > 6\text{dBi}$ , so the power limit shall be reduced to  $24 - (9.43 - 6) = 20.57\text{dBm}$ .

2. UNII-2C: Directional gain =  $10 \log[(10^{G0/20} + 10^{G1/20})^2 / 2] = 8.83\text{dBi} > 6\text{dBi}$ , so the power limit shall be reduced to  $24 - (8.83 - 6) = 21.17\text{dBm}$ .

**26dB BANDWIDTH:**

Channel	Frequency (MHz)	26dBc Bandwidth (MHz)	
		Chain 0	Chain 1
54	5270	82.40	84.09
62	5310	49.07	52.41
102	5510	49.85	47.00
110	5550	72.31	57.53
134	5670	75.69	78.07

**Note: For U\_NII-2A, U\_NII-2C Band output power limitation is determined based on 26dBc bandwidth**

Power Limit = 11dBm + 10logB < U_NII-2A, U_NII-2C >			
Channel Number	Freq.(MHz)	Min. B(MHz)	Determined Conducted Limit (dBm)
54	5270	82.40	30.15 > 24
62	5310	49.07	27.9 > 24
102	5510	47.00	27.72 > 24
110	5550	57.53	28.59 > 24
134	5670	75.69	29.79 > 24

## 802.11ac (VHT80)

### POWER OUTPUT:

Chan.	Chan. Freq. (MHz)	Maximum Conducted Power (dBm)		Total Power (mW)	Total Power (dBm)	Limit (dBm)	Pass / Fail
		Chain 0	Chain 1				
58	5290	16.82	17.06	98.9	19.95	20.57	Pass
106	5530	15.98	15.59	75.852	18.80	21.17	Pass
122	5610	16.97	16.84	98.08	19.92	21.17	Pass

Note: \* Test was performed in accordance with Measurement follow FCC KDB 789033 UNII test procedure Method SA-2 and use spectrum analyzer test.

1. UNII-2A: Directional gain =  $10 \log[(10^{G_{0/20}} + 10^{G_{1/20}})^2 / 2] = 9.43\text{dBi} > 6\text{dBi}$ , so the power limit shall be reduced to  $24 - (9.43 - 6) = 20.57\text{dBm}$ .

2. UNII-2C: Directional gain =  $10 \log[(10^{G_{0/20}} + 10^{G_{1/20}})^2 / 2] = 8.83\text{dBi} > 6\text{dBi}$ , so the power limit shall be reduced to  $24 - (8.83 - 6) = 21.17\text{dBm}$ .

### 26dB BANDWIDTH:

Channel	Frequency (MHz)	26dBc Bandwidth (MHz)	
		Chain 0	Chain 1
58	5290	89.86	90.65
106	5530	90.08	89.12
122	5610	137.36	114.46

Note: For U\_NII-2A, U\_NII-2C Band output power limitation is determined based on 26dBc bandwidth

Power Limit = $11\text{dBm} + 10\log B < U\_NII-2A, U\_NII-2C >$			
Channel Number	Freq.(MHz)	Min. B(MHz)	Determined Conducted Limit (dBm)
58	5290	89.86	30.53 > 24
106	5530	89.12	30.49 > 24
122	5610	114.46	31.58 > 24

#### 4.3.8 Test Result (Mode 2)

##### 802.11a

##### Power Output:

Channel	Channel Frequency (MHz)	Maximum Conducted Power (mW)	Maximum Conducted Power (dBm)	Power Limit (dBm)	Pass/Fail
52	5260	56.105	17.49	23.13	Pass
60	5300	56.624	17.53	23.13	Pass
64	5320	54.2	17.34	23.13	Pass
100	5500	66.374	18.22	23.73	Pass
116	5580	59.841	17.77	23.73	Pass
140	5700	50.234	17.01	23.73	Pass

Note: \* Test was performed in accordance with Measurement follow FCC KDB 789033 UNII test procedure Method SA-2 and use spectrum analyzer test.

1. UNII-2A: The Max. gain is 6.87dBi > 6dBi, therefore the limit needs to reduce, so the power limit shall be reduced to  $24 - (6.87 - 6) = 23.13\text{dBm}$ .
2. UNII-2C: The Max. gain is 6.27dBi > 6dBi, therefore the limit needs to reduce, so the power limit shall be reduced to  $24 - (6.27 - 6) = 23.73\text{dBm}$ .

##### 26dB OCCUPIED BANDWIDTH

Channel	Frequency (MHz)	26dBc Bandwidth (MHz)
52	5260	33.71
60	5300	35.07
64	5320	34.95
100	5500	36.04
116	5580	34.82
140	5700	35.19

**Note: For U-NII-2A, U-NII-2C Band output power limitation is determined based on 26dBc bandwidth**

Power Limit = $11\text{dBm} + 10\log B < \text{U-NII-2A, U-NII-2C} >$			
Channel Number	Freq.(MHz)	Min. B(MHz)	Determined Conducted Limit (dBm)
52	5260	33.71	26.27 > 24
60	5300	35.07	26.44 > 24
64	5320	34.95	26.43 > 24
100	5500	36.04	26.56 > 24
116	5580	34.82	26.41 > 24
140	5700	35.19	26.46 > 24

## 802.11ac (VHT20)

### Power Output:

Channel	Channel Frequency (MHz)	Maximum Conducted Power (mW)	Maximum Conducted Power (dBm)	Power Limit (dBm)	Pass/Fail
52	5260	51.88	17.15	23.13	Pass
60	5300	51.404	17.11	23.13	Pass
64	5320	49.431	16.94	23.13	Pass
100	5500	58.479	17.67	23.73	Pass
116	5580	57.677	17.61	23.73	Pass
140	5700	41.591	16.19	23.73	Pass

Note: \* Test was performed in accordance with Measurement follow FCC KDB 789033 UNII test procedure Method SA-2 and use spectrum analyzer test.

- UNII-2A: The Max. gain is 6.87dBi > 6dBi, therefore the limit needs to reduce, so the power limit shall be reduced to  $24 - (6.87 - 6) = 23.13\text{dBm}$ .
- UNII-2C: The Max. gain is 6.27dBi > 6dBi, therefore the limit needs to reduce, so the power limit shall be reduced to  $24 - (6.27 - 6) = 23.73\text{dBm}$ .

### 26dB OCCUPIED BANDWIDTH

Channel	Frequency (MHz)	26dBc Bandwidth (MHz)
52	5260	35.24
60	5300	33.32
64	5320	32.86
100	5500	36.88
116	5580	37.34
140	5700	32.30

Note: For U-NII-2A, U-NII-2C Band output power limitation is determined based on 26dBc bandwidth

Power Limit = $11\text{dBm} + 10\log B$ < U-NII-2A, U-NII-2C >			
Channel Number	Freq.(MHz)	Min. B(MHz)	Determined Conducted Limit (dBm)
52	5260	35.24	26.47 > 24
60	5300	33.32	26.22 > 24
64	5320	32.86	26.16 > 24
100	5500	36.88	26.66 > 24
116	5580	37.34	26.72 > 24
140	5700	32.30	26.09 > 24

## 802.11ac (VHT40)

### Power Output:

Channel	Channel Frequency (MHz)	Maximum Conducted Power (mW)	Maximum Conducted Power (dBm)	Power Limit (dBm)	Pass/Fail
54	5270	54.702	17.38	23.13	Pass
62	5310	21.086	13.24	23.13	Pass
102	5510	21.33	13.29	23.73	Pass
110	5550	58.614	17.68	23.73	Pass
134	5670	48.641	16.87	23.73	Pass

Note: \* Test was performed in accordance with Measurement follow FCC KDB 789033 UNII test procedure Method SA-2 and use spectrum analyzer test.

1. UNII-2A: The Max. gain is 6.87dBi > 6dBi, therefore the limit needs to reduce, so the power limit shall be reduced to  $24 - (6.87 - 6) = 23.13\text{dBm}$ .
2. UNII-2C: The Max. gain is 6.27dBi > 6dBi, therefore the limit needs to reduce, so the power limit shall be reduced to  $24 - (6.27 - 6) = 23.73\text{dBm}$ .

### 26dB OCCUPIED BANDWIDTH

Channel	Frequency (MHz)	26dBc Bandwidth (MHz)
54	5270	72.47
62	5310	52.43
102	5510	51.04
110	5550	74.45
134	5670	65.91

**Note: For U-NII-2A, U-NII-2C Band output power limitation is determined based on 26dBc bandwidth**

Power Limit = $11\text{dBm} + 10\log B$ < U-NII-2A, U-NII-2C >			
Channel Number	Freq.(MHz)	Min. B(MHz)	Determined Conducted Limit (dBm)
54	5270	72.47	29.6 > 24
62	5310	52.43	28.19 > 24
102	5510	51.04	28.07 > 24
110	5550	74.45	29.71 > 24
134	5670	65.91	29.18 > 24

## 802.11ac (VHT80)

### Power Output:

Channel	Channel Frequency (MHz)	Maximum Conducted Power (mW)	Maximum Conducted Power (dBm)	Power Limit (dBm)	Pass/Fail
58	5290	6.823	8.34	23.13	Pass
106	5530	6.918	8.40	23.73	Pass
122	5610	63.387	18.02	23.73	Pass

Note: \* Test was performed in accordance with Measurement follow FCC KDB 789033 UNII test procedure Method SA-2 and use spectrum analyzer test.

- UNII-2A: The Max. gain is 6.87dBi > 6dBi, therefore the limit needs to reduce, so the power limit shall be reduced to  $24 - (6.87 - 6) = 23.13\text{dBm}$ .
- UNII-2C: The Max. gain is 6.27dBi > 6dBi, therefore the limit needs to reduce, so the power limit shall be reduced to  $24 - (6.27 - 6) = 23.73\text{dBm}$ .

### 26dB OCCUPIED BANDWIDTH

Channel	Frequency (MHz)	26dBc Bandwidth (MHz)
58	5290	103.39
106	5530	98.17
122	5610	160.77

Note: For U-NII-2A, U-NII-2C Band output power limitation is determined based on 26dBc bandwidth

Power Limit = $11\text{dBm} + 10\log B < \text{U-NII-2A, U-NII-2C} >$			
Channel Number	Freq.(MHz)	Min. B(MHz)	Determined Conducted Limit (dBm)
58	5290	103.39	31.14 > 24
106	5530	98.17	30.91 > 24
122	5610	160.77	33.06 > 24



### Spectrum Plot of Worst Value

#### 802.11a: CH52

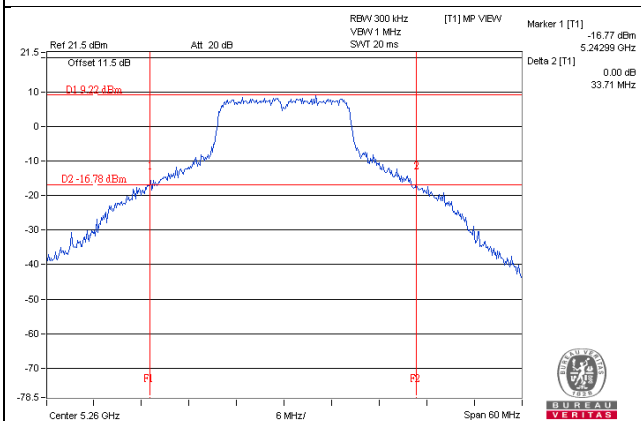

#### 802.11ac (VHT20) / CH140

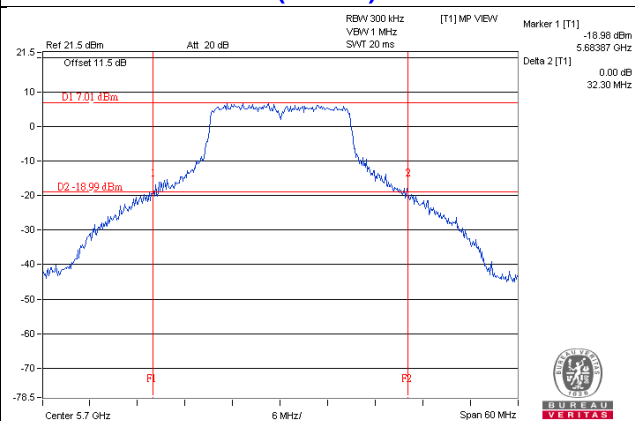

#### 802.11ac (VHT40) / CH102

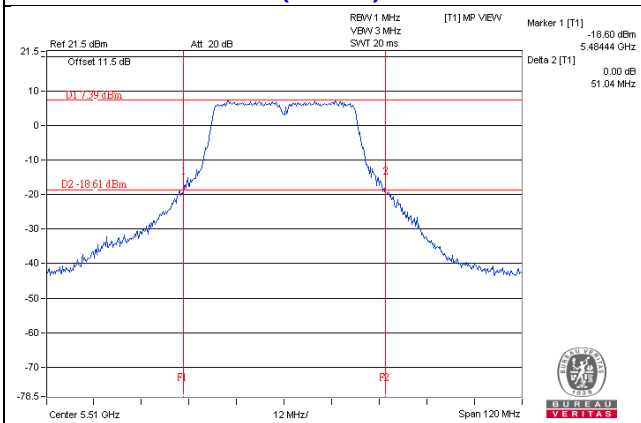

#### 802.11ac (VHT80) / CH106

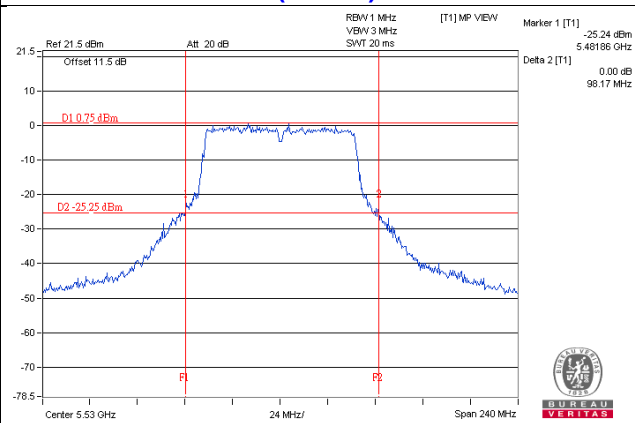

## 4.4 Occupied Bandwidth Measurement

### 4.4.1 Test Setup



### 4.4.2 Test Instruments

Refer to section 4.1.2 to get information of above instrument.

### 4.4.3 Test Procedure

The transmitter output was connected to the spectrum analyzer through an attenuator. The bandwidth of the fundamental frequency was measured by spectrum analyzer with resolution bandwidth in the range of 1% to 5% of the anticipated emission bandwidth, and a video bandwidth at least 3x the resolution bandwidth and set the detector to SAMPLE. The width of a frequency band such that, below the lower and above the upper frequency limits, the mean powers emitted are each equal to a specified percentage 0.5 %of the total mean power of a given emission.

## 4.4.4 Test Results (Mode 1)

## 802.11a

Channel	Channel Frequency (MHz)	Occupied Bandwidth (MHz)	
		Chain 0	Chain 1
52	5260	16.80	16.92
60	5300	16.80	16.80
64	5320	16.80	16.80
100	5500	16.80	16.80
116	5580	16.92	16.80
140	5700	16.80	16.92

## 802.11ac (VHT20)

Channel	Channel Frequency (MHz)	Occupied Bandwidth (MHz)	
		Chain 0	Chain 1
52	5260	18.00	18.00
60	5300	18.00	18.00
64	5320	18.12	18.12
100	5500	18.12	18.00
116	5580	18.00	18.12
140	5700	18.00	18.12

## 802.11ac (VHT40)

Channel	Channel Frequency (MHz)	Occupied Bandwidth (MHz)	
		Chain 0	Chain 1
54	5270	37.44	37.68
62	5310	36.96	36.72
102	5510	36.72	36.96
110	5550	37.20	36.96
134	5670	37.20	37.20

## 802.11ac (VHT80)

Channel	Channel Frequency (MHz)	Occupied Bandwidth (MHz)	
		Chain 0	Chain 1
58	5290	76.32	76.32
106	5530	75.84	76.32
122	5610	76.32	76.32

### Spectrum Plot of Worst Value

**802.11a\_Chain 0 / CH116**

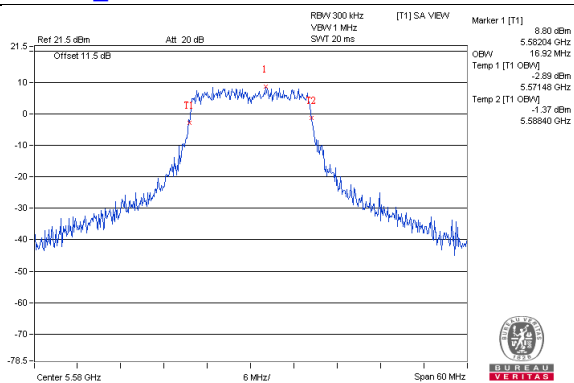

**802.11ac (VHT20)\_Chain 0 / CH64**

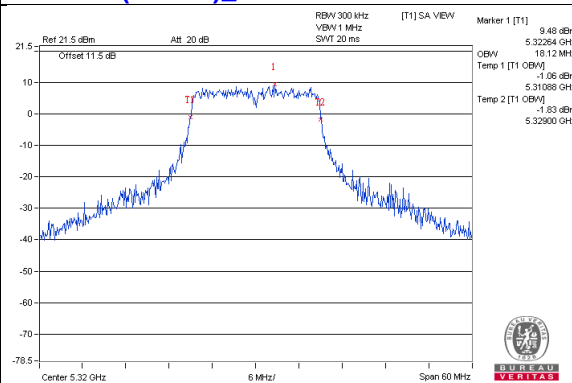

**802.11ac (VHT40)\_Chain 1 / CH54**

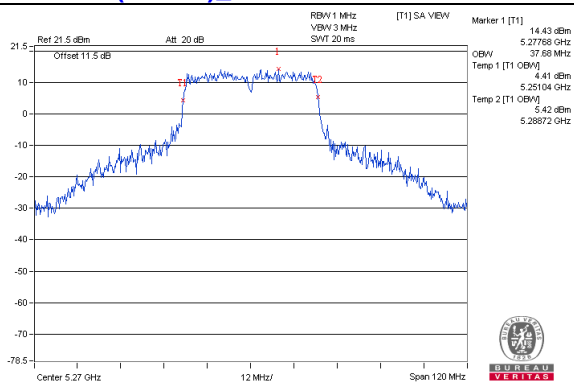

**802.11ac (VHT80)\_Chain 0 / CH58**

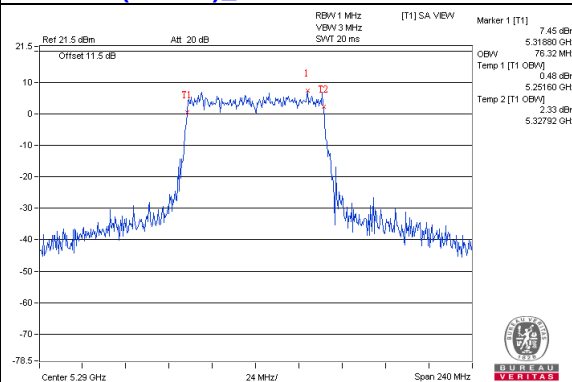

#### 4.4.5 Test Results (Mode 2)

##### 802.11a

Channel	Channel Frequency (MHz)	Occupied Bandwidth (MHz)
52	5260	19.08
60	5300	18.84
64	5320	18.48
100	5500	19.20
116	5580	19.20
140	5700	19.08

##### 802.11ac (VHT20)

Channel	Channel Frequency (MHz)	Occupied Bandwidth (MHz)
52	5260	18.72
60	5300	19.08
64	5320	18.96
100	5500	19.80
116	5580	19.20
140	5700	18.84

##### 802.11ac (VHT40)

Channel	Channel Frequency (MHz)	Occupied Bandwidth (MHz)
54	5270	38.16
62	5310	37.20
102	5510	36.96
110	5550	38.64
134	5670	37.68

##### 802.11ac (VHT80)

Channel	Channel Frequency (MHz)	Occupied Bandwidth (MHz)
58	5290	76.32
106	5530	76.32
122	5610	76.40

### Spectrum Plot of Worst Value

#### 802.11a : CH100

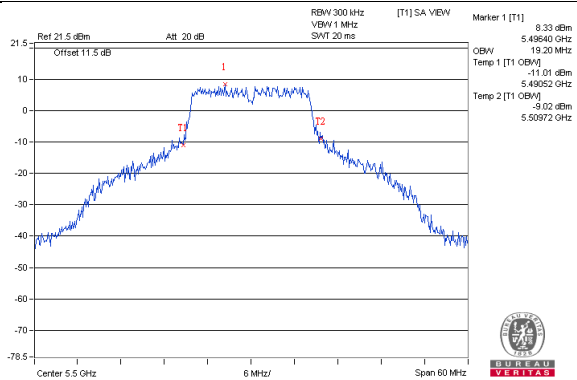

#### 802.11ac(VHT20) : CH100

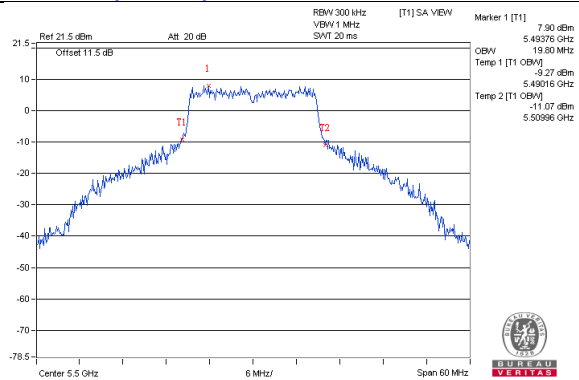

#### 802.11ac (VHT40) : CH110

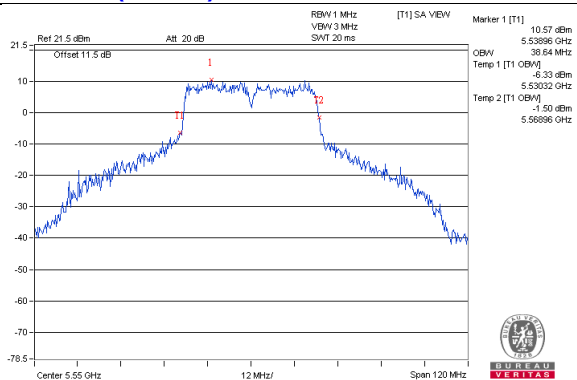

#### 802.11ac (VHT80) : CH122

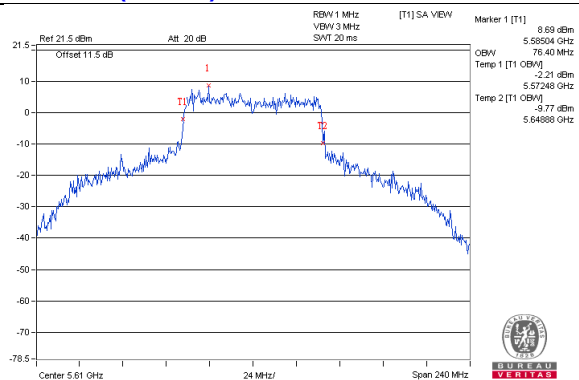

## 4.5 Peak Power Spectral Density Measurement

### 4.5.1 Limits of Peak Power Spectral Density Measurement

Operation Band	EUT Category		Limit
U-NII-1		Outdoor Access Point	17dBm/ MHz
		Fixed point-to-point Access Point	
		Indoor Access Point	
		Mobile and Portable client device	11dBm/ MHz
U-NII-2A	√		11dBm/ MHz
U-NII-2C	√		11dBm/ MHz
U-NII-3			30dBm/ 500kHz

### 4.5.2 Test Setup

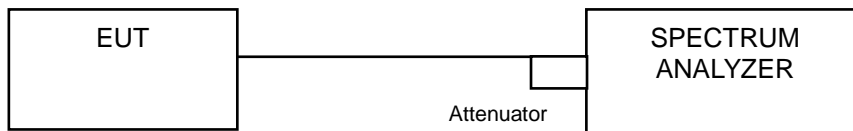

### 4.5.3 Test Instruments

Refer to section 4.1.2 to get information of above instrument.

#### 4.5.4 Test Procedure

##### Radio 2

##### 802.11a, 802.11ac (VHT20)

Using method SA-1

1. Set span to encompass the entire emission bandwidth (EBW) of the signal.
2. Set RBW = 1 MHz, Set VBW  $\geq$  3 MHz, Detector = RMS
3. Sweep time = auto, trigger set to "free run".
4. Trace average at least 100 traces in power averaging mode.
5. Record the max value

##### 802.11ac (VHT40), 802.11ac (VHT80)

Using method SA-2

1. Set span to encompass the entire emission bandwidth (EBW) of the signal.
2. Set RBW = 1 MHz, Set VBW  $\geq$  3 MHz, Detector = RMS
3. Sweep time = auto, trigger set to "free run".
4. Trace average at least 100 traces in power averaging mode.
5. Record the max value and add  $10 \log (1/\text{duty cycle})$

##### Radio 3

Using method SA-2

1. Set span to encompass the entire emission bandwidth (EBW) of the signal.
2. Set RBW = 1 MHz, Set VBW  $\geq$  3 MHz, Detector = RMS
3. Sweep time = auto, trigger set to "free run".
4. Trace average at least 100 traces in power averaging mode.
5. Record the max value and add  $10 \log (1/\text{duty cycle})$

#### 4.5.5 Deviation from Test Standard

No deviation.

#### 4.5.6 EUT Operating Condition

Same as Item 4.3.6.



#### 4.5.7 Test Results (Mode 1)

#### For UNII-2A, UNII-2C:

#### 802.11a

Chan.	Chan. Freq. (MHz)	PSD (dBm/MHz)		Total Power Density (dBm/MHz)	MAX. Limit (dBm/MHz)	Pass / Fail
		Chain 0	Chain 1			
52	5260	3.87	4.21	7.05	7.57	Pass
60	5300	4.57	4.36	7.48	7.57	Pass
64	5320	4.20	4.32	7.27	7.57	Pass
100	5500	4.09	3.46	6.80	8.17	Pass
116	5580	4.39	3.70	7.07	8.17	Pass
140	5700	3.84	4.05	6.96	8.17	Pass

- Note:** 1. Method a) of power density measurement of KDB 662911 is using for calculating total power density. Total power density is summing entire spectra across corresponding frequency bins on the various outputs by computer.
2. UNII-2A: Directional gain =  $10 \log[(10^{G0/20} + 10^{G1/20})^2 / 2] = 9.43\text{dBi} > 6\text{dBi}$ , so the power density limit shall be reduced to  $11-(9.43-6) = 7.57\text{dBm}$ .
3. UNII-2C: Directional gain =  $10 \log[(10^{G0/20} + 10^{G1/20})^2 / 2] = 8.83\text{dBi} > 6\text{dBi}$ , so the power density limit shall be reduced to  $11-(8.83-6) = 8.17\text{dBm}$ .

#### 802.11ac (VHT20)

Chan.	Chan. Freq. (MHz)	PSD (dBm/MHz)		Total Power Density (dBm/MHz)	MAX. Limit (dBm/MHz)	Pass / Fail
		Chain 0	Chain 1			
52	5260	4.44	4.26	7.36	7.57	Pass
60	5300	4.09	4.37	7.24	7.57	Pass
64	5320	4.20	4.27	7.25	7.57	Pass
100	5500	3.87	3.86	6.88	8.17	Pass
116	5580	3.56	4.10	6.85	8.17	Pass
140	5700	3.80	4.40	7.12	8.17	Pass

- Note:** 1. Method a) of power density measurement of KDB 662911 is using for calculating total power density. Total power density is summing entire spectra across corresponding frequency bins on the various outputs by computer.
2. UNII-2A: Directional gain =  $10 \log[(10^{G0/20} + 10^{G1/20})^2 / 2] = 9.43\text{dBi} > 6\text{dBi}$ , so the power density limit shall be reduced to  $11-(9.43-6) = 7.57\text{dBm}$ .
3. UNII-2C: Directional gain =  $10 \log[(10^{G0/20} + 10^{G1/20})^2 / 2] = 8.83\text{dBi} > 6\text{dBi}$ , so the power density limit shall be reduced to  $11-(8.83-6) = 8.17\text{dBm}$ .

### 802.11ac (VHT40)

Chan.	Chan. Freq. (MHz)	PSD W/O Duty Factor (dBm/MHz)		Duty Factor (dB)	Total PSD With Duty Factor (dBm/MHz)	MAX. Limit (dBm/MHz)	Pass / Fail
		Chain 0	Chain 1				
54	5270	3.74	4.18	0.16	7.13	7.57	Pass
62	5310	0.37	0.50	0.16	3.60	7.57	Pass
102	5510	0.60	0.02	0.16	3.49	8.17	Pass
110	5550	2.97	2.72	0.16	6.01	8.17	Pass
134	5670	2.23	2.31	0.16	5.44	8.17	Pass

- Note:**
- Method a) of power density measurement of KDB 662911 is using for calculating total power density. Total power density is summing entire spectra across corresponding frequency bins on the various outputs by computer.
  - UNII-2A: Directional gain =  $10 \log[(10^{G0/20} + 10^{G1/20})^2 / 2] = 9.43\text{dBi} > 6\text{dBi}$ , so the power density limit shall be reduced to  $11-(9.43-6) = 7.57\text{dBm}$ .
  - UNII-2C: Directional gain =  $10 \log[(10^{G0/20} + 10^{G1/20})^2 / 2] = 8.83\text{dBi} > 6\text{dBi}$ , so the power density limit shall be reduced to  $11-(8.83-6) = 8.17\text{dBm}$ .
  - Refer to section 3.3 for duty cycle spectrum plot.

### 802.11ac (VHT80)

Chan.	Chan. Freq. (MHz)	PSD W/O Duty Factor (dBm/MHz)		Duty Factor (dB)	Total PSD With Duty Factor (dBm/MHz)	MAX. Limit (dBm/MHz)	Pass / Fail
		Chain 0	Chain 1				
58	5290	-3.54	-4.01	0.29	-0.47	7.57	Pass
106	5530	-4.28	-4.09	0.29	-0.88	8.17	Pass
122	5610	-0.48	-1.49	0.29	2.34	8.17	Pass

- Note:**
- Method a) of power density measurement of KDB 662911 is using for calculating total power density. Total power density is summing entire spectra across corresponding frequency bins on the various outputs by computer.
  - UNII-2A: Directional gain =  $10 \log[(10^{G0/20} + 10^{G1/20})^2 / 2] = 9.43\text{dBi} > 6\text{dBi}$ , so the power density limit shall be reduced to  $11-(9.43-6) = 7.57\text{dBm}$ .
  - UNII-2C: Directional gain =  $10 \log[(10^{G0/20} + 10^{G1/20})^2 / 2] = 8.83\text{dBi} > 6\text{dBi}$ , so the power density limit shall be reduced to  $11-(8.83-6) = 8.17\text{dBm}$ .
  - Refer to section 3.3 for duty cycle spectrum plot.

Spectrum Plot of Worst Value

802.11a\_Chain 0 / CH60

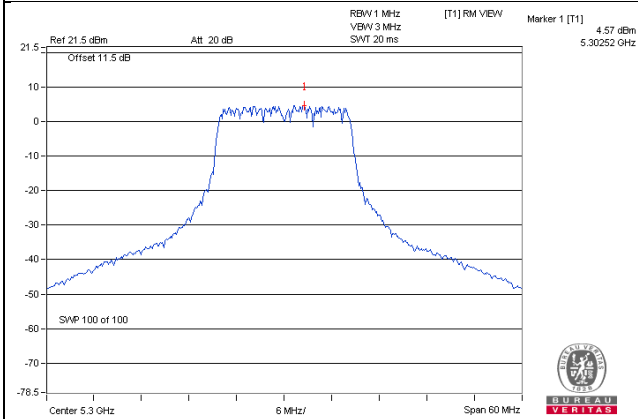

802.11ac (VHT20)\_Chain 0 / CH52

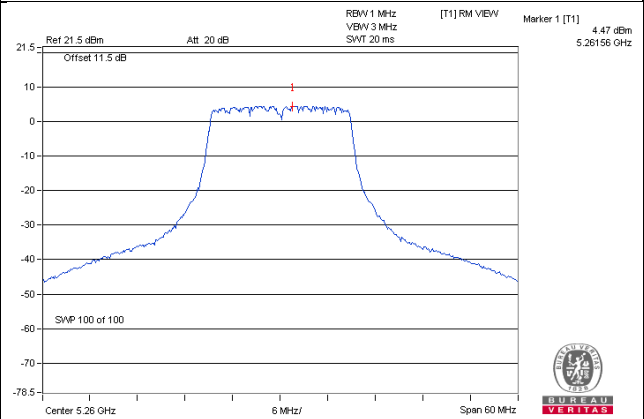

802.11ac (VHT40)\_Chain 1 / CH54

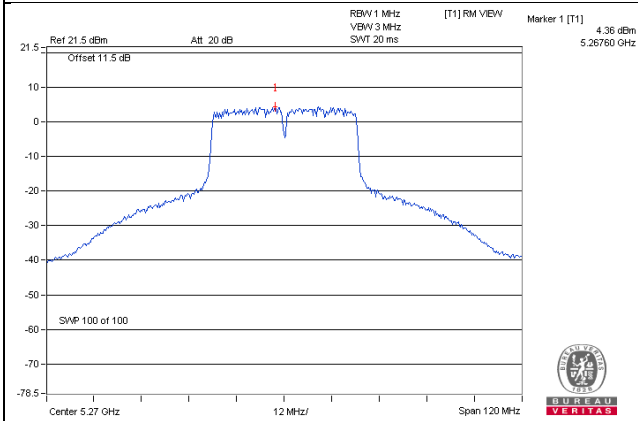

802.11ac (VHT80)\_Chain 0 / CH122

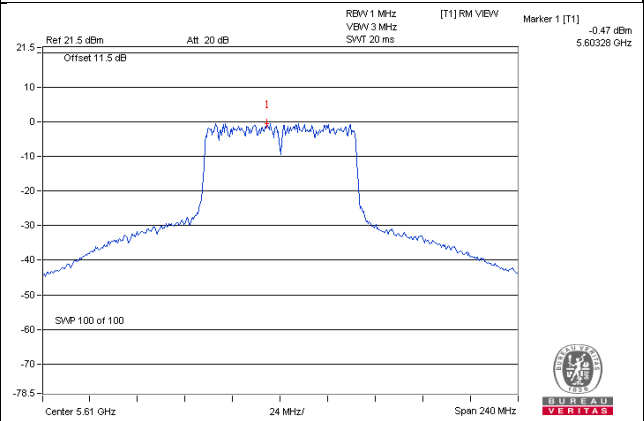

#### 4.5.8 Test Results (Mode 2)

##### For UNII-2A, UNII-2C:

##### 802.11a

Chan.	Chan. Freq. (MHz)	PSD W/O Duty Factor (dBm/MHz)	Duty Factor (dB)	PSD With Duty Factor (dBm/MHz)	MAX. Limit (dBm/MHz)	Pass / Fail
52	5260	2.99	0.17	3.16	10.13	Pass
60	5300	3.07	0.17	3.24	10.13	Pass
64	5320	3.02	0.17	3.19	10.13	Pass
100	5500	3.83	0.17	4.00	10.73	Pass
116	5580	3.14	0.17	3.31	10.73	Pass
140	5700	2.22	0.17	2.39	10.73	Pass

- Note:** 1. UNII-2A: Max. gain = 6.87dBi > 6dBi , so the power density limit shall be reduced to  $11-(6.87-6) = 10.13\text{dBm}$ .
2. UNII-2C: Max. gain = 6.27dBi > 6dBi , so the power density limit shall be reduced to  $11-(6.27-6) = 10.73\text{dBm}$ .
3. Refer to section 3.3 for duty cycle spectrum plot.

##### 802.11ac (VHT20)

Chan.	Chan. Freq. (MHz)	PSD W/O Duty Factor (dBm/MHz)	Duty Factor (dB)	PSD With Duty Factor (dBm/MHz)	MAX. Limit (dBm/MHz)	Pass / Fail
52	5260	2.23	0.17	2.40	10.13	Pass
60	5300	2.28	0.17	2.45	10.13	Pass
64	5320	2.17	0.17	2.34	10.13	Pass
100	5500	3.38	0.17	3.55	10.73	Pass
116	5580	3.17	0.17	3.34	10.73	Pass
140	5700	1.23	0.17	1.40	10.73	Pass

- Note:** 1. UNII-2A: Max. gain = 6.87dBi > 6dBi , so the power density limit shall be reduced to  $11-(6.87-6) = 10.13\text{dBm}$ .
2. UNII-2C: Max. gain = 6.27dBi > 6dBi , so the power density limit shall be reduced to  $11-(6.27-6) = 10.73\text{dBm}$ .
3. Refer to section 3.3 for duty cycle spectrum plot.

### 802.11ac (VHT40)

Chan.	Chan. Freq. (MHz)	PSD W/O Duty Factor (dBm/MHz)	Duty Factor (dB)	PSD With Duty Factor (dBm/MHz)	MAX. Limit (dBm/MHz)	Pass / Fail
54	5270	-0.46	0.33	-0.13	10.13	Pass
62	5310	-4.45	0.33	-4.12	10.13	Pass
102	5510	-4.19	0.33	-3.85	10.73	Pass
110	5550	0.29	0.33	0.63	10.73	Pass
134	5670	-1.67	0.33	-1.33	10.73	Pass

- Note:**
1. UNII-2A: Max. gain = 6.87dBi > 6dBi , so the power density limit shall be reduced to  $11-(6.87-6) = 10.13\text{dBm}$ .
  2. UNII-2C: Max. gain = 6.27dBi > 6dBi , so the power density limit shall be reduced to  $11-(6.27-6) = 10.73\text{dBm}$ .
  3. Refer to section 3.3 for duty cycle spectrum plot.

### 802.11ac (VHT80)

Chan.	Chan. Freq. (MHz)	PSD W/O Duty Factor (dBm/MHz)	Duty Factor (dB)	PSD With Duty Factor (dBm/MHz)	MAX. Limit (dBm/MHz)	Pass / Fail
58	5290	-13.03	0.70	-12.33	10.13	Pass
106	5530	-11.91	0.70	-11.21	10.73	Pass
122	5610	-3.00	0.70	-2.30	10.73	Pass

- Note:**
1. UNII-2A: Max. gain = 6.87dBi > 6dBi , so the power density limit shall be reduced to  $11-(6.87-6) = 10.13\text{dBm}$ .
  2. UNII-2C: Max. gain = 6.27dBi > 6dBi , so the power density limit shall be reduced to  $11-(6.27-6) = 10.73\text{dBm}$ .
  3. Refer to section 3.3 for duty cycle spectrum plot.

### Spectrum Plot of Worst Value

**802.11a / CH100**

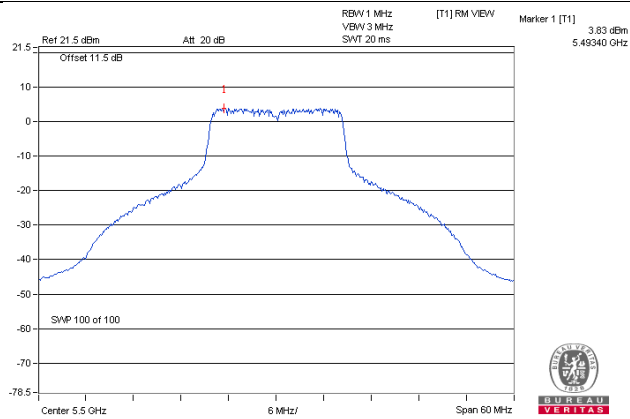

**802.11ac (VHT20) / CH100**

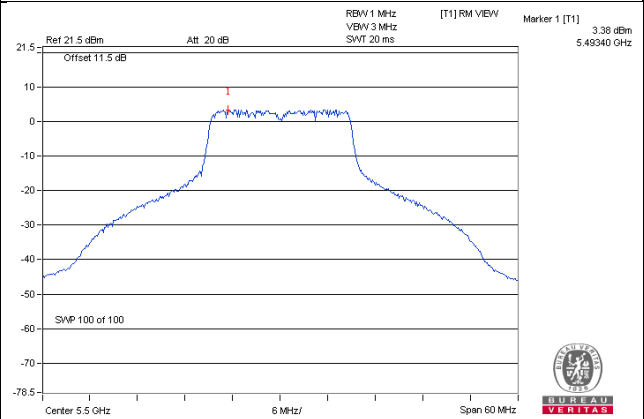

**802.11ac (VHT40) / CH110**

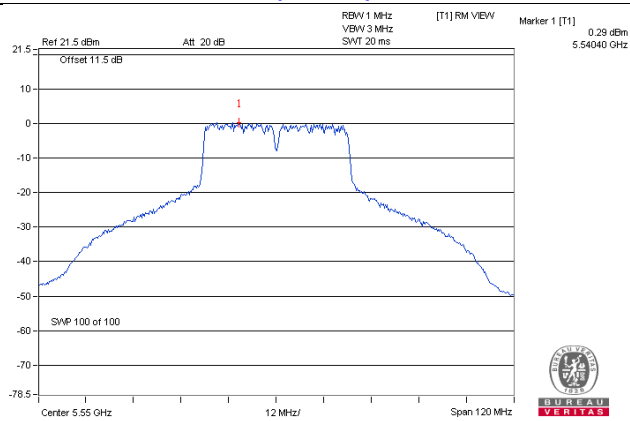

**802.11ac (VHT80) / CH122**

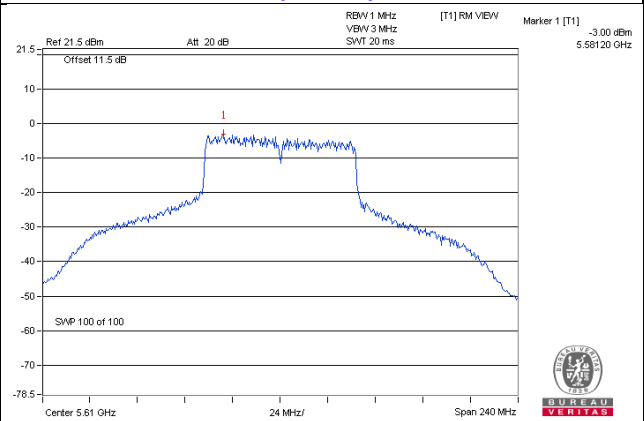

## 4.6 Frequency Stability Measurement

### 4.6.1 Limits of Frequency Stability Measurement

The frequency of the carrier signal shall be maintained within band of operation

### 4.6.2 Test Setup

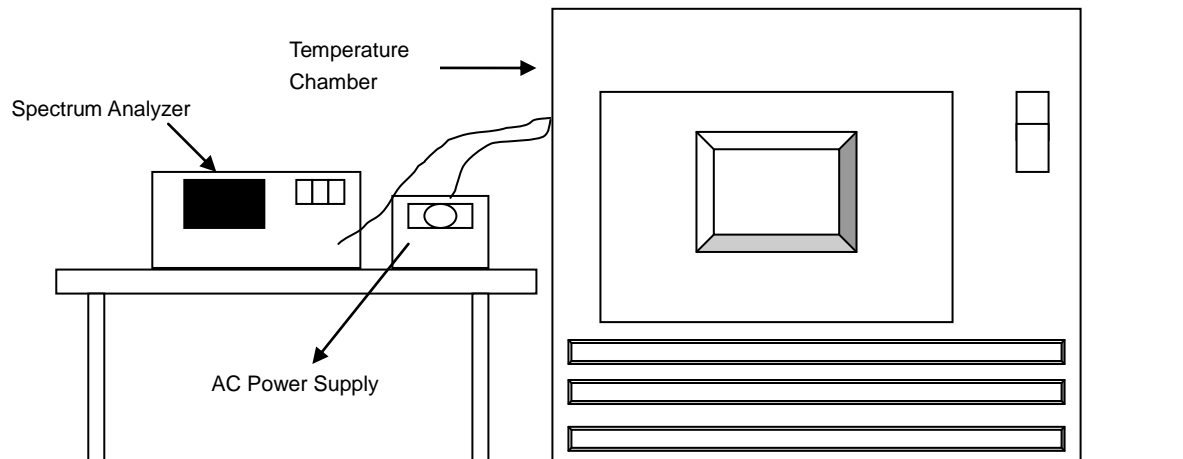

### 4.6.3 Test Instruments

Refer to section 4.1.2 to get information of above instrument.

### 4.6.4 Test Procedure

- The EUT was placed inside the environmental test chamber and powered by nominal AC voltage.
- Turn the EUT on and couple its output to a spectrum analyzer.
- Turn the EUT off and set the chamber to the highest temperature specified.
- Allow sufficient time (approximately 30 min) for the temperature of the chamber to stabilize, turn the EUT on and measure the operating frequency after 2, 5, and 10 Minutes.
- Repeat step 2 and 3 with the temperature chamber set to the lowest temperature.
- The test chamber was allowed to stabilize at +20 degree C for a minimum of 30 Minutes. The supply voltage was then adjusted on the EUT from 85% to 115% and the frequency record.

### 4.6.5 Deviation from Test Standard

No deviation.

### 4.6.6 EUT Operating Condition

Set the EUT transmit at un-modulation mode to test frequency stability.

## 4.6.7 Test Results (Mode 1)

Frequency Stability Versus Temp.									
Operating Frequency: 5260 MHz									
TEMP. (°C)	Power Supply (Vac)	0 Minute		2 Minutes		5 Minutes		10 Minutes	
		Measured Frequency (MHz)	Pass/Fail	Measured Frequency (MHz)	Pass/Fail	Measured Frequency (MHz)	Pass/Fail	Measured Frequency (MHz)	Pass/Fail
50	120	5260.0031	PASS	5260.0003	PASS	5260.0019	PASS	5259.9998	PASS
40	120	5260.0091	PASS	5260.005	PASS	5260.0052	PASS	5260.0043	PASS
30	120	5260.0252	PASS	5260.0267	PASS	5260.0231	PASS	5260.0273	PASS
20	120	5260.0119	PASS	5260.0125	PASS	5260.0149	PASS	5260.0126	PASS
10	120	5260.0043	PASS	5260.0014	PASS	5260.001	PASS	5260.0014	PASS
0	120	5259.9955	PASS	5259.9982	PASS	5259.9957	PASS	5259.9965	PASS
-10	120	5260.0256	PASS	5260.0223	PASS	5260.0247	PASS	5260.0255	PASS
-20	120	5259.9929	PASS	5259.9921	PASS	5259.9918	PASS	5259.9924	PASS
-30	120	5260.0227	PASS	5260.0255	PASS	5260.0236	PASS	5260.0239	PASS

Frequency Stability Versus Voltage									
Operating Frequency: 5260 MHz									
TEMP. (°C)	Power Supply (Vac)	0 Minute		2 Minutes		5 Minutes		10 Minutes	
		Measured Frequency (MHz)	Pass/Fail	Measured Frequency (MHz)	Pass/Fail	Measured Frequency (MHz)	Pass/Fail	Measured Frequency (MHz)	Pass/Fail
20	138	5260.0112	PASS	5260.0119	PASS	5260.0143	PASS	5260.013	PASS
	120	5260.0119	PASS	5260.0125	PASS	5260.0149	PASS	5260.0126	PASS
	102	5260.0118	PASS	5260.0131	PASS	5260.0156	PASS	5260.013	PASS



## 4.6.8 Test Results (Mode 2)

Frequency Stability Versus Temp.									
Operating Frequency: 5260 MHz									
TEMP. (°C)	Power Supply (Vac)	0 Minute		2 Minutes		5 Minutes		10 Minutes	
		Measured Frequency (MHz)	Pass/Fail	Measured Frequency (MHz)	Pass/Fail	Measured Frequency (MHz)	Pass/Fail	Measured Frequency (MHz)	Pass/Fail
50	120	5260.0217	PASS	5260.0188	PASS	5260.0201	PASS	5260.021	PASS
40	120	5259.996	PASS	5259.9926	PASS	5259.9924	PASS	5259.9973	PASS
30	120	5260.0192	PASS	5260.022	PASS	5260.0192	PASS	5260.0229	PASS
20	120	5260.0156	PASS	5260.0152	PASS	5260.0176	PASS	5260.0146	PASS
10	120	5259.9801	PASS	5259.9762	PASS	5259.9782	PASS	5259.9786	PASS
0	120	5260.0047	PASS	5260.0042	PASS	5260.008	PASS	5260.005	PASS
-10	120	5259.9938	PASS	5259.995	PASS	5259.9936	PASS	5259.9919	PASS
-20	120	5260.0232	PASS	5260.0245	PASS	5260.02	PASS	5260.022	PASS
-30	120	5260.0005	PASS	5259.9986	PASS	5259.9996	PASS	5259.9982	PASS

Frequency Stability Versus Voltage									
Operating Frequency: 5260 MHz									
TEMP. (°C)	Power Supply (Vac)	0 Minute		2 Minutes		5 Minutes		10 Minutes	
		Measured Frequency (MHz)	Pass/Fail	Measured Frequency (MHz)	Pass/Fail	Measured Frequency (MHz)	Pass/Fail	Measured Frequency (MHz)	Pass/Fail
20	138	5260.0166	PASS	5260.0152	PASS	5260.0186	PASS	5260.014	PASS
	120	5260.0156	PASS	5260.0152	PASS	5260.0176	PASS	5260.0146	PASS
	102	5260.0166	PASS	5260.0147	PASS	5260.0168	PASS	5260.0155	PASS

## 5 Pictures of Test Arrangements

Please refer to the attached file (Test Setup Photo).

## Appendix – Information on the Testing Laboratories

We, Bureau Veritas Consumer Products Services (H.K.) Ltd., Taoyuan Branch, were founded in 1988 to provide our best service in EMC, Radio, Telecom and Safety consultation. Our laboratories are accredited and approved according to ISO/IEC 17025.

If you have any comments, please feel free to contact us at the following:

**Linko EMC/RF Lab**

Tel: 886-2-26052180

Fax: 886-2-26051924

**Hsin Chu EMC/RF/Telecom Lab**

Tel: 886-3-6668565

Fax: 886-3-6668323

**Hwa Ya EMC/RF/Safety Lab**

Tel: 886-3-3183232

Fax: 886-3-3270892

**Email:** [service.adt@tw.bureauveritas.com](mailto:service.adt@tw.bureauveritas.com)

**Web Site:** [www.bureauveritas-adt.com](http://www.bureauveritas-adt.com)

The address and road map of all our labs can be found in our web site also.

--- END ---