

## FCC Test Report

**Report No.:** RF171011E02-1

**FCC ID:** UXX-S5A750A

**Test Model:** S5A750A

**Received Date:** Oct. 11, 2017

**Test Date:** Nov. 06 to 09, 2017

**Issued Date:** Nov. 17, 2017

**Applicant:** Cradlepoint, Inc.

**Address:** 1111 W. Jefferson Street, Suite 400, Boise, ID 83702 USA

**Issued By:** Bureau Veritas Consumer Products Services (H.K.) Ltd., Taoyuan Branch  
Hsin Chu Laboratory

**Lab Address:** E-2, No.1, Li Hsin 1st Road, Hsinchu Science Park, Hsinchu City 300,  
Taiwan R.O.C.

**Test Location:** E-2, No.1, Li Hsin 1st Road, Hsinchu Science Park, Hsinchu City 300,  
Taiwan R.O.C.

**FCC Registration /  
Designation Number:** 723255 / TW2022



This report is for your exclusive use. Any copying or replication of this report to or for any other person or entity, or use of our name or trademark, is permitted only with our prior written permission. This report sets forth our findings solely with respect to the test samples identified herein. The results set forth in this report are not indicative or representative of the quality or characteristics of the lot from which a test sample was taken or any similar or identical product unless specifically and expressly noted. Our report includes all of the tests requested by you and the results thereof based upon the information that you provided to us. You have 60 days from date of issuance of this report to notify us of any material error or omission caused by our negligence, provided, however, that such notice shall be in writing and shall specifically address the issue you wish to raise. A failure to raise such issue within the prescribed time shall constitute your unqualified acceptance of the completeness of this report, the tests conducted and the correctness of the report contents. Unless specific mention, the uncertainty of measurement has been explicitly taken into account to declare the compliance or non-compliance to the specification. The report must not be used by the client to claim product certification, approval, or endorsement by TAF or any government agencies.

## Table of Contents

<b>Release Control Record</b> .....	<b>4</b>
<b>1 Certificate of Conformity</b> .....	<b>5</b>
<b>2 Summary of Test Results</b> .....	<b>6</b>
2.1 Measurement Uncertainty .....	6
2.2 Modification Record .....	6
<b>3 General Information</b> .....	<b>7</b>
3.1 General Description of EUT .....	7
3.2 Description of Test Modes .....	10
3.2.1 Test Mode Applicability and Tested Channel Detail .....	11
3.3 Duty Cycle of Test Signal .....	15
3.4 Description of Support Units .....	17
3.4.1 Configuration of System under Test .....	18
3.5 General Description of Applied Standard .....	19
<b>4 Test Types and Results</b> .....	<b>20</b>
4.1 Radiated Emission and Bandedge Measurement .....	20
4.1.1 Limits of Radiated Emission and Bandedge Measurement .....	20
4.1.2 Test Instruments .....	21
4.1.3 Test Procedure .....	22
4.1.4 Deviation from Test Standard .....	22
4.1.5 Test Setup .....	23
4.1.6 EUT Operating Condition .....	24
4.1.7 Test Results (Mode 1) .....	25
4.1.8 Test Results (Mode 2) .....	44
4.2 Conducted Emission Measurement .....	63
4.2.1 Limits of Conducted Emission Measurement .....	63
4.2.2 Test Instruments .....	63
4.2.3 Test Procedure .....	64
4.2.4 Deviation from Test Standard .....	64
4.2.5 Test Setup .....	64
4.2.6 EUT Operating Condition .....	64
4.2.7 Test Results (Mode 1) .....	65
4.2.8 Test Results (Mode 2) .....	67
4.3 Transmit Power Measurement .....	69
4.3.1 Limits of Transmit Power Measurement .....	69
4.3.2 Test Setup .....	69
4.3.3 Test Instruments .....	69
4.3.4 Test Procedure .....	69
4.3.5 Deviation from Test Standard .....	69
4.3.6 EUT Operating Condition .....	69
4.3.7 Test Result (Mode 1) .....	70
4.3.8 Test Result (Mode 2) .....	73
4.4 Occupied Bandwidth Measurement .....	75
4.4.1 Test Setup .....	75
4.4.2 Test Instruments .....	75
4.4.3 Test Procedure .....	75
4.4.4 Test Results (Mode 1) .....	76
4.4.5 Test Results (Mode 2) .....	80
4.5 Peak Power Spectral Density Measurement .....	84
4.5.1 Limits of Peak Power Spectral Density Measurement .....	84
4.5.2 Test Setup .....	84
4.5.3 Test Instruments .....	84
4.5.4 Test Procedure .....	85
4.5.5 Deviation from Test Standard .....	86

4.5.6 EUT Operating Condition .....	86
4.5.7 Test Results (Mode 1).....	87
4.5.8 Test Results (Mode 2).....	93
4.6 Frequency Stability Measurement.....	97
4.6.1 Limits of Frequency Stability Measurement .....	97
4.6.2 Test Setup.....	97
4.6.3 Test Instruments .....	97
4.6.4 Test Procedure .....	97
4.6.5 Deviation from Test Standard .....	97
4.6.6 EUT Operating Condition .....	97
4.6.7 Test Results (Mode 1).....	98
4.6.8 Test Results (Mode 2).....	99
4.7 6dB Bandwidth Measurement .....	100
4.7.1 Limits of 6dB Bandwidth Measurement.....	100
4.7.2 Test Setup.....	100
4.7.3 Test Instruments .....	100
4.7.4 Test Procedure .....	100
4.7.5 Deviation from Test Standard .....	100
4.7.6 EUT Operating Condition .....	100
4.7.7 Test Results (Mode 1).....	101
4.7.8 Test Results (Mode 2).....	103
<b>5 Pictures of Test Arrangements.....</b>	<b>105</b>
<b>Annex A- Radiated Out of Band Emission (OOBE) Measurement (For U-NII-3 band) .....</b>	<b>106</b>
<b>Appendix – Information on the Testing Laboratories .....</b>	<b>114</b>

### Release Control Record

Issue No.	Description	Date Issued
RF171011E02-1	Original release.	Nov. 17, 2017

## 1 Certificate of Conformity

**Product:** WiFi Access Point

**Brand:** cradlepoint

**Test Model:** S5A750A

**Sample Status:** ENGINEERING SAMPLE

**Applicant:** Cradlepoint, Inc.

**Test Date:** Nov. 06 to 09, 2017

**Standard:** 47 CFR FCC Part 15, Subpart E (Section 15.407)  
ANSI C63.10: 2013

The above equipment has been tested by **Bureau Veritas Consumer Products Services (H.K.) Ltd., Taoyuan Branch**, and found compliance with the requirement of the above standards. The test record, data evaluation & Equipment Under Test (EUT) configurations represented herein are true and accurate accounts of the measurements of the sample's EMC characteristics under the conditions specified in this report.

**Prepared by :** Mary Ko , **Date:** Nov. 17, 2017  
Mary Ko / Specialist

**Approved by :** May Chen , **Date:** Nov. 17, 2017  
May Chen / Manager

## 2 Summary of Test Results

47 CFR FCC Part 15, Subpart E (Section 15.407)			
FCC Clause	Test Item	Result	Remarks
15.407(b)(6)	AC Power Conducted Emissions	Pass	Meet the requirement of limit. Minimum passing margin is -11.67dB at 0.15000MHz.
15.407(b) (1/2/3/4(i/ii)/6)	Radiated Emissions & Band Edge Measurement*	Pass	Meet the requirement of limit. Minimum passing margin is -0.1dB at 5150.00MHz, 11570.00MHz, 11650.00MHz.
15.407(a)(1/2/3)	Max Average Transmit Power	Pass	Meet the requirement of limit.
---	Occupied Bandwidth Measurement	-	Reference only.
15.407(a)(1/2/3)	Peak Power Spectral Density	Pass	Meet the requirement of limit.
15.407(e)	6dB bandwidth	Pass	Meet the requirement of limit. (U-NII-3 Band only)
15.407(g)	Frequency Stability	Pass	Meet the requirement of limit.
15.203	Antenna Requirement	Pass	Antenna connector is i-pex(MHF) not a standard connector.

\*For U-NII-3 band compliance with rule part 15.407(b)(4)(i), the OOB test plots were recorded in Annex A.

### 2.1 Measurement Uncertainty

Where relevant, the following measurement uncertainty levels have been estimated for tests performed on the EUT as specified in CISPR 16-4-2:

Measurement	Frequency	Expanded Uncertainty (k=2) ( $\pm$ )
Conducted Emissions at mains ports	150kHz ~ 30MHz	1.84 dB
Radiated Emissions up to 1 GHz	30MHz ~ 1GHz	5.30 dB
Radiated Emissions above 1 GHz	1GHz ~ 6GHz	5.16 dB
	6GHz ~ 18GHz	4.91 dB
	18GHz ~ 40GHz	5.30 dB

### 2.2 Modification Record

There were no modifications required for compliance.

### 3 General Information

#### 3.1 General Description of EUT

Product	WiFi Access Point
Brand	cradlepoint
Test Model	S5A750A
Status of EUT	ENGINEERING SAMPLE
Power Supply Rating	DC 48V from POE
Modulation Type	CCK, DQPSK, DBPSK for DSSS 64QAM, 16QAM, QPSK, BPSK for OFDM 256QAM for OFDM in 11ac mode only
Modulation Technology	DSSS, OFDM
Transfer Rate	802.11b: up to 11Mbps 802.11g: up to 54Mbps 802.11n: up to 300Mbps 802.11ac: up to 866.7Mbps
Operating Frequency	<b>2.4GHz:</b> 2.412 ~ 2.462GHz <b>5GHz:</b> 5.18 ~ 5.24GHz, 5.745 ~ 5.825GHz
Number of Channel	<b>2.4GHz:</b> 802.11b, 802.11g, 802.11n (HT20): 11 802.11n (HT40): 7 <b>5GHz:</b> 802.11a, 802.11n (HT20), 802.11ac (VHT20): 9 802.11n (HT40), 802.11ac (VHT40): 4 802.11ac (VHT80): 2
Output Power	<b>Radio 1</b> <b>2.4GHz:</b> <b>CDD Mode:</b> 721.992mW <b>Beamforming Mode:</b> 691.881 mW <b>Radio 2</b> <b>5.18 ~ 5.24GHz:</b> <b>CDD Mode:</b> 368.707mW <b>Beamforming Mode:</b> 368.707mW <b>5.745 ~ 5.825GHz:</b> <b>CDD Mode:</b> 424.356mW <b>Beamforming Mode:</b> 407.259mW <b>Radio 3</b> <b>2.4GHz:</b> 211.349mW <b>5.18 ~ 5.24GHz:</b> 75.858mW <b>5.745 ~ 5.825GHz:</b> 92.045mW
Antenna Type	Refer to Note
Antenna Connector	Refer to Note
Accessory Device	NA
Data Cable Supplied	NA

Note:

1. The EUT has three radios as following table:

Radio 1	Radio 2	Radio 3
WLAN - 2.4GHz	WLAN - 5GHz	WLAN - 2.4GHz+5 GHz

2. Simultaneously transmission condition.

Condition	Technology		
1	WLAN (Radio 1) (2.4GHz-2TX)	WLAN (Radio 2) (5GHz-2TX)	WLAN (Radio 3) (5GHz-1TX)
2	WLAN (Radio 1) (2.4GHz-2TX)	WLAN (Radio 2) (5GHz-2TX)	WLAN (Radio 3) (2.4GHz-1TX)

**Note:** The emission of the simultaneous operation has been evaluated and no non-compliance was found.

3. The antennas provided to the EUT, please refer to the following table:

Antenna No.	Antenna Net Gain (dBi)	Frequency Range (GHz)	Antenna Type	Connector Type
1 (Radio 1, 2)	5.19	2.4~2.4835	PIFA	i-pex(MHF)
	4.81	5.15~5.25		
	5.91	5.25~5.35		
	4.90	5.47~5.725		
	6.69	5.725~5.85		
2 (Radio 1, 2)	3.04	2.4~2.4835	PIFA	i-pex(MHF)
	7.37	5.15~5.25		
	6.90	5.25~5.35		
	6.65	5.47~5.725		
3 (Radio 3)	6.89	5.725~5.85	PIFA	i-pex(MHF)
	3.89	2.4~2.4835		
	6.58	5.15~5.25		
	6.87	5.25~5.35		
	6.27	5.47~5.725		
	7.01	5.725~5.85		



4. The EUT incorporates a MIMO function:

2.4GHz Band (Radio 1)			
MODULATION MODE	DATA RATE (MCS)	TX & RX CONFIGURATION	
802.11b	1 ~ 11Mbps	2TX	2RX
802.11g	6 ~ 54Mbps	2TX	2RX
802.11n (HT20)	MCS 0~7	2TX	2RX
	MCS 8~15	2TX	2RX
802.11n (HT40)	MCS 0~7	2TX	2RX
	MCS 8~15	2TX	2RX
5GHz Band (Radio 2)			
MODULATION MODE	DATA RATE (MCS)	TX & RX CONFIGURATION	
802.11a	6 ~ 54Mbps	2TX	2RX
802.11n (HT20)	MCS 0~7	2TX	2RX
	MCS 8~15	2TX	2RX
802.11n (HT40)	MCS 0~7	2TX	2RX
	MCS 8~15	2TX	2RX
802.11ac (VHT20)	MCS0~8 Nss=1	2TX	2RX
	MCS0~8 Nss=2	2TX	2RX
802.11ac (VHT40)	MCS0~9 Nss=1	2TX	2RX
	MCS0~9 Nss=2	2TX	2RX
802.11ac (VHT80)	MCS0~9 Nss=1	2TX	2RX
	MCS0~9 Nss=2	2TX	2RX
2.4GHz Band (Radio 3)			
MODULATION MODE	DATA RATE (MCS)	TX & RX CONFIGURATION	
802.11b	1 ~ 11Mbps	1TX	1RX
802.11g	6 ~ 54Mbps	1TX	1RX
802.11n (HT20)	MCS 0~7	1TX	1RX
802.11n (HT40)	MCS 0~7	1TX	1RX
5GHz Band (Radio 3)			
MODULATION MODE	DATA RATE (MCS)	TX & RX CONFIGURATION	
802.11a	6 ~ 54Mbps	1TX	1RX
802.11n (HT20)	MCS 0~7	1TX	1RX
802.11n (HT40)	MCS 0~7	1TX	1RX
802.11ac (VHT20)	MCS 0~8, Nss=1	1TX	1RX
802.11ac (VHT40)	MCS 0~9, Nss=1	1TX	1RX
802.11ac (VHT80)	MCS 0~9, Nss=1	1TX	1RX

Note:

1. All of modulation mode support beamforming function except 802.11a/b/g modulation mode.
2. The EUT support Beamforming and CDD mode, therefore both mode were investigated and the worst case scenario was identified. The worst case data were presented in test report.
3. The modulation and bandwidth are similar for 802.11n mode for 20MHz (40MHz) and 802.11ac mode for 20MHz (40MHz), therefore investigated worst case to representative mode in test report. (Final test mode refer section 3.2.1)

5. The above EUT information is declared by manufacturer and for more detailed features description, please refer to the manufacturer's specifications or user's manual.

### 3.2 Description of Test Modes

#### FOR 5180 ~ 5240MHz

4 channels are provided for 802.11a, 802.11n (HT20), 802.11ac (VHT20):

Channel	Frequency	Channel	Frequency
36	5180MHz	44	5220MHz
40	5200MHz	48	5240MHz

2 channels are provided for 802.11n (HT40), 802.11ac (VHT40):

Channel	Frequency	Channel	Frequency
38	5190MHz	46	5230MHz

1 channel is provided for 802.11ac (VHT80):

Channel	Frequency
42	5210MHz

#### FOR 5745 ~ 5825MHz:

5 channels are provided for 802.11a, 802.11n (HT20), 802.11ac (VHT20):

Channel	Frequency	Channel	Frequency
149	5745MHz	161	5805MHz
153	5765MHz	165	5825MHz
157	5785MHz		

2 channels are provided for 802.11n (HT40), 802.11ac (VHT40):

Channel	Frequency	Channel	Frequency
151	5755MHz	159	5795MHz

1 channel is provided for 802.11ac (VHT80):

Channel	Frequency
155	5775MHz

### 3.2.1 Test Mode Applicability and Tested Channel Detail

EUT Configure Mode	Applicable To				Description
	RE $\geq$ 1G	RE $<$ 1G	PLC	APCM	
1	√	√	√	√	Radio 2
2	√	√	√	√	Radio 3

Where **RE $\geq$ 1G**: Radiated Emission above 1GHz      **RE $<$ 1G**: Radiated Emission below 1GHz  
**PLC**: Power Line Conducted Emission      **APCM**: Antenna Port Conducted Measurement

**NOTE:**

1. The EUT had been pre-tested on the positioned of each 2 axis. The worst case was found when positioned on **Y-plane**.

#### **Radiated Emission Test (Above 1GHz):**

- Pre-Scan has been conducted to determine the worst-case mode from all possible combinations between available modulations, data rates and antenna ports (if EUT with antenna diversity architecture).
- Following channel(s) was (were) selected for the final test as listed below.

CDD Mode - Radio 2						
Mode	FREQ. Band (MHz)	Available Channel	Tested Channel	Modulation Technology	Modulation Type	Data Rate (Mbps)
802.11a	5180-5240	36 to 48	36, 40, 48	OFDM	BPSK	6
802.11ac (VHT20)		36 to 48	36, 40, 48	OFDM	BPSK	6.5
802.11ac (VHT40)		38 to 46	38, 46	OFDM	BPSK	13.5
802.11ac (VHT80)		42	42	OFDM	BPSK	29.3
802.11a	5745-5825	149 to 165	149, 157, 165	OFDM	BPSK	6
802.11ac (VHT20)		149 to 165	149, 157, 165	OFDM	BPSK	6.5
802.11ac (VHT40)		151 to 159	151, 159	OFDM	BPSK	13.5
802.11ac (VHT80)		155	155	OFDM	BPSK	29.3
Radio 3						
Mode	FREQ. Band (MHz)	Available Channel	Tested Channel	Modulation Technology	Modulation Type	Data Rate (Mbps)
802.11a	5180-5240	36 to 48	36, 40, 48	OFDM	BPSK	6
802.11ac (VHT20)		36 to 48	36, 40, 48	OFDM	BPSK	6.5
802.11ac (VHT40)		38 to 46	38, 46	OFDM	BPSK	13.5
802.11ac (VHT80)		42	42	OFDM	BPSK	29.3
802.11a	5745-5825	149 to 165	149, 157, 165	OFDM	BPSK	6
802.11ac (VHT20)		149 to 165	149, 157, 165	OFDM	BPSK	6.5
802.11ac (VHT40)		151 to 159	151, 159	OFDM	BPSK	13.5
802.11ac (VHT80)		155	155	OFDM	BPSK	29.3

### Radiated Emission Test (Below 1GHz):

- Pre-Scan has been conducted to determine the worst-case mode from all possible combinations between available modulations, data rates and antenna ports (if EUT with antenna diversity architecture).
- Following channel(s) was (were) selected for the final test as listed below.

CDD Mode – Radio 2						
Mode	FREQ. Band (MHz)	Available Channel	Tested Channel	Modulation Technology	Modulation Type	Data Rate (Mbps)
802.11ac (VHT40)	5180-5240 5745-5825	38 to 46 151 to 159	159	OFDM	BPSK	13.5
Radio 3						
Mode	FREQ. Band (MHz)	Available Channel	Tested Channel	Modulation Technology	Modulation Type	Data Rate (Mbps)
802.11ac (VHT40)	5180-5240 5745-5825	38 to 46 151 to 159	151	OFDM	BPSK	13.5

### Power Line Conducted Emission Test:

- Pre-Scan has been conducted to determine the worst-case mode from all possible combinations between available modulations, data rates and antenna ports (if EUT with antenna diversity architecture).
- Following channel(s) was (were) selected for the final test as listed below.

CDD Mode – Radio 2						
Mode	FREQ. Band (MHz)	Available Channel	Tested Channel	Modulation Technology	Modulation Type	Data Rate (Mbps)
802.11ac (VHT40)	5180-5240 5745-5825	38 to 46 151 to 159	159	OFDM	BPSK	13.5
Radio 3						
Mode	FREQ. Band (MHz)	Available Channel	Tested Channel	Modulation Technology	Modulation Type	Data Rate (Mbps)
802.11ac (VHT40)	5180-5240 5745-5825	38 to 46 151 to 159	151	OFDM	BPSK	13.5

### Antenna Port Conducted Measurement:

- This item includes all test value of each mode, but only includes spectrum plot of worst value of each mode.
- Pre-Scan has been conducted to determine the worst-case mode from all possible combinations between available modulations, data rates and antenna ports (if EUT with antenna diversity architecture).
- Following channel(s) was (were) selected for the final test as listed below.

<b>CDD Mode – Radio 2</b>						
Mode	FREQ. Band (MHz)	Available Channel	Tested Channel	Modulation Technology	Modulation Type	Data Rate (Mbps)
802.11a	5180-5240	36 to 48	36, 40, 48	OFDM	BPSK	6
802.11ac (VHT20)		36 to 48	36, 40, 48	OFDM	BPSK	6.5
802.11ac (VHT40)		38 to 46	38, 46	OFDM	BPSK	13.5
802.11ac (VHT80)		42	42	OFDM	BPSK	29.3
802.11a	5745-5825	149 to 165	149, 157, 165	OFDM	BPSK	6
802.11ac (VHT20)		149 to 165	149, 157, 165	OFDM	BPSK	6.5
802.11ac (VHT40)		151 to 159	151, 159	OFDM	BPSK	13.5
802.11ac (VHT80)		155	155	OFDM	BPSK	29.3
<b>Beamforming Mode (output power only – Radio 2)</b>						
Mode	FREQ. Band (MHz)	Available Channel	Tested Channel	Modulation Technology	Modulation Type	Data Rate (Mbps)
802.11ac (VHT20)	5180-5240	36 to 48	36, 40, 48	OFDM	BPSK	6.5
802.11ac (VHT40)		38 to 46	38, 46	OFDM	BPSK	13.5
802.11ac (VHT80)		42	42	OFDM	BPSK	29.3
802.11ac (VHT20)	5745-5825	149 to 165	149, 157, 165	OFDM	BPSK	6.5
802.11ac (VHT40)		151 to 159	151, 159	OFDM	BPSK	13.5
802.11ac (VHT80)		155	155	OFDM	BPSK	29.3
<b>Radio 3</b>						
Mode	FREQ. Band (MHz)	Available Channel	Tested Channel	Modulation Technology	Modulation Type	Data Rate (Mbps)
802.11a	5180-5240	36 to 48	36, 40, 48	OFDM	BPSK	6
802.11ac (VHT20)		36 to 48	36, 40, 48	OFDM	BPSK	6.5
802.11ac (VHT40)		38 to 46	38, 46	OFDM	BPSK	13.5
802.11ac (VHT80)		42	42	OFDM	BPSK	29.3
802.11a	5745-5825	149 to 165	149, 157, 165	OFDM	BPSK	6
802.11ac (VHT20)		149 to 165	149, 157, 165	OFDM	BPSK	6.5
802.11ac (VHT40)		151 to 159	151, 159	OFDM	BPSK	13.5
802.11ac (VHT80)		155	155	OFDM	BPSK	29.3

**Test Condition:**

Applicable To	Environmental Conditions	Input Power (system)	Tested By
RE $\geq$ 1G	22deg. C, 70%RH	120Vac, 60Hz	Jyunchun Lin Rey Chen
RE<1G	25deg. C, 64%RH	120Vac, 60Hz	Rey Chen
PLC	24deg. C, 74%RH	120Vac, 60Hz	Andy Ho
APCM	25deg. C, 60%RH	120Vac, 60Hz	Anderson Chen

### 3.3 Duty Cycle of Test Signal

#### Radio 2

If duty cycle of test signal is  $\geq 98\%$ , duty factor is not required.

If duty cycle of test signal is  $< 98\%$ , duty factor shall be considered.

**802.11a:** Duty cycle =  $2.019 \text{ ms} / 2104 \text{ ms} = 0.96$ , Duty factor =  $10 * \log(1/0.96) = 0.18$

**802.11ac (VHT20):** Duty cycle =  $4.965 \text{ ms} / 5.053 \text{ ms} = 0.983$

**802.11ac (VHT40):** Duty cycle =  $2.415 \text{ ms} / 2.504 \text{ ms} = 0.964$ , Duty factor =  $10 * \log(1/0.964) = 0.16$

**802.11ac (VHT80):** Duty cycle =  $1.135 \text{ ms} / 1.212 \text{ ms} = 0.936$ , Duty factor =  $10 * \log(1/0.936) = 0.29$

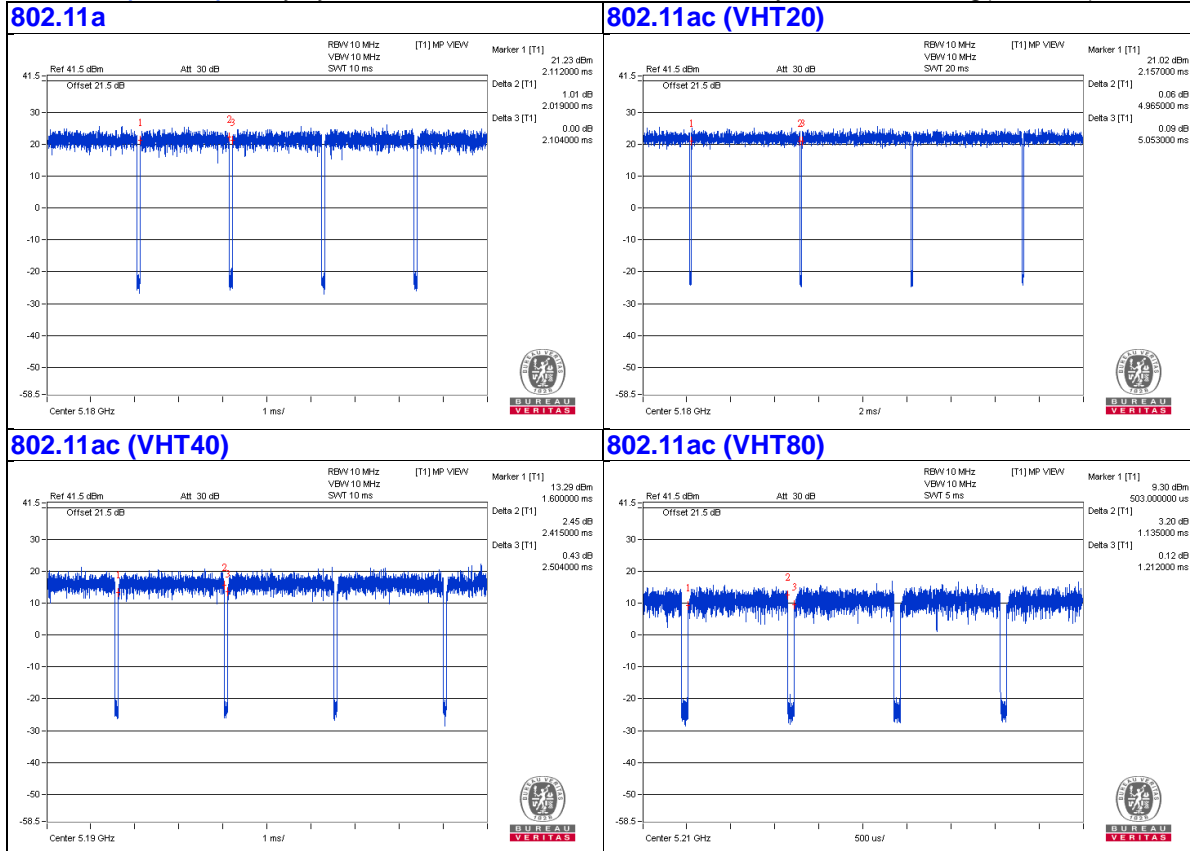

### Radio 3

If duty cycle of test signal is  $\geq 98\%$ , duty factor is not required.

If duty cycle of test signal is  $< 98\%$ , duty factor shall be considered.

**802.11a:** Duty cycle =  $2.026 \text{ ms} / 2.105 \text{ ms} = 0.962$ , Duty factor =  $10 * \log(1/0.962) = 0.17$

**802.11ac (VHT20):** Duty cycle =  $1.897 \text{ ms} / 1.975 \text{ ms} = 0.961$ , Duty factor =  $10 * \log(1/0.961) = 0.17$

**802.11ac (VHT40):** Duty cycle =  $0.932 \text{ ms} / 1.007 \text{ ms} = 0.926$ , Duty factor =  $10 * \log(1/0.926) = 0.34$

**802.11ac (VHT80):** Duty cycle =  $0.453 \text{ ms} / 0.533 \text{ ms} = 0.85$ , Duty factor =  $10 * \log(1/0.85) = 0.71$

**802.11a**

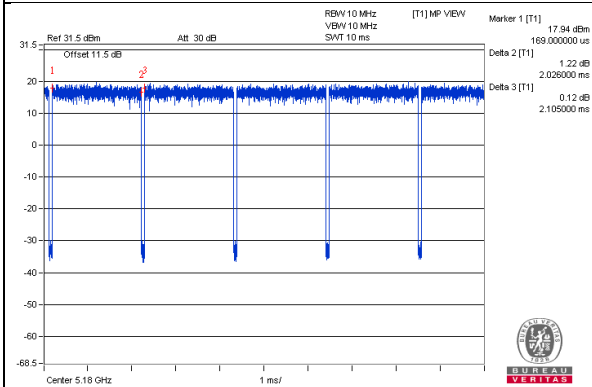

**802.11ac (VHT20)**

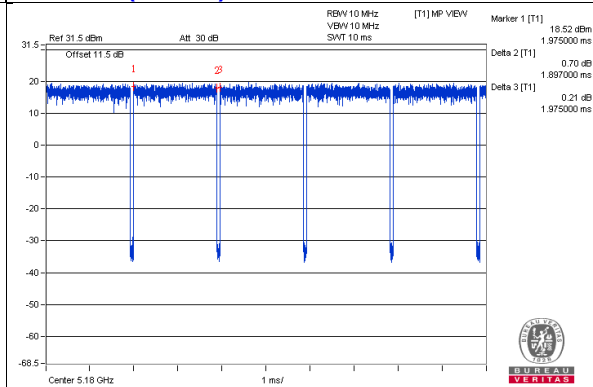

**802.11ac (VHT40)**

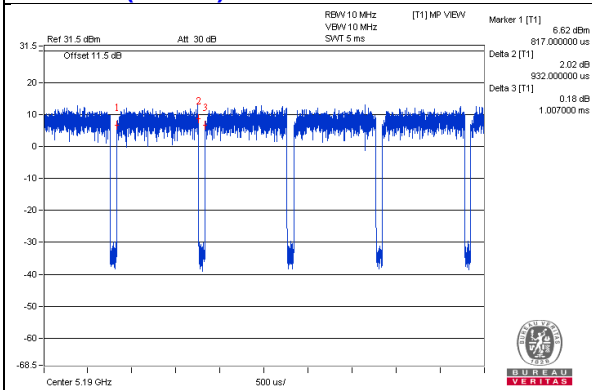

**802.11ac (VHT80)**

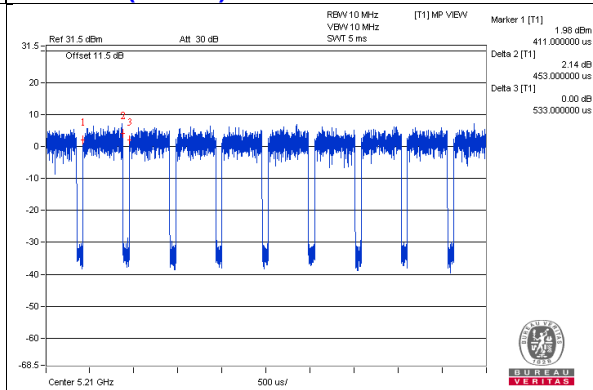



### 3.4 Description of Support Units

The EUT has been tested as an independent unit together with other necessary accessories or support units. The following support units or accessories were used to form a representative test configuration during the tests.

ID	Product	Brand	Model No.	Serial No.	FCC ID	Remarks
A.	Laptop	HP	Pavilion 14-ab023TU	5CD5340WXZ	NA	Provided by Lab
B.	POE	ELECTRONICS	PGSA20D01-480035	NA	NA	Supplied by client
C.	iPod	Apple	MD778TA/A	CC4JMH7LF4T1	NA	Provided by Lab

Note:

1. All power cords of the above support units are non-shielded (1.8m).

ID	Descriptions	Qty.	Length (m)	Shielding (Yes/No)	Cores (Qty.)	Remarks
1.	RJ-45 Cable	1	10	No	0	Provided by Lab
2.	RJ-45 Cable	1	3	No	0	Provided by Lab
3.	USB Cable	1	0.1	Yes	0	Provided by Lab

### 3.4.1 Configuration of System under Test

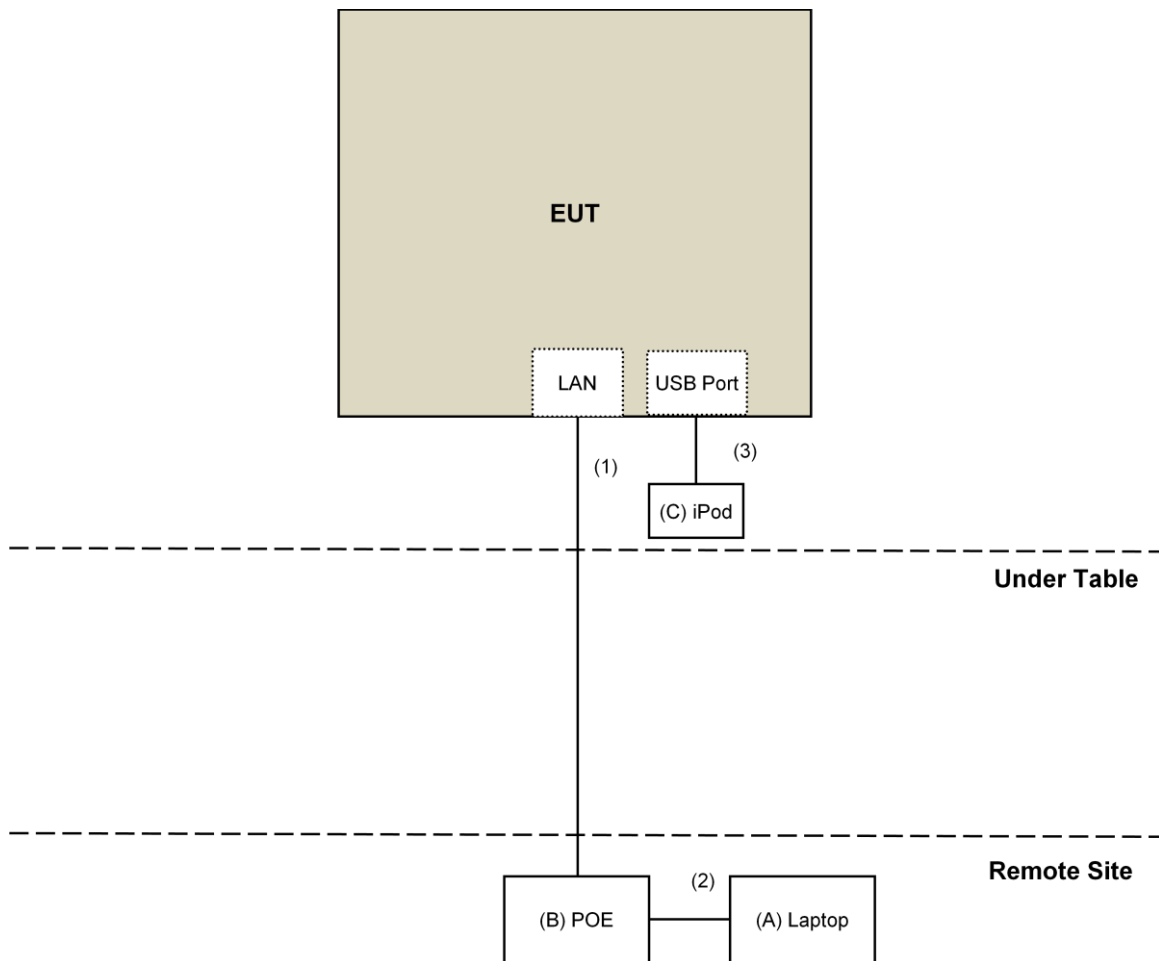

### 3.5 General Description of Applied Standard

The EUT is a RF Product. According to the specifications of the manufacturer, it must comply with the requirements of the following standards:

**FCC Part 15, Subpart E (15.407)**  
**KDB 789033 D02 General UNII Test Procedure New Rules v01r04**  
**KDB 662911 D01 Multiple Transmitter Output v02r01**  
**ANSI C63.10-2013**

All test items have been performed and recorded as per the above standards.

**NOTE:** The EUT has been verified to comply with the requirements of FCC Part 15, Subpart B, Class B (DoC). The test report has been issued separately.

## 4 Test Types and Results

### 4.1 Radiated Emission and Bandedge Measurement

#### 4.1.1 Limits of Radiated Emission and Bandedge Measurement

Radiated emissions which fall in the restricted bands must comply with the radiated emission limits specified as below table.

Frequencies (MHz)	Field Strength (microvolts/meter)	Measurement Distance (meters)
0.009 ~ 0.490	2400/F(kHz)	300
0.490 ~ 1.705	24000/F(kHz)	30
1.705 ~ 30.0	30	30
30 ~ 88	100	3
88 ~ 216	150	3
216 ~ 960	200	3
Above 960	500	3

#### NOTE:

- The lower limit shall apply at the transition frequencies.
- Emission level (dBuV/m) = 20 log Emission level (uV/m).
- For frequencies above 1000MHz, the field strength limits are based on average detector, however, the peak field strength of any emission shall not exceed the maximum permitted average limits, specified above by more than 20dB under any condition of modulation.

Limits of unwanted emission out of the restricted bands

Applicable To		Limit	
789033 D02 General UNII Test Procedure New Rules v01r04		Field Strength at 3m	
		PK:74 (dBuV/m)	AV:54 (dBuV/m)
Frequency Band	Applicable To	EIRP Limit	Equivalent Field Strength at 3m
5150~5250 MHz	15.407(b)(1)	PK:-27 (dBm/MHz)	PK:68.2(dBuV/m)
5250~5350 MHz	15.407(b)(2)		
5470~5725 MHz	15.407(b)(3)		
5725~5850 MHz	<input checked="" type="checkbox"/> 15.407(b)(4)(i)	PK:-27 (dBm/MHz) <sup>*1</sup> PK:10 (dBm/MHz) <sup>*2</sup> PK:15.6 (dBm/MHz) <sup>*3</sup> PK:27 (dBm/MHz) <sup>*4</sup>	PK: 68.2(dBuV/m) <sup>*1</sup> PK:105.2 (dBuV/m) <sup>*2</sup> PK: 110.8(dBuV/m) <sup>*3</sup> PK:122.2 (dBuV/m) <sup>*4</sup>
	<input type="checkbox"/> 15.407(b)(4)(ii)	Emission limits in section 15.247(d)	
<sup>*1</sup> beyond 75 MHz or more above of the band edge.		<sup>*2</sup> below the band edge increasing linearly to 10 dBm/MHz at 25 MHz above.	
<sup>*3</sup> below the band edge increasing linearly to a level of 15.6 dBm/MHz at 5 MHz above.		<sup>*4</sup> from 5 MHz above or below the band edge increasing linearly to a level of 27 dBm/MHz at the band edge.	

#### Note:

The following formula is used to convert the equipment isotropic radiated power (eirp) to field strength:

$$E = \frac{1000000\sqrt{30P}}{3} \mu\text{V/m, where P is the eirp (Watts).}$$

## 4.1.2 Test Instruments

DESCRIPTION & MANUFACTURER	MODEL NO.	SERIAL NO.	CALIBRATED DATE	CALIBRATED UNTIL
Test Receiver Keysight	N9038A	MY54450088	July 08, 2017	July 07, 2018
Pre-Amplifier <sup>(*)</sup> EMCI	EMC001340	980142	Jan. 20, 2016	Jan. 19, 2018
Loop Antenna <sup>(*)</sup> Electro-Metrics	EM-6879	264	Dec. 16, 2016	Dec. 15, 2018
RF Cable	NA	LOOPCAB-001 LOOPCAB-002	Jan. 17, 2017	Jan. 16, 2018
Pre-Amplifier Mini-Circuits	ZFL-1000VH2B	AMP-ZFL-01	Nov. 10, 2016	Nov. 09, 2017
Trilog Broadband Antenna SCHWARZBECK	VULB 9168	9168-406	Dec. 13, 2016	Dec. 12, 2017
RF Cable	8D	966-4-1 966-4-2 966-4-3	Apr. 01, 2017	Mar. 31, 2018
Fixed attenuator Mini-Circuits	UNAT-5+	PAD-3m-4-01	Oct. 03, 2017	Oct. 02, 2018
Horn_Antenna SCHWARZBECK	BBHA 9120D	9120D-783	Dec. 27, 2016	Dec. 26, 2017
Pre-Amplifier EMCI	EMC12630SE	980385	Feb. 02, 2017	Feb. 01, 2018
RF Cable	EMC104-SM-SM-1200 EMC104-SM-SM-2000 EMC104-SM-SM-5000	160923 150318 150321	Feb. 02, 2017 Mar. 29, 2017 Mar. 29, 2017	Feb. 01, 2018 Mar. 28, 2018 Mar. 28, 2018
Pre-Amplifier EMCI	EMC184045SE	980387	Feb. 02, 2017	Feb. 01, 2018
Horn_Antenna SCHWARZBECK	BBHA 9170	BBHA9170608	Dec. 15, 2016	Dec. 14, 2017
RF Cable	SUCOFLEX 102	36432/2 36433/2	Jan. 15, 2017	Jan. 14, 2018
Software	ADT_Radiated_V8.7.08	NA	NA	NA
Antenna Tower & Turn Table Max-Full	MF-7802	MF780208410	NA	NA
Boresight Antenna Fixture	FBA-01	FBA-SIP02	NA	NA
Spectrum Analyzer R&S	FSV40	100964	July 1, 2017	June 30, 2018
Power meter Anritsu	ML2495A	1014008	May 11, 2017	May 10, 2018
Power sensor Anritsu	MA2411B	0917122	May 11, 2017	May 10, 2018
DC Power Supply Topward	6603D	795558	NA	NA
Temperature & Humidity Chamber Giant Force	GTH-150-40-SP-AR	MAA0812-008	Jan. 11, 2017	Jan. 10, 2018
Digital Multimeter FLUKE	87III	73680266	Nov. 10, 2016	Nov. 09, 2017

**Note:**

1. The calibration interval of the above test instruments is 12 months and the calibrations are traceable to NML/ROC and NIST/USA.
2. \*The calibration interval of the above test instruments is 24 months and the calibrations are traceable to NML/ROC and NIST/USA.
3. The test was performed in 966 Chamber No. 4.
4. Loop antenna was used for all emissions below 30 MHz.
5. The CANADA Site Registration No. is 20331-2
6. Tested Date: Nov. 06 to 08, 2017

#### 4.1.3 Test Procedure

##### **For Radiated emission below 30MHz**

- a. The EUT was placed on the top of a rotating table 0.8 meters above the ground at a 3 meter chamber room. The table was rotated 360 degrees to determine the position of the highest radiation.
- b. The EUT was set 3 meters away from the interference-receiving antenna, which was mounted on the top of a variable-height antenna tower.
- c. Both X and Y axes of the antenna are set to make the measurement.
- d. For each suspected emission, the EUT was arranged to its worst case and the rotatable table was turned from 0 degrees to 360 degrees to find the maximum reading.
- e. The test-receiver system was set to Quasi-Peak Detect Function and Specified Bandwidth with Maximum Hold Mode.

##### **NOTE:**

1. The resolution bandwidth and video bandwidth of test receiver/spectrum analyzer is 9kHz at frequency below 30MHz.

##### **For Radiated emission above 30MHz**

- a. The EUT was placed on the top of a rotating table 0.8 meters (for 30MHz ~ 1GHz) / 1.5 meters (for above 1GHz) above the ground at 3 meter chamber room for test. The table was rotated 360 degrees to determine the position of the highest radiation.
- b. The EUT was set 3 meters away from the interference-receiving antenna, which was mounted on the top of a variable-height antenna tower.
- c. The height of antenna is varied from one meter to four meters above the ground to determine the maximum value of the field strength. Both horizontal and vertical polarizations of the antenna are set to make the measurement.
- d. For each suspected emission, the EUT was arranged to its worst case and then the antenna was tuned to heights from 1 meter to 4 meters and the rotatable table was turned from 0 degrees to 360 degrees to find the maximum reading.
- e. The test-receiver system was set to quasi-peak detect function and specified bandwidth with maximum hold mode when the test frequency is below 1 GHz.
- f. The test-receiver system was set to peak and average detects function and specified bandwidth with maximum hold mode when the test frequency is above 1 GHz. If the peak reading value also meets average limit, measurement with the average detector is unnecessary.

##### **Note:**

1. The resolution bandwidth and video bandwidth of test receiver/spectrum analyzer is 120kHz for Quasi-peak detection (QP) at frequency below 1GHz.
2. The resolution bandwidth of test receiver/spectrum analyzer is 1 MHz and the video bandwidth is 3 MHz for Peak detection (PK) at frequency above 1GHz.
3. The resolution bandwidth of test receiver/spectrum analyzer is 1MHz and the video bandwidth is  $\geq 1/T$  (Duty cycle < 98%) or 10Hz (Duty cycle  $\geq 98\%$ ) for Average detection (AV) at frequency above 1GHz.
4. All modes of operation were investigated and the worst-case emissions are reported.

#### 4.1.4 Deviation from Test Standard

No deviation.

#### 4.1.5 Test Setup

##### For Radiated emission below 30MHz

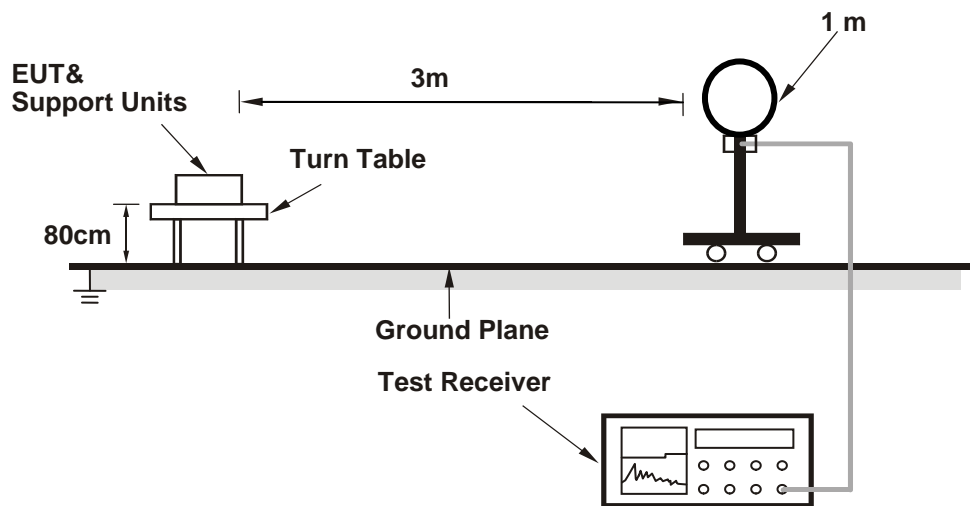

##### For Radiated emission 30MHz to 1GHz

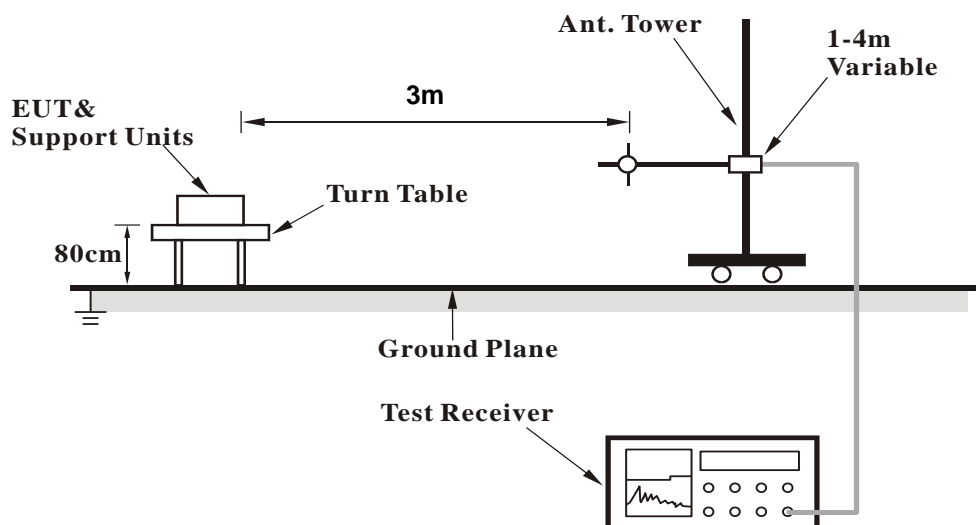

**For Radiated emission above 1GHz**

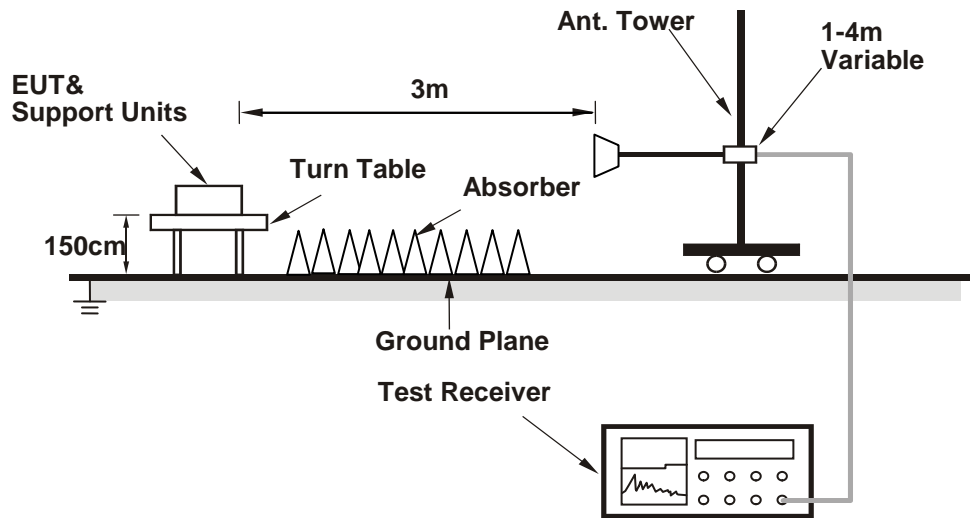

For the actual test configuration, please refer to the attached file (Test Setup Photo).

**4.1.6 EUT Operating Condition**

- a. Connected the EUT with the Laptop which is placed on remote site.
- b. Controlling software (QRCT.EXE[Version3.0.264.0]) has been activated to set the EUT on specific status.



4.1.7 Test Results (Mode 1)

Above 1GHz Data:

802.11a

<b>CHANNEL</b>	TX Channel 36	<b>DETECTOR FUNCTION</b>	Peak (PK)
<b>FREQUENCY RANGE</b>	1GHz ~ 40GHz		Average (AV)

ANTENNA POLARITY & TEST DISTANCE: HORIZONTAL AT 3 M								
NO.	FREQ. (MHz)	EMISSION LEVEL (dBuV/m)	LIMIT (dBuV/m)	MARGIN (dB)	ANTENNA HEIGHT (m)	TABLE ANGLE (Degree)	RAW VALUE (dBuV)	CORRECTION FACTOR (dB/m)
1	5150.00	71.8 PK	74.0	-2.2	1.50 H	343	67.8	4.0
2	5150.00	52.5 AV	54.0	-1.5	1.50 H	343	48.5	4.0
3	*5180.00	113.8 PK			1.50 H	343	109.8	4.0
4	*5180.00	103.5 AV			1.50 H	343	99.5	4.0
5	#10360.00	50.5 PK	74.0	-23.5	1.83 H	112	36.9	13.6
6	#10360.00	38.2 AV	54.0	-15.8	1.83 H	112	24.6	13.6
7	15540.00	44.5 PK	74.0	-29.5	1.46 H	302	31.3	13.2
8	15540.00	33.0 AV	54.0	-21.0	1.46 H	302	19.8	13.2

ANTENNA POLARITY & TEST DISTANCE: VERTICAL AT 3 M								
NO.	FREQ. (MHz)	EMISSION LEVEL (dBuV/m)	LIMIT (dBuV/m)	MARGIN (dB)	ANTENNA HEIGHT (m)	TABLE ANGLE (Degree)	RAW VALUE (dBuV)	CORRECTION FACTOR (dB/m)
1	5150.00	72.7 PK	74.0	-1.3	2.23 V	327	68.7	4.0
2	5150.00	53.8 AV	54.0	-0.2	2.23 V	327	49.8	4.0
3	*5180.00	114.8 PK			2.23 V	327	110.8	4.0
4	*5180.00	104.5 AV			2.23 V	327	100.5	4.0
5	#10360.00	51.2 PK	74.0	-22.8	1.84 V	358	37.6	13.6
6	#10360.00	39.6 AV	54.0	-14.4	1.84 V	358	26.0	13.6
7	15540.00	44.8 PK	74.0	-29.2	1.71 V	305	31.6	13.2
8	15540.00	32.4 AV	54.0	-21.6	1.71 V	305	19.2	13.2

REMARKS:

1. Emission Level(dBuV/m) = Raw Value(dBuV) + Correction Factor(dB/m)
2. Correction Factor(dB/m) = Antenna Factor(dB/m) + Cable Factor(dB) – Pre-Amplifier Factor(dB)
3. The other emission levels were very low against the limit.
4. Margin value = Emission Level – Limit value
5. " \* ": Fundamental frequency.
6. " # ": The radiated frequency is out of the restricted band.

<b>CHANNEL</b>	TX Channel 40	<b>DETECTOR FUNCTION</b>	Peak (PK)
<b>FREQUENCY RANGE</b>	1GHz ~ 40GHz		Average (AV)

**ANTENNA POLARITY & TEST DISTANCE: HORIZONTAL AT 3 M**

NO.	FREQ. (MHz)	EMISSION LEVEL (dBuV/m)	LIMIT (dBuV/m)	MARGIN (dB)	ANTENNA HEIGHT (m)	TABLE ANGLE (Degree)	RAW VALUE (dBuV)	CORRECTION FACTOR (dB/m)
1	5150.00	69.8 PK	74.0	-4.2	1.53 H	346	65.8	4.0
2	5150.00	50.1 AV	54.0	-3.9	1.53 H	346	46.1	4.0
3	*5200.00	117.8 PK			1.53 H	346	113.8	4.0
4	*5200.00	107.9 AV			1.53 H	346	103.9	4.0
5	5350.00	51.2 PK	74.0	-22.8	1.53 H	346	46.8	4.4
6	5350.00	38.0 AV	54.0	-16.0	1.53 H	346	33.6	4.4
7	#10400.00	51.3 PK	74.0	-22.7	1.86 H	124	37.7	13.6
8	#10400.00	39.2 AV	54.0	-14.8	1.86 H	124	25.6	13.6
9	15600.00	45.2 PK	74.0	-28.8	1.44 H	302	31.8	13.4
10	15600.00	33.6 AV	54.0	-20.4	1.44 H	302	20.2	13.4

**ANTENNA POLARITY & TEST DISTANCE: VERTICAL AT 3 M**

NO.	FREQ. (MHz)	EMISSION LEVEL (dBuV/m)	LIMIT (dBuV/m)	MARGIN (dB)	ANTENNA HEIGHT (m)	TABLE ANGLE (Degree)	RAW VALUE (dBuV)	CORRECTION FACTOR (dB/m)
1	5150.00	70.7 PK	74.0	-3.3	2.35 V	360	66.7	4.0
2	5150.00	51.4 AV	54.0	-2.6	2.35 V	360	47.4	4.0
3	*5200.00	118.8 PK			2.35 V	360	114.8	4.0
4	*5200.00	108.9 AV			2.35 V	360	104.9	4.0
5	5350.00	52.1 PK	74.0	-21.9	2.35 V	360	47.7	4.4
6	5350.00	39.3 AV	54.0	-14.7	2.35 V	360	34.9	4.4
7	#10400.00	52.2 PK	74.0	-21.8	1.85 V	355	38.6	13.6
8	#10400.00	40.5 AV	54.0	-13.5	1.85 V	355	26.9	13.6
9	15600.00	45.9 PK	74.0	-28.1	1.68 V	311	32.5	13.4
10	15600.00	33.7 AV	54.0	-20.3	1.68 V	311	20.3	13.4

**REMARKS:**

- Emission Level(dBuV/m) = Raw Value(dBuV) + Correction Factor(dB/m)
- Correction Factor(dB/m) = Antenna Factor(dB/m) + Cable Factor(dB) – Pre-Amplifier Factor(dB)
- The other emission levels were very low against the limit.
- Margin value = Emission Level – Limit value
- " \* ": Fundamental frequency.
- " # ": The radiated frequency is out of the restricted band.

<b>CHANNEL</b>	TX Channel 48	<b>DETECTOR FUNCTION</b>	Peak (PK)
<b>FREQUENCY RANGE</b>	1GHz ~ 40GHz		Average (AV)

**ANTENNA POLARITY & TEST DISTANCE: HORIZONTAL AT 3 M**

NO.	FREQ. (MHz)	EMISSION LEVEL (dBuV/m)	LIMIT (dBuV/m)	MARGIN (dB)	ANTENNA HEIGHT (m)	TABLE ANGLE (Degree)	RAW VALUE (dBuV)	CORRECTION FACTOR (dB/m)
1	*5240.00	116.5 PK			1.55 H	347	112.3	4.2
2	*5240.00	106.5 AV			1.55 H	347	102.3	4.2
3	5350.00	55.4 PK	74.0	-18.6	1.55 H	347	51.0	4.4
4	5350.00	37.3 AV	54.0	-16.7	1.55 H	347	32.9	4.4
5	#10480.00	51.0 PK	74.0	-23.0	1.84 H	113	37.3	13.7
6	#10480.00	38.9 AV	54.0	-15.1	1.84 H	113	25.2	13.7
7	15720.00	44.8 PK	74.0	-29.2	1.47 H	300	30.8	14.0
8	15720.00	33.4 AV	54.0	-20.6	1.47 H	300	19.4	14.0

**ANTENNA POLARITY & TEST DISTANCE: VERTICAL AT 3 M**

NO.	FREQ. (MHz)	EMISSION LEVEL (dBuV/m)	LIMIT (dBuV/m)	MARGIN (dB)	ANTENNA HEIGHT (m)	TABLE ANGLE (Degree)	RAW VALUE (dBuV)	CORRECTION FACTOR (dB/m)
1	*5240.00	117.5 PK			2.33 V	360	113.3	4.2
2	*5240.00	107.5 AV			2.33 V	360	103.3	4.2
3	5350.00	56.3 PK	74.0	-17.7	2.33 V	360	51.9	4.4
4	5350.00	38.6 AV	54.0	-15.4	2.33 V	360	34.2	4.4
5	#10480.00	51.1 PK	74.0	-22.9	1.85 V	360	37.4	13.7
6	#10480.00	39.5 AV	54.0	-14.5	1.85 V	360	25.8	13.7
7	15720.00	45.9 PK	74.0	-28.1	1.66 V	305	31.9	14.0
8	15720.00	33.4 AV	54.0	-20.6	1.66 V	305	19.4	14.0

**REMARKS:**

1. Emission Level(dBuV/m) = Raw Value(dBuV) + Correction Factor(dB/m)
2. Correction Factor(dB/m) = Antenna Factor(dB/m) + Cable Factor(dB) – Pre-Amplifier Factor(dB)
3. The other emission levels were very low against the limit.
4. Margin value = Emission Level – Limit value
5. " \* ": Fundamental frequency.
6. " # ": The radiated frequency is out of the restricted band.

<b>CHANNEL</b>	TX Channel 149	<b>DETECTOR FUNCTION</b>	Peak (PK)
<b>FREQUENCY RANGE</b>	1GHz ~ 40GHz		Average (AV)

**ANTENNA POLARITY & TEST DISTANCE: HORIZONTAL AT 3 M**

NO.	FREQ. (MHz)	EMISSION LEVEL (dBuV/m)	LIMIT (dBuV/m)	MARGIN (dB)	ANTENNA HEIGHT (m)	TABLE ANGLE (Degree)	RAW VALUE (dBuV)	CORRECTION FACTOR (dB/m)
1	*5745.00	106.7 PK			1.75 H	333	101.7	5.0
2	*5745.00	106.4 AV			1.75 H	333	101.4	5.0
3	11490.00	53.6 PK	74.0	-20.4	2.21 H	193	39.5	14.1
4	11490.00	40.6 AV	54.0	-13.4	2.21 H	193	26.5	14.1
5	#17235.00	55.2 PK	74.0	-18.8	2.28 H	114	36.9	18.3
6	#17235.00	41.8 AV	54.0	-12.2	2.28 H	114	23.5	18.3

**ANTENNA POLARITY & TEST DISTANCE: VERTICAL AT 3 M**

NO.	FREQ. (MHz)	EMISSION LEVEL (dBuV/m)	LIMIT (dBuV/m)	MARGIN (dB)	ANTENNA HEIGHT (m)	TABLE ANGLE (Degree)	RAW VALUE (dBuV)	CORRECTION FACTOR (dB/m)
1	*5745.00	119.0 PK			1.04 V	357	114.0	5.0
2	*5745.00	109.0 AV			1.04 V	357	104.0	5.0
3	11490.00	49.9 PK	74.0	-24.1	1.47 V	29	35.8	14.1
4	11490.00	37.0 AV	54.0	-17.0	1.47 V	29	22.9	14.1
5	#17235.00	54.1 PK	74.0	-19.9	1.55 V	153	35.8	18.3
6	#17235.00	41.0 AV	54.0	-13.0	1.55 V	153	22.7	18.3

**REMARKS:**

1. Emission Level(dBuV/m) = Raw Value(dBuV) + Correction Factor(dB/m)
2. Correction Factor(dB/m) = Antenna Factor(dB/m) + Cable Factor(dB) – Pre-Amplifier Factor(dB)
3. The other emission levels were very low against the limit.
4. Margin value = Emission Level – Limit value
5. " \* ": Fundamental frequency.
6. " # ": The radiated frequency is out of the restricted band.

<b>CHANNEL</b>	TX Channel 157	<b>DETECTOR FUNCTION</b>	Peak (PK)
<b>FREQUENCY RANGE</b>	1GHz ~ 40GHz		Average (AV)

**ANTENNA POLARITY & TEST DISTANCE: HORIZONTAL AT 3 M**

NO.	FREQ. (MHz)	EMISSION LEVEL (dBuV/m)	LIMIT (dBuV/m)	MARGIN (dB)	ANTENNA HEIGHT (m)	TABLE ANGLE (Degree)	RAW VALUE (dBuV)	CORRECTION FACTOR (dB/m)
1	*5785.00	106.3 PK			1.75 H	335	101.3	5.0
2	*5785.00	106.0 AV			1.75 H	335	101.0	5.0
3	11570.00	53.7 PK	74.0	-20.3	2.23 H	182	39.7	14.0
4	11570.00	40.5 AV	54.0	-13.5	2.23 H	182	26.5	14.0
5	#17355.00	54.7 PK	74.0	-19.3	2.23 H	100	35.8	18.9
6	#17355.00	41.6 AV	54.0	-12.4	2.23 H	100	22.7	18.9

**ANTENNA POLARITY & TEST DISTANCE: VERTICAL AT 3 M**

NO.	FREQ. (MHz)	EMISSION LEVEL (dBuV/m)	LIMIT (dBuV/m)	MARGIN (dB)	ANTENNA HEIGHT (m)	TABLE ANGLE (Degree)	RAW VALUE (dBuV)	CORRECTION FACTOR (dB/m)
1	*5785.00	119.4 PK			1.04 V	357	114.4	5.0
2	*5785.00	109.2 AV			1.04 V	357	104.2	5.0
3	11570.00	50.2 PK	74.0	-23.8	1.50 V	27	36.2	14.0
4	11570.00	37.2 AV	54.0	-16.8	1.50 V	27	23.2	14.0
5	#17355.00	54.5 PK	74.0	-19.5	1.50 V	160	35.6	18.9
6	#17355.00	41.5 AV	54.0	-12.5	1.50 V	160	22.6	18.9

**REMARKS:**

1. Emission Level(dBuV/m) = Raw Value(dBuV) + Correction Factor(dB/m)
2. Correction Factor(dB/m) = Antenna Factor(dB/m) + Cable Factor(dB) – Pre-Amplifier Factor(dB)
3. The other emission levels were very low against the limit.
4. Margin value = Emission Level – Limit value
5. " \* ": Fundamental frequency.
6. " # ": The radiated frequency is out of the restricted band.

<b>CHANNEL</b>	TX Channel 165	<b>DETECTOR FUNCTION</b>	Peak (PK)
<b>FREQUENCY RANGE</b>	1GHz ~ 40GHz		Average (AV)

**ANTENNA POLARITY & TEST DISTANCE: HORIZONTAL AT 3 M**

NO.	FREQ. (MHz)	EMISSION LEVEL (dBuV/m)	LIMIT (dBuV/m)	MARGIN (dB)	ANTENNA HEIGHT (m)	TABLE ANGLE (Degree)	RAW VALUE (dBuV)	CORRECTION FACTOR (dB/m)
1	*5825.00	116.0 PK			1.75 H	338	110.8	5.2
2	*5825.00	105.7 AV			1.75 H	338	100.5	5.2
3	11650.00	53.4 PK	74.0	-20.6	2.21 H	195	39.3	14.1
4	11650.00	40.3 AV	54.0	-13.7	2.21 H	195	26.2	14.1
5	#17475.00	54.5 PK	74.0	-19.5	2.18 H	104	34.8	19.7
6	#17475.00	41.7 AV	54.0	-12.3	2.18 H	104	22.0	19.7

**ANTENNA POLARITY & TEST DISTANCE: VERTICAL AT 3 M**

NO.	FREQ. (MHz)	EMISSION LEVEL (dBuV/m)	LIMIT (dBuV/m)	MARGIN (dB)	ANTENNA HEIGHT (m)	TABLE ANGLE (Degree)	RAW VALUE (dBuV)	CORRECTION FACTOR (dB/m)
1	*5825.00	118.8 PK			1.04 V	358	113.6	5.2
2	*5825.00	108.8 AV			1.04 V	358	103.6	5.2
3	11650.00	50.7 PK	74.0	-23.3	1.54 V	23	36.6	14.1
4	11650.00	37.5 AV	54.0	-16.5	1.54 V	23	23.4	14.1
5	#17475.00	54.5 PK	74.0	-19.5	1.44 V	153	34.8	19.7
6	#17475.00	41.4 AV	54.0	-12.6	1.44 V	153	21.7	19.7

**REMARKS:**

1. Emission Level(dBuV/m) = Raw Value(dBuV) + Correction Factor(dB/m)
2. Correction Factor(dB/m) = Antenna Factor(dB/m) + Cable Factor(dB) – Pre-Amplifier Factor(dB)
3. The other emission levels were very low against the limit.
4. Margin value = Emission Level – Limit value
5. " \* ": Fundamental frequency.
6. " # ": The radiated frequency is out of the restricted band.

**802.11ac (VHT20)**

<b>CHANNEL</b>	TX Channel 36	<b>DETECTOR FUNCTION</b>	Peak (PK)
<b>FREQUENCY RANGE</b>	1GHz ~ 40GHz		Average (AV)

**ANTENNA POLARITY & TEST DISTANCE: HORIZONTAL AT 3 M**

NO.	FREQ. (MHz)	EMISSION LEVEL (dBuV/m)	LIMIT (dBuV/m)	MARGIN (dB)	ANTENNA HEIGHT (m)	TABLE ANGLE (Degree)	RAW VALUE (dBuV)	CORRECTION FACTOR (dB/m)
1	5150.00	71.9 PK	74.0	-2.1	1.55 H	355	67.9	4.0
2	5150.00	52.3 AV	54.0	-1.7	1.55 H	355	48.3	4.0
3	*5180.00	113.0 PK			1.55 H	355	109.0	4.0
4	*5180.00	102.9 AV			1.55 H	355	98.9	4.0
5	#10360.00	50.6 PK	74.0	-23.4	1.81 H	126	37.0	13.6
6	#10360.00	38.5 AV	54.0	-15.5	1.81 H	126	24.9	13.6
7	15540.00	44.6 PK	74.0	-29.4	1.43 H	295	31.4	13.2
8	15540.00	33.2 AV	54.0	-20.8	1.43 H	295	20.0	13.2

**ANTENNA POLARITY & TEST DISTANCE: VERTICAL AT 3 M**

NO.	FREQ. (MHz)	EMISSION LEVEL (dBuV/m)	LIMIT (dBuV/m)	MARGIN (dB)	ANTENNA HEIGHT (m)	TABLE ANGLE (Degree)	RAW VALUE (dBuV)	CORRECTION FACTOR (dB/m)
1	5150.00	72.8 PK	74.0	-1.2	2.23 V	350	68.8	4.0
2	5150.00	53.6 AV	54.0	-0.4	2.23 V	350	49.6	4.0
3	*5180.00	114.0 PK			2.23 V	350	110.0	4.0
4	*5180.00	103.9 AV			2.23 V	350	99.9	4.0
5	#10360.00	51.2 PK	74.0	-22.8	1.85 V	360	37.6	13.6
6	#10360.00	39.6 AV	54.0	-14.4	1.85 V	360	26.0	13.6
7	15540.00	44.3 PK	74.0	-29.7	1.76 V	315	31.1	13.2
8	15540.00	32.0 AV	54.0	-22.0	1.76 V	315	18.8	13.2

**REMARKS:**

- Emission Level(dBuV/m) = Raw Value(dBuV) + Correction Factor(dB/m)
- Correction Factor(dB/m) = Antenna Factor(dB/m) + Cable Factor(dB) – Pre-Amplifier Factor(dB)
- The other emission levels were very low against the limit.
- Margin value = Emission Level – Limit value
- " \* ": Fundamental frequency.
- " # ": The radiated frequency is out of the restricted band.

<b>CHANNEL</b>	TX Channel 40	<b>DETECTOR FUNCTION</b>	Peak (PK)
<b>FREQUENCY RANGE</b>	1GHz ~ 40GHz		Average (AV)

**ANTENNA POLARITY & TEST DISTANCE: HORIZONTAL AT 3 M**

NO.	FREQ. (MHz)	EMISSION LEVEL (dBuV/m)	LIMIT (dBuV/m)	MARGIN (dB)	ANTENNA HEIGHT (m)	TABLE ANGLE (Degree)	RAW VALUE (dBuV)	CORRECTION FACTOR (dB/m)
1	5150.00	71.5 PK	74.0	-2.5	1.61 H	357	67.5	4.0
2	5150.00	51.3 AV	54.0	-2.7	1.61 H	357	47.3	4.0
3	*5200.00	117.5 PK			1.61 H	357	113.5	4.0
4	*5200.00	107.0 AV			1.61 H	357	103.0	4.0
5	5350.00	51.6 PK	74.0	-22.4	1.61 H	357	47.2	4.4
6	5350.00	38.3 AV	54.0	-15.7	1.61 H	357	33.9	4.4
7	#10400.00	51.4 PK	74.0	-22.6	1.84 H	140	37.8	13.6
8	#10400.00	39.2 AV	54.0	-14.8	1.84 H	140	25.6	13.6
9	15600.00	45.1 PK	74.0	-28.9	1.39 H	307	31.7	13.4
10	15600.00	33.2 AV	54.0	-20.8	1.39 H	307	19.8	13.4

**ANTENNA POLARITY & TEST DISTANCE: VERTICAL AT 3 M**

NO.	FREQ. (MHz)	EMISSION LEVEL (dBuV/m)	LIMIT (dBuV/m)	MARGIN (dB)	ANTENNA HEIGHT (m)	TABLE ANGLE (Degree)	RAW VALUE (dBuV)	CORRECTION FACTOR (dB/m)
1	5150.00	72.4 PK	74.0	-1.6	2.23 V	1	68.4	4.0
2	5150.00	52.6 AV	54.0	-1.4	2.23 V	1	48.6	4.0
3	*5200.00	118.5 PK			2.23 V	1	114.5	4.0
4	*5200.00	108.0 AV			2.23 V	1	104.0	4.0
5	5350.00	52.5 PK	74.0	-21.5	2.23 V	1	48.1	4.4
6	5350.00	39.6 AV	54.0	-14.4	2.23 V	1	35.2	4.4
7	#10400.00	51.9 PK	74.0	-22.1	1.85 V	340	38.3	13.6
8	#10400.00	40.4 AV	54.0	-13.6	1.85 V	340	26.8	13.6
9	15600.00	45.6 PK	74.0	-28.4	1.71 V	313	32.2	13.4
10	15600.00	33.5 AV	54.0	-20.5	1.71 V	313	20.1	13.4

**REMARKS:**

1. Emission Level(dBuV/m) = Raw Value(dBuV) + Correction Factor(dB/m)
2. Correction Factor(dB/m) = Antenna Factor(dB/m) + Cable Factor(dB) – Pre-Amplifier Factor(dB)
3. The other emission levels were very low against the limit.
4. Margin value = Emission Level – Limit value
5. " \* ": Fundamental frequency.
6. " # ": The radiated frequency is out of the restricted band.



<b>CHANNEL</b>	TX Channel 48	<b>DETECTOR FUNCTION</b>	Peak (PK)
<b>FREQUENCY RANGE</b>	1GHz ~ 40GHz		Average (AV)

**ANTENNA POLARITY & TEST DISTANCE: HORIZONTAL AT 3 M**

NO.	FREQ. (MHz)	EMISSION LEVEL (dBuV/m)	LIMIT (dBuV/m)	MARGIN (dB)	ANTENNA HEIGHT (m)	TABLE ANGLE (Degree)	RAW VALUE (dBuV)	CORRECTION FACTOR (dB/m)
1	5136.00	51.2 PK	74.0	-22.8	1.58 H	337	47.2	4.0
2	5136.00	38.9 AV	54.0	-15.1	1.58 H	337	34.9	4.0
3	*5240.00	115.8 PK			1.58 H	337	111.6	4.2
4	*5240.00	105.7 AV			1.58 H	337	101.5	4.2
5	5424.00	50.8 PK	74.0	-23.2	1.58 H	337	46.3	4.5
6	5424.00	38.2 AV	54.0	-15.8	1.58 H	337	33.7	4.5
7	#10480.00	51.5 PK	74.0	-22.5	1.88 H	125	37.8	13.7
8	#10480.00	39.3 AV	54.0	-14.7	1.88 H	125	25.6	13.7
9	15720.00	45.1 PK	74.0	-28.9	1.41 H	288	31.1	14.0
10	15720.00	33.9 AV	54.0	-20.1	1.41 H	288	19.9	14.0

**ANTENNA POLARITY & TEST DISTANCE: VERTICAL AT 3 M**

NO.	FREQ. (MHz)	EMISSION LEVEL (dBuV/m)	LIMIT (dBuV/m)	MARGIN (dB)	ANTENNA HEIGHT (m)	TABLE ANGLE (Degree)	RAW VALUE (dBuV)	CORRECTION FACTOR (dB/m)
1	5136.00	52.1 PK	74.0	-21.9	2.33 V	2	48.1	4.0
2	5136.00	40.2 AV	54.0	-13.8	2.33 V	2	36.2	4.0
3	*5240.00	116.8 PK			2.33 V	2	112.6	4.2
4	*5240.00	106.7 AV			2.33 V	2	102.5	4.2
5	5424.00	51.7 PK	74.0	-22.3	2.33 V	2	47.2	4.5
6	5424.00	39.5 AV	54.0	-14.5	2.33 V	2	35.0	4.5
7	#10480.00	50.6 PK	74.0	-23.4	1.88 V	357	36.9	13.7
8	#10480.00	39.2 AV	54.0	-14.8	1.88 V	357	25.5	13.7
9	15720.00	46.1 PK	74.0	-27.9	1.70 V	311	32.1	14.0
10	15720.00	33.5 AV	54.0	-20.5	1.70 V	311	19.5	14.0

**REMARKS:**

- Emission Level(dBuV/m) = Raw Value(dBuV) + Correction Factor(dB/m)
- Correction Factor(dB/m) = Antenna Factor(dB/m) + Cable Factor(dB) – Pre-Amplifier Factor(dB)
- The other emission levels were very low against the limit.
- Margin value = Emission Level – Limit value
- " \* ": Fundamental frequency.
- " # ": The radiated frequency is out of the restricted band.

<b>CHANNEL</b>	TX Channel 149	<b>DETECTOR FUNCTION</b>	Peak (PK)
<b>FREQUENCY RANGE</b>	1GHz ~ 40GHz		Average (AV)

**ANTENNA POLARITY & TEST DISTANCE: HORIZONTAL AT 3 M**

NO.	FREQ. (MHz)	EMISSION LEVEL (dBuV/m)	LIMIT (dBuV/m)	MARGIN (dB)	ANTENNA HEIGHT (m)	TABLE ANGLE (Degree)	RAW VALUE (dBuV)	CORRECTION FACTOR (dB/m)
1	*5745.00	116.8 PK			1.75 H	351	111.8	5.0
2	*5745.00	106.0 AV			1.75 H	351	101.0	5.0
3	11490.00	53.8 PK	74.0	-20.2	2.20 H	196	39.7	14.1
4	11490.00	40.8 AV	54.0	-13.2	2.20 H	196	26.7	14.1
5	#17235.00	55.1 PK	74.0	-18.9	2.30 H	102	36.8	18.3
6	#17235.00	41.6 AV	54.0	-12.4	2.30 H	102	23.3	18.3

**ANTENNA POLARITY & TEST DISTANCE: VERTICAL AT 3 M**

NO.	FREQ. (MHz)	EMISSION LEVEL (dBuV/m)	LIMIT (dBuV/m)	MARGIN (dB)	ANTENNA HEIGHT (m)	TABLE ANGLE (Degree)	RAW VALUE (dBuV)	CORRECTION FACTOR (dB/m)
1	*5745.00	118.4 PK			1.04 V	343	113.4	5.0
2	*5745.00	107.7 AV			1.04 V	343	102.7	5.0
3	11490.00	49.3 PK	74.0	-24.7	1.50 V	13	35.2	14.1
4	11490.00	36.6 AV	54.0	-17.4	1.50 V	13	22.5	14.1
5	#17235.00	53.7 PK	74.0	-20.3	1.49 V	152	35.4	18.3
6	#17235.00	40.6 AV	54.0	-13.4	1.49 V	152	22.3	18.3

**REMARKS:**

1. Emission Level(dBuV/m) = Raw Value(dBuV) + Correction Factor(dB/m)
2. Correction Factor(dB/m) = Antenna Factor(dB/m) + Cable Factor(dB) – Pre-Amplifier Factor(dB)
3. The other emission levels were very low against the limit.
4. Margin value = Emission Level – Limit value
5. " \* ": Fundamental frequency.
6. " # ": The radiated frequency is out of the restricted band.

<b>CHANNEL</b>	TX Channel 157	<b>DETECTOR FUNCTION</b>	Peak (PK)
<b>FREQUENCY RANGE</b>	1GHz ~ 40GHz		Average (AV)

**ANTENNA POLARITY & TEST DISTANCE: HORIZONTAL AT 3 M**

NO.	FREQ. (MHz)	EMISSION LEVEL (dBuV/m)	LIMIT (dBuV/m)	MARGIN (dB)	ANTENNA HEIGHT (m)	TABLE ANGLE (Degree)	RAW VALUE (dBuV)	CORRECTION FACTOR (dB/m)
1	*5785.00	116.5 PK			1.37 H	353	111.5	5.0
2	*5785.00	105.8 AV			1.37 H	353	100.8	5.0
3	11570.00	54.0 PK	74.0	-20.0	2.28 H	178	40.0	14.0
4	11570.00	40.6 AV	54.0	-13.4	2.28 H	178	26.6	14.0
5	#17355.00	54.6 PK	74.0	-19.4	2.20 H	111	35.7	18.9
6	#17355.00	41.8 AV	54.0	-12.2	2.20 H	111	22.9	18.9

**ANTENNA POLARITY & TEST DISTANCE: VERTICAL AT 3 M**

NO.	FREQ. (MHz)	EMISSION LEVEL (dBuV/m)	LIMIT (dBuV/m)	MARGIN (dB)	ANTENNA HEIGHT (m)	TABLE ANGLE (Degree)	RAW VALUE (dBuV)	CORRECTION FACTOR (dB/m)
1	*5785.00	118.4 PK			1.31 V	354	113.4	5.0
2	*5785.00	107.7 AV			1.31 V	354	102.7	5.0
3	11570.00	51.0 PK	74.0	-23.0	1.47 V	34	37.0	14.0
4	11570.00	37.7 AV	54.0	-16.3	1.47 V	34	23.7	14.0
5	#17355.00	54.9 PK	74.0	-19.1	1.55 V	172	36.0	18.9
6	#17355.00	41.6 AV	54.0	-12.4	1.55 V	172	22.7	18.9

**REMARKS:**

1. Emission Level(dBuV/m) = Raw Value(dBuV) + Correction Factor(dB/m)
2. Correction Factor(dB/m) = Antenna Factor(dB/m) + Cable Factor(dB) – Pre-Amplifier Factor(dB)
3. The other emission levels were very low against the limit.
4. Margin value = Emission Level – Limit value
5. " \* ": Fundamental frequency.
6. " # ": The radiated frequency is out of the restricted band.

<b>CHANNEL</b>	TX Channel 165	<b>DETECTOR FUNCTION</b>	Peak (PK)
<b>FREQUENCY RANGE</b>	1GHz ~ 40GHz		Average (AV)

**ANTENNA POLARITY & TEST DISTANCE: HORIZONTAL AT 3 M**

NO.	FREQ. (MHz)	EMISSION LEVEL (dBuV/m)	LIMIT (dBuV/m)	MARGIN (dB)	ANTENNA HEIGHT (m)	TABLE ANGLE (Degree)	RAW VALUE (dBuV)	CORRECTION FACTOR (dB/m)
1	*5825.00	115.5 PK			1.48 H	353	110.3	5.2
2	*5825.00	105.2 AV			1.48 H	353	100.0	5.2
3	11650.00	53.1 PK	74.0	-20.9	2.22 H	207	39.0	14.1
4	11650.00	40.2 AV	54.0	-13.8	2.22 H	207	26.1	14.1
5	#17475.00	54.4 PK	74.0	-19.6	2.13 H	94	34.7	19.7
6	#17475.00	41.5 AV	54.0	-12.5	2.13 H	94	21.8	19.7

**ANTENNA POLARITY & TEST DISTANCE: VERTICAL AT 3 M**

NO.	FREQ. (MHz)	EMISSION LEVEL (dBuV/m)	LIMIT (dBuV/m)	MARGIN (dB)	ANTENNA HEIGHT (m)	TABLE ANGLE (Degree)	RAW VALUE (dBuV)	CORRECTION FACTOR (dB/m)
1	*5825.00	118.3 PK			1.26 V	327	113.1	5.2
2	*5825.00	107.6 AV			1.26 V	327	102.4	5.2
3	11650.00	51.4 PK	74.0	-22.6	1.49 V	24	37.3	14.1
4	11650.00	38.0 AV	54.0	-16.0	1.49 V	24	23.9	14.1
5	#17475.00	55.0 PK	74.0	-19.0	1.43 V	142	35.3	19.7
6	#17475.00	41.9 AV	54.0	-12.1	1.43 V	142	22.2	19.7

**REMARKS:**

1. Emission Level(dBuV/m) = Raw Value(dBuV) + Correction Factor(dB/m)
2. Correction Factor(dB/m) = Antenna Factor(dB/m) + Cable Factor(dB) – Pre-Amplifier Factor(dB)
3. The other emission levels were very low against the limit.
4. Margin value = Emission Level – Limit value
5. " \* ": Fundamental frequency.
6. " # ": The radiated frequency is out of the restricted band.

**802.11ac (VHT40)**

<b>CHANNEL</b>	TX Channel 38	<b>DETECTOR FUNCTION</b>	Peak (PK)
<b>FREQUENCY RANGE</b>	1GHz ~ 40GHz		Average (AV)

**ANTENNA POLARITY & TEST DISTANCE: HORIZONTAL AT 3 M**

NO.	FREQ. (MHz)	EMISSION LEVEL (dBuV/m)	LIMIT (dBuV/m)	MARGIN (dB)	ANTENNA HEIGHT (m)	TABLE ANGLE (Degree)	RAW VALUE (dBuV)	CORRECTION FACTOR (dB/m)
1	5150.00	71.8 PK	74.0	-2.2	1.52 H	360	67.8	4.0
2	5150.00	52.6 AV	54.0	-1.4	1.52 H	360	48.6	4.0
3	*5190.00	109.3 PK			1.52 H	360	105.3	4.0
4	*5190.00	98.9 AV			1.52 H	360	94.9	4.0
5	5424.00	50.6 PK	74.0	-23.4	1.52 H	360	46.1	4.5
6	5424.00	38.0 AV	54.0	-16.0	1.52 H	360	33.5	4.5
7	#10380.00	50.0 PK	74.0	-24.0	1.76 H	127	36.4	13.6
8	#10380.00	38.1 AV	54.0	-15.9	1.76 H	127	24.5	13.6
9	15570.00	45.1 PK	74.0	-28.9	1.47 H	299	31.8	13.3
10	15570.00	33.6 AV	54.0	-20.4	1.47 H	299	20.3	13.3

**ANTENNA POLARITY & TEST DISTANCE: VERTICAL AT 3 M**

NO.	FREQ. (MHz)	EMISSION LEVEL (dBuV/m)	LIMIT (dBuV/m)	MARGIN (dB)	ANTENNA HEIGHT (m)	TABLE ANGLE (Degree)	RAW VALUE (dBuV)	CORRECTION FACTOR (dB/m)
1	5150.00	72.7 PK	74.0	-1.3	2.27 V	355	68.7	4.0
2	<b>5150.00</b>	<b>53.9 AV</b>	<b>54.0</b>	<b>-0.1</b>	<b>2.27 V</b>	<b>355</b>	<b>49.9</b>	<b>4.0</b>
3	*5190.00	110.2 PK			2.27 V	355	106.2	4.0
4	*5190.00	99.8 AV			2.27 V	355	95.8	4.0
5	5424.00	51.5 PK	74.0	-22.5	2.27 V	355	47.0	4.5
6	5424.00	39.3 AV	54.0	-14.7	2.27 V	355	34.8	4.5
7	#10380.00	51.1 PK	74.0	-22.9	1.87 V	360	37.5	13.6
8	#10380.00	39.7 AV	54.0	-14.3	1.87 V	360	26.1	13.6
9	15570.00	44.5 PK	74.0	-29.5	1.72 V	304	31.2	13.3
10	15570.00	32.1 AV	54.0	-21.9	1.72 V	304	18.8	13.3

**REMARKS:**

- Emission Level(dBuV/m) = Raw Value(dBuV) + Correction Factor(dB/m)
- Correction Factor(dB/m) = Antenna Factor(dB/m) + Cable Factor(dB) – Pre-Amplifier Factor(dB)
- The other emission levels were very low against the limit.
- Margin value = Emission Level – Limit value
- " \* ": Fundamental frequency.
- " # ": The radiated frequency is out of the restricted band.

<b>CHANNEL</b>	TX Channel 46	<b>DETECTOR FUNCTION</b>	Peak (PK)
<b>FREQUENCY RANGE</b>	1GHz ~ 40GHz		Average (AV)

**ANTENNA POLARITY & TEST DISTANCE: HORIZONTAL AT 3 M**

NO.	FREQ. (MHz)	EMISSION LEVEL (dBuV/m)	LIMIT (dBuV/m)	MARGIN (dB)	ANTENNA HEIGHT (m)	TABLE ANGLE (Degree)	RAW VALUE (dBuV)	CORRECTION FACTOR (dB/m)
1	5150.00	64.6 PK	74.0	-9.4	1.58 H	344	60.6	4.0
2	5150.00	47.6 AV	54.0	-6.4	1.58 H	344	43.6	4.0
3	*5230.00	113.3 PK			1.58 H	344	109.1	4.2
4	*5230.00	103.2 AV			1.58 H	344	99.0	4.2
5	5350.00	58.4 PK	74.0	-15.6	1.58 H	344	54.0	4.4
6	5350.00	40.8 AV	54.0	-13.2	1.58 H	344	36.4	4.4
7	#10460.00	51.8 PK	74.0	-22.2	1.90 H	110	38.1	13.7
8	#10460.00	39.7 AV	54.0	-14.3	1.90 H	110	26.0	13.7
9	15690.00	44.9 PK	74.0	-29.1	1.43 H	286	30.9	14.0
10	15690.00	33.6 AV	54.0	-20.4	1.43 H	286	19.6	14.0

**ANTENNA POLARITY & TEST DISTANCE: VERTICAL AT 3 M**

NO.	FREQ. (MHz)	EMISSION LEVEL (dBuV/m)	LIMIT (dBuV/m)	MARGIN (dB)	ANTENNA HEIGHT (m)	TABLE ANGLE (Degree)	RAW VALUE (dBuV)	CORRECTION FACTOR (dB/m)
1	5150.00	65.5 PK	74.0	-8.5	2.27 V	330	61.5	4.0
2	5150.00	48.9 AV	54.0	-5.1	2.27 V	330	44.9	4.0
3	*5230.00	114.0 PK			2.27 V	330	109.8	4.2
4	*5230.00	104.2 AV			2.27 V	330	100.0	4.2
5	5350.00	59.3 PK	74.0	-14.7	2.27 V	330	54.9	4.4
6	5350.00	42.1 AV	54.0	-11.9	2.27 V	330	37.7	4.4
7	#10460.00	50.6 PK	74.0	-23.4	1.82 V	360	36.9	13.7
8	#10460.00	39.4 AV	54.0	-14.6	1.82 V	360	25.7	13.7
9	15690.00	46.2 PK	74.0	-27.8	1.72 V	316	32.2	14.0
10	15690.00	33.9 AV	54.0	-20.1	1.72 V	316	19.9	14.0

**REMARKS:**

1. Emission Level(dBuV/m) = Raw Value(dBuV) + Correction Factor(dB/m)
2. Correction Factor(dB/m) = Antenna Factor(dB/m) + Cable Factor(dB) – Pre-Amplifier Factor(dB)
3. The other emission levels were very low against the limit.
4. Margin value = Emission Level – Limit value
5. " \* ": Fundamental frequency.
6. " # ": The radiated frequency is out of the restricted band.

<b>CHANNEL</b>	TX Channel 151	<b>DETECTOR FUNCTION</b>	Peak (PK)
<b>FREQUENCY RANGE</b>	1GHz ~ 40GHz		Average (AV)

**ANTENNA POLARITY & TEST DISTANCE: HORIZONTAL AT 3 M**

NO.	FREQ. (MHz)	EMISSION LEVEL (dBuV/m)	LIMIT (dBuV/m)	MARGIN (dB)	ANTENNA HEIGHT (m)	TABLE ANGLE (Degree)	RAW VALUE (dBuV)	CORRECTION FACTOR (dB/m)
1	*5755.00	113.3 PK			1.48 H	353	108.3	5.0
2	*5755.00	103.2 AV			1.48 H	353	98.2	5.0
3	11510.00	52.7 PK	74.0	-21.3	2.28 H	221	38.7	14.0
4	11510.00	39.9 AV	54.0	-14.1	2.28 H	221	25.9	14.0
5	#17265.00	54.3 PK	74.0	-19.7	2.16 H	84	35.8	18.5
6	#17265.00	41.4 AV	54.0	-12.6	2.16 H	84	22.9	18.5

**ANTENNA POLARITY & TEST DISTANCE: VERTICAL AT 3 M**

NO.	FREQ. (MHz)	EMISSION LEVEL (dBuV/m)	LIMIT (dBuV/m)	MARGIN (dB)	ANTENNA HEIGHT (m)	TABLE ANGLE (Degree)	RAW VALUE (dBuV)	CORRECTION FACTOR (dB/m)
1	*5755.00	116.5 PK			1.26 V	354	111.5	5.0
2	*5755.00	106.5 AV			1.26 V	354	101.5	5.0
3	11510.00	51.8 PK	74.0	-22.2	1.49 V	24	37.8	14.0
4	11510.00	38.2 AV	54.0	-15.8	1.49 V	24	24.2	14.0
5	#17265.00	55.4 PK	74.0	-18.6	1.40 V	134	36.9	18.5
6	#17265.00	42.2 AV	54.0	-11.8	1.40 V	134	23.7	18.5

**REMARKS:**

- Emission Level(dBuV/m) = Raw Value(dBuV) + Correction Factor(dB/m)
- Correction Factor(dB/m) = Antenna Factor(dB/m) + Cable Factor(dB) – Pre-Amplifier Factor(dB)
- The other emission levels were very low against the limit.
- Margin value = Emission Level – Limit value
- " \* ": Fundamental frequency.
- " # ": The radiated frequency is out of the restricted band.

<b>CHANNEL</b>	TX Channel 159	<b>DETECTOR FUNCTION</b>	Peak (PK)
<b>FREQUENCY RANGE</b>	1GHz ~ 40GHz		Average (AV)

**ANTENNA POLARITY & TEST DISTANCE: HORIZONTAL AT 3 M**

NO.	FREQ. (MHz)	EMISSION LEVEL (dBuV/m)	LIMIT (dBuV/m)	MARGIN (dB)	ANTENNA HEIGHT (m)	TABLE ANGLE (Degree)	RAW VALUE (dBuV)	CORRECTION FACTOR (dB/m)
1	*5795.00	113.1 PK			1.50 H	353	108.0	5.1
2	*5795.00	103.0 AV			1.50 H	353	97.9	5.1
3	11590.00	52.5 PK	74.0	-21.5	2.24 H	191	38.5	14.0
4	11590.00	39.7 AV	54.0	-14.3	2.24 H	191	25.7	14.0
5	#17385.00	53.8 PK	74.0	-20.2	2.12 H	82	34.7	19.1
6	#17385.00	41.0 AV	54.0	-13.0	2.12 H	82	21.9	19.1

**ANTENNA POLARITY & TEST DISTANCE: VERTICAL AT 3 M**

NO.	FREQ. (MHz)	EMISSION LEVEL (dBuV/m)	LIMIT (dBuV/m)	MARGIN (dB)	ANTENNA HEIGHT (m)	TABLE ANGLE (Degree)	RAW VALUE (dBuV)	CORRECTION FACTOR (dB/m)
1	*5795.00	116.3 PK			1.26 V	354	111.2	5.1
2	*5795.00	106.3 AV			1.26 V	354	101.2	5.1
3	11590.00	51.6 PK	74.0	-22.4	1.52 V	34	37.6	14.0
4	11590.00	38.4 AV	54.0	-15.6	1.52 V	34	24.4	14.0
5	#17385.00	54.6 PK	74.0	-19.4	1.40 V	129	35.5	19.1
6	#17385.00	41.7 AV	54.0	-12.3	1.40 V	129	22.6	19.1

**REMARKS:**

- Emission Level(dBuV/m) = Raw Value(dBuV) + Correction Factor(dB/m)
- Correction Factor(dB/m) = Antenna Factor(dB/m) + Cable Factor(dB) – Pre-Amplifier Factor(dB)
- The other emission levels were very low against the limit.
- Margin value = Emission Level – Limit value
- " \* ": Fundamental frequency.
- " # ": The radiated frequency is out of the restricted band.



**802.11ac (VHT80)**

<b>CHANNEL</b>	TX Channel 42	<b>DETECTOR FUNCTION</b>	Peak (PK)
<b>FREQUENCY RANGE</b>	1GHz ~ 40GHz		Average (AV)

**ANTENNA POLARITY & TEST DISTANCE: HORIZONTAL AT 3 M**

NO.	FREQ. (MHz)	EMISSION LEVEL (dBuV/m)	LIMIT (dBuV/m)	MARGIN (dB)	ANTENNA HEIGHT (m)	TABLE ANGLE (Degree)	RAW VALUE (dBuV)	CORRECTION FACTOR (dB/m)
1	5137.00	68.3 PK	74.0	-5.7	1.60 H	352	64.3	4.0
2	5137.00	52.2 AV	54.0	-1.8	1.60 H	352	48.2	4.0
3	*5210.00	105.0 PK			1.60 H	352	100.9	4.1
4	*5210.00	95.2 AV			1.60 H	352	91.1	4.1
5	5352.00	55.5 PK	74.0	-18.5	1.60 H	352	51.1	4.4
6	5352.00	40.3 AV	54.0	-13.7	1.60 H	352	35.9	4.4
7	#10420.00	50.8 PK	74.0	-23.2	1.78 H	139	37.2	13.6
8	#10420.00	38.8 AV	54.0	-15.2	1.78 H	139	25.2	13.6
9	15630.00	44.5 PK	74.0	-29.5	1.39 H	299	30.9	13.6
10	15630.00	33.3 AV	54.0	-20.7	1.39 H	299	19.7	13.6

**ANTENNA POLARITY & TEST DISTANCE: VERTICAL AT 3 M**

NO.	FREQ. (MHz)	EMISSION LEVEL (dBuV/m)	LIMIT (dBuV/m)	MARGIN (dB)	ANTENNA HEIGHT (m)	TABLE ANGLE (Degree)	RAW VALUE (dBuV)	CORRECTION FACTOR (dB/m)
1	5137.00	69.2 PK	74.0	-4.8	2.27 V	330	65.2	4.0
2	5137.00	53.5 AV	54.0	-0.5	2.27 V	330	49.5	4.0
3	*5210.00	106.0 PK			2.27 V	330	101.9	4.1
4	*5210.00	96.3 AV			2.27 V	330	92.2	4.1
5	5352.00	56.4 PK	74.0	-17.6	2.27 V	330	52.0	4.4
6	5352.00	41.6 AV	54.0	-12.4	2.27 V	330	37.2	4.4
7	#10420.00	51.2 PK	74.0	-22.8	1.82 V	357	37.6	13.6
8	#10420.00	39.8 AV	54.0	-14.2	1.82 V	357	26.2	13.6
9	15630.00	44.3 PK	74.0	-29.7	1.79 V	313	30.7	13.6
10	15630.00	32.0 AV	54.0	-22.0	1.79 V	313	18.4	13.6

**REMARKS:**

- Emission Level(dBuV/m) = Raw Value(dBuV) + Correction Factor(dB/m)
- Correction Factor(dB/m) = Antenna Factor(dB/m) + Cable Factor(dB) – Pre-Amplifier Factor(dB)
- The other emission levels were very low against the limit.
- Margin value = Emission Level – Limit value
- " \* ": Fundamental frequency.
- " # ": The radiated frequency is out of the restricted band.

<b>CHANNEL</b>	TX Channel 155	<b>DETECTOR FUNCTION</b>	Peak (PK)
<b>FREQUENCY RANGE</b>	1GHz ~ 40GHz		Average (AV)

**ANTENNA POLARITY & TEST DISTANCE: HORIZONTAL AT 3 M**

NO.	FREQ. (MHz)	EMISSION LEVEL (dBuV/m)	LIMIT (dBuV/m)	MARGIN (dB)	ANTENNA HEIGHT (m)	TABLE ANGLE (Degree)	RAW VALUE (dBuV)	CORRECTION FACTOR (dB/m)
1	*5775.00	107.3 PK			1.50 H	353	102.3	5.0
2	*5775.00	97.5 AV			1.50 H	353	92.5	5.0
3	11550.00	52.7 PK	74.0	-21.3	2.17 H	196	38.7	14.0
4	11550.00	40.1 AV	54.0	-13.9	2.17 H	196	26.1	14.0
5	#17325.00	53.8 PK	74.0	-20.2	2.07 H	81	35.2	18.6
6	#17325.00	41.1 AV	54.0	-12.9	2.07 H	81	22.5	18.6

**ANTENNA POLARITY & TEST DISTANCE: VERTICAL AT 3 M**

NO.	FREQ. (MHz)	EMISSION LEVEL (dBuV/m)	LIMIT (dBuV/m)	MARGIN (dB)	ANTENNA HEIGHT (m)	TABLE ANGLE (Degree)	RAW VALUE (dBuV)	CORRECTION FACTOR (dB/m)
1	*5775.00	110.5 PK			1.07 V	354	105.5	5.0
2	*5775.00	100.2 AV			1.07 V	354	95.2	5.0
3	11550.00	51.8 PK	74.0	-22.2	1.53 V	13	37.8	14.0
4	11550.00	38.3 AV	54.0	-15.7	1.53 V	13	24.3	14.0
5	#17325.00	54.9 PK	74.0	-19.1	1.47 V	138	36.3	18.6
6	#17325.00	41.7 AV	54.0	-12.3	1.47 V	138	23.1	18.6

**REMARKS:**

- Emission Level(dBuV/m) = Raw Value(dBuV) + Correction Factor(dB/m)
- Correction Factor(dB/m) = Antenna Factor(dB/m) + Cable Factor(dB) – Pre-Amplifier Factor(dB)
- The other emission levels were very low against the limit.
- Margin value = Emission Level – Limit value
- " \* ": Fundamental frequency.
- " # ": The radiated frequency is out of the restricted band.

**Below 1GHz Data:**

**802.11ac (VHT40)**

<b>CHANNEL</b>	TX Channel 159	<b>DETECTOR FUNCTION</b>	Quasi-Peak (QP)
<b>FREQUENCY RANGE</b>	9kHz ~ 1GHz		

**ANTENNA POLARITY & TEST DISTANCE: HORIZONTAL AT 3 M**

NO.	FREQ. (MHz)	EMISSION LEVEL (dBuV/m)	LIMIT (dBuV/m)	MARGIN (dB)	ANTENNA HEIGHT (m)	TABLE ANGLE (Degree)	RAW VALUE (dBuV)	CORRECTION FACTOR (dB/m)
1	31.79	36.8 QP	40.0	-3.2	1.00 H	133	46.2	-9.4
2	98.05	36.0 QP	43.5	-7.5	2.00 H	110	49.0	-13.0
3	359.97	36.8 QP	46.0	-9.2	1.00 H	314	43.0	-6.2
4	440.02	32.9 QP	46.0	-13.1	2.00 H	360	36.7	-3.8
5	480.01	32.3 QP	46.0	-13.7	2.00 H	360	35.3	-3.0
6	625.00	39.8 QP	46.0	-6.2	2.00 H	360	39.9	-0.1

**ANTENNA POLARITY & TEST DISTANCE: VERTICAL AT 3 M**

NO.	FREQ. (MHz)	EMISSION LEVEL (dBuV/m)	LIMIT (dBuV/m)	MARGIN (dB)	ANTENNA HEIGHT (m)	TABLE ANGLE (Degree)	RAW VALUE (dBuV)	CORRECTION FACTOR (dB/m)
1	65.02	36.7 QP	40.0	-3.3	1.00 V	228	45.7	-9.0
2	137.06	33.3 QP	43.5	-10.2	1.00 V	360	41.7	-8.4
3	196.86	30.2 QP	43.5	-13.3	1.00 V	352	41.6	-11.4
4	360.02	35.4 QP	46.0	-10.6	1.00 V	5	41.5	-6.1
5	439.99	32.3 QP	46.0	-13.7	1.00 V	1	36.1	-3.8
6	625.02	31.7 QP	46.0	-14.3	1.00 V	360	31.8	-0.1

**REMARKS:**

1. Emission Level(dBuV/m) = Raw Value(dBuV) + Correction Factor(dB/m)
2. Correction Factor(dB/m) = Antenna Factor(dB/m) + Cable Factor(dB) – Pre-Amplifier Factor(dB)
3. The other emission levels were very low against the limit.
4. Margin value = Emission Level – Limit value

4.1.8 Test Results (Mode 2)

Above 1GHz Data:

802.11a

<b>CHANNEL</b>	TX Channel 36	<b>DETECTOR FUNCTION</b>	Peak (PK)
<b>FREQUENCY RANGE</b>	1GHz ~ 40GHz		Average (AV)

ANTENNA POLARITY & TEST DISTANCE: HORIZONTAL AT 3 M								
NO.	FREQ. (MHz)	EMISSION LEVEL (dBuV/m)	LIMIT (dBuV/m)	MARGIN (dB)	ANTENNA HEIGHT (m)	TABLE ANGLE (Degree)	RAW VALUE (dBuV)	CORRECTION FACTOR (dB/m)
1	5150.00	67.8 PK	74.0	-6.2	1.00 H	289	63.8	4.0
2	5150.00	53.5 AV	54.0	-0.5	1.00 H	289	49.5	4.0
3	*5180.00	111.3 PK			1.00 H	289	107.3	4.0
4	*5180.00	101.3 AV			1.00 H	289	97.3	4.0
5	#10360.00	64.2 PK	74.0	-9.8	1.77 H	316	50.6	13.6
6	#10360.00	49.0 AV	54.0	-5.0	1.77 H	316	35.4	13.6
7	15540.00	45.8 PK	74.0	-28.2	1.73 H	359	32.6	13.2
8	15540.00	33.5 AV	54.0	-20.5	1.73 H	359	20.3	13.2

ANTENNA POLARITY & TEST DISTANCE: VERTICAL AT 3 M								
NO.	FREQ. (MHz)	EMISSION LEVEL (dBuV/m)	LIMIT (dBuV/m)	MARGIN (dB)	ANTENNA HEIGHT (m)	TABLE ANGLE (Degree)	RAW VALUE (dBuV)	CORRECTION FACTOR (dB/m)
1	5150.00	67.0 PK	74.0	-7.0	1.86 V	300	63.0	4.0
2	5150.00	52.7 AV	54.0	-1.3	1.86 V	300	48.7	4.0
3	*5180.00	110.2 PK			1.86 V	300	106.2	4.0
4	*5180.00	100.1 AV			1.86 V	300	96.1	4.0
5	#10360.00	63.5 PK	74.0	-10.5	1.54 V	360	49.9	13.6
6	#10360.00	48.2 AV	54.0	-5.8	1.54 V	360	34.6	13.6
7	15540.00	45.7 PK	74.0	-28.3	1.90 V	12	32.5	13.2
8	15540.00	33.4 AV	54.0	-20.6	1.90 V	12	20.2	13.2

REMARKS:

1. Emission Level(dBuV/m) = Raw Value(dBuV) + Correction Factor(dB/m)
2. Correction Factor(dB/m) = Antenna Factor(dB/m) + Cable Factor(dB) – Pre-Amplifier Factor(dB)
3. The other emission levels were very low against the limit.
4. Margin value = Emission Level – Limit value
5. " \* ": Fundamental frequency.
6. " # ": The radiated frequency is out of the restricted band.

<b>CHANNEL</b>	TX Channel 40	<b>DETECTOR FUNCTION</b>	Peak (PK)
<b>FREQUENCY RANGE</b>	1GHz ~ 40GHz		Average (AV)

**ANTENNA POLARITY & TEST DISTANCE: HORIZONTAL AT 3 M**

NO.	FREQ. (MHz)	EMISSION LEVEL (dBuV/m)	LIMIT (dBuV/m)	MARGIN (dB)	ANTENNA HEIGHT (m)	TABLE ANGLE (Degree)	RAW VALUE (dBuV)	CORRECTION FACTOR (dB/m)
1	5150.00	61.5 PK	74.0	-12.5	1.00 H	290	57.5	4.0
2	5150.00	46.8 AV	54.0	-7.2	1.00 H	290	42.8	4.0
3	*5200.00	115.5 PK			1.00 H	290	111.5	4.0
4	*5200.00	105.2 AV			1.00 H	290	101.2	4.0
5	5360.00	54.5 PK	74.0	-19.5	1.00 H	290	50.1	4.4
6	5360.00	42.7 AV	54.0	-11.3	1.00 H	290	38.3	4.4
7	#10400.00	65.7 PK	74.0	-8.3	1.79 H	317	52.1	13.6
8	#10400.00	50.5 AV	54.0	-3.5	1.79 H	317	36.9	13.6
9	15600.00	47.3 PK	74.0	-26.7	1.77 H	359	33.9	13.4
10	15600.00	35.0 AV	54.0	-19.0	1.77 H	359	21.6	13.4

**ANTENNA POLARITY & TEST DISTANCE: VERTICAL AT 3 M**

NO.	FREQ. (MHz)	EMISSION LEVEL (dBuV/m)	LIMIT (dBuV/m)	MARGIN (dB)	ANTENNA HEIGHT (m)	TABLE ANGLE (Degree)	RAW VALUE (dBuV)	CORRECTION FACTOR (dB/m)
1	5150.00	60.7 PK	74.0	-13.3	1.91 V	289	56.7	4.0
2	5150.00	46.0 AV	54.0	-8.0	1.91 V	289	42.0	4.0
3	*5200.00	114.4 PK			1.91 V	289	110.4	4.0
4	*5200.00	104.0 AV			1.91 V	289	100.0	4.0
5	5360.00	53.7 PK	74.0	-20.3	1.91 V	289	49.3	4.4
6	5360.00	41.9 AV	54.0	-12.1	1.91 V	289	37.5	4.4
7	#10400.00	65.0 PK	74.0	-9.0	1.50 V	343	51.4	13.6
8	#10400.00	49.7 AV	54.0	-4.3	1.50 V	343	36.1	13.6
9	15600.00	47.2 PK	74.0	-26.8	1.91 V	1	33.8	13.4
10	15600.00	34.9 AV	54.0	-19.1	1.91 V	1	21.5	13.4

**REMARKS:**

1. Emission Level(dBuV/m) = Raw Value(dBuV) + Correction Factor(dB/m)
2. Correction Factor(dB/m) = Antenna Factor(dB/m) + Cable Factor(dB) – Pre-Amplifier Factor(dB)
3. The other emission levels were very low against the limit.
4. Margin value = Emission Level – Limit value
5. " \* ": Fundamental frequency.
6. " # ": The radiated frequency is out of the restricted band.

<b>CHANNEL</b>	TX Channel 48	<b>DETECTOR FUNCTION</b>	Peak (PK)
<b>FREQUENCY RANGE</b>	1GHz ~ 40GHz		Average (AV)

**ANTENNA POLARITY & TEST DISTANCE: HORIZONTAL AT 3 M**

NO.	FREQ. (MHz)	EMISSION LEVEL (dBuV/m)	LIMIT (dBuV/m)	MARGIN (dB)	ANTENNA HEIGHT (m)	TABLE ANGLE (Degree)	RAW VALUE (dBuV)	CORRECTION FACTOR (dB/m)
1	5150.00	52.1 PK	74.0	-21.9	1.00 H	290	48.1	4.0
2	5150.00	39.6 AV	54.0	-14.4	1.00 H	290	35.6	4.0
3	*5240.00	112.3 PK			1.00 H	290	108.1	4.2
4	*5240.00	102.0 AV			1.00 H	290	97.8	4.2
5	5393.00	53.5 PK	74.0	-20.5	1.00 H	290	49.1	4.4
6	5393.00	41.7 AV	54.0	-12.3	1.00 H	290	37.3	4.4
7	#10480.00	65.2 PK	74.0	-8.8	1.73 H	314	51.5	13.7
8	#10480.00	50.0 AV	54.0	-4.0	1.73 H	314	36.3	13.7
9	15720.00	46.8 PK	74.0	-27.2	1.73 H	350	32.8	14.0
10	15720.00	34.5 AV	54.0	-19.5	1.73 H	350	20.5	14.0

**ANTENNA POLARITY & TEST DISTANCE: VERTICAL AT 3 M**

NO.	FREQ. (MHz)	EMISSION LEVEL (dBuV/m)	LIMIT (dBuV/m)	MARGIN (dB)	ANTENNA HEIGHT (m)	TABLE ANGLE (Degree)	RAW VALUE (dBuV)	CORRECTION FACTOR (dB/m)
1	5150.00	51.3 PK	74.0	-22.7	1.85 V	289	47.3	4.0
2	5150.00	38.8 AV	54.0	-15.2	1.85 V	289	34.8	4.0
3	*5240.00	111.2 PK			1.85 V	289	107.0	4.2
4	*5240.00	100.8 AV			1.85 V	289	96.6	4.2
5	5393.00	52.7 PK	74.0	-21.3	1.85 V	289	48.3	4.4
6	5393.00	40.9 AV	54.0	-13.1	1.85 V	289	36.5	4.4
7	#10480.00	64.5 PK	74.0	-9.5	1.54 V	351	50.8	13.7
8	#10480.00	49.2 AV	54.0	-4.8	1.54 V	351	35.5	13.7
9	15720.00	46.7 PK	74.0	-27.3	1.93 V	0	32.7	14.0
10	15720.00	34.4 AV	54.0	-19.6	1.93 V	0	20.4	14.0

**REMARKS:**

1. Emission Level(dBuV/m) = Raw Value(dBuV) + Correction Factor(dB/m)
2. Correction Factor(dB/m) = Antenna Factor(dB/m) + Cable Factor(dB) – Pre-Amplifier Factor(dB)
3. The other emission levels were very low against the limit.
4. Margin value = Emission Level – Limit value
5. " \* ": Fundamental frequency.
6. " # ": The radiated frequency is out of the restricted band.

<b>CHANNEL</b>	TX Channel 149	<b>DETECTOR FUNCTION</b>	Peak (PK)
<b>FREQUENCY RANGE</b>	1GHz ~ 40GHz		Average (AV)

**ANTENNA POLARITY & TEST DISTANCE: HORIZONTAL AT 3 M**

NO.	FREQ. (MHz)	EMISSION LEVEL (dBuV/m)	LIMIT (dBuV/m)	MARGIN (dB)	ANTENNA HEIGHT (m)	TABLE ANGLE (Degree)	RAW VALUE (dBuV)	CORRECTION FACTOR (dB/m)
1	*5745.00	112.8 PK			1.00 H	290	107.8	5.0
2	*5745.00	102.2 AV			1.00 H	290	97.2	5.0
3	11490.00	66.7 PK	74.0	-7.3	1.73 H	177	52.6	14.1
4	11490.00	53.8 AV	54.0	-0.2	1.73 H	177	39.7	14.1
5	#17235.00	54.9 PK	74.0	-19.1	1.76 H	95	36.6	18.3
6	#17235.00	42.0 AV	54.0	-12.0	1.76 H	95	23.7	18.3

**ANTENNA POLARITY & TEST DISTANCE: VERTICAL AT 3 M**

NO.	FREQ. (MHz)	EMISSION LEVEL (dBuV/m)	LIMIT (dBuV/m)	MARGIN (dB)	ANTENNA HEIGHT (m)	TABLE ANGLE (Degree)	RAW VALUE (dBuV)	CORRECTION FACTOR (dB/m)
1	*5745.00	111.8 PK			1.30 V	294	106.8	5.0
2	*5745.00	101.2 AV			1.30 V	294	96.2	5.0
3	11490.00	61.9 PK	74.0	-12.1	1.25 V	30	47.8	14.1
4	11490.00	46.6 AV	54.0	-7.4	1.25 V	30	32.5	14.1
5	#17235.00	54.4 PK	74.0	-19.6	1.24 V	36	36.1	18.3
6	#17235.00	41.4 AV	54.0	-12.6	1.24 V	36	23.1	18.3

**REMARKS:**

1. Emission Level(dBuV/m) = Raw Value(dBuV) + Correction Factor(dB/m)
2. Correction Factor(dB/m) = Antenna Factor(dB/m) + Cable Factor(dB) – Pre-Amplifier Factor(dB)
3. The other emission levels were very low against the limit.
4. Margin value = Emission Level – Limit value
5. " \* ": Fundamental frequency.
6. " # ": The radiated frequency is out of the restricted band.

<b>CHANNEL</b>	TX Channel 157	<b>DETECTOR FUNCTION</b>	Peak (PK)
<b>FREQUENCY RANGE</b>	1GHz ~ 40GHz		Average (AV)

**ANTENNA POLARITY & TEST DISTANCE: HORIZONTAL AT 3 M**

NO.	FREQ. (MHz)	EMISSION LEVEL (dBuV/m)	LIMIT (dBuV/m)	MARGIN (dB)	ANTENNA HEIGHT (m)	TABLE ANGLE (Degree)	RAW VALUE (dBuV)	CORRECTION FACTOR (dB/m)
1	*5785.00	112.7 PK			1.00 H	290	107.7	5.0
2	*5785.00	102.1 AV			1.00 H	290	97.1	5.0
3	11570.00	66.5 PK	74.0	-7.5	2.01 H	166	52.5	14.0
4	11570.00	53.7 AV	54.0	-0.3	2.01 H	166	39.7	14.0
5	#17355.00	54.1 PK	74.0	-19.9	1.73 H	100	35.2	18.9
6	#17355.00	41.5 AV	54.0	-12.5	1.73 H	100	22.6	18.9

**ANTENNA POLARITY & TEST DISTANCE: VERTICAL AT 3 M**

NO.	FREQ. (MHz)	EMISSION LEVEL (dBuV/m)	LIMIT (dBuV/m)	MARGIN (dB)	ANTENNA HEIGHT (m)	TABLE ANGLE (Degree)	RAW VALUE (dBuV)	CORRECTION FACTOR (dB/m)
1	*5785.00	111.6 PK			1.30 V	294	106.6	5.0
2	*5785.00	100.9 AV			1.30 V	294	95.9	5.0
3	11570.00	61.5 PK	74.0	-12.5	1.23 V	15	47.5	14.0
4	11570.00	46.3 AV	54.0	-7.7	1.23 V	15	32.3	14.0
5	#17355.00	54.2 PK	74.0	-19.8	1.25 V	50	35.3	18.9
6	#17355.00	41.5 AV	54.0	-12.5	1.25 V	50	22.6	18.9

**REMARKS:**

1. Emission Level(dBuV/m) = Raw Value(dBuV) + Correction Factor(dB/m)
2. Correction Factor(dB/m) = Antenna Factor(dB/m) + Cable Factor(dB) – Pre-Amplifier Factor(dB)
3. The other emission levels were very low against the limit.
4. Margin value = Emission Level – Limit value
5. " \* ": Fundamental frequency.
6. " # ": The radiated frequency is out of the restricted band.



<b>CHANNEL</b>	TX Channel 165	<b>DETECTOR FUNCTION</b>	Peak (PK)
<b>FREQUENCY RANGE</b>	1GHz ~ 40GHz		Average (AV)

**ANTENNA POLARITY & TEST DISTANCE: HORIZONTAL AT 3 M**

NO.	FREQ. (MHz)	EMISSION LEVEL (dBuV/m)	LIMIT (dBuV/m)	MARGIN (dB)	ANTENNA HEIGHT (m)	TABLE ANGLE (Degree)	RAW VALUE (dBuV)	CORRECTION FACTOR (dB/m)
1	*5825.00	113.3 PK			1.00 H	290	108.1	5.2
2	*5825.00	102.6 AV			1.00 H	290	97.4	5.2
3	11650.00	67.1 PK	74.0	-6.9	2.01 H	184	53.0	14.1
4	<b>11650.00</b>	<b>53.9 AV</b>	<b>54.0</b>	<b>-0.1</b>	<b>2.01 H</b>	<b>184</b>	<b>39.8</b>	<b>14.1</b>
5	#17475.00	54.0 PK	74.0	-20.0	1.69 H	115	34.3	19.7
6	#17475.00	41.4 AV	54.0	-12.6	1.69 H	115	21.7	19.7

**ANTENNA POLARITY & TEST DISTANCE: VERTICAL AT 3 M**

NO.	FREQ. (MHz)	EMISSION LEVEL (dBuV/m)	LIMIT (dBuV/m)	MARGIN (dB)	ANTENNA HEIGHT (m)	TABLE ANGLE (Degree)	RAW VALUE (dBuV)	CORRECTION FACTOR (dB/m)
1	*5825.00	111.7 PK			1.30 V	294	106.5	5.2
2	*5825.00	100.9 AV			1.30 V	294	95.7	5.2
3	11650.00	61.5 PK	74.0	-12.5	1.27 V	20	47.4	14.1
4	11650.00	46.3 AV	54.0	-7.7	1.27 V	20	32.2	14.1
5	#17475.00	54.6 PK	74.0	-19.4	1.30 V	51	34.9	19.7
6	#17475.00	41.4 AV	54.0	-12.6	1.30 V	51	21.7	19.7

**REMARKS:**

1. Emission Level(dBuV/m) = Raw Value(dBuV) + Correction Factor(dB/m)
2. Correction Factor(dB/m) = Antenna Factor(dB/m) + Cable Factor(dB) – Pre-Amplifier Factor(dB)
3. The other emission levels were very low against the limit.
4. Margin value = Emission Level – Limit value
5. " \* ": Fundamental frequency.
6. " # ": The radiated frequency is out of the restricted band.

**802.11ac (VHT20)**

<b>CHANNEL</b>	TX Channel 36	<b>DETECTOR FUNCTION</b>	Peak (PK)
<b>FREQUENCY RANGE</b>	1GHz ~ 40GHz		Average (AV)

**ANTENNA POLARITY & TEST DISTANCE: HORIZONTAL AT 3 M**

NO.	FREQ. (MHz)	EMISSION LEVEL (dBuV/m)	LIMIT (dBuV/m)	MARGIN (dB)	ANTENNA HEIGHT (m)	TABLE ANGLE (Degree)	RAW VALUE (dBuV)	CORRECTION FACTOR (dB/m)
1	5150.00	70.2 PK	74.0	-3.8	1.00 H	291	66.2	4.0
2	5150.00	53.7 AV	54.0	-0.3	1.00 H	291	49.7	4.0
3	*5180.00	110.8 PK			1.00 H	291	106.8	4.0
4	*5180.00	100.9 AV			1.00 H	291	96.9	4.0
5	#10360.00	63.7 PK	74.0	-10.3	1.83 H	325	50.1	13.6
6	#10360.00	48.7 AV	54.0	-5.3	1.83 H	325	35.1	13.6
7	15540.00	45.5 PK	74.0	-28.5	1.67 H	360	32.3	13.2
8	15540.00	33.3 AV	54.0	-20.7	1.67 H	360	20.1	13.2

**ANTENNA POLARITY & TEST DISTANCE: VERTICAL AT 3 M**

NO.	FREQ. (MHz)	EMISSION LEVEL (dBuV/m)	LIMIT (dBuV/m)	MARGIN (dB)	ANTENNA HEIGHT (m)	TABLE ANGLE (Degree)	RAW VALUE (dBuV)	CORRECTION FACTOR (dB/m)
1	5150.00	69.4 PK	74.0	-4.6	1.82 V	281	65.4	4.0
2	5150.00	52.9 AV	54.0	-1.1	1.82 V	281	48.9	4.0
3	*5180.00	109.7 PK			1.82 V	281	105.7	4.0
4	*5180.00	99.7 AV			1.82 V	281	95.7	4.0
5	#10360.00	63.9 PK	74.0	-10.1	1.59 V	360	50.3	13.6
6	#10360.00	48.4 AV	54.0	-5.6	1.59 V	360	34.8	13.6
7	15540.00	45.2 PK	74.0	-28.8	1.87 V	5	32.0	13.2
8	15540.00	32.9 AV	54.0	-21.1	1.87 V	5	19.7	13.2

**REMARKS:**

- Emission Level(dBuV/m) = Raw Value(dBuV) + Correction Factor(dB/m)
- Correction Factor(dB/m) = Antenna Factor(dB/m) + Cable Factor(dB) – Pre-Amplifier Factor(dB)
- The other emission levels were very low against the limit.
- Margin value = Emission Level – Limit value
- " \* ": Fundamental frequency.
- " # ": The radiated frequency is out of the restricted band.

<b>CHANNEL</b>	TX Channel 40	<b>DETECTOR FUNCTION</b>	Peak (PK)
<b>FREQUENCY RANGE</b>	1GHz ~ 40GHz		Average (AV)

**ANTENNA POLARITY & TEST DISTANCE: HORIZONTAL AT 3 M**

NO.	FREQ. (MHz)	EMISSION LEVEL (dBuV/m)	LIMIT (dBuV/m)	MARGIN (dB)	ANTENNA HEIGHT (m)	TABLE ANGLE (Degree)	RAW VALUE (dBuV)	CORRECTION FACTOR (dB/m)
1	5150.00	62.8 PK	74.0	-11.2	1.00 H	291	58.8	4.0
2	5150.00	46.9 AV	54.0	-7.1	1.00 H	291	42.9	4.0
3	*5200.00	113.3 PK			1.00 H	291	109.3	4.0
4	*5200.00	103.0 AV			1.00 H	291	99.0	4.0
5	5350.00	54.2 PK	74.0	-19.8	1.00 H	291	49.8	4.4
6	5350.00	42.6 AV	54.0	-11.4	1.00 H	291	38.2	4.4
7	#10400.00	65.9 PK	74.0	-8.1	1.75 H	309	52.3	13.6
8	#10400.00	50.7 AV	54.0	-3.3	1.75 H	309	37.1	13.6
9	15600.00	47.2 PK	74.0	-26.8	1.75 H	360	33.8	13.4
10	15600.00	34.7 AV	54.0	-19.3	1.75 H	360	21.3	13.4

**ANTENNA POLARITY & TEST DISTANCE: VERTICAL AT 3 M**

NO.	FREQ. (MHz)	EMISSION LEVEL (dBuV/m)	LIMIT (dBuV/m)	MARGIN (dB)	ANTENNA HEIGHT (m)	TABLE ANGLE (Degree)	RAW VALUE (dBuV)	CORRECTION FACTOR (dB/m)
1	5150.00	62.0 PK	74.0	-12.0	1.85 V	277	58.0	4.0
2	5150.00	46.1 AV	54.0	-7.9	1.85 V	277	42.1	4.0
3	*5200.00	112.2 PK			1.85 V	277	108.2	4.0
4	*5200.00	101.8 AV			1.85 V	277	97.8	4.0
5	5350.00	53.4 PK	74.0	-20.6	1.85 V	277	49.0	4.4
6	5350.00	41.8 AV	54.0	-12.2	1.85 V	277	37.4	4.4
7	#10400.00	64.8 PK	74.0	-9.2	1.44 V	356	51.2	13.6
8	#10400.00	49.4 AV	54.0	-4.6	1.44 V	356	35.8	13.6
9	15600.00	47.1 PK	74.0	-26.9	1.86 V	16	33.7	13.4
10	15600.00	35.0 AV	54.0	-19.0	1.86 V	16	21.6	13.4

**REMARKS:**

- Emission Level(dBuV/m) = Raw Value(dBuV) + Correction Factor(dB/m)
- Correction Factor(dB/m) = Antenna Factor(dB/m) + Cable Factor(dB) – Pre-Amplifier Factor(dB)
- The other emission levels were very low against the limit.
- Margin value = Emission Level – Limit value
- " \* ": Fundamental frequency.
- " # ": The radiated frequency is out of the restricted band.

<b>CHANNEL</b>	TX Channel 48	<b>DETECTOR FUNCTION</b>	Peak (PK)
<b>FREQUENCY RANGE</b>	1GHz ~ 40GHz		Average (AV)

**ANTENNA POLARITY & TEST DISTANCE: HORIZONTAL AT 3 M**

NO.	FREQ. (MHz)	EMISSION LEVEL (dBuV/m)	LIMIT (dBuV/m)	MARGIN (dB)	ANTENNA HEIGHT (m)	TABLE ANGLE (Degree)	RAW VALUE (dBuV)	CORRECTION FACTOR (dB/m)
1	5150.00	52.1 PK	74.0	-21.9	1.00 H	291	48.1	4.0
2	5150.00	39.5 AV	54.0	-14.5	1.00 H	291	35.5	4.0
3	*5240.00	111.5 PK			1.00 H	291	107.3	4.2
4	*5240.00	101.7 AV			1.00 H	291	97.5	4.2
5	5393.00	53.8 PK	74.0	-20.2	1.00 H	291	49.4	4.4
6	5393.00	41.5 AV	54.0	-12.5	1.00 H	291	37.1	4.4
7	#10480.00	64.7 PK	74.0	-9.3	1.70 H	316	51.0	13.7
8	#10480.00	49.7 AV	54.0	-4.3	1.70 H	316	36.0	13.7
9	15720.00	46.8 PK	74.0	-27.2	1.77 H	360	32.8	14.0
10	15720.00	34.3 AV	54.0	-19.7	1.77 H	360	20.3	14.0

**ANTENNA POLARITY & TEST DISTANCE: VERTICAL AT 3 M**

NO.	FREQ. (MHz)	EMISSION LEVEL (dBuV/m)	LIMIT (dBuV/m)	MARGIN (dB)	ANTENNA HEIGHT (m)	TABLE ANGLE (Degree)	RAW VALUE (dBuV)	CORRECTION FACTOR (dB/m)
1	5150.00	51.3 PK	74.0	-22.7	1.81 V	275	47.3	4.0
2	5150.00	38.7 AV	54.0	-15.3	1.81 V	275	34.7	4.0
3	*5240.00	110.4 PK			1.81 V	275	106.2	4.2
4	*5240.00	100.5 AV			1.81 V	275	96.3	4.2
5	5393.00	53.0 PK	74.0	-21.0	1.81 V	275	48.6	4.4
6	5393.00	40.7 AV	54.0	-13.3	1.81 V	275	36.3	4.4
7	#10480.00	64.3 PK	74.0	-9.7	1.57 V	345	50.6	13.7
8	#10480.00	49.0 AV	54.0	-5.0	1.57 V	345	35.3	13.7
9	15720.00	46.8 PK	74.0	-27.2	1.94 V	12	32.8	14.0
10	15720.00	34.4 AV	54.0	-19.6	1.94 V	12	20.4	14.0

**REMARKS:**

1. Emission Level(dBuV/m) = Raw Value(dBuV) + Correction Factor(dB/m)
2. Correction Factor(dB/m) = Antenna Factor(dB/m) + Cable Factor(dB) – Pre-Amplifier Factor(dB)
3. The other emission levels were very low against the limit.
4. Margin value = Emission Level – Limit value
5. " \* ": Fundamental frequency.
6. " # ": The radiated frequency is out of the restricted band.

<b>CHANNEL</b>	TX Channel 149	<b>DETECTOR FUNCTION</b>	Peak (PK)
<b>FREQUENCY RANGE</b>	1GHz ~ 40GHz		Average (AV)

**ANTENNA POLARITY & TEST DISTANCE: HORIZONTAL AT 3 M**

NO.	FREQ. (MHz)	EMISSION LEVEL (dBuV/m)	LIMIT (dBuV/m)	MARGIN (dB)	ANTENNA HEIGHT (m)	TABLE ANGLE (Degree)	RAW VALUE (dBuV)	CORRECTION FACTOR (dB/m)
1	*5745.00	112.8 PK			1.00 H	290	107.8	5.0
2	*5745.00	102.9 AV			1.00 H	290	97.9	5.0
3	11490.00	66.4 PK	74.0	-7.6	1.76 H	186	52.3	14.1
4	11490.00	53.6 AV	54.0	-0.4	1.76 H	186	39.5	14.1
5	#17235.00	55.8 PK	74.0	-18.2	1.63 H	80	37.5	18.3
6	#17235.00	42.7 AV	54.0	-11.3	1.63 H	80	24.4	18.3

**ANTENNA POLARITY & TEST DISTANCE: VERTICAL AT 3 M**

NO.	FREQ. (MHz)	EMISSION LEVEL (dBuV/m)	LIMIT (dBuV/m)	MARGIN (dB)	ANTENNA HEIGHT (m)	TABLE ANGLE (Degree)	RAW VALUE (dBuV)	CORRECTION FACTOR (dB/m)
1	*5745.00	111.5 PK			1.49 V	296	106.5	5.0
2	*5745.00	101.2 AV			1.49 V	296	96.2	5.0
3	11490.00	61.6 PK	74.0	-12.4	1.19 V	34	47.5	14.1
4	11490.00	46.6 AV	54.0	-7.4	1.19 V	34	32.5	14.1
5	#17235.00	54.7 PK	74.0	-19.3	1.26 V	23	36.4	18.3
6	#17235.00	41.6 AV	54.0	-12.4	1.26 V	23	23.3	18.3

**REMARKS:**

1. Emission Level(dBuV/m) = Raw Value(dBuV) + Correction Factor(dB/m)
2. Correction Factor(dB/m) = Antenna Factor(dB/m) + Cable Factor(dB) – Pre-Amplifier Factor(dB)
3. The other emission levels were very low against the limit.
4. Margin value = Emission Level – Limit value
5. " \* ": Fundamental frequency.
6. " # ": The radiated frequency is out of the restricted band.

<b>CHANNEL</b>	TX Channel 157	<b>DETECTOR FUNCTION</b>	Peak (PK)
<b>FREQUENCY RANGE</b>	1GHz ~ 40GHz		Average (AV)

**ANTENNA POLARITY & TEST DISTANCE: HORIZONTAL AT 3 M**

NO.	FREQ. (MHz)	EMISSION LEVEL (dBuV/m)	LIMIT (dBuV/m)	MARGIN (dB)	ANTENNA HEIGHT (m)	TABLE ANGLE (Degree)	RAW VALUE (dBuV)	CORRECTION FACTOR (dB/m)
1	*5785.00	112.5 PK			1.00 H	291	107.5	5.0
2	*5785.00	102.4 AV			1.00 H	291	97.4	5.0
3	11570.00	66.8 PK	74.0	-7.2	2.07 H	151	52.8	14.0
<b>4</b>	<b>11570.00</b>	<b>53.9 AV</b>	<b>54.0</b>	<b>-0.1</b>	<b>2.07 H</b>	<b>151</b>	<b>39.9</b>	<b>14.0</b>
5	#17355.00	54.1 PK	74.0	-19.9	1.73 H	92	35.2	18.9
6	#17355.00	41.2 AV	54.0	-12.8	1.73 H	92	22.3	18.9

**ANTENNA POLARITY & TEST DISTANCE: VERTICAL AT 3 M**

NO.	FREQ. (MHz)	EMISSION LEVEL (dBuV/m)	LIMIT (dBuV/m)	MARGIN (dB)	ANTENNA HEIGHT (m)	TABLE ANGLE (Degree)	RAW VALUE (dBuV)	CORRECTION FACTOR (dB/m)
1	*5785.00	111.2 PK			1.49 V	297	106.2	5.0
2	*5785.00	100.8 AV			1.49 V	297	95.8	5.0
3	11570.00	62.4 PK	74.0	-11.6	1.23 V	26	48.4	14.0
4	11570.00	47.0 AV	54.0	-7.0	1.23 V	26	33.0	14.0
5	#17355.00	53.9 PK	74.0	-20.1	1.28 V	37	35.0	18.9
6	#17355.00	41.1 AV	54.0	-12.9	1.28 V	37	22.2	18.9

**REMARKS:**

- Emission Level(dBuV/m) = Raw Value(dBuV) + Correction Factor(dB/m)
- Correction Factor(dB/m) = Antenna Factor(dB/m) + Cable Factor(dB) – Pre-Amplifier Factor(dB)
- The other emission levels were very low against the limit.
- Margin value = Emission Level – Limit value
- " \* ": Fundamental frequency.
- " # ": The radiated frequency is out of the restricted band.

<b>CHANNEL</b>	TX Channel 165	<b>DETECTOR FUNCTION</b>	Peak (PK)
<b>FREQUENCY RANGE</b>	1GHz ~ 40GHz		Average (AV)

**ANTENNA POLARITY & TEST DISTANCE: HORIZONTAL AT 3 M**

NO.	FREQ. (MHz)	EMISSION LEVEL (dBuV/m)	LIMIT (dBuV/m)	MARGIN (dB)	ANTENNA HEIGHT (m)	TABLE ANGLE (Degree)	RAW VALUE (dBuV)	CORRECTION FACTOR (dB/m)
1	*5825.00	113.4 PK			1.00 H	287	108.2	5.2
2	*5825.00	102.8 AV			1.00 H	287	97.6	5.2
3	11650.00	66.7 PK	74.0	-7.3	2.07 H	191	52.6	14.1
4	11650.00	53.8 AV	54.0	-0.2	2.07 H	191	39.7	14.1
5	#17475.00	53.5 PK	74.0	-20.5	1.68 H	92	33.8	19.7
6	#17475.00	41.2 AV	54.0	-12.8	1.68 H	92	21.5	19.7

**ANTENNA POLARITY & TEST DISTANCE: VERTICAL AT 3 M**

NO.	FREQ. (MHz)	EMISSION LEVEL (dBuV/m)	LIMIT (dBuV/m)	MARGIN (dB)	ANTENNA HEIGHT (m)	TABLE ANGLE (Degree)	RAW VALUE (dBuV)	CORRECTION FACTOR (dB/m)
1	*5825.00	111.1 PK			1.48 V	294	105.9	5.2
2	*5825.00	100.5 AV			1.48 V	294	95.3	5.2
3	11650.00	62.3 PK	74.0	-11.7	1.27 V	26	48.2	14.1
4	11650.00	46.8 AV	54.0	-7.2	1.27 V	26	32.7	14.1
5	#17475.00	54.0 PK	74.0	-20.0	1.24 V	47	34.3	19.7
6	#17475.00	41.0 AV	54.0	-13.0	1.24 V	47	21.3	19.7

**REMARKS:**

1. Emission Level(dBuV/m) = Raw Value(dBuV) + Correction Factor(dB/m)
2. Correction Factor(dB/m) = Antenna Factor(dB/m) + Cable Factor(dB) – Pre-Amplifier Factor(dB)
3. The other emission levels were very low against the limit.
4. Margin value = Emission Level – Limit value
5. " \* ": Fundamental frequency.
6. " # ": The radiated frequency is out of the restricted band.

**802.11ac (VHT40)**

<b>CHANNEL</b>	TX Channel 38	<b>DETECTOR FUNCTION</b>	Peak (PK)
<b>FREQUENCY RANGE</b>	1GHz ~ 40GHz		Average (AV)

**ANTENNA POLARITY & TEST DISTANCE: HORIZONTAL AT 3 M**

NO.	FREQ. (MHz)	EMISSION LEVEL (dBuV/m)	LIMIT (dBuV/m)	MARGIN (dB)	ANTENNA HEIGHT (m)	TABLE ANGLE (Degree)	RAW VALUE (dBuV)	CORRECTION FACTOR (dB/m)
1	5150.00	67.2 PK	74.0	-6.8	1.00 H	290	63.2	4.0
2	<b>5150.00</b>	<b>53.9 AV</b>	<b>54.0</b>	<b>-0.1</b>	<b>1.00 H</b>	<b>290</b>	<b>49.9</b>	<b>4.0</b>
3	*5190.00	107.6 PK			1.00 H	290	103.6	4.0
4	*5190.00	97.8 AV			1.00 H	290	93.8	4.0
5	5350.00	53.1 PK	74.0	-20.9	1.00 H	290	48.7	4.4
6	5350.00	41.3 AV	54.0	-12.7	1.00 H	290	36.9	4.4
7	#10380.00	64.0 PK	74.0	-10.0	1.79 H	328	50.4	13.6
8	#10380.00	49.1 AV	54.0	-4.9	1.79 H	328	35.5	13.6
9	15570.00	45.7 PK	74.0	-28.3	1.73 H	360	32.4	13.3
10	15570.00	33.7 AV	54.0	-20.3	1.73 H	360	20.4	13.3

**ANTENNA POLARITY & TEST DISTANCE: VERTICAL AT 3 M**

NO.	FREQ. (MHz)	EMISSION LEVEL (dBuV/m)	LIMIT (dBuV/m)	MARGIN (dB)	ANTENNA HEIGHT (m)	TABLE ANGLE (Degree)	RAW VALUE (dBuV)	CORRECTION FACTOR (dB/m)
1	5150.00	66.4 PK	74.0	-7.6	1.79 V	296	62.4	4.0
2	5150.00	53.1 AV	54.0	-0.9	1.79 V	296	49.1	4.0
3	*5190.00	106.5 PK			1.79 V	296	102.5	4.0
4	*5190.00	96.6 AV			1.79 V	296	92.6	4.0
5	5350.00	52.3 PK	74.0	-21.7	1.79 V	296	47.9	4.4
6	5350.00	40.5 AV	54.0	-13.5	1.79 V	296	36.1	4.4
7	#10380.00	64.2 PK	74.0	-9.8	1.63 V	360	50.6	13.6
8	#10380.00	48.5 AV	54.0	-5.5	1.63 V	360	34.9	13.6
9	15570.00	45.8 PK	74.0	-28.2	1.82 V	3	32.5	13.3
10	15570.00	33.3 AV	54.0	-20.7	1.82 V	3	20.0	13.3

**REMARKS:**

- Emission Level(dBuV/m) = Raw Value(dBuV) + Correction Factor(dB/m)
- Correction Factor(dB/m) = Antenna Factor(dB/m) + Cable Factor(dB) – Pre-Amplifier Factor(dB)
- The other emission levels were very low against the limit.
- Margin value = Emission Level – Limit value
- " \* ": Fundamental frequency.
- " # ": The radiated frequency is out of the restricted band.



<b>CHANNEL</b>	TX Channel 46	<b>DETECTOR FUNCTION</b>	Peak (PK)
<b>FREQUENCY RANGE</b>	1GHz ~ 40GHz		Average (AV)

**ANTENNA POLARITY & TEST DISTANCE: HORIZONTAL AT 3 M**

NO.	FREQ. (MHz)	EMISSION LEVEL (dBuV/m)	LIMIT (dBuV/m)	MARGIN (dB)	ANTENNA HEIGHT (m)	TABLE ANGLE (Degree)	RAW VALUE (dBuV)	CORRECTION FACTOR (dB/m)
1	5150.00	59.4 PK	74.0	-14.6	1.00 H	292	55.4	4.0
2	5150.00	45.8 AV	54.0	-8.2	1.00 H	292	41.8	4.0
3	*5230.00	109.3 PK			1.00 H	292	105.1	4.2
4	*5230.00	99.2 AV			1.00 H	292	95.0	4.2
5	5381.00	55.6 PK	74.0	-18.4	1.00 H	292	51.2	4.4
6	5381.00	42.9 AV	54.0	-11.1	1.00 H	292	38.5	4.4
7	#10460.00	64.9 PK	74.0	-9.1	1.72 H	312	51.2	13.7
8	#10460.00	50.1 AV	54.0	-3.9	1.72 H	312	36.4	13.7
9	15690.00	47.2 PK	74.0	-26.8	1.75 H	353	33.2	14.0
10	15690.00	34.6 AV	54.0	-19.4	1.75 H	353	20.6	14.0

**ANTENNA POLARITY & TEST DISTANCE: VERTICAL AT 3 M**

NO.	FREQ. (MHz)	EMISSION LEVEL (dBuV/m)	LIMIT (dBuV/m)	MARGIN (dB)	ANTENNA HEIGHT (m)	TABLE ANGLE (Degree)	RAW VALUE (dBuV)	CORRECTION FACTOR (dB/m)
1	5150.00	58.6 PK	74.0	-15.4	1.85 V	268	54.6	4.0
2	5150.00	45.0 AV	54.0	-9.0	1.85 V	268	41.0	4.0
3	*5230.00	108.2 PK			1.85 V	268	104.0	4.2
4	*5230.00	98.0 AV			1.85 V	268	93.8	4.2
5	5381.00	54.8 PK	74.0	-19.2	1.85 V	268	50.4	4.4
6	5381.00	42.1 AV	54.0	-11.9	1.85 V	268	37.7	4.4
7	#10460.00	64.3 PK	74.0	-9.7	1.54 V	333	50.6	13.7
8	#10460.00	49.2 AV	54.0	-4.8	1.54 V	333	35.5	13.7
9	15690.00	46.0 PK	74.0	-28.0	1.97 V	27	32.0	14.0
10	15690.00	33.9 AV	54.0	-20.1	1.97 V	27	19.9	14.0

**REMARKS:**

1. Emission Level(dBuV/m) = Raw Value(dBuV) + Correction Factor(dB/m)
2. Correction Factor(dB/m) = Antenna Factor(dB/m) + Cable Factor(dB) – Pre-Amplifier Factor(dB)
3. The other emission levels were very low against the limit.
4. Margin value = Emission Level – Limit value
5. " \* ": Fundamental frequency.
6. " # ": The radiated frequency is out of the restricted band.

<b>CHANNEL</b>	TX Channel 151	<b>DETECTOR FUNCTION</b>	Peak (PK)
<b>FREQUENCY RANGE</b>	1GHz ~ 40GHz		Average (AV)

**ANTENNA POLARITY & TEST DISTANCE: HORIZONTAL AT 3 M**

NO.	FREQ. (MHz)	EMISSION LEVEL (dBuV/m)	LIMIT (dBuV/m)	MARGIN (dB)	ANTENNA HEIGHT (m)	TABLE ANGLE (Degree)	RAW VALUE (dBuV)	CORRECTION FACTOR (dB/m)
1	*5755.00	109.9 PK			1.00 H	290	104.9	5.0
2	*5755.00	100.0 AV			1.00 H	290	95.0	5.0
3	11510.00	66.6 PK	74.0	-7.4	1.76 H	163	52.6	14.0
4	11510.00	53.3 AV	54.0	-0.7	1.76 H	163	39.3	14.0
5	#17265.00	54.2 PK	74.0	-19.8	1.76 H	100	35.7	18.5
6	#17265.00	42.6 AV	54.0	-11.4	1.76 H	100	24.1	18.5

**ANTENNA POLARITY & TEST DISTANCE: VERTICAL AT 3 M**

NO.	FREQ. (MHz)	EMISSION LEVEL (dBuV/m)	LIMIT (dBuV/m)	MARGIN (dB)	ANTENNA HEIGHT (m)	TABLE ANGLE (Degree)	RAW VALUE (dBuV)	CORRECTION FACTOR (dB/m)
1	*5755.00	108.8 PK			1.50 V	296	103.8	5.0
2	*5755.00	98.8 AV			1.50 V	296	93.8	5.0
3	11510.00	62.1 PK	74.0	-11.9	1.23 V	24	48.1	14.0
4	11510.00	46.8 AV	54.0	-7.2	1.23 V	24	32.8	14.0
5	#17265.00	54.5 PK	74.0	-19.5	1.30 V	38	36.0	18.5
6	#17265.00	41.7 AV	54.0	-12.3	1.30 V	38	23.2	18.5

**REMARKS:**

1. Emission Level(dBuV/m) = Raw Value(dBuV) + Correction Factor(dB/m)
2. Correction Factor(dB/m) = Antenna Factor(dB/m) + Cable Factor(dB) – Pre-Amplifier Factor(dB)
3. The other emission levels were very low against the limit.
4. Margin value = Emission Level – Limit value
5. " \* ": Fundamental frequency.
6. " # ": The radiated frequency is out of the restricted band.

<b>CHANNEL</b>	TX Channel 159	<b>DETECTOR FUNCTION</b>	Peak (PK)
<b>FREQUENCY RANGE</b>	1GHz ~ 40GHz		Average (AV)

**ANTENNA POLARITY & TEST DISTANCE: HORIZONTAL AT 3 M**

NO.	FREQ. (MHz)	EMISSION LEVEL (dBuV/m)	LIMIT (dBuV/m)	MARGIN (dB)	ANTENNA HEIGHT (m)	TABLE ANGLE (Degree)	RAW VALUE (dBuV)	CORRECTION FACTOR (dB/m)
1	*5795.00	108.8 PK			1.00 H	289	103.7	5.1
2	*5795.00	98.6 AV			1.00 H	289	93.5	5.1
3	11590.00	62.8 PK	74.0	-11.2	1.76 H	174	48.8	14.0
4	11590.00	50.2 AV	54.0	-3.8	1.76 H	174	36.2	14.0
5	#17385.00	54.3 PK	74.0	-19.7	1.73 H	99	35.2	19.1
6	#17385.00	42.5 AV	54.0	-11.5	1.73 H	99	23.4	19.1

**ANTENNA POLARITY & TEST DISTANCE: VERTICAL AT 3 M**

NO.	FREQ. (MHz)	EMISSION LEVEL (dBuV/m)	LIMIT (dBuV/m)	MARGIN (dB)	ANTENNA HEIGHT (m)	TABLE ANGLE (Degree)	RAW VALUE (dBuV)	CORRECTION FACTOR (dB/m)
1	*5795.00	106.7 PK			1.50 V	293	101.6	5.1
2	*5795.00	96.7 AV			1.50 V	293	91.6	5.1
3	11590.00	62.0 PK	74.0	-12.0	1.22 V	26	48.0	14.0
4	11590.00	46.5 AV	54.0	-7.5	1.22 V	26	32.5	14.0
5	#17385.00	54.0 PK	74.0	-20.0	1.21 V	22	34.9	19.1
6	#17385.00	41.2 AV	54.0	-12.8	1.21 V	22	22.1	19.1

**REMARKS:**

1. Emission Level(dBuV/m) = Raw Value(dBuV) + Correction Factor(dB/m)
2. Correction Factor(dB/m) = Antenna Factor(dB/m) + Cable Factor(dB) – Pre-Amplifier Factor(dB)
3. The other emission levels were very low against the limit.
4. Margin value = Emission Level – Limit value
5. " \* ": Fundamental frequency.
6. " # ": The radiated frequency is out of the restricted band.

**802.11ac (VHT80)**

<b>CHANNEL</b>	TX Channel 42	<b>DETECTOR FUNCTION</b>	Peak (PK)
<b>FREQUENCY RANGE</b>	1GHz ~ 40GHz		Average (AV)

**ANTENNA POLARITY & TEST DISTANCE: HORIZONTAL AT 3 M**

NO.	FREQ. (MHz)	EMISSION LEVEL (dBuV/m)	LIMIT (dBuV/m)	MARGIN (dB)	ANTENNA HEIGHT (m)	TABLE ANGLE (Degree)	RAW VALUE (dBuV)	CORRECTION FACTOR (dB/m)
1	5150.00	66.8 PK	74.0	-7.2	1.00 H	291	62.8	4.0
2	5150.00	53.6 AV	54.0	-0.4	1.00 H	291	49.6	4.0
3	*5210.00	97.7 PK			1.00 H	291	93.6	4.1
4	*5210.00	87.7 AV			1.00 H	291	83.6	4.1
5	5350.00	54.1 PK	74.0	-19.9	1.00 H	291	49.7	4.4
6	5350.00	42.6 AV	54.0	-11.4	1.00 H	291	38.2	4.4
7	#10420.00	64.1 PK	74.0	-9.9	1.87 H	335	50.5	13.6
8	#10420.00	49.1 AV	54.0	-4.9	1.87 H	335	35.5	13.6
9	15630.00	45.5 PK	74.0	-28.5	1.62 H	360	31.9	13.6
10	15630.00	33.2 AV	54.0	-20.8	1.62 H	360	19.6	13.6

**ANTENNA POLARITY & TEST DISTANCE: VERTICAL AT 3 M**

NO.	FREQ. (MHz)	EMISSION LEVEL (dBuV/m)	LIMIT (dBuV/m)	MARGIN (dB)	ANTENNA HEIGHT (m)	TABLE ANGLE (Degree)	RAW VALUE (dBuV)	CORRECTION FACTOR (dB/m)
1	5150.00	66.0 PK	74.0	-8.0	1.90 V	277	62.0	4.0
2	5150.00	52.8 AV	54.0	-1.2	1.90 V	277	48.8	4.0
3	*5210.00	96.6 PK			1.90 V	277	92.5	4.1
4	*5210.00	86.4 AV			1.90 V	277	82.3	4.1
5	5350.00	53.3 PK	74.0	-20.7	1.90 V	277	48.9	4.4
6	5350.00	41.8 AV	54.0	-12.2	1.90 V	277	37.4	4.4
7	#10420.00	64.2 PK	74.0	-9.8	1.53 V	360	50.6	13.6
8	#10420.00	48.4 AV	54.0	-5.6	1.53 V	360	34.8	13.6
9	15630.00	45.3 PK	74.0	-28.7	1.87 V	16	31.7	13.6
10	15630.00	32.7 AV	54.0	-21.3	1.87 V	16	19.1	13.6

**REMARKS:**

- Emission Level(dBuV/m) = Raw Value(dBuV) + Correction Factor(dB/m)
- Correction Factor(dB/m) = Antenna Factor(dB/m) + Cable Factor(dB) – Pre-Amplifier Factor(dB)
- The other emission levels were very low against the limit.
- Margin value = Emission Level – Limit value
- " \* ": Fundamental frequency.
- " # ": The radiated frequency is out of the restricted band.

<b>CHANNEL</b>	TX Channel 155	<b>DETECTOR FUNCTION</b>	Peak (PK)
<b>FREQUENCY RANGE</b>	1GHz ~ 40GHz		Average (AV)

**ANTENNA POLARITY & TEST DISTANCE: HORIZONTAL AT 3 M**

NO.	FREQ. (MHz)	EMISSION LEVEL (dBuV/m)	LIMIT (dBuV/m)	MARGIN (dB)	ANTENNA HEIGHT (m)	TABLE ANGLE (Degree)	RAW VALUE (dBuV)	CORRECTION FACTOR (dB/m)
1	*5775.00	106.6 PK			1.00 H	293	101.6	5.0
2	*5775.00	96.2 AV			1.00 H	293	91.2	5.0
3	11550.00	62.6 PK	74.0	-11.4	1.75 H	166	48.6	14.0
4	11550.00	50.3 AV	54.0	-3.7	1.75 H	166	36.3	14.0
5	#17325.00	54.2 PK	74.0	-19.8	1.68 H	115	35.6	18.6
6	#17325.00	42.7 AV	54.0	-11.3	1.68 H	115	24.1	18.6

**ANTENNA POLARITY & TEST DISTANCE: VERTICAL AT 3 M**

NO.	FREQ. (MHz)	EMISSION LEVEL (dBuV/m)	LIMIT (dBuV/m)	MARGIN (dB)	ANTENNA HEIGHT (m)	TABLE ANGLE (Degree)	RAW VALUE (dBuV)	CORRECTION FACTOR (dB/m)
1	*5775.00	104.4 PK			1.50 V	298	99.4	5.0
2	*5775.00	94.1 AV			1.50 V	298	89.1	5.0
3	11550.00	62.2 PK	74.0	-11.8	1.21 V	36	48.2	14.0
4	11550.00	46.8 AV	54.0	-7.2	1.21 V	36	32.8	14.0
5	#17325.00	53.9 PK	74.0	-20.1	1.23 V	51	35.3	18.6
6	#17325.00	40.9 AV	54.0	-13.1	1.23 V	51	22.3	18.6

**REMARKS:**

1. Emission Level(dBuV/m) = Raw Value(dBuV) + Correction Factor(dB/m)
2. Correction Factor(dB/m) = Antenna Factor(dB/m) + Cable Factor(dB) – Pre-Amplifier Factor(dB)
3. The other emission levels were very low against the limit.
4. Margin value = Emission Level – Limit value
5. " \* ": Fundamental frequency.
6. " # ": The radiated frequency is out of the restricted band.

**Below 1GHz Data:**

**802.11ac (VHT40)**

<b>CHANNEL</b>	TX Channel 151	<b>DETECTOR FUNCTION</b>	Quasi-Peak (QP)
<b>FREQUENCY RANGE</b>	9kHz ~ 1GHz		

**ANTENNA POLARITY & TEST DISTANCE: HORIZONTAL AT 3 M**

NO.	FREQ. (MHz)	EMISSION LEVEL (dBuV/m)	LIMIT (dBuV/m)	MARGIN (dB)	ANTENNA HEIGHT (m)	TABLE ANGLE (Degree)	RAW VALUE (dBuV)	CORRECTION FACTOR (dB/m)
1	31.75	35.3 QP	40.0	-4.7	1.00 H	213	44.7	-9.4
2	85.39	35.5 QP	40.0	-4.5	2.00 H	84	49.2	-13.7
3	98.63	38.0 QP	43.5	-5.5	2.00 H	84	50.9	-12.9
4	137.06	30.4 QP	43.5	-13.1	2.00 H	270	38.8	-8.4
5	360.02	37.4 QP	46.0	-8.6	1.00 H	315	43.5	-6.1
6	625.00	39.5 QP	46.0	-6.5	2.00 H	360	39.6	-0.1

**ANTENNA POLARITY & TEST DISTANCE: VERTICAL AT 3 M**

NO.	FREQ. (MHz)	EMISSION LEVEL (dBuV/m)	LIMIT (dBuV/m)	MARGIN (dB)	ANTENNA HEIGHT (m)	TABLE ANGLE (Degree)	RAW VALUE (dBuV)	CORRECTION FACTOR (dB/m)
1	64.94	36.1 QP	40.0	-3.9	1.00 V	4	45.1	-9.0
2	137.06	33.0 QP	43.5	-10.5	1.00 V	360	41.4	-8.4
3	195.75	29.9 QP	43.5	-13.6	1.00 V	352	41.3	-11.4
4	359.99	34.3 QP	46.0	-11.7	1.00 V	7	40.5	-6.2
5	440.02	31.9 QP	46.0	-14.1	1.00 V	3	35.7	-3.8
6	625.02	31.9 QP	46.0	-14.1	1.00 V	36	32.0	-0.1

**REMARKS:**

1. Emission Level(dBuV/m) = Raw Value(dBuV) + Correction Factor(dB/m)
2. Correction Factor(dB/m) = Antenna Factor(dB/m) + Cable Factor(dB) – Pre-Amplifier Factor(dB)
3. The other emission levels were very low against the limit.
4. Margin value = Emission Level – Limit value

## 4.2 Conducted Emission Measurement

### 4.2.1 Limits of Conducted Emission Measurement

Frequency (MHz)	Conducted Limit (dBuV)	
	Quasi-peak	Average
0.15 - 0.5	66 - 56	56 - 46
0.50 - 5.0	56	46
5.0 - 30.0	60	50

Note: 1. The lower limit shall apply at the transition frequencies.

2. The limit decreases in line with the logarithm of the frequency in the range of 0.15 to 0.50MHz.

### 4.2.2 Test Instruments

DESCRIPTION & MANUFACTURER	MODEL NO.	SERIAL NO.	CALIBRATED DATE	CALIBRATED UNTIL
Test Receiver R&S	ESCS 30	100375	May. 09, 2017	May. 08, 2018
Line-Impedance Stabilization Network (for EUT) R&S	NSLK-8127	8127-522	Aug. 31, 2017	Aug. 30, 2018
Line-Impedance Stabilization Network (for Peripheral) R&S	ENV216	100072	June 03, 2017	June 02, 2018
50 ohms Terminator	N/A	EMC-02	Sep. 22, 2017	Sep. 21, 2018
RF Cable	5D-FB	COCCAB-001	Sep. 29, 2017	Sep. 28, 2018
10 dB PAD Mini-Circuits	HAT-10+	CONATT-004	June 18, 2017	June 17, 2018
Software BVADT	BVADT_Cond_ V7.3.7.4	NA	NA	NA

**Note:**

1. The calibration interval of the above test instruments are 12 months and the calibrations are traceable to NML/ROC and NIST/USA.
2. The test was performed in Shielded Room No. 1.
- 3 Tested Date: Nov. 09, 2017

#### 4.2.3 Test Procedure

- The EUT was placed 0.4 meters from the conducting wall of the shielded room with EUT being connected to the power mains through a line impedance stabilization network (LISN). Other support units were connected to the power mains through another LISN. The two LISNs provide 50 ohm/ 50uH of coupling impedance for the measuring instrument.
- Both lines of the power mains connected to the EUT were checked for maximum conducted interference.
- The frequency range from 150kHz to 30MHz was searched. Emission levels under (Limit - 20dB) was not recorded.

**NOTE:** All modes of operation were investigated and the worst-case emissions are reported.

#### 4.2.4 Deviation from Test Standard

No deviation.

#### 4.2.5 Test Setup

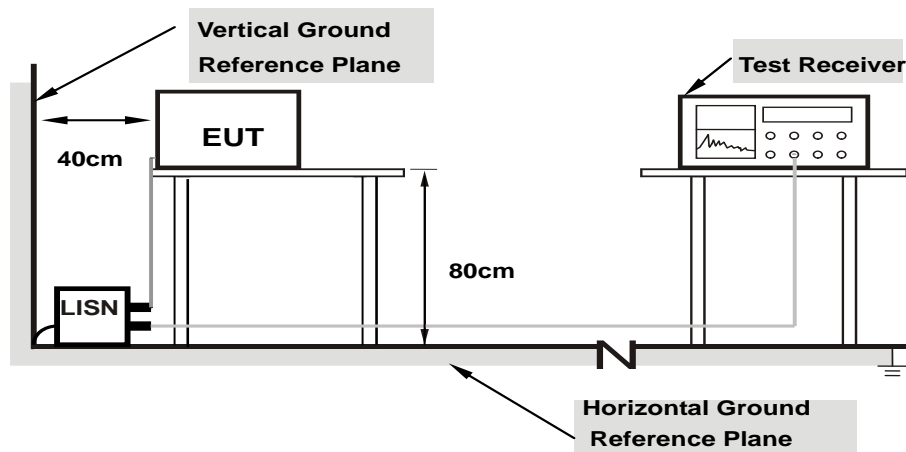

**Note: 1.Support units were connected to second LISN.**

For the actual test configuration, please refer to the attached file (Test Setup Photo).

#### 4.2.6 EUT Operating Condition

Same as 4.1.6.



#### 4.2.7 Test Results (Mode 1)

Phase	Line (L)	Detector Function	Quasi-Peak (QP) / Average (AV)
-------	----------	-------------------	--------------------------------

No	Freq.	Corr.	Reading Value		Emission Level		Limit		Margin	
	[MHz]	Factor	[dB (uV)]		[dB (uV)]		[dB (uV)]		(dB)	
		(dB)	Q.P.	AV.	Q.P.	AV.	Q.P.	AV.	Q.P.	AV.
1	0.15000	9.67	44.51	28.23	54.18	37.90	66.00	56.00	-11.82	-18.10
2	0.16953	9.70	41.81	25.42	51.51	35.12	64.98	54.98	-13.47	-19.86
3	0.51719	9.73	27.09	20.42	36.82	30.15	56.00	46.00	-19.18	-15.85
4	10.63281	9.88	23.57	18.17	33.45	28.05	60.00	50.00	-26.55	-21.95
5	19.27734	9.93	16.26	10.52	26.19	20.45	60.00	50.00	-33.81	-29.55
6	29.06641	10.05	21.39	3.12	31.44	13.17	60.00	50.00	-28.56	-36.83

#### REMARKS:

1. Q.P. and AV. are abbreviations of quasi-peak and average individually.
2. The emission levels of other frequencies were very low against the limit.
3. Margin value = Emission level - Limit value
4. Correction factor = Insertion loss + Cable loss
5. Emission Level = Correction Factor + Reading Value.

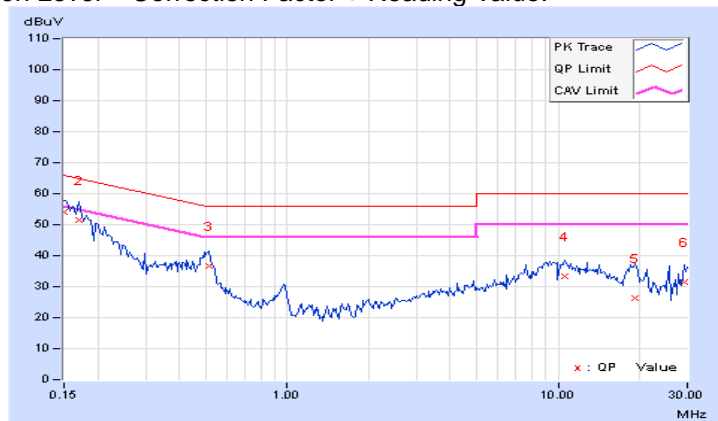

Phase	Neutral (N)	Detector Function	Quasi-Peak (QP) / Average (AV)
-------	-------------	-------------------	--------------------------------

No	Freq.	Corr.	Reading Value		Emission Level		Limit		Margin	
	[MHz]	Factor	[dB (uV)]		[dB (uV)]		[dB (uV)]		(dB)	
		(dB)	Q.P.	AV.	Q.P.	AV.	Q.P.	AV.	Q.P.	AV.
<b>1</b>	<b>0.15000</b>	<b>9.70</b>	<b>44.63</b>	<b>28.19</b>	<b>54.33</b>	<b>37.89</b>	<b>66.00</b>	<b>56.00</b>	<b>-11.67</b>	<b>-18.11</b>
2	0.16953	9.72	42.12	25.91	51.84	35.63	64.98	54.98	-13.14	-19.35
3	0.50938	9.71	28.37	21.72	38.08	31.43	56.00	46.00	-17.92	-14.57
4	0.99375	9.75	14.97	8.26	24.72	18.01	56.00	46.00	-31.28	-27.99
5	9.14453	9.93	24.17	18.22	34.10	28.15	60.00	50.00	-25.90	-21.85
6	20.76563	10.22	18.91	15.60	29.13	25.82	60.00	50.00	-30.87	-24.18

**REMARKS:**

1. Q.P. and AV. are abbreviations of quasi-peak and average individually.
2. The emission levels of other frequencies were very low against the limit.
3. Margin value = Emission level - Limit value
4. Correction factor = Insertion loss + Cable loss
5. Emission Level = Correction Factor + Reading Value.

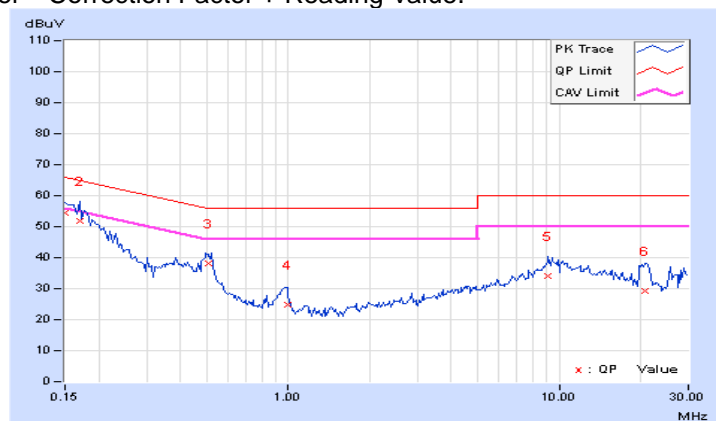

#### 4.2.8 Test Results (Mode 2)

Phase	Line (L)	Detector Function	Quasi-Peak (QP) / Average (AV)
-------	----------	-------------------	--------------------------------

No	Freq. [MHz]	Corr. Factor	Reading Value [dB (uV)]		Emission Level [dB (uV)]		Limit [dB (uV)]		Margin (dB)	
		(dB)	Q.P.	AV.	Q.P.	AV.	Q.P.	AV.	Q.P.	AV.
	1	0.15000	9.67	44.47	27.58	54.14	37.25	66.00	56.00	-11.86
2	0.16953	9.70	41.27	25.28	50.97	34.98	64.98	54.98	-14.01	-20.00
3	0.48203	9.74	25.69	19.04	35.43	28.78	56.30	46.30	-20.87	-17.52
4	0.98203	9.71	15.21	8.34	24.92	18.05	56.00	46.00	-31.08	-27.95
5	9.83594	9.88	24.78	18.97	34.66	28.85	60.00	50.00	-25.34	-21.15
6	29.83984	10.07	14.71	4.21	24.78	14.28	60.00	50.00	-35.22	-35.72

#### REMARKS:

1. Q.P. and AV. are abbreviations of quasi-peak and average individually.
2. The emission levels of other frequencies were very low against the limit.
3. Margin value = Emission level - Limit value
4. Correction factor = Insertion loss + Cable loss
5. Emission Level = Correction Factor + Reading Value.

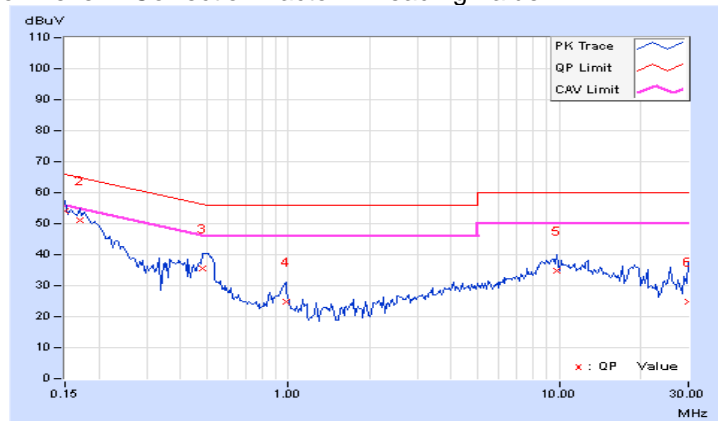

Phase	Neutral (N)	Detector Function	Quasi-Peak (QP) / Average (AV)
-------	-------------	-------------------	--------------------------------

No	Freq. [MHz]	Corr. Factor	Reading Value [dB (uV)]		Emission Level [dB (uV)]		Limit [dB (uV)]		Margin (dB)	
		(dB)	Q.P.	AV.	Q.P.	AV.	Q.P.	AV.	Q.P.	AV.
	1	0.15781	9.71	43.03	26.42	52.74	36.13	65.58	55.58	-12.84
2	0.16953	9.72	41.57	25.38	51.29	35.10	64.98	54.98	-13.69	-19.88
3	0.51328	9.71	27.88	21.25	37.59	30.96	56.00	46.00	-18.41	-15.04
4	9.48047	9.94	24.24	18.80	34.18	28.74	60.00	50.00	-25.82	-21.26
5	19.99609	10.21	21.54	10.66	31.75	20.87	60.00	50.00	-28.25	-29.13
6	29.89063	10.36	15.14	10.63	25.50	20.99	60.00	50.00	-34.50	-29.01

**REMARKS:**

1. Q.P. and AV. are abbreviations of quasi-peak and average individually.
2. The emission levels of other frequencies were very low against the limit.
3. Margin value = Emission level - Limit value
4. Correction factor = Insertion loss + Cable loss
5. Emission Level = Correction Factor + Reading Value.

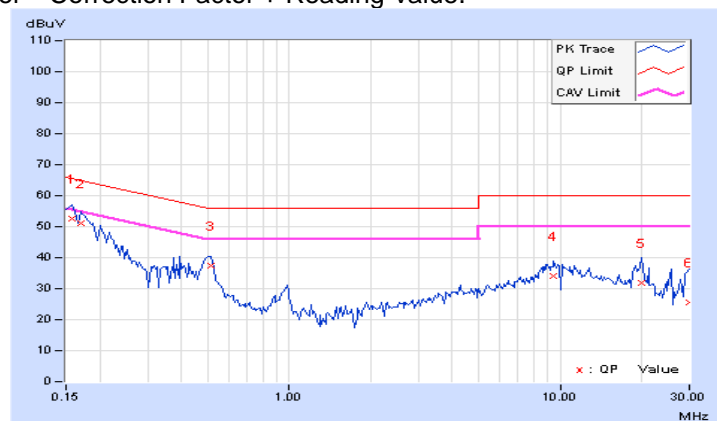

### 4.3 Transmit Power Measurement

#### 4.3.1 Limits of Transmit Power Measurement

Operation Band	EUT Category		Limit
U-NII-1		Outdoor Access Point	1 Watt (30 dBm) (Max. e.i.r.p $\leq$ 125mW(21 dBm) at any elevation angle above 30 degrees as measured from the horizon)
		Fixed point-to-point Access Point	1 Watt (30 dBm)
	√	Indoor Access Point	1 Watt (30 dBm)
		Client device	250mW (24 dBm)
U-NII-2A	---		250mW (24 dBm) or 11 dBm+10 log B*
U-NII-2C	---		250mW (24 dBm) or 11 dBm+10 log B*
U-NII-3	√		1 Watt (30 dBm)

\*B is the 26 dB emission bandwidth in megahertz

Per KDB 662911 Method of conducted output power measurement on IEEE 802.11 devices,

Array Gain = 0 dB (i.e., no array gain) for  $N_{ANT} \leq 4$ ;

Array Gain = 0 dB (i.e., no array gain) for channel widths  $\geq 40$  MHz for any  $N_{ANT}$ ;

Array Gain =  $5 \log(N_{ANT}/N_{SS})$  dB or 3 dB, whichever is less for 20-MHz channel widths with  $N_{ANT} \geq 5$ .

For power measurements on all other devices: Array Gain =  $10 \log(N_{ANT}/N_{SS})$  dB.

#### 4.3.2 Test Setup

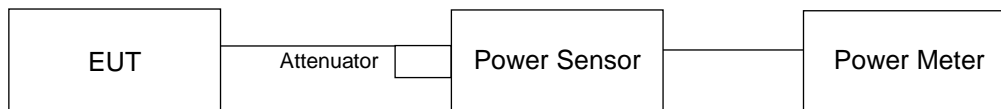

#### 4.3.3 Test Instruments

Refer to section 4.1.2 to get information of above instrument.

#### 4.3.4 Test Procedure

Method PM is used to perform output power measurement, trigger and gating function of wide band power meter is enabled to measure max output power of TX on burst. Duty factor is not added to measured value.

#### 4.3.5 Deviation from Test Standard

No deviation.

#### 4.3.6 EUT Operating Condition

The software provided by client to enable the EUT under transmission condition continuously at lowest, middle and highest channel frequencies individually.

#### 4.3.7 Test Result (Mode 1)

##### CDD Mode

##### Power Output:

##### 802.11a

Chan.	Chan. Freq. (MHz)	Average Power (dBm)		Total Power (mW)	Total Power (dBm)	Limit (dBm)	Pass / Fail
		Chain 0	Chain 1				
36	5180	19.42	19.40	174.594	22.42	28.63	Pass
40	5200	22.71	22.56	366.94	25.65	28.63	Pass
48	5240	21.87	21.83	306.22	24.86	28.63	Pass
149	5745	23.87	22.17	408.597	26.11	29.11	Pass
157	5785	23.95	22.25	416.193	26.19	29.11	Pass
165	5825	23.51	22.38	397.37	25.99	29.11	Pass

- Note:** 1. For U-NII-1: Max. gain = 7.37dBi > 6dBi, so the power limit shall be reduced to  $30-(7.37-6) = 28.63\text{dBm}$ .
2. For U-NII-3: Max. gain = 6.89dBi > 6dBi, so the power limit shall be reduced to  $30-(6.89-6) = 29.11\text{dBm}$ .

##### 802.11ac (VHT20)

Chan.	Chan. Freq. (MHz)	Average Power (dBm)		Total Power (mW)	Total Power (dBm)	Limit (dBm)	Pass / Fail
		Chain 0	Chain 1				
36	5180	18.89	19.04	157.614	21.98	28.63	Pass
40	5200	22.77	22.54	368.707	25.67	28.63	Pass
48	5240	21.86	21.88	307.632	24.88	28.63	Pass
149	5745	23.67	22.03	392.397	25.94	29.11	Pass
157	5785	23.75	22.17	401.953	26.04	29.11	Pass
165	5825	23.46	22.34	393.216	25.95	29.11	Pass

- Note:** 1. For U-NII-1: Max. gain = 7.37dBi > 6dBi, so the power limit shall be reduced to  $30-(7.37-6) = 28.63\text{dBm}$ .
2. For U-NII-3: Max. gain = 6.89dBi > 6dBi, so the power limit shall be reduced to  $30-(6.89-6) = 29.11\text{dBm}$ .

### 802.11ac (VHT40)

Chan.	Chan. Freq. (MHz)	Average Power (dBm)		Total Power (mW)	Total Power (dBm)	Limit (dBm)	Pass / Fail
		Chain 0	Chain 1				
38	5190	16.73	16.84	95.404	19.80	28.63	Pass
46	5230	20.86	20.46	233.072	23.67	28.63	Pass
151	5755	23.66	22.43	407.259	26.10	29.11	Pass
159	5795	23.83	22.62	424.356	26.28	29.11	Pass

- Note:** 1. For U-NII-1: Max. gain = 7.37dBi > 6dBi, so the power limit shall be reduced to  $30-(7.37-6) = 28.63\text{dBm}$ .
2. For U-NII-3: Max. gain = 6.89dBi > 6dBi, so the power limit shall be reduced to  $30-(6.89-6) = 29.11\text{dBm}$ .

### 802.11ac (VHT80)

Chan.	Chan. Freq. (MHz)	Average Power (dBm)		Total Power (mW)	Total Power (dBm)	Limit (dBm)	Pass / Fail
		Chain 0	Chain 1				
42	5210	15.68	15.52	72.628	18.61	28.63	Pass
155	5775	21.11	20.54	242.362	23.84	29.11	Pass

- Note:** 1. For U-NII-1: Max. gain = 7.37dBi > 6dBi, so the power limit shall be reduced to  $30-(7.37-6) = 28.63\text{dBm}$ .
2. For U-NII-3: Max. gain = 6.89dBi > 6dBi, so the power limit shall be reduced to  $30-(6.89-6) = 29.11\text{dBm}$ .

### Beamforming Mode

#### Power Output:

#### 802.11ac (VHT20)

Chan.	Chan. Freq. (MHz)	Average Power (dBm)		Total Power (mW)	Total Power (dBm)	Limit (dBm)	Pass / Fail
		Chain 0	Chain 1				
36	5180	18.89	19.04	157.614	21.98	26.81	Pass
40	5200	22.77	22.54	368.707	25.67	26.81	Pass
48	5240	21.86	21.88	307.632	24.88	26.81	Pass
149	5745	23.67	22.03	392.397	25.94	26.20	Pass
157	5785	23.75	22.17	401.953	26.04	26.20	Pass
165	5825	23.46	22.34	393.216	25.95	26.20	Pass

- Note:** 1. For U-NII-1: Directional gain =  $10 \log[(10^{G0/20} + 10^{G1/20})^2 / 2] = 9.19\text{dBi} > 6\text{dBi}$ , so the power limit shall be reduced to  $30 - (9.19 - 6) = 26.81\text{dBm}$ .
2. For U-NII-3: Directional gain =  $10 \log[(10^{G0/20} + 10^{G1/20})^2 / 2] = 9.8\text{dBi} > 6\text{dBi}$ , so the power limit shall be reduced to  $30 - (9.8 - 6) = 26.20\text{dBm}$ .

#### 802.11ac (VHT40)

Chan.	Chan. Freq. (MHz)	Average Power (dBm)		Total Power (mW)	Total Power (dBm)	Limit (dBm)	Pass / Fail
		Chain 0	Chain 1				
38	5190	16.73	16.84	95.404	19.80	26.81	Pass
46	5230	20.86	20.46	233.072	23.67	26.81	Pass
151	5755	23.66	22.43	407.259	26.10	26.20	Pass
159	5795	23.32	22.24	382.277	25.82	26.20	Pass

- Note:** 1. For U-NII-1: Directional gain =  $10 \log[(10^{G0/20} + 10^{G1/20})^2 / 2] = 9.19\text{dBi} > 6\text{dBi}$ , so the power limit shall be reduced to  $30 - (9.19 - 6) = 26.81\text{dBm}$ .
2. For U-NII-3: Directional gain =  $10 \log[(10^{G0/20} + 10^{G1/20})^2 / 2] = 9.8\text{dBi} > 6\text{dBi}$ , so the power limit shall be reduced to  $30 - (9.8 - 6) = 26.20\text{dBm}$ .

#### 802.11ac (VHT80)

Chan.	Chan. Freq. (MHz)	Average Power (dBm)		Total Power (mW)	Total Power (dBm)	Limit (dBm)	Pass / Fail
		Chain 0	Chain 1				
42	5210	15.68	15.52	72.628	18.61	26.81	Pass
155	5775	21.11	20.54	242.362	23.84	26.20	Pass

- Note:** 1. For U-NII-1: Directional gain =  $10 \log[(10^{G0/20} + 10^{G1/20})^2 / 2] = 9.19\text{dBi} > 6\text{dBi}$ , so the power limit shall be reduced to  $30 - (9.19 - 6) = 26.81\text{dBm}$ .
2. For U-NII-3: Directional gain =  $10 \log[(10^{G0/20} + 10^{G1/20})^2 / 2] = 9.8\text{dBi} > 6\text{dBi}$ , so the power limit shall be reduced to  $30 - (9.8 - 6) = 26.20\text{dBm}$ .



#### 4.3.8 Test Result (Mode 2)

##### 802.11a

Channel	Channel Frequency (MHz)	Maximum Conducted Power (mW)	Maximum Conducted Power (dBm)	Power Limit (dBm)	Pass/Fail
36	5180	46.666	16.69	29.42	Pass
40	5200	75.858	18.80	29.42	Pass
48	5240	46.026	16.63	29.42	Pass
149	5745	83.368	19.21	28.99	Pass
157	5785	79.799	19.02	28.99	Pass
165	5825	74.817	18.74	28.99	Pass

- Note:** 1. For U-NII-1: Max. gain = 6.58dBi > 6dBi, so the power limit shall be reduced to  $30-(6.58-6) = 29.42\text{dBm}$ .  
 2. For U-NII-3: Max. gain = 7.01dBi > 6dBi, so the power limit shall be reduced to  $30-(7.01-6) = 28.99\text{dBm}$ .

##### 802.11ac (VHT20)

Channel	Channel Frequency (MHz)	Maximum Conducted Power (mW)	Maximum Conducted Power (dBm)	Power Limit (dBm)	Pass/Fail
36	5180	45.394	16.57	29.42	Pass
40	5200	75.336	18.77	29.42	Pass
48	5240	45.29	16.56	29.42	Pass
149	5745	81.47	19.11	28.99	Pass
157	5785	79.983	19.03	28.99	Pass
165	5825	74.473	18.72	28.99	Pass

- Note:** 1. For U-NII-1: Max. gain = 6.58dBi > 6dBi, so the power limit shall be reduced to  $30-(6.58-6) = 29.42\text{dBm}$ .  
 2. For U-NII-3: Max. gain = 7.01dBi > 6dBi, so the power limit shall be reduced to  $30-(7.01-6) = 28.99\text{dBm}$ .

##### 802.11ac (VHT40)

Channel	Channel Frequency (MHz)	Maximum Conducted Power (mW)	Maximum Conducted Power (dBm)	Power Limit (dBm)	Pass/Fail
38	5190	15.311	11.85	29.42	Pass
46	5230	47.973	16.81	29.42	Pass
151	5755	92.045	19.64	28.99	Pass
159	5795	82.794	19.18	28.99	Pass

- Note:** 1. For U-NII-1: Max. gain = 6.58dBi > 6dBi, so the power limit shall be reduced to  $30-(6.58-6) = 29.42\text{dBm}$ .  
 2. For U-NII-3: Max. gain = 7.01dBi > 6dBi, so the power limit shall be reduced to  $30-(7.01-6) = 28.99\text{dBm}$ .

**802.11ac (VHT80)**

Channel	Channel Frequency (MHz)	Maximum Conducted Power (mW)	Maximum Conducted Power (dBm)	Power Limit (dBm)	Pass/Fail
42	5210	5.834	7.66	29.42	Pass
155	5775	57.943	17.63	28.99	Pass

**Note:** 1. For U-NII-1: Max. gain = 6.58dBi > 6dBi, so the power limit shall be reduced to  $30-(6.58-6) = 29.42\text{dBm}$ .  
 2. For U-NII-3: Max. gain = 7.01dBi > 6dBi, so the power limit shall be reduced to  $30-(7.01-6) = 28.99\text{dBm}$ .

## 4.4 Occupied Bandwidth Measurement

### 4.4.1 Test Setup



### 4.4.2 Test Instruments

Refer to section 4.1.2 to get information of above instrument.

### 4.4.3 Test Procedure

The transmitter output was connected to the spectrum analyzer through an attenuator. The bandwidth of the fundamental frequency was measured by spectrum analyzer with resolution bandwidth in the range of 1% to 5% of the anticipated emission bandwidth, and a video bandwidth at least 3x the resolution bandwidth and set the detector to SAMPLE. The width of a frequency band such that, below the lower and above the upper frequency limits, the mean powers emitted are each equal to a specified percentage 0.5 %of the total mean power of a given emission.

## 4.4.4 Test Results (Mode 1)

## 802.11a

Channel	Channel Frequency (MHz)	Occupied Bandwidth (MHz)	
		CHAIN 0	CHAIN 1
36	5180	16.92	16.92
40	5200	21.36	22.92
48	5240	19.32	17.76
149	5745	25.20	30.36
157	5785	24.72	31.20
165	5825	24.12	30.36

## 802.11ac (VHT20)

Channel	Channel Frequency (MHz)	Occupied Bandwidth (MHz)	
		CHAIN 0	CHAIN 1
36	5180	18.12	18.00
40	5200	22.92	25.32
48	5240	18.96	18.48
149	5745	26.88	32.40
157	5785	27.48	30.84
165	5825	26.28	30.60

## 802.11ac (VHT40)

Channel	Channel Frequency (MHz)	Occupied Bandwidth (MHz)	
		CHAIN 0	CHAIN 1
38	5190	36.72	36.72
46	5230	37.44	37.44
151	5755	60.00	43.92
159	5795	58.56	69.12

## 802.11ac (VHT80)

Channel	Channel Frequency (MHz)	Occupied Bandwidth (MHz)	
		CHAIN 0	CHAIN 1
42	5210	76.32	76.32
155	5775	77.28	77.28

### Spectrum Plot of Worst Value

**802.11a\_Chain 1 / CH157**

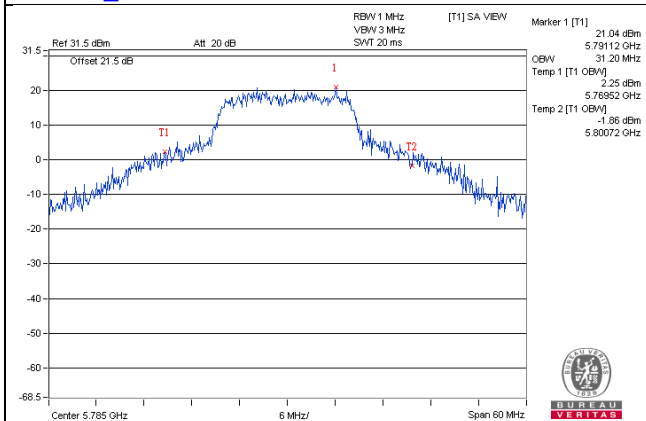

**802.11ac (VHT20)\_Chain 1 / CH149**

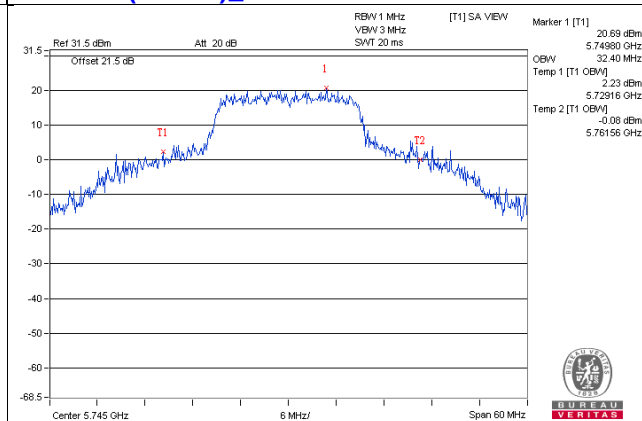

**802.11ac (VHT40)\_Chain 1 / CH159**

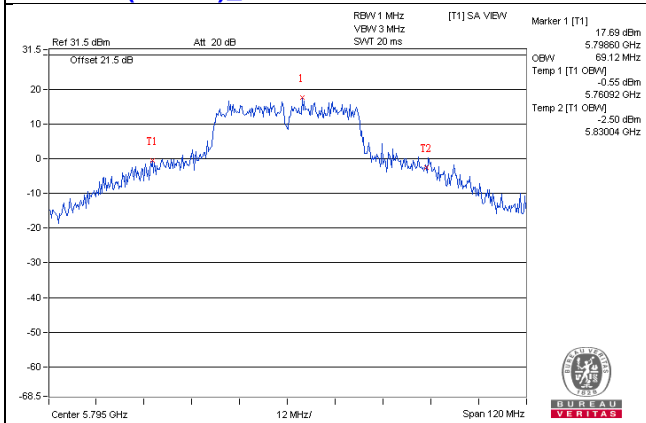

**802.11ac (VHT80)\_Chain 0 / CH155**

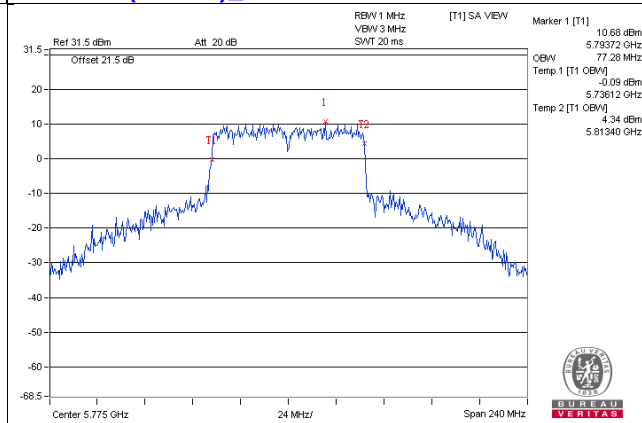

### Spectrum Plot for near by DFS band (DFS is required, if 99% OCP straddle into U-NII-2A band)

**802.11a\_Chain0 / CH48**

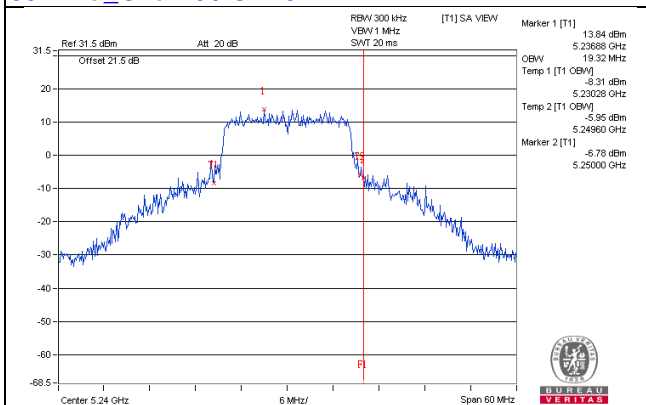

**802.11a\_Chain1 / CH48**

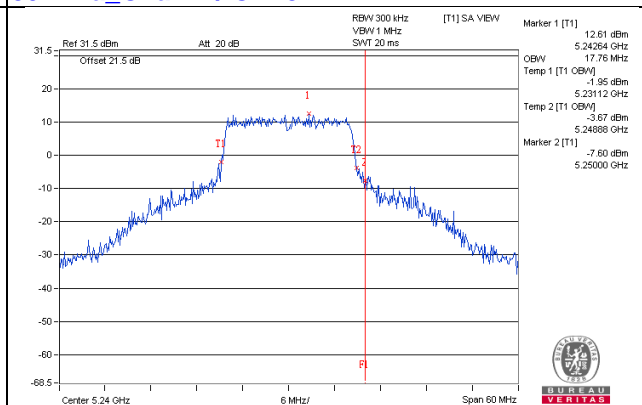

**802.11ac(VHT20)\_Chain0 / CH48**

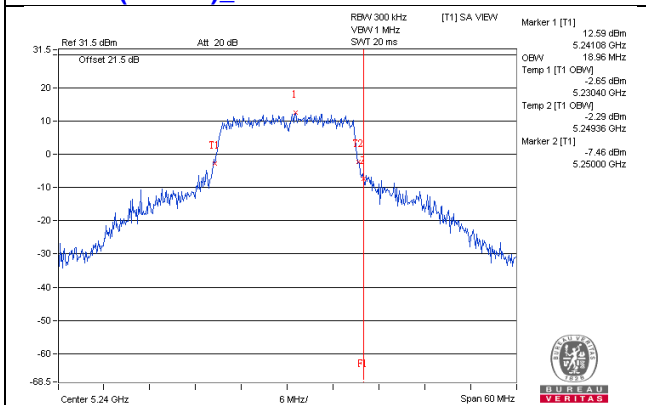

**802.11ac(VHT20)\_Chain1 / CH48**

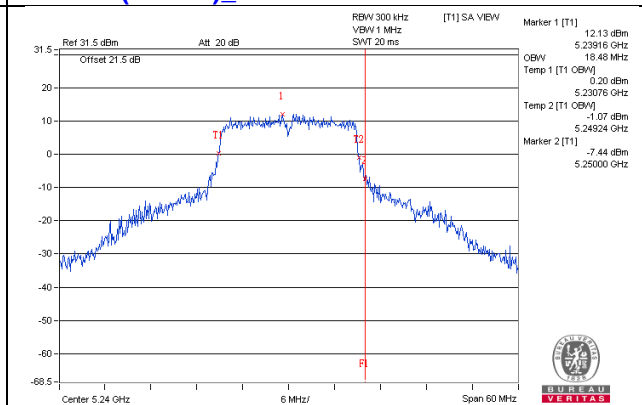

**802.11ac(VHT40)\_Chain0 / CH46**

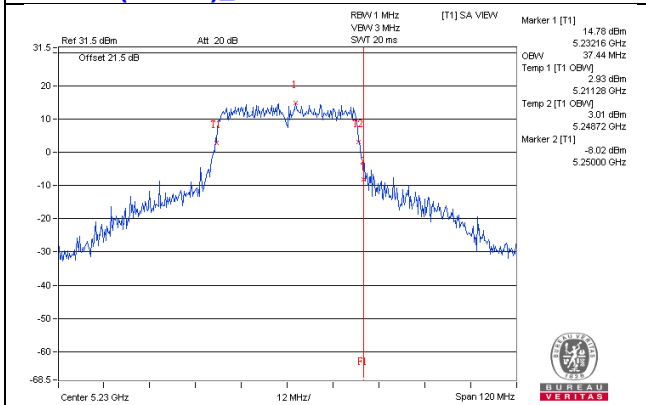

**802.11ac(VHT40)\_Chain1 / CH46**

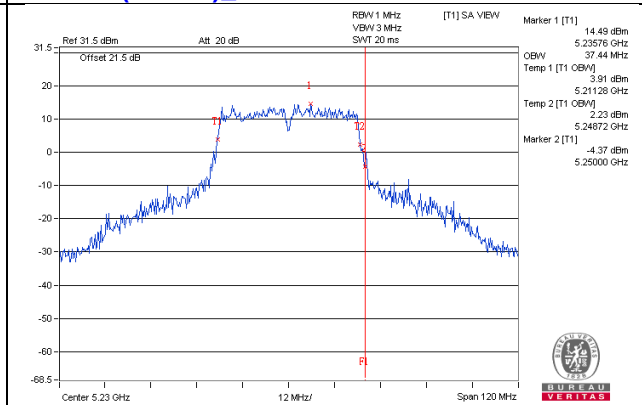

**802.11ac(VHT80)\_Chain0 / CH42**

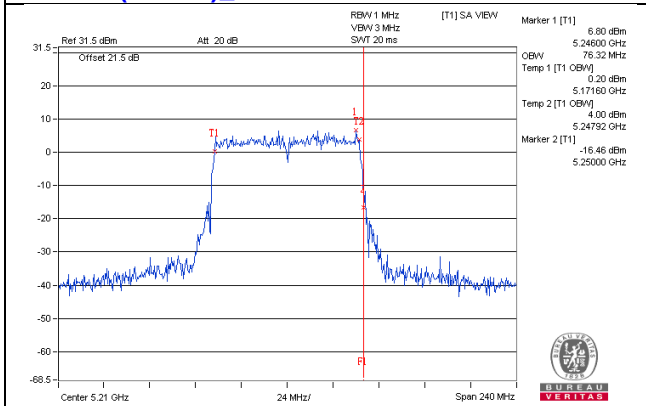

**802.11ac(VHT80)\_Chain1 / CH42**

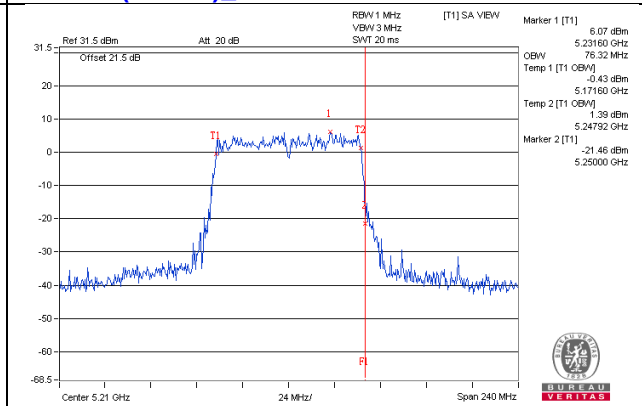

### Spectrum Plot for near by DFS band (DFS is required, if 99% OCP straddle into U-NII-2C band)

**802.11a\_Chain0 / CH149**

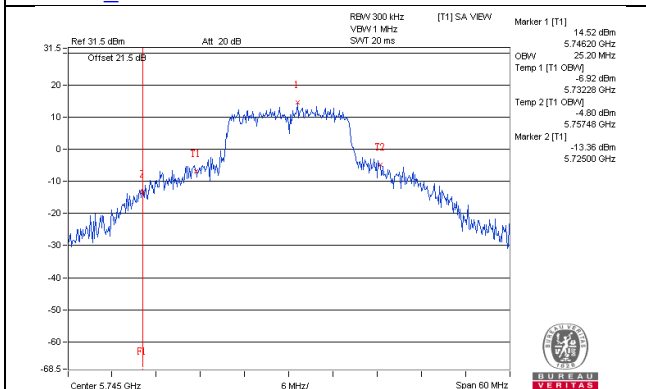

**802.11a\_Chain1 / CH149**

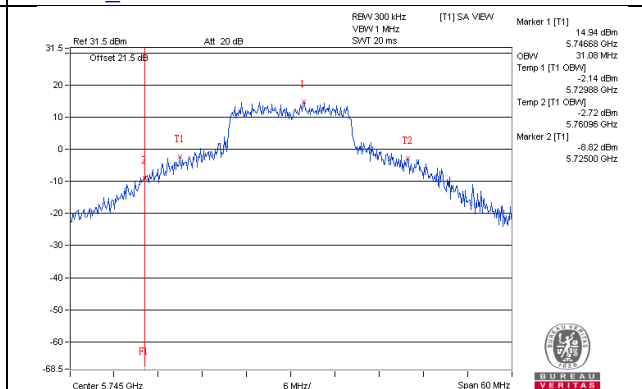

**802.11ac(VHT20)\_Chain0 / CH149**

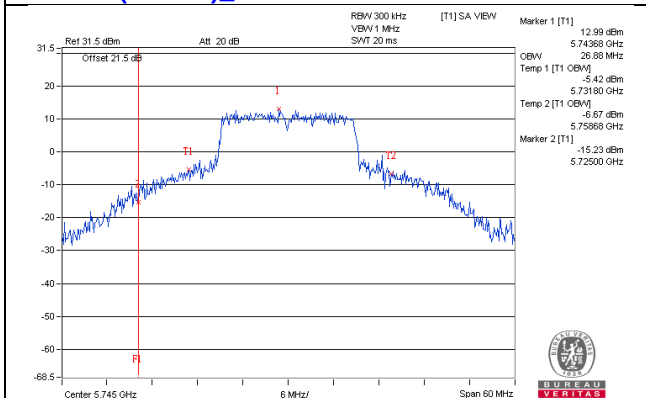

**802.11ac(VHT20)\_Chain1 / CH149**

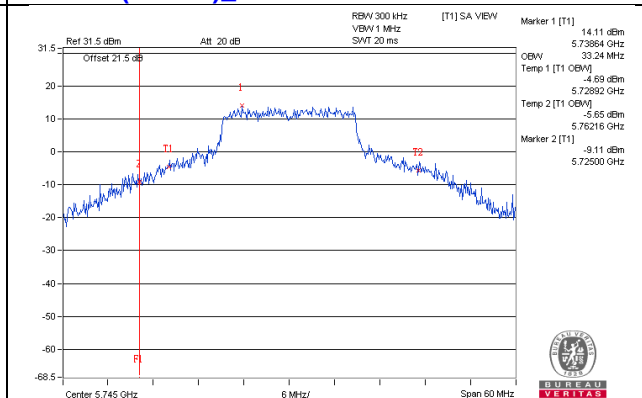

**802.11ac(VHT40)\_Chain0 / CH151**

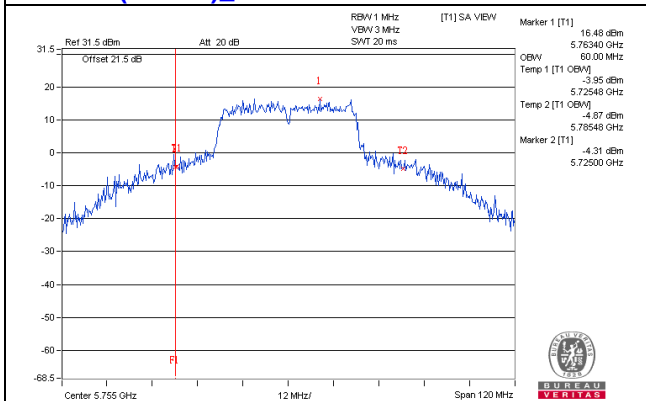

**802.11ac(VHT40)\_Chain1 / CH151**

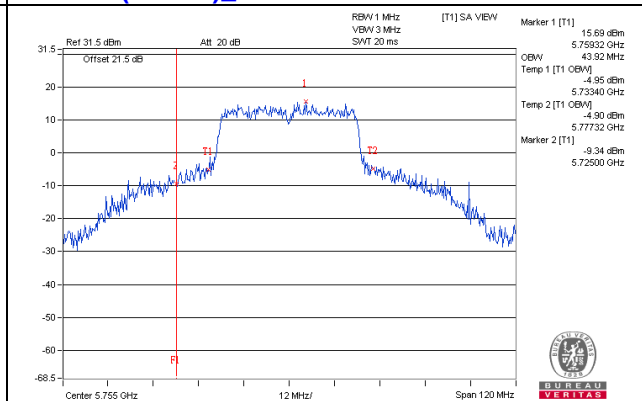

**802.11ac(VHT80)\_Chain0 / CH155**

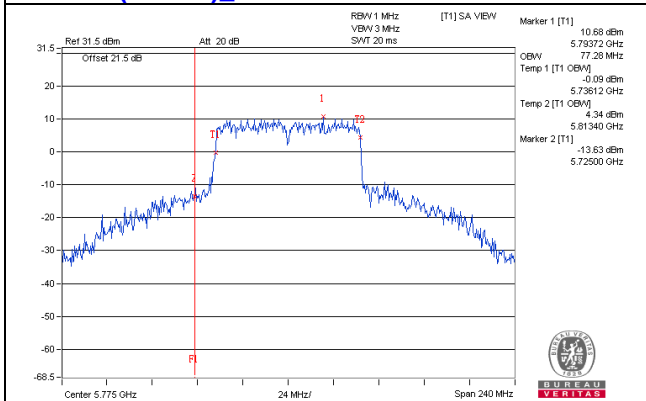

**802.11ac(VHT80)\_Chain1 / CH155**

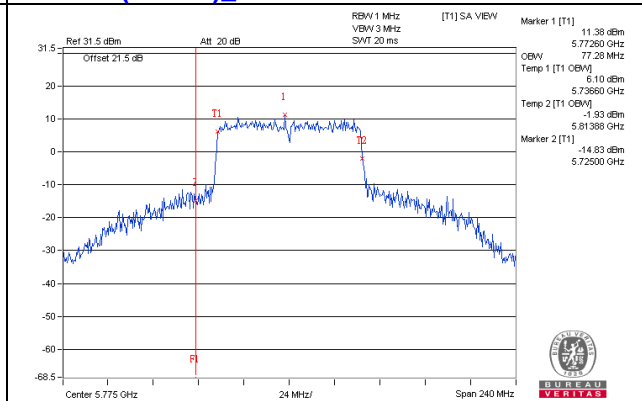

#### 4.4.5 Test Results (Mode 2)

##### 802.11a

Channel	Channel Frequency (MHz)	Occupied Bandwidth (MHz)
36	5180	18.72
40	5200	23.88
48	5240	18.12
149	5745	27.96
157	5785	29.16
165	5825	28.68

##### 802.11ac (VHT20)

Channel	Channel Frequency (MHz)	Occupied Bandwidth (MHz)
36	5180	19.32
40	5200	24.72
48	5240	18.96
149	5745	29.76
157	5785	29.52
165	5825	29.76

##### 802.11ac (VHT40)

Channel	Channel Frequency (MHz)	Occupied Bandwidth (MHz)
38	5190	37.20
46	5230	38.16
151	5755	52.08
159	5795	64.08

##### 802.11ac (VHT80)

Channel	Channel Frequency (MHz)	Occupied Bandwidth (MHz)
42	5210	76.32
155	5775	79.68



### Spectrum Plot of Worst Value

#### 802.11a / CH157

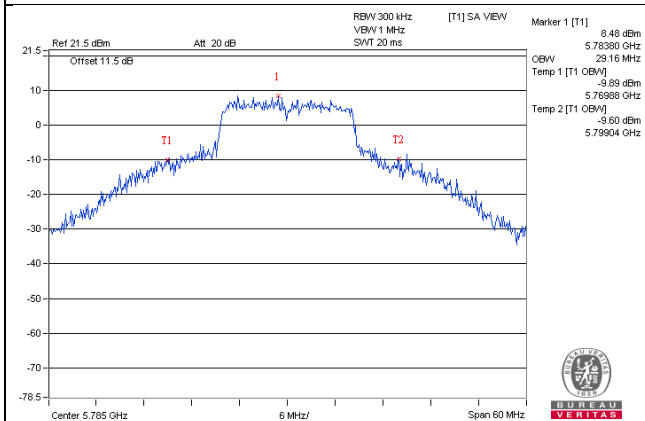

#### 802.11ac (VHT20) / CH165

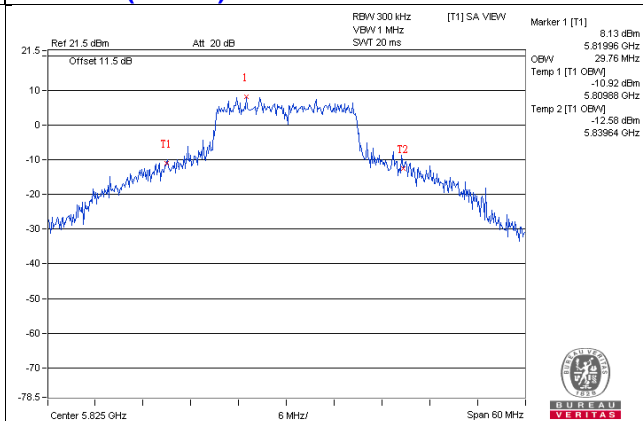

#### 802.11ac (VHT40) / CH159

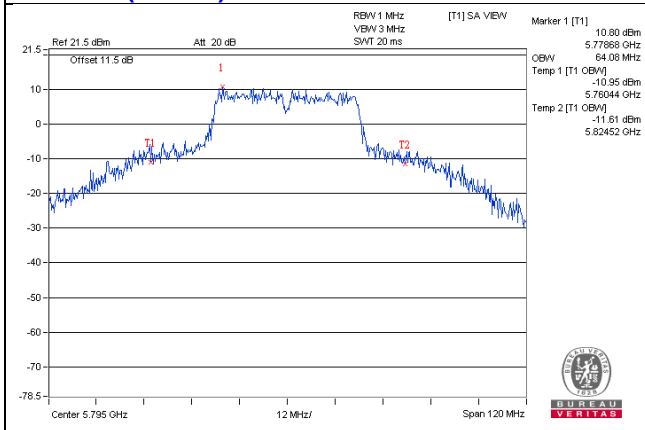

#### 802.11ac (VHT80) / CH155

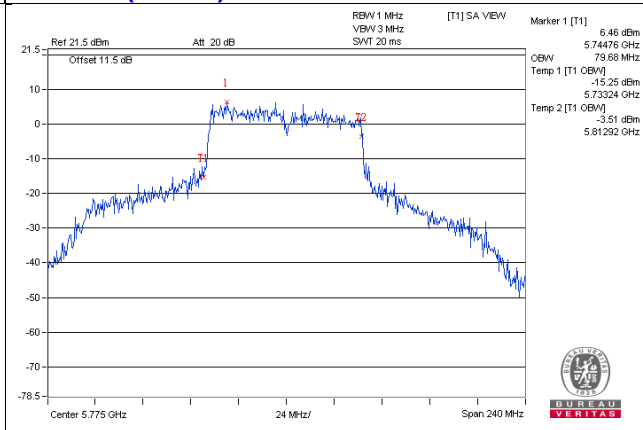

## Spectrum Plot for near by DFS band (DFS is required, if 99% OCP straddle into U-NII-2A band)

### 802.11a / CH48

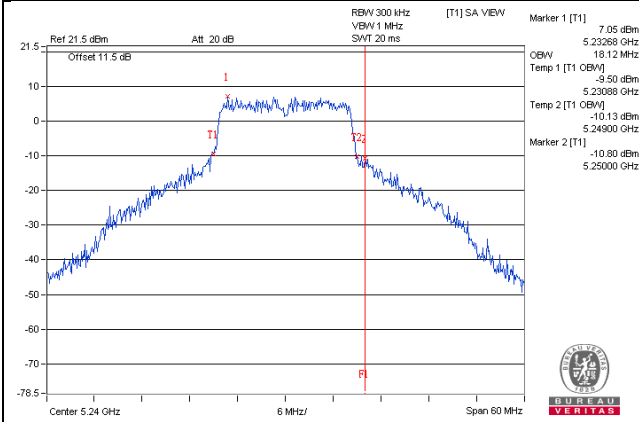

### 802.11ac(VHT20) / CH48

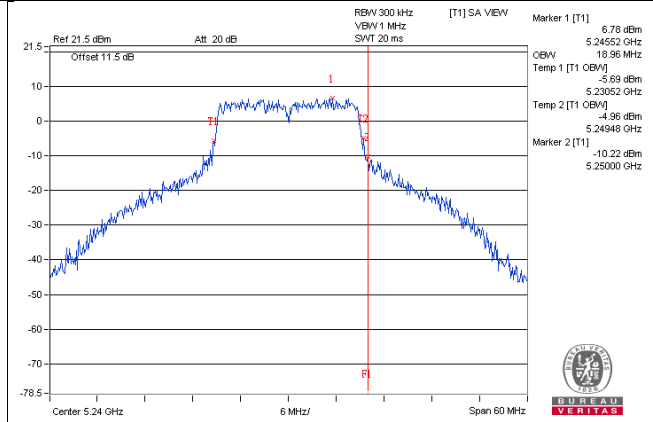

### 802.11ac(VHT40) / CH46

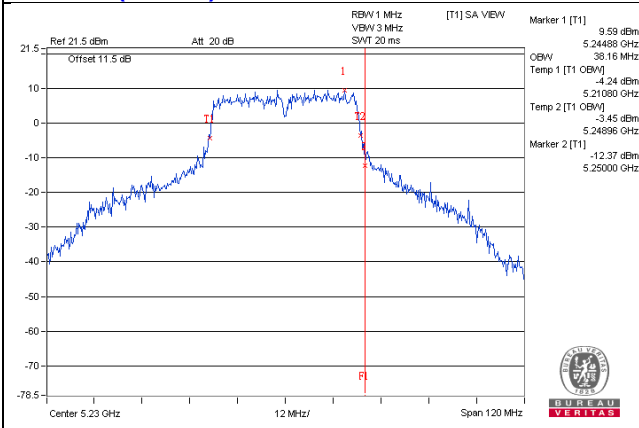

### 802.11ac(VHT80) / CH42

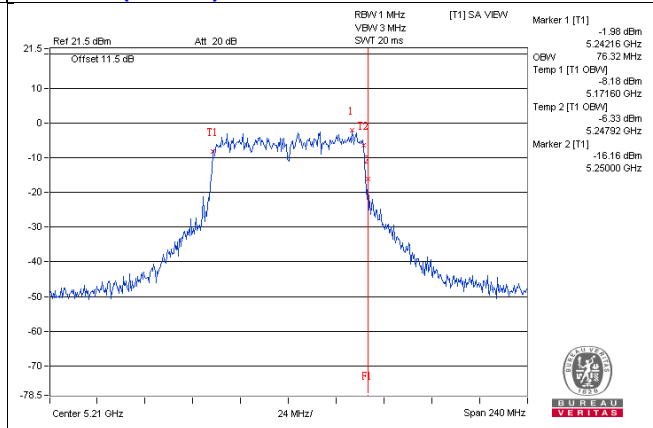

## Spectrum Plot for near by DFS band (DFS is required, if 99% OCP straddle into U-NII-2C band)

### 802.11a / CH149

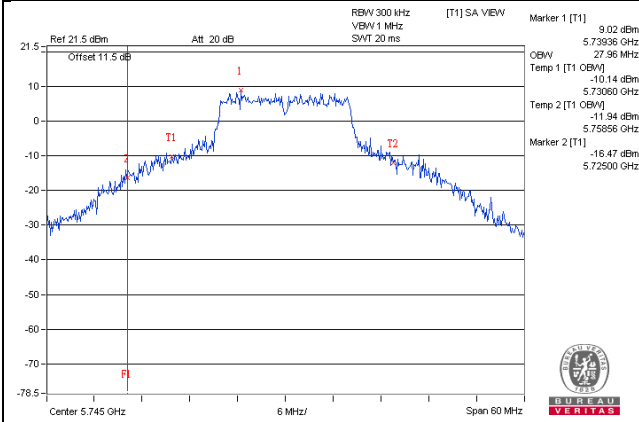

### 802.11ac(VHT20) / CH149

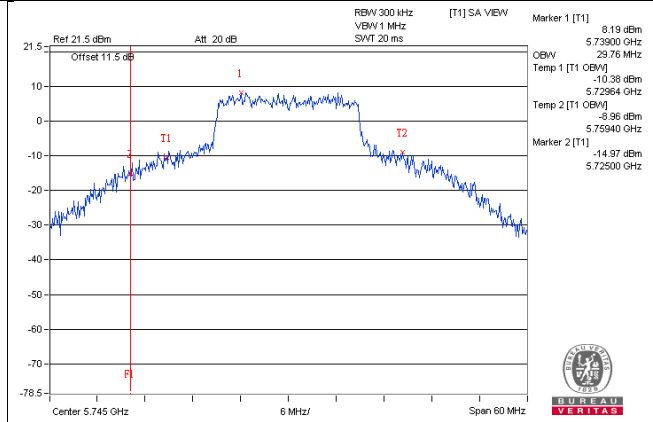

### 802.11ac(VHT40) / CH151

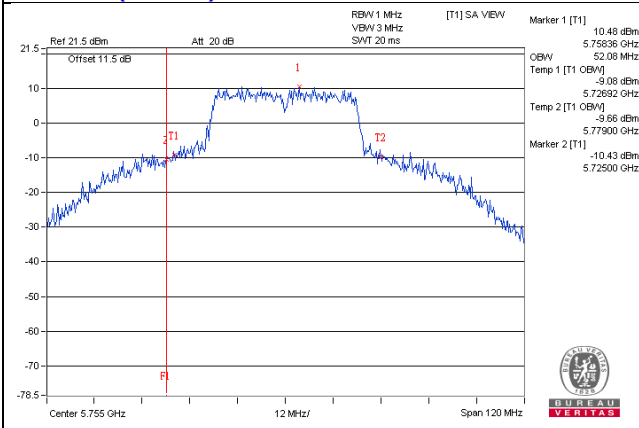

### 802.11ac(VHT80) / CH155

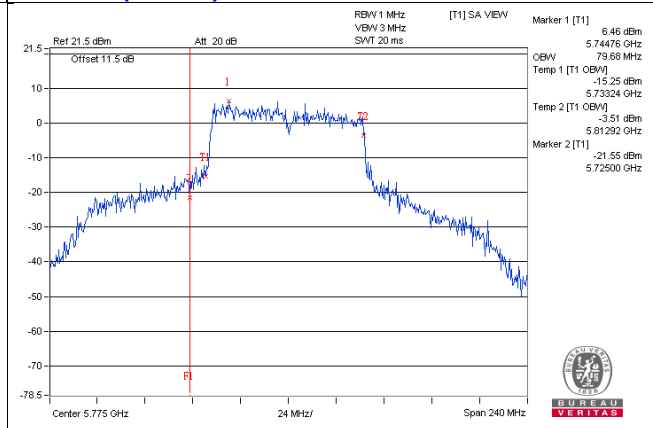

## 4.5 Peak Power Spectral Density Measurement

### 4.5.1 Limits of Peak Power Spectral Density Measurement

Operation Band	EUT Category		Limit
U-NII-1		Outdoor Access Point	17dBm/ MHz
		Fixed point-to-point Access Point	
	√	Indoor Access Point	
		Client device	
U-NII-2A	---		11dBm/ MHz
U-NII-2C	---		11dBm/ MHz
U-NII-3	√		30dBm/ 500kHz

### 4.5.2 Test Setup

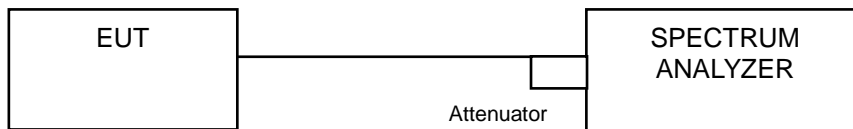

### 4.5.3 Test Instruments

Refer to section 4.1.2 to get information of above instrument.

#### 4.5.4 Test Procedure

##### **Radio 2**

##### **802.11a, 802.11ac (VHT40)**

##### **For U-NII-1:**

Using method SA-2

1. Set span to encompass the entire emission bandwidth (EBW) of the signal.
2. Set RBW = 1 MHz, Set VBW  $\geq$  3 MHz, Detector = RMS
3. Sweep time = auto, trigger set to "free run".
4. Trace average at least 100 traces in power averaging mode.
5. Record the max value and add 10 log (1/duty cycle)

##### **For U-NII-3:**

1. Set span to encompass the entire emission bandwidth (EBW) of the signal.
2. Set RBW = 300 kHz, Set VBW  $\geq$  1 MHz, Detector = RMS
3. Use the peak marker function to determine the maximum power level in any 300 kHz band segment within the fundamental EBW.
4. Scale the observed power level to an equivalent value in 500 kHz by adjusting (reducing) the measured power by a bandwidth correction factor (BWCF) where  $BWCF = 10\log(500\text{ kHz}/300\text{kHz})$
5. Sweep time = auto, trigger set to "free run".
6. Trace average at least 100 traces in power averaging mode.
7. Record the max value and add 10 log (1/duty cycle)

##### **802.11ac (VHT20), 802.11ac (VHT80)**

##### **For U-NII-1:**

Using method SA-1

1. Set span to encompass the entire emission bandwidth (EBW) of the signal.
2. Set RBW = 1 MHz, Set VBW  $\geq$  3 MHz, Detector = RMS
3. Sweep time = auto, trigger set to "free run".
4. Trace average at least 100 traces in power averaging mode.
5. Record the max value

##### **For U-NII-3:**

1. Set span to encompass the entire emission bandwidth (EBW) of the signal.
2. Set RBW = 300 kHz, Set VBW  $\geq$  1 MHz, Detector = RMS
3. Use the peak marker function to determine the maximum power level in any 300 kHz band segment within the fundamental EBW.
4. Scale the observed power level to an equivalent value in 500 kHz by adjusting (reducing) the measured power by a bandwidth correction factor (BWCF) where  $BWCF = 10\log(500\text{ kHz}/300\text{kHz})$
5. Sweep time = auto, trigger set to "free run".
6. Trace average at least 100 traces in power averaging mode.
7. Record the max value

### Radio 3

#### For U-NII-1,

Using method SA-2

1. Set span to encompass the entire emission bandwidth (EBW) of the signal.
2. Set RBW = 1 MHz, Set VBW  $\geq$  3 MHz, Detector = RMS
3. Sweep time = auto, trigger set to "free run".
4. Trace average at least 100 traces in power averaging mode.
5. Record the max value and add  $10 \log (1/\text{duty cycle})$

#### For U-NII-3:

1. Set span to encompass the entire emission bandwidth (EBW) of the signal.
2. Set RBW = 300 kHz, Set VBW  $\geq$  1 MHz, Detector = RMS
3. Use the peak marker function to determine the maximum power level in any 300 kHz band segment within the fundamental EBW.
4. Scale the observed power level to an equivalent value in 500 kHz by adjusting (reducing) the measured power by a bandwidth correction factor (BWCF) where  $\text{BWCF} = 10 \log(500 \text{ kHz}/300 \text{ kHz})$
5. Sweep time = auto, trigger set to "free run".
6. Trace average at least 100 traces in power averaging mode.
7. Record the max value and add  $10 \log (1/\text{duty cycle})$

#### 4.5.5 Deviation from Test Standard

No deviation.

#### 4.5.6 EUT Operating Condition

Same as Item 4.3.6.

#### 4.5.7 Test Results (Mode 1)

For U-NII-1:

##### 802.11a

Chan.	Chan. Freq. (MHz)	PSD W/O Duty Factor (dBm/MHz)		Duty Factor (dB)	Total PSD With Duty Factor (dBm/MHz)	MAX. Limit (dBm/MHz)	Pass / Fail
		Chain 0	Chain 1				
36	5180	5.80	5.39	0.18	8.79	13.81	Pass
40	5200	8.83	8.88	0.18	12.04	13.81	Pass
48	5240	9.22	8.45	0.18	12.04	13.81	Pass

- Note:**
- Method a) of power density measurement of KDB 662911 is using for calculating total power density. Total power density is summing entire spectra across corresponding frequency bins on the various outputs by computer.
  - Directional gain =  $10 \log[(10^{G0/20} + 10^{G1/20})^2 / 2] = 9.19 > 6\text{dBi}$  , so the power density limit shall be reduced to  $17-(9.19-6) = 13.81\text{dBm}$ .
  - Refer to section 3.3 for duty cycle spectrum plot.

##### 802.11ac (VHT20)

Chan.	Chan. Freq. (MHz)	PSD (dBm/MHz)		Total Power Density (dBm/MHz)	MAX. Limit (dBm/MHz)	Pass / Fail
		Chain 0	Chain 1			
36	5180	5.72	5.23	8.49	13.81	Pass
40	5200	9.61	9.22	12.43	13.81	Pass
48	5240	8.62	8.07	11.36	13.81	Pass

- Note:**
- Method a) of power density measurement of KDB 662911 is using for calculating total power density. Total power density is summing entire spectra across corresponding frequency bins on the various outputs by computer.
  - Directional gain =  $10 \log[(10^{G0/20} + 10^{G1/20})^2 / 2] = 9.19 > 6\text{dBi}$  , so the power density limit shall be reduced to  $17-(9.19-6) = 13.81\text{dBm}$ .

### 802.11ac (VHT40)

Chan.	Chan. Freq. (MHz)	PSD W/O Duty Factor (dBm/MHz)		Duty Factor (dB)	Total PSD With Duty Factor (dBm/MHz)	MAX. Limit (dBm/MHz)	Pass / Fail
		Chain 0	Chain 1				
38	5190	0.75	-0.86	0.16	3.19	13.81	Pass
46	5230	4.98	4.38	0.16	7.86	13.81	Pass

- Note:**
- Method a) of power density measurement of KDB 662911 is using for calculating total power density. Total power density is summing entire spectra across corresponding frequency bins on the various outputs by computer.
  - Directional gain =  $10 \log[(10^{G0/20} + 10^{G1/20})^2 / 2] = 9.19 > 6\text{dBi}$  , so the power density limit shall be reduced to  $17-(9.19-6) = 13.81\text{dBm}$ .
  - Refer to section 3.3 for duty cycle spectrum plot.

### 802.11ac (VHT80)

Chan.	Chan. Freq. (MHz)	PSD W/O Duty Factor (dBm/MHz)		Duty Factor (dB)	Total PSD With Duty Factor (dBm/MHz)	MAX. Limit (dBm/MHz)	Pass / Fail
		Chain 0	Chain 1				
42	5210	-3.60	-3.97	0.29	-0.49	13.81	Pass

- Note:**
- Method a) of power density measurement of KDB 662911 is using for calculating total power density. Total power density is summing entire spectra across corresponding frequency bins on the various outputs by computer.
  - Directional gain =  $10 \log[(10^{G0/20} + 10^{G1/20})^2 / 2] = 9.19 > 6\text{dBi}$  , so the power density limit shall be reduced to  $17-(9.19-6) = 13.81\text{dBm}$ .
  - Refer to section 3.3 for duty cycle spectrum plot.



Spectrum Plot of Worst Value

802.11a\_Chain 0 / CH48

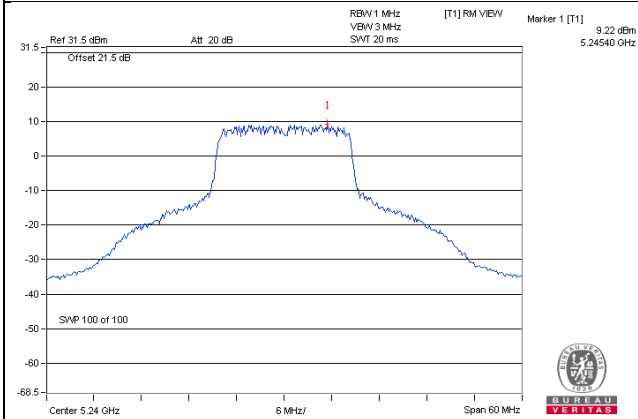

802.11ac (VHT20)\_Chain 0 / CH40

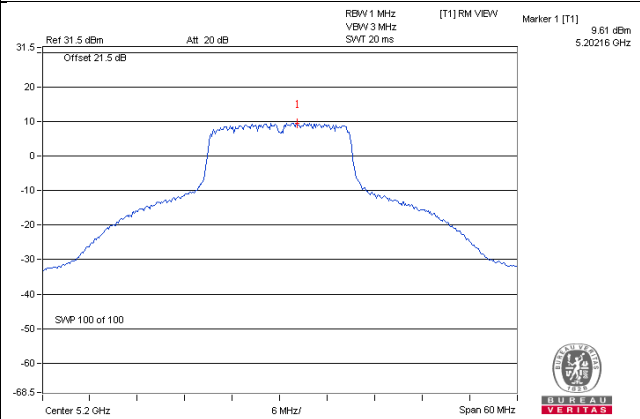

802.11ac (VHT40)\_Chain 0 / CH46

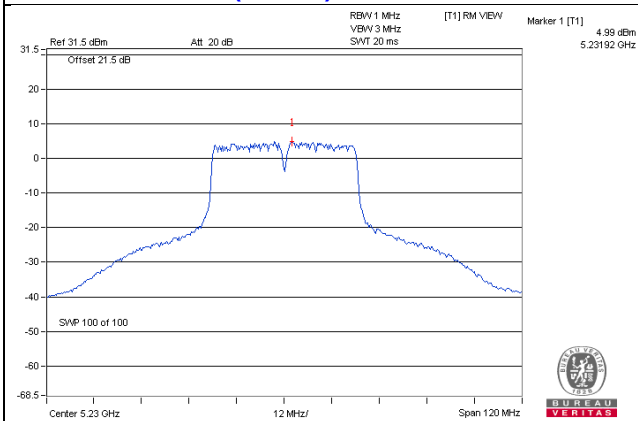

802.11ac (VHT80)\_Chain 0 / CH42

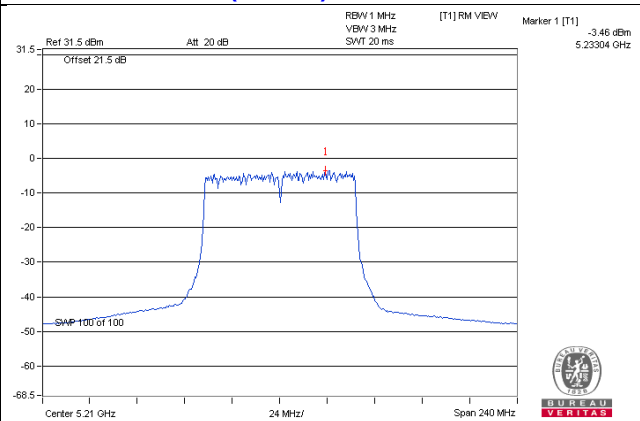

**For U-NII-3:**
**802.11a**

TX chain	Chan.	Chan. Freq. (MHz)	PSD W/O Duty Factor		10 log (N=2) dB	Duty Factor (dB)	Total PSD With Duty Factor (dBm/500kHz)	Limit (dBm/500kHz)	Pass /Fail
			(dBm/300kHz)	(dBm/500kHz)					
0	149	5745	0.37	2.59	3.01	0.18	5.78	26.20	Pass
	157	5785	0.59	2.81	3.01	0.18	6.00	26.20	Pass
	165	5825	0.24	2.46	3.01	0.18	5.65	26.20	Pass
1	149	5745	1.80	4.02	3.01	0.18	7.21	26.20	Pass
	157	5785	1.38	3.60	3.01	0.18	6.79	26.20	Pass
	165	5825	1.35	3.57	3.01	0.18	6.76	26.20	Pass

**Note:** 1. Directional gain =  $10 \log[(10^{G0/20} + 10^{G1/20})^2 / 2] = 9.8\text{dBi} > 6\text{dBi}$ , so the power density limit shall be reduced to  $30-(9.8-6) = 26.20\text{dBm}$ .

2. Refer to section 3.3 for duty cycle spectrum plot.

**802.11ac (VHT20)**

TX chain	Channel	Freq. (MHz)	PSD (dBm/300kHz)	PSD (dBm/500kHz)	10 log (N=2) dB	Total PSD (dBm/500kHz)	Limit (dBm/500kHz)	Pass /Fail
0	149	5745	0.55	2.77	3.01	5.78	26.20	Pass
	157	5785	0.49	2.71	3.01	5.72	26.20	Pass
	165	5825	0.45	2.67	3.01	5.68	26.20	Pass
1	149	5745	1.96	4.18	3.01	7.19	26.20	Pass
	157	5785	1.72	3.94	3.01	6.95	26.20	Pass
	165	5825	1.47	3.69	3.01	6.70	26.20	Pass

**Note:** 1. Directional gain =  $10 \log[(10^{G0/20} + 10^{G1/20})^2 / 2] = 9.8\text{dBi} > 6\text{dBi}$ , so the power density limit shall be reduced to  $30-(9.8-6) = 26.20\text{dBm}$ .

### 802.11ac (VHT40)

TX chain	Chan.	Chan. Freq. (MHz)	PSD W/O Duty Factor		10 log (N=2) dB	Duty Factor (dB)	Total PSD With Duty Factor (dBm/500kHz)	Limit (dBm/500kHz)	Pass /Fail
			(dBm/300kHz)	(dBm/500kHz)					
0	151	5755	-2.49	-0.27	3.01	0.16	2.90	26.20	Pass
	159	5795	-2.57	-0.35	3.01	0.16	2.82	26.20	Pass
1	151	5755	-3.09	-0.87	3.01	0.16	2.30	26.20	Pass
	159	5795	-2.13	0.09	3.01	0.16	3.26	26.20	Pass

**Note:** 1. Directional gain =  $10 \log[(10^{G0/20} + 10^{G1/20})^2 / 2] = 9.8\text{dBi} > 6\text{dBi}$ , so the power density limit shall be reduced to  $30-(9.8-6) = 26.20\text{dBm}$ .

2. Refer to section 3.3 for duty cycle spectrum plot.

### 802.11ac (VHT80)

TX chain	Chan.	Chan. Freq. (MHz)	PSD W/O Duty Factor		10 log (N=2) dB	Duty Factor (dB)	Total PSD With Duty Factor (dBm/500kHz)	Limit (dBm/500kHz)	Pass /Fail
			(dBm/300kHz)	(dBm/500kHz)					
0	155	5775	-8.00	-5.78	3.01	0.29	-2.48	26.20	Pass
1	155	5775	-7.80	-5.58	3.01	0.29	-2.28	26.20	Pass

**Note:** 1. Directional gain =  $10 \log[(10^{G0/20} + 10^{G1/20})^2 / 2] = 9.8\text{dBi} > 6\text{dBi}$ , so the power density limit shall be reduced to  $30-(9.8-6) = 26.20\text{dBm}$ .

2. Refer to section 3.3 for duty cycle spectrum plot.

Spectrum Plot of Worst Value

802.11a\_Chain 1 / CH149

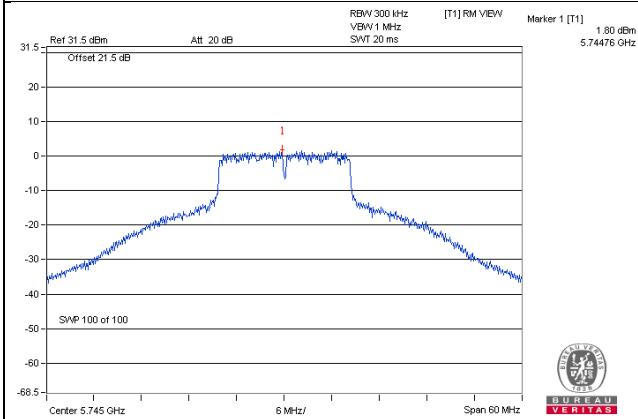

802.11ac (VHT20)\_Chain 1 / CH149

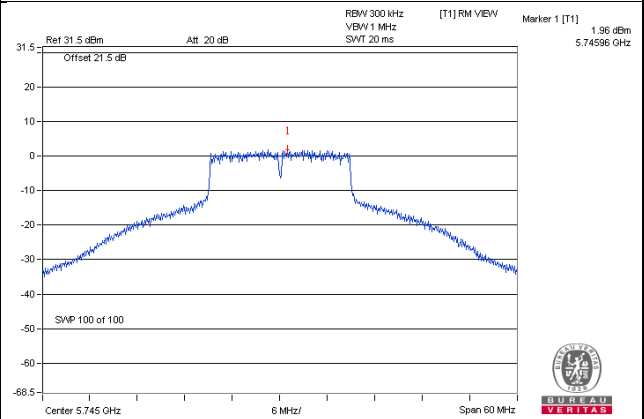

802.11ac (VHT40)\_Chain 1 / CH159

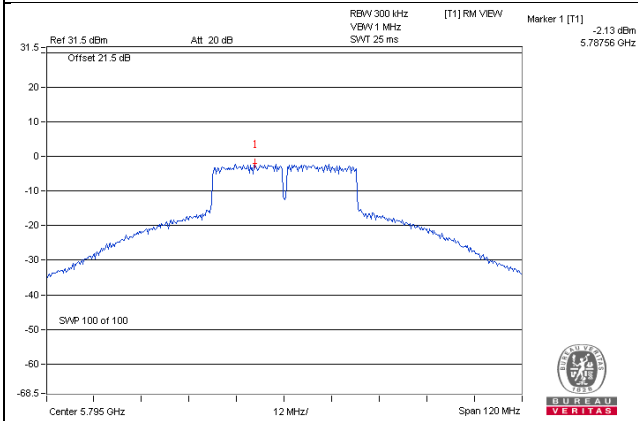

802.11ac (VHT80)\_Chain 1 / CH155

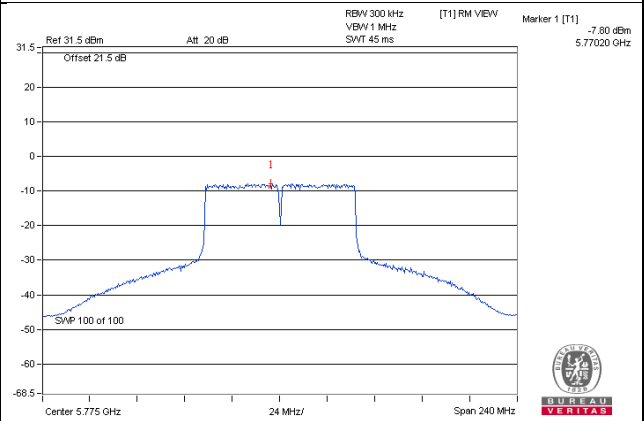

#### 4.5.8 Test Results (Mode 2)

##### For U-NII-1:

##### 802.11a

Chan.	Chan. Freq. (MHz)	PSD W/O Duty Factor (dBm/MHz)	Duty Factor (dB)	PSD With Duty Factor (dBm/MHz)	MAX. Limit (dBm/MHz)	Pass / Fail
36	5180	1.67	0.17	1.84	16.42	Pass
40	5200	4.00	0.17	4.17	16.42	Pass
48	5240	2.77	0.17	2.94	16.42	Pass

**Note:** 1. The directional gain is  $6.58 > 6\text{dBi}$ , so the power density limit shall be reduced to  $17-(6.58-6) = 16.42\text{dBm}$ .

2. Refer to section 3.3 for duty cycle spectrum plot.

##### 802.11ac (VHT20)

Chan.	Chan. Freq. (MHz)	PSD W/O Duty Factor (dBm/MHz)	Duty Factor (dB)	PSD With Duty Factor (dBm/MHz)	MAX. Limit (dBm/MHz)	Pass / Fail
36	5180	1.81	0.17	1.99	16.42	Pass
40	5200	4.40	0.17	4.57	16.42	Pass
48	5240	2.44	0.17	2.62	16.42	Pass

**Note:** 1. The directional gain is  $6.58 > 6\text{dBi}$ , so the power density limit shall be reduced to  $17-(6.58-6) = 16.42\text{dBm}$ .

2. Refer to section 3.3 for duty cycle spectrum plot.

##### 802.11ac (VHT40)

Chan.	Chan. Freq. (MHz)	PSD W/O Duty Factor (dBm/MHz)	Duty Factor (dB)	PSD With Duty Factor (dBm/MHz)	MAX. Limit (dBm/MHz)	Pass / Fail
38	5190	-6.32	0.34	-5.98	16.42	Pass
46	5230	-1.34	0.34	-1.00	16.42	Pass

**Note:** 1. The directional gain is  $6.58 > 6\text{dBi}$ , so the power density limit shall be reduced to  $17-(6.58-6) = 16.42\text{dBm}$ .

2. Refer to section 3.3 for duty cycle spectrum plot.

##### 802.11ac (VHT80)

Chan.	Chan. Freq. (MHz)	PSD W/O Duty Factor (dBm/MHz)	Duty Factor (dB)	PSD With Duty Factor (dBm/MHz)	MAX. Limit (dBm/MHz)	Pass / Fail
42	5210	-12.73	0.71	-12.02	16.42	Pass

**Note:** 1. The directional gain is  $6.58 > 6\text{dBi}$ , so the power density limit shall be reduced to  $17-(6.58-6) = 16.42\text{dBm}$ .

2. Refer to section 3.3 for duty cycle spectrum plot.

### Spectrum Plot of Worst Value

**802.11a / CH40**

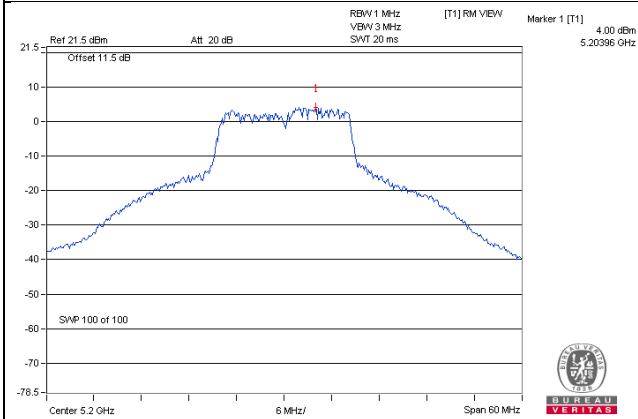

**802.11ac (VHT20) / CH40**

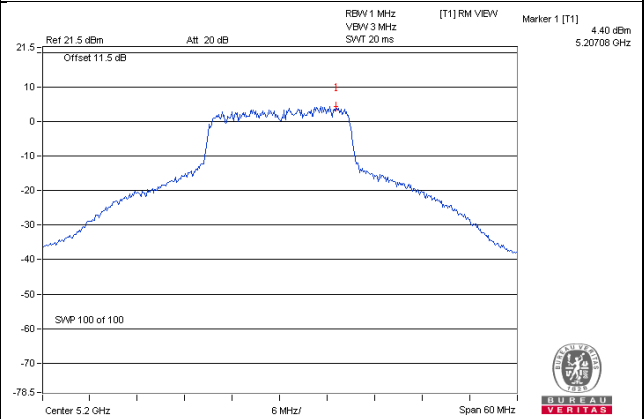

**802.11ac (VHT40) / CH46**

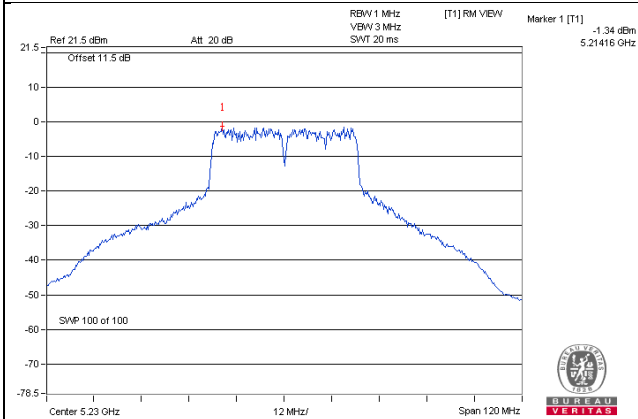

**802.11ac (VHT80) / CH42**

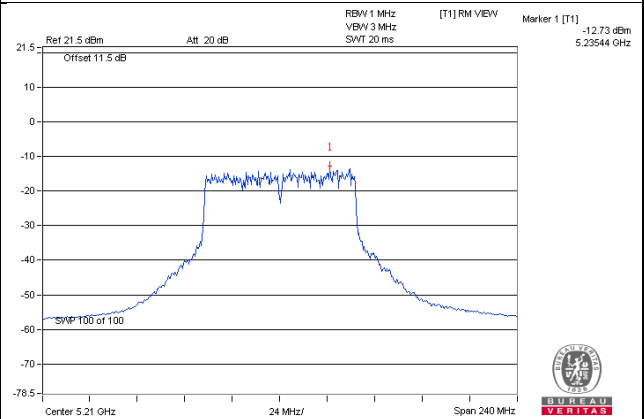

**For U-NII-3:**
**802.11a**

Chan.	Chan. Freq. (MHz)	PSD W/O Duty Factor		Duty Factor (dB)	Total PSD With Duty Factor (dBm/500kHz)	Limit (dBm/500kHz)	Pass /Fail
		(dBm/300kHz)	(dBm/500kHz)				
149	5745	-3.96	-1.74	0.17	-1.57	28.99	Pass
157	5785	-4.45	-2.23	0.17	-2.06	28.99	Pass
165	5825	-4.64	-2.42	0.17	-2.25	28.99	Pass

- Note:** 1. The directional gain is 7.01 > 6dBi, so the power density limit shall be reduced to  $30-(7.01-6) = 28.99\text{dBm}$ .
2. Refer to section 3.3 for duty cycle spectrum plot.

**802.11ac (VHT20)**

Chan.	Chan. Freq. (MHz)	PSD W/O Duty Factor		Duty Factor (dB)	Total PSD With Duty Factor (dBm/500kHz)	Limit (dBm/500kHz)	Pass /Fail
		(dBm/300kHz)	(dBm/500kHz)				
149	5745	-4.24	-2.02	0.17	-1.85	28.99	Pass
157	5785	-4.73	-2.51	0.17	-2.34	28.99	Pass
165	5825	-5.10	-2.88	0.17	-2.71	28.99	Pass

- Note:** 1. The directional gain is 7.01 > 6dBi, so the power density limit shall be reduced to  $30-(7.01-6) = 28.99\text{dBm}$ .
2. Refer to section 3.3 for duty cycle spectrum plot.

**802.11ac (VHT40)**

Chan.	Chan. Freq. (MHz)	PSD W/O Duty Factor		Duty Factor (dB)	Total PSD With Duty Factor (dBm/500kHz)	Limit (dBm/500kHz)	Pass /Fail
		(dBm/300kHz)	(dBm/500kHz)				
151	5755	-8.27	-6.05	0.34	-5.71	28.99	Pass
159	5795	-8.27	-6.05	0.34	-5.71	28.99	Pass

- Note:** 1. The directional gain is 7.01 > 6dBi, so the power density limit shall be reduced to  $30-(7.01-6) = 28.99\text{dBm}$ .
2. Refer to section 3.3 for duty cycle spectrum plot.

**802.11ac (VHT80)**

Chan.	Chan. Freq. (MHz)	PSD W/O Duty Factor		Duty Factor (dB)	Total PSD With Duty Factor (dBm/500kHz)	Limit (dBm/500kHz)	Pass /Fail
		(dBm/300kHz)	(dBm/500kHz)				
155	5775	-12.66	-10.44	0.71	-9.73	28.99	Pass

- Note:** 1. The directional gain is 7.01 > 6dBi, so the power density limit shall be reduced to  $30-(7.01-6) = 28.99\text{dBm}$ .
2. Refer to section 3.3 for duty cycle spectrum plot.

Spectrum Plot of Worst Value

802.11a / CH149

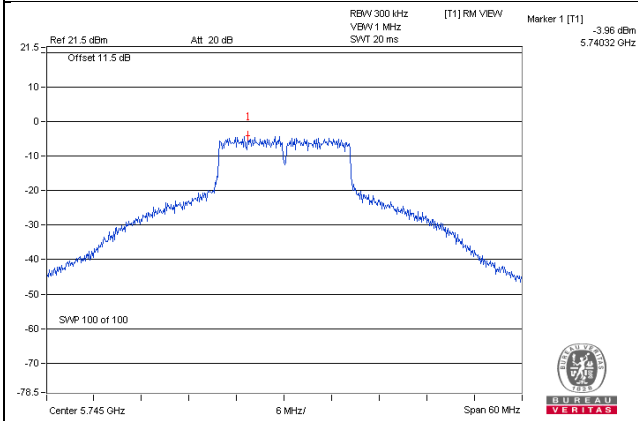

802.11ac (VHT20) / CH149

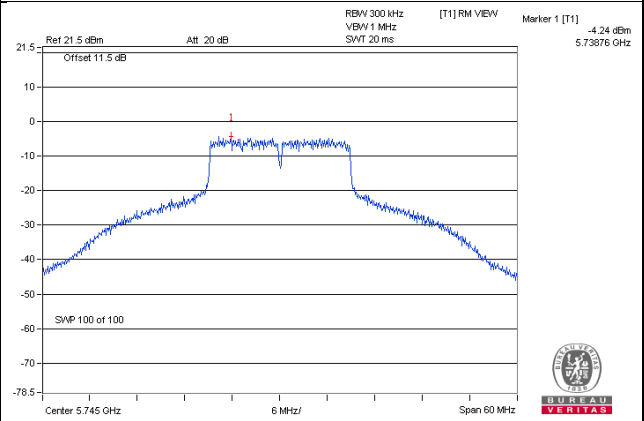

802.11ac (VHT40) / CH151

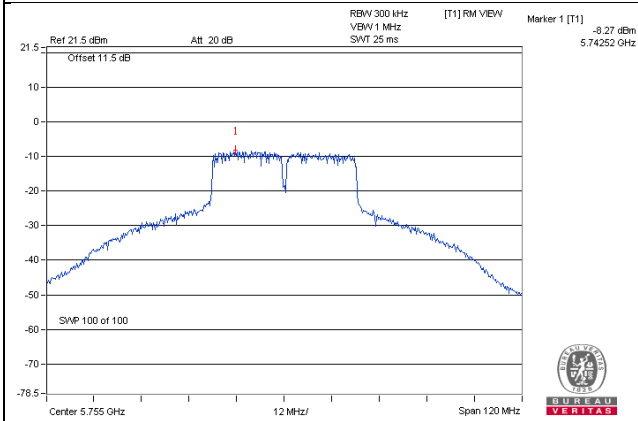

802.11ac (VHT80) / CH155

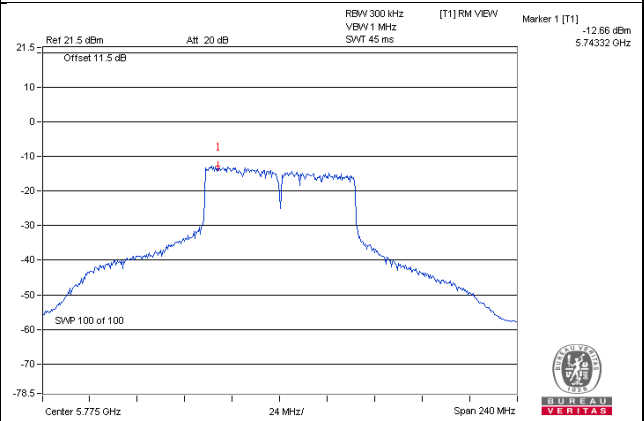



## 4.6 Frequency Stability Measurement

### 4.6.1 Limits of Frequency Stability Measurement

The frequency of the carrier signal shall be maintained within band of operation

### 4.6.2 Test Setup

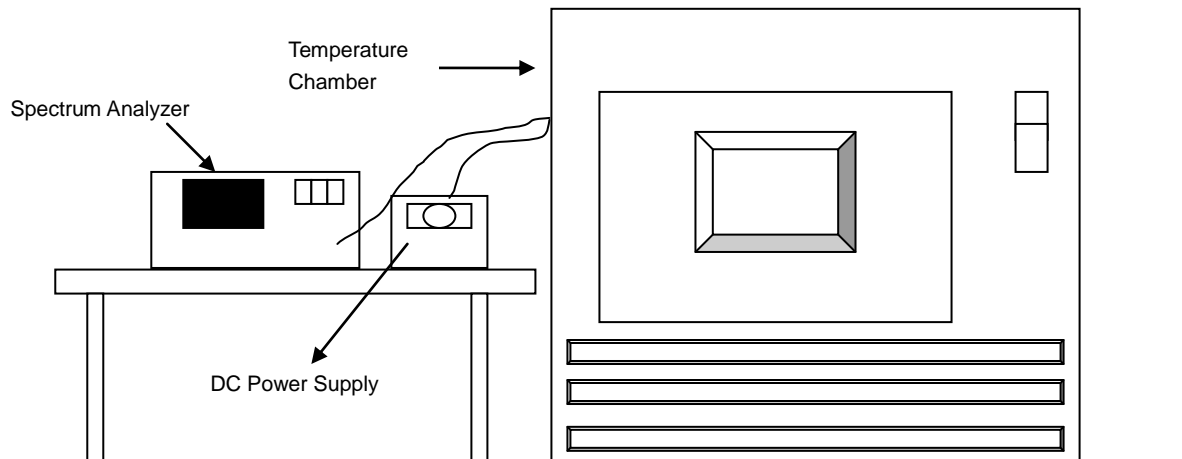

### 4.6.3 Test Instruments

Refer to section 4.1.2 to get information of above instrument.

### 4.6.4 Test Procedure

- The EUT was placed inside the environmental test chamber and powered by nominal DC voltage.
- Turn the EUT on and couple its output to a spectrum analyzer.
- Turn the EUT off and set the chamber to the highest temperature specified.
- Allow sufficient time (approximately 30 min) for the temperature of the chamber to stabilize, turn the EUT on and measure the operating frequency after 2, 5, and 10 Minutes.
- Repeat step 2 and 3 with the temperature chamber set to the lowest temperature.
- The test chamber was allowed to stabilize at +20 degree C for a minimum of 30 Minutes. The supply voltage was then adjusted on the EUT from 85% to 115% and the frequency record.

### 4.6.5 Deviation from Test Standard

No deviation.

### 4.6.6 EUT Operating Condition

Set the EUT transmit at un-modulation mode to test frequency stability.

## 4.6.7 Test Results (Mode 1)

Frequency Stability Versus Temp.									
Operating Frequency: 5180 MHz									
TEMP. (°C)	Power Supply (Vdc)	0 Minute		2 Minutes		5 Minutes		10 Minutes	
		Measured Frequency (MHz)	Pass/Fail	Measured Frequency (MHz)	Pass/Fail	Measured Frequency (MHz)	Pass/Fail	Measured Frequency (MHz)	Pass/Fail
50	48	5179.9891	PASS	5179.9879	PASS	5179.987	PASS	5179.9857	PASS
40	48	5179.9781	PASS	5179.9809	PASS	5179.9795	PASS	5179.9779	PASS
30	48	5180.0089	PASS	5180.0082	PASS	5180.0055	PASS	5180.008	PASS
20	48	5180.0191	PASS	5180.0204	PASS	5180.0217	PASS	5180.0198	PASS
10	48	5180.015	PASS	5180.0153	PASS	5180.0128	PASS	5180.0129	PASS
0	48	5179.9945	PASS	5179.9952	PASS	5179.9969	PASS	5179.9954	PASS
-10	48	5179.9909	PASS	5179.9915	PASS	5179.9924	PASS	5179.9932	PASS
-20	48	5180.0044	PASS	5180.0052	PASS	5180.0064	PASS	5180.0048	PASS
-30	48	5180.0177	PASS	5180.0207	PASS	5180.0205	PASS	5180.0194	PASS

Frequency Stability Versus Voltage									
Operating Frequency: 5180 MHz									
TEMP. (°C)	Power Supply (Vdc)	0 Minute		2 Minutes		5 Minutes		10 Minutes	
		Measured Frequency (MHz)	Pass/Fail	Measured Frequency (MHz)	Pass/Fail	Measured Frequency (MHz)	Pass/Fail	Measured Frequency (MHz)	Pass/Fail
20	55.2	5180.02	PASS	5180.0202	PASS	5180.0208	PASS	5180.0208	PASS
	48	5180.0191	PASS	5180.0204	PASS	5180.0217	PASS	5180.0198	PASS
	40.8	5180.0186	PASS	5180.0205	PASS	5180.0221	PASS	5180.0195	PASS

## 4.6.8 Test Results (Mode 2)

Frequency Stability Versus Temp.									
Operating Frequency: 5180 MHz									
TEMP. (°C)	Power Supply (Vdc)	0 Minute		2 Minutes		5 Minutes		10 Minutes	
		Measured Frequency (MHz)	Pass/Fail	Measured Frequency (MHz)	Pass/Fail	Measured Frequency (MHz)	Pass/Fail	Measured Frequency (MHz)	Pass/Fail
50	48	5179.9958	PASS	5179.9947	PASS	5179.9972	PASS	5179.9956	PASS
40	48	5180.0106	PASS	5180.0127	PASS	5180.0132	PASS	5180.0119	PASS
30	48	5179.9803	PASS	5179.9849	PASS	5179.983	PASS	5179.9801	PASS
20	48	5179.9759	PASS	5179.9747	PASS	5179.9754	PASS	5179.9738	PASS
10	48	5180.0076	PASS	5180.0071	PASS	5180.0107	PASS	5180.0077	PASS
0	48	5180.0045	PASS	5180.0048	PASS	5180.0024	PASS	5180.0036	PASS
-10	48	5180.0054	PASS	5180.0058	PASS	5180.0031	PASS	5180.0065	PASS
-20	48	5180.0183	PASS	5180.0143	PASS	5180.0163	PASS	5180.016	PASS
-30	48	5179.9836	PASS	5179.9793	PASS	5179.9838	PASS	5179.9838	PASS

Frequency Stability Versus Voltage									
Operating Frequency: 5180 MHz									
TEMP. (°C)	Power Supply (Vdc)	0 Minute		2 Minutes		5 Minutes		10 Minutes	
		Measured Frequency (MHz)	Pass/Fail	Measured Frequency (MHz)	Pass/Fail	Measured Frequency (MHz)	Pass/Fail	Measured Frequency (MHz)	Pass/Fail
20	55.2	5179.9751	PASS	5179.9739	PASS	5179.9759	PASS	5179.974	PASS
	48	5179.9759	PASS	5179.9747	PASS	5179.9754	PASS	5179.9738	PASS
	40.8	5179.9749	PASS	5179.9745	PASS	5179.9748	PASS	5179.9742	PASS

## 4.7 6dB Bandwidth Measurement

### 4.7.1 Limits of 6dB Bandwidth Measurement

The minimum of 6dB Bandwidth Measurement is 0.5MHz.

### 4.7.2 Test Setup

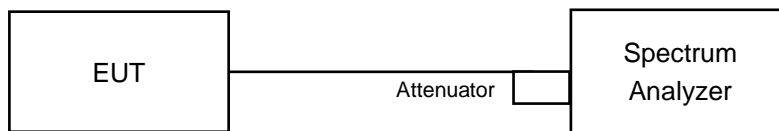

### 4.7.3 Test Instruments

Refer to section 4.1.2 to get information of above instrument.

### 4.7.4 Test Procedure

#### MEASUREMENT PROCEDURE REF

- a. Set resolution bandwidth (RBW) = 100kHz
- b. Set the video bandwidth (VBW)  $\geq 3 \times$  RBW, Detector = Peak.
- c. Trace mode = max hold.
- d. Sweep = auto couple.
- e. Measure the maximum width of the emission that is constrained by the frequencies associated with the two amplitude points (upper and lower) that are attenuated by 6 dB relative to the maximum level measured in the fundamental emission

### 4.7.5 Deviation from Test Standard

No deviation.

### 4.7.6 EUT Operating Condition

The software provided by client to enable the EUT under transmission condition continuously at lowest, middle and highest channel frequencies individually.

#### 4.7.7 Test Results (Mode 1)

##### 802.11a

Channel	Frequency (MHz)	6dB Bandwidth (MHz)		Minimum Limit (MHz)	Pass / Fail
		Chain 0	Chain 1		
149	5745	16.41	16.33	0.5	PASS
157	5785	16.42	16.37	0.5	PASS
165	5825	16.40	16.38	0.5	PASS

##### 802.11ac (VHT20)

Channel	Frequency (MHz)	6dB Bandwidth (MHz)		Minimum Limit (MHz)	Pass / Fail
		Chain 0	Chain 1		
149	5745	17.66	17.64	0.5	PASS
157	5785	17.65	17.65	0.5	PASS
165	5825	17.65	17.62	0.5	PASS

##### 802.11ac (VHT40)

Channel	Frequency (MHz)	6dB Bandwidth (MHz)		Minimum Limit (MHz)	Pass / Fail
		Chain 0	Chain 1		
151	5755	36.15	36.48	0.5	PASS
159	5795	36.47	36.41	0.5	PASS

##### 802.11ac (VHT80)

Channel	Frequency (MHz)	6dB Bandwidth (MHz)		Minimum Limit (MHz)	Pass / Fail
		Chain 0	Chain 1		
155	5775	76.47	76.46	0.5	PASS

### Spectrum Plot of Worst Value

#### 802.11a\_Chain 1 / CH149

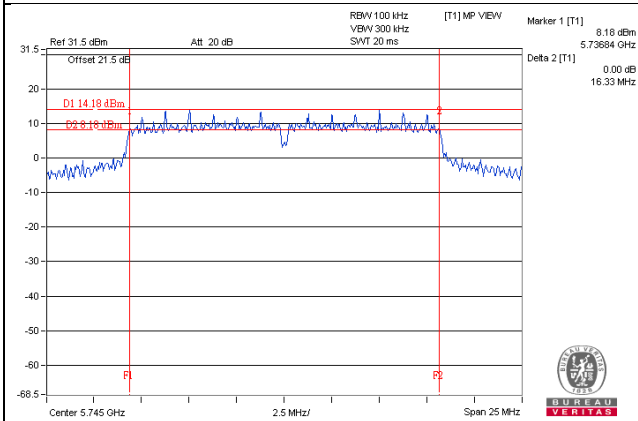

#### 802.11ac (VHT20)\_Chain 1 / CH165

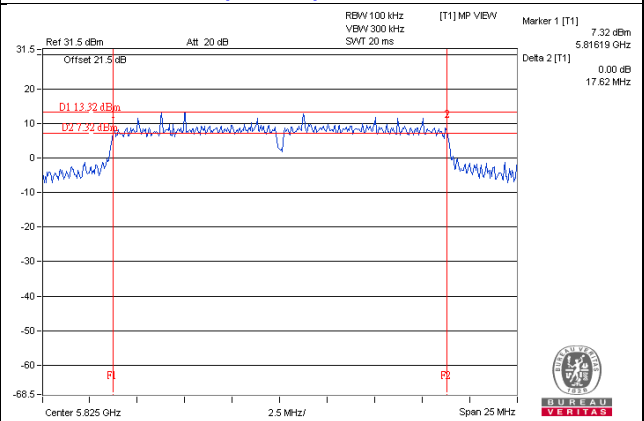

#### 802.11ac (VHT40)\_Chain 0 / CH151

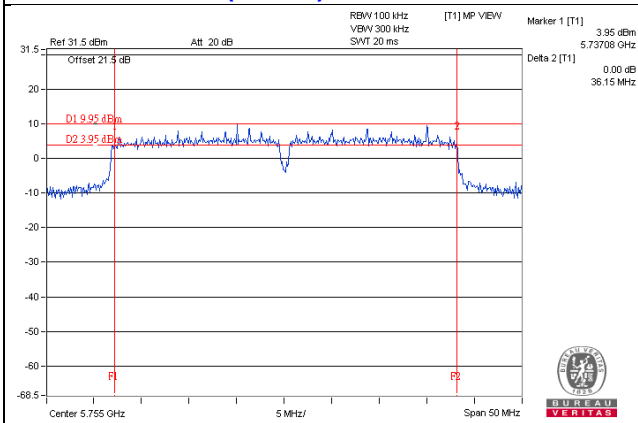

#### 802.11ac (VHT80)\_Chain 1 / CH155

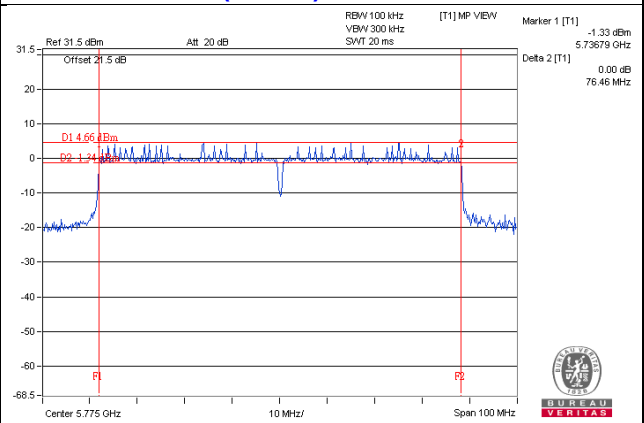

#### 4.7.8 Test Results (Mode 2)

##### 802.11a

Channel	Frequency (MHz)	6dB Bandwidth (MHz)	Minimum Limit (MHz)	Pass / Fail
149	5745	16.38	0.5	PASS
157	5785	16.42	0.5	PASS
165	5825	16.41	0.5	PASS

##### 802.11ac (VHT20)

Channel	Frequency (MHz)	6dB Bandwidth (MHz)	Minimum Limit (MHz)	Pass / Fail
149	5745	17.62	0.5	PASS
157	5785	17.37	0.5	PASS
165	5825	17.59	0.5	PASS

##### 802.11ac (VHT40)

Channel	Frequency (MHz)	6dB Bandwidth (MHz)	Minimum Limit (MHz)	Pass / Fail
151	5755	35.79	0.5	PASS
159	5795	36.16	0.5	PASS

##### 802.11ac (VHT80)

Channel	Frequency (MHz)	6dB Bandwidth (MHz)	Minimum Limit (MHz)	Pass / Fail
155	5775	73.26	0.5	PASS

### Spectrum Plot of Worst Value

#### 802.11a / CH149

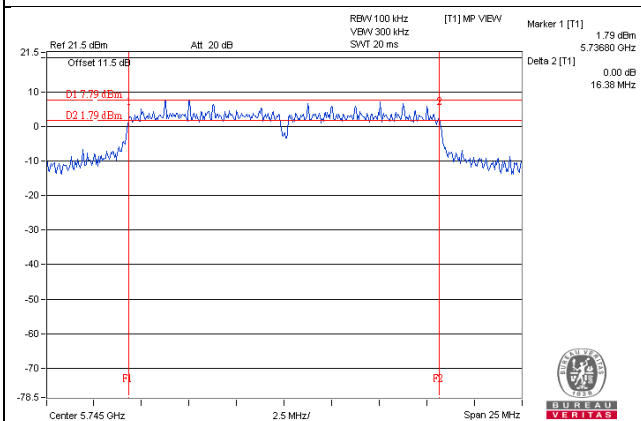

#### 802.11ac (VHT20) / CH157

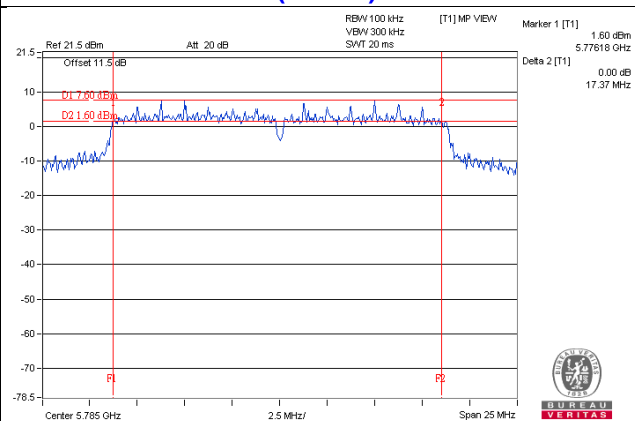

#### 802.11ac (VHT40) / CH151

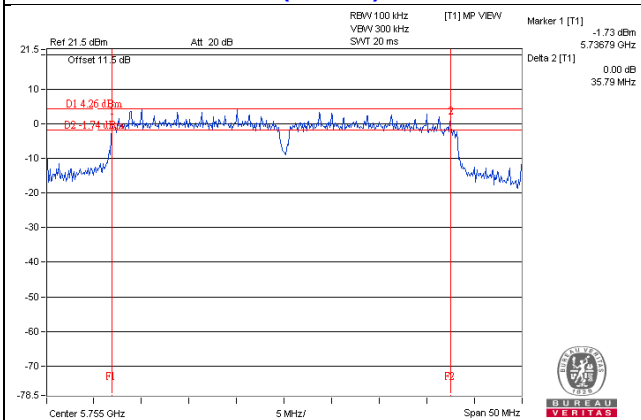

#### 802.11ac (VHT80) / CH155

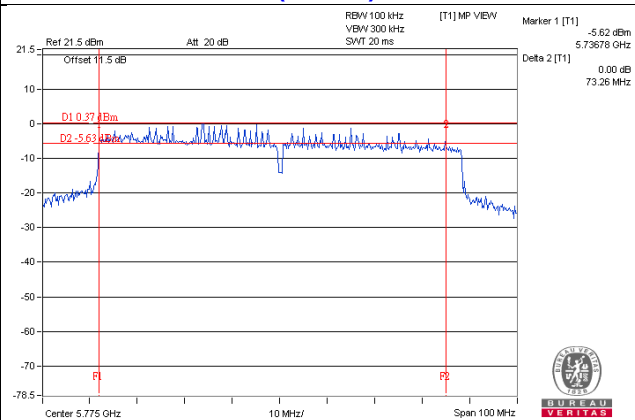



## 5 Pictures of Test Arrangements

Please refer to the attached file (Test Setup Photo).

## Annex A- Radiated Out of Band Emission (OOBE) Measurement (For U-NII-3 band)

### Radio 2

#### 802.11a

#### CH 149 5745 MHz

Horizontal

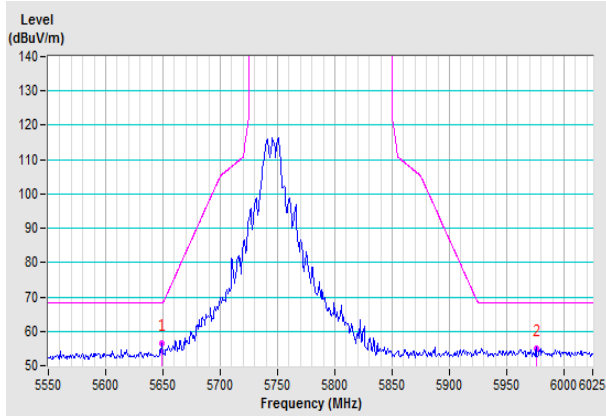

Vertical

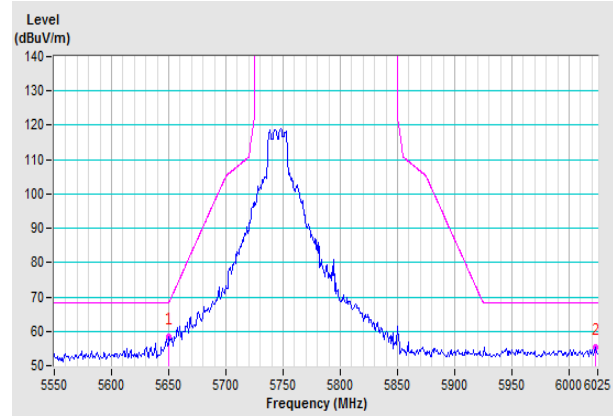

#### CH 157 5785 MHz

Horizontal

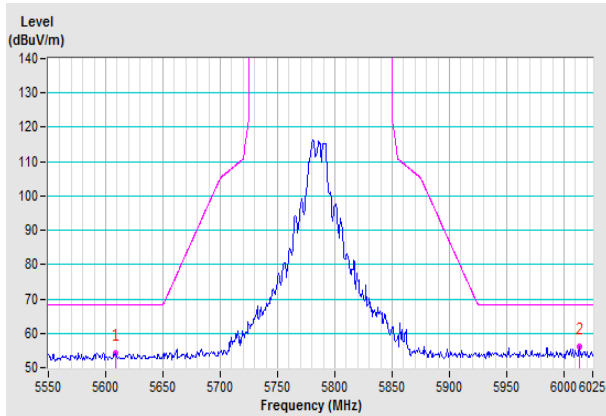

Vertical

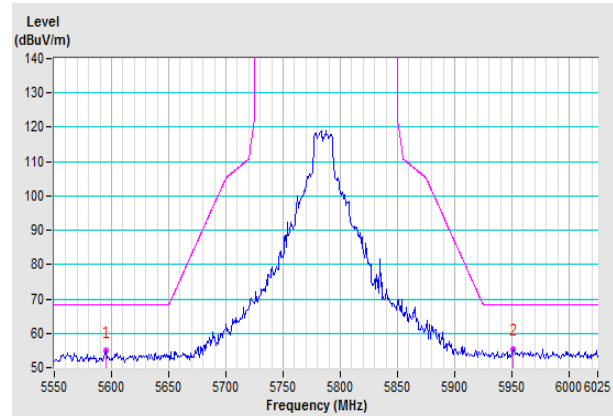

#### CH 165 5825 MHz

Horizontal

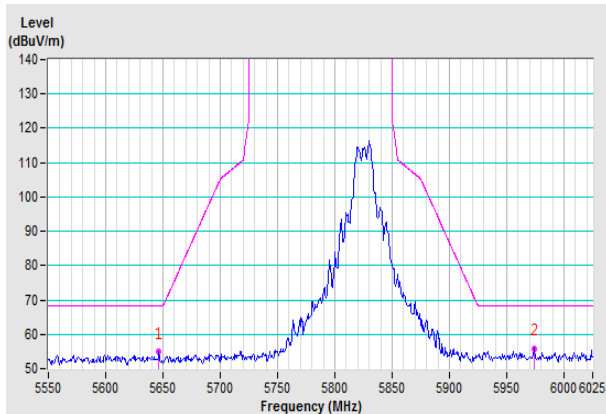

Vertical

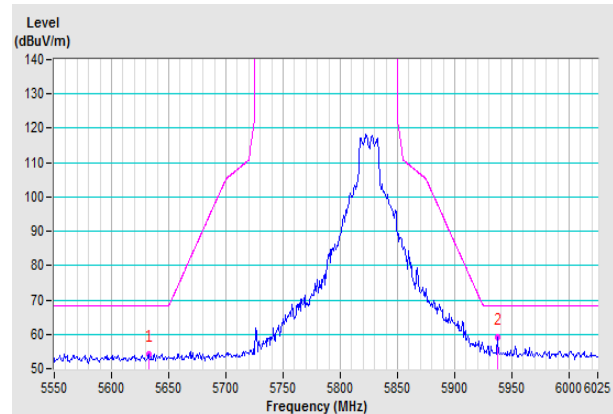

802.11ac (VHT20)

CH 149 5745 MHz

Horizontal

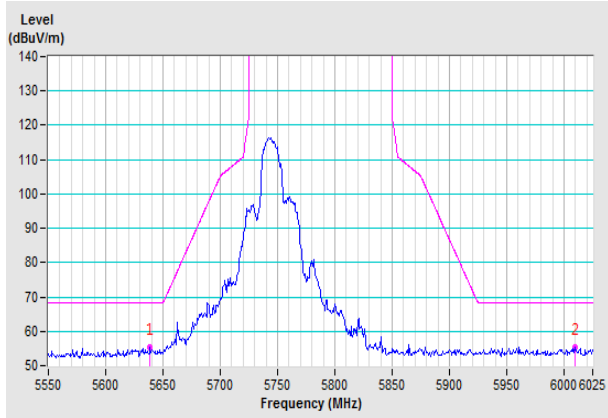

Vertical

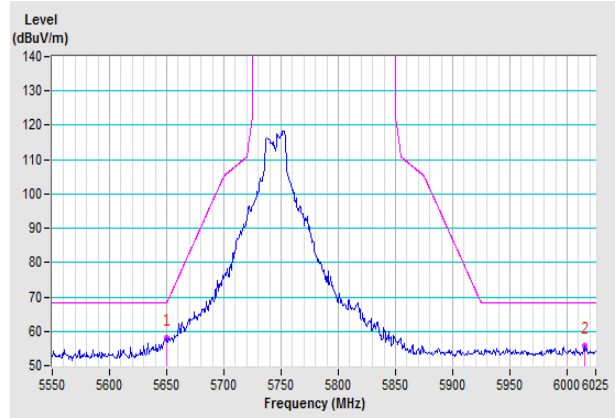

CH 157 5785 MHz

Horizontal

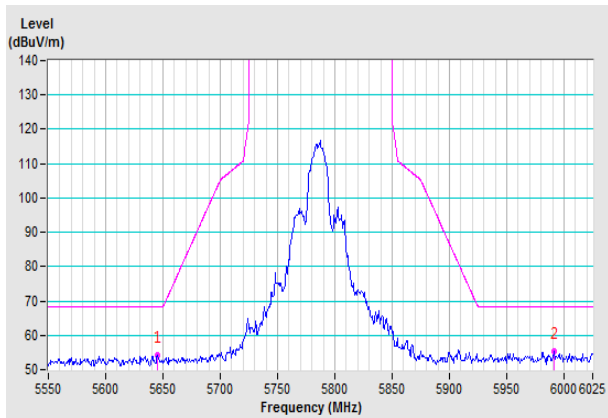

Vertical

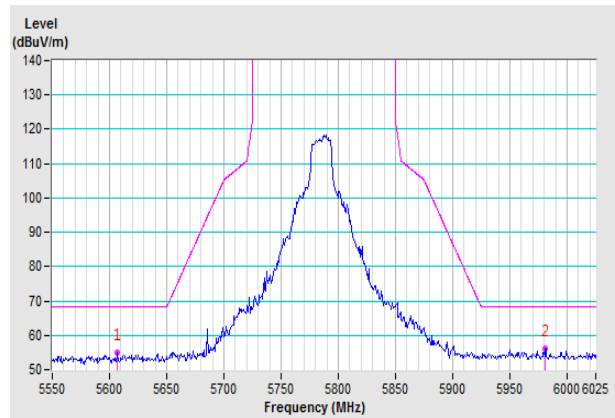

CH 165 5825 MHz

Horizontal

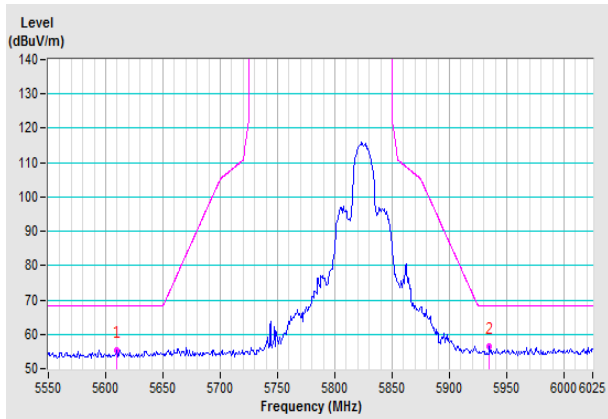

Vertical

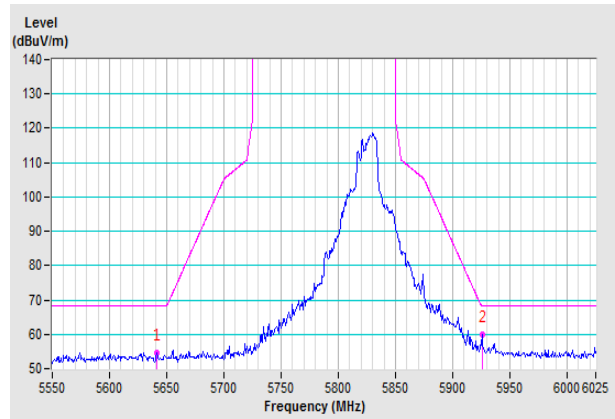

802.11ac (VHT40)

CH 151 5755 MHz

Horizontal

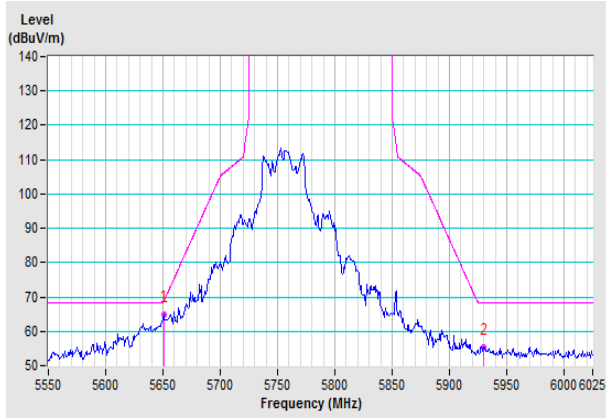

Vertical

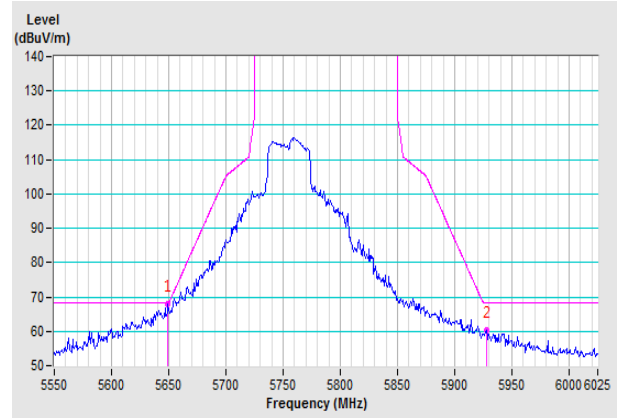

CH 159 5795 MHz

Horizontal

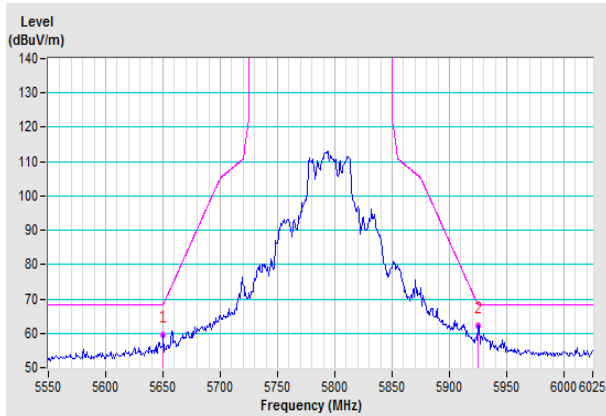

Vertical

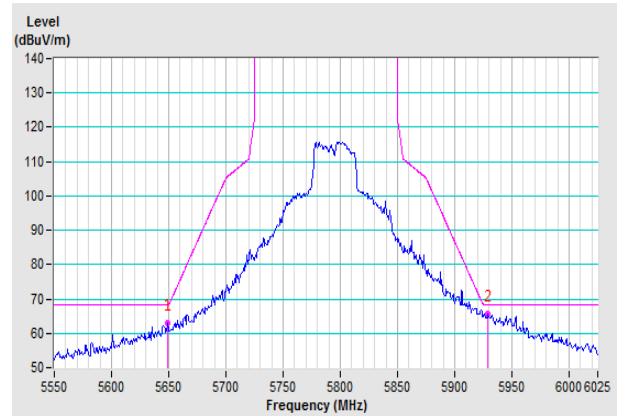

802.11ac (VHT80)

CH 155 5775 MHz

Horizontal

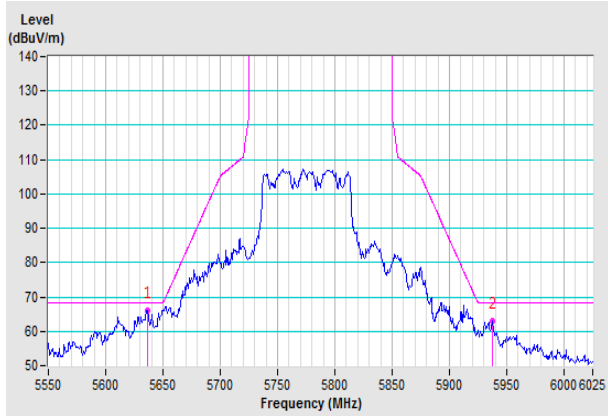

Vertical

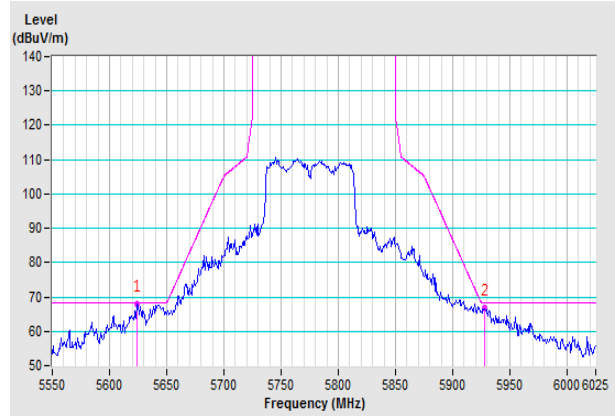

**Radio 3**

802.11a

**CH 149 5745 MHz**

**Horizontal**

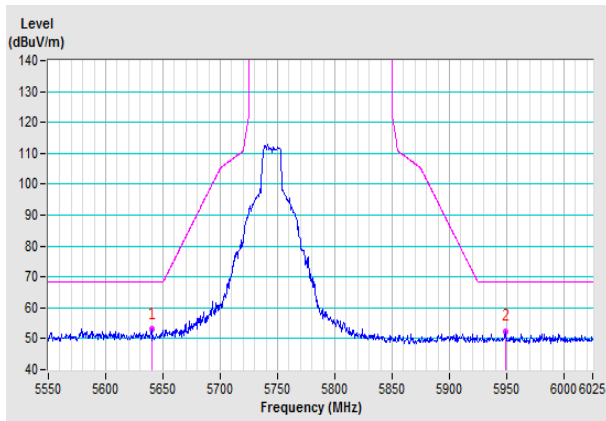

**Vertical**

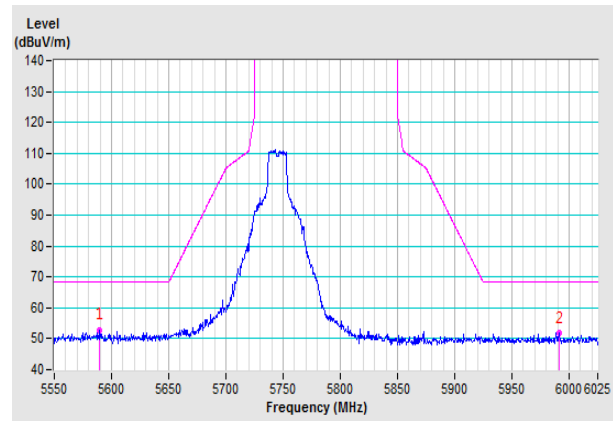

**CH 157 5785 MHz**

**Horizontal**

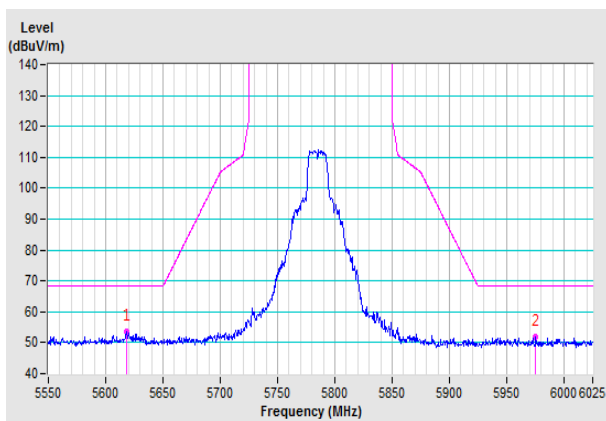

**Vertical**

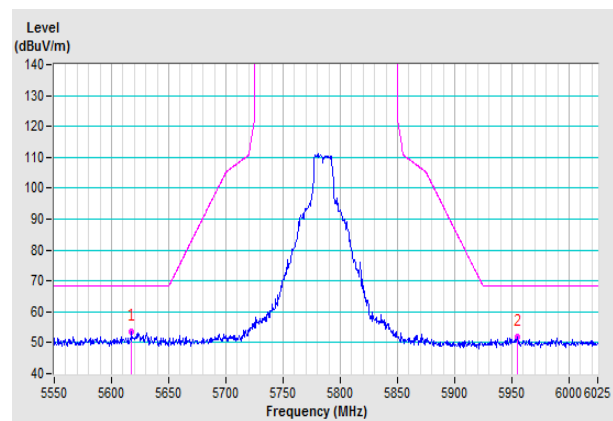

**CH 165 5825 MHz**

**Horizontal**

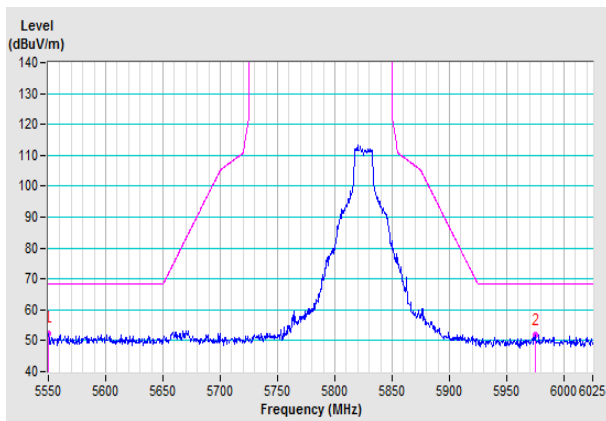

**Vertical**

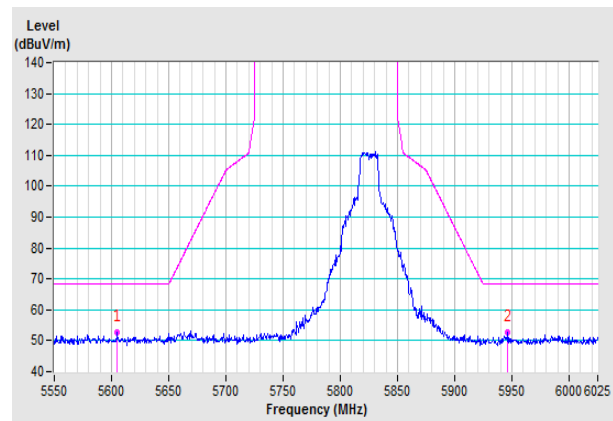

### 802.11ac (VHT20)

#### CH 149 5745 MHz

**Horizontal**

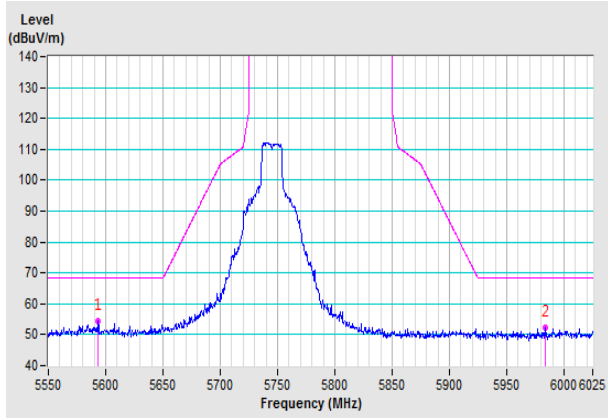

**Vertical**

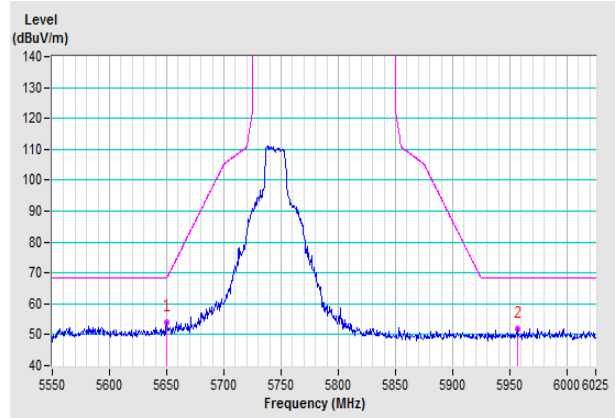

#### CH 157 5785 MHz

**Horizontal**

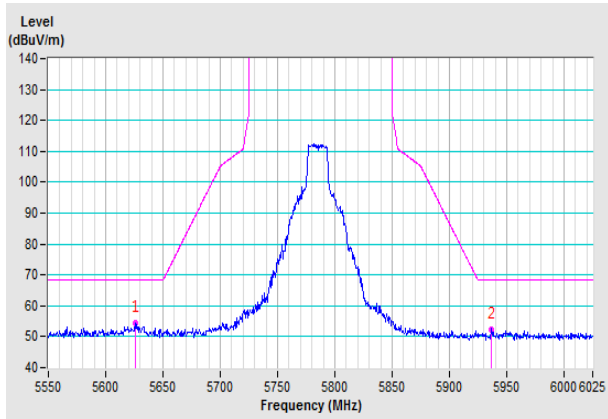

**Vertical**

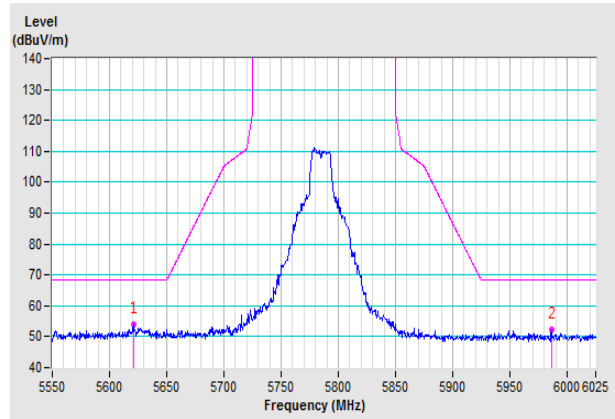

#### CH 165 5825 MHz

**Horizontal**

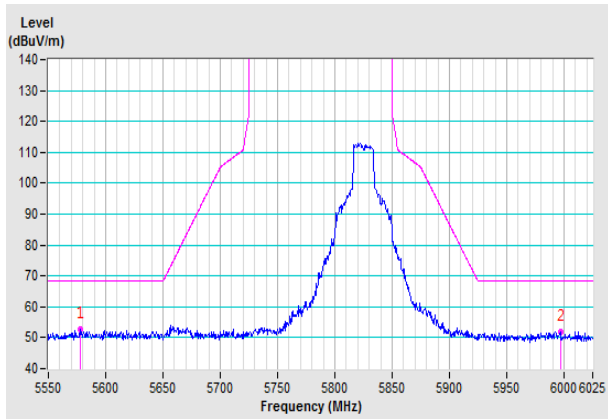

**Vertical**

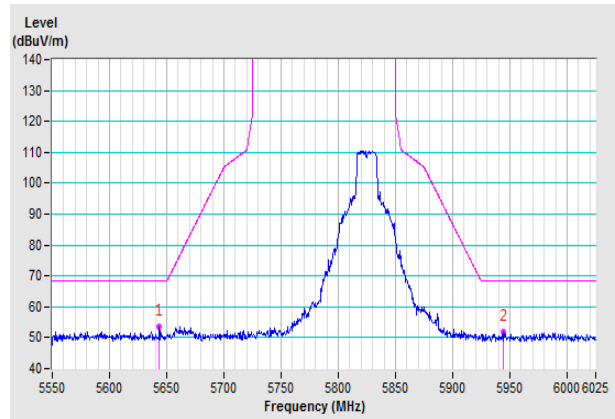

802.11ac (VHT40)

CH 151 5755 MHz

Horizontal

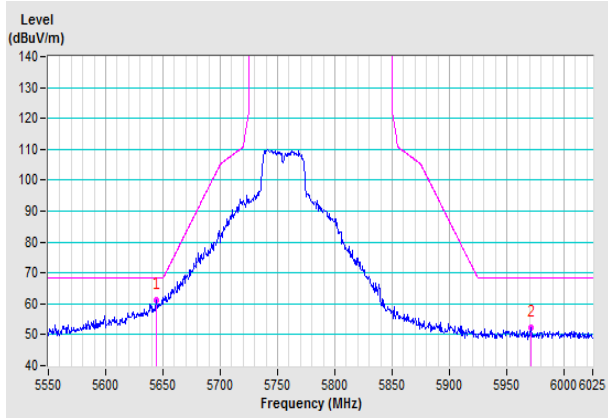

Vertical

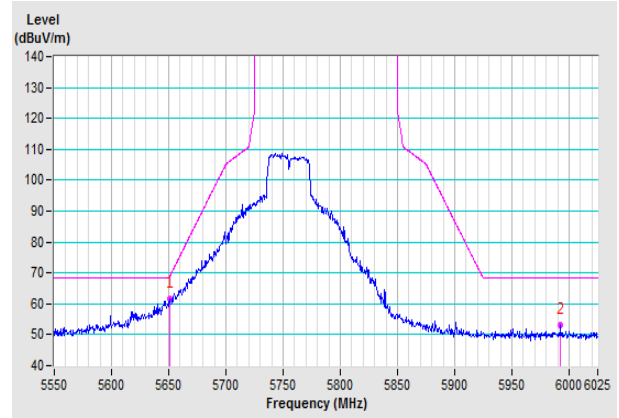

CH 159 5795 MHz

Horizontal

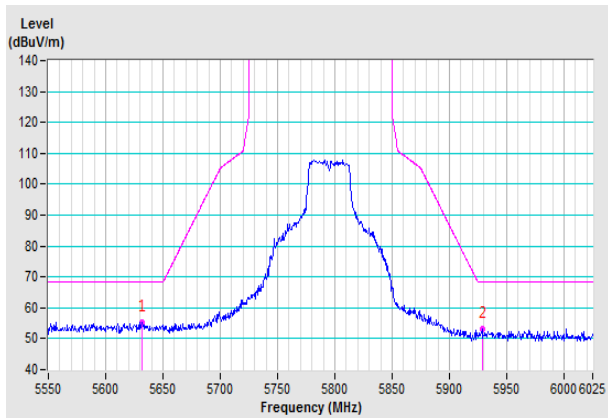

Vertical

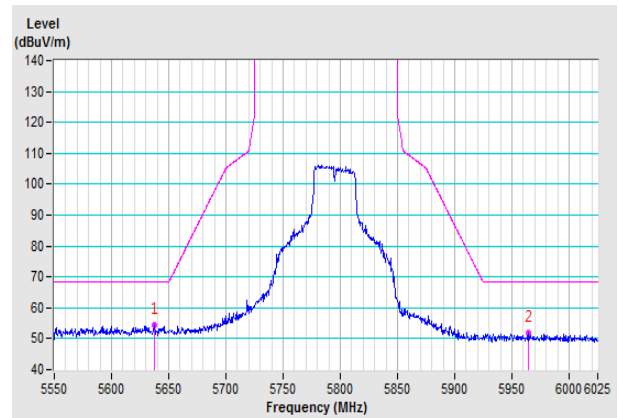



802.11ac (VHT80)

CH 155 5775 MHz

Horizontal

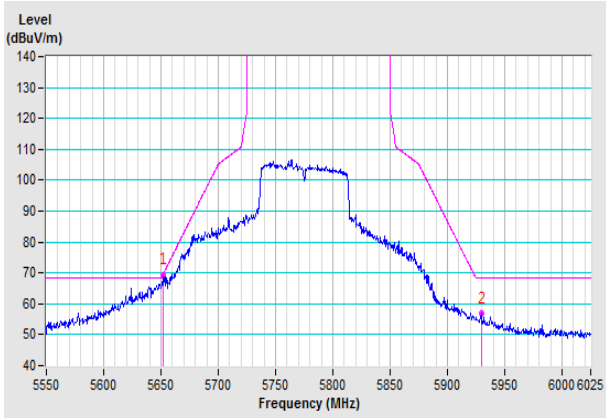

Vertical

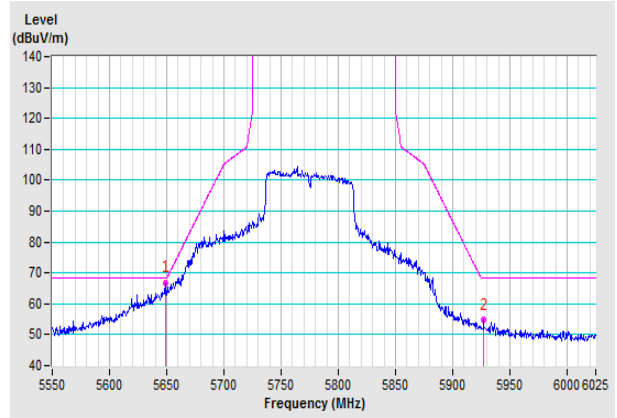

## Appendix – Information on the Testing Laboratories

We, Bureau Veritas Consumer Products Services (H.K.) Ltd., Taoyuan Branch, were founded in 1988 to provide our best service in EMC, Radio, Telecom and Safety consultation. Our laboratories are FCC recognized accredited test firms and accredited according to ISO/IEC 17025.

If you have any comments, please feel free to contact us at the following:

**Linkou EMC/RF Lab**

Tel: 886-2-26052180

Fax: 886-2-26051924

**Hsin Chu EMC/RF/Telecom Lab**

Tel: 886-3-6668565

Fax: 886-3-6668323

**Hwa Ya EMC/RF/Safety Lab**

Tel: 886-3-3183232

Fax: 886-3-3270892

**Email:** [service.adt@tw.bureauveritas.com](mailto:service.adt@tw.bureauveritas.com)

**Web Site:** [www.bureauveritas-adt.com](http://www.bureauveritas-adt.com)

The address and road map of all our labs can be found in our web site also.

--- END ---