

FCC Test Report

Report No.: RF170825E04-1

FCC ID: UXX-S5A741A

Test Model: S5A741A

Received Date: Aug. 25, 2017

Test Date: Sep. 22 to Oct. 03, 2017

Issued Date: Oct. 16, 2017

Applicant: Cradlepoint, Inc

Address: 1111 W. Jefferson Street Suite 400 Boise, ID 83702 USA

Issued By: Bureau Veritas Consumer Products Services (H.K.) Ltd., Taoyuan Branch
Hsin Chu Laboratory

Lab Address: E-2, No.1, Li Hsin 1st Road, Hsinchu Science Park, Hsinchu City 300,
Taiwan R.O.C.

Test Location : E-2, No.1, Li Hsin 1st Road, Hsinchu Science Park, Hsinchu City 300,
Taiwan R.O.C.



This report is for your exclusive use. Any copying or replication of this report to or for any other person or entity, or use of our name or trademark, is permitted only with our prior written permission. This report sets forth our findings solely with respect to the test samples identified herein. The results set forth in this report are not indicative or representative of the quality or characteristics of the lot from which a test sample was taken or any similar or identical product unless specifically and expressly noted. Our report includes all of the tests requested by you and the results thereof based upon the information that you provided to us. You have 60 days from date of issuance of this report to notify us of any material error or omission caused by our negligence, provided, however, that such notice shall be in writing and shall specifically address the issue you wish to raise. A failure to raise such issue within the prescribed time shall constitute your unqualified acceptance of the completeness of this report, the tests conducted and the correctness of the report contents. Unless specific mention, the uncertainty of measurement has been explicitly taken into account to declare the compliance or non-compliance to the specification. The report must not be used by the client to claim product certification, approval, or endorsement by TAF or any government agencies.

Table of Contents

Release Control Record	4
1 Certificate of Conformity	5
2 Summary of Test Results	6
2.1 Measurement Uncertainty	6
2.2 Modification Record	6
3 General Information	7
3.1 General Description of EUT	7
3.2 Description of Test Modes	12
3.2.1 Test Mode Applicability and Tested Channel Detail	13
3.3 Duty Cycle of Test Signal	17
3.4 Description of Support Units	18
3.4.1 Configuration of System under Test	19
3.5 General Description of Applied Standard	21
4 Test Types and Results	22
4.1 Radiated Emission and Bandedge Measurement	22
4.1.1 Limits of Radiated Emission and Bandedge Measurement	22
4.1.2 Test Instruments	23
4.1.3 Test Procedure	25
4.1.4 Deviation from Test Standard	25
4.1.5 Test Setup	26
4.1.6 EUT Operating Condition	27
4.1.7 Test Results (Mode 1)	28
4.1.8 Test Results (Mode 3)	47
4.2 Conducted Emission Measurement	66
4.2.1 Limits of Conducted Emission Measurement	66
4.2.2 Test Instruments	66
4.2.3 Test Procedure	67
4.2.4 Deviation from Test Standard	67
4.2.5 Test Setup	67
4.2.6 EUT Operating Condition	67
4.2.7 Test Results (Mode 1)	68
4.2.8 Test Results (Mode 2)	70
4.2.9 Test Results (Mode 3)	72
4.2.10 Test Results (Mode 4)	74
4.3 Transmit Power Measurement	76
4.3.1 Limits of Transmit Power Measurement	76
4.3.2 Test Setup	76
4.3.3 Test Instruments	76
4.3.4 Test Procedure	76
4.3.5 Deviation from Test Standard	76
4.3.6 EUT Operating Condition	76
4.3.7 Test Result (Mode 1)	77
4.3.8 Test Result (Mode 3)	83
4.4 Occupied Bandwidth Measurement	87
4.4.1 Test Setup	87
4.4.2 Test Instruments	87
4.4.3 Test Procedure	87
4.4.4 Test Results (Mode 1)	88
4.4.5 Test Results (Mode 3)	94
4.5 Peak Power Spectral Density Measurement	102
4.5.1 Limits of Peak Power Spectral Density Measurement	102
4.5.2 Test Setup	102
4.5.3 Test Instruments	102

4.5.4	Test Procedure	103
4.5.5	Deviation from Test Standard	103
4.5.6	EUT Operating Condition	103
4.5.7	Test Results (Mode 1).....	104
4.5.8	Test Results (Mode 3).....	116
4.6	Frequency Stability Measurement.....	132
4.6.1	Limits of Frequency Stability Measurement	132
4.6.2	Test Setup.....	132
4.6.3	Test Instruments	132
4.6.4	Test Procedure	132
4.6.5	Deviation from Test Standard	132
4.6.6	EUT Operating Condition	132
4.6.7	Test Results (Mode 1).....	133
4.6.8	Test Results (Mode 3).....	134
4.7	6dB Bandwidth Measurement.....	135
4.7.1	Limits of 6dB Bandwidth Measurement.....	135
4.7.2	Test Setup.....	135
4.7.3	Test Instruments	135
4.7.4	Test Procedure	135
4.7.5	Deviation from Test Standard	135
4.7.6	EUT Operating Condition	135
4.7.7	Test Results (Mode 1).....	136
4.7.8	Test Results (Mode 3).....	138
5	Pictures of Test Arrangements.....	140
	Annex A- Radiated Out of Band Emission (OOBE) Measurement (For U-NII-3 band)	141
	Appendix – Information on the Testing Laboratories	147

Release Control Record

Issue No.	Description	Date Issued
RF170825E04-1	Original release.	Oct. 16, 2017

1 Certificate of Conformity

Product: Integrated Mobile Broadband Router

Brand: cradlepoint

Test Model: S5A741A

Sample Status: ENGINEERING SAMPLE

Applicant: Cradlepoint, Inc

Test Date: Sep. 22 to Oct. 03, 2017

Standard: 47 CFR FCC Part 15, Subpart E (Section 15.407)
ANSI C63.10: 2013

The above equipment has been tested by **Bureau Veritas Consumer Products Services (H.K.) Ltd., Taoyuan Branch**, and found compliance with the requirement of the above standards. The test record, data evaluation & Equipment Under Test (EUT) configurations represented herein are true and accurate accounts of the measurements of the sample's EMC characteristics under the conditions specified in this report.

Prepared by : Wendy Wu , **Date:** Oct. 16, 2017
Wendy Wu / Specialist

Approved by : May Chen , **Date:** Oct. 16, 2017
May Chen / Manager

2 Summary of Test Results

47 CFR FCC Part 15, Subpart E (Section 15.407)			
FCC Clause	Test Item	Result	Remarks
15.407(b)(6)	AC Power Conducted Emissions	Pass	Meet the requirement of limit. Minimum passing margin is -17.95dB at 22.69922MHz.
15.407(b) (1/2/3/4(i/ii)/6)	Radiated Emissions & Band Edge Measurement*	Pass	Meet the requirement of limit. Minimum passing margin is -0.1dB at 5150.00MHz, 5925.73MHz.
15.407(a)(1/2/3)	Max Average Transmit Power	Pass	Meet the requirement of limit.
---	Occupied Bandwidth Measurement	-	Reference only.
15.407(a)(1/2/3)	Peak Power Spectral Density	Pass	Meet the requirement of limit.
15.407(e)	6dB bandwidth	Pass	Meet the requirement of limit. (U-NII-3 Band only)
15.407(g)	Frequency Stability	Pass	Meet the requirement of limit.
15.203	Antenna Requirement	Pass	Antenna connector is R-SMA not a standard connector.

*For U-NII-3 band compliance with rule part 15.407(b)(4)(i), the OOB test plots were recorded in Annex A.

2.1 Measurement Uncertainty

Where relevant, the following measurement uncertainty levels have been estimated for tests performed on the EUT as specified in CISPR 16-4-2:

Measurement	Frequency	Expanded Uncertainty (k=2) (±)
Conducted Emissions at mains ports	150kHz ~ 30MHz	1.84 dB
Radiated Emissions up to 1 GHz	30MHz ~ 1GHz	5.30 dB
Radiated Emissions above 1 GHz	1GHz ~ 6GHz	5.16 dB
	6GHz ~ 18GHz	4.91 dB
	18GHz ~ 40GHz	5.30 dB

2.2 Modification Record

There were no modifications required for compliance.

3 General Information

3.1 General Description of EUT

Product	Integrated Mobile Broadband Router
Brand	cradlepoint
Test Model	S5A741A
Status of EUT	ENGINEERING SAMPLE
Power Supply Rating	DC 9-36V, 5A
Modulation Type	CCK, DQPSK, DBPSK for DSSS 64QAM, 16QAM, QPSK, BPSK for OFDM 256QAM for OFDM in 11ac mode and VHT20/40 mode in 2.4GHz band
Modulation Technology	DSSS, OFDM
Transfer Rate	802.11b: up to 11Mbps 802.11a/g: up to 54Mbps 802.11n: up to 600Mbps 802.11ac: up to 1733.3Mbps
Operating Frequency	2.4GHz: 2.412 ~ 2.462GHz 5GHz: 5.18GHz ~ 5.24GHz, 5.745GHz ~ 5.825GHz
Number of Channel	2.4GHz: 802.11b, 802.11g, 802.11n (HT20), VHT20: 11 802.11n (HT40), VHT40: 7 5GHz: 802.11a, 802.11n (HT20), 802.11ac (VHT20): 9 802.11n (HT40), 802.11ac (VHT40): 4 802.11ac (VHT80): 2
Output Power	Radio 1 2.4GHz: CDD Mode: 833.916mW Beamforming Mode: 734.744mW 5.18 ~ 5.24GHz Master Mode CDD Mode: 681.538mW Beamforming Mode: 610.962mW Client Mode CDD Mode: 207.519mW Beamforming Mode: 205.918mW 5.745 ~ 5.825GHz Master Mode CDD Mode: 873.145mW Beamforming Mode: 846.325mW Client Mode CDD Mode: 873.145mW Beamforming Mode: 846.325mW Radio 2 5.18 ~ 5.24GHz Master Mode CDD Mode: 789.037mW Beamforming Mode: 428.397mW Client Mode CDD Mode: 214.49mW Beamforming Mode: 108.001mW 5.745 ~ 5.825GHz Master Mode CDD Mode: 996.851mW Beamforming Mode: 432.56mW Client Mode CDD Mode: 996.851mW Beamforming Mode: 432.56mW

Antenna Type	Refer to Note
Antenna Connector	Refer to Note
Accessory Device	NA
Data Cable Supplied	DC cable (4 pin) x 1 (Unshielding, 2m) DC COR Power & GPIO Cable (2x10 pin) x 1 (Unshielding, 2m)

Note:

1. There are WLAN, 3G/LTE and GPS technology used for the EUT.
2. The EUT contains certified 3G/LTE modular which FCC ID: RI7LM940.
3. Simultaneously transmission condition.

Condition	Technology		
1	WLAN (Radio 1) (2.4GHz + 5GHz)	WLAN (Radio 2) (5GHz)	WWAN (Radio 3) 3G/LTE

Note: The emission of the simultaneous operation has been evaluated and no non-compliance was found.

4. The antennas provided to the EUT, please refer to the following table:

WLAN										
Ant Set.	Transmitter Circuit			Model	Frequency range (GHz)	Antenna Type	Connecter Type	Cable Length (mm)	Cable Loss(dB)	excluding cable loss Antenna Gain(dBi)
	Radio 1		Radio 2							
	2.4G	5G	5G							
1	GPIO 0 Chain0	Chain1	-	RFA-25-F17M3-B70-25	2.4~2.4835 5.15~5.85	Dipole	R-SMA	230	0.8 1.4	2.5 3.5
	GPIO 0 Chain1	Chain0	-		2.4~2.4835 5.15~5.85	Dipole	R-SMA	230	0.8 1.4	2.5 3.5
	GPIO 1 Chain1	-	Chain2		2.4~2.4835 5.15~5.85	Dipole	R-SMA	230	0.8 1.4	2.5 3.5
	-	-	Chain3		2.4~2.4835 5.15~5.85	Dipole	R-SMA	230	0.8 1.4	2.5 3.5
	-	-	Chain0		2.4~2.4835 5.15~5.85	Dipole	R-SMA	230	0.8 1.4	2.5 3.5
	GPIO 1 Chain0	-	Chain1		2.4~2.4835 5.15~5.85	Dipole	R-SMA	230	0.8 1.4	2.5 3.5
2	GPIO 0 Chain0	Chain1	-	TWX-1513RSXX-711	2.4~2.4835 5.15~5.85	Dipole	R-SMA	230	0.8 1.4	5 5
	GPIO 0 Chain1	Chain0	-		2.4~2.4835 5.15~5.85	Dipole	R-SMA	230	0.8 1.4	5 5
	GPIO 1 Chain1	-	Chain2		2.4~2.4835 5.15~5.85	Dipole	R-SMA	230	0.8 1.4	5 5
	-	-	Chain3		2.4~2.4835 5.15~5.85	Dipole	R-SMA	230	0.8 1.4	5 5
	-	-	Chain0		2.4~2.4835 5.15~5.85	Dipole	R-SMA	230	0.8 1.4	5 5
	GPIO 1 Chain0	-	Chain1		2.4~2.4835 5.15~5.85	Dipole	R-SMA	230	0.8 1.4	5 5
3G/LTE										
Ant Set.	Transmitter Circuit	Model	Antenna Gain with cable		Frequency range	Antenna Type	Connecter Type	Cable Length (mm)	Cable Loss (dB)	
			including cable loss							
1	Main	YWX-6252SABX-711	1.0dBi@2300~2320MHz 2dBi@690~2300MHz 3dBi@2320~2700MHz	2300~2320MHz 690~2300MHz 2320~2700MHz	Dipole	SMA	230	0~1G 0.5dB 1~3G 0.9dB		
	Aux	YWX-6252SABX-711	1.0dBi@2300~2320MHz 2dBi@690~2300MHz 3dBi@2320~2700MHz	2300~2320MHz 690~2300MHz 2320~2700MHz	Dipole	SMA	230	0~1G 0.5dB 1~3G 0.9dB		
2	Main	YWX-6241SAXX-711D	1.0dBi@2300~2320MHz 2dBi@690~2300MHz 3dBi@2320~2700MHz	2300~2320MHz 690~2300MHz 2320~2700MHz	Dipole	SMA	230	0~1G 0.5dB 1~3G 0.9dB		
	Aux	YWX-6241SAXX-711D	1.0dBi@2300~2320MHz 2dBi@690~2300MHz 3dBi@2320~2700MHz	2300~2320MHz 690~2300MHz 2320~2700MHz	Dipole	SMA	230	0~1G 0.5dB 1~3G 0.9dB		
GPS										
Antenna Gain with cable			Frequency range		Antenna Type	Connecter Type				
including cable loss										
GPS: 1.36dBi GLONASS: 0.09dBi			GPS: 1574.42MHz±3MHz GLONASS: 1602MHz±0.5MHz		Dipole	SMA				

Note:

- For WLAN: Ant set 2 was selected for the final test.
- For 2.4GHz configuration mode, GPIO 0 and GPIO 1 were pre-tested and the worst case was found in GPIO 0, therefore only the test data of the modes were recorded in this report.

5. The EUT incorporates a MIMO function:

2.4GHz Band			
MODULATION MODE	DATA RATE (MCS)	TX & RX CONFIGURATION	
802.11b	1 ~ 11Mbps	2TX	2RX
802.11g	6 ~ 54Mbps	2TX	2RX
802.11n (HT20)	MCS 0~7	2TX	2RX
	MCS 8~15	2TX	2RX
802.11n (HT40)	MCS 0~7	2TX	2RX
	MCS 8~15	2TX	2RX
VHT20	MCS0~8 Nss=1	2TX	2RX
	MCS0~8 Nss=2	2TX	2RX
VHT40	MCS0~9 Nss=1	2TX	2RX
	MCS0~9 Nss=2	2TX	2RX
5GHz Band (Radio 1)			
MODULATION MODE	DATA RATE (MCS)	TX & RX CONFIGURATION	
802.11a	6 ~ 54Mbps	2TX	2RX
802.11n (HT20)	MCS 0~7	2TX	2RX
	MCS 8~15	2TX	2RX
802.11n (HT40)	MCS 0~7	2TX	2RX
	MCS 8~15	2TX	2RX
802.11ac (VHT20)	MCS0~8 Nss=1	2TX	2RX
	MCS0~8 Nss=2	2TX	2RX
802.11ac (VHT40)	MCS0~9 Nss=1	2TX	2RX
	MCS0~9 Nss=2	2TX	2RX
802.11ac (VHT80)	MCS0~9 Nss=1	2TX	2RX
	MCS0~9 Nss=2	2TX	2RX
5GHz Band (Radio 2)			
MODULATION MODE	DATA RATE (MCS)	TX & RX CONFIGURATION	
802.11a	6 ~ 54Mbps	4TX	4RX
802.11n (HT20)	MCS 0~7	4TX	4RX
	MCS 8~15	4TX	4RX
	MCS 16~23	4TX	4RX
	MCS 24~31	4TX	4RX
802.11n (HT40)	MCS 0~7	4TX	4RX
	MCS 8~15	4TX	4RX
	MCS 16~23	4TX	4RX
802.11ac (VHT20)	MCS 0~8, Nss=1	4TX	4RX
	MCS 0~8, Nss=2	4TX	4RX
	MCS 0~9, Nss=3	4TX	4RX
	MCS 0~8, Nss=4	4TX	4RX
802.11ac (VHT40)	MCS 0~9, Nss=1	4TX	4RX
	MCS 0~9, Nss=2	4TX	4RX
	MCS 0~9, Nss=3	4TX	4RX
	MCS 0~9, Nss=4	4TX	4RX
802.11ac (VHT80)	MCS 0~9, Nss=1	4TX	4RX
	MCS 0~9, Nss=2	4TX	4RX
	MCS 0~9, Nss=3	4TX	4RX
	MCS 0~9, Nss=4	4TX	4RX

Note:

- All of modulation mode support beamforming function except 802.11a/b/g modulation mode.
- The EUT support Beamforming and CDD mode, therefore both mode were investigated and the worst case scenario was identified. The worst case data were presented in test report.
- The modulation and bandwidth are similar for 802.11n mode for 20MHz (40MHz) and 802.11ac mode for 20MHz (40MHz), therefore investigated worst case to representative mode in test report. (Final test mode refer section 3.2.1)

6. EUT has been pre-tested under following pre-test modes.

Pre-test Mode	Power
Mode A	DC cable (4 pin)
Mode B	DC COR Power & GPIO Cable (2x10 pin)

Note: From the above modes, the radiated emission worse case was found in **Mode A**. Therefore only the test data of the mode was recorded in this report.

7. This device can support different category application which switched by access point mode and client mode by software.
8. The above EUT information is declared by manufacturer and for more detailed features description, please refer to the manufacturer's specifications or user's manual.

3.2 Description of Test Modes

FOR 5180 ~ 5240MHz

4 channels are provided for 802.11a, 802.11n (HT20), 802.11ac (VHT20):

Channel	Frequency	Channel	Frequency
36	5180MHz	44	5220MHz
40	5200MHz	48	5240MHz

2 channels are provided for 802.11n (HT40), 802.11ac (VHT40):

Channel	Frequency	Channel	Frequency
38	5190MHz	46	5230MHz

1 channel is provided for 802.11ac (VHT80):

Channel	Frequency
42	5210MHz

FOR 5745 ~ 5825MHz:

5 channels are provided for 802.11a, 802.11n (HT20), 802.11ac (VHT20):

Channel	Frequency	Channel	Frequency
149	5745MHz	161	5805MHz
153	5765MHz	165	5825MHz
157	5785MHz		

2 channels are provided for 802.11n (HT40), 802.11ac (VHT40):

Channel	Frequency	Channel	Frequency
151	5755MHz	159	5795MHz

1 channel is provided for 802.11ac (VHT80):

Channel	Frequency
155	5775MHz

3.2.1 Test Mode Applicability and Tested Channel Detail

EUT Configure Mode	Applicable To				Description
	RE \geq 1G	RE $<$ 1G	PLC	APCM	
1	√	√	√	√	Radio 1 with DC cable (4 pin)
2	-	-	√	-	Radio 1 with DC COR Power & GPIO Cable (2x10 pin)
3	√	√	√	√	Radio 2 with DC cable (4 pin)
4	-	-	√	-	Radio 2 with DC COR Power & GPIO Cable (2x10 pin)

Where **RE \geq 1G**: Radiated Emission above 1GHz **RE $<$ 1G**: Radiated Emission below 1GHz
PLC: Power Line Conducted Emission **APCM**: Antenna Port Conducted Measurement

NOTE:

1. The EUT had been pre-tested on the positioned of each 3 axis. The worst case was found when positioned on **X-plane**.
2. “-” means no effect.

Radiated Emission Test (Above 1GHz):

- Pre-Scan has been conducted to determine the worst-case mode from all possible combinations between available modulations, data rates and antenna ports (if EUT with antenna diversity architecture).
- Following channel(s) was (were) selected for the final test as listed below.

Radio 1 / Radio 2 / CDD Mode						
Mode	FREQ. Band (MHz)	Available Channel	Tested Channel	Modulation Technology	Modulation Type	Data Rate (Mbps)
802.11a	5180-5240	36 to 48	36, 40, 48	OFDM	BPSK	6
802.11ac (VHT20)		36 to 48	36, 40, 48	OFDM	BPSK	6.5
802.11ac (VHT40)		38 to 46	38, 46	OFDM	BPSK	13.5
802.11ac (VHT80)		42	42	OFDM	BPSK	29.3
802.11a	5745-5825	149 to 165	149, 157, 165	OFDM	BPSK	6
802.11ac (VHT20)		149 to 165	149, 157, 165	OFDM	BPSK	6.5
802.11ac (VHT40)		151 to 159	151, 159	OFDM	BPSK	13.5
802.11ac (VHT80)		155	155	OFDM	BPSK	29.3

Radiated Emission Test (Below 1GHz):

- Pre-Scan has been conducted to determine the worst-case mode from all possible combinations between available modulations, data rates and antenna ports (if EUT with antenna diversity architecture).
- Following channel(s) was (were) selected for the final test as listed below.

Radio 1 / CDD Mode						
Mode	FREQ. Band (MHz)	Available Channel	Tested Channel	Modulation Technology	Modulation Type	Data Rate (Mbps)
802.11a	5180-5240 5745-5825	36 to 48 149 to 165	40	OFDM	BPSK	6

Radio 2 / CDD Mode						
Mode	FREQ. Band (MHz)	Available Channel	Tested Channel	Modulation Technology	Modulation Type	Data Rate (Mbps)
802.11ac (VHT20)	5180-5240 5745-5825	36 to 48 149 to 165	165	OFDM	BPSK	6.5

Power Line Conducted Emission Test:

- Pre-Scan has been conducted to determine the worst-case mode from all possible combinations between available modulations, data rates and antenna ports (if EUT with antenna diversity architecture).
- Following channel(s) was (were) selected for the final test as listed below.

Radio 1 / CDD Mode						
Mode	FREQ. Band (MHz)	Available Channel	Tested Channel	Modulation Technology	Modulation Type	Data Rate (Mbps)
802.11a	5180-5240 5745-5825	36 to 48 149 to 165	40	OFDM	BPSK	6
Radio 2 / CDD Mode						
Mode	FREQ. Band (MHz)	Available Channel	Tested Channel	Modulation Technology	Modulation Type	Data Rate (Mbps)
802.11ac (VHT20)	5180-5240 5745-5825	36 to 48 149 to 165	165	OFDM	BPSK	6.5

Antenna Port Conducted Measurement:

- This item includes all test value of each mode, but only includes spectrum plot of worst value of each mode.
- Pre-Scan has been conducted to determine the worst-case mode from all possible combinations between available modulations, data rates and antenna ports (if EUT with antenna diversity architecture).
- Following channel(s) was (were) selected for the final test as listed below.

Radio 1 / Radio 2 / CDD Mode / Master Mode						
Mode	FREQ. Band (MHz)	Available Channel	Tested Channel	Modulation Technology	Modulation Type	Data Rate (Mbps)
802.11a	5180-5240	36 to 48	36, 40, 48	OFDM	BPSK	6
802.11ac (VHT20)		36 to 48	36, 40, 48	OFDM	BPSK	6.5
802.11ac (VHT40)		38 to 46	38, 46	OFDM	BPSK	13.5
802.11ac (VHT80)		42	42	OFDM	BPSK	29.3
802.11a	5745-5825	149 to 165	149, 157, 165	OFDM	BPSK	6
802.11ac (VHT20)		149 to 165	149, 157, 165	OFDM	BPSK	6.5
802.11ac (VHT40)		151 to 159	151, 159	OFDM	BPSK	13.5
802.11ac (VHT80)		155	155	OFDM	BPSK	29.3
Radio 1 / Radio 2 / CDD Mode / Client Mode						
Mode	FREQ. Band (MHz)	Available Channel	Tested Channel	Modulation Technology	Modulation Type	Data Rate (Mbps)
802.11a	5180-5240	36 to 48	36, 40, 48	OFDM	BPSK	6
802.11ac (VHT20)		36 to 48	36, 40, 48	OFDM	BPSK	6.5
802.11ac (VHT40)		38 to 46	38, 46	OFDM	BPSK	13.5
802.11ac (VHT80)		42	42	OFDM	BPSK	29.3
802.11a	5745-5825	149 to 165	149, 157, 165	OFDM	BPSK	6
802.11ac (VHT20)		149 to 165	149, 157, 165	OFDM	BPSK	6.5
802.11ac (VHT40)		151 to 159	151, 159	OFDM	BPSK	13.5
802.11ac (VHT80)		155	155	OFDM	BPSK	29.3
Radio 1 / Radio 2 / Beamforming Mode / Master Mode (Output power only)						
Mode	FREQ. Band (MHz)	Available Channel	Tested Channel	Modulation Technology	Modulation Type	Data Rate (Mbps)
802.11a	5180-5240	36 to 48	36, 40, 48	OFDM	BPSK	6
802.11ac (VHT20)		36 to 48	36, 40, 48	OFDM	BPSK	6.5
802.11ac (VHT40)		38 to 46	38, 46	OFDM	BPSK	13.5
802.11ac (VHT80)		42	42	OFDM	BPSK	29.3
802.11a	5745-5825	149 to 165	149, 157, 165	OFDM	BPSK	6
802.11ac (VHT20)		149 to 165	149, 157, 165	OFDM	BPSK	6.5
802.11ac (VHT40)		151 to 159	151, 159	OFDM	BPSK	13.5
802.11ac (VHT80)		155	155	OFDM	BPSK	29.3
Radio 1 / Radio 2 / Beamforming Mode / Client Mode (Output power only)						
Mode	FREQ. Band (MHz)	Available Channel	Tested Channel	Modulation Technology	Modulation Type	Data Rate (Mbps)
802.11a	5180-5240	36 to 48	36, 40, 48	OFDM	BPSK	6
802.11ac (VHT20)		36 to 48	36, 40, 48	OFDM	BPSK	6.5
802.11ac (VHT40)		38 to 46	38, 46	OFDM	BPSK	13.5
802.11ac (VHT80)		42	42	OFDM	BPSK	29.3
802.11a	5745-5825	149 to 165	149, 157, 165	OFDM	BPSK	6
802.11ac (VHT20)		149 to 165	149, 157, 165	OFDM	BPSK	6.5
802.11ac (VHT40)		151 to 159	151, 159	OFDM	BPSK	13.5
802.11ac (VHT80)		155	155	OFDM	BPSK	29.3

Test Condition:

Applicable To	Environmental Conditions	INPUT POWER (SYSTEM)	TESTED BY
RE≥1G	25deg. C, 70%RH	120Vac, 60Hz	Weiwei Lo
RE<1G	27deg. C, 73%RH	120Vac, 60Hz	Andy Ho
PLC	23deg. C, 75%RH	120Vac, 60Hz	Andy Ho
APCM	25deg. C, 60%RH	120Vac, 60Hz	Robert Cheng

3.3 Duty Cycle of Test Signal

If duty cycle of test signal is $\geq 98\%$, duty factor is not required.

If duty cycle of test signal is $< 98\%$, duty factor shall be considered.

802.11a: Duty cycle = $2.025/2.109 = 0.96$, Duty factor = $10 * \log(1/0.96) = 0.18$

802.11ac (VHT20): Duty cycle = $4.965/5.06 = 0.981$

802.11ac (VHT40): Duty cycle = $2.409/2.499 = 0.964$, Duty factor = $10 * \log(1/0.964) = 0.16$

802.11ac (VHT80): Duty cycle = $1.135/1.214 = 0.935$, Duty factor = $10 * \log(1/0.935) = 0.29$

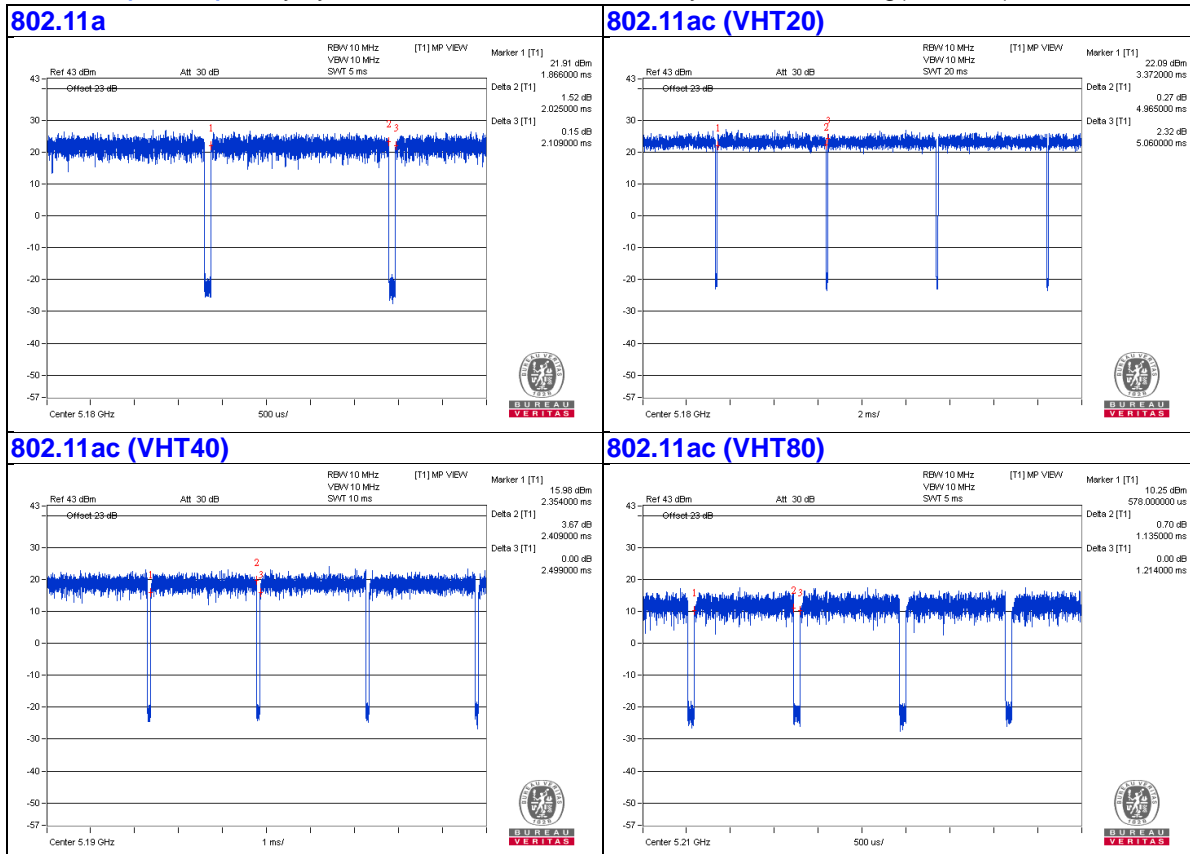

3.4 Description of Support Units

The EUT has been tested as an independent unit together with other necessary accessories or support units. The following support units or accessories were used to form a representative test configuration during the tests.

ID	Product	Brand	Model No.	Serial No.	FCC ID	Remarks
A.	DC Power Supply	GOOD WILL INSTRUMENT CO., LTD.	GPC-3030D	7700087	NA	Provided by Lab
B.	Laptop	DELL	E6420	B92T3R1	FCC DoC	Provided by Lab
C.	Laptop	DELL	E6420	482T3R1	FCC DoC	Provided by Lab
D.	iPod	Apple	MD778TA/A	CC4JMFL0F4T1	NA	Provided by Lab
E.	3G/LTE Modem	cradlepoint	MC400LP6	NA	N7NMC7455	Supplied by client

Note:

1. All power cords of the above support units are non-shielded (1.8m).

ID	Descriptions	Qty.	Length (m)	Shielding (Yes/No)	Cores (Qty.)	Remarks
1.	DC Cable	1	2	No	0	Supplied by client
2.	GND Cable	1	3	No	0	Provided by Lab
3.	RJ-45 Cable	1	10	No	0	Provided by Lab
4.	RJ-45 Cable	1	10	No	0	Provided by Lab
5.	USB Cable	1	0.1	Yes	0	Provided by Lab
6.	Coaxial Cable	1	1.6	No	0	Provided by Lab
7.	GPS Cable	1	3	No	0	Supplied by client
8.	GPS Cable	1	3	No	0	Supplied by client

Note: The core(s) is(are) originally attached to the cable(s).

3.4.1 Configuration of System under Test

For Conducted Emission Test:

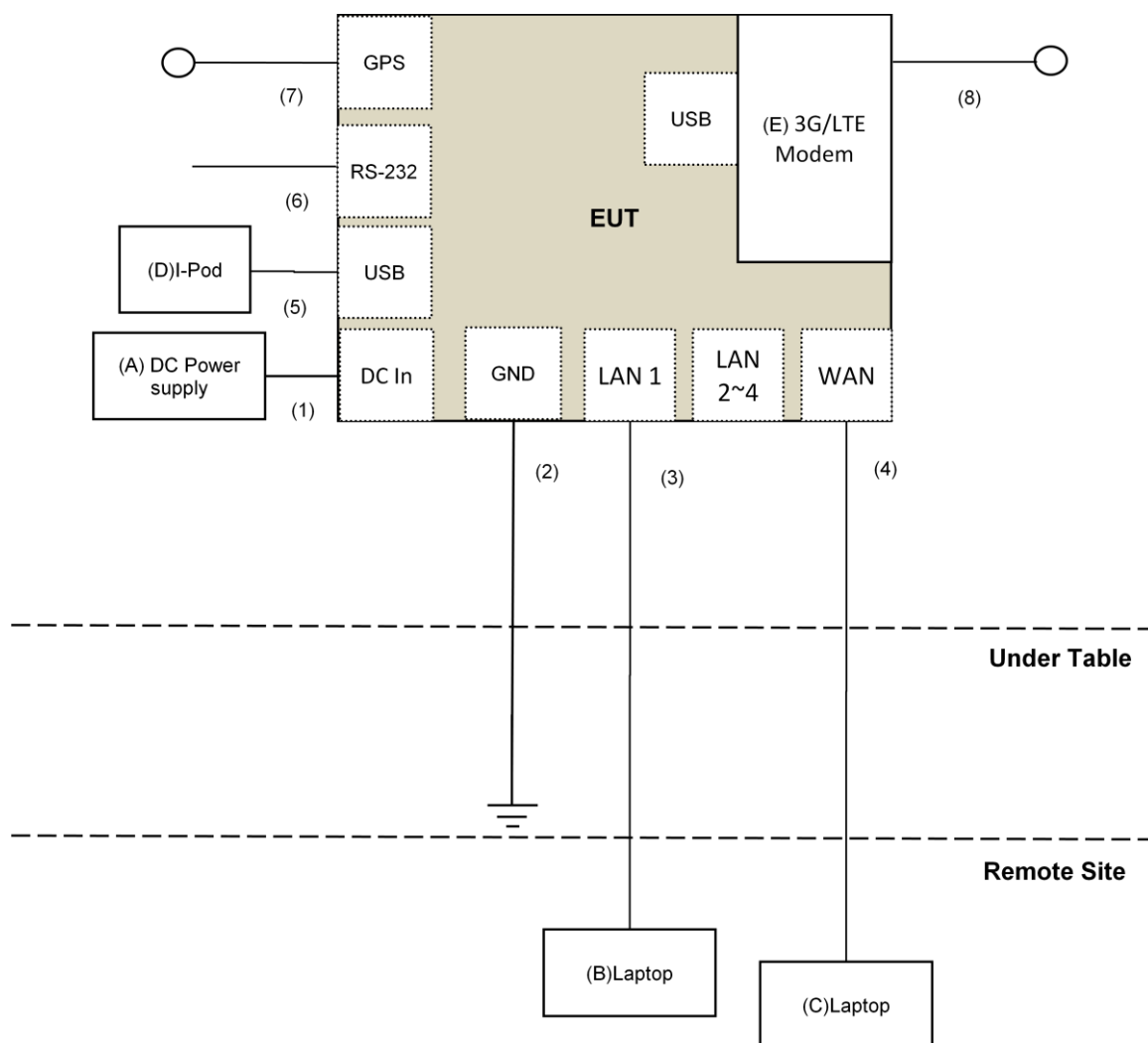

For other test:

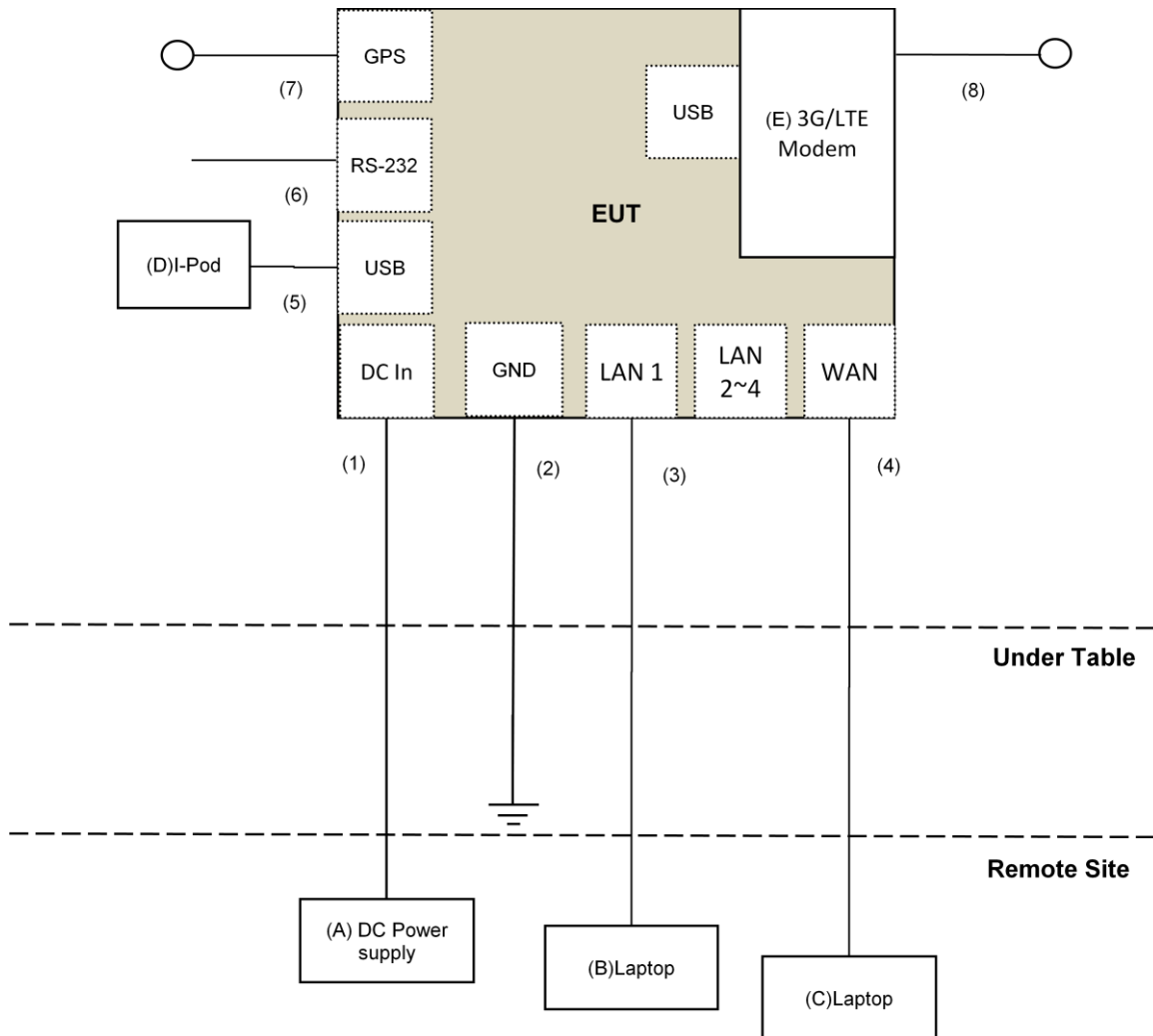

3.5 General Description of Applied Standard

The EUT is a RF Product. According to the specifications of the manufacturer, it must comply with the requirements of the following standards:

FCC Part 15, Subpart E (15.407)
KDB 789033 D02 General UNII Test Procedure New Rules v01r04
KDB 662911 D01 Multiple Transmitter Output v02r01
ANSI C63.10-2013

All test items have been performed and recorded as per the above standards.

NOTE: The EUT has been verified to comply with the requirements of FCC Part 15, Subpart B, Class B (DoC). The test report has been issued separately.

4 Test Types and Results

4.1 Radiated Emission and Bandedge Measurement

4.1.1 Limits of Radiated Emission and Bandedge Measurement

Radiated emissions which fall in the restricted bands must comply with the radiated emission limits specified as below table.

Frequencies (MHz)	Field Strength (microvolts/meter)	Measurement Distance (meters)
0.009 ~ 0.490	2400/F(kHz)	300
0.490 ~ 1.705	24000/F(kHz)	30
1.705 ~ 30.0	30	30
30 ~ 88	100	3
88 ~ 216	150	3
216 ~ 960	200	3
Above 960	500	3

NOTE:

1. The lower limit shall apply at the transition frequencies.
2. Emission level (dBuV/m) = 20 log Emission level (uV/m).
3. For frequencies above 1000MHz, the field strength limits are based on average detector, however, the peak field strength of any emission shall not exceed the maximum permitted average limits, specified above by more than 20dB under any condition of modulation.

Limits of unwanted emission out of the restricted bands

Applicable To		Limit	
789033 D02 General UNII Test Procedure New Rules v01r04		Field Strength at 3m	
		PK:74 (dBuV/m)	AV:54 (dBuV/m)
Frequency Band	Applicable To	EIRP Limit	Equivalent Field Strength at 3m
5150~5250 MHz	15.407(b)(1)	PK:-27 (dBm/MHz)	PK:68.2(dBuV/m)
5250~5350 MHz	15.407(b)(2)		
5470~5725 MHz	15.407(b)(3)		
5725~5850 MHz	<input checked="" type="checkbox"/> 15.407(b)(4)(i)	PK:-27 (dBm/MHz) ^{*1} PK:10 (dBm/MHz) ^{*2} PK:15.6 (dBm/MHz) ^{*3} PK:27 (dBm/MHz) ^{*4}	PK: 68.2(dBuV/m) ^{*1} PK:105.2 (dBuV/m) ^{*2} PK: 110.8(dBuV/m) ^{*3} PK:122.2 (dBuV/m) ^{*4}
	<input type="checkbox"/> 15.407(b)(4)(ii)	Emission limits in section 15.247(d)	
^{*1} beyond 75 MHz or more above of the band edge.		^{*2} below the band edge increasing linearly to 10 dBm/MHz at 25 MHz above.	
^{*3} below the band edge increasing linearly to a level of 15.6 dBm/MHz at 5 MHz above.		^{*4} from 5 MHz above or below the band edge increasing linearly to a level of 27 dBm/MHz at the band edge.	

Note:

The following formula is used to convert the equipment isotropic radiated power (eirp) to field strength:

$$E = \frac{1000000\sqrt{30P}}{3} \mu\text{V/m, where } P \text{ is the eirp (Watts).}$$

4.1.2 Test Instruments

DESCRIPTION & MANUFACTURER	MODEL NO.	SERIAL NO.	CALIBRATED DATE	CALIBRATED UNTIL
Test Receiver Keysight	N9038A	MY54450088	July 08, 2017	July 07, 2018
Pre-Amplifier ^(*) EMCI	EMC001340	980142	Jan. 20, 2016	Jan. 19, 2018
Loop Antenna ^(*) Electro-Metrics	EM-6879	264	Dec. 16, 2016	Dec. 15, 2018
RF Cable	NA	LOOPCAB-001 LOOPCAB-002	Jan. 17, 2017	Jan. 16, 2018
Pre-Amplifier Mini-Circuits	ZFL-1000VH2B	AMP-ZFL-01	Nov. 10, 2016	Nov. 09, 2017
Trilog Broadband Antenna SCHWARZBECK	VULB 9168	9168-406	Dec. 13, 2016	Dec. 12, 2017
RF Cable	8D	966-4-1 966-4-2 966-4-3	Apr. 01, 2017	Mar. 31, 2018
Fixed attenuator Mini-Circuits	UNAT-5+	PAD-3m-4-01	Oct. 05, 2016	Oct. 04, 2017
Horn_Antenna SCHWARZBECK	BBHA 9120D	9120D-783	Dec. 27, 2016	Dec. 26, 2017
Pre-Amplifier EMCI	EMC12630SE	980385	Feb. 02, 2017	Feb. 01, 2018
RF Cable	EMC104-SM-SM-1200 EMC104-SM-SM-2000 EMC104-SM-SM-5000	160923 150318 150321	Feb. 02, 2017 Mar. 29, 2017 Mar. 29, 2017	Feb. 01, 2018 Mar. 28, 2018 Mar. 28, 2018
Pre-Amplifier EMCI	EMC184045SE	980387	Feb. 02, 2017	Feb. 01, 2018
Horn_Antenna SCHWARZBECK	BBHA 9170	BBHA9170608	Dec. 15, 2016	Dec. 14, 2017
RF Cable	SUCOFLEX 102	36432/2 36433/2	Jan. 15, 2017	Jan. 14, 2018
Software	ADT_Radiated_V8.7.08	NA	NA	NA
Antenna Tower & Turn Table Max-Full	MF-7802	MF780208410	NA	NA
Boresight Antenna Fixture	FBA-01	FBA-SIP02	NA	NA
Spectrum Analyzer R&S	FSv40	100964	July 1, 2017	June 30, 2018
Power meter Anritsu	ML2495A	1014008	May 11, 2017	May 10, 2018
Power sensor Anritsu	MA2411B	0917122	May 11, 2017	May 10, 2018
Temperature & Humidity Chamber Giant Force	GTH-150-40-SP-AR	MAA0812-008	Jan. 11, 2017	Jan. 10, 2018
DC Power Supply Topward	6603D	795558	NA	NA
Digital Multimeter FLUKE	87III	73680266	Nov. 10, 2016	Nov. 09, 2017

Note:

1. The calibration interval of the above test instruments is 12 months and the calibrations are traceable to NML/ROC and NIST/USA.
2. *The calibration interval of the above test instruments is 24 months and the calibrations are traceable to NML/ROC and NIST/USA.
3. The test was performed in 966 Chamber No. 4.
4. The FCC Designation Number is TW2022.
5. Loop antenna was used for all emissions below 30 MHz.
6. The CANADA Site Registration No. is 20331-2
7. Tested Date: Sep. 22 to Oct. 03, 2017

4.1.3 Test Procedure

For Radiated emission below 30MHz

- a. The EUT was placed on the top of a rotating table 0.8 meters above the ground at a 3 meter chamber room. The table was rotated 360 degrees to determine the position of the highest radiation.
- b. The EUT was set 3 meters away from the interference-receiving antenna, which was mounted on the top of a variable-height antenna tower.
- c. Both X and Y axes of the antenna are set to make the measurement.
- d. For each suspected emission, the EUT was arranged to its worst case and the rotatable table was turned from 0 degrees to 360 degrees to find the maximum reading.
- e. The test-receiver system was set to Quasi-Peak Detect Function and Specified Bandwidth with Maximum Hold Mode.

NOTE:

1. The resolution bandwidth and video bandwidth of test receiver/spectrum analyzer is 9kHz at frequency below 30MHz.

For Radiated emission above 30MHz

- a. The EUT was placed on the top of a rotating table 0.8 meters (for 30MHz ~ 1GHz) / 1.5 meters (for above 1GHz) above the ground at 3 meter chamber room for test. The table was rotated 360 degrees to determine the position of the highest radiation.
- b. The EUT was set 3 meters away from the interference-receiving antenna, which was mounted on the top of a variable-height antenna tower.
- c. The height of antenna is varied from one meter to four meters above the ground to determine the maximum value of the field strength. Both horizontal and vertical polarizations of the antenna are set to make the measurement.
- d. For each suspected emission, the EUT was arranged to its worst case and then the antenna was tuned to heights from 1 meter to 4 meters and the rotatable table was turned from 0 degrees to 360 degrees to find the maximum reading.
- e. The test-receiver system was set to quasi-peak detect function and specified bandwidth with maximum hold mode when the test frequency is below 1 GHz.
- f. The test-receiver system was set to peak and average detect function and specified bandwidth with maximum hold mode when the test frequency is above 1 GHz. If the peak reading value also meets average limit, measurement with the average detector is unnecessary.

Note:

1. The resolution bandwidth and video bandwidth of test receiver/spectrum analyzer is 120kHz for Quasi-peak detection (QP) at frequency below 1GHz.
2. The resolution bandwidth of test receiver/spectrum analyzer is 1 MHz and the video bandwidth is 3 MHz for Peak detection (PK) at frequency above 1GHz.
3. The resolution bandwidth of test receiver/spectrum analyzer is 1MHz and the video bandwidth is $\geq 1/T$ (Duty cycle < 98%) or 10Hz (Duty cycle $\geq 98\%$) for Average detection (AV) at frequency above 1GHz.
4. All modes of operation were investigated and the worst-case emissions are reported.

4.1.4 Deviation from Test Standard

No deviation.

4.1.5 Test Setup

For Radiated emission below 30MHz

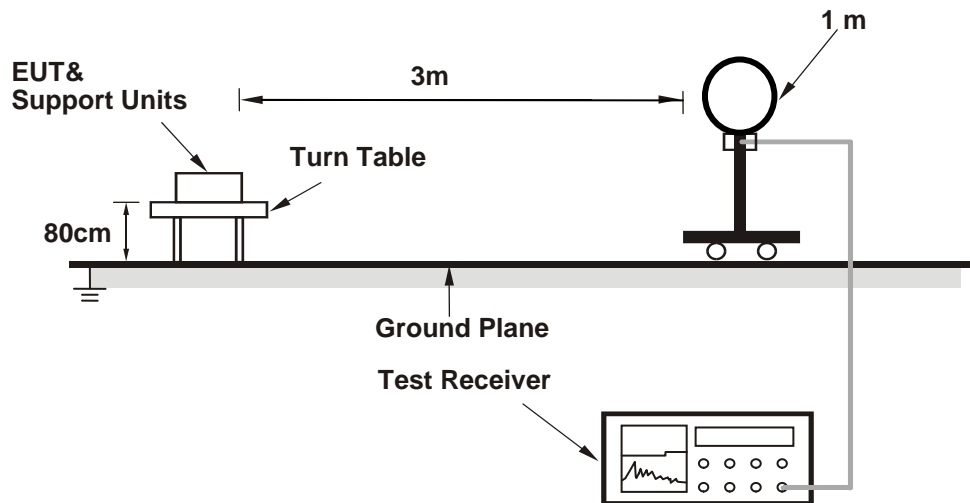

For Radiated emission 30MHz to 1GHz

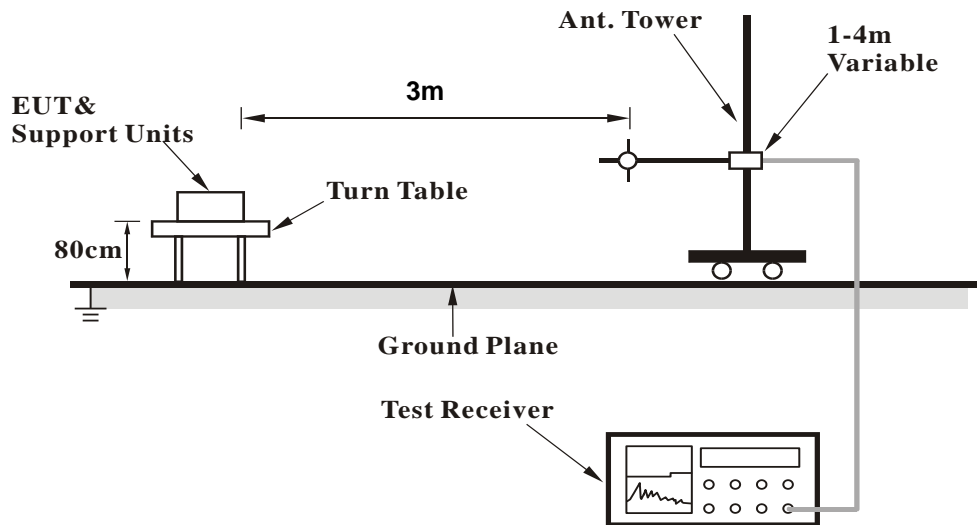

For Radiated emission above 1GHz

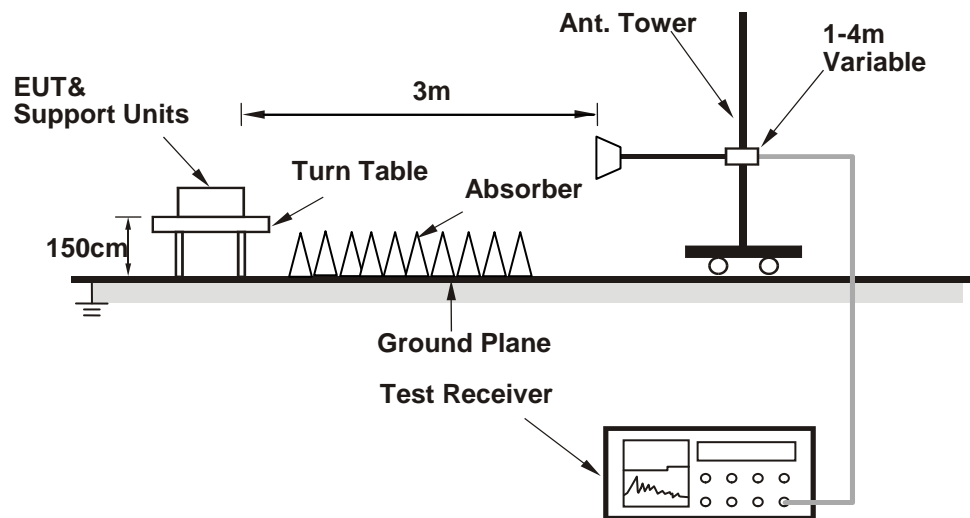

For the actual test configuration, please refer to the attached file (Test Setup Photo).

4.1.6 EUT Operating Condition

- a. Connected the EUT with the Laptop which is placed on remote site.
- b. Controlling software (QCA Radio Control Toolkit Version3.0.210.0) has been activated to set the EUT on specific status.

4.1.7 Test Results (Mode 1)

Above 1GHz Data:

802.11a

CHANNEL	TX Channel 36	DETECTOR FUNCTION	Peak (PK)
FREQUENCY RANGE	1GHz ~ 40GHz		Average (AV)

ANTENNA POLARITY & TEST DISTANCE: HORIZONTAL AT 3 M								
NO.	FREQ. (MHz)	EMISSION LEVEL (dBuV/m)	LIMIT (dBuV/m)	MARGIN (dB)	ANTENNA HEIGHT (m)	TABLE ANGLE (Degree)	RAW VALUE (dBuV)	CORRECTION FACTOR (dB/m)
1	5150.00	61.6 PK	74.0	-12.4	2.54 H	67	57.6	4.0
2	5150.00	45.8 AV	54.0	-8.2	2.54 H	67	41.8	4.0
3	*5180.00	107.7 PK			2.54 H	67	103.7	4.0
4	*5180.00	97.7 AV			2.54 H	67	93.7	4.0
5	#10360.00	46.5 PK	74.0	-27.5	1.45 H	18	32.9	13.6
6	#10360.00	34.9 AV	54.0	-19.1	1.45 H	18	21.3	13.6
7	15540.00	59.2 PK	74.0	-14.8	1.28 H	360	46.0	13.2
8	15540.00	46.5 AV	54.0	-7.5	1.28 H	360	33.3	13.2
ANTENNA POLARITY & TEST DISTANCE: VERTICAL AT 3 M								
NO.	FREQ. (MHz)	EMISSION LEVEL (dBuV/m)	LIMIT (dBuV/m)	MARGIN (dB)	ANTENNA HEIGHT (m)	TABLE ANGLE (Degree)	RAW VALUE (dBuV)	CORRECTION FACTOR (dB/m)
1	5150.00	66.1 PK	74.0	-7.9	1.27 V	360	62.1	4.0
2	5150.00	53.6 AV	54.0	-0.4	1.27 V	360	49.6	4.0
3	*5180.00	117.0 PK			1.27 V	360	113.0	4.0
4	*5180.00	107.1 AV			1.27 V	360	103.1	4.0
5	#10360.00	51.0 PK	74.0	-23.0	1.23 V	321	37.4	13.6
6	#10360.00	38.2 AV	54.0	-15.8	1.23 V	321	24.6	13.6
7	15540.00	57.4 PK	74.0	-16.6	2.20 V	355	44.2	13.2
8	15540.00	44.0 AV	54.0	-10.0	2.20 V	355	30.8	13.2

REMARKS:

1. Emission Level(dBuV/m) = Raw Value(dBuV) + Correction Factor(dB/m)
2. Correction Factor(dB/m) = Antenna Factor(dB/m) + Cable Factor(dB) – Pre-Amplifier Factor(dB)
3. The other emission levels were very low against the limit.
4. Margin value = Emission Level – Limit value
5. " * ": Fundamental frequency.
6. " # ": The radiated frequency is out of the restricted band.

CHANNEL	TX Channel 40	DETECTOR FUNCTION	Peak (PK)
FREQUENCY RANGE	1GHz ~ 40GHz		Average (AV)

ANTENNA POLARITY & TEST DISTANCE: HORIZONTAL AT 3 M

NO.	FREQ. (MHz)	EMISSION LEVEL (dBuV/m)	LIMIT (dBuV/m)	MARGIN (dB)	ANTENNA HEIGHT (m)	TABLE ANGLE (Degree)	RAW VALUE (dBuV)	CORRECTION FACTOR (dB/m)
1	5150.00	64.4 PK	74.0	-9.6	2.55 H	63	60.4	4.0
2	5150.00	46.1 AV	54.0	-7.9	2.55 H	63	42.1	4.0
3	*5200.00	112.2 PK			2.55 H	63	108.2	4.0
4	*5200.00	102.3 AV			2.55 H	63	98.3	4.0
5	5350.00	48.6 PK	74.0	-25.4	2.55 H	63	44.2	4.4
6	5350.00	37.8 AV	54.0	-16.2	2.55 H	63	33.4	4.4
7	#10400.00	46.4 PK	74.0	-27.6	1.43 H	9	32.8	13.6
8	#10400.00	34.9 AV	54.0	-19.1	1.43 H	9	21.3	13.6
9	15600.00	59.6 PK	74.0	-14.4	1.27 H	360	46.2	13.4
10	15600.00	46.9 AV	54.0	-7.1	1.27 H	360	33.5	13.4

ANTENNA POLARITY & TEST DISTANCE: VERTICAL AT 3 M

NO.	FREQ. (MHz)	EMISSION LEVEL (dBuV/m)	LIMIT (dBuV/m)	MARGIN (dB)	ANTENNA HEIGHT (m)	TABLE ANGLE (Degree)	RAW VALUE (dBuV)	CORRECTION FACTOR (dB/m)
1	5150.00	68.9 PK	74.0	-5.1	1.23 V	360	64.9	4.0
2	5150.00	53.9 AV	54.0	-0.1	1.23 V	360	49.9	4.0
3	*5200.00	121.5 PK			1.23 V	360	117.5	4.0
4	*5200.00	111.7 AV			1.23 V	360	107.7	4.0
5	5350.00	51.6 PK	74.0	-22.4	1.23 V	360	47.2	4.4
6	5350.00	40.8 AV	54.0	-13.2	1.23 V	360	36.4	4.4
7	#10400.00	50.9 PK	74.0	-23.1	1.26 V	312	37.3	13.6
8	#10400.00	38.1 AV	54.0	-15.9	1.26 V	312	24.5	13.6
9	15600.00	56.8 PK	74.0	-17.2	2.16 V	354	43.4	13.4
10	15600.00	43.5 AV	54.0	-10.5	2.16 V	354	30.1	13.4

REMARKS:

1. Emission Level(dBuV/m) = Raw Value(dBuV) + Correction Factor(dB/m)
2. Correction Factor(dB/m) = Antenna Factor(dB/m) + Cable Factor(dB) – Pre-Amplifier Factor(dB)
3. The other emission levels were very low against the limit.
4. Margin value = Emission Level – Limit value
5. " * ": Fundamental frequency.
6. " # ": The radiated frequency is out of the restricted band.

CHANNEL	TX Channel 48	DETECTOR FUNCTION	Peak (PK)
FREQUENCY RANGE	1GHz ~ 40GHz		Average (AV)

ANTENNA POLARITY & TEST DISTANCE: HORIZONTAL AT 3 M

NO.	FREQ. (MHz)	EMISSION LEVEL (dBuV/m)	LIMIT (dBuV/m)	MARGIN (dB)	ANTENNA HEIGHT (m)	TABLE ANGLE (Degree)	RAW VALUE (dBuV)	CORRECTION FACTOR (dB/m)
1	*5240.00	111.6 PK			2.53 H	74	107.4	4.2
2	*5240.00	101.8 AV			2.53 H	74	97.6	4.2
3	5350.00	47.8 PK	74.0	-26.2	2.53 H	74	43.4	4.4
4	5350.00	38.6 AV	54.0	-15.4	2.53 H	74	34.2	4.4
5	#10480.00	45.9 PK	74.0	-28.1	1.45 H	16	32.2	13.7
6	#10480.00	34.5 AV	54.0	-19.5	1.45 H	16	20.8	13.7
7	15720.00	59.6 PK	74.0	-14.4	1.31 H	360	45.6	14.0
8	15720.00	46.6 AV	54.0	-7.4	1.31 H	360	32.6	14.0

ANTENNA POLARITY & TEST DISTANCE: VERTICAL AT 3 M

NO.	FREQ. (MHz)	EMISSION LEVEL (dBuV/m)	LIMIT (dBuV/m)	MARGIN (dB)	ANTENNA HEIGHT (m)	TABLE ANGLE (Degree)	RAW VALUE (dBuV)	CORRECTION FACTOR (dB/m)
1	*5240.00	120.9 PK			1.19 V	360	116.7	4.2
2	*5240.00	111.2 AV			1.19 V	360	107.0	4.2
3	5350.00	50.8 PK	74.0	-23.2	1.19 V	360	46.4	4.4
4	5350.00	41.6 AV	54.0	-12.4	1.19 V	360	37.2	4.4
5	#10480.00	50.5 PK	74.0	-23.5	1.27 V	314	36.8	13.7
6	#10480.00	38.0 AV	54.0	-16.0	1.27 V	314	24.3	13.7
7	15720.00	56.2 PK	74.0	-17.8	2.17 V	360	42.2	14.0
8	15720.00	43.2 AV	54.0	-10.8	2.17 V	360	29.2	14.0

REMARKS:

1. Emission Level(dBuV/m) = Raw Value(dBuV) + Correction Factor(dB/m)
2. Correction Factor(dB/m) = Antenna Factor(dB/m) + Cable Factor(dB) – Pre-Amplifier Factor(dB)
3. The other emission levels were very low against the limit.
4. Margin value = Emission Level – Limit value
5. " * ": Fundamental frequency.
6. " # ": The radiated frequency is out of the restricted band.

CHANNEL	TX Channel 149	DETECTOR FUNCTION	Peak (PK)
FREQUENCY RANGE	1GHz ~ 40GHz		Average (AV)

ANTENNA POLARITY & TEST DISTANCE: HORIZONTAL AT 3 M

NO.	FREQ. (MHz)	EMISSION LEVEL (dBuV/m)	LIMIT (dBuV/m)	MARGIN (dB)	ANTENNA HEIGHT (m)	TABLE ANGLE (Degree)	RAW VALUE (dBuV)	CORRECTION FACTOR (dB/m)
1	#5627.16	59.1 PK	68.2	-9.1	1.10 H	147	54.7	4.4
2	*5745.00	115.6 PK			1.10 H	147	110.6	5.0
3	*5745.00	104.9 AV			1.10 H	147	99.9	5.0
4	#5966.19	58.9 PK	68.2	-9.3	1.10 H	147	54.2	4.7
5	11490.00	59.2 PK	74.0	-14.8	1.26 H	30	45.1	14.1
6	11490.00	48.2 AV	54.0	-5.8	1.26 H	30	34.1	14.1
7	#17235.00	63.5 PK	74.0	-10.5	2.08 H	360	45.2	18.3
8	#17235.00	52.6 AV	54.0	-1.4	2.08 H	360	34.3	18.3

ANTENNA POLARITY & TEST DISTANCE: VERTICAL AT 3 M

NO.	FREQ. (MHz)	EMISSION LEVEL (dBuV/m)	LIMIT (dBuV/m)	MARGIN (dB)	ANTENNA HEIGHT (m)	TABLE ANGLE (Degree)	RAW VALUE (dBuV)	CORRECTION FACTOR (dB/m)
1	#5597.93	59.3 PK	68.2	-8.9	1.05 V	360	54.9	4.4
2	*5745.00	122.4 PK			1.06 V	360	117.4	5.0
3	*5745.00	112.7 AV			1.06 V	360	107.7	5.0
4	#5942.93	58.2 PK	68.2	-10.0	1.05 V	360	53.5	4.7
5	11490.00	54.3 PK	74.0	-19.7	2.14 V	323	40.2	14.1
6	11490.00	42.2 AV	54.0	-11.8	2.14 V	323	28.1	14.1
7	#17235.00	63.9 PK	74.0	-10.1	2.43 V	360	45.6	18.3
8	#17235.00	52.1 AV	54.0	-1.9	2.43 V	360	33.8	18.3

REMARKS:

1. Emission Level(dBuV/m) = Raw Value(dBuV) + Correction Factor(dB/m)
2. Correction Factor(dB/m) = Antenna Factor(dB/m) + Cable Factor(dB) – Pre-Amplifier Factor(dB)
3. The other emission levels were very low against the limit.
4. Margin value = Emission Level – Limit value
5. " * ": Fundamental frequency.
6. " # ": The radiated frequency is out of the restricted band.

CHANNEL	TX Channel 157	DETECTOR FUNCTION	Peak (PK)
FREQUENCY RANGE	1GHz ~ 40GHz		Average (AV)

ANTENNA POLARITY & TEST DISTANCE: HORIZONTAL AT 3 M

NO.	FREQ. (MHz)	EMISSION LEVEL (dBuV/m)	LIMIT (dBuV/m)	MARGIN (dB)	ANTENNA HEIGHT (m)	TABLE ANGLE (Degree)	RAW VALUE (dBuV)	CORRECTION FACTOR (dB/m)
1	#5582.25	57.9 PK	68.2	-10.3	1.10 H	146	53.7	4.2
2	*5785.00	114.3 PK			1.10 H	146	109.3	5.0
3	*5785.00	104.5 AV			1.10 H	146	99.5	5.0
4	#5962.20	58.1 PK	68.2	-10.1	1.10 H	146	53.4	4.7
5	11570.00	58.7 PK	74.0	-15.3	1.32 H	26	44.7	14.0
6	11570.00	47.9 AV	54.0	-6.1	1.32 H	26	33.9	14.0
7	#17355.00	64.0 PK	74.0	-10.0	2.10 H	360	45.1	18.9
8	#17355.00	52.9 AV	54.0	-1.1	2.10 H	360	34.0	18.9

ANTENNA POLARITY & TEST DISTANCE: VERTICAL AT 3 M

NO.	FREQ. (MHz)	EMISSION LEVEL (dBuV/m)	LIMIT (dBuV/m)	MARGIN (dB)	ANTENNA HEIGHT (m)	TABLE ANGLE (Degree)	RAW VALUE (dBuV)	CORRECTION FACTOR (dB/m)
1	#5618.17	58.7 PK	68.2	-9.5	1.05 V	360	54.3	4.4
2	*5785.00	122.3 PK			1.05 V	360	117.3	5.0
3	*5785.00	112.4 AV			1.05 V	360	107.4	5.0
4	#6007.84	57.1 PK	68.2	-11.1	1.05 V	360	52.3	4.8
5	11570.00	53.6 PK	74.0	-20.4	2.18 V	327	39.6	14.0
6	11570.00	41.8 AV	54.0	-12.2	2.18 V	327	27.8	14.0
7	#17355.00	63.6 PK	74.0	-10.4	2.41 V	360	44.7	18.9
8	#17355.00	51.6 AV	54.0	-2.4	2.41 V	360	32.7	18.9

REMARKS:

1. Emission Level(dBuV/m) = Raw Value(dBuV) + Correction Factor(dB/m)
2. Correction Factor(dB/m) = Antenna Factor(dB/m) + Cable Factor(dB) – Pre-Amplifier Factor(dB)
3. The other emission levels were very low against the limit.
4. Margin value = Emission Level – Limit value
5. " * ": Fundamental frequency.
6. " # ": The radiated frequency is out of the restricted band.

CHANNEL	TX Channel 165	DETECTOR FUNCTION	Peak (PK)
FREQUENCY RANGE	1GHz ~ 40GHz		Average (AV)

ANTENNA POLARITY & TEST DISTANCE: HORIZONTAL AT 3 M

NO.	FREQ. (MHz)	EMISSION LEVEL (dBuV/m)	LIMIT (dBuV/m)	MARGIN (dB)	ANTENNA HEIGHT (m)	TABLE ANGLE (Degree)	RAW VALUE (dBuV)	CORRECTION FACTOR (dB/m)
1	#5617.18	58.8 PK	68.2	-9.4	1.22 H	151	54.4	4.4
2	*5825.00	114.4 PK			1.22 H	151	109.2	5.2
3	*5825.00	104.6 AV			1.22 H	151	99.4	5.2
4	#5973.33	58.2 PK	68.2	-10.0	1.22 H	151	53.5	4.7
5	11650.00	59.4 PK	74.0	-14.6	1.25 H	20	45.3	14.1
6	11650.00	48.1 AV	54.0	-5.9	1.25 H	20	34.0	14.1
7	#17475.00	63.3 PK	74.0	-10.7	2.11 H	347	43.6	19.7
8	#17475.00	52.7 AV	54.0	-1.3	2.11 H	347	33.0	19.7

ANTENNA POLARITY & TEST DISTANCE: VERTICAL AT 3 M

NO.	FREQ. (MHz)	EMISSION LEVEL (dBuV/m)	LIMIT (dBuV/m)	MARGIN (dB)	ANTENNA HEIGHT (m)	TABLE ANGLE (Degree)	RAW VALUE (dBuV)	CORRECTION FACTOR (dB/m)
1	#5645.28	59.6 PK	68.2	-8.6	1.05 V	360	55.2	4.4
2	*5825.00	122.1 PK			1.05 V	360	116.9	5.2
3	*5825.00	112.3 AV			1.05 V	360	107.1	5.2
4	#6003.47	58.4 PK	68.2	-9.8	1.05 V	360	53.6	4.8
5	11650.00	53.7 PK	74.0	-20.3	2.12 V	339	39.6	14.1
6	11650.00	41.7 AV	54.0	-12.3	2.12 V	339	27.6	14.1
7	#17475.00	63.3 PK	74.0	-10.7	2.44 V	360	43.6	19.7
8	#17475.00	51.7 AV	54.0	-2.3	2.44 V	360	32.0	19.7

REMARKS:

1. Emission Level(dBuV/m) = Raw Value(dBuV) + Correction Factor(dB/m)
2. Correction Factor(dB/m) = Antenna Factor(dB/m) + Cable Factor(dB) – Pre-Amplifier Factor(dB)
3. The other emission levels were very low against the limit.
4. Margin value = Emission Level – Limit value
5. " * ": Fundamental frequency.
6. " # ": The radiated frequency is out of the restricted band.

802.11ac (VHT20)

CHANNEL	TX Channel 36	DETECTOR FUNCTION	Peak (PK)
FREQUENCY RANGE	1GHz ~ 40GHz		Average (AV)

ANTENNA POLARITY & TEST DISTANCE: HORIZONTAL AT 3 M

NO.	FREQ. (MHz)	EMISSION LEVEL (dBuV/m)	LIMIT (dBuV/m)	MARGIN (dB)	ANTENNA HEIGHT (m)	TABLE ANGLE (Degree)	RAW VALUE (dBuV)	CORRECTION FACTOR (dB/m)
1	5150.00	64.1 PK	74.0	-9.9	2.54 H	75	60.1	4.0
2	5150.00	46.0 AV	54.0	-8.0	2.54 H	75	42.0	4.0
3	*5180.00	106.9 PK			2.54 H	75	102.9	4.0
4	*5180.00	97.0 AV			2.54 H	75	93.0	4.0
5	#10360.00	46.1 PK	74.0	-27.9	1.37 H	39	32.5	13.6
6	#10360.00	34.9 AV	54.0	-19.1	1.37 H	39	21.3	13.6
7	15540.00	58.7 PK	74.0	-15.3	1.36 H	360	45.5	13.2
8	15540.00	46.2 AV	54.0	-7.8	1.36 H	360	33.0	13.2

ANTENNA POLARITY & TEST DISTANCE: VERTICAL AT 3 M

NO.	FREQ. (MHz)	EMISSION LEVEL (dBuV/m)	LIMIT (dBuV/m)	MARGIN (dB)	ANTENNA HEIGHT (m)	TABLE ANGLE (Degree)	RAW VALUE (dBuV)	CORRECTION FACTOR (dB/m)
1	5150.00	68.6 PK	74.0	-5.4	1.21 V	360	64.6	4.0
2	5150.00	53.8 AV	54.0	-0.2	1.21 V	360	49.8	4.0
3	*5180.00	116.2 PK			1.21 V	360	112.2	4.0
4	*5180.00	106.4 AV			1.21 V	360	102.4	4.0
5	#10360.00	50.1 PK	74.0	-23.9	1.21 V	314	36.5	13.6
6	#10360.00	37.3 AV	54.0	-16.7	1.21 V	314	23.7	13.6
7	15540.00	56.8 PK	74.0	-17.2	2.21 V	360	43.6	13.2
8	15540.00	43.7 AV	54.0	-10.3	2.21 V	360	30.5	13.2

REMARKS:

- Emission Level(dBuV/m) = Raw Value(dBuV) + Correction Factor(dB/m)
- Correction Factor(dB/m) = Antenna Factor(dB/m) + Cable Factor(dB) – Pre-Amplifier Factor(dB)
- The other emission levels were very low against the limit.
- Margin value = Emission Level – Limit value
- " * ": Fundamental frequency.
- " # ": The radiated frequency is out of the restricted band.

CHANNEL	TX Channel 40	DETECTOR FUNCTION	Peak (PK)
FREQUENCY RANGE	1GHz ~ 40GHz		Average (AV)

ANTENNA POLARITY & TEST DISTANCE: HORIZONTAL AT 3 M

NO.	FREQ. (MHz)	EMISSION LEVEL (dBuV/m)	LIMIT (dBuV/m)	MARGIN (dB)	ANTENNA HEIGHT (m)	TABLE ANGLE (Degree)	RAW VALUE (dBuV)	CORRECTION FACTOR (dB/m)
1	5150.00	63.1 PK	74.0	-10.9	2.49 H	89	59.1	4.0
2	5150.00	46.1 AV	54.0	-7.9	2.49 H	89	42.1	4.0
3	*5200.00	112.4 PK			2.49 H	89	108.4	4.0
4	*5200.00	101.9 AV			2.49 H	89	97.9	4.0
5	5350.00	48.5 PK	74.0	-25.5	2.49 H	89	44.1	4.4
6	5350.00	37.7 AV	54.0	-16.3	2.49 H	89	33.3	4.4
7	#10400.00	45.9 PK	74.0	-28.1	1.42 H	25	32.3	13.6
8	#10400.00	34.6 AV	54.0	-19.4	1.42 H	25	21.0	13.6
9	15600.00	59.2 PK	74.0	-14.8	1.31 H	360	45.8	13.4
10	15600.00	46.5 AV	54.0	-7.5	1.31 H	360	33.1	13.4

ANTENNA POLARITY & TEST DISTANCE: VERTICAL AT 3 M

NO.	FREQ. (MHz)	EMISSION LEVEL (dBuV/m)	LIMIT (dBuV/m)	MARGIN (dB)	ANTENNA HEIGHT (m)	TABLE ANGLE (Degree)	RAW VALUE (dBuV)	CORRECTION FACTOR (dB/m)
1	5150.00	67.6 PK	74.0	-6.4	1.17 V	360	63.6	4.0
2	5150.00	53.9 AV	54.0	-0.1	1.17 V	360	49.9	4.0
3	*5200.00	121.7 PK			1.17 V	360	117.7	4.0
4	*5200.00	111.3 AV			1.17 V	360	107.3	4.0
5	5350.00	51.5 PK	74.0	-22.5	1.17 V	360	47.1	4.4
6	5350.00	40.7 AV	54.0	-13.3	1.17 V	360	36.3	4.4
7	#10400.00	50.3 PK	74.0	-23.7	1.23 V	310	36.7	13.6
8	#10400.00	37.7 AV	54.0	-16.3	1.23 V	310	24.1	13.6
9	15600.00	56.4 PK	74.0	-17.6	2.17 V	360	43.0	13.4
10	15600.00	43.3 AV	54.0	-10.7	2.17 V	360	29.9	13.4

REMARKS:

- Emission Level(dBuV/m) = Raw Value(dBuV) + Correction Factor(dB/m)
- Correction Factor(dB/m) = Antenna Factor(dB/m) + Cable Factor(dB) – Pre-Amplifier Factor(dB)
- The other emission levels were very low against the limit.
- Margin value = Emission Level – Limit value
- " * ": Fundamental frequency.
- " # ": The radiated frequency is out of the restricted band.

CHANNEL	TX Channel 48	DETECTOR FUNCTION	Peak (PK)
FREQUENCY RANGE	1GHz ~ 40GHz		Average (AV)

ANTENNA POLARITY & TEST DISTANCE: HORIZONTAL AT 3 M

NO.	FREQ. (MHz)	EMISSION LEVEL (dBuV/m)	LIMIT (dBuV/m)	MARGIN (dB)	ANTENNA HEIGHT (m)	TABLE ANGLE (Degree)	RAW VALUE (dBuV)	CORRECTION FACTOR (dB/m)
1	*5240.00	112.2 PK			2.45 H	90	108.0	4.2
2	*5240.00	101.6 AV			2.45 H	90	97.4	4.2
3	5350.00	49.6 PK	74.0	-24.4	2.45 H	90	45.2	4.4
4	5350.00	38.6 AV	54.0	-15.4	2.45 H	90	34.2	4.4
5	#10480.00	45.5 PK	74.0	-28.5	1.40 H	40	31.8	13.7
6	#10480.00	34.5 AV	54.0	-19.5	1.40 H	40	20.8	13.7
7	15720.00	59.3 PK	74.0	-14.7	1.34 H	360	45.3	14.0
8	15720.00	46.4 AV	54.0	-7.6	1.34 H	360	32.4	14.0

ANTENNA POLARITY & TEST DISTANCE: VERTICAL AT 3 M

NO.	FREQ. (MHz)	EMISSION LEVEL (dBuV/m)	LIMIT (dBuV/m)	MARGIN (dB)	ANTENNA HEIGHT (m)	TABLE ANGLE (Degree)	RAW VALUE (dBuV)	CORRECTION FACTOR (dB/m)
1	*5240.00	121.5 PK			1.21 V	360	117.3	4.2
2	*5240.00	111.0 AV			1.21 V	360	106.8	4.2
3	5350.00	52.6 PK	74.0	-21.4	1.21 V	360	48.2	4.4
4	5350.00	41.6 AV	54.0	-12.4	1.21 V	360	37.2	4.4
5	#10480.00	50.0 PK	74.0	-24.0	1.25 V	325	36.3	13.7
6	#10480.00	37.3 AV	54.0	-16.7	1.25 V	325	23.6	13.7
7	15720.00	55.9 PK	74.0	-18.1	2.23 V	360	41.9	14.0
8	15720.00	42.8 AV	54.0	-11.2	2.23 V	360	28.8	14.0

REMARKS:

1. Emission Level(dBuV/m) = Raw Value(dBuV) + Correction Factor(dB/m)
2. Correction Factor(dB/m) = Antenna Factor(dB/m) + Cable Factor(dB) – Pre-Amplifier Factor(dB)
3. The other emission levels were very low against the limit.
4. Margin value = Emission Level – Limit value
5. " * ": Fundamental frequency.
6. " # ": The radiated frequency is out of the restricted band.

CHANNEL	TX Channel 149	DETECTOR FUNCTION	Peak (PK)
FREQUENCY RANGE	1GHz ~ 40GHz		Average (AV)

ANTENNA POLARITY & TEST DISTANCE: HORIZONTAL AT 3 M

NO.	FREQ. (MHz)	EMISSION LEVEL (dBuV/m)	LIMIT (dBuV/m)	MARGIN (dB)	ANTENNA HEIGHT (m)	TABLE ANGLE (Degree)	RAW VALUE (dBuV)	CORRECTION FACTOR (dB/m)
1	#5609.97	58.7 PK	68.2	-9.5	1.04 H	151	54.3	4.4
2	*5745.00	115.5 PK			1.04 H	151	110.5	5.0
3	*5745.00	104.6 AV			1.04 H	151	99.6	5.0
4	#5933.31	57.3 PK	68.2	-10.9	1.04 H	151	52.6	4.7
5	11490.00	58.8 PK	74.0	-15.2	1.28 H	44	44.7	14.1
6	11490.00	47.9 AV	54.0	-6.1	1.28 H	44	33.8	14.1
7	#17235.00	63.6 PK	74.0	-10.4	2.12 H	360	45.3	18.3
8	#17235.00	52.7 AV	54.0	-1.3	2.12 H	360	34.4	18.3

ANTENNA POLARITY & TEST DISTANCE: VERTICAL AT 3 M

NO.	FREQ. (MHz)	EMISSION LEVEL (dBuV/m)	LIMIT (dBuV/m)	MARGIN (dB)	ANTENNA HEIGHT (m)	TABLE ANGLE (Degree)	RAW VALUE (dBuV)	CORRECTION FACTOR (dB/m)
1	#5574.75	58.9 PK	68.2	-9.3	1.14 V	360	54.7	4.2
2	*5745.00	122.1 PK			1.14 V	360	117.1	5.0
3	*5745.00	112.3 AV			1.14 V	360	107.3	5.0
4	#5951.68	57.5 PK	68.2	-10.7	1.14 V	360	52.8	4.7
5	11490.00	54.5 PK	74.0	-19.5	2.12 V	321	40.4	14.1
6	11490.00	42.3 AV	54.0	-11.7	2.12 V	321	28.2	14.1
7	#17235.00	63.8 PK	74.0	-10.2	2.46 V	360	45.5	18.3
8	#17235.00	52.2 AV	54.0	-1.8	2.46 V	360	33.9	18.3

REMARKS:

1. Emission Level(dBuV/m) = Raw Value(dBuV) + Correction Factor(dB/m)
2. Correction Factor(dB/m) = Antenna Factor(dB/m) + Cable Factor(dB) – Pre-Amplifier Factor(dB)
3. The other emission levels were very low against the limit.
4. Margin value = Emission Level – Limit value
5. " * ": Fundamental frequency.
6. " # ": The radiated frequency is out of the restricted band.

CHANNEL	TX Channel 157	DETECTOR FUNCTION	Peak (PK)
FREQUENCY RANGE	1GHz ~ 40GHz		Average (AV)

ANTENNA POLARITY & TEST DISTANCE: HORIZONTAL AT 3 M

NO.	FREQ. (MHz)	EMISSION LEVEL (dBuV/m)	LIMIT (dBuV/m)	MARGIN (dB)	ANTENNA HEIGHT (m)	TABLE ANGLE (Degree)	RAW VALUE (dBuV)	CORRECTION FACTOR (dB/m)
1	#5626.63	58.3 PK	68.2	-9.9	1.02 H	148	53.9	4.4
2	*5785.00	114.2 PK			1.02 H	148	109.2	5.0
3	*5785.00	104.4 AV			1.02 H	148	99.4	5.0
4	#5929.05	57.9 PK	68.2	-10.3	1.02 H	148	53.2	4.7
5	11570.00	59.4 PK	74.0	-14.6	1.24 H	26	45.4	14.0
6	11570.00	48.2 AV	54.0	-5.8	1.24 H	26	34.2	14.0
7	#17355.00	63.6 PK	74.0	-10.4	2.08 H	360	44.7	18.9
8	#17355.00	52.6 AV	54.0	-1.4	2.08 H	360	33.7	18.9

ANTENNA POLARITY & TEST DISTANCE: VERTICAL AT 3 M

NO.	FREQ. (MHz)	EMISSION LEVEL (dBuV/m)	LIMIT (dBuV/m)	MARGIN (dB)	ANTENNA HEIGHT (m)	TABLE ANGLE (Degree)	RAW VALUE (dBuV)	CORRECTION FACTOR (dB/m)
1	#5560.09	59.6 PK	68.2	-8.6	1.10 V	360	55.4	4.2
2	*5785.00	122.2 PK			1.10 V	360	117.2	5.0
3	*5785.00	112.2 AV			1.10 V	360	107.2	5.0
4	#5998.42	57.2 PK	68.2	-11.0	1.10 V	360	52.5	4.7
5	11570.00	54.0 PK	74.0	-20.0	2.13 V	318	40.0	14.0
6	11570.00	41.8 AV	54.0	-12.2	2.13 V	318	27.8	14.0
7	#17355.00	63.6 PK	74.0	-10.4	2.42 V	360	44.7	18.9
8	#17355.00	51.6 AV	54.0	-2.4	2.42 V	360	32.7	18.9

REMARKS:

1. Emission Level(dBuV/m) = Raw Value(dBuV) + Correction Factor(dB/m)
2. Correction Factor(dB/m) = Antenna Factor(dB/m) + Cable Factor(dB) – Pre-Amplifier Factor(dB)
3. The other emission levels were very low against the limit.
4. Margin value = Emission Level – Limit value
5. " * ": Fundamental frequency.
6. " # ": The radiated frequency is out of the restricted band.

CHANNEL	TX Channel 165	DETECTOR FUNCTION	Peak (PK)
FREQUENCY RANGE	1GHz ~ 40GHz		Average (AV)

ANTENNA POLARITY & TEST DISTANCE: HORIZONTAL AT 3 M

NO.	FREQ. (MHz)	EMISSION LEVEL (dBuV/m)	LIMIT (dBuV/m)	MARGIN (dB)	ANTENNA HEIGHT (m)	TABLE ANGLE (Degree)	RAW VALUE (dBuV)	CORRECTION FACTOR (dB/m)
1	#5564.68	60.3 PK	68.2	-7.9	1.02 H	147	56.1	4.2
2	*5825.00	114.7 PK			1.02 H	147	109.5	5.2
3	*5825.00	104.3 AV			1.02 H	147	99.1	5.2
4	#5988.03	57.8 PK	68.2	-10.4	1.02 H	147	53.1	4.7
5	11650.00	59.7 PK	74.0	-14.3	1.29 H	27	45.6	14.1
6	11650.00	48.4 AV	54.0	-5.6	1.29 H	27	34.3	14.1
7	#17475.00	63.2 PK	74.0	-10.8	2.11 H	347	43.5	19.7
8	#17475.00	52.3 AV	54.0	-1.7	2.11 H	347	32.6	19.7

ANTENNA POLARITY & TEST DISTANCE: VERTICAL AT 3 M

NO.	FREQ. (MHz)	EMISSION LEVEL (dBuV/m)	LIMIT (dBuV/m)	MARGIN (dB)	ANTENNA HEIGHT (m)	TABLE ANGLE (Degree)	RAW VALUE (dBuV)	CORRECTION FACTOR (dB/m)
1	#5574.36	58.0 PK	68.2	-10.2	1.13 V	360	53.8	4.2
2	*5825.00	122.1 PK			1.13 V	360	116.9	5.2
3	*5825.00	112.2 AV			1.13 V	360	107.0	5.2
4	#5995.74	58.1 PK	68.2	-10.1	1.13 V	360	53.4	4.7
5	11650.00	54.9 PK	74.0	-19.1	2.16 V	331	40.8	14.1
6	11650.00	42.5 AV	54.0	-11.5	2.16 V	331	28.4	14.1
7	#17475.00	63.6 PK	74.0	-10.4	2.39 V	359	43.9	19.7
8	#17475.00	51.9 AV	54.0	-2.1	2.39 V	359	32.2	19.7

REMARKS:

1. Emission Level(dBuV/m) = Raw Value(dBuV) + Correction Factor(dB/m)
2. Correction Factor(dB/m) = Antenna Factor(dB/m) + Cable Factor(dB) – Pre-Amplifier Factor(dB)
3. The other emission levels were very low against the limit.
4. Margin value = Emission Level – Limit value
5. " * ": Fundamental frequency.
6. " # ": The radiated frequency is out of the restricted band.

802.11ac (VHT40)

CHANNEL	TX Channel 38	DETECTOR FUNCTION	Peak (PK)
FREQUENCY RANGE	1GHz ~ 40GHz		Average (AV)

ANTENNA POLARITY & TEST DISTANCE: HORIZONTAL AT 3 M

NO.	FREQ. (MHz)	EMISSION LEVEL (dBuV/m)	LIMIT (dBuV/m)	MARGIN (dB)	ANTENNA HEIGHT (m)	TABLE ANGLE (Degree)	RAW VALUE (dBuV)	CORRECTION FACTOR (dB/m)
1	5150.00	66.2 PK	74.0	-7.8	2.52 H	82	62.2	4.0
2	5150.00	46.1 AV	54.0	-7.9	2.52 H	82	42.1	4.0
3	*5190.00	104.4 PK			2.52 H	82	100.4	4.0
4	*5190.00	94.9 AV			2.52 H	82	90.9	4.0
5	5350.00	48.7 PK	74.0	-25.3	2.52 H	82	44.3	4.4
6	5350.00	38.4 AV	54.0	-15.6	2.52 H	82	34.0	4.4
7	#10380.00	46.0 PK	74.0	-28.0	1.45 H	24	32.4	13.6
8	#10380.00	34.4 AV	54.0	-19.6	1.45 H	24	20.8	13.6
9	15570.00	58.8 PK	74.0	-15.2	1.35 H	360	45.5	13.3
10	15570.00	46.4 AV	54.0	-7.6	1.35 H	360	33.1	13.3

ANTENNA POLARITY & TEST DISTANCE: VERTICAL AT 3 M

NO.	FREQ. (MHz)	EMISSION LEVEL (dBuV/m)	LIMIT (dBuV/m)	MARGIN (dB)	ANTENNA HEIGHT (m)	TABLE ANGLE (Degree)	RAW VALUE (dBuV)	CORRECTION FACTOR (dB/m)
1	5150.00	70.7 PK	74.0	-3.3	1.03 V	360	66.7	4.0
2	5150.00	53.9 AV	54.0	-0.1	1.03 V	360	49.9	4.0
3	*5190.00	113.7 PK			1.03 V	360	109.7	4.0
4	*5190.00	104.3 AV			1.03 V	360	100.3	4.0
5	5350.00	51.7 PK	74.0	-22.3	1.03 V	360	47.3	4.4
6	5350.00	41.4 AV	54.0	-12.6	1.03 V	360	37.0	4.4
7	#10380.00	50.7 PK	74.0	-23.3	1.19 V	310	37.1	13.6
8	#10380.00	38.2 AV	54.0	-15.8	1.19 V	310	24.6	13.6
9	15570.00	56.5 PK	74.0	-17.5	2.16 V	360	43.2	13.3
10	15570.00	43.6 AV	54.0	-10.4	2.16 V	360	30.3	13.3

REMARKS:

- Emission Level(dBuV/m) = Raw Value(dBuV) + Correction Factor(dB/m)
- Correction Factor(dB/m) = Antenna Factor(dB/m) + Cable Factor(dB) – Pre-Amplifier Factor(dB)
- The other emission levels were very low against the limit.
- Margin value = Emission Level – Limit value
- " * ": Fundamental frequency.
- " # ": The radiated frequency is out of the restricted band.

CHANNEL	TX Channel 46	DETECTOR FUNCTION	Peak (PK)
FREQUENCY RANGE	1GHz ~ 40GHz		Average (AV)

ANTENNA POLARITY & TEST DISTANCE: HORIZONTAL AT 3 M

NO.	FREQ. (MHz)	EMISSION LEVEL (dBuV/m)	LIMIT (dBuV/m)	MARGIN (dB)	ANTENNA HEIGHT (m)	TABLE ANGLE (Degree)	RAW VALUE (dBuV)	CORRECTION FACTOR (dB/m)
1	*5230.00	108.8 PK			2.56 H	90	104.6	4.2
2	*5230.00	98.9 AV			2.56 H	90	94.7	4.2
3	5350.00	49.7 PK	74.0	-24.3	2.56 H	90	45.3	4.4
4	5350.00	39.3 AV	54.0	-14.7	2.56 H	90	34.9	4.4
5	#10460.00	45.5 PK	74.0	-28.5	1.38 H	32	31.8	13.7
6	#10460.00	34.5 AV	54.0	-19.5	1.38 H	32	20.8	13.7
7	15690.00	59.7 PK	74.0	-14.3	1.32 H	360	45.7	14.0
8	15690.00	46.9 AV	54.0	-7.1	1.32 H	360	32.9	14.0

ANTENNA POLARITY & TEST DISTANCE: VERTICAL AT 3 M

NO.	FREQ. (MHz)	EMISSION LEVEL (dBuV/m)	LIMIT (dBuV/m)	MARGIN (dB)	ANTENNA HEIGHT (m)	TABLE ANGLE (Degree)	RAW VALUE (dBuV)	CORRECTION FACTOR (dB/m)
1	*5230.00	118.1 PK			1.12 V	360	113.9	4.2
2	*5230.00	108.3 AV			1.12 V	360	104.1	4.2
3	5350.00	52.7 PK	74.0	-21.3	1.12 V	360	48.3	4.4
4	5350.00	42.3 AV	54.0	-11.7	1.12 V	360	37.9	4.4
5	#10460.00	50.3 PK	74.0	-23.7	1.20 V	300	36.6	13.7
6	#10460.00	37.9 AV	54.0	-16.1	1.20 V	300	24.2	13.7
7	15690.00	56.0 PK	74.0	-18.0	2.20 V	357	42.0	14.0
8	15690.00	43.1 AV	54.0	-10.9	2.20 V	357	29.1	14.0

REMARKS:

1. Emission Level(dBuV/m) = Raw Value(dBuV) + Correction Factor(dB/m)
2. Correction Factor(dB/m) = Antenna Factor(dB/m) + Cable Factor(dB) – Pre-Amplifier Factor(dB)
3. The other emission levels were very low against the limit.
4. Margin value = Emission Level – Limit value
5. " * ": Fundamental frequency.
6. " # ": The radiated frequency is out of the restricted band.

CHANNEL	TX Channel 151	DETECTOR FUNCTION	Peak (PK)
FREQUENCY RANGE	1GHz ~ 40GHz		Average (AV)

ANTENNA POLARITY & TEST DISTANCE: HORIZONTAL AT 3 M

NO.	FREQ. (MHz)	EMISSION LEVEL (dBuV/m)	LIMIT (dBuV/m)	MARGIN (dB)	ANTENNA HEIGHT (m)	TABLE ANGLE (Degree)	RAW VALUE (dBuV)	CORRECTION FACTOR (dB/m)
1	#5614.66	58.9 PK	68.2	-9.3	1.38 H	153	54.5	4.4
2	*5755.00	111.6 PK			1.38 H	153	106.6	5.0
3	*5755.00	101.7 AV			1.38 H	153	96.7	5.0
4	#6010.96	57.5 PK	68.2	-10.7	1.38 H	153	52.7	4.8
5	11510.00	56.3 PK	74.0	-17.7	1.23 H	19	42.3	14.0
6	11510.00	45.1 AV	54.0	-8.9	1.23 H	19	31.1	14.0
7	#17265.00	61.0 PK	74.0	-13.0	2.02 H	360	42.5	18.5
8	#17265.00	49.9 AV	54.0	-4.1	2.02 H	360	31.4	18.5

ANTENNA POLARITY & TEST DISTANCE: VERTICAL AT 3 M

NO.	FREQ. (MHz)	EMISSION LEVEL (dBuV/m)	LIMIT (dBuV/m)	MARGIN (dB)	ANTENNA HEIGHT (m)	TABLE ANGLE (Degree)	RAW VALUE (dBuV)	CORRECTION FACTOR (dB/m)
1	#5645.13	65.3 PK	68.2	-2.9	1.08 V	360	60.9	4.4
2	*5755.00	118.5 PK			1.08 V	360	113.5	5.0
3	*5755.00	109.4 AV			1.08 V	360	104.4	5.0
4	#5973.96	58.0 PK	68.2	-10.2	1.08 V	360	53.3	4.7
5	11510.00	50.6 PK	74.0	-23.4	2.16 V	333	36.6	14.0
6	11510.00	38.5 AV	54.0	-15.5	2.16 V	333	24.5	14.0
7	#17265.00	60.5 PK	74.0	-13.5	2.37 V	354	42.0	18.5
8	#17265.00	48.4 AV	54.0	-5.6	2.37 V	354	29.9	18.5

REMARKS:

1. Emission Level(dBuV/m) = Raw Value(dBuV) + Correction Factor(dB/m)
2. Correction Factor(dB/m) = Antenna Factor(dB/m) + Cable Factor(dB) – Pre-Amplifier Factor(dB)
3. The other emission levels were very low against the limit.
4. Margin value = Emission Level – Limit value
5. " * ": Fundamental frequency.
6. " # ": The radiated frequency is out of the restricted band.

CHANNEL	TX Channel 159	DETECTOR FUNCTION	Peak (PK)
FREQUENCY RANGE	1GHz ~ 40GHz		Average (AV)

ANTENNA POLARITY & TEST DISTANCE: HORIZONTAL AT 3 M

NO.	FREQ. (MHz)	EMISSION LEVEL (dBuV/m)	LIMIT (dBuV/m)	MARGIN (dB)	ANTENNA HEIGHT (m)	TABLE ANGLE (Degree)	RAW VALUE (dBuV)	CORRECTION FACTOR (dB/m)
1	#5596.48	59.2 PK	68.2	-9.0	1.39 H	151	54.9	4.3
2	*5795.00	111.9 PK			1.39 H	151	106.8	5.1
3	*5795.00	102.4 AV			1.39 H	151	97.3	5.1
4	#5966.17	58.6 PK	68.2	-9.6	1.39 H	151	53.9	4.7
5	11590.00	56.3 PK	74.0	-17.7	1.21 H	5	42.3	14.0
6	11590.00	45.2 AV	54.0	-8.8	1.21 H	5	31.2	14.0
7	#17385.00	60.9 PK	74.0	-13.1	2.02 H	360	41.8	19.1
8	#17385.00	49.7 AV	54.0	-4.3	2.02 H	360	30.6	19.1

ANTENNA POLARITY & TEST DISTANCE: VERTICAL AT 3 M

NO.	FREQ. (MHz)	EMISSION LEVEL (dBuV/m)	LIMIT (dBuV/m)	MARGIN (dB)	ANTENNA HEIGHT (m)	TABLE ANGLE (Degree)	RAW VALUE (dBuV)	CORRECTION FACTOR (dB/m)
1	#5583.62	59.8 PK	68.2	-8.4	1.12 V	360	55.6	4.2
2	*5795.00	118.9 PK			1.12 V	360	113.8	5.1
3	*5795.00	109.7 AV			1.12 V	360	104.6	5.1
4	#5924.63	58.9 PK	68.5	-9.6	1.12 V	360	54.2	4.7
5	11590.00	51.0 PK	74.0	-23.0	2.12 V	322	37.0	14.0
6	11590.00	38.8 AV	54.0	-15.2	2.12 V	322	24.8	14.0
7	#17385.00	59.9 PK	74.0	-14.1	2.35 V	352	40.8	19.1
8	#17385.00	48.0 AV	54.0	-6.0	2.35 V	352	28.9	19.1

REMARKS:

1. Emission Level(dBuV/m) = Raw Value(dBuV) + Correction Factor(dB/m)
2. Correction Factor(dB/m) = Antenna Factor(dB/m) + Cable Factor(dB) – Pre-Amplifier Factor(dB)
3. The other emission levels were very low against the limit.
4. Margin value = Emission Level – Limit value
5. " * ": Fundamental frequency.
6. " # ": The radiated frequency is out of the restricted band.

802.11ac (VHT80)

CHANNEL	TX Channel 42	DETECTOR FUNCTION	Peak (PK)
FREQUENCY RANGE	1GHz ~ 40GHz		Average (AV)

ANTENNA POLARITY & TEST DISTANCE: HORIZONTAL AT 3 M

NO.	FREQ. (MHz)	EMISSION LEVEL (dBuV/m)	LIMIT (dBuV/m)	MARGIN (dB)	ANTENNA HEIGHT (m)	TABLE ANGLE (Degree)	RAW VALUE (dBuV)	CORRECTION FACTOR (dB/m)
1	5150.00	60.3 PK	74.0	-13.7	2.62 H	95	56.3	4.0
2	5150.00	46.1 AV	54.0	-7.9	2.62 H	95	42.1	4.0
3	*5210.00	98.4 PK			2.62 H	95	94.3	4.1
4	*5210.00	89.2 AV			2.62 H	95	85.1	4.1
5	5350.00	51.6 PK	74.0	-22.4	2.62 H	95	47.2	4.4
6	5350.00	37.6 AV	54.0	-16.4	2.62 H	95	33.2	4.4
7	#10420.00	45.9 PK	74.0	-28.1	1.45 H	15	32.3	13.6
8	#10420.00	34.5 AV	54.0	-19.5	1.45 H	15	20.9	13.6
9	15630.00	58.6 PK	74.0	-15.4	1.38 H	360	45.0	13.6
10	15630.00	46.5 AV	54.0	-7.5	1.38 H	360	32.9	13.6

ANTENNA POLARITY & TEST DISTANCE: VERTICAL AT 3 M

NO.	FREQ. (MHz)	EMISSION LEVEL (dBuV/m)	LIMIT (dBuV/m)	MARGIN (dB)	ANTENNA HEIGHT (m)	TABLE ANGLE (Degree)	RAW VALUE (dBuV)	CORRECTION FACTOR (dB/m)
1	5150.00	64.8 PK	74.0	-9.2	2.23 V	178	60.8	4.0
2	5150.00	53.9 AV	54.0	-0.1	2.23 V	178	49.9	4.0
3	*5210.00	107.7 PK			2.23 V	178	103.6	4.1
4	*5210.00	98.6 AV			2.23 V	178	94.5	4.1
5	5350.00	56.1 PK	74.0	-17.9	2.23 V	178	51.7	4.4
6	5350.00	45.4 AV	54.0	-8.6	2.23 V	178	41.0	4.4
7	#10420.00	51.1 PK	74.0	-22.9	1.18 V	297	37.5	13.6
8	#10420.00	38.5 AV	54.0	-15.5	1.18 V	297	24.9	13.6
9	15630.00	56.8 PK	74.0	-17.2	2.17 V	360	43.2	13.6
10	15630.00	44.0 AV	54.0	-10.0	2.17 V	360	30.4	13.6

REMARKS:

- Emission Level(dBuV/m) = Raw Value(dBuV) + Correction Factor(dB/m)
- Correction Factor(dB/m) = Antenna Factor(dB/m) + Cable Factor(dB) – Pre-Amplifier Factor(dB)
- The other emission levels were very low against the limit.
- Margin value = Emission Level – Limit value
- " * ": Fundamental frequency.
- " # ": The radiated frequency is out of the restricted band.

CHANNEL	TX Channel 155	DETECTOR FUNCTION	Peak (PK)
FREQUENCY RANGE	1GHz ~ 40GHz		Average (AV)

ANTENNA POLARITY & TEST DISTANCE: HORIZONTAL AT 3 M

NO.	FREQ. (MHz)	EMISSION LEVEL (dBuV/m)	LIMIT (dBuV/m)	MARGIN (dB)	ANTENNA HEIGHT (m)	TABLE ANGLE (Degree)	RAW VALUE (dBuV)	CORRECTION FACTOR (dB/m)
1	#5616.48	60.1 PK	68.2	-8.1	1.37 H	151	55.7	4.4
2	*5775.00	103.8 PK			1.37 H	151	98.8	5.0
3	*5775.00	95.2 AV			1.37 H	151	90.2	5.0
4	#5961.20	57.9 PK	68.2	-10.3	1.37 H	151	53.2	4.7
5	11550.00	56.3 PK	74.0	-17.7	1.23 H	5	42.3	14.0
6	11550.00	45.1 AV	54.0	-8.9	1.23 H	5	31.1	14.0
7	#17325.00	60.5 PK	74.0	-13.5	1.98 H	360	41.9	18.6
8	#17325.00	49.4 AV	54.0	-4.6	1.98 H	360	30.8	18.6

ANTENNA POLARITY & TEST DISTANCE: VERTICAL AT 3 M

NO.	FREQ. (MHz)	EMISSION LEVEL (dBuV/m)	LIMIT (dBuV/m)	MARGIN (dB)	ANTENNA HEIGHT (m)	TABLE ANGLE (Degree)	RAW VALUE (dBuV)	CORRECTION FACTOR (dB/m)
1	#5642.44	65.8 PK	68.2	-2.4	2.47 V	167	61.4	4.4
2	*5775.00	113.9 PK			2.47 V	167	108.9	5.0
3	*5775.00	105.4 AV			2.47 V	167	100.4	5.0
4	#5925.73	68.1 PK	68.2	-0.1	2.47 V	167	63.4	4.7
5	11550.00	50.9 PK	74.0	-23.1	2.16 V	316	36.9	14.0
6	11550.00	38.5 AV	54.0	-15.5	2.16 V	316	24.5	14.0
7	#17325.00	60.1 PK	74.0	-13.9	2.33 V	356	41.5	18.6
8	#17325.00	48.0 AV	54.0	-6.0	2.33 V	356	29.4	18.6

REMARKS:

1. Emission Level(dBuV/m) = Raw Value(dBuV) + Correction Factor(dB/m)
2. Correction Factor(dB/m) = Antenna Factor(dB/m) + Cable Factor(dB) – Pre-Amplifier Factor(dB)
3. The other emission levels were very low against the limit.
4. Margin value = Emission Level – Limit value
5. " * ": Fundamental frequency.
6. " # ": The radiated frequency is out of the restricted band.

Below 1GHz Data:

802.11a

CHANNEL	TX Channel 40	DETECTOR FUNCTION	Quasi-Peak (QP)
FREQUENCY RANGE	9kHz ~ 1GHz		

ANTENNA POLARITY & TEST DISTANCE: HORIZONTAL AT 3 M

NO.	FREQ. (MHz)	EMISSION LEVEL (dBuV/m)	LIMIT (dBuV/m)	MARGIN (dB)	ANTENNA HEIGHT (m)	TABLE ANGLE (Degree)	RAW VALUE (dBuV)	CORRECTION FACTOR (dB/m)
1	125.05	38.4 QP	43.5	-5.1	1.32 H	243	48.0	-9.6
2	249.22	33.5 QP	46.0	-12.5	1.56 H	289	43.0	-9.5
3	332.88	39.1 QP	46.0	-6.9	1.24 H	301	45.8	-6.7
4	431.58	40.4 QP	46.0	-5.6	1.52 H	189	44.4	-4.0
5	483.96	39.8 QP	46.0	-6.2	1.00 H	247	42.9	-3.1
6	951.50	37.2 QP	46.0	-8.8	1.15 H	287	32.6	4.6

ANTENNA POLARITY & TEST DISTANCE: VERTICAL AT 3 M

NO.	FREQ. (MHz)	EMISSION LEVEL (dBuV/m)	LIMIT (dBuV/m)	MARGIN (dB)	ANTENNA HEIGHT (m)	TABLE ANGLE (Degree)	RAW VALUE (dBuV)	CORRECTION FACTOR (dB/m)
1	38.11	35.4 QP	40.0	-4.6	1.55 V	218	43.7	-8.3
2	93.62	35.4 QP	43.5	-8.1	1.53 V	274	49.3	-13.9
3	124.99	34.6 QP	43.5	-8.9	1.34 V	169	44.2	-9.6
4	334.10	38.4 QP	46.0	-7.6	1.00 V	221	45.1	-6.7
5	479.40	36.3 QP	46.0	-9.7	1.56 V	179	39.3	-3.0
6	951.45	37.1 QP	46.0	-8.9	1.41 V	279	32.5	4.6

REMARKS:

1. Emission Level(dBuV/m) = Raw Value(dBuV) + Correction Factor(dB/m)
2. Correction Factor(dB/m) = Antenna Factor(dB/m) + Cable Factor(dB) – Pre-Amplifier Factor(dB)
3. The other emission levels were very low against the limit.
4. Margin value = Emission Level – Limit value

4.1.8 Test Results (Mode 3)

Above 1GHz Data:

802.11a

CHANNEL	TX Channel 36	DETECTOR FUNCTION	Peak (PK)
FREQUENCY RANGE	1GHz ~ 40GHz		Average (AV)

ANTENNA POLARITY & TEST DISTANCE: HORIZONTAL AT 3 M								
NO.	FREQ. (MHz)	EMISSION LEVEL (dBuV/m)	LIMIT (dBuV/m)	MARGIN (dB)	ANTENNA HEIGHT (m)	TABLE ANGLE (Degree)	RAW VALUE (dBuV)	CORRECTION FACTOR (dB/m)
1	5150.00	50.6 PK	74.0	-23.4	1.66 H	94	46.6	4.0
2	5150.00	39.3 AV	54.0	-14.7	1.66 H	94	35.3	4.0
3	*5180.00	108.1 PK			1.66 H	94	104.1	4.0
4	*5180.00	98.1 AV			1.66 H	94	94.1	4.0
5	#10360.00	44.4 PK	74.0	-29.6	1.53 H	26	30.8	13.6
6	#10360.00	33.2 AV	54.0	-20.8	1.53 H	26	19.6	13.6
7	15540.00	56.6 PK	74.0	-17.4	1.21 H	359	43.4	13.2
8	15540.00	43.4 AV	54.0	-10.6	1.21 H	359	30.2	13.2

ANTENNA POLARITY & TEST DISTANCE: VERTICAL AT 3 M								
NO.	FREQ. (MHz)	EMISSION LEVEL (dBuV/m)	LIMIT (dBuV/m)	MARGIN (dB)	ANTENNA HEIGHT (m)	TABLE ANGLE (Degree)	RAW VALUE (dBuV)	CORRECTION FACTOR (dB/m)
1	5150.00	62.9 PK	74.0	-11.1	1.20 V	3	58.9	4.0
2	5150.00	51.8 AV	54.0	-2.2	1.20 V	3	47.8	4.0
3	*5180.00	122.1 PK			1.20 V	3	118.1	4.0
4	*5180.00	112.4 AV			1.20 V	3	108.4	4.0
5	#10360.00	49.0 PK	74.0	-25.0	1.30 V	293	35.4	13.6
6	#10360.00	36.0 AV	54.0	-18.0	1.30 V	293	22.4	13.6
7	15540.00	53.3 PK	74.0	-20.7	2.13 V	333	40.1	13.2
8	15540.00	39.8 AV	54.0	-14.2	2.13 V	333	26.6	13.2

REMARKS:

1. Emission Level(dBuV/m) = Raw Value(dBuV) + Correction Factor(dB/m)
2. Correction Factor(dB/m) = Antenna Factor(dB/m) + Cable Factor(dB) – Pre-Amplifier Factor(dB)
3. The other emission levels were very low against the limit.
4. Margin value = Emission Level – Limit value
5. " * ": Fundamental frequency.
6. " # ": The radiated frequency is out of the restricted band.

CHANNEL	TX Channel 40	DETECTOR FUNCTION	Peak (PK)
FREQUENCY RANGE	1GHz ~ 40GHz		Average (AV)

ANTENNA POLARITY & TEST DISTANCE: HORIZONTAL AT 3 M

NO.	FREQ. (MHz)	EMISSION LEVEL (dBuV/m)	LIMIT (dBuV/m)	MARGIN (dB)	ANTENNA HEIGHT (m)	TABLE ANGLE (Degree)	RAW VALUE (dBuV)	CORRECTION FACTOR (dB/m)
1	5150.00	50.9 PK	74.0	-23.1	1.60 H	95	46.9	4.0
2	5150.00	37.2 AV	54.0	-16.8	1.60 H	95	33.2	4.0
3	*5200.00	108.8 PK			1.60 H	95	104.8	4.0
4	*5200.00	98.9 AV			1.60 H	95	94.9	4.0
5	5350.00	42.1 PK	74.0	-31.9	1.60 H	95	37.7	4.4
6	5350.00	31.7 AV	54.0	-22.3	1.60 H	95	27.3	4.4
7	#10400.00	46.4 PK	74.0	-27.6	1.47 H	24	32.8	13.6
8	#10400.00	35.2 AV	54.0	-18.8	1.47 H	24	21.6	13.6
9	15600.00	55.9 PK	74.0	-18.1	1.21 H	360	42.5	13.4
10	15600.00	43.0 AV	54.0	-11.0	1.21 H	360	29.6	13.4

ANTENNA POLARITY & TEST DISTANCE: VERTICAL AT 3 M

NO.	FREQ. (MHz)	EMISSION LEVEL (dBuV/m)	LIMIT (dBuV/m)	MARGIN (dB)	ANTENNA HEIGHT (m)	TABLE ANGLE (Degree)	RAW VALUE (dBuV)	CORRECTION FACTOR (dB/m)
1	5150.00	63.2 PK	74.0	-10.8	1.12 V	2	59.2	4.0
2	5150.00	49.7 AV	54.0	-4.3	1.12 V	2	45.7	4.0
3	*5200.00	122.8 PK			1.12 V	2	118.8	4.0
4	*5200.00	113.2 AV			1.12 V	2	109.2	4.0
5	5350.00	50.4 PK	74.0	-23.6	1.12 V	2	46.0	4.4
6	5350.00	40.2 AV	54.0	-13.8	1.12 V	2	35.8	4.4
7	#10400.00	51.0 PK	74.0	-23.0	1.24 V	297	37.4	13.6
8	#10400.00	38.0 AV	54.0	-16.0	1.24 V	297	24.4	13.6
9	15600.00	53.0 PK	74.0	-21.0	2.17 V	347	39.6	13.4
10	15600.00	39.8 AV	54.0	-14.2	2.17 V	347	26.4	13.4

REMARKS:

- Emission Level(dBuV/m) = Raw Value(dBuV) + Correction Factor(dB/m)
- Correction Factor(dB/m) = Antenna Factor(dB/m) + Cable Factor(dB) – Pre-Amplifier Factor(dB)
- The other emission levels were very low against the limit.
- Margin value = Emission Level – Limit value
- " * ": Fundamental frequency.
- " # ": The radiated frequency is out of the restricted band.

CHANNEL	TX Channel 48	DETECTOR FUNCTION	Peak (PK)
FREQUENCY RANGE	1GHz ~ 40GHz		Average (AV)

ANTENNA POLARITY & TEST DISTANCE: HORIZONTAL AT 3 M

NO.	FREQ. (MHz)	EMISSION LEVEL (dBuV/m)	LIMIT (dBuV/m)	MARGIN (dB)	ANTENNA HEIGHT (m)	TABLE ANGLE (Degree)	RAW VALUE (dBuV)	CORRECTION FACTOR (dB/m)
1	*5240.00	108.7 PK			1.59 H	84	104.5	4.2
2	*5240.00	98.5 AV			1.59 H	84	94.3	4.2
3	5350.00	44.6 PK	74.0	-29.4	1.59 H	84	40.2	4.4
4	5350.00	33.0 AV	54.0	-21.0	1.59 H	84	28.6	4.4
5	#10480.00	46.5 PK	74.0	-27.5	1.49 H	12	32.8	13.7
6	#10480.00	35.1 AV	54.0	-18.9	1.49 H	12	21.4	13.7
7	15720.00	55.8 PK	74.0	-18.2	1.16 H	360	41.8	14.0
8	15720.00	43.1 AV	54.0	-10.9	1.16 H	360	29.1	14.0

ANTENNA POLARITY & TEST DISTANCE: VERTICAL AT 3 M

NO.	FREQ. (MHz)	EMISSION LEVEL (dBuV/m)	LIMIT (dBuV/m)	MARGIN (dB)	ANTENNA HEIGHT (m)	TABLE ANGLE (Degree)	RAW VALUE (dBuV)	CORRECTION FACTOR (dB/m)
1	*5240.00	122.7 PK			1.17 V	3	118.5	4.2
2	*5240.00	112.8 AV			1.17 V	3	108.6	4.2
3	5350.00	51.9 PK	74.0	-22.1	1.17 V	3	47.5	4.4
4	5350.00	40.5 AV	54.0	-13.5	1.17 V	3	36.1	4.4
5	#10480.00	51.2 PK	74.0	-22.8	1.25 V	301	37.5	13.7
6	#10480.00	38.0 AV	54.0	-16.0	1.25 V	301	24.3	13.7
7	15720.00	52.9 PK	74.0	-21.1	2.17 V	340	38.9	14.0
8	15720.00	39.9 AV	54.0	-14.1	2.17 V	340	25.9	14.0

REMARKS:

1. Emission Level(dBuV/m) = Raw Value(dBuV) + Correction Factor(dB/m)
2. Correction Factor(dB/m) = Antenna Factor(dB/m) + Cable Factor(dB) – Pre-Amplifier Factor(dB)
3. The other emission levels were very low against the limit.
4. Margin value = Emission Level – Limit value
5. " * ": Fundamental frequency.
6. " # ": The radiated frequency is out of the restricted band.

CHANNEL	TX Channel 149	DETECTOR FUNCTION	Peak (PK)
FREQUENCY RANGE	1GHz ~ 40GHz		Average (AV)

ANTENNA POLARITY & TEST DISTANCE: HORIZONTAL AT 3 M

NO.	FREQ. (MHz)	EMISSION LEVEL (dBuV/m)	LIMIT (dBuV/m)	MARGIN (dB)	ANTENNA HEIGHT (m)	TABLE ANGLE (Degree)	RAW VALUE (dBuV)	CORRECTION FACTOR (dB/m)
1	#5639.73	61.8 PK	68.2	-6.4	3.30 H	85	57.4	4.4
2	*5745.00	117.0 PK			3.30 H	85	112.0	5.0
3	*5745.00	106.0 AV			3.30 H	85	101.0	5.0
4	#5995.62	59.9 PK	68.2	-8.3	3.30 H	85	55.2	4.7
5	11490.00	48.6 PK	74.0	-25.4	1.75 H	222	34.5	14.1
6	11490.00	36.5 AV	54.0	-17.5	1.75 H	222	22.4	14.1
7	#17235.00	51.3 PK	74.0	-22.7	1.66 H	155	33.0	18.3
8	#17235.00	40.6 AV	54.0	-13.4	1.66 H	155	22.3	18.3

ANTENNA POLARITY & TEST DISTANCE: VERTICAL AT 3 M

NO.	FREQ. (MHz)	EMISSION LEVEL (dBuV/m)	LIMIT (dBuV/m)	MARGIN (dB)	ANTENNA HEIGHT (m)	TABLE ANGLE (Degree)	RAW VALUE (dBuV)	CORRECTION FACTOR (dB/m)
1	#5641.40	68.0 PK	68.2	-0.2	1.14 V	2	63.6	4.4
2	*5745.00	123.1 PK			1.14 V	2	118.1	5.0
3	*5745.00	113.2 AV			1.14 V	2	108.2	5.0
4	#5986.94	59.5 PK	68.2	-8.7	1.14 V	2	54.8	4.7
5	11490.00	50.6 PK	74.0	-23.4	1.06 V	12	36.5	14.1
6	11490.00	38.4 AV	54.0	-15.6	1.06 V	12	24.3	14.1
7	#17235.00	50.5 PK	74.0	-23.5	1.56 V	166	32.2	18.3
8	#17235.00	38.6 AV	54.0	-15.4	1.56 V	166	20.3	18.3

REMARKS:

1. Emission Level(dBuV/m) = Raw Value(dBuV) + Correction Factor(dB/m)
2. Correction Factor(dB/m) = Antenna Factor(dB/m) + Cable Factor(dB) – Pre-Amplifier Factor(dB)
3. The other emission levels were very low against the limit.
4. Margin value = Emission Level – Limit value
5. " * ": Fundamental frequency.
6. " # ": The radiated frequency is out of the restricted band.

CHANNEL	TX Channel 157	DETECTOR FUNCTION	Peak (PK)
FREQUENCY RANGE	1GHz ~ 40GHz		Average (AV)

ANTENNA POLARITY & TEST DISTANCE: HORIZONTAL AT 3 M

NO.	FREQ. (MHz)	EMISSION LEVEL (dBuV/m)	LIMIT (dBuV/m)	MARGIN (dB)	ANTENNA HEIGHT (m)	TABLE ANGLE (Degree)	RAW VALUE (dBuV)	CORRECTION FACTOR (dB/m)
1	#5629.79	60.2 PK	68.2	-8.0	3.31 H	88	55.8	4.4
2	*5785.00	116.2 PK			3.31 H	88	111.2	5.0
3	*5785.00	105.9 AV			3.31 H	88	100.9	5.0
4	#5985.75	60.3 PK	68.2	-7.9	3.31 H	88	55.6	4.7
5	11570.00	48.5 PK	74.0	-25.5	1.81 H	214	34.5	14.0
6	11570.00	36.7 AV	54.0	-17.3	1.81 H	214	22.7	14.0
7	#17355.00	51.5 PK	74.0	-22.5	1.64 H	151	32.6	18.9
8	#17355.00	40.7 AV	54.0	-13.3	1.64 H	151	21.8	18.9

ANTENNA POLARITY & TEST DISTANCE: VERTICAL AT 3 M

NO.	FREQ. (MHz)	EMISSION LEVEL (dBuV/m)	LIMIT (dBuV/m)	MARGIN (dB)	ANTENNA HEIGHT (m)	TABLE ANGLE (Degree)	RAW VALUE (dBuV)	CORRECTION FACTOR (dB/m)
1	#5603.03	61.6 PK	68.2	-6.6	1.10 V	4	57.2	4.4
2	*5785.00	123.0 PK			1.10 V	4	118.0	5.0
3	*5785.00	113.1 AV			1.10 V	4	108.1	5.0
4	#5947.21	61.0 PK	68.2	-7.2	1.10 V	4	56.3	4.7
5	11570.00	50.8 PK	74.0	-23.2	1.06 V	10	36.8	14.0
6	11570.00	38.7 AV	54.0	-15.3	1.06 V	10	24.7	14.0
7	#17355.00	50.5 PK	74.0	-23.5	1.61 V	159	31.6	18.9
8	#17355.00	38.5 AV	54.0	-15.5	1.61 V	159	19.6	18.9

REMARKS:

1. Emission Level(dBuV/m) = Raw Value(dBuV) + Correction Factor(dB/m)
2. Correction Factor(dB/m) = Antenna Factor(dB/m) + Cable Factor(dB) – Pre-Amplifier Factor(dB)
3. The other emission levels were very low against the limit.
4. Margin value = Emission Level – Limit value
5. " * ": Fundamental frequency.
6. " # ": The radiated frequency is out of the restricted band.

CHANNEL	TX Channel 165	DETECTOR FUNCTION	Peak (PK)
FREQUENCY RANGE	1GHz ~ 40GHz		Average (AV)

ANTENNA POLARITY & TEST DISTANCE: HORIZONTAL AT 3 M

NO.	FREQ. (MHz)	EMISSION LEVEL (dBuV/m)	LIMIT (dBuV/m)	MARGIN (dB)	ANTENNA HEIGHT (m)	TABLE ANGLE (Degree)	RAW VALUE (dBuV)	CORRECTION FACTOR (dB/m)
1	#5623.09	60.4 PK	68.2	-7.8	3.28 H	85	56.0	4.4
2	*5825.00	114.9 PK			3.28 H	85	109.7	5.2
3	*5825.00	105.2 AV			3.28 H	85	100.0	5.2
4	#5995.00	60.7 PK	68.2	-7.5	3.28 H	85	56.0	4.7
5	11650.00	48.2 PK	74.0	-25.8	1.77 H	203	34.1	14.1
6	11650.00	36.6 AV	54.0	-17.4	1.77 H	203	22.5	14.1
7	#17475.00	51.7 PK	74.0	-22.3	1.62 H	159	32.0	19.7
8	#17475.00	40.7 AV	54.0	-13.3	1.62 H	159	21.0	19.7

ANTENNA POLARITY & TEST DISTANCE: VERTICAL AT 3 M

NO.	FREQ. (MHz)	EMISSION LEVEL (dBuV/m)	LIMIT (dBuV/m)	MARGIN (dB)	ANTENNA HEIGHT (m)	TABLE ANGLE (Degree)	RAW VALUE (dBuV)	CORRECTION FACTOR (dB/m)
1	#5597.58	60.4 PK	68.2	-7.8	1.08 V	3	56.0	4.4
2	*5825.00	122.6 PK			1.08 V	3	117.4	5.2
3	*5825.00	112.4 AV			1.08 V	3	107.2	5.2
4	#5934.90	61.1 PK	68.2	-7.1	1.08 V	3	56.4	4.7
5	11650.00	50.9 PK	74.0	-23.1	1.10 V	0	36.8	14.1
6	11650.00	39.1 AV	54.0	-14.9	1.10 V	0	25.0	14.1
7	#17475.00	50.5 PK	74.0	-23.5	1.61 V	146	30.8	19.7
8	#17475.00	38.3 AV	54.0	-15.7	1.61 V	146	18.6	19.7

REMARKS:

1. Emission Level(dBuV/m) = Raw Value(dBuV) + Correction Factor(dB/m)
2. Correction Factor(dB/m) = Antenna Factor(dB/m) + Cable Factor(dB) – Pre-Amplifier Factor(dB)
3. The other emission levels were very low against the limit.
4. Margin value = Emission Level – Limit value
5. " * ": Fundamental frequency.
6. " # ": The radiated frequency is out of the restricted band.

802.11ac (VHT20)

CHANNEL	TX Channel 36	DETECTOR FUNCTION	Peak (PK)
FREQUENCY RANGE	1GHz ~ 40GHz		Average (AV)

ANTENNA POLARITY & TEST DISTANCE: HORIZONTAL AT 3 M								
NO.	FREQ. (MHz)	EMISSION LEVEL (dBuV/m)	LIMIT (dBuV/m)	MARGIN (dB)	ANTENNA HEIGHT (m)	TABLE ANGLE (Degree)	RAW VALUE (dBuV)	CORRECTION FACTOR (dB/m)
1	5150.00	52.6 PK	74.0	-21.4	1.68 H	99	48.6	4.0
2	5150.00	39.1 AV	54.0	-14.9	1.68 H	99	35.1	4.0
3	*5180.00	108.0 PK			1.68 H	99	104.0	4.0
4	*5180.00	97.3 AV			1.68 H	99	93.3	4.0
5	#10360.00	45.9 PK	74.0	-28.1	1.42 H	31	32.3	13.6
6	#10360.00	34.9 AV	54.0	-19.1	1.42 H	31	21.3	13.6
7	15540.00	55.7 PK	74.0	-18.3	1.15 H	360	42.5	13.2
8	15540.00	43.0 AV	54.0	-11.0	1.15 H	360	29.8	13.2

ANTENNA POLARITY & TEST DISTANCE: VERTICAL AT 3 M								
NO.	FREQ. (MHz)	EMISSION LEVEL (dBuV/m)	LIMIT (dBuV/m)	MARGIN (dB)	ANTENNA HEIGHT (m)	TABLE ANGLE (Degree)	RAW VALUE (dBuV)	CORRECTION FACTOR (dB/m)
1	5150.00	64.9 PK	74.0	-9.1	1.03 V	3	60.9	4.0
2	5150.00	51.6 AV	54.0	-2.4	1.03 V	3	47.6	4.0
3	*5180.00	122.0 PK			1.03 V	3	118.0	4.0
4	*5180.00	111.6 AV			1.03 V	3	107.6	4.0
5	#10360.00	51.1 PK	74.0	-22.9	1.18 V	294	37.5	13.6
6	#10360.00	37.9 AV	54.0	-16.1	1.18 V	294	24.3	13.6
7	15540.00	52.9 PK	74.0	-21.1	2.19 V	335	39.7	13.2
8	15540.00	39.7 AV	54.0	-14.3	2.19 V	335	26.5	13.2

REMARKS:

1. Emission Level(dBuV/m) = Raw Value(dBuV) + Correction Factor(dB/m)
2. Correction Factor(dB/m) = Antenna Factor(dB/m) + Cable Factor(dB) – Pre-Amplifier Factor(dB)
3. The other emission levels were very low against the limit.
4. Margin value = Emission Level – Limit value
5. " * ": Fundamental frequency.
6. " # ": The radiated frequency is out of the restricted band.

CHANNEL	TX Channel 40	DETECTOR FUNCTION	Peak (PK)
FREQUENCY RANGE	1GHz ~ 40GHz		Average (AV)

ANTENNA POLARITY & TEST DISTANCE: HORIZONTAL AT 3 M

NO.	FREQ. (MHz)	EMISSION LEVEL (dBuV/m)	LIMIT (dBuV/m)	MARGIN (dB)	ANTENNA HEIGHT (m)	TABLE ANGLE (Degree)	RAW VALUE (dBuV)	CORRECTION FACTOR (dB/m)
1	5150.00	50.2 PK	74.0	-23.8	1.63 H	103	46.2	4.0
2	5150.00	37.4 AV	54.0	-16.6	1.63 H	103	33.4	4.0
3	*5200.00	107.9 PK			1.63 H	103	103.9	4.0
4	*5200.00	97.5 AV			1.63 H	103	93.5	4.0
5	5350.00	48.4 PK	74.0	-25.6	1.63 H	103	44.0	4.4
6	5350.00	37.1 AV	54.0	-16.9	1.63 H	103	32.7	4.4
7	#10400.00	47.0 PK	74.0	-27.0	1.51 H	29	33.4	13.6
8	#10400.00	35.5 AV	54.0	-18.5	1.51 H	29	21.9	13.6
9	15600.00	55.8 PK	74.0	-18.2	1.21 H	360	42.4	13.4
10	15600.00	42.7 AV	54.0	-11.3	1.21 H	360	29.3	13.4

ANTENNA POLARITY & TEST DISTANCE: VERTICAL AT 3 M

NO.	FREQ. (MHz)	EMISSION LEVEL (dBuV/m)	LIMIT (dBuV/m)	MARGIN (dB)	ANTENNA HEIGHT (m)	TABLE ANGLE (Degree)	RAW VALUE (dBuV)	CORRECTION FACTOR (dB/m)
1	5150.00	62.2 PK	74.0	-11.8	1.04 V	4	58.2	4.0
2	5150.00	49.6 AV	54.0	-4.4	1.04 V	4	45.6	4.0
3	*5200.00	121.9 PK			1.04 V	4	117.9	4.0
4	*5200.00	111.8 AV			1.04 V	4	107.8	4.0
5	5350.00	49.9 PK	74.0	-24.1	1.04 V	4	45.5	4.4
6	5350.00	38.6 AV	54.0	-15.4	1.04 V	4	34.2	4.4
7	#10400.00	51.2 PK	74.0	-22.8	1.26 V	300	37.6	13.6
8	#10400.00	38.0 AV	54.0	-16.0	1.26 V	300	24.4	13.6
9	15600.00	53.0 PK	74.0	-21.0	2.16 V	335	39.6	13.4
10	15600.00	39.7 AV	54.0	-14.3	2.16 V	335	26.3	13.4

REMARKS:

1. Emission Level(dBuV/m) = Raw Value(dBuV) + Correction Factor(dB/m)
2. Correction Factor(dB/m) = Antenna Factor(dB/m) + Cable Factor(dB) – Pre-Amplifier Factor(dB)
3. The other emission levels were very low against the limit.
4. Margin value = Emission Level – Limit value
5. " * ": Fundamental frequency.
6. " # ": The radiated frequency is out of the restricted band.

CHANNEL	TX Channel 48	DETECTOR FUNCTION	Peak (PK)
FREQUENCY RANGE	1GHz ~ 40GHz		Average (AV)

ANTENNA POLARITY & TEST DISTANCE: HORIZONTAL AT 3 M

NO.	FREQ. (MHz)	EMISSION LEVEL (dBuV/m)	LIMIT (dBuV/m)	MARGIN (dB)	ANTENNA HEIGHT (m)	TABLE ANGLE (Degree)	RAW VALUE (dBuV)	CORRECTION FACTOR (dB/m)
1	*5240.00	107.3 PK			1.58 H	95	103.1	4.2
2	*5240.00	97.2 AV			1.58 H	95	93.0	4.2
3	5350.00	49.6 PK	74.0	-24.4	1.58 H	95	45.2	4.4
4	5350.00	37.4 AV	54.0	-16.6	1.58 H	95	33.0	4.4
5	#10480.00	46.1 PK	74.0	-27.9	1.52 H	18	32.4	13.7
6	#10480.00	35.1 AV	54.0	-18.9	1.52 H	18	21.4	13.7
7	15720.00	55.4 PK	74.0	-18.6	1.19 H	360	41.4	14.0
8	15720.00	42.6 AV	54.0	-11.4	1.19 H	360	28.6	14.0

ANTENNA POLARITY & TEST DISTANCE: VERTICAL AT 3 M

NO.	FREQ. (MHz)	EMISSION LEVEL (dBuV/m)	LIMIT (dBuV/m)	MARGIN (dB)	ANTENNA HEIGHT (m)	TABLE ANGLE (Degree)	RAW VALUE (dBuV)	CORRECTION FACTOR (dB/m)
1	*5240.00	121.3 PK			1.10 V	4	117.1	4.2
2	*5240.00	111.5 AV			1.10 V	4	107.3	4.2
3	5350.00	50.4 PK	74.0	-23.6	1.10 V	4	46.0	4.4
4	5350.00	38.7 AV	54.0	-15.3	1.10 V	4	34.3	4.4
5	#10480.00	51.0 PK	74.0	-23.0	1.18 V	313	37.3	13.7
6	#10480.00	38.0 AV	54.0	-16.0	1.18 V	313	24.3	13.7
7	15720.00	53.0 PK	74.0	-21.0	2.21 V	359	39.0	14.0
8	15720.00	39.8 AV	54.0	-14.2	2.21 V	359	25.8	14.0

REMARKS:

1. Emission Level(dBuV/m) = Raw Value(dBuV) + Correction Factor(dB/m)
2. Correction Factor(dB/m) = Antenna Factor(dB/m) + Cable Factor(dB) – Pre-Amplifier Factor(dB)
3. The other emission levels were very low against the limit.
4. Margin value = Emission Level – Limit value
5. " * ": Fundamental frequency.
6. " # ": The radiated frequency is out of the restricted band.

CHANNEL	TX Channel 149	DETECTOR FUNCTION	Peak (PK)
FREQUENCY RANGE	1GHz ~ 40GHz		Average (AV)

ANTENNA POLARITY & TEST DISTANCE: HORIZONTAL AT 3 M

NO.	FREQ. (MHz)	EMISSION LEVEL (dBuV/m)	LIMIT (dBuV/m)	MARGIN (dB)	ANTENNA HEIGHT (m)	TABLE ANGLE (Degree)	RAW VALUE (dBuV)	CORRECTION FACTOR (dB/m)
1	#5636.63	60.6 PK	68.2	-7.6	1.45 H	85	56.2	4.4
2	*5745.00	113.9 PK			1.45 H	85	108.9	5.0
3	*5745.00	103.3 AV			1.45 H	85	98.3	5.0
4	#5986.76	59.6 PK	68.2	-8.6	1.45 H	85	54.9	4.7
5	11490.00	49.0 PK	74.0	-25.0	1.73 H	209	34.9	14.1
6	11490.00	36.8 AV	54.0	-17.2	1.73 H	209	22.7	14.1
7	#17235.00	51.9 PK	74.0	-22.1	1.61 H	156	33.6	18.3
8	#17235.00	41.0 AV	54.0	-13.0	1.61 H	156	22.7	18.3

ANTENNA POLARITY & TEST DISTANCE: VERTICAL AT 3 M

NO.	FREQ. (MHz)	EMISSION LEVEL (dBuV/m)	LIMIT (dBuV/m)	MARGIN (dB)	ANTENNA HEIGHT (m)	TABLE ANGLE (Degree)	RAW VALUE (dBuV)	CORRECTION FACTOR (dB/m)
1	#5630.70	61.9 PK	68.2	-6.3	1.08 V	2	57.5	4.4
2	*5745.00	121.7 PK			1.08 V	2	116.7	5.0
3	*5745.00	112.6 AV			1.08 V	2	107.6	5.0
4	#5935.40	59.7 PK	68.2	-8.5	1.08 V	2	55.0	4.7
5	11490.00	50.4 PK	74.0	-23.6	1.12 V	2	36.3	14.1
6	11490.00	38.1 AV	54.0	-15.9	1.12 V	2	24.0	14.1
7	#17235.00	50.2 PK	74.0	-23.8	1.55 V	150	31.9	18.3
8	#17235.00	38.3 AV	54.0	-15.7	1.55 V	150	20.0	18.3

REMARKS:

1. Emission Level(dBuV/m) = Raw Value(dBuV) + Correction Factor(dB/m)
2. Correction Factor(dB/m) = Antenna Factor(dB/m) + Cable Factor(dB) – Pre-Amplifier Factor(dB)
3. The other emission levels were very low against the limit.
4. Margin value = Emission Level – Limit value
5. " * ": Fundamental frequency.
6. " # ": The radiated frequency is out of the restricted band.

CHANNEL	TX Channel 157	DETECTOR FUNCTION	Peak (PK)
FREQUENCY RANGE	1GHz ~ 40GHz		Average (AV)

ANTENNA POLARITY & TEST DISTANCE: HORIZONTAL AT 3 M

NO.	FREQ. (MHz)	EMISSION LEVEL (dBuV/m)	LIMIT (dBuV/m)	MARGIN (dB)	ANTENNA HEIGHT (m)	TABLE ANGLE (Degree)	RAW VALUE (dBuV)	CORRECTION FACTOR (dB/m)
1	#5633.28	60.8 PK	68.2	-7.4	1.32 H	84	56.4	4.4
2	*5785.00	112.6 PK			1.32 H	84	107.6	5.0
3	*5785.00	103.4 AV			1.32 H	84	98.4	5.0
4	#5925.37	59.7 PK	68.2	-8.5	1.32 H	84	55.0	4.7
5	11570.00	48.9 PK	74.0	-25.1	1.79 H	224	34.9	14.0
6	11570.00	37.0 AV	54.0	-17.0	1.79 H	224	23.0	14.0
7	#17355.00	51.1 PK	74.0	-22.9	1.67 H	168	32.2	18.9
8	#17355.00	40.3 AV	54.0	-13.7	1.67 H	168	21.4	18.9

ANTENNA POLARITY & TEST DISTANCE: VERTICAL AT 3 M

NO.	FREQ. (MHz)	EMISSION LEVEL (dBuV/m)	LIMIT (dBuV/m)	MARGIN (dB)	ANTENNA HEIGHT (m)	TABLE ANGLE (Degree)	RAW VALUE (dBuV)	CORRECTION FACTOR (dB/m)
1	#5640.59	61.2 PK	68.2	-7.0	1.07 V	3	56.8	4.4
2	*5785.00	122.5 PK			1.07 V	3	117.5	5.0
3	*5785.00	112.9 AV			1.07 V	3	107.9	5.0
4	#5958.56	59.3 PK	68.2	-8.9	1.07 V	3	54.6	4.7
5	11570.00	50.6 PK	74.0	-23.4	1.05 V	22	36.6	14.0
6	11570.00	38.2 AV	54.0	-15.8	1.05 V	22	24.2	14.0
7	#17355.00	50.2 PK	74.0	-23.8	1.59 V	179	31.3	18.9
8	#17355.00	38.6 AV	54.0	-15.4	1.59 V	179	19.7	18.9

REMARKS:

1. Emission Level(dBuV/m) = Raw Value(dBuV) + Correction Factor(dB/m)
2. Correction Factor(dB/m) = Antenna Factor(dB/m) + Cable Factor(dB) – Pre-Amplifier Factor(dB)
3. The other emission levels were very low against the limit.
4. Margin value = Emission Level – Limit value
5. " * ": Fundamental frequency.
6. " # ": The radiated frequency is out of the restricted band.

CHANNEL	TX Channel 165	DETECTOR FUNCTION	Peak (PK)
FREQUENCY RANGE	1GHz ~ 40GHz		Average (AV)

ANTENNA POLARITY & TEST DISTANCE: HORIZONTAL AT 3 M

NO.	FREQ. (MHz)	EMISSION LEVEL (dBuV/m)	LIMIT (dBuV/m)	MARGIN (dB)	ANTENNA HEIGHT (m)	TABLE ANGLE (Degree)	RAW VALUE (dBuV)	CORRECTION FACTOR (dB/m)
1	#5610.12	61.1 PK	68.2	-7.1	1.29 H	86	56.7	4.4
2	*5825.00	112.9 PK			1.29 H	86	107.7	5.2
3	*5825.00	102.9 AV			1.29 H	86	97.7	5.2
4	#5946.59	62.4 PK	68.2	-5.8	1.29 H	86	57.7	4.7
5	11650.00	48.5 PK	74.0	-25.5	1.79 H	210	34.4	14.1
6	11650.00	36.3 AV	54.0	-17.7	1.79 H	210	22.2	14.1
7	#17475.00	51.4 PK	74.0	-22.6	1.64 H	149	31.7	19.7
8	#17475.00	40.7 AV	54.0	-13.3	1.64 H	149	21.0	19.7

ANTENNA POLARITY & TEST DISTANCE: VERTICAL AT 3 M

NO.	FREQ. (MHz)	EMISSION LEVEL (dBuV/m)	LIMIT (dBuV/m)	MARGIN (dB)	ANTENNA HEIGHT (m)	TABLE ANGLE (Degree)	RAW VALUE (dBuV)	CORRECTION FACTOR (dB/m)
1	#5625.23	60.5 PK	68.2	-7.7	1.07 V	3	56.1	4.4
2	*5825.00	122.0 PK			1.07 V	3	116.8	5.2
3	*5825.00	112.1 AV			1.07 V	3	106.9	5.2
4	#5951.24	60.1 PK	68.2	-8.1	1.07 V	3	55.4	4.7
5	11650.00	50.9 PK	74.0	-23.1	1.04 V	8	36.8	14.1
6	11650.00	38.9 AV	54.0	-15.1	1.04 V	8	24.8	14.1
7	#17475.00	50.5 PK	74.0	-23.5	1.59 V	160	30.8	19.7
8	#17475.00	38.5 AV	54.0	-15.5	1.59 V	160	18.8	19.7

REMARKS:

1. Emission Level(dBuV/m) = Raw Value(dBuV) + Correction Factor(dB/m)
2. Correction Factor(dB/m) = Antenna Factor(dB/m) + Cable Factor(dB) – Pre-Amplifier Factor(dB)
3. The other emission levels were very low against the limit.
4. Margin value = Emission Level – Limit value
5. " * ": Fundamental frequency.
6. " # ": The radiated frequency is out of the restricted band.

802.11ac (VHT40)

CHANNEL	TX Channel 38	DETECTOR FUNCTION	Peak (PK)
FREQUENCY RANGE	1GHz ~ 40GHz		Average (AV)

ANTENNA POLARITY & TEST DISTANCE: HORIZONTAL AT 3 M

NO.	FREQ. (MHz)	EMISSION LEVEL (dBuV/m)	LIMIT (dBuV/m)	MARGIN (dB)	ANTENNA HEIGHT (m)	TABLE ANGLE (Degree)	RAW VALUE (dBuV)	CORRECTION FACTOR (dB/m)
1	5150.00	50.5 PK	74.0	-23.5	1.60 H	101	46.5	4.0
2	5150.00	41.2 AV	54.0	-12.8	1.60 H	101	37.2	4.0
3	*5190.00	103.3 PK			1.60 H	101	99.3	4.0
4	*5190.00	93.9 AV			1.60 H	101	89.9	4.0
5	5350.00	51.1 PK	74.0	-22.9	1.60 H	101	46.7	4.4
6	5350.00	37.4 AV	54.0	-16.6	1.60 H	101	33.0	4.4
7	#10380.00	46.0 PK	74.0	-28.0	1.43 H	24	32.4	13.6
8	#10380.00	35.0 AV	54.0	-19.0	1.43 H	24	21.4	13.6
9	15570.00	55.8 PK	74.0	-18.2	1.16 H	351	42.5	13.3
10	15570.00	42.8 AV	54.0	-11.2	1.16 H	351	29.5	13.3

ANTENNA POLARITY & TEST DISTANCE: VERTICAL AT 3 M

NO.	FREQ. (MHz)	EMISSION LEVEL (dBuV/m)	LIMIT (dBuV/m)	MARGIN (dB)	ANTENNA HEIGHT (m)	TABLE ANGLE (Degree)	RAW VALUE (dBuV)	CORRECTION FACTOR (dB/m)
1	5150.00	62.8 PK	74.0	-11.2	1.16 V	360	58.8	4.0
2	5150.00	53.7 AV	54.0	-0.3	1.16 V	360	49.7	4.0
3	*5190.00	117.3 PK			1.16 V	360	113.3	4.0
4	*5190.00	108.2 AV			1.16 V	360	104.2	4.0
5	5350.00	54.5 PK	74.0	-19.5	1.16 V	360	50.1	4.4
6	5350.00	42.3 AV	54.0	-11.7	1.16 V	360	37.9	4.4
7	#10380.00	50.8 PK	74.0	-23.2	1.31 V	297	37.2	13.6
8	#10380.00	37.8 AV	54.0	-16.2	1.31 V	297	24.2	13.6
9	15570.00	52.6 PK	74.0	-21.4	2.18 V	348	39.3	13.3
10	15570.00	39.6 AV	54.0	-14.4	2.18 V	348	26.3	13.3

REMARKS:

- Emission Level(dBuV/m) = Raw Value(dBuV) + Correction Factor(dB/m)
- Correction Factor(dB/m) = Antenna Factor(dB/m) + Cable Factor(dB) – Pre-Amplifier Factor(dB)
- The other emission levels were very low against the limit.
- Margin value = Emission Level – Limit value
- " * ": Fundamental frequency.
- " # ": The radiated frequency is out of the restricted band.

CHANNEL	TX Channel 46	DETECTOR FUNCTION	Peak (PK)
FREQUENCY RANGE	1GHz ~ 40GHz		Average (AV)

ANTENNA POLARITY & TEST DISTANCE: HORIZONTAL AT 3 M

NO.	FREQ. (MHz)	EMISSION LEVEL (dBuV/m)	LIMIT (dBuV/m)	MARGIN (dB)	ANTENNA HEIGHT (m)	TABLE ANGLE (Degree)	RAW VALUE (dBuV)	CORRECTION FACTOR (dB/m)
1	*5230.00	107.6 PK			1.57 H	104	103.4	4.2
2	*5230.00	98.3 AV			1.57 H	104	94.1	4.2
3	5350.00	54.9 PK	74.0	-19.1	1.57 H	104	50.5	4.4
4	5350.00	38.7 AV	54.0	-15.3	1.57 H	104	34.3	4.4
5	#10460.00	45.5 PK	74.0	-28.5	1.41 H	47	31.8	13.7
6	#10460.00	34.5 AV	54.0	-19.5	1.41 H	47	20.8	13.7
7	15690.00	56.3 PK	74.0	-17.7	1.11 H	356	42.3	14.0
8	15690.00	43.4 AV	54.0	-10.6	1.11 H	356	29.4	14.0

ANTENNA POLARITY & TEST DISTANCE: VERTICAL AT 3 M

NO.	FREQ. (MHz)	EMISSION LEVEL (dBuV/m)	LIMIT (dBuV/m)	MARGIN (dB)	ANTENNA HEIGHT (m)	TABLE ANGLE (Degree)	RAW VALUE (dBuV)	CORRECTION FACTOR (dB/m)
1	*5230.00	121.6 PK			1.09 V	360	117.4	4.2
2	*5230.00	112.6 AV			1.09 V	360	108.4	4.2
3	5350.00	67.2 PK	74.0	-6.8	1.09 V	360	62.8	4.4
4	5350.00	51.2 AV	54.0	-2.8	1.09 V	360	46.8	4.4
5	#10460.00	51.5 PK	74.0	-22.5	1.31 V	287	37.8	13.7
6	#10460.00	38.2 AV	54.0	-15.8	1.31 V	287	24.5	13.7
7	15690.00	53.0 PK	74.0	-21.0	2.19 V	324	39.0	14.0
8	15690.00	39.5 AV	54.0	-14.5	2.19 V	324	25.5	14.0

REMARKS:

1. Emission Level(dBuV/m) = Raw Value(dBuV) + Correction Factor(dB/m)
2. Correction Factor(dB/m) = Antenna Factor(dB/m) + Cable Factor(dB) – Pre-Amplifier Factor(dB)
3. The other emission levels were very low against the limit.
4. Margin value = Emission Level – Limit value
5. " * ": Fundamental frequency.
6. " # ": The radiated frequency is out of the restricted band.

CHANNEL	TX Channel 151	DETECTOR FUNCTION	Peak (PK)
FREQUENCY RANGE	1GHz ~ 40GHz		Average (AV)

ANTENNA POLARITY & TEST DISTANCE: HORIZONTAL AT 3 M

NO.	FREQ. (MHz)	EMISSION LEVEL (dBuV/m)	LIMIT (dBuV/m)	MARGIN (dB)	ANTENNA HEIGHT (m)	TABLE ANGLE (Degree)	RAW VALUE (dBuV)	CORRECTION FACTOR (dB/m)
1	#5601.48	60.3 PK	68.2	-7.9	1.33 H	82	55.9	4.4
2	*5755.00	109.5 PK			1.33 H	82	104.5	5.0
3	*5755.00	100.9 AV			1.33 H	82	95.9	5.0
4	#5940.64	60.4 PK	68.2	-7.8	1.33 H	82	55.7	4.7
5	11510.00	48.9 PK	74.0	-25.1	1.85 H	239	34.9	14.0
6	11510.00	37.2 AV	54.0	-16.8	1.85 H	239	23.2	14.0
7	#17265.00	51.4 PK	74.0	-22.6	1.64 H	182	32.9	18.5
8	#17265.00	40.5 AV	54.0	-13.5	1.64 H	182	22.0	18.5

ANTENNA POLARITY & TEST DISTANCE: VERTICAL AT 3 M

NO.	FREQ. (MHz)	EMISSION LEVEL (dBuV/m)	LIMIT (dBuV/m)	MARGIN (dB)	ANTENNA HEIGHT (m)	TABLE ANGLE (Degree)	RAW VALUE (dBuV)	CORRECTION FACTOR (dB/m)
1	#5634.89	66.3 PK	68.2	-1.9	1.13 V	360	61.9	4.4
2	*5755.00	119.8 PK			1.13 V	360	114.8	5.0
3	*5755.00	110.6 AV			1.13 V	360	105.6	5.0
4	#5940.02	60.5 PK	68.2	-7.7	1.13 V	360	55.8	4.7
5	11510.00	50.7 PK	74.0	-23.3	1.06 V	14	36.7	14.0
6	11510.00	38.1 AV	54.0	-15.9	1.06 V	14	24.1	14.0
7	#17265.00	50.8 PK	74.0	-23.2	1.64 V	166	32.3	18.5
8	#17265.00	39.0 AV	54.0	-15.0	1.64 V	166	20.5	18.5

REMARKS:

1. Emission Level(dBuV/m) = Raw Value(dBuV) + Correction Factor(dB/m)
2. Correction Factor(dB/m) = Antenna Factor(dB/m) + Cable Factor(dB) – Pre-Amplifier Factor(dB)
3. The other emission levels were very low against the limit.
4. Margin value = Emission Level – Limit value
5. " * ": Fundamental frequency.
6. " # ": The radiated frequency is out of the restricted band.

CHANNEL	TX Channel 159	DETECTOR FUNCTION	Peak (PK)
FREQUENCY RANGE	1GHz ~ 40GHz		Average (AV)

ANTENNA POLARITY & TEST DISTANCE: HORIZONTAL AT 3 M

NO.	FREQ. (MHz)	EMISSION LEVEL (dBuV/m)	LIMIT (dBuV/m)	MARGIN (dB)	ANTENNA HEIGHT (m)	TABLE ANGLE (Degree)	RAW VALUE (dBuV)	CORRECTION FACTOR (dB/m)
1	#5647.61	61.7 PK	68.2	-6.5	1.29 H	84	57.3	4.4
2	*5795.00	110.9 PK			1.29 H	84	105.8	5.1
3	*5795.00	101.3 AV			1.29 H	84	96.2	5.1
4	#5939.95	62.1 PK	68.2	-6.1	1.29 H	84	57.4	4.7
5	11590.00	49.0 PK	74.0	-25.0	1.82 H	214	35.0	14.0
6	11590.00	37.0 AV	54.0	-17.0	1.82 H	214	23.0	14.0
7	#17385.00	51.0 PK	74.0	-23.0	1.71 H	160	31.9	19.1
8	#17385.00	40.3 AV	54.0	-13.7	1.71 H	160	21.2	19.1

ANTENNA POLARITY & TEST DISTANCE: VERTICAL AT 3 M

NO.	FREQ. (MHz)	EMISSION LEVEL (dBuV/m)	LIMIT (dBuV/m)	MARGIN (dB)	ANTENNA HEIGHT (m)	TABLE ANGLE (Degree)	RAW VALUE (dBuV)	CORRECTION FACTOR (dB/m)
1	#5635.99	67.4 PK	68.2	-0.8	1.01 V	360	63.0	4.4
2	*5795.00	120.1 PK			1.01 V	360	115.0	5.1
3	*5795.00	110.5 AV			1.01 V	360	105.4	5.1
4	#5926.46	64.9 PK	68.2	-3.3	1.01 V	360	60.2	4.7
5	11590.00	50.7 PK	74.0	-23.3	1.00 V	36	36.7	14.0
6	11590.00	38.1 AV	54.0	-15.9	1.00 V	36	24.1	14.0
7	#17385.00	50.7 PK	74.0	-23.3	1.57 V	174	31.6	19.1
8	#17385.00	38.9 AV	54.0	-15.1	1.57 V	174	19.8	19.1

REMARKS:

1. Emission Level(dBuV/m) = Raw Value(dBuV) + Correction Factor(dB/m)
2. Correction Factor(dB/m) = Antenna Factor(dB/m) + Cable Factor(dB) – Pre-Amplifier Factor(dB)
3. The other emission levels were very low against the limit.
4. Margin value = Emission Level – Limit value
5. " * ": Fundamental frequency.
6. " # ": The radiated frequency is out of the restricted band.

802.11ac (VHT80)

CHANNEL	TX Channel 42	DETECTOR FUNCTION	Peak (PK)
FREQUENCY RANGE	1GHz ~ 40GHz		Average (AV)

ANTENNA POLARITY & TEST DISTANCE: HORIZONTAL AT 3 M

NO.	FREQ. (MHz)	EMISSION LEVEL (dBuV/m)	LIMIT (dBuV/m)	MARGIN (dB)	ANTENNA HEIGHT (m)	TABLE ANGLE (Degree)	RAW VALUE (dBuV)	CORRECTION FACTOR (dB/m)
1	5150.00	50.9 PK	74.0	-23.1	1.62 H	92	46.9	4.0
2	5150.00	41.3 AV	54.0	-12.7	1.62 H	92	37.3	4.0
3	*5210.00	97.6 PK			1.62 H	92	93.5	4.1
4	*5210.00	88.7 AV			1.62 H	92	84.6	4.1
5	5350.00	49.7 PK	74.0	-24.3	1.62 H	92	45.3	4.4
6	5350.00	37.6 AV	54.0	-16.4	1.62 H	92	33.2	4.4
7	#10420.00	46.3 PK	74.0	-27.7	1.49 H	35	32.7	13.6
8	#10420.00	35.4 AV	54.0	-18.6	1.49 H	35	21.8	13.6
9	15630.00	55.7 PK	74.0	-18.3	1.14 H	349	42.1	13.6
10	15630.00	42.6 AV	54.0	-11.4	1.14 H	349	29.0	13.6

ANTENNA POLARITY & TEST DISTANCE: VERTICAL AT 3 M

NO.	FREQ. (MHz)	EMISSION LEVEL (dBuV/m)	LIMIT (dBuV/m)	MARGIN (dB)	ANTENNA HEIGHT (m)	TABLE ANGLE (Degree)	RAW VALUE (dBuV)	CORRECTION FACTOR (dB/m)
1	5150.00	63.2 PK	74.0	-10.8	1.18 V	360	59.2	4.0
2	5150.00	53.8 AV	54.0	-0.2	1.18 V	360	49.8	4.0
3	*5210.00	111.6 PK			1.18 V	360	107.5	4.1
4	*5210.00	103.0 AV			1.18 V	360	98.9	4.1
5	5350.00	58.7 PK	74.0	-15.3	1.18 V	0	54.3	4.4
6	5350.00	46.6 AV	54.0	-7.4	1.18 V	0	42.2	4.4
7	#10420.00	51.5 PK	74.0	-22.5	1.28 V	282	37.9	13.6
8	#10420.00	38.5 AV	54.0	-15.5	1.28 V	282	24.9	13.6
9	15630.00	53.3 PK	74.0	-20.7	2.22 V	324	39.7	13.6
10	15630.00	39.7 AV	54.0	-14.3	2.22 V	324	26.1	13.6

REMARKS:

- Emission Level(dBuV/m) = Raw Value(dBuV) + Correction Factor(dB/m)
- Correction Factor(dB/m) = Antenna Factor(dB/m) + Cable Factor(dB) – Pre-Amplifier Factor(dB)
- The other emission levels were very low against the limit.
- Margin value = Emission Level – Limit value
- " * ": Fundamental frequency.
- " # ": The radiated frequency is out of the restricted band.

CHANNEL	TX Channel 155	DETECTOR FUNCTION	Peak (PK)
FREQUENCY RANGE	1GHz ~ 40GHz		Average (AV)

ANTENNA POLARITY & TEST DISTANCE: HORIZONTAL AT 3 M

NO.	FREQ. (MHz)	EMISSION LEVEL (dBuV/m)	LIMIT (dBuV/m)	MARGIN (dB)	ANTENNA HEIGHT (m)	TABLE ANGLE (Degree)	RAW VALUE (dBuV)	CORRECTION FACTOR (dB/m)
1	#5648.95	61.7 PK	68.2	-6.5	1.51 H	86	57.3	4.4
2	*5775.00	103.7 PK			1.51 H	86	98.7	5.0
3	*5775.00	95.9 AV			1.51 H	86	90.9	5.0
4	#5929.49	60.7 PK	68.2	-7.5	1.51 H	86	56.0	4.7
5	11550.00	49.5 PK	74.0	-24.5	1.87 H	220	35.5	14.0
6	11550.00	37.3 AV	54.0	-16.7	1.87 H	220	23.3	14.0
7	#17325.00	50.7 PK	74.0	-23.3	1.77 H	174	32.1	18.6
8	#17325.00	40.1 AV	54.0	-13.9	1.77 H	174	21.5	18.6

ANTENNA POLARITY & TEST DISTANCE: VERTICAL AT 3 M

NO.	FREQ. (MHz)	EMISSION LEVEL (dBuV/m)	LIMIT (dBuV/m)	MARGIN (dB)	ANTENNA HEIGHT (m)	TABLE ANGLE (Degree)	RAW VALUE (dBuV)	CORRECTION FACTOR (dB/m)
1	#5639.10	68.0 PK	68.2	-0.2	1.16 V	359	63.6	4.4
2	*5775.00	113.4 PK			1.16 V	259	108.4	5.0
3	*5775.00	104.0 AV			1.16 V	259	99.0	5.0
4	#5938.41	62.3 PK	68.2	-5.9	1.16 V	359	57.6	4.7
5	11550.00	50.7 PK	74.0	-23.3	1.02 V	40	36.7	14.0
6	11550.00	38.3 AV	54.0	-15.7	1.02 V	40	24.3	14.0
7	#17325.00	51.2 PK	74.0	-22.8	1.55 V	172	32.6	18.6
8	#17325.00	39.3 AV	54.0	-14.7	1.55 V	172	20.7	18.6

REMARKS:

1. Emission Level(dBuV/m) = Raw Value(dBuV) + Correction Factor(dB/m)
2. Correction Factor(dB/m) = Antenna Factor(dB/m) + Cable Factor(dB) – Pre-Amplifier Factor(dB)
3. The other emission levels were very low against the limit.
4. Margin value = Emission Level – Limit value
5. " * ": Fundamental frequency.
6. " # ": The radiated frequency is out of the restricted band.

Below 1GHz Data:

802.11ac (VHT20)

CHANNEL	TX Channel 165	DETECTOR FUNCTION	Quasi-Peak (QP)
FREQUENCY RANGE	9kHz ~ 1GHz		

ANTENNA POLARITY & TEST DISTANCE: HORIZONTAL AT 3 M

NO.	FREQ. (MHz)	EMISSION LEVEL (dBuV/m)	LIMIT (dBuV/m)	MARGIN (dB)	ANTENNA HEIGHT (m)	TABLE ANGLE (Degree)	RAW VALUE (dBuV)	CORRECTION FACTOR (dB/m)
1	125.05	37.8 QP	43.5	-5.7	1.25 H	171	47.4	-9.6
2	249.22	34.6 QP	46.0	-11.4	1.43 H	261	44.1	-9.5
3	332.88	38.7 QP	46.0	-7.3	1.00 H	224	45.4	-6.7
4	431.58	39.5 QP	46.0	-6.5	1.03 H	264	43.5	-4.0
5	483.96	39.5 QP	46.0	-6.5	1.12 H	314	42.6	-3.1
6	951.50	37.0 QP	46.0	-9.0	1.00 H	241	32.4	4.6

ANTENNA POLARITY & TEST DISTANCE: VERTICAL AT 3 M

NO.	FREQ. (MHz)	EMISSION LEVEL (dBuV/m)	LIMIT (dBuV/m)	MARGIN (dB)	ANTENNA HEIGHT (m)	TABLE ANGLE (Degree)	RAW VALUE (dBuV)	CORRECTION FACTOR (dB/m)
1	38.11	35.3 QP	40.0	-4.7	1.62 V	191	43.6	-8.3
2	93.62	36.5 QP	43.5	-7.0	1.56 V	241	50.4	-13.9
3	124.99	35.3 QP	43.5	-8.2	1.22 V	269	44.9	-9.6
4	334.10	37.8 QP	46.0	-8.2	1.52 V	184	44.5	-6.7
5	479.40	35.8 QP	46.0	-10.2	1.00 V	221	38.8	-3.0
6	951.45	38.2 QP	46.0	-7.8	1.52 V	46	33.6	4.6

REMARKS:

1. Emission Level(dBuV/m) = Raw Value(dBuV) + Correction Factor(dB/m)
2. Correction Factor(dB/m) = Antenna Factor(dB/m) + Cable Factor(dB) – Pre-Amplifier Factor(dB)
3. The other emission levels were very low against the limit.
4. Margin value = Emission Level – Limit value

4.2 Conducted Emission Measurement

4.2.1 Limits of Conducted Emission Measurement

Frequency (MHz)	Conducted Limit (dBuV)	
	Quasi-peak	Average
0.15 - 0.5	66 - 56	56 - 46
0.50 - 5.0	56	46
5.0 - 30.0	60	50

Note: 1. The lower limit shall apply at the transition frequencies.

2. The limit decreases in line with the logarithm of the frequency in the range of 0.15 to 0.50MHz.

4.2.2 Test Instruments

DESCRIPTION & MANUFACTURER	MODEL NO.	SERIAL NO.	CALIBRATED DATE	CALIBRATED UNTIL
Test Receiver R&S	ESCS 30	847124/029	Oct. 24, 2016	Oct. 23, 2017
Line-Impedance Stabilization Network (for EUT) R&S	ESH3-Z5	848773/004	Oct. 26, 2016	Oct. 25, 2017
Line-Impedance Stabilization Network (for Peripheral) R&S	ENV216	100072	June 03, 2017	June 02, 2018
50 ohms Terminator	N/A	EMC-02	Sep. 22, 2017	Sep. 21, 2018
RF Cable	5D-FB	COCCAB-001	Sep. 30, 2016	Sep. 29, 2017
10 dB PAD Mini-Circuits	HAT-10+	CONATT-004	June 18, 2017	June 17, 2018
Software BVADT	BVADT_Cond_ V7.3.7.4	NA	NA	NA

Note:

1. The calibration interval of the above test instruments are 12 months and the calibrations are traceable to NML/ROC and NIST/USA.
2. The test was performed in Shielded Room No. 1.
3. Tested Date: Sep. 28, 2017

4.2.3 Test Procedure

- The EUT was placed 0.4 meters from the conducting wall of the shielded room with EUT being connected to the power mains through a line impedance stabilization network (LISN). Other support units were connected to the power mains through another LISN. The two LISNs provide 50 ohm/ 50uH of coupling impedance for the measuring instrument.
- Both lines of the power mains connected to the EUT were checked for maximum conducted interference.
- The frequency range from 150kHz to 30MHz was searched. Emission levels under (Limit - 20dB) was not recorded.

NOTE: All modes of operation were investigated and the worst-case emissions are reported.

4.2.4 Deviation from Test Standard

No deviation.

4.2.5 Test Setup

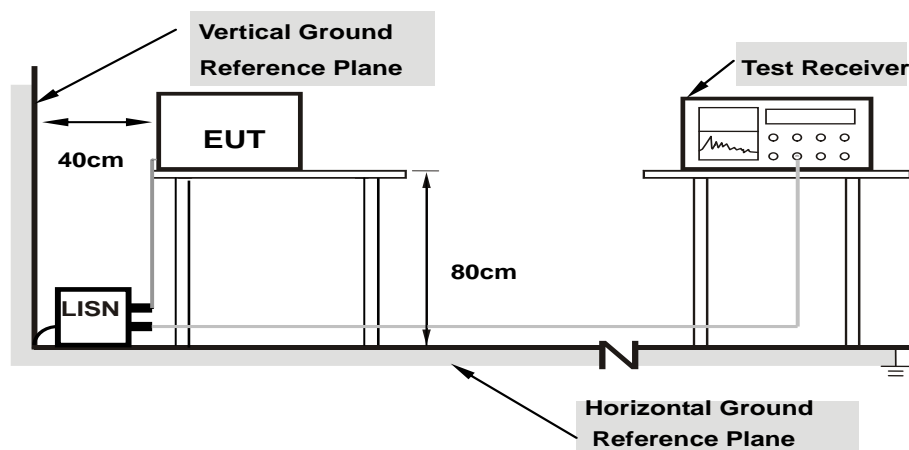

Note: 1.Support units were connected to second LISN.

For the actual test configuration, please refer to the attached file (Test Setup Photo).

4.2.6 EUT Operating Condition

Same as 4.1.6.

4.2.7 Test Results (Mode 1)

Phase	Line (L)	Detector Function	Quasi-Peak (QP) / Average (AV)
-------	----------	-------------------	--------------------------------

No	Freq. [MHz]	Corr.	Reading Value		Emission Level		Limit		Margin	
		Factor (dB)	[dB (uV)]		[dB (uV)]		[dB (uV)]		(dB)	
		Q.P.	AV.	Q.P.	AV.	Q.P.	AV.	Q.P.	AV.	Q.P.
1	0.15000	10.07	23.59	3.81	33.66	13.88	66.00	56.00	-32.34	-42.12
2	0.18125	10.06	18.96	-4.95	29.02	5.11	64.43	54.43	-35.41	-49.32
3	0.31016	10.09	10.84	-7.84	20.93	2.25	59.97	49.97	-39.04	-47.72
4	0.94297	10.14	9.29	-6.20	19.43	3.94	56.00	46.00	-36.57	-42.06
5	2.94922	10.22	11.39	4.42	21.61	14.64	56.00	46.00	-34.39	-31.36
6	22.68359	11.31	19.87	15.39	31.18	26.70	60.00	50.00	-28.82	-23.30

REMARKS:

1. Q.P. and AV. are abbreviations of quasi-peak and average individually.
2. The emission levels of other frequencies were very low against the limit.
3. Margin value = Emission level - Limit value
4. Correction factor = Insertion loss + Cable loss
5. Emission Level = Correction Factor + Reading Value.

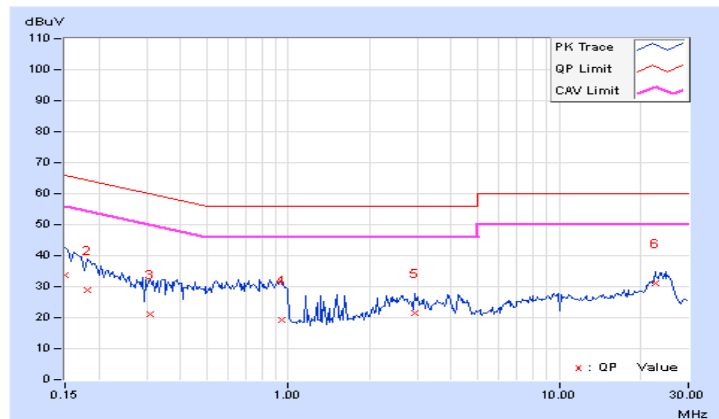

Phase	Neutral (N)	Detector Function	Quasi-Peak (QP) / Average (AV)
-------	-------------	-------------------	--------------------------------

No	Freq.	Corr.	Reading Value		Emission Level		Limit		Margin	
	[MHz]	Factor	[dB (uV)]		[dB (uV)]		[dB (uV)]		(dB)	
		(dB)	Q.P.	AV.	Q.P.	AV.	Q.P.	AV.	Q.P.	AV.
1	0.15000	10.06	22.57	-0.60	32.63	9.46	66.00	56.00	-33.37	-46.54
2	0.19687	10.03	16.58	-6.16	26.61	3.87	63.74	53.74	-37.13	-49.87
3	0.38828	10.10	10.69	-7.49	20.79	2.61	58.10	48.10	-37.31	-45.49
4	0.89219	10.11	10.95	-5.89	21.06	4.22	56.00	46.00	-34.94	-41.78
5	2.67969	10.19	14.09	5.81	24.28	16.00	56.00	46.00	-31.72	-30.00
6	23.89844	10.98	18.36	12.95	29.34	23.93	60.00	50.00	-30.66	-26.07

REMARKS:

1. Q.P. and AV. are abbreviations of quasi-peak and average individually.
2. The emission levels of other frequencies were very low against the limit.
3. Margin value = Emission level - Limit value
4. Correction factor = Insertion loss + Cable loss
5. Emission Level = Correction Factor + Reading Value.

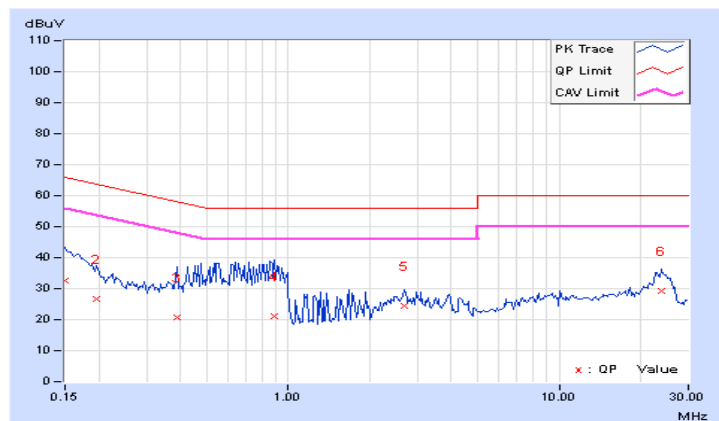

4.2.8 Test Results (Mode 2)

Phase	Line (L)	Detector Function	Quasi-Peak (QP) / Average (AV)
-------	----------	-------------------	--------------------------------

No	Freq. [MHz]	Corr. Factor	Reading Value [dB (uV)]		Emission Level [dB (uV)]		Limit [dB (uV)]		Margin (dB)	
		(dB)	Q.P.	AV.	Q.P.	AV.	Q.P.	AV.	Q.P.	AV.
	1	0.15000	10.07	23.29	3.87	33.36	13.94	66.00	56.00	-32.64
2	0.25156	10.07	12.52	-7.23	22.59	2.84	61.71	51.71	-39.12	-48.87
3	0.49766	10.11	10.29	-7.51	20.40	2.60	56.04	46.04	-35.64	-43.44
4	0.76719	10.13	10.08	-6.85	20.21	3.28	56.00	46.00	-35.79	-42.72
5	2.91797	10.21	11.64	4.45	21.85	14.66	56.00	46.00	-34.15	-31.34
6	22.69922	11.31	24.01	20.74	35.32	32.05	60.00	50.00	-24.68	-17.95

REMARKS:

1. Q.P. and AV. are abbreviations of quasi-peak and average individually.
2. The emission levels of other frequencies were very low against the limit.
3. Margin value = Emission level - Limit value
4. Correction factor = Insertion loss + Cable loss
5. Emission Level = Correction Factor + Reading Value.

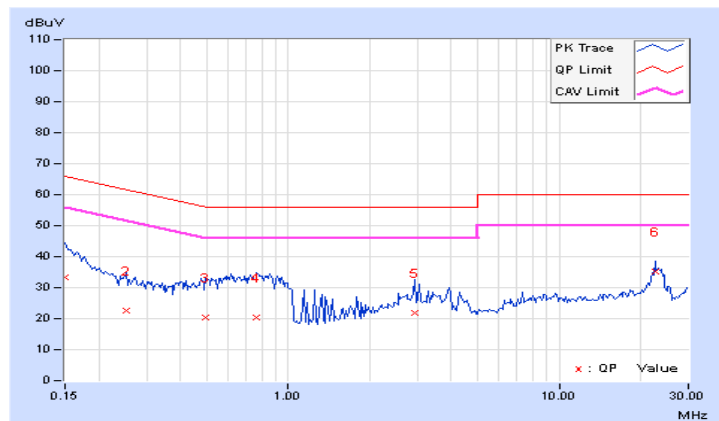

Phase	Neutral (N)	Detector Function	Quasi-Peak (QP) / Average (AV)
-------	-------------	-------------------	--------------------------------

No	Freq.	Corr.	Reading Value		Emission Level		Limit		Margin	
	[MHz]	Factor	[dB (uV)]		[dB (uV)]		[dB (uV)]		(dB)	
		(dB)	Q.P.	AV.	Q.P.	AV.	Q.P.	AV.	Q.P.	AV.
1	0.15781	10.06	21.15	6.31	31.21	16.37	65.58	55.58	-34.37	-39.21
2	0.20469	10.03	13.84	-5.96	23.87	4.07	63.42	53.42	-39.55	-49.35
3	0.47031	10.10	5.49	-7.95	15.59	2.15	56.51	46.51	-40.92	-44.36
4	0.67344	10.10	12.61	-8.27	22.71	1.83	56.00	46.00	-33.29	-44.17
5	3.55078	10.21	12.60	6.65	22.81	16.86	56.00	46.00	-33.19	-29.14
6	22.69922	10.99	23.54	20.34	34.53	31.33	60.00	50.00	-25.47	-18.67

REMARKS:

1. Q.P. and AV. are abbreviations of quasi-peak and average individually.
2. The emission levels of other frequencies were very low against the limit.
3. Margin value = Emission level - Limit value
4. Correction factor = Insertion loss + Cable loss
5. Emission Level = Correction Factor + Reading Value.

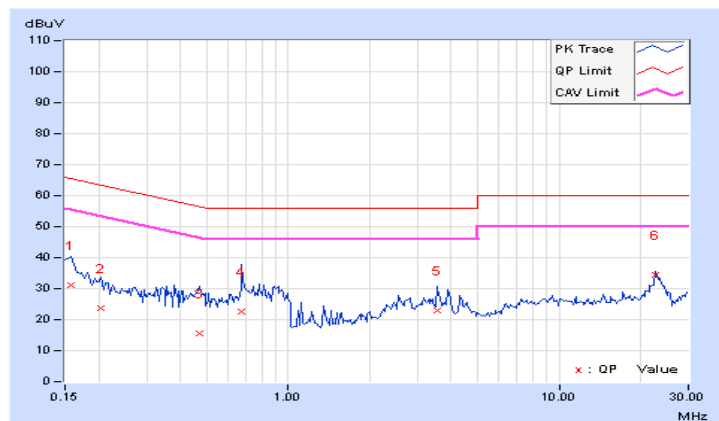

4.2.9 Test Results (Mode 3)

Phase	Line (L)	Detector Function	Quasi-Peak (QP) / Average (AV)
-------	----------	-------------------	--------------------------------

No	Freq. [MHz]	Corr. Factor	Reading Value [dB (uV)]		Emission Level [dB (uV)]		Limit [dB (uV)]		Margin (dB)	
		(dB)	Q.P.	AV.	Q.P.	AV.	Q.P.	AV.	Q.P.	AV.
	1	0.15000	10.07	22.82	2.85	32.89	12.92	66.00	56.00	-33.11
2	0.18906	10.06	17.98	1.53	28.04	11.59	64.08	54.08	-36.04	-42.49
3	0.68125	10.12	9.27	-7.96	19.39	2.16	56.00	46.00	-36.61	-43.84
4	0.94297	10.14	7.86	1.05	18.00	11.19	56.00	46.00	-38.00	-34.81
5	2.92188	10.21	11.28	4.63	21.49	14.84	56.00	46.00	-34.51	-31.16
6	24.05469	11.32	17.90	12.70	29.22	24.02	60.00	50.00	-30.78	-25.98

REMARKS:

1. Q.P. and AV. are abbreviations of quasi-peak and average individually.
2. The emission levels of other frequencies were very low against the limit.
3. Margin value = Emission level - Limit value
4. Correction factor = Insertion loss + Cable loss
5. Emission Level = Correction Factor + Reading Value.

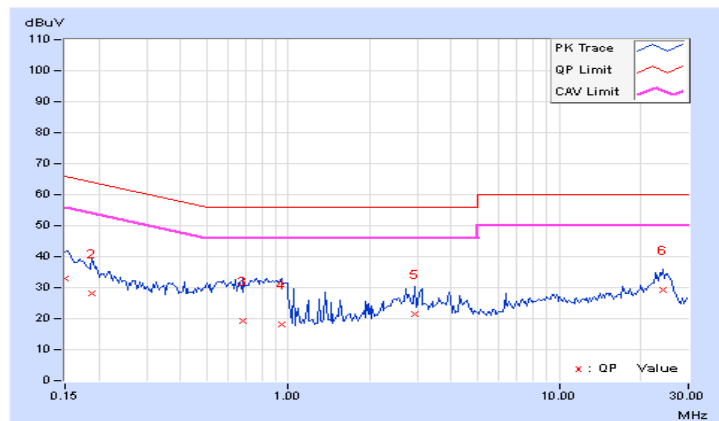

Phase	Neutral (N)	Detector Function	Quasi-Peak (QP) / Average (AV)
-------	-------------	-------------------	--------------------------------

No	Freq. [MHz]	Corr. Factor	Reading Value [dB (uV)]		Emission Level [dB (uV)]		Limit [dB (uV)]		Margin (dB)	
		(dB)	Q.P.	AV.	Q.P.	AV.	Q.P.	AV.	Q.P.	AV.
	1	0.15000	10.06	22.58	3.79	32.64	13.85	66.00	56.00	-33.36
2	0.20859	10.03	13.74	-5.92	23.77	4.11	63.26	53.26	-39.49	-49.15
3	0.61484	10.10	8.53	-7.93	18.63	2.17	56.00	46.00	-37.37	-43.83
4	0.87266	10.11	10.44	-5.43	20.55	4.68	56.00	46.00	-35.45	-41.32
5	2.42969	10.19	10.69	3.45	20.88	13.64	56.00	46.00	-35.12	-32.36
6	24.68359	10.98	18.18	12.73	29.16	23.71	60.00	50.00	-30.84	-26.29

REMARKS:

1. Q.P. and AV. are abbreviations of quasi-peak and average individually.
2. The emission levels of other frequencies were very low against the limit.
3. Margin value = Emission level - Limit value
4. Correction factor = Insertion loss + Cable loss
5. Emission Level = Correction Factor + Reading Value.

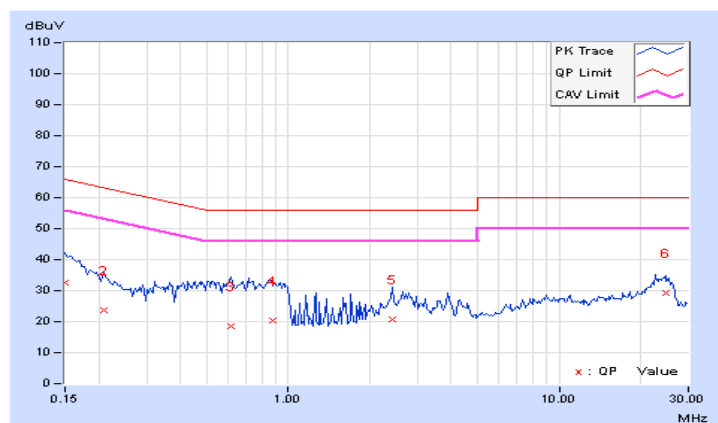

4.2.10 Test Results (Mode 4)

Phase	Line (L)	Detector Function	Quasi-Peak (QP) / Average (AV)
-------	----------	-------------------	--------------------------------

No	Freq. [MHz]	Corr.	Reading Value		Emission Level		Limit		Margin	
		Factor	[dB (uV)]		[dB (uV)]		[dB (uV)]		(dB)	
	(dB)	Q.P.	AV.	Q.P.	AV.	Q.P.	AV.	Q.P.	AV.	
1	0.15000	10.07	23.39	3.61	33.46	13.68	66.00	56.00	-32.54	-42.32
2	0.21641	10.06	11.30	-7.58	21.36	2.48	62.96	52.96	-41.60	-50.48
3	0.50938	10.12	10.22	-7.88	20.34	2.24	56.00	46.00	-35.66	-43.76
4	0.70469	10.13	10.25	-7.89	20.38	2.24	56.00	46.00	-35.62	-43.76
5	2.69531	10.20	13.25	6.25	23.45	16.45	56.00	46.00	-32.55	-29.55
6	23.62891	11.32	18.95	13.17	30.27	24.49	60.00	50.00	-29.73	-25.51

REMARKS:

1. Q.P. and AV. are abbreviations of quasi-peak and average individually.
2. The emission levels of other frequencies were very low against the limit.
3. Margin value = Emission level - Limit value
4. Correction factor = Insertion loss + Cable loss
5. Emission Level = Correction Factor + Reading Value.

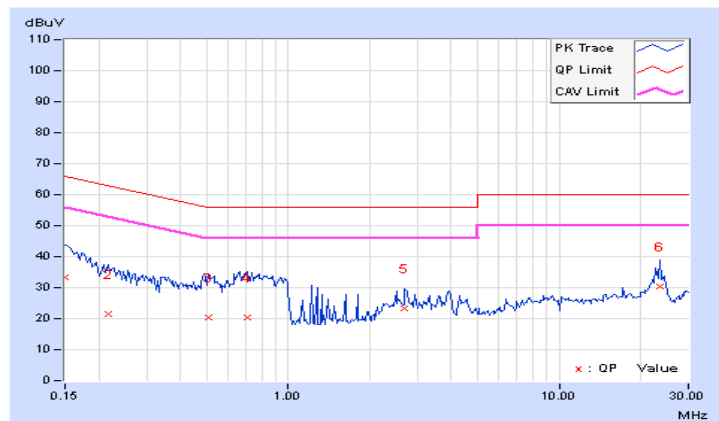

Phase	Neutral (N)	Detector Function	Quasi-Peak (QP) / Average (AV)
-------	-------------	-------------------	--------------------------------

No	Freq.	Corr.	Reading Value		Emission Level		Limit		Margin	
	[MHz]	Factor	[dB (uV)]		[dB (uV)]		[dB (uV)]		(dB)	
		(dB)	Q.P.	AV.	Q.P.	AV.	Q.P.	AV.	Q.P.	AV.
1	0.15000	10.06	22.48	3.29	32.54	13.35	66.00	56.00	-33.46	-42.65
2	0.23203	10.04	12.42	-7.55	22.46	2.49	62.38	52.38	-39.92	-49.89
3	0.35703	10.08	5.93	0.51	16.01	10.59	58.80	48.80	-42.79	-38.21
4	0.85703	10.11	5.01	-6.08	15.12	4.03	56.00	46.00	-40.88	-41.97
5	2.79297	10.20	11.12	6.30	21.32	16.50	56.00	46.00	-34.68	-29.50
6	22.69922	10.99	23.38	20.14	34.37	31.13	60.00	50.00	-25.63	-18.87

REMARKS:

1. Q.P. and AV. are abbreviations of quasi-peak and average individually.
2. The emission levels of other frequencies were very low against the limit.
3. Margin value = Emission level - Limit value
4. Correction factor = Insertion loss + Cable loss
5. Emission Level = Correction Factor + Reading Value.

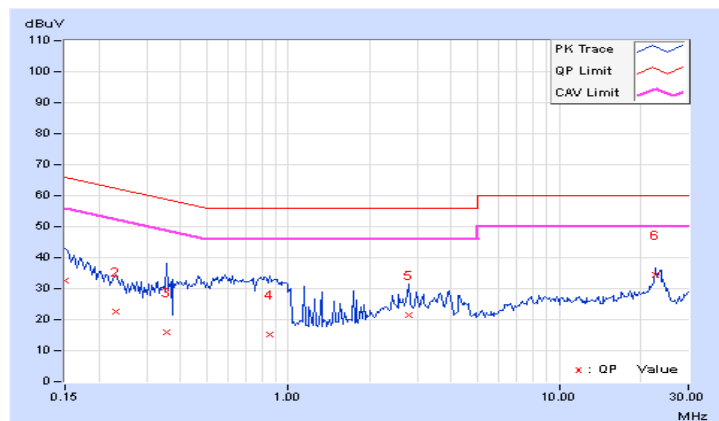

4.3 Transmit Power Measurement

4.3.1 Limits of Transmit Power Measurement

Operation Band	EUT Category		Limit
U-NII-1		Outdoor Access Point	1 Watt (30 dBm) (Max. e.i.r.p \leq 125mW(21 dBm) at any elevation angle above 30 degrees as measured from the horizon)
		Fixed point-to-point Access Point	1 Watt (30 dBm)
	√	Indoor Access Point	1 Watt (30 dBm)
	√	Mobile and Portable client device	250mW (24 dBm)
U-NII-2A			250mW (24 dBm) or 11 dBm+10 log B*
U-NII-2C			250mW (24 dBm) or 11 dBm+10 log B*
U-NII-3		√	1 Watt (30 dBm)

*B is the 26 dB emission bandwidth in megahertz

Per KDB 662911 Method of conducted output power measurement on IEEE 802.11 devices,

Array Gain = 0 dB (i.e., no array gain) for $N_{ANT} \leq 4$;

Array Gain = 0 dB (i.e., no array gain) for channel widths ≥ 40 MHz for any N_{ANT} ;

Array Gain = $5 \log(N_{ANT}/N_{SS})$ dB or 3 dB, whichever is less for 20-MHz channel widths with $N_{ANT} \geq 5$.

For power measurements on all other devices: Array Gain = $10 \log(N_{ANT}/N_{SS})$ dB.

4.3.2 Test Setup

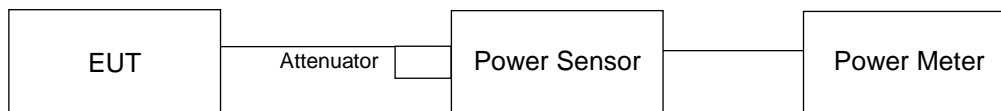

4.3.3 Test Instruments

Refer to section 4.1.2 to get information of above instrument.

4.3.4 Test Procedure

Method PM is used to perform output power measurement, trigger and gating function of wide band power meter is enabled to measure max output power of TX on burst. Duty factor is not added to measured value.

4.3.5 Deviation from Test Standard

No deviation.

4.3.6 EUT Operating Condition

The software provided by client to enable the EUT under transmission condition continuously at lowest, middle and highest channel frequencies individually.

4.3.7 Test Result (Mode 1)

CDD Mode / Master Mode
802.11a

Chan.	Chan. Freq. (MHz)	Maximum Conducted Power (dBm)		Total Power (mW)	Total Power (dBm)	Limit (dBm)	Pass / Fail
		Chain 0	Chain 1				
36	5180	21.24	21.70	280.956	24.49	30.00	Pass
40	5200	25.12	25.52	681.538	28.33	30.00	Pass
48	5240	24.62	24.65	581.477	27.65	30.00	Pass
149	5745	26.47	26.33	873.145	29.41	30.00	Pass
157	5785	26.10	26.15	819.478	29.14	30.00	Pass
165	5825	25.90	26.08	794.554	29.00	30.00	Pass

802.11ac (VHT20)

Chan.	Chan. Freq. (MHz)	Maximum Conducted Power (dBm)		Total Power (mW)	Total Power (dBm)	Limit (dBm)	Pass / Fail
		Chain 0	Chain 1				
36	5180	20.96	21.24	257.783	24.11	30.00	Pass
40	5200	24.64	25.05	610.962	27.86	30.00	Pass
48	5240	24.57	24.51	568.906	27.55	30.00	Pass
149	5745	26.24	26.29	846.325	29.28	30.00	Pass
157	5785	26.25	26.06	825.342	29.17	30.00	Pass
165	5825	26.05	25.89	790.867	28.98	30.00	Pass

802.11ac (VHT40)

Chan.	Chan. Freq. (MHz)	Maximum Conducted Power (dBm)		Total Power (mW)	Total Power (dBm)	Limit (dBm)	Pass / Fail
		Chain 0	Chain 1				
38	5190	19.96	20.32	206.73	23.15	30.00	Pass
46	5230	24.27	24.14	526.719	27.22	30.00	Pass
151	5755	25.98	26.05	798.995	29.03	30.00	Pass
159	5795	25.86	26.01	784.503	28.95	30.00	Pass

802.11ac (VHT80)

Chan.	Chan. Freq. (MHz)	Maximum Conducted Power (dBm)		Total Power (mW)	Total Power (dBm)	Limit (dBm)	Pass / Fail
		Chain 0	Chain 1				
42	5210	17.59	17.79	117.529	20.70	30.00	Pass
155	5775	22.26	22.57	348.984	25.43	30.00	Pass

CDD Mode / Client Mode
802.11a

Chan.	Chan. Freq. (MHz)	Maximum Conducted Power (dBm)		Total Power (mW)	Total Power (dBm)	Limit (dBm)	Pass / Fail
		Chain 0	Chain 1				
36	5180	19.89	20.20	202.212	23.06	24.00	Pass
40	5200	20.01	20.21	205.185	23.12	24.00	Pass
48	5240	19.88	20.13	200.314	23.02	24.00	Pass
149	5745	26.47	26.33	873.145	29.41	30.00	Pass
157	5785	26.10	26.15	819.478	29.14	30.00	Pass
165	5825	25.90	26.08	794.554	29.00	30.00	Pass

802.11ac (VHT20)

Chan.	Chan. Freq. (MHz)	Maximum Conducted Power (dBm)		Total Power (mW)	Total Power (dBm)	Limit (dBm)	Pass / Fail
		Chain 0	Chain 1				
36	5180	19.96	20.24	204.765	23.11	24.00	Pass
40	5200	20.11	20.21	207.519	23.17	24.00	Pass
48	5240	19.80	20.12	198.301	22.97	24.00	Pass
149	5745	26.24	26.29	846.325	29.28	30.00	Pass
157	5785	26.25	26.06	825.342	29.17	30.00	Pass
165	5825	26.05	25.89	790.867	28.98	30.00	Pass

802.11ac (VHT40)

Chan.	Chan. Freq. (MHz)	Maximum Conducted Power (dBm)		Total Power (mW)	Total Power (dBm)	Limit (dBm)	Pass / Fail
		Chain 0	Chain 1				
38	5190	19.96	20.32	206.73	23.15	24.00	Pass
46	5230	19.88	20.36	205.918	23.14	24.00	Pass
151	5755	25.98	26.05	798.995	29.03	30.00	Pass
159	5795	25.86	26.01	784.503	28.95	30.00	Pass

802.11ac (VHT80)

Chan.	Chan. Freq. (MHz)	Maximum Conducted Power (dBm)		Total Power (mW)	Total Power (dBm)	Limit (dBm)	Pass / Fail
		Chain 0	Chain 1				
42	5210	17.59	17.79	117.529	20.70	24.00	Pass
155	5775	22.26	22.57	348.984	25.43	30.00	Pass

Beamforming Mode / Master Mode

802.11ac (VHT20)

Chan.	Chan. Freq. (MHz)	Maximum Conducted Power (dBm)		Total Power (mW)	Total Power (dBm)	Limit (dBm)	Pass / Fail
		Chain 0	Chain 1				
36	5180	20.96	21.24	257.783	24.11	29.39	Pass
40	5200	24.64	25.05	610.962	27.86	29.39	Pass
48	5240	24.57	24.51	568.906	27.55	29.39	Pass
149	5745	26.24	26.29	846.325	29.28	29.39	Pass
157	5785	26.25	26.06	825.342	29.17	29.39	Pass
165	5825	26.05	25.89	790.867	28.98	29.39	Pass

Note: 1. Directional gain = $3.60\text{dBi} + 10\log(2) = 6.61\text{dBi} > 6\text{dBi}$, so the power limit shall be reduced to $30 - (6.61 - 6) = 29.39\text{dBm}$

802.11ac (VHT40)

Chan.	Chan. Freq. (MHz)	Maximum Conducted Power (dBm)		Total Power (mW)	Total Power (dBm)	Limit (dBm)	Pass / Fail
		Chain 0	Chain 1				
38	5190	19.96	20.32	206.73	23.15	29.39	Pass
46	5230	24.27	24.14	526.719	27.22	29.39	Pass
151	5755	25.98	26.05	798.995	29.03	29.39	Pass
159	5795	25.86	26.01	784.503	28.95	29.39	Pass

Note: 1. Directional gain = $3.60\text{dBi} + 10\log(2) = 6.61\text{dBi} > 6\text{dBi}$, so the power limit shall be reduced to $30 - (6.61 - 6) = 29.39\text{dBm}$

802.11ac (VHT80)

Chan.	Chan. Freq. (MHz)	Maximum Conducted Power (dBm)		Total Power (mW)	Total Power (dBm)	Limit (dBm)	Pass / Fail
		Chain 0	Chain 1				
42	5210	17.59	17.79	117.529	20.70	29.39	Pass
155	5775	22.26	22.57	348.984	25.43	29.39	Pass

Note: 1. Directional gain = $3.60\text{dBi} + 10\log(2) = 6.61\text{dBi} > 6\text{dBi}$, so the power limit shall be reduced to $30 - (6.61 - 6) = 29.39\text{dBm}$

Beamforming Mode / Client Mode

802.11ac (VHT20)

Chan.	Chan. Freq. (MHz)	Maximum Conducted Power (dBm)		Total Power (mW)	Total Power (dBm)	Limit (dBm)	Pass / Fail
		Chain 0	Chain 1				
36	5180	19.89	20.20	202.212	23.06	23.39	Pass
40	5200	20.01	20.21	205.185	23.12	23.39	Pass
48	5240	19.88	20.13	200.314	23.02	23.39	Pass
149	5745	26.24	26.29	846.325	29.28	29.39	Pass
157	5785	26.25	26.06	825.342	29.17	29.39	Pass
165	5825	26.05	25.89	790.867	28.98	29.39	Pass

- Note:** 1. UNII-1: Directional gain = $3.60\text{dBi} + 10\log(2) = 6.61\text{dBi} > 6\text{dBi}$, so the power limit shall be reduced to $24 - (6.61 - 6) = 23.39\text{dBm}$
 2. UNII-3: Directional gain = $3.60\text{dBi} + 10\log(2) = 6.61\text{dBi} > 6\text{dBi}$, so the power limit shall be reduced to $30 - (6.61 - 6) = 29.39\text{dBm}$

802.11ac (VHT40)

Chan.	Chan. Freq. (MHz)	Maximum Conducted Power (dBm)		Total Power (mW)	Total Power (dBm)	Limit (dBm)	Pass / Fail
		Chain 0	Chain 1				
38	5190	19.96	20.32	206.73	23.15	23.39	Pass
46	5230	19.88	20.36	205.918	23.14	23.39	Pass
151	5755	25.98	26.05	798.995	29.03	29.39	Pass
159	5795	25.86	26.01	784.503	28.95	29.39	Pass

- Note:** 1. UNII-1: Directional gain = $3.60\text{dBi} + 10\log(2) = 6.61\text{dBi} > 6\text{dBi}$, so the power limit shall be reduced to $24 - (6.61 - 6) = 23.39\text{dBm}$
 2. UNII-3: Directional gain = $3.60\text{dBi} + 10\log(2) = 6.61\text{dBi} > 6\text{dBi}$, so the power limit shall be reduced to $30 - (6.61 - 6) = 29.39\text{dBm}$

802.11ac (VHT80)

Chan.	Chan. Freq. (MHz)	Maximum Conducted Power (dBm)		Total Power (mW)	Total Power (dBm)	Limit (dBm)	Pass / Fail
		Chain 0	Chain 1				
42	5210	17.59	17.79	117.529	20.70	23.39	Pass
155	5775	22.26	22.57	348.984	25.43	29.39	Pass

- Note:** 1. UNII-1: Directional gain = $3.60\text{dBi} + 10\log(2) = 6.61\text{dBi} > 6\text{dBi}$, so the power limit shall be reduced to $24 - (6.61 - 6) = 23.39\text{dBm}$
 2. UNII-3: Directional gain = $3.60\text{dBi} + 10\log(2) = 6.61\text{dBi} > 6\text{dBi}$, so the power limit shall be reduced to $30 - (6.61 - 6) = 29.39\text{dBm}$

4.3.8 Test Result (Mode 3)

CDD Mode / Master Mode
802.11a

Chan.	Chan. Freq. (MHz)	Maximum Conducted Power (dBm)				Total Power (mW)	Total Power (dBm)	Limit (dBm)	Pass / Fail
		Chain 0	Chain 1	Chain 2	Chain 3				
36	5180	20.87	20.13	19.88	20.07	424.119	26.27	30.00	Pass
40	5200	20.48	20.39	19.90	20.11	421.371	26.25	30.00	Pass
48	5240	20.31	20.13	19.98	20.41	419.88	26.23	30.00	Pass
149	5745	22.98	23.30	22.87	22.07	767.112	28.85	30.00	Pass
157	5785	22.88	23.17	23.11	23.00	805.75	29.06	30.00	Pass
165	5825	22.99	23.05	22.75	22.96	786.966	28.96	30.00	Pass

802.11ac (VHT20)

Chan.	Chan. Freq. (MHz)	Maximum Conducted Power (dBm)				Total Power (mW)	Total Power (dBm)	Limit (dBm)	Pass / Fail
		Chain 0	Chain 1	Chain 2	Chain 3				
36	5180	20.69	20.08	19.98	19.84	415.003	26.18	30.00	Pass
40	5200	20.69	20.08	20.35	20.04	428.397	26.32	30.00	Pass
48	5240	20.31	19.79	19.89	20.48	411.864	26.15	30.00	Pass
149	5745	22.99	23.18	22.89	24.07	856.843	29.33	30.00	Pass
157	5785	22.97	23.15	22.65	24.77	888.684	29.49	30.00	Pass
165	5825	22.95	23.02	24.80	24.73	996.851	29.99	30.00	Pass

802.11ac (VHT40)

Chan.	Chan. Freq. (MHz)	Maximum Conducted Power (dBm)				Total Power (mW)	Total Power (dBm)	Limit (dBm)	Pass / Fail
		Chain 0	Chain 1	Chain 2	Chain 3				
38	5190	19.13	18.75	18.89	18.74	309.098	24.90	30.00	Pass
46	5230	23.15	22.72	23.02	22.90	789.037	28.97	30.00	Pass
151	5755	23.56	23.85	23.62	23.51	924.179	29.66	30.00	Pass
159	5795	23.79	24.08	23.69	24.10	986.115	29.94	30.00	Pass

802.11ac (VHT80)

Chan.	Chan. Freq. (MHz)	Maximum Conducted Power (dBm)				Total Power (mW)	Total Power (dBm)	Limit (dBm)	Pass / Fail
		Chain 0	Chain 1	Chain 2	Chain 3				
42	5210	16.92	16.58	16.66	16.49	185.614	22.69	30.00	Pass
155	5775	20.15	20.89	19.96	19.84	421.724	26.25	30.00	Pass

CDD Mode / Client Mode
802.11a

Chan.	Chan. Freq. (MHz)	Maximum Conducted Power (dBm)				Total Power (mW)	Total Power (dBm)	Limit (dBm)	Pass / Fail
		Chain 0	Chain 1	Chain 2	Chain 3				
36	5180	14.87	14.13	13.88	14.07	106.533	20.27	24.00	Pass
40	5200	14.48	14.39	13.90	14.11	105.843	20.25	24.00	Pass
48	5240	14.31	14.13	13.98	14.41	105.468	20.23	24.00	Pass
149	5745	22.98	23.30	22.87	22.07	767.112	28.85	30.00	Pass
157	5785	22.88	23.17	23.11	23.00	805.75	29.06	30.00	Pass
165	5825	22.99	23.05	22.75	22.96	786.966	28.96	30.00	Pass

802.11ac (VHT20)

Chan.	Chan. Freq. (MHz)	Maximum Conducted Power (dBm)				Total Power (mW)	Total Power (dBm)	Limit (dBm)	Pass / Fail
		Chain 0	Chain 1	Chain 2	Chain 3				
36	5180	14.69	14.08	13.98	13.84	104.243	20.18	24.00	Pass
40	5200	14.69	14.08	14.35	14.04	107.608	20.32	24.00	Pass
48	5240	14.31	13.79	13.89	14.47	103.391	20.14	24.00	Pass
149	5745	22.99	23.18	22.89	24.07	856.843	29.33	30.00	Pass
157	5785	22.97	23.15	22.65	24.77	888.684	29.49	30.00	Pass
165	5825	22.95	23.02	24.80	24.73	996.851	29.99	30.00	Pass

802.11ac (VHT40)

Chan.	Chan. Freq. (MHz)	Maximum Conducted Power (dBm)				Total Power (mW)	Total Power (dBm)	Limit (dBm)	Pass / Fail
		Chain 0	Chain 1	Chain 2	Chain 3				
38	5190	17.63	16.88	17.39	17.24	214.49	23.31	24.00	Pass
46	5230	17.56	16.72	17.33	16.90	207.058	23.16	24.00	Pass
151	5755	23.56	23.85	23.62	23.51	924.179	29.66	30.00	Pass
159	5795	23.79	24.08	23.69	24.10	986.115	29.94	30.00	Pass

802.11ac (VHT80)

Chan.	Chan. Freq. (MHz)	Maximum Conducted Power (dBm)				Total Power (mW)	Total Power (dBm)	Limit (dBm)	Pass / Fail
		Chain 0	Chain 1	Chain 2	Chain 3				
42	5210	16.92	16.58	16.66	16.49	185.614	22.69	24.00	Pass
155	5775	20.15	20.89	19.96	19.84	421.724	26.25	30.00	Pass

Beamforming Mode / Master Mode

802.11ac (VHT20)

Chan.	Chan. Freq. (MHz)	Maximum Conducted Power (dBm)				Total Power (mW)	Total Power (dBm)	Limit (dBm)	Pass / Fail
		Chain 0	Chain 1	Chain 2	Chain 3				
36	5180	20.69	20.08	19.98	19.84	415.003	26.18	26.38	Pass
40	5200	20.69	20.08	20.35	20.04	428.397	26.32	26.38	Pass
48	5240	20.31	19.79	19.89	20.48	411.864	26.15	26.38	Pass
149	5745	19.99	20.18	19.89	21.07	429.439	26.33	26.38	Pass
157	5785	19.97	20.15	19.65	20.77	414.482	26.18	26.38	Pass
165	5825	19.85	19.76	20.90	20.73	432.56	26.36	26.38	Pass

Note: 1. Directional gain = $3.60\text{dBi} + 10\log(4) = 9.62\text{dBi} > 6\text{dBi}$, so the power limit shall be reduced to $30 - (9.62 - 6) = 26.38\text{dBm}$

802.11ac (VHT40)

Chan.	Chan. Freq. (MHz)	Maximum Conducted Power (dBm)				Total Power (mW)	Total Power (dBm)	Limit (dBm)	Pass / Fail
		Chain 0	Chain 1	Chain 2	Chain 3				
38	5190	19.13	18.75	18.89	18.74	309.098	24.90	26.38	Pass
46	5230	20.65	19.72	20.52	19.87	419.672	26.23	26.38	Pass
151	5755	19.66	19.98	20.62	20.31	414.755	26.18	26.38	Pass
159	5795	19.79	20.08	19.69	20.10	392.579	25.94	26.38	Pass

Note: 1. Directional gain = $3.60\text{dBi} + 10\log(4) = 9.62\text{dBi} > 6\text{dBi}$, so the power limit shall be reduced to $30 - (9.62 - 6) = 26.38\text{dBm}$

802.11ac (VHT80)

Chan.	Chan. Freq. (MHz)	Maximum Conducted Power (dBm)				Total Power (mW)	Total Power (dBm)	Limit (dBm)	Pass / Fail
		Chain 0	Chain 1	Chain 2	Chain 3				
42	5210	16.92	16.58	16.66	16.49	185.614	22.69	26.38	Pass
155	5775	20.15	20.89	19.96	19.84	421.724	26.25	26.38	Pass

Note: 1. Directional gain = $3.60\text{dBi} + 10\log(4) = 9.62\text{dBi} > 6\text{dBi}$, so the power limit shall be reduced to $30 - (9.62 - 6) = 26.38\text{dBm}$

Beamforming Mode / Client Mode

802.11ac (VHT20)

Chan.	Chan. Freq. (MHz)	Maximum Conducted Power (dBm)				Total Power (mW)	Total Power (dBm)	Limit (dBm)	Pass / Fail
		Chain 0	Chain 1	Chain 2	Chain 3				
36	5180	14.69	14.08	13.98	13.84	104.243	20.18	20.38	Pass
40	5200	14.69	14.08	14.35	14.04	107.608	20.32	20.38	Pass
48	5240	14.31	13.79	13.89	14.47	103.391	20.14	20.38	Pass
149	5745	19.99	20.18	19.89	21.07	429.439	26.33	26.38	Pass
157	5785	19.97	20.15	19.65	20.77	414.482	26.18	26.38	Pass
165	5825	19.85	19.76	20.90	20.73	432.56	26.36	26.38	Pass

- Note:** 1. UNII-1: Directional gain = $3.60\text{dBi} + 10\log(4) = 9.62\text{dBi} > 6\text{dBi}$, so the power limit shall be reduced to $24 - (9.62 - 6) = 20.38\text{dBm}$
 2. UNII-3: Directional gain = $3.60\text{dBi} + 10\log(4) = 9.62\text{dBi} > 6\text{dBi}$, so the power limit shall be reduced to $30 - (9.62 - 6) = 26.38\text{dBm}$

802.11ac (VHT40)

Chan.	Chan. Freq. (MHz)	Maximum Conducted Power (dBm)				Total Power (mW)	Total Power (dBm)	Limit (dBm)	Pass / Fail
		Chain 0	Chain 1	Chain 2	Chain 3				
38	5190	14.63	13.88	14.39	14.24	107.499	20.31	20.38	Pass
46	5230	14.56	13.72	14.33	13.90	103.775	20.16	20.38	Pass
151	5755	19.66	19.98	20.62	20.31	414.755	26.18	26.38	Pass
159	5795	19.79	20.08	19.69	20.10	392.579	25.94	26.38	Pass

- Note:** 1. UNII-1: Directional gain = $3.60\text{dBi} + 10\log(4) = 9.62\text{dBi} > 6\text{dBi}$, so the power limit shall be reduced to $24 - (9.62 - 6) = 20.38\text{dBm}$
 2. UNII-3: Directional gain = $3.60\text{dBi} + 10\log(4) = 9.62\text{dBi} > 6\text{dBi}$, so the power limit shall be reduced to $30 - (9.62 - 6) = 26.38\text{dBm}$

802.11ac (VHT80)

Chan.	Chan. Freq. (MHz)	Maximum Conducted Power (dBm)				Total Power (mW)	Total Power (dBm)	Limit (dBm)	Pass / Fail
		Chain 0	Chain 1	Chain 2	Chain 3				
42	5210	14.92	13.68	14.66	13.87	108.001	20.33	20.38	Pass
155	5775	20.15	20.89	19.96	19.84	421.724	26.25	26.38	Pass

- Note:** 1. UNII-1: Directional gain = $3.60\text{dBi} + 10\log(4) = 9.62\text{dBi} > 6\text{dBi}$, so the power limit shall be reduced to $24 - (9.62 - 6) = 20.38\text{dBm}$
 2. UNII-3: Directional gain = $3.60\text{dBi} + 10\log(4) = 9.62\text{dBi} > 6\text{dBi}$, so the power limit shall be reduced to $30 - (9.62 - 6) = 26.38\text{dBm}$

4.4 Occupied Bandwidth Measurement

4.4.1 Test Setup

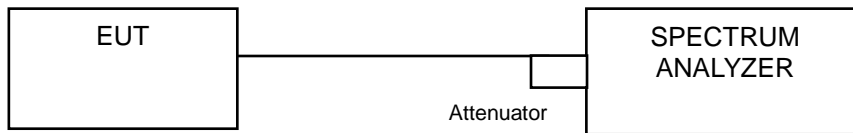

4.4.2 Test Instruments

Refer to section 4.1.2 to get information of above instrument.

4.4.3 Test Procedure

The transmitter output was connected to the spectrum analyzer through an attenuator. The bandwidth of the fundamental frequency was measured by spectrum analyzer with resolution bandwidth in the range of 1% to 5% of the anticipated emission bandwidth, and a video bandwidth at least 3x the resolution bandwidth and set the detector to SAMPLE. The width of a frequency band such that, below the lower and above the upper frequency limits, the mean powers emitted are each equal to a specified percentage 0.5 %of the total mean power of a given emission.

4.4.4 Test Results (Mode 1)

Master Mode

802.11a

Channel	Channel Frequency (MHz)	Occupied Bandwidth (MHz)	
		CHAIN 0	CHAIN 1
36	5180	16.56	16.56
40	5200	22.44	19.68
48	5240	17.16	17.64
149	5745	27.84	25.44
157	5785	28.08	22.92
165	5825	27.72	24.96

802.11ac (VHT20)

Channel	Channel Frequency (MHz)	Occupied Bandwidth (MHz)	
		CHAIN 0	CHAIN 1
36	5180	17.76	17.64
40	5200	18.84	19.56
48	5240	18.24	18.36
149	5745	29.16	24.00
157	5785	28.68	21.24
165	5825	28.08	24.24

802.11ac (VHT40)

Channel	Channel Frequency (MHz)	Occupied Bandwidth (MHz)	
		CHAIN 0	CHAIN 1
38	5190	36.24	36.24
46	5230	36.72	36.96
151	5755	51.12	46.80
159	5795	46.32	42.48

802.11ac (VHT80)

Channel	Channel Frequency (MHz)	Occupied Bandwidth (MHz)	
		CHAIN 0	CHAIN 1
42	5210	75.84	75.84
155	5775	75.84	76.32

Spectrum Plot of Worst Value

802.11a_Chain0 / CH157

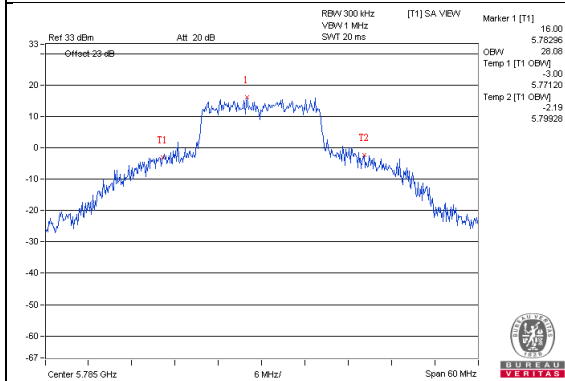

802.11ac (VHT20)_Chain0 / CH149

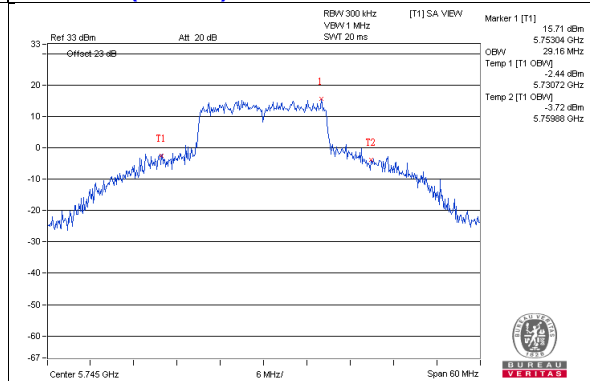

802.11ac (VHT40)_Chain0 / CH151

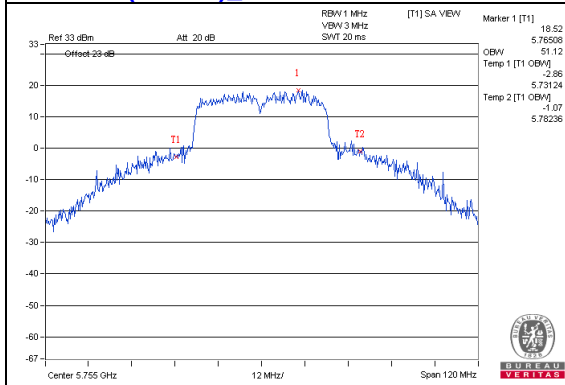

802.11ac (VHT80)_Chain1 / CH155

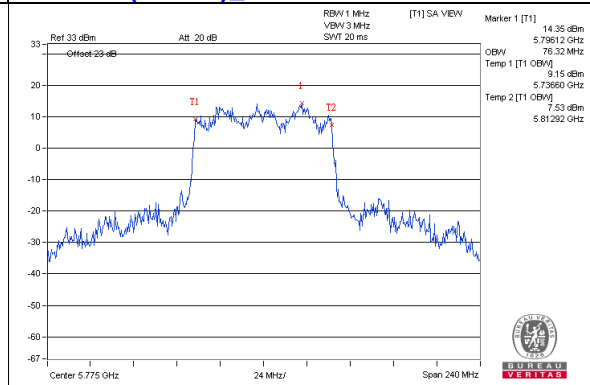

Client Mode
802.11a

Channel	Channel Frequency (MHz)	Occupied Bandwidth (MHz)	
		CHAIN 0	CHAIN 1
36	5180	16.56	16.32
40	5200	16.56	16.56
48	5240	16.44	16.44
149	5745	27.84	25.44
157	5785	28.08	22.92
165	5825	27.72	24.96

802.11ac (VHT20)

Channel	Channel Frequency (MHz)	Occupied Bandwidth (MHz)	
		CHAIN 0	CHAIN 1
36	5180	17.76	17.76
40	5200	17.76	17.64
48	5240	17.76	17.76
149	5745	29.16	24.00
157	5785	28.68	21.24
165	5825	28.08	24.24

802.11ac (VHT40)

Channel	Channel Frequency (MHz)	Occupied Bandwidth (MHz)	
		CHAIN 0	CHAIN 1
38	5190	36.24	36.48
46	5230	36.24	36.24
151	5755	51.12	46.80
159	5795	46.32	42.48

802.11ac (VHT80)

Channel	Channel Frequency (MHz)	Occupied Bandwidth (MHz)	
		CHAIN 0	CHAIN 1
42	5210	76.32	75.36
155	5775	75.84	76.32

Spectrum Plot of Worst Value

802.11a_Chain0 / CH157

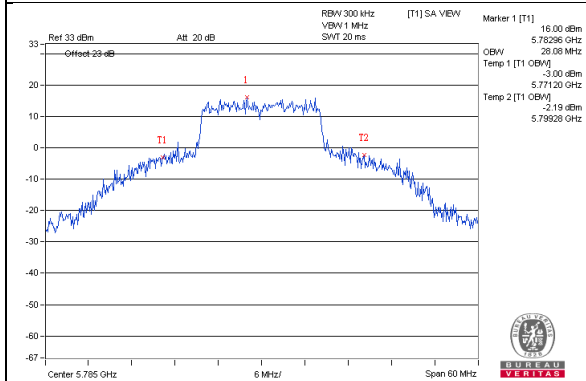

802.11ac (VHT20)_Chain0 / CH149

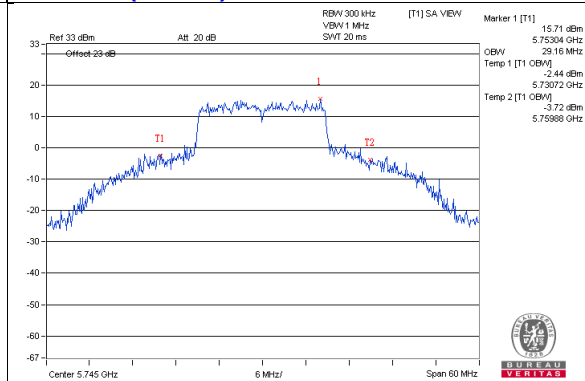

802.11ac (VHT40)_Chain0 / CH151

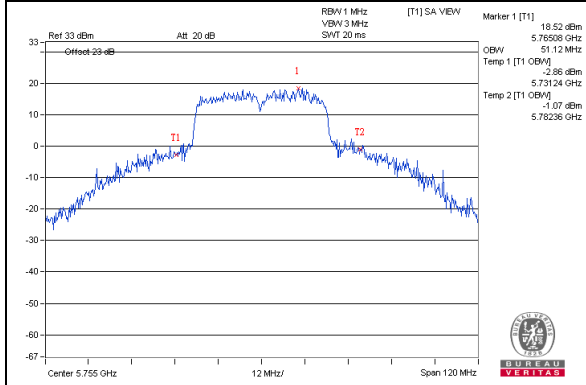

802.11ac (VHT80)_Chain1 / CH155

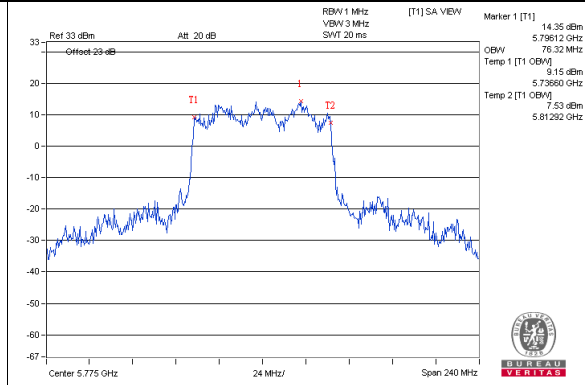

Spectrum Plot for near by DFS band (DFS is required, if 99% OCP straddle into U-NII-2A band)

802.11a_Chain0 / CH48

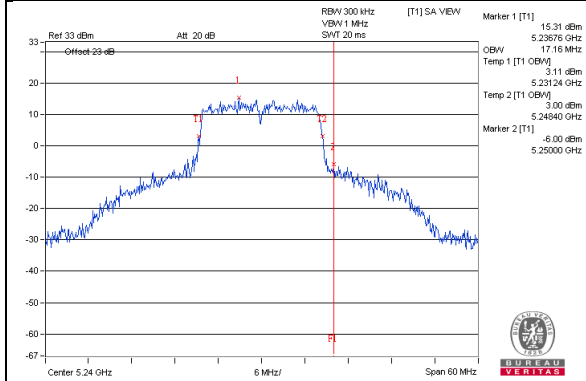

802.11a_Chain1 / CH48

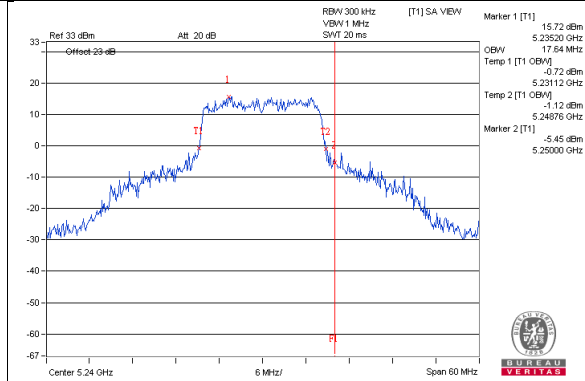

802.11ac(VHT20)_Chain0 / CH48

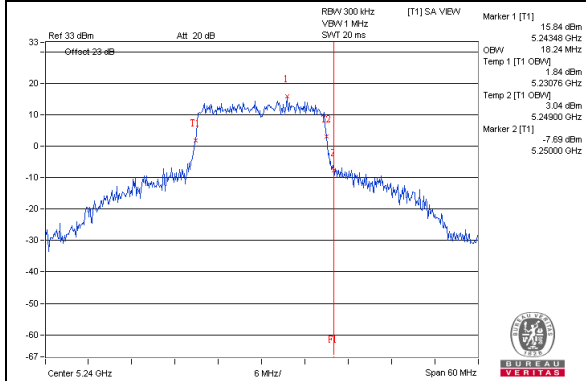

802.11ac(VHT20)_Chain1 / CH48

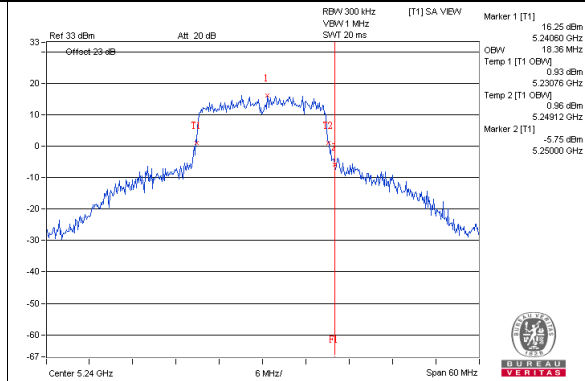

802.11ac(VHT40)_Chain0 / CH46

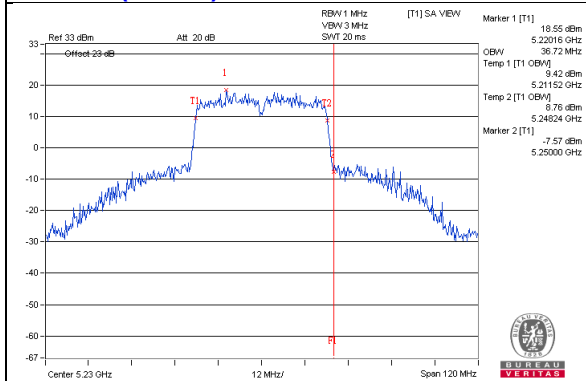

802.11ac(VHT40)_Chain1 / CH46

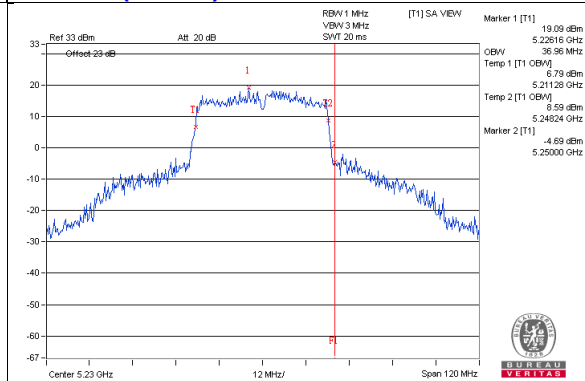

802.11ac(VHT80)_Chain0 / CH42

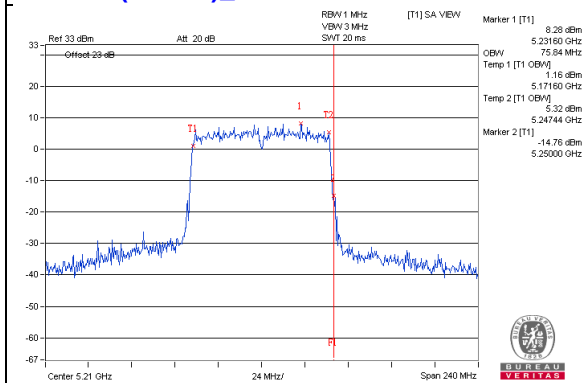

802.11ac(VHT80)_Chain1 / CH42

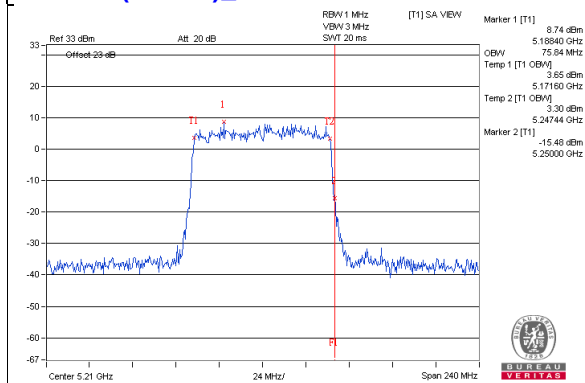

Spectrum Plot for near by DFS band (DFS is required, if 99% OCP straddle into U-NII-2C band)

802.11a_Chain0 / CH149

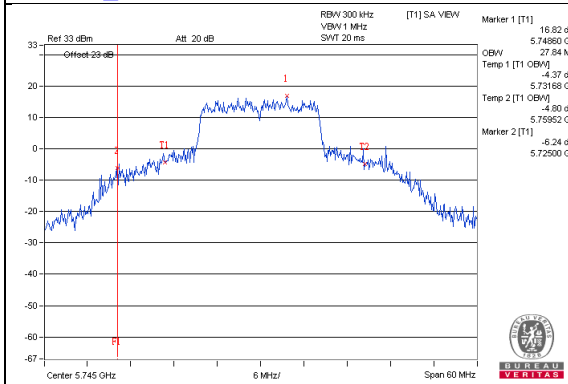

802.11a_Chain1 / CH149

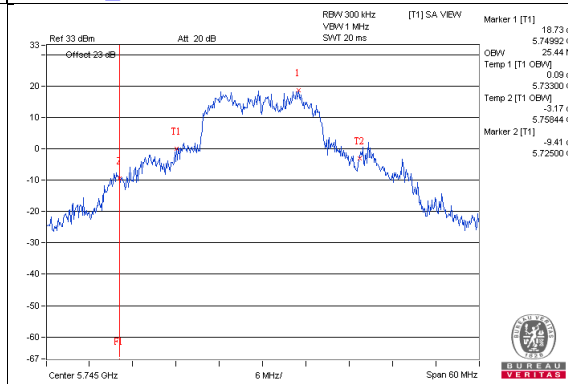

802.11ac(VHT20)_Chain0 / CH149

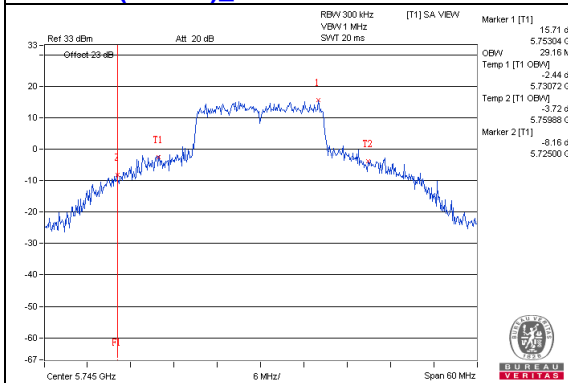

802.11ac(VHT20)_Chain1 / CH149

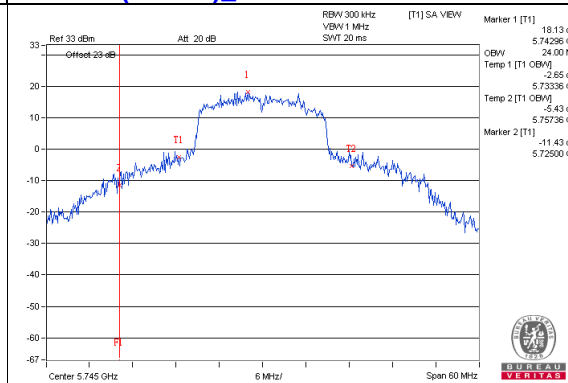

802.11ac(VHT40)_Chain0 / CH151

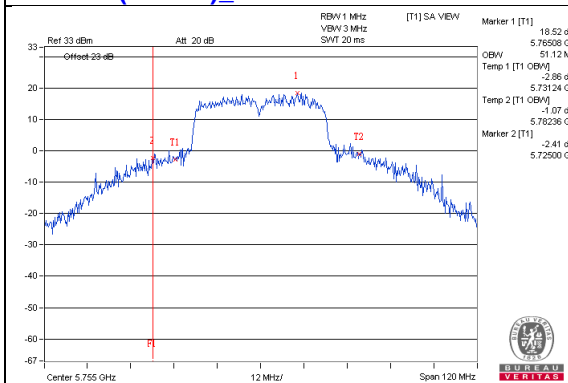

802.11ac(VHT40)_Chain1 / CH151



802.11ac(VHT80)_Chain0 / CH155

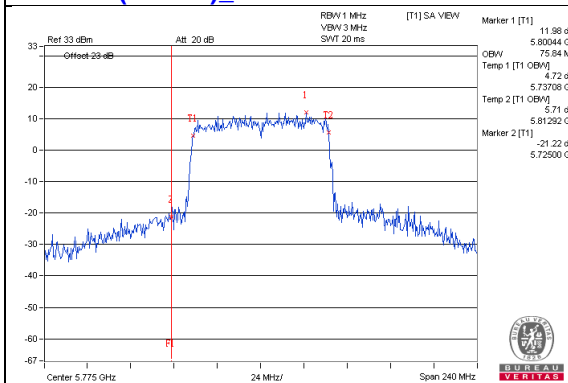

802.11ac(VHT80)_Chain1 / CH155

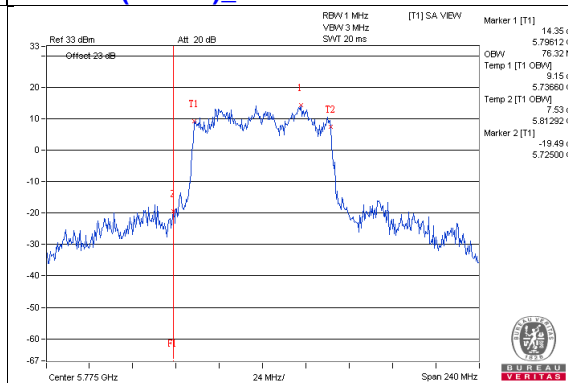

4.4.5 Test Results (Mode 3)

Master Mode

802.11a

Channel	Channel Frequency (MHz)	Occupied Bandwidth (MHz)			
		Chain 0	Chain 1	Chain 2	Chain 3
36	5180	16.44	16.44	16.56	16.56
40	5200	16.56	16.44	16.44	16.44
48	5240	16.44	16.44	16.44	16.44
149	5745	16.56	16.56	16.44	16.56
157	5785	16.44	16.56	16.56	16.56
165	5825	16.56	16.56	16.56	16.56

802.11ac (VHT20)

Channel	Channel Frequency (MHz)	Occupied Bandwidth (MHz)			
		Chain 0	Chain 1	Chain 2	Chain 3
36	5180	17.76	17.64	17.64	17.64
40	5200	17.64	17.64	17.76	17.64
48	5240	17.64	17.76	17.64	17.76
149	5745	17.64	17.76	17.64	17.76
157	5785	17.64	17.76	17.64	17.76
165	5825	17.64	17.76	17.76	17.64

802.11ac (VHT40)

Channel	Channel Frequency (MHz)	Occupied Bandwidth (MHz)			
		Chain 0	Chain 1	Chain 2	Chain 3
38	5190	36.24	36.24	36.24	36.24
46	5230	36.24	36.24	36.24	36.48
151	5755	36.24	36.24	36.24	36.24
159	5795	36.24	36.24	36.48	36.24

802.11ac (VHT80)

Channel	Channel Frequency (MHz)	Occupied Bandwidth (MHz)			
		Chain 0	Chain 1	Chain 2	Chain 3
42	5210	75.84	75.84	75.84	76.32
155	5775	76.32	75.84	76.32	75.84

Spectrum Plot of Worst Value

802.11a_Chain0 / CH40

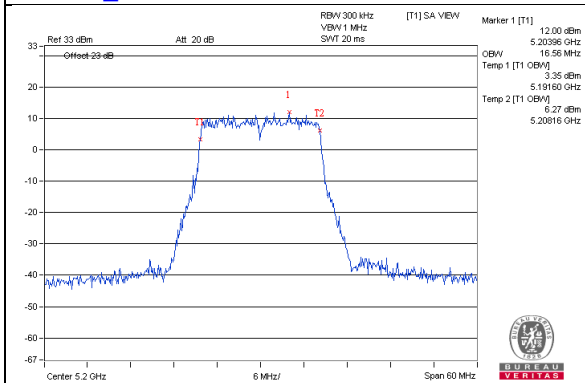

802.11ac (VHT20)_Chain0 / CH36

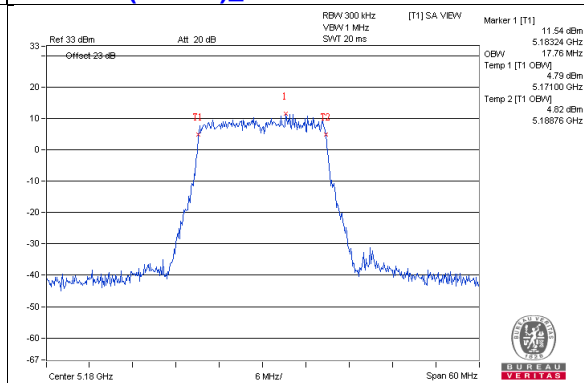

802.11ac (VHT40)_Chain3 / CH46

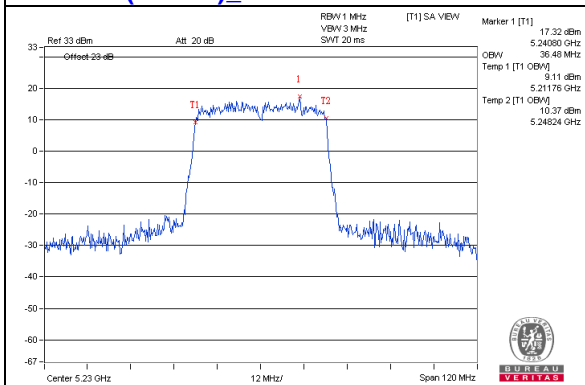

802.11ac (VHT80)_Chain0 / CH155

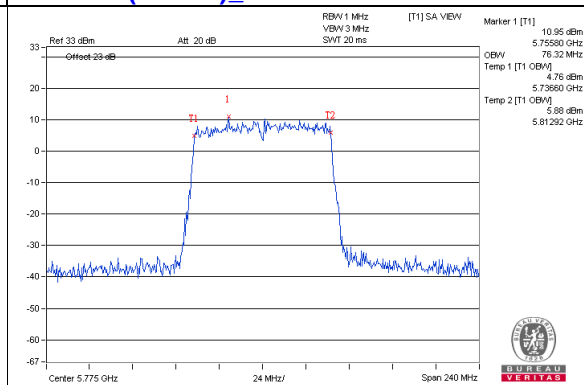

Client Mode
802.11a

Channel	Channel Frequency (MHz)	Occupied Bandwidth (MHz)			
		Chain 0	Chain 1	Chain 2	Chain 3
36	5180	16.56	16.44	16.44	16.56
40	5200	16.44	16.44	16.44	16.44
48	5240	16.56	16.44	16.44	16.44
149	5745	16.56	16.56	16.44	16.56
157	5785	16.44	16.56	16.56	16.56
165	5825	16.56	16.56	16.56	16.56

802.11ac (VHT20)

Channel	Channel Frequency (MHz)	Occupied Bandwidth (MHz)			
		Chain 0	Chain 1	Chain 2	Chain 3
36	5180	17.64	17.76	17.64	17.64
40	5200	17.64	17.76	17.64	17.64
48	5240	17.64	17.64	17.76	17.64
149	5745	17.64	17.76	17.64	17.76
157	5785	17.64	17.76	17.64	17.76
165	5825	17.64	17.76	17.76	17.64

802.11ac (VHT40)

Channel	Channel Frequency (MHz)	Occupied Bandwidth (MHz)			
		Chain 0	Chain 1	Chain 2	Chain 3
38	5190	36.24	36.24	36.24	36.24
46	5230	36.24	36.24	36.24	36.24
151	5755	36.24	36.24	36.24	36.24
159	5795	36.24	36.24	36.48	36.24

802.11ac (VHT80)

Channel	Channel Frequency (MHz)	Occupied Bandwidth (MHz)			
		Chain 0	Chain 1	Chain 2	Chain 3
42	5210	75.84	75.84	75.84	76.32
155	5775	76.32	75.84	76.32	75.84

Spectrum Plot of Worst Value

802.11a_Chain0 / CH36

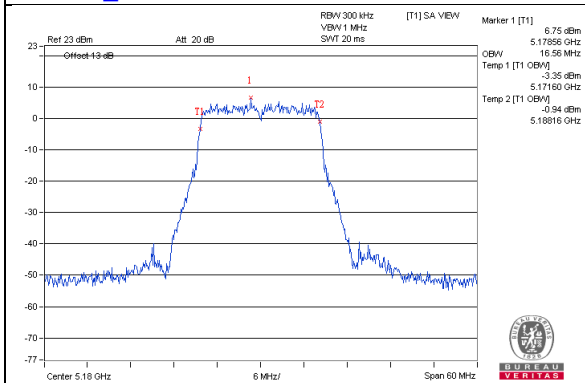

802.11ac (VHT20)_Chain1 / CH36

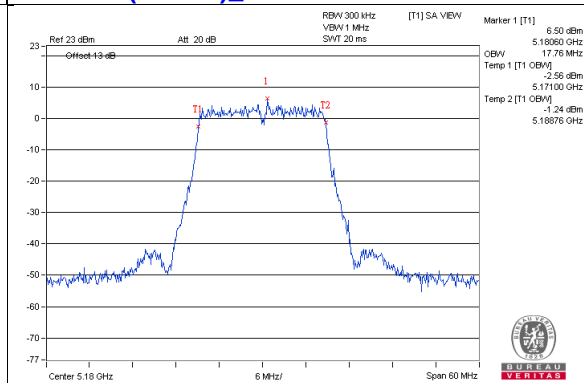

802.11ac (VHT40)_Chain2 / CH159

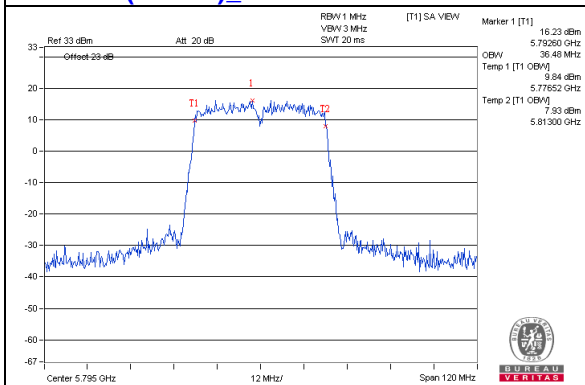

802.11ac (VHT80)_Chain0 / CH155

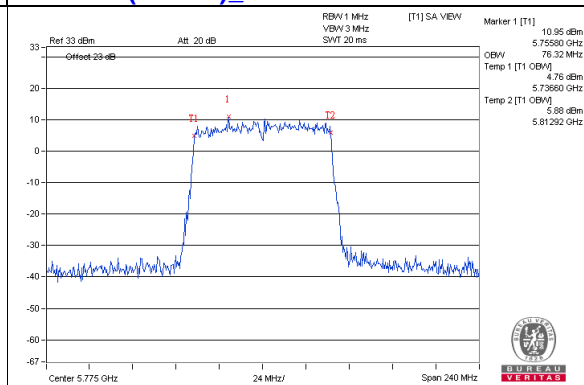

Spectrum Plot for near by DFS band (DFS is required, if 99% OCP straddle into U-NII-2A band)

802.11a / Chain 0 : CH48

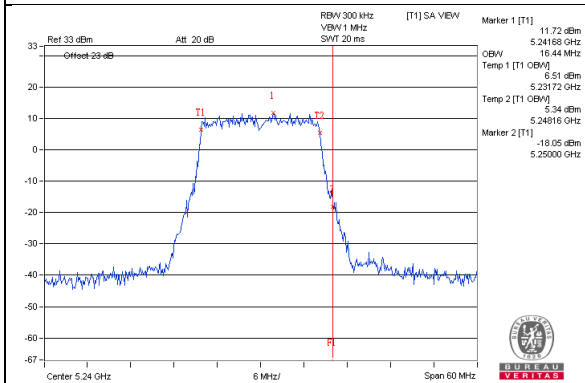

802.11a / Chain 1 : CH48

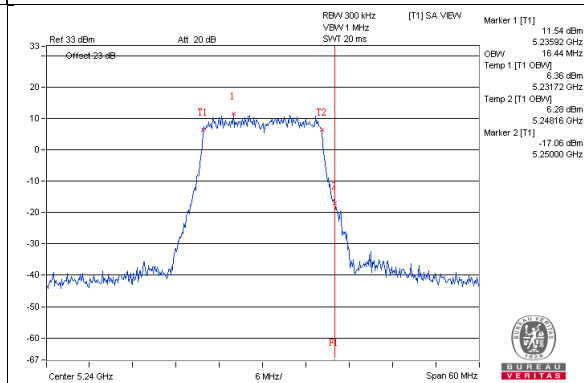

802.11a / Chain 2 : CH48

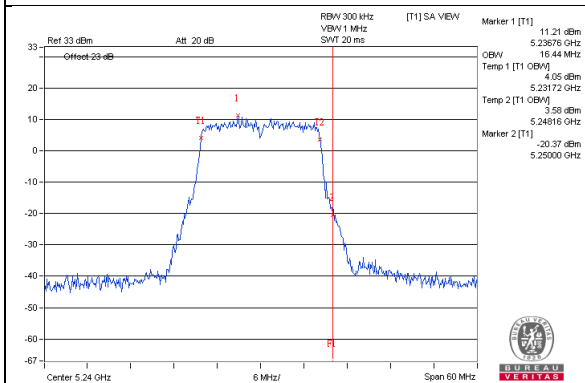

802.11a / Chain 3 : CH48

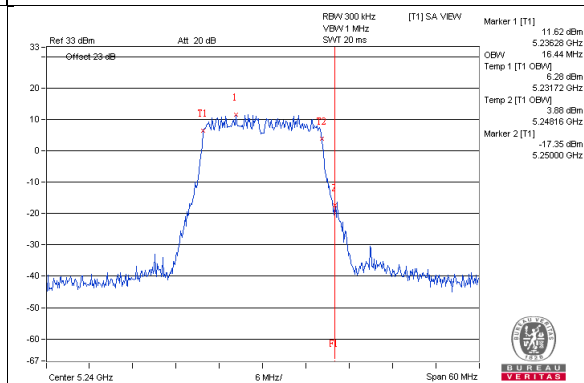

802.11ac (VHT20) / Chain 0 : CH48

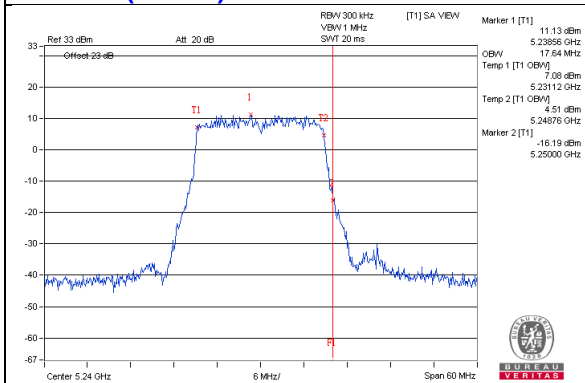

802.11ac (VHT20) / Chain 1 : CH48

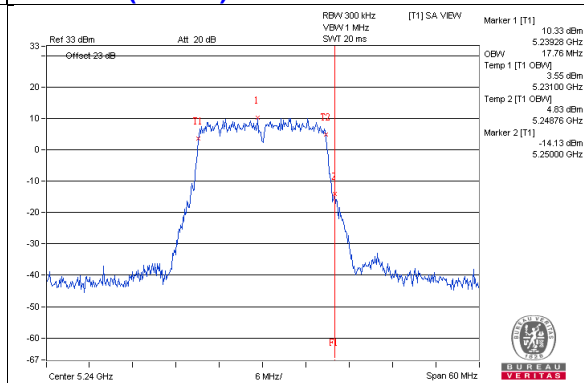

802.11ac (VHT20) / Chain 2 : CH48

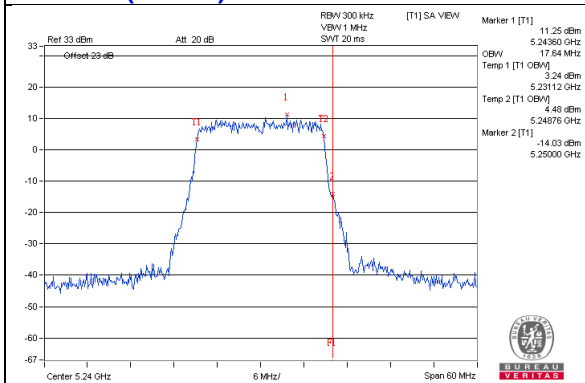

802.11ac (VHT20) / Chain 3 : CH48

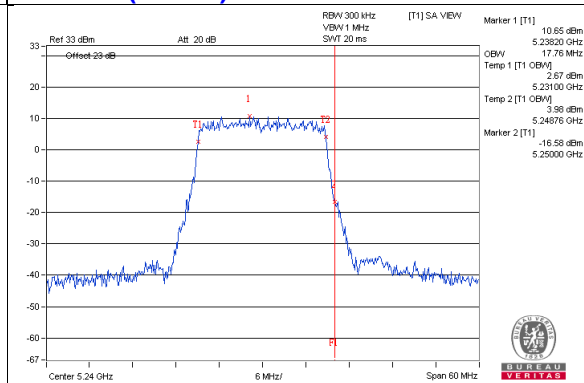

**Spectrum Plot for near by DFS band
(DFS is required, if 99% OCP straddle into U-NII-2A band)**

802.11ac (VHT40) / Chain 0 : CH46

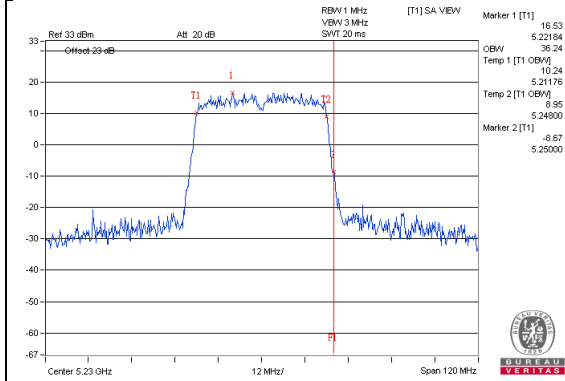

802.11ac (VHT40) / Chain 1 : CH46

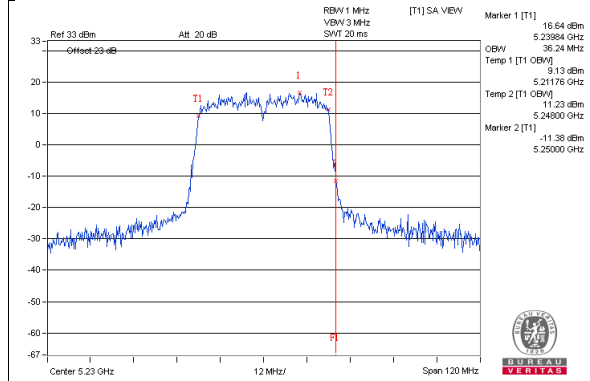

802.11ac (VHT40) / Chain 2 : CH46

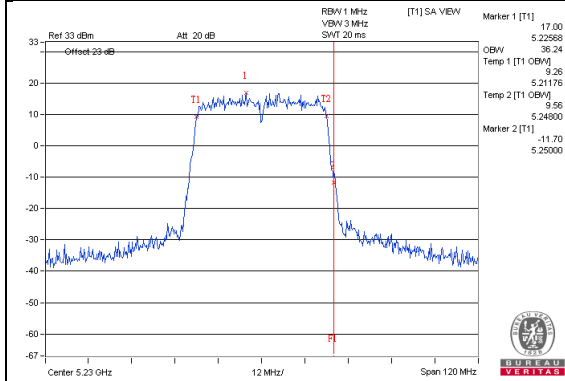

802.11ac (VHT40) / Chain 3 : CH46

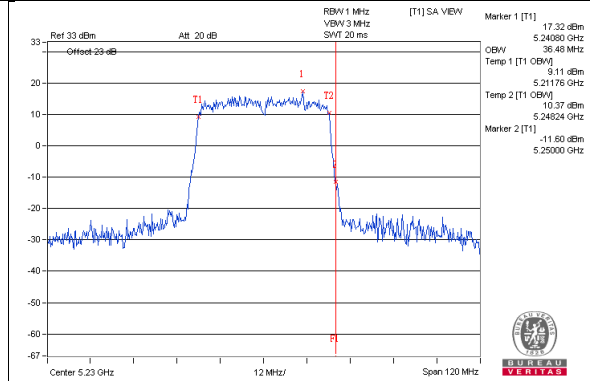

802.11ac (VHT80) / Chain 0 : CH42

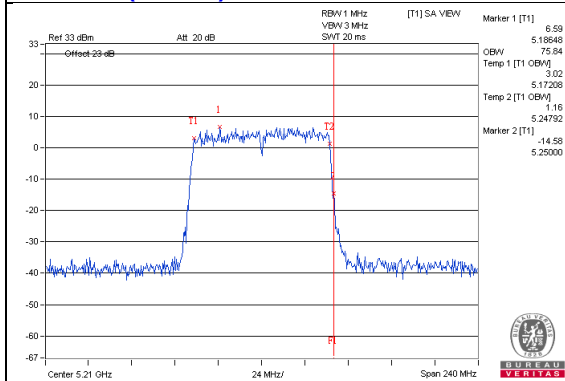

802.11ac (VHT80) / Chain 1 : CH42

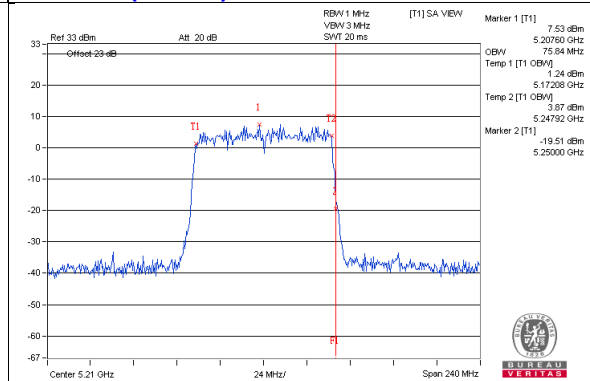

802.11ac (VHT80) / Chain 2 : CH42

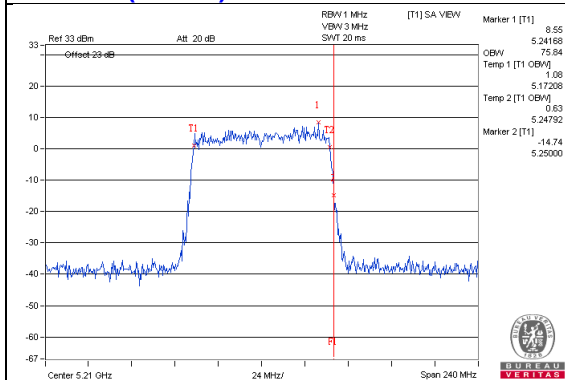

802.11ac (VHT80) / Chain 3 : CH42

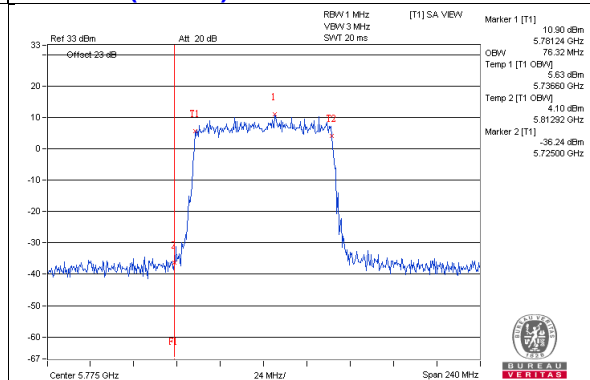

Spectrum Plot for near by DFS band (DFS is required, if 99% OCP straddle into U-NII-2C band)

802.11a / Chain 0 : CH149

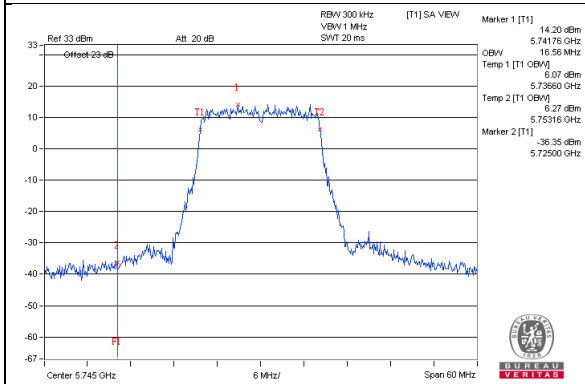

802.11a / Chain 1 : CH149

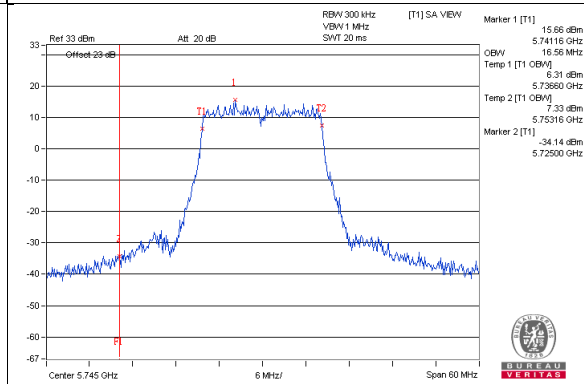

802.11a / Chain 2 : CH149

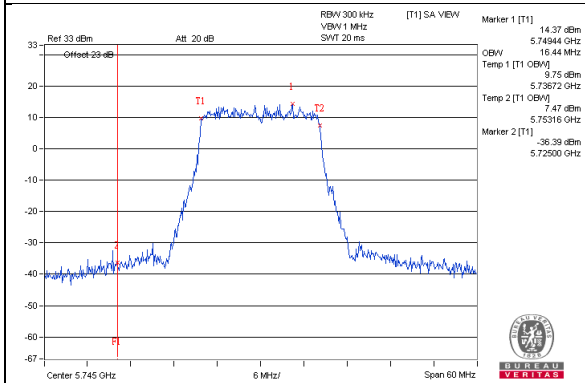

802.11a / Chain 3 : CH149

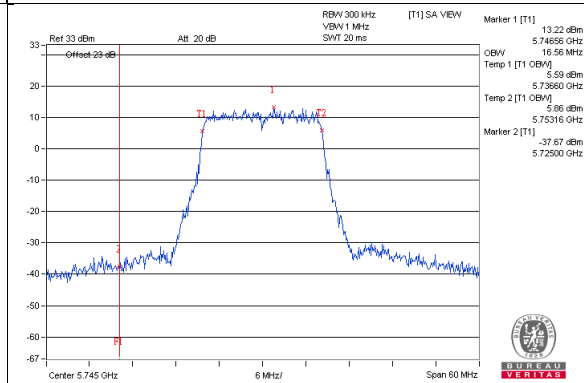

802.11ac (VHT20) / Chain 0 : CH149

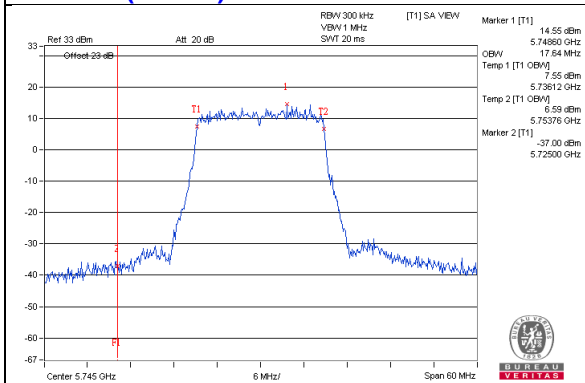

802.11ac (VHT20) / Chain 1 : CH149

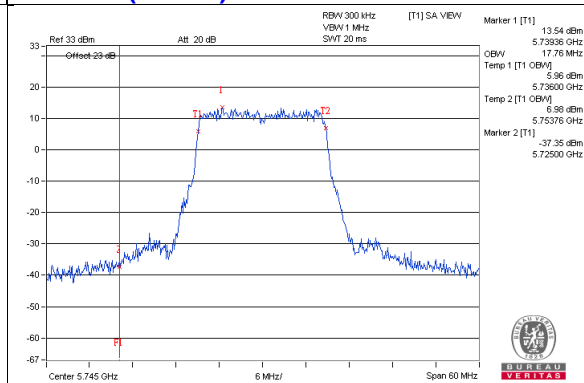

802.11ac (VHT20) / Chain 2 : CH149

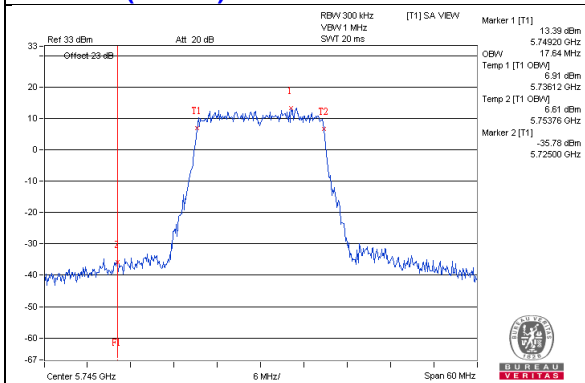

802.11ac (VHT20) / Chain 3 : CH149

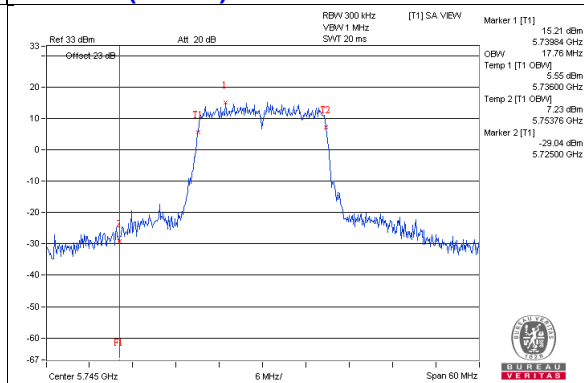

Spectrum Plot for near by DFS band (DFS is required, if 99% OCP straddle into U-NII-2C band)

802.11ac (VHT40) / Chain 0 : CH151

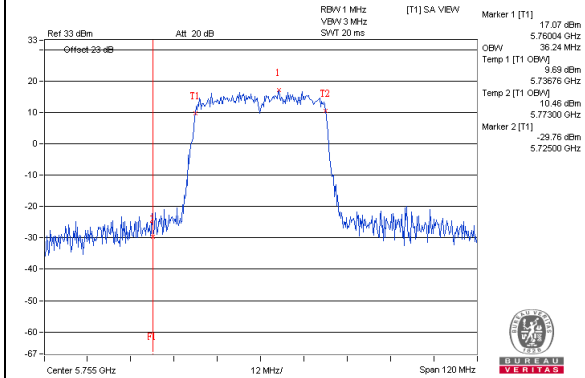

802.11ac (VHT40) / Chain 1 : CH151

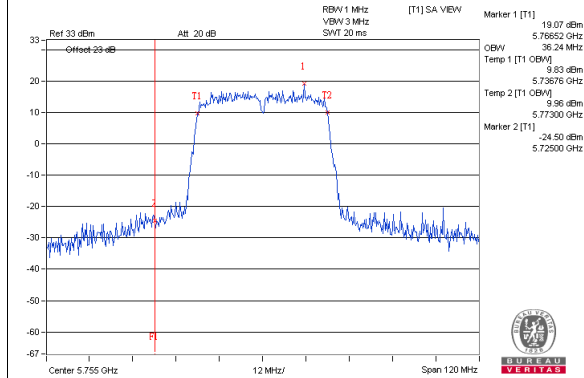

802.11ac (VHT40) / Chain 2 : CH151

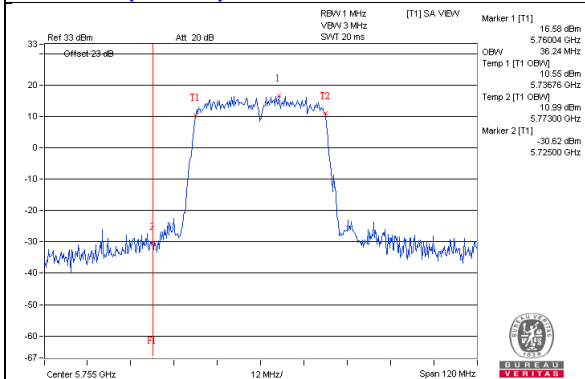

802.11ac (VHT40) / Chain 3 : CH151

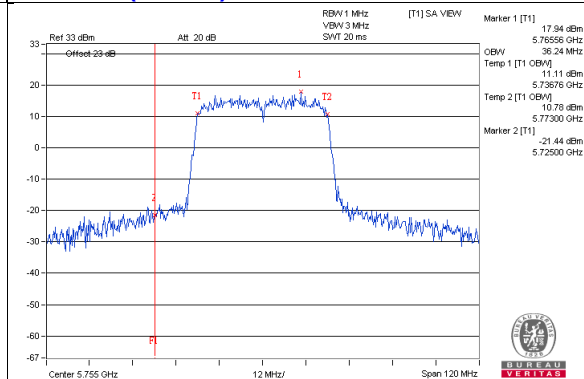

802.11ac (VHT80) / Chain 0 : CH155

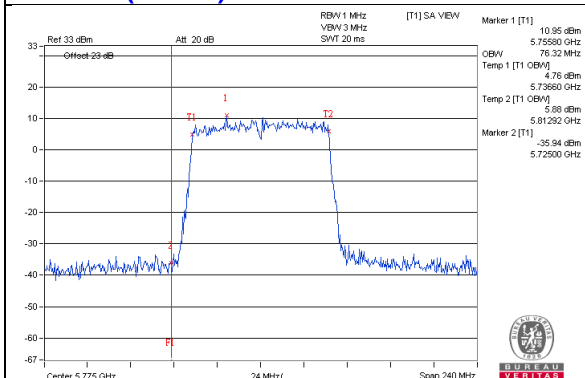

802.11ac (VHT80) / Chain 1 : CH155

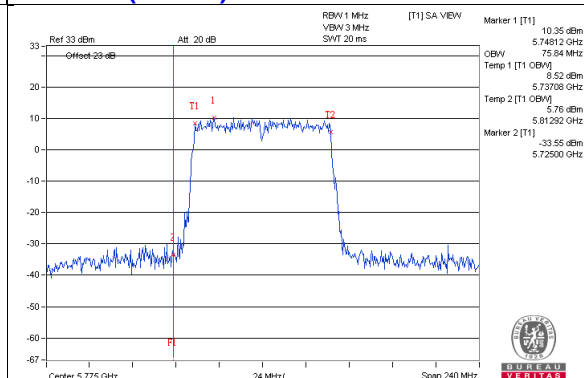

802.11ac (VHT80) / Chain 2 : CH155

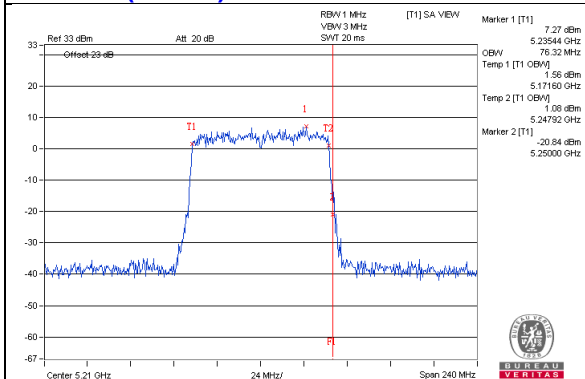

802.11ac (VHT80) / Chain 3 : CH155

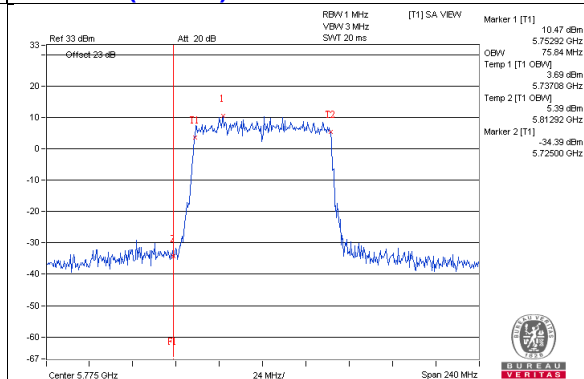

4.5 Peak Power Spectral Density Measurement

4.5.1 Limits of Peak Power Spectral Density Measurement

Operation Band	EUT Category		Limit
U-NII-1		Outdoor Access Point	17dBm/ MHz
		Fixed point-to-point Access Point	
	√	Indoor Access Point	11dBm/ MHz
	√	Mobile and Portable client device	
U-NII-2A			11dBm/ MHz
U-NII-2C			11dBm/ MHz
U-NII-3	√		30dBm/ 500kHz

4.5.2 Test Setup

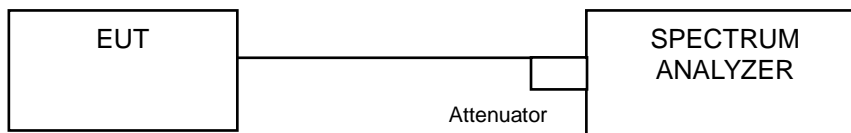

4.5.3 Test Instruments

Refer to section 4.1.2 to get information of above instrument.

4.5.4 Test Procedure

802.11ac (VHT20)

For U-NII-1:

Using method SA-1

1. Set span to encompass the entire emission bandwidth (EBW) of the signal.
2. Set RBW = 1 MHz, Set VBW \geq 3 MHz, Detector = RMS
3. Sweep time = auto, trigger set to "free run".
4. Trace average at least 100 traces in power averaging mode.
5. Record the max value

For U-NII-3:

1. Set span to encompass the entire emission bandwidth (EBW) of the signal.
2. Set RBW = 300 kHz, Set VBW \geq 1 MHz, Detector = RMS
3. Use the peak marker function to determine the maximum power level in any 300 kHz band segment within the fundamental EBW.
4. Scale the observed power level to an equivalent value in 500 kHz by adjusting (reducing) the measured power by a bandwidth correction factor (BWCF) where $BWCF = 10\log(500 \text{ kHz}/300\text{kHz})$
5. Sweep time = auto, trigger set to "free run".
6. Trace average at least 100 traces in power averaging mode.
7. Record the max value

802.11a, 802.11ac (VHT40), 802.11ac (VHT80)

For U-NII-1:

Using method SA-2

1. Set span to encompass the entire emission bandwidth (EBW) of the signal.
2. Set RBW = 1 MHz, Set VBW \geq 3 MHz, Detector = RMS
3. Sweep time = auto, trigger set to "free run".
4. Trace average at least 100 traces in power averaging mode.
5. Record the max value and add $10 \log (1/\text{duty cycle})$

For U-NII-3:

1. Set span to encompass the entire emission bandwidth (EBW) of the signal.
2. Set RBW = 300 kHz, Set VBW \geq 1 MHz, Detector = RMS
3. Use the peak marker function to determine the maximum power level in any 300 kHz band segment within the fundamental EBW.
4. Scale the observed power level to an equivalent value in 500 kHz by adjusting (reducing) the measured power by a bandwidth correction factor (BWCF) where $BWCF = 10\log(500 \text{ kHz}/300\text{kHz})$
5. Sweep time = auto, trigger set to "free run".
6. Trace average at least 100 traces in power averaging mode.
7. Record the max value and add $10 \log (1/\text{duty cycle})$

4.5.5 Deviation from Test Standard

No deviation.

4.5.6 EUT Operating Condition

Same as Item 4.3.6.

4.5.7 Test Results (Mode 1)

Master Mode

For U-NII-1:

802.11a

Chan.	Chan. Freq. (MHz)	PSD W/O Duty Factor (dBm)		Duty Factor (dB)	Total PSD With Duty Factor (dBm)	MAX. Limit (dBm)	Pass / Fail
		Chain 0	Chain 1				
36	5180	7.28	7.83	0.18	10.75	16.39	Pass
40	5200	10.81	11.60	0.18	14.41	16.39	Pass
48	5240	10.20	11.86	0.18	14.30	16.39	Pass

- Note:**
- Method a) of power density measurement of KDB 662911 is using for calculating total power density. Total power density is summing entire spectra across corresponding frequency bins on the various outputs by computer.
 - Directional gain = $3.60\text{dBi} + 10\log(2) = 6.61\text{dBi} > 6\text{dBi}$, so the power density limit shall be reduced to $17 - (6.61 - 6) = 16.39\text{dBm}$.
 - Refer to section 3.3 for duty cycle spectrum plot.

802.11ac (VHT20)

Chan.	Chan. Freq. (MHz)	PSD (dBm/MHz)		Total Power Density (dBm/MHz)	MAX. Limit (dBm/MHz)	Pass / Fail
		Chain 0	Chain 1			
36	5180	6.79	7.84	10.36	16.39	Pass
40	5200	10.09	11.60	13.92	16.39	Pass
48	5240	10.28	11.89	14.17	16.39	Pass

- Note:**
- Method a) of power density measurement of KDB 662911 is using for calculating total power density. Total power density is summing entire spectra across corresponding frequency bins on the various outputs by computer.
 - Directional gain = $3.60\text{dBi} + 10\log(2) = 6.61\text{dBi} > 6\text{dBi}$, so the power density limit shall be reduced to $17 - (6.61 - 6) = 16.39\text{dBm}$.

802.11ac (VHT40)

Chan.	Chan. Freq. (MHz)	PSD W/O Duty Factor (dBm)		Duty Factor (dB)	Total PSD With Duty Factor (dBm)	MAX. Limit (dBm)	Pass / Fail
		Chain 0	Chain 1				
38	5190	3.24	3.76	0.16	6.68	16.39	Pass
46	5230	7.45	8.38	0.16	11.11	16.39	Pass

- Note:**
- Method a) of power density measurement of KDB 662911 is using for calculating total power density. Total power density is summing entire spectra across corresponding frequency bins on the various outputs by computer.
 - Directional gain = $3.60\text{dBi} + 10\log(2) = 6.61\text{dBi} > 6\text{dBi}$, so the power density limit shall be reduced to $17-(6.61-6) = 16.39\text{dBm}$.
 - Refer to section 3.3 for duty cycle spectrum plot.

802.11ac (VHT80)

Chan.	Chan. Freq. (MHz)	PSD W/O Duty Factor (dBm)		Duty Factor (dB)	Total PSD With Duty Factor (dBm)	MAX. Limit (dBm)	Pass / Fail
		Chain 0	Chain 1				
42	5210	-3.07	-1.93	0.29	0.84	16.39	Pass

- Note:**
- Method a) of power density measurement of KDB 662911 is using for calculating total power density. Total power density is summing entire spectra across corresponding frequency bins on the various outputs by computer.
 - Directional gain = $3.60\text{dBi} + 10\log(2) = 6.61\text{dBi} > 6\text{dBi}$, so the power density limit shall be reduced to $17-(6.61-6) = 16.39\text{dBm}$.
 - Refer to section 3.3 for duty cycle spectrum plot.

Spectrum Plot of Worst Value

802.11a_Chain 1 / CH48

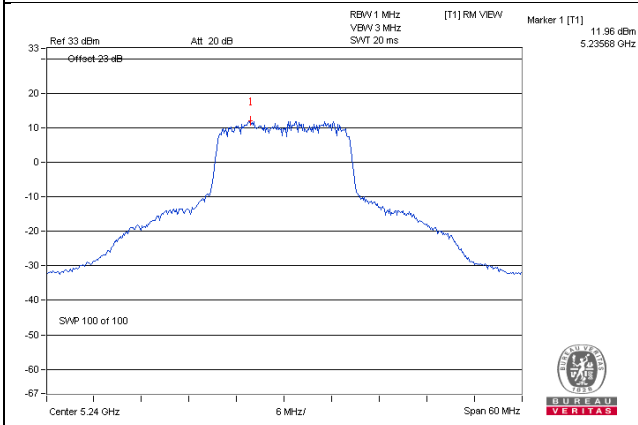

802.11ac (VHT20)_Chain 1 / CH48

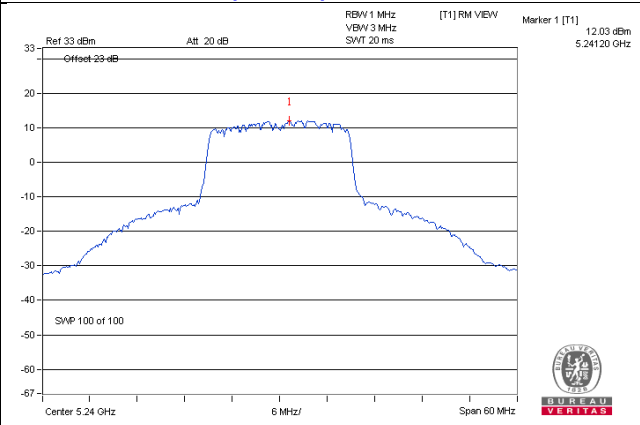

802.11ac (VHT40)_Chain 1 / CH46

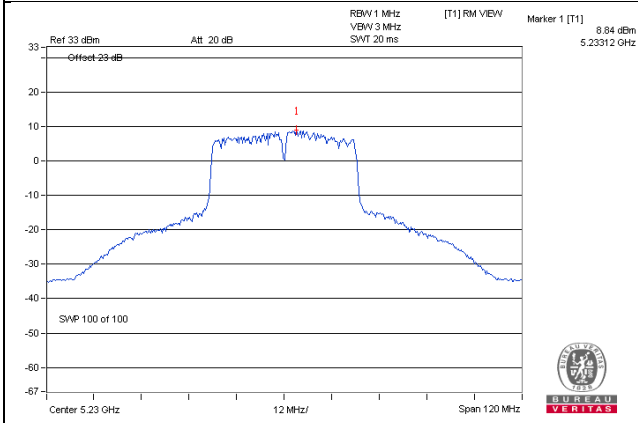

802.11ac (VHT80)_Chain 1 / CH42

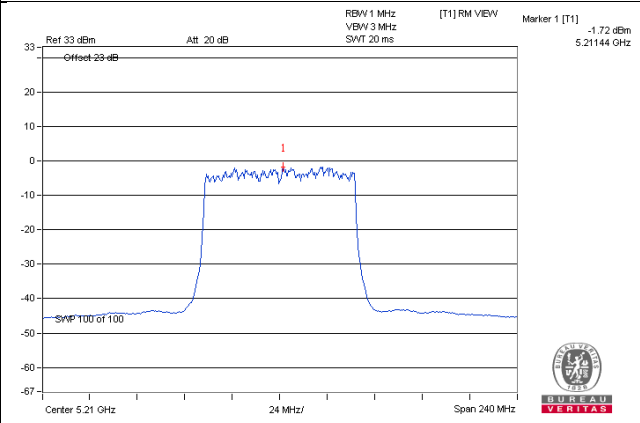

For U-NII-3:
802.11a

TX chain	Chan.	Chan. Freq. (MHz)	PSD W/O Duty Factor		10 log (N=2) dB	Duty Factor (dB)	Total PSD With Duty Factor (dBm/500kHz)	Limit (dBm/500kHz)	Pass /Fail
			(dBm/300kHz)	(dBm/500kHz)					
0	149	5745	3.15	5.37	3.01	0.18	8.56	29.39	Pass
	157	5785	3.44	5.66	3.01	0.18	8.85	29.39	Pass
	165	5825	3.34	5.56	3.01	0.18	8.75	29.39	Pass
1	149	5745	6.11	8.33	3.01	0.18	11.52	29.39	Pass
	157	5785	5.37	7.59	3.01	0.18	10.78	29.39	Pass
	165	5825	5.62	7.84	3.01	0.18	11.03	29.39	Pass

Note: 1. Directional gain = $3.60\text{dBi} + 10\log(2) = 6.61\text{dBi} > 6\text{dBi}$, so the power density limit shall be reduced to $30-(6.61-6) = 29.39\text{dBm}$.

2. Refer to section 3.3 for duty cycle spectrum plot.

802.11ac (VHT20)

TX chain	Channel	Freq. (MHz)	PSD (dBm/300kHz)	PSD (dBm/500kHz)	10 log (N=2) dB	Total PSD (dBm/500kHz)	Limit (dBm/500kHz)	Pass /Fail
0	149	5745	2.73	4.95	3.01	7.96	29.39	Pass
	157	5785	2.62	4.84	3.01	7.85	29.39	Pass
	165	5825	2.85	5.07	3.01	8.08	29.39	Pass
1	149	5745	6.00	8.22	3.01	11.23	29.39	Pass
	157	5785	5.56	7.78	3.01	10.79	29.39	Pass
	165	5825	5.89	8.11	3.01	11.12	29.39	Pass

Note: 1. Directional gain = $3.60\text{dBi} + 10\log(2) = 6.61\text{dBi} > 6\text{dBi}$, so the power density limit shall be reduced to $30-(6.61-6) = 29.39\text{dBm}$.

802.11ac (VHT40)

TX chain	Chan.	Chan. Freq. (MHz)	PSD W/O Duty Factor		10 log (N=2) dB	Duty Factor (dB)	Total PSD With Duty Factor (dBm/500kHz)	Limit (dBm/500kHz)	Pass /Fail
			(dBm/300kHz)	(dBm/500kHz)					
0	151	5755	-0.67	1.55	3.01	0.16	4.72	29.39	Pass
	159	5795	-1.11	1.11	3.01	0.16	4.28	29.39	Pass
1	151	5755	2.75	4.97	3.01	0.16	8.14	29.39	Pass
	159	5795	2.47	4.69	3.01	0.16	7.86	29.39	Pass

Note: 1. Directional gain = $3.60\text{dBi} + 10\log(2) = 6.61\text{dBi} > 6\text{dBi}$, so the power density limit shall be reduced to $30-(6.61-6) = 29.39\text{dBm}$.

2. Refer to section 3.3 for duty cycle spectrum plot.

802.11ac (VHT80)

TX chain	Chan.	Chan. Freq. (MHz)	PSD W/O Duty Factor		10 log (N=2) dB	Duty Factor (dB)	Total PSD With Duty Factor (dBm/500kHz)	Limit (dBm/500kHz)	Pass /Fail
			(dBm/300kHz)	(dBm/500kHz)					
0	155	5775	-7.03	-4.81	3.01	0.29	-1.51	29.39	Pass
1	155	5775	-4.57	-2.35	3.01	0.29	0.95	29.39	Pass

Note: 1. Directional gain = $3.60\text{dBi} + 10\log(2) = 6.61\text{dBi} > 6\text{dBi}$, so the power density limit shall be reduced to $30-(6.61-6) = 29.39\text{dBm}$.

2. Refer to section 3.3 for duty cycle spectrum plot.

Spectrum Plot of Worst Value

802.11a – Chain 1: CH 149

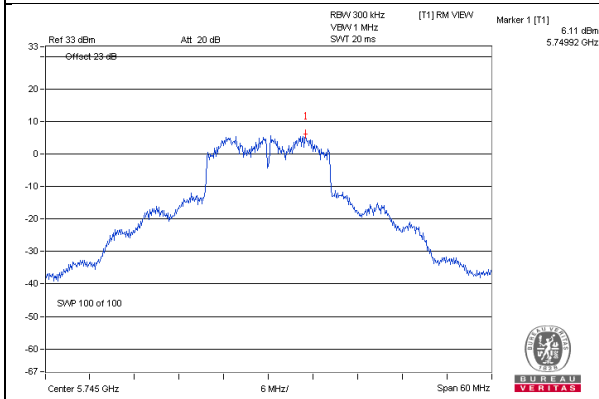

802.11ac (VHT20) – Chain 1: CH 149

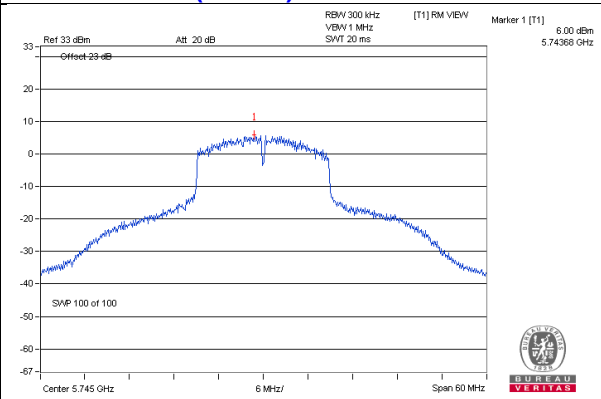

802.11ac (VHT40) – Chain 1: CH 151

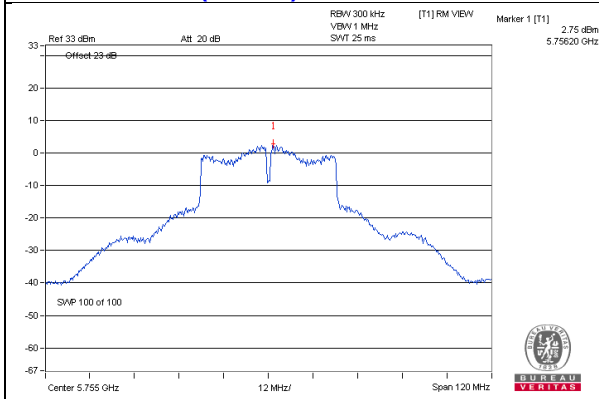

802.11ac (VHT80) – Chain 1: CH 155

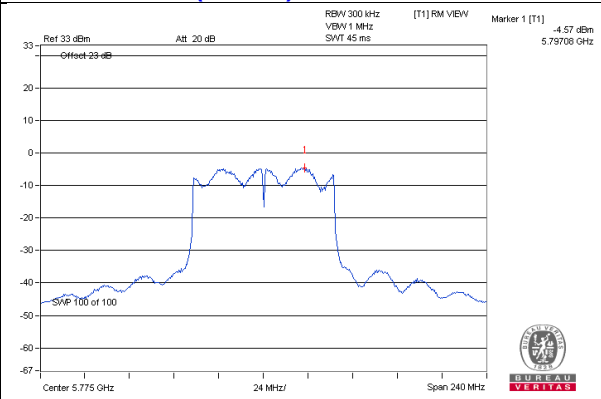

Client Mode

For U-NII-1:

802.11a

Chan.	Chan. Freq. (MHz)	PSD W/O Duty Factor (dBm)		Duty Factor (dB)	Total PSD With Duty Factor (dBm)	MAX. Limit (dBm)	Pass / Fail
		Chain 0	Chain 1				
36	5180	5.67	6.79	0.18	9.45	10.39	Pass
40	5200	5.95	7.03	0.18	9.71	10.39	Pass
48	5240	6.47	7.37	0.18	10.13	10.39	Pass

- Note:**
- Method a) of power density measurement of KDB 662911 is using for calculating total power density. Total power density is summing entire spectra across corresponding frequency bins on the various outputs by computer.
 - Directional gain = $3.60\text{dBi} + 10\log(2) = 6.61\text{dBi} > 6\text{dBi}$, so the power density limit shall be reduced to $11-(6.61-6) = 10.39\text{dBm}$.
 - Refer to section 3.3 for duty cycle spectrum plot.

802.11ac (VHT20)

Chan.	Chan. Freq. (MHz)	PSD (dBm/MHz)		Total Power Density (dBm/MHz)	MAX. Limit (dBm/MHz)	Pass / Fail
		Chain 0	Chain 1			
36	5180	5.81	6.93	9.42	10.39	Pass
40	5200	6.02	7.30	9.72	10.39	Pass
48	5240	6.25	7.85	10.13	10.39	Pass

- Note:**
- Method a) of power density measurement of KDB 662911 is using for calculating total power density. Total power density is summing entire spectra across corresponding frequency bins on the various outputs by computer.
 - Directional gain = $3.60\text{dBi} + 10\log(2) = 6.61\text{dBi} > 6\text{dBi}$, so the power density limit shall be reduced to $11-(6.61-6) = 10.39\text{dBm}$.

802.11ac (VHT40)

Chan.	Chan. Freq. (MHz)	PSD W/O Duty Factor (dBm)		Duty Factor (dB)	Total PSD With Duty Factor (dBm)	MAX. Limit (dBm)	Pass / Fail
		Chain 0	Chain 1				
38	5190	3.30	3.77	0.16	6.71	10.39	Pass
46	5230	3.58	4.58	0.16	7.28	10.39	Pass

- Note:**
- Method a) of power density measurement of KDB 662911 is using for calculating total power density. Total power density is summing entire spectra across corresponding frequency bins on the various outputs by computer.
 - Directional gain = $3.60\text{dBi} + 10\log(2) = 6.61\text{dBi} > 6\text{dBi}$, so the power density limit shall be reduced to $11-(6.61-6) = 10.39\text{dBm}$.
 - Refer to section 3.3 for duty cycle spectrum plot.

802.11ac (VHT80)

Chan.	Chan. Freq. (MHz)	PSD W/O Duty Factor (dBm)		Duty Factor (dB)	Total PSD With Duty Factor (dBm)	MAX. Limit (dBm)	Pass / Fail
		Chain 0	Chain 1				
42	5210	-1.60	-2.07	0.29	1.47	10.39	Pass

- Note:**
- Method a) of power density measurement of KDB 662911 is using for calculating total power density. Total power density is summing entire spectra across corresponding frequency bins on the various outputs by computer.
 - Directional gain = $3.60\text{dBi} + 10\log(2) = 6.61\text{dBi} > 6\text{dBi}$, so the power density limit shall be reduced to $11-(6.61-6) = 10.39\text{dBm}$.
 - Refer to section 3.3 for duty cycle spectrum plot.

Spectrum Plot of Worst Value

802.11a_Chain 1 / CH48

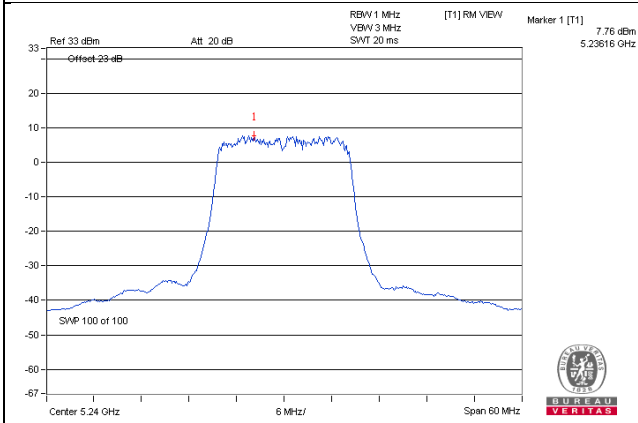

802.11ac (VHT20)_Chain 1 / CH48

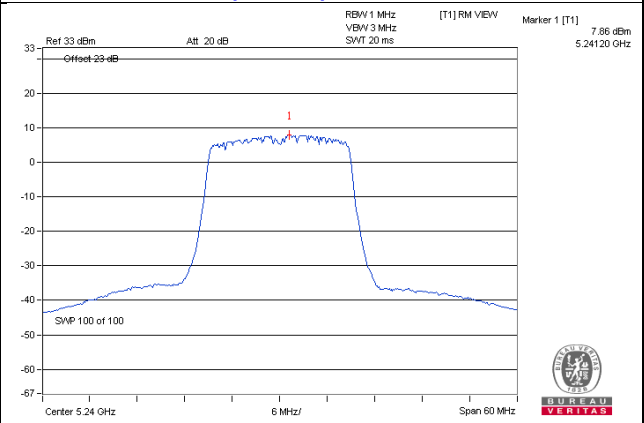

802.11ac (VHT40)_Chain 1 / CH46

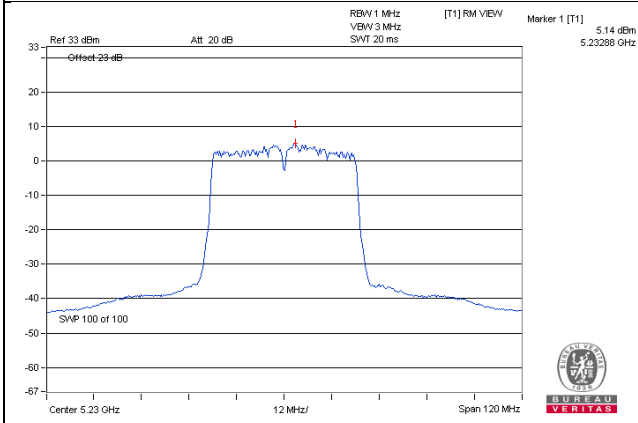

802.11ac (VHT80)_Chain 0 / CH42

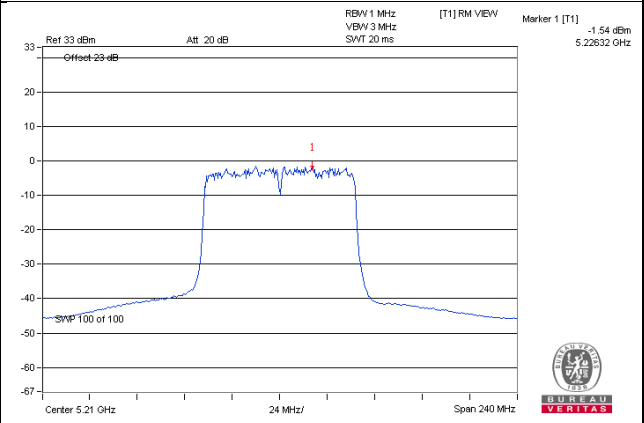

For U-NII-3:

802.11a

TX chain	Chan.	Chan. Freq. (MHz)	PSD W/O Duty Factor		10 log (N=2) dB	Duty Factor (dB)	Total PSD With Duty Factor (dBm/500kHz)	Limit (dBm/500kHz)	Pass /Fail
			(dBm/300kHz)	(dBm/500kHz)					
0	149	5745	3.15	5.37	3.01	0.18	8.56	29.39	Pass
	157	5785	3.44	5.66	3.01	0.18	8.85	29.39	Pass
	165	5825	3.34	5.56	3.01	0.18	8.75	29.39	Pass
1	149	5745	6.11	8.33	3.01	0.18	11.52	29.39	Pass
	157	5785	5.37	7.59	3.01	0.18	10.78	29.39	Pass
	165	5825	5.62	7.84	3.01	0.18	11.03	29.39	Pass

Note: 1. Directional gain = $3.60\text{dBi} + 10\log(2) = 6.61\text{dBi} > 6\text{dBi}$, so the power density limit shall be reduced to $30-(6.61-6) = 29.39\text{dBm}$.

2. Refer to section 3.3 for duty cycle spectrum plot.

802.11ac (VHT20)

TX chain	Channel	Freq. (MHz)	PSD (dBm/300kHz)	PSD (dBm/500kHz)	10 log (N=2) dB	Total PSD (dBm/500kHz)	Limit (dBm/500kHz)	Pass /Fail
0	149	5745	2.73	4.95	3.01	7.96	29.39	Pass
	157	5785	2.62	4.84	3.01	7.85	29.39	Pass
	165	5825	2.85	5.07	3.01	8.08	29.39	Pass
1	149	5745	6.00	8.22	3.01	11.23	29.39	Pass
	157	5785	5.56	7.78	3.01	10.79	29.39	Pass
	165	5825	5.89	8.11	3.01	11.12	29.39	Pass

Note: 1. Directional gain = $3.60\text{dBi} + 10\log(2) = 6.61\text{dBi} > 6\text{dBi}$, so the power density limit shall be reduced to $30-(6.61-6) = 29.39\text{dBm}$.

802.11ac (VHT40)

TX chain	Chan.	Chan. Freq. (MHz)	PSD W/O Duty Factor		10 log (N=2) dB	Duty Factor (dB)	Total PSD With Duty Factor (dBm/500kHz)	Limit (dBm/500kHz)	Pass /Fail
			(dBm/300kHz)	(dBm/500kHz)					
0	151	5755	-0.67	1.55	3.01	0.16	4.72	29.39	Pass
	159	5795	-1.11	1.11	3.01	0.16	4.28	29.39	Pass
1	151	5755	2.75	4.97	3.01	0.16	8.14	29.39	Pass
	159	5795	2.47	4.69	3.01	0.16	7.86	29.39	Pass

Note: 1. Directional gain = $3.60\text{dBi} + 10\log(2) = 6.61\text{dBi} > 6\text{dBi}$, so the power density limit shall be reduced to $30-(6.61-6) = 29.39\text{dBm}$.

2. Refer to section 3.3 for duty cycle spectrum plot.

802.11ac (VHT80)

TX chain	Chan.	Chan. Freq. (MHz)	PSD W/O Duty Factor		10 log (N=2) dB	Duty Factor (dB)	Total PSD With Duty Factor (dBm/500kHz)	Limit (dBm/500kHz)	Pass /Fail
			(dBm/300kHz)	(dBm/500kHz)					
0	155	5775	-7.03	-4.81	3.01	0.29	-1.51	29.39	Pass
1	155	5775	-4.57	-2.35	3.01	0.29	0.95	29.39	Pass

Note: 1. Directional gain = $3.60\text{dBi} + 10\log(2) = 6.61\text{dBi} > 6\text{dBi}$, so the power density limit shall be reduced to $30-(6.61-6) = 29.39\text{dBm}$.

2. Refer to section 3.3 for duty cycle spectrum plot.

Spectrum Plot of Worst Value

802.11a – Chain 1: CH 149

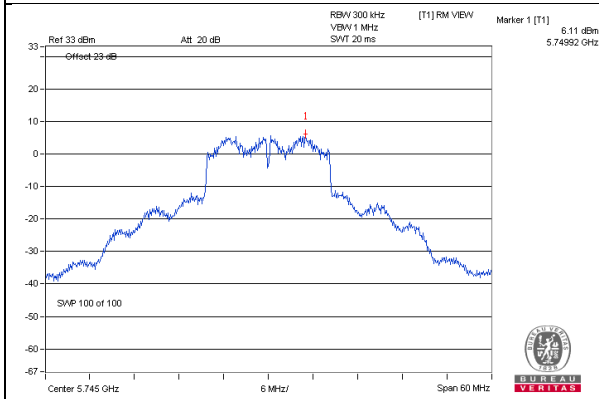

802.11ac (VHT20) – Chain 1: CH 149

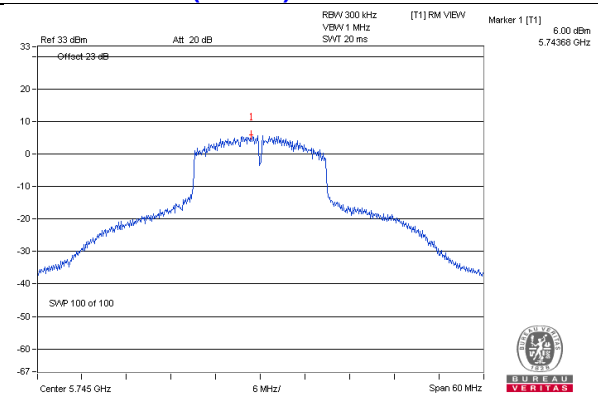

802.11ac (VHT40) – Chain 1: CH 151

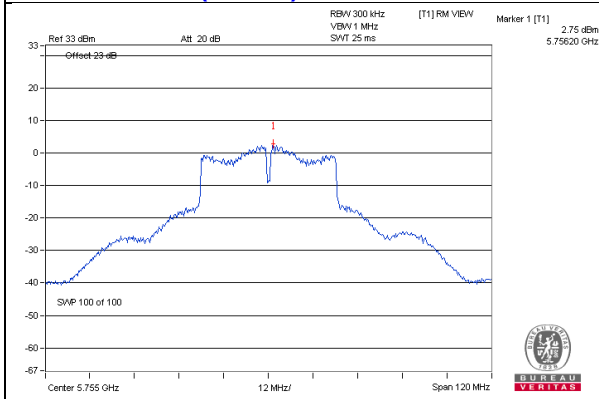

802.11ac (VHT80) – Chain 1: CH 155

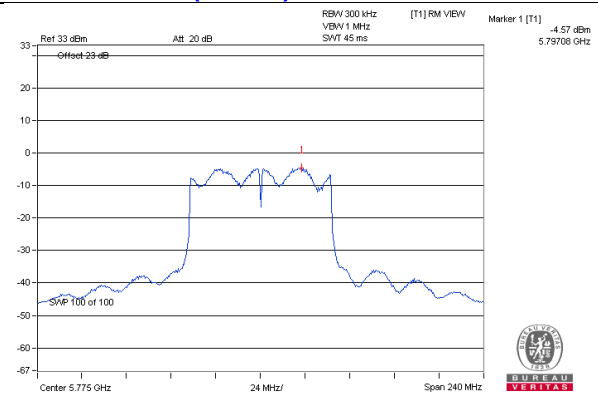

4.5.8 Test Results (Mode 3)

Master Mode

For U-NII-1:

802.11a

Chan.	Chan. Freq. (MHz)	PSD W/O Duty Factor (dBm)				Duty Factor (dB)	Total PSD With Duty Factor (dBm)	MAX. Limit (dBm/MHz)	Pass / Fail
		Chain 0	Chain 1	Chain 2	Chain 3				
36	5180	6.67	5.99	5.98	6.34	0.18	12.45	13.38	Pass
40	5200	6.89	6.61	6.01	6.57	0.18	12.73	13.38	Pass
48	5240	6.61	6.78	6.21	6.50	0.18	12.73	13.38	Pass

- Note:**
- Method a) of power density measurement of KDB 662911 is using for calculating total power density. Total power density is summing entire spectra across corresponding frequency bins on the various outputs by computer.
 - Directional gain = $3.60\text{dBi} + 10\log(4) = 9.62\text{dBi} > 6\text{dBi}$, so the power density limit shall be reduced to $17 - (9.62 - 6) = 13.38\text{dBm}$.
 - Refer to section 3.3 for duty cycle spectrum plot.

802.11ac (VHT20)

Chan.	Chan. Freq. (MHz)	PSD (dBm/MHz)				Total Power Density (dBm/MHz)	MAX. Limit (dBm/MHz)	Pass / Fail
		Chain 0	Chain 1	Chain 2	Chain 3			
36	5180	6.07	6.10	5.99	5.96	12.05	13.38	Pass
40	5200	6.26	6.42	6.50	6.08	12.34	13.38	Pass
48	5240	6.56	5.74	5.77	6.21	12.10	13.38	Pass

- Note:**
- Method a) of power density measurement of KDB 662911 is using for calculating total power density. Total power density is summing entire spectra across corresponding frequency bins on the various outputs by computer.
 - Directional gain = $3.60\text{dBi} + 10\log(4) = 9.62\text{dBi} > 6\text{dBi}$, so the power density limit shall be reduced to $17 - (9.62 - 6) = 13.38\text{dBm}$.

802.11ac (VHT40)

Chan.	Chan. Freq. (MHz)	PSD W/O Duty Factor (dBm)				Duty Factor (dB)	Total PSD With Duty Factor (dBm)	MAX. Limit (dBm/MHz)	Pass / Fail
		Chain 0	Chain 1	Chain 2	Chain 3				
38	5190	2.30	1.98	2.27	2.06	0.16	8.33	13.38	Pass
46	5230	6.87	6.32	5.72	5.98	0.16	12.42	13.38	Pass

- Note:**
- Method a) of power density measurement of KDB 662911 is using for calculating total power density. Total power density is summing entire spectra across corresponding frequency bins on the various outputs by computer.
 - Directional gain = $3.60\text{dBi} + 10\log(4) = 9.62\text{dBi} > 6\text{dBi}$, so the power density limit shall be reduced to $17 - (9.62 - 6) = 13.38\text{dBm}$.
 - Refer to section 3.3 for duty cycle spectrum plot.

802.11ac (VHT80)

Chan.	Chan. Freq. (MHz)	PSD W/O Duty Factor (dBm)				Duty Factor (dB)	Total PSD With Duty Factor (dBm)	MAX. Limit (dBm/MHz)	Pass / Fail
		Chain 0	Chain 1	Chain 2	Chain 3				
42	5210	-3.32	-3.76	-3.30	-4.11	0.29	2.70	13.38	Pass

- Note:**
- Method a) of power density measurement of KDB 662911 is using for calculating total power density. Total power density is summing entire spectra across corresponding frequency bins on the various outputs by computer.
 - Directional gain = $3.60\text{dBi} + 10\log(4) = 9.62\text{dBi} > 6\text{dBi}$, so the power density limit shall be reduced to $17-(9.62-6) = 13.38\text{dBm}$.
 - Refer to section 3.3 for duty cycle spectrum plot.

Spectrum Plot of Worst Value

802.11a / Chain 0 : CH40

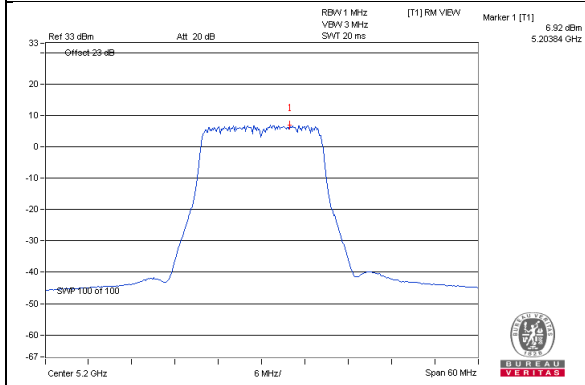

802.11a (VHT20) / Chain 0 : CH48

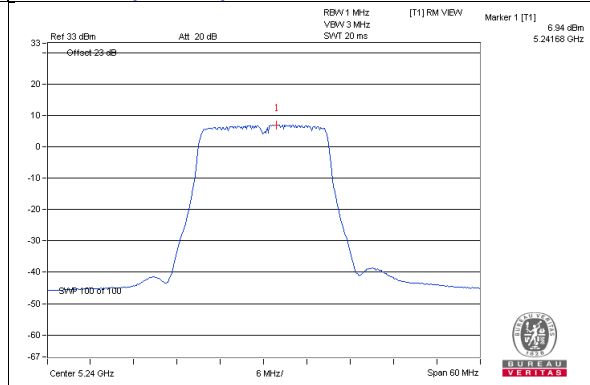

802.11ac (VHT40) / Chain 0: CH46

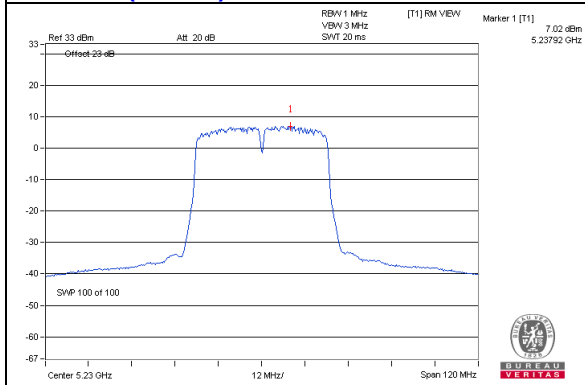

802.11ac (VHT80) / Chain 2 : CH42

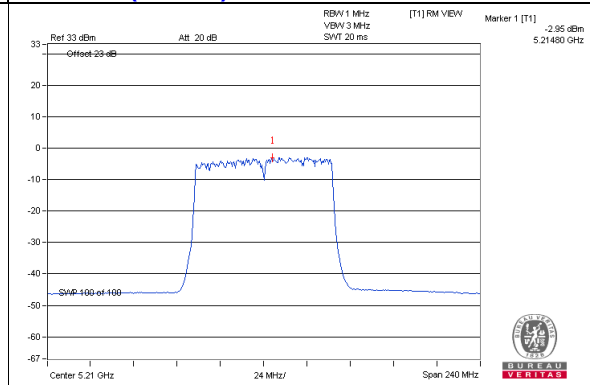

For U-NII-3:

802.11a

TX chain	Chan.	Chan. Freq. (MHz)	PSD W/O Duty Factor		10 log (N=4) dB	Duty Factor (dB)	Total PSD With Duty Factor (dBm/500kHz)	Limit (dBm/500kHz)	Pass /Fail
			(dBm/300kHz)	(dBm/500kHz)					
0	149	5745	1.58	3.80	6.02	0.18	10.00	26.38	Pass
	157	5785	1.72	3.94	6.02	0.18	10.14	26.38	Pass
	165	5825	1.55	3.77	6.02	0.18	9.97	26.38	Pass
1	149	5745	2.00	4.22	6.02	0.18	10.42	26.38	Pass
	157	5785	1.14	3.36	6.02	0.18	9.56	26.38	Pass
	165	5825	1.23	3.45	6.02	0.18	9.65	26.38	Pass
2	149	5745	0.94	3.16	6.02	0.18	9.36	26.38	Pass
	157	5785	1.32	3.54	6.02	0.18	9.74	26.38	Pass
	165	5825	1.13	3.35	6.02	0.18	9.55	26.38	Pass
3	149	5745	0.23	2.45	6.02	0.18	8.65	26.38	Pass
	157	5785	1.76	3.98	6.02	0.18	10.18	26.38	Pass
	165	5825	1.41	3.63	6.02	0.18	9.83	26.38	Pass

Note: 1. Directional gain = $3.60\text{dBi} + 10\log(4) = 9.62\text{dBi} > 6\text{dBi}$, so the power density limit shall be reduced to $30 - (9.62 - 6) = 26.38\text{dBm}$.

2. Refer to section 3.3 for duty cycle spectrum plot.

802.11ac (VHT20)

TX chain	Channel	Freq. (MHz)	PSD (dBm/300kHz)	PSD (dBm/500kHz)	10 log (N=4) dB	Total PSD (dBm/500kHz)	Limit (dBm/500kHz)	Pass /Fail
0	149	5745	1.24	3.46	6.02	9.48	26.38	Pass
	157	5785	0.84	3.06	6.02	9.08	26.38	Pass
	165	5825	0.65	2.87	6.02	8.89	26.38	Pass
1	149	5745	1.45	3.67	6.02	9.69	26.38	Pass
	157	5785	1.44	3.66	6.02	9.68	26.38	Pass
	165	5825	0.94	3.16	6.02	9.18	26.38	Pass
2	149	5745	0.76	2.98	6.02	9.00	26.38	Pass
	157	5785	1.06	3.28	6.02	9.30	26.38	Pass
	165	5825	1.40	3.62	6.02	9.64	26.38	Pass
3	149	5745	2.36	4.58	6.02	10.60	26.38	Pass
	157	5785	2.61	4.83	6.02	10.85	26.38	Pass
	165	5825	2.64	4.86	6.02	10.88	26.38	Pass

Note: 1. Directional gain = $3.60\text{dBi} + 10\log(4) = 9.62\text{dBi} > 6\text{dBi}$, so the power density limit shall be reduced to $30 - (9.62 - 6) = 26.38\text{dBm}$.

802.11ac (VHT40)

TX chain	Chan.	Chan. Freq. (MHz)	PSD W/O Duty Factor		10 log (N=4) dB	Duty Factor (dB)	Total PSD With Duty Factor (dBm/500kHz)	Limit (dBm/500kHz)	Pass /Fail
			(dBm/300kHz)	(dBm/500kHz)					
0	151	5755	-1.33	0.89	6.02	0.16	7.07	26.38	Pass
	159	5795	-1.53	0.69	6.02	0.16	6.87	26.38	Pass
1	151	5755	-1.07	1.15	6.02	0.16	7.33	26.38	Pass
	159	5795	-1.36	0.86	6.02	0.16	7.04	26.38	Pass
2	151	5755	-1.78	0.44	6.02	0.16	6.62	26.38	Pass
	159	5795	-2.17	0.05	6.02	0.16	6.23	26.38	Pass
3	151	5755	-1.61	0.61	6.02	0.16	6.79	26.38	Pass
	159	5795	-1.04	1.18	6.02	0.16	7.36	26.38	Pass

Note: 1. Directional gain = $3.60\text{dBi} + 10\log(4) = 9.62\text{dBi} > 6\text{dBi}$, so the power density limit shall be reduced to $30 - (9.62 - 6) = 26.38\text{dBm}$.

2. Refer to section 3.3 for duty cycle spectrum plot.

802.11ac (VHT80)

TX chain	Chan.	Chan. Freq. (MHz)	PSD W/O Duty Factor		10 log (N=4) dB	Duty Factor (dB)	Total PSD With Duty Factor (dBm/500kHz)	Limit (dBm/500kHz)	Pass /Fail
			(dBm/300kHz)	(dBm/500kHz)					
0	155	5775	-7.96	-5.74	6.02	0.29	0.57	26.38	Pass
1	155	5775	-7.75	-5.53	6.02	0.29	0.78	26.38	Pass
2	155	5775	-8.59	-6.37	6.02	0.29	-0.06	26.38	Pass
3	155	5775	-8.72	-6.50	6.02	0.29	-0.19	26.38	Pass

Note: 1. Directional gain = $3.60\text{dBi} + 10\log(4) = 9.62\text{dBi} > 6\text{dBi}$, so the power density limit shall be reduced to $30 - (9.62 - 6) = 26.38\text{dBm}$.

2. Refer to section 3.3 for duty cycle spectrum plot.

Spectrum Plot of Worst Value

802.11a / Chain 1 : CH149

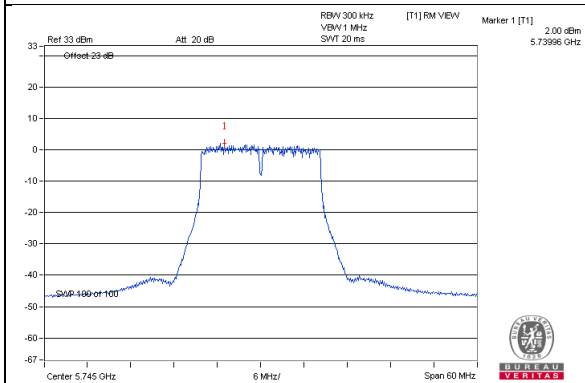

802.11ac (VHT20) / Chain 3 : CH165

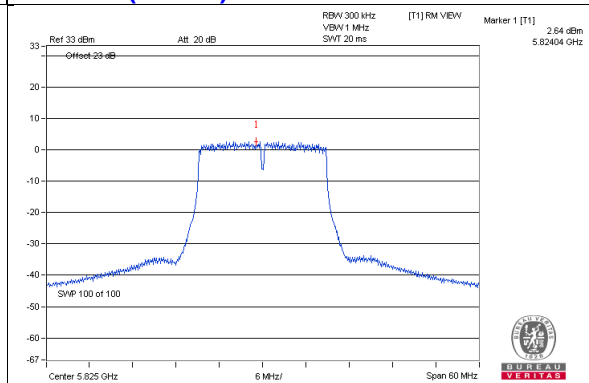

802.11ac (VHT40) / Chain 3: CH159

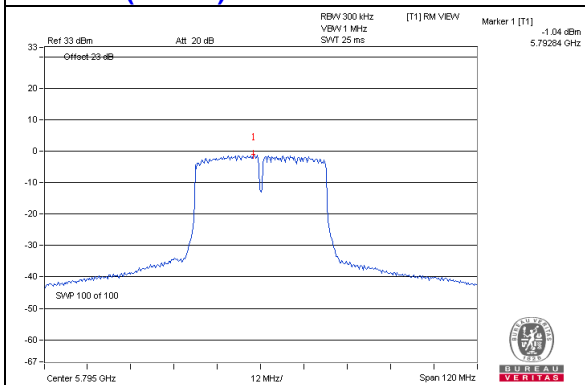

802.11ac (VHT80) / Chain 1 : CH155

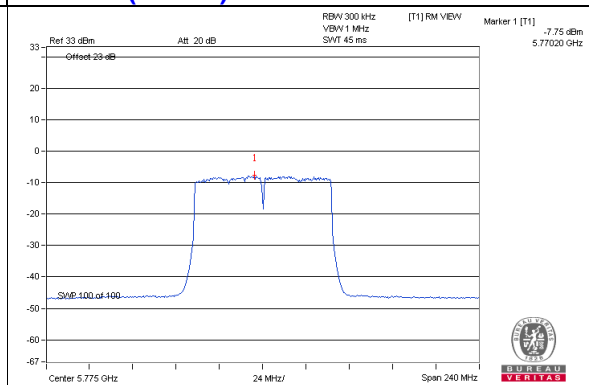

Client Mode

For U-NII-1:

802.11a

Chan.	Chan. Freq. (MHz)	PSD W/O Duty Factor (dBm)				Duty Factor (dB)	Total PSD With Duty Factor (dBm)	MAX. Limit (dBm/MHz)	Pass / Fail
		Chain 0	Chain 1	Chain 2	Chain 3				
36	5180	0.87	0.86	-0.64	0.31	0.18	6.59	7.38	Pass
40	5200	0.90	0.73	-0.53	0.55	0.18	6.64	7.38	Pass
48	5240	0.59	0.83	0.01	0.55	0.18	6.70	7.38	Pass

- Note:**
- Method a) of power density measurement of KDB 662911 is using for calculating total power density. Total power density is summing entire spectra across corresponding frequency bins on the various outputs by computer.
 - Directional gain = $3.60\text{dBi} + 10\log(4) = 9.62\text{dBi} > 6\text{dBi}$, so the power density limit shall be reduced to $11 - (9.62 - 6) = 7.38\text{dBm}$.
 - Refer to section 3.3 for duty cycle spectrum plot.

802.11ac (VHT20)

Chan.	Chan. Freq. (MHz)	PSD (dBm/MHz)				Total Power Density (dBm/MHz)	MAX. Limit (dBm/MHz)	Pass / Fail
		Chain 0	Chain 1	Chain 2	Chain 3			
36	5180	0.24	0.10	0.10	-0.16	6.09	7.38	Pass
40	5200	0.28	0.27	0.71	-0.21	6.30	7.38	Pass
48	5240	0.49	-0.06	0.13	0.51	6.29	7.38	Pass

- Note:**
- Method a) of power density measurement of KDB 662911 is using for calculating total power density. Total power density is summing entire spectra across corresponding frequency bins on the various outputs by computer.
 - Directional gain = $3.60\text{dBi} + 10\log(4) = 9.62\text{dBi} > 6\text{dBi}$, so the power density limit shall be reduced to $11 - (9.62 - 6) = 7.38\text{dBm}$.

802.11ac (VHT40)

Chan.	Chan. Freq. (MHz)	PSD W/O Duty Factor (dBm)				Duty Factor (dB)	Total PSD With Duty Factor (dBm)	MAX. Limit (dBm/MHz)	Pass / Fail
		Chain 0	Chain 1	Chain 2	Chain 3				
38	5190	0.87	-0.04	0.83	0.89	0.16	6.83	7.38	Pass
46	5230	1.07	0.03	0.18	-0.06	0.16	6.51	7.38	Pass

- Note:**
- Method a) of power density measurement of KDB 662911 is using for calculating total power density. Total power density is summing entire spectra across corresponding frequency bins on the various outputs by computer.
 - Directional gain = $3.60\text{dBi} + 10\log(4) = 9.62\text{dBi} > 6\text{dBi}$, so the power density limit shall be reduced to $11 - (9.62 - 6) = 7.38\text{dBm}$.
 - Refer to section 3.3 for duty cycle spectrum plot.

802.11ac (VHT80)

Chan.	Chan. Freq. (MHz)	PSD W/O Duty Factor (dBm)				Duty Factor (dB)	Total PSD With Duty Factor (dBm)	MAX. Limit (dBm/MHz)	Pass / Fail
		Chain 0	Chain 1	Chain 2	Chain 3				
42	5210	-3.32	-3.76	-3.30	-4.11	0.29	2.70	7.38	Pass

- Note:**
1. Method a) of power density measurement of KDB 662911 is using for calculating total power density. Total power density is summing entire spectra across corresponding frequency bins on the various outputs by computer.
 2. Directional gain = $3.60\text{dBi} + 10\log(4) = 9.62\text{dBi} > 6\text{dBi}$, so the power density limit shall be reduced to $11 - (9.62 - 6) = 7.38\text{dBm}$.
 3. Refer to section 3.3 for duty cycle spectrum plot.

Spectrum Plot of Worst Value

802.11a / Chain 0 : CH40

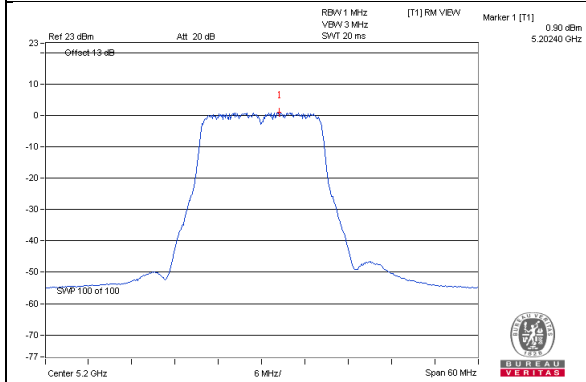

802.11ac (VHT20) / Chain 2 : CH40

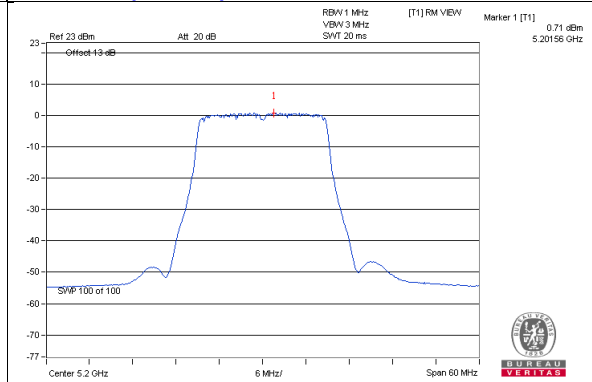

802.11ac (VHT40) / Chain 0: CH46

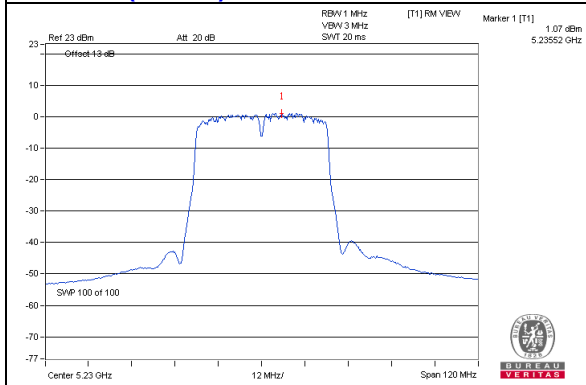

802.11ac (VHT80) / Chain 2 : CH42

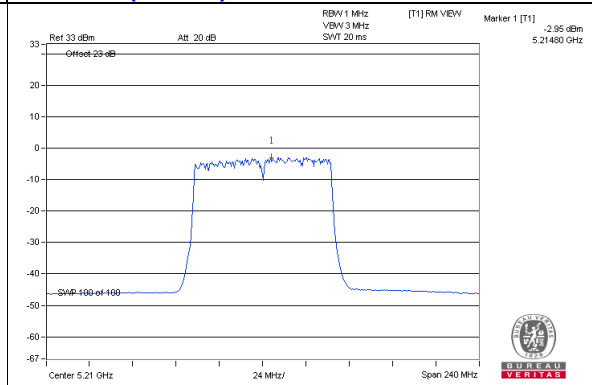

For U-NII-3:

802.11a

TX chain	Chan.	Chan. Freq. (MHz)	PSD W/O Duty Factor		10 log (N=4) dB	Duty Factor (dB)	Total PSD With Duty Factor (dBm/500kHz)	Limit (dBm/500kHz)	Pass /Fail
			(dBm/300kHz)	(dBm/500kHz)					
0	149	5745	1.58	3.80	6.02	0.18	10.00	26.38	Pass
	157	5785	1.72	3.94	6.02	0.18	10.14	26.38	Pass
	165	5825	1.55	3.77	6.02	0.18	9.97	26.38	Pass
1	149	5745	2.00	4.22	6.02	0.18	10.42	26.38	Pass
	157	5785	1.14	3.36	6.02	0.18	9.56	26.38	Pass
	165	5825	1.23	3.45	6.02	0.18	9.65	26.38	Pass
2	149	5745	0.94	3.16	6.02	0.18	9.36	26.38	Pass
	157	5785	1.32	3.54	6.02	0.18	9.74	26.38	Pass
	165	5825	1.13	3.35	6.02	0.18	9.55	26.38	Pass
3	149	5745	0.23	2.45	6.02	0.18	8.65	26.38	Pass
	157	5785	1.76	3.98	6.02	0.18	10.18	26.38	Pass
	165	5825	1.41	3.63	6.02	0.18	9.83	26.38	Pass

Note: 1. Directional gain = $3.60\text{dBi} + 10\log(4) = 9.62\text{dBi} > 6\text{dBi}$, so the power density limit shall be reduced to $30 - (9.62 - 6) = 26.38\text{dBm}$.

2. Refer to section 3.3 for duty cycle spectrum plot.

802.11ac (VHT20)

TX chain	Channel	Freq. (MHz)	PSD (dBm/300kHz)	PSD (dBm/500kHz)	10 log (N=4) dB	Total PSD (dBm/500kHz)	Limit (dBm/500kHz)	Pass /Fail
0	149	5745	1.24	3.46	6.02	9.48	26.38	Pass
	157	5785	0.84	3.06	6.02	9.08	26.38	Pass
	165	5825	0.65	2.87	6.02	8.89	26.38	Pass
1	149	5745	1.45	3.67	6.02	9.69	26.38	Pass
	157	5785	1.44	3.66	6.02	9.68	26.38	Pass
	165	5825	0.94	3.16	6.02	9.18	26.38	Pass
2	149	5745	0.76	2.98	6.02	9.00	26.38	Pass
	157	5785	1.06	3.28	6.02	9.30	26.38	Pass
	165	5825	1.40	3.62	6.02	9.64	26.38	Pass
3	149	5745	2.36	4.58	6.02	10.60	26.38	Pass
	157	5785	2.61	4.83	6.02	10.85	26.38	Pass
	165	5825	2.64	4.86	6.02	10.88	26.38	Pass

Note: 1. Directional gain = $3.60\text{dBi} + 10\log(4) = 9.62\text{dBi} > 6\text{dBi}$, so the power density limit shall be reduced to $30 - (9.62 - 6) = 26.38\text{dBm}$.

802.11ac (VHT40)

TX chain	Chan.	Chan. Freq. (MHz)	PSD W/O Duty Factor		10 log (N=4) dB	Duty Factor (dB)	Total PSD With Duty Factor (dBm/500kHz)	Limit (dBm/500kHz)	Pass /Fail
			(dBm/300kHz)	(dBm/500kHz)					
0	151	5755	-1.33	0.89	6.02	0.16	7.07	26.38	Pass
	159	5795	-1.53	0.69	6.02	0.16	6.87	26.38	Pass
1	151	5755	-1.07	1.15	6.02	0.16	7.33	26.38	Pass
	159	5795	-1.36	0.86	6.02	0.16	7.04	26.38	Pass
2	151	5755	-1.78	0.44	6.02	0.16	6.62	26.38	Pass
	159	5795	-2.17	0.05	6.02	0.16	6.23	26.38	Pass
3	151	5755	-1.61	0.61	6.02	0.16	6.79	26.38	Pass
	159	5795	-1.04	1.18	6.02	0.16	7.36	26.38	Pass

Note: 1. Directional gain = $3.60\text{dBi} + 10\log(4) = 9.62\text{dBi} > 6\text{dBi}$, so the power density limit shall be reduced to $30 - (9.62 - 6) = 26.38\text{dBm}$.

2. Refer to section 3.3 for duty cycle spectrum plot.

802.11ac (VHT80)

TX chain	Chan.	Chan. Freq. (MHz)	PSD W/O Duty Factor		10 log (N=4) dB	Duty Factor (dB)	Total PSD With Duty Factor (dBm/500kHz)	Limit (dBm/500kHz)	Pass /Fail
			(dBm/300kHz)	(dBm/500kHz)					
0	155	5775	-7.96	-5.74	6.02	0.29	0.57	26.38	Pass
1	155	5775	-7.75	-5.53	6.02	0.29	0.78	26.38	Pass
2	155	5775	-8.59	-6.37	6.02	0.29	-0.06	26.38	Pass
3	155	5775	-8.72	-6.50	6.02	0.29	-0.19	26.38	Pass

Note: 1. Directional gain = $3.60\text{dBi} + 10\log(4) = 9.62\text{dBi} > 6\text{dBi}$, so the power density limit shall be reduced to $30 - (9.62 - 6) = 26.38\text{dBm}$.

2. Refer to section 3.3 for duty cycle spectrum plot.

Spectrum Plot of Worst Value

802.11a / Chain 1 : CH149

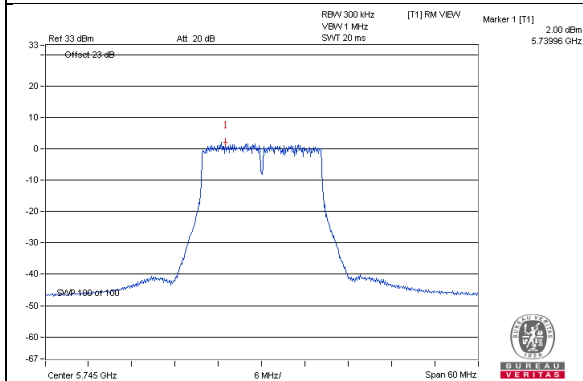

802.11ac (VHT20) / Chain 3 : CH165

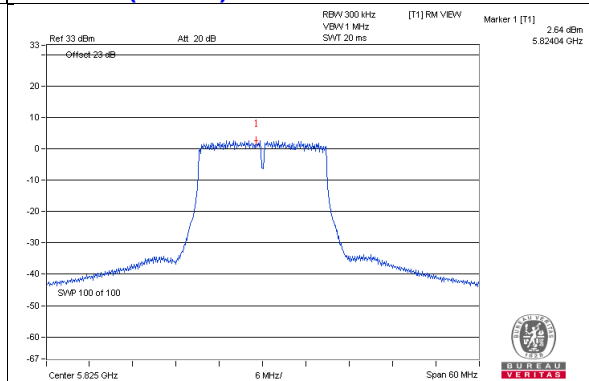

802.11ac (VHT40) / Chain 3: CH159

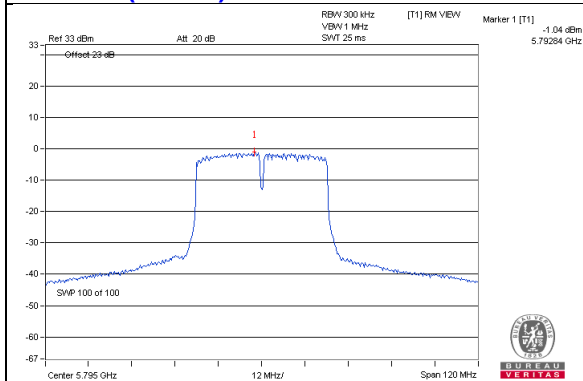

802.11ac (VHT80) / Chain 1 : CH155

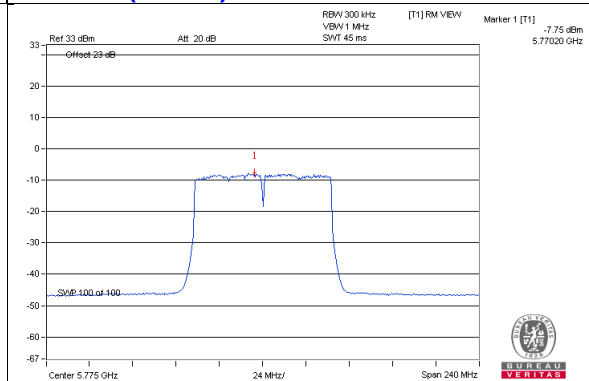

4.6 Frequency Stability Measurement

4.6.1 Limits of Frequency Stability Measurement

The frequency of the carrier signal shall be maintained within band of operation

4.6.2 Test Setup

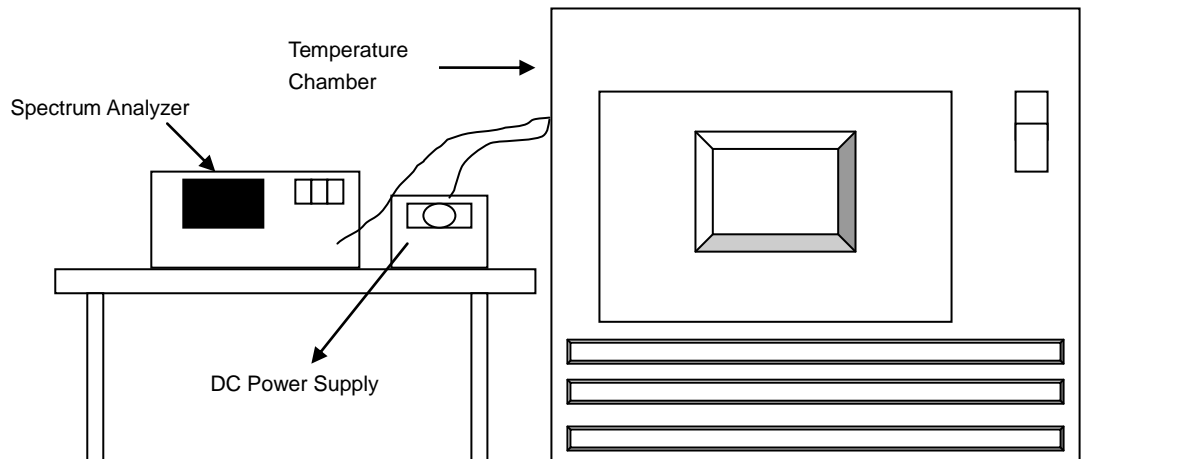

4.6.3 Test Instruments

Refer to section 4.1.2 to get information of above instrument.

4.6.4 Test Procedure

- The EUT was placed inside the environmental test chamber and powered by nominal DC voltage.
- Turn the EUT on and couple its output to a spectrum analyzer.
- Turn the EUT off and set the chamber to the highest temperature specified.
- Allow sufficient time (approximately 30 min) for the temperature of the chamber to stabilize, turn the EUT on and measure the operating frequency after 2, 5, and 10 Minutes.
- Repeat step 2 and 3 with the temperature chamber set to the lowest temperature.
- The test chamber was allowed to stabilize at +20 degree C for a minimum of 30 Minutes. The supply voltage was then adjusted on the EUT from 85% to 115% and the frequency record.

4.6.5 Deviation from Test Standard

No deviation.

4.6.6 EUT Operating Condition

Set the EUT transmit at un-modulation mode to test frequency stability.

4.6.7 Test Results (Mode 1)

Frequency Stability Versus Temp.									
Operating Frequency: 5180 MHz									
TEMP. (°C)	Power Supply (Vdc)	0 Minute		2 Minute		5 Minute		10 Minute	
		Measured Frequency (MHz)	Pass/Fail	Measured Frequency (MHz)	Pass/Fail	Measured Frequency (MHz)	Pass/Fail	Measured Frequency (MHz)	Pass/Fail
50	12	5179.9997	PASS	5179.9954	PASS	5179.9958	PASS	5179.9993	PASS
40	12	5179.9755	PASS	5179.9728	PASS	5179.9761	PASS	5179.9755	PASS
30	12	5180.0097	PASS	5180.0079	PASS	5180.0083	PASS	5180.0079	PASS
20	12	5180.0043	PASS	5180.0012	PASS	5180.0012	PASS	5180.0003	PASS
10	12	5180.0177	PASS	5180.0196	PASS	5180.0199	PASS	5180.0202	PASS
0	12	5180.0158	PASS	5180.0163	PASS	5180.0172	PASS	5180.0176	PASS
-10	12	5180.0192	PASS	5180.016	PASS	5180.0175	PASS	5180.0176	PASS
-20	12	5179.9899	PASS	5179.9896	PASS	5179.9899	PASS	5179.9931	PASS
-30	12	5179.9819	PASS	5179.9839	PASS	5179.9836	PASS	5179.981	PASS

Frequency Stability Versus Voltage									
Operating Frequency: 5180 MHz									
TEMP. (°C)	Power Supply (Vdc)	0 Minute		2 Minute		5 Minute		10 Minute	
		Measured Frequency (MHz)	Pass/Fail	Measured Frequency (MHz)	Pass/Fail	Measured Frequency (MHz)	Pass/Fail	Measured Frequency (MHz)	Pass/Fail
20	12	5180.0048	PASS	5180.0013	PASS	5180.0004	PASS	5179.9993	PASS
	12	5180.0043	PASS	5180.0012	PASS	5180.0012	PASS	5180.0003	PASS
	12	5180.0044	PASS	5180.0018	PASS	5180.0011	PASS	5179.9996	PASS

4.6.8 Test Results (Mode 3)

Frequency Stability Versus Temp.									
Operating Frequency: 5180 MHz									
TEMP. (°C)	Power Supply (Vdc)	0 Minute		2 Minute		5 Minute		10 Minute	
		Measured Frequency (MHz)	Pass/Fail	Measured Frequency (MHz)	Pass/Fail	Measured Frequency (MHz)	Pass/Fail	Measured Frequency (MHz)	Pass/Fail
50	12	5179.9878	PASS	5179.988	PASS	5179.9878	PASS	5179.9904	PASS
40	12	5179.9717	PASS	5179.9751	PASS	5179.973	PASS	5179.9757	PASS
30	12	5180.0026	PASS	5179.9993	PASS	5180.0015	PASS	5179.9982	PASS
20	12	5180.0036	PASS	5180.0067	PASS	5180.0062	PASS	5180.0042	PASS
10	12	5179.9768	PASS	5179.9734	PASS	5179.9767	PASS	5179.9757	PASS
0	12	5180.0151	PASS	5180.013	PASS	5180.0139	PASS	5180.0117	PASS
-10	12	5179.9984	PASS	5179.9946	PASS	5179.9953	PASS	5179.995	PASS
-20	12	5180.015	PASS	5180.0164	PASS	5180.0194	PASS	5180.0173	PASS
-30	12	5179.995	PASS	5179.9954	PASS	5179.9921	PASS	5179.996	PASS

Frequency Stability Versus Voltage									
Operating Frequency: 5180 MHz									
TEMP. (°C)	Power Supply (Vdc)	0 Minute		2 Minute		5 Minute		10 Minute	
		Measured Frequency (MHz)	Pass/Fail	Measured Frequency (MHz)	Pass/Fail	Measured Frequency (MHz)	Pass/Fail	Measured Frequency (MHz)	Pass/Fail
20	12	5180.0045	PASS	5180.0062	PASS	5180.0071	PASS	5180.0041	PASS
	12	5180.0036	PASS	5180.0067	PASS	5180.0062	PASS	5180.0042	PASS
	12	5180.0031	PASS	5180.0059	PASS	5180.0057	PASS	5180.0037	PASS

4.7 6dB Bandwidth Measurement

4.7.1 Limits of 6dB Bandwidth Measurement

The minimum of 6dB Bandwidth Measurement is 0.5MHz.

4.7.2 Test Setup

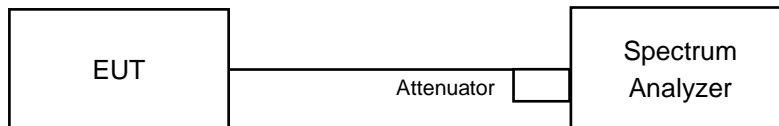

4.7.3 Test Instruments

Refer to section 4.1.2 to get information of above instrument.

4.7.4 Test Procedure

MEASUREMENT PROCEDURE REF

- Set resolution bandwidth (RBW) = 100kHz
- Set the video bandwidth (VBW) $\geq 3 \times$ RBW, Detector = Peak.
- Trace mode = max hold.
- Sweep = auto couple.
- Measure the maximum width of the emission that is constrained by the frequencies associated with the two amplitude points (upper and lower) that are attenuated by 6 dB relative to the maximum level measured in the fundamental emission

4.7.5 Deviation from Test Standard

No deviation.

4.7.6 EUT Operating Condition

The software provided by client to enable the EUT under transmission condition continuously at lowest, middle and highest channel frequencies individually.

4.7.7 Test Results (Mode 1)

Master / Client Mode
802.11a

Channel	Frequency (MHz)	6dB Bandwidth (MHz)		Minimum Limit (MHz)	Pass / Fail
		Chain 0	Chain 1		
149	5745	16.39	14.46	0.5	PASS
157	5785	16.42	13.89	0.5	PASS
165	5825	16.40	15.10	0.5	PASS

802.11ac (VHT20)

Channel	Frequency (MHz)	6dB Bandwidth (MHz)		Minimum Limit (MHz)	Pass / Fail
		Chain 0	Chain 1		
149	5745	17.64	15.29	0.5	PASS
157	5785	17.65	13.79	0.5	PASS
165	5825	17.66	16.33	0.5	PASS

802.11ac (VHT40)

Channel	Frequency (MHz)	6dB Bandwidth (MHz)		Minimum Limit (MHz)	Pass / Fail
		Chain 0	Chain 1		
151	5755	35.60	30.18	0.5	PASS
159	5795	35.54	31.68	0.5	PASS

802.11ac (VHT80)

Channel	Frequency (MHz)	6dB Bandwidth (MHz)		Minimum Limit (MHz)	Pass / Fail
		Chain 0	Chain 1		
155	5775	76.00	74.34	0.5	PASS

Spectrum Plot of Worst Value

802.11a_Chain 1 / CH157

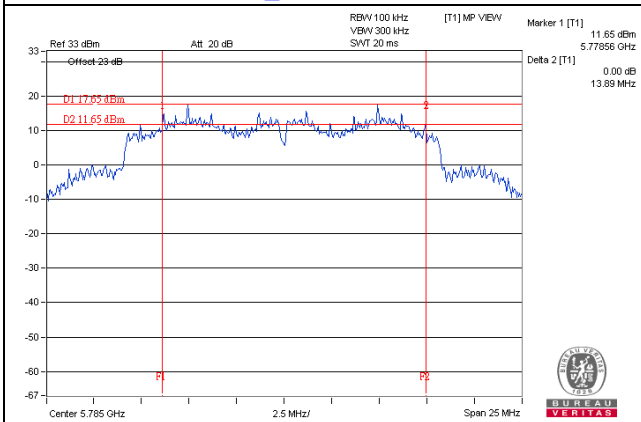

802.11ac (VHT20)_Chain 1 / CH157

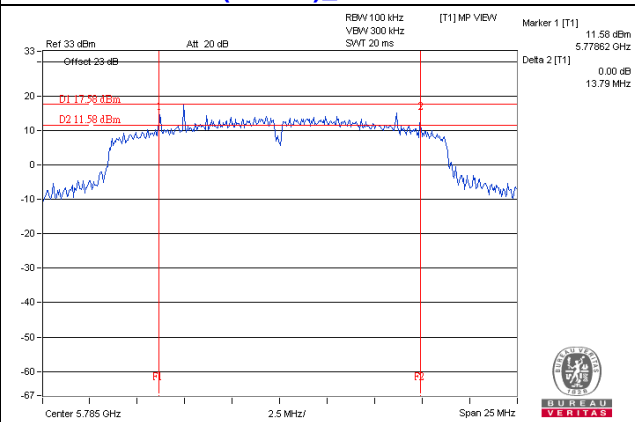

802.11ac (VHT40)_Chain 1 / CH151

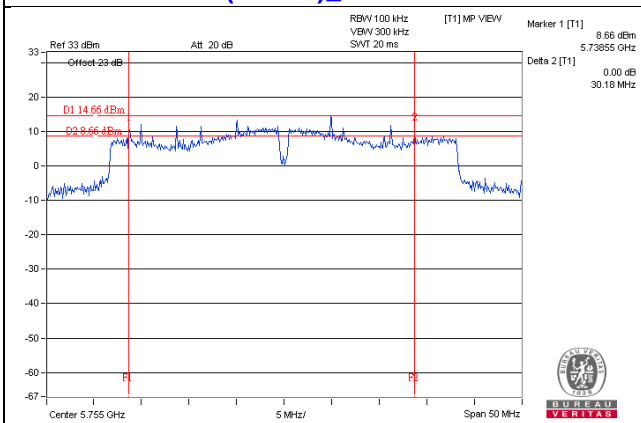

802.11ac (VHT80)_Chain 1 / CH155

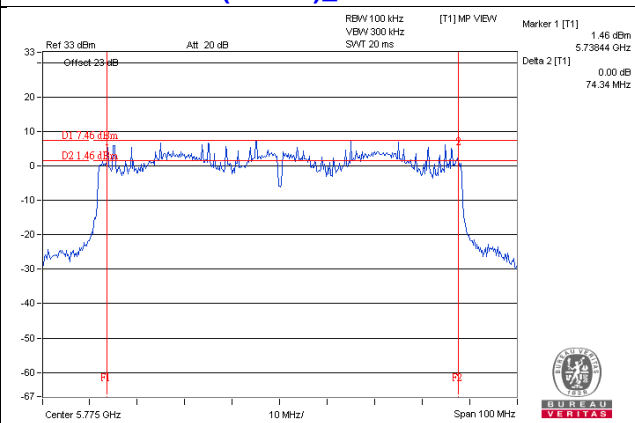

4.7.8 Test Results (Mode 3)

Master / Client Mode

802.11a

Channel	Frequency (MHz)	6dB Bandwidth (MHz)				Minimum Limit (MHz)	Pass / Fail
		Chain 0	Chain 1	Chain 2	Chain 3		
149	5745	16.39	16.40	16.38	16.40	0.5	PASS
157	5785	16.40	16.42	16.42	16.41	0.5	PASS
165	5825	16.39	16.42	16.38	16.39	0.5	PASS

802.11ac (VHT20)

Channel	Frequency (MHz)	6dB Bandwidth (MHz)				Minimum Limit (MHz)	Pass / Fail
		Chain 0	Chain 1	Chain 2	Chain 3		
149	5745	17.61	17.66	17.60	17.62	0.5	PASS
157	5785	17.63	17.64	17.61	17.63	0.5	PASS
165	5825	17.63	17.62	17.60	17.63	0.5	PASS

802.11ac (VHT40)

Channel	Frequency (MHz)	6dB Bandwidth (MHz)				Minimum Limit (MHz)	Pass / Fail
		Chain 0	Chain 1	Chain 2	Chain 3		
151	5755	35.45	35.16	35.81	35.48	0.5	PASS
159	5795	35.57	35.18	35.75	35.16	0.5	PASS

802.11ac (VHT80)

Channel	Frequency (MHz)	6dB Bandwidth (MHz)				Minimum Limit (MHz)	Pass / Fail
		Chain 0	Chain 1	Chain 2	Chain 3		
155	5775	76.28	76.46	76.46	76.49	0.5	PASS

Spectrum Plot of Worst Value

802.11a_Chain 2 / CH149

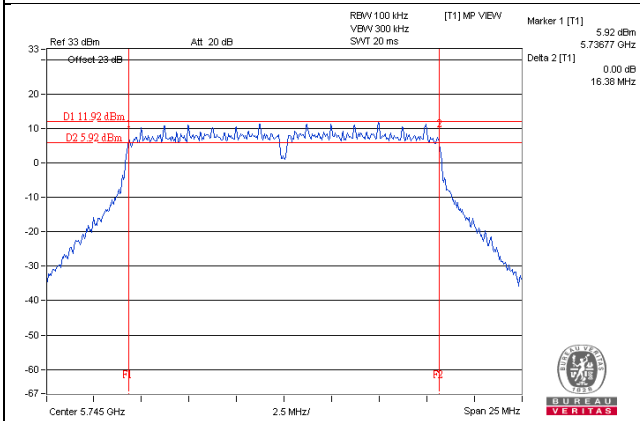

802.11ac (VHT20)_Chain 2 / CH149

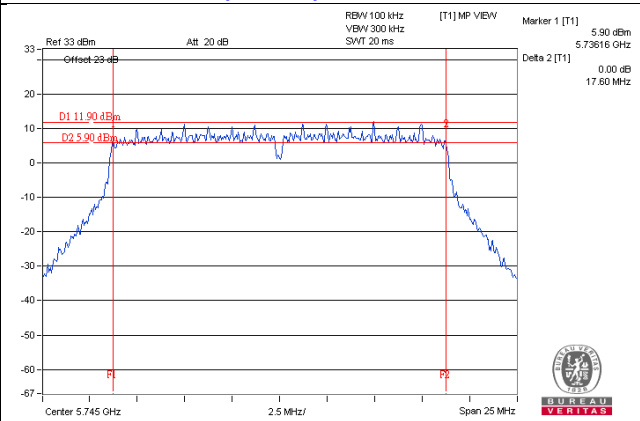

802.11ac (VHT40)_Chain 1 / CH151

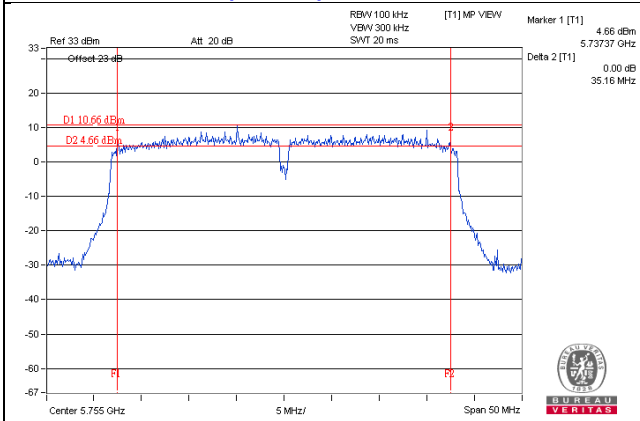

802.11ac (VHT80)_Chain 0 / CH155

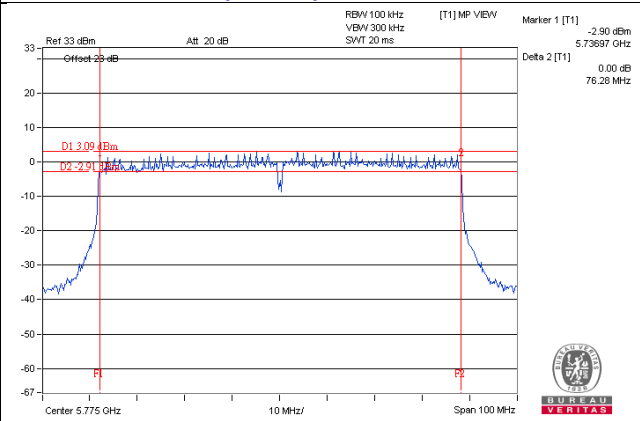

5 Pictures of Test Arrangements

Please refer to the attached file (Test Setup Photo).

Annex A- Radiated Out of Band Emission (OOBE) Measurement (For U-NII-3 band)

Radio 1

802.11a

CH 149 5745 MHz

Horizontal

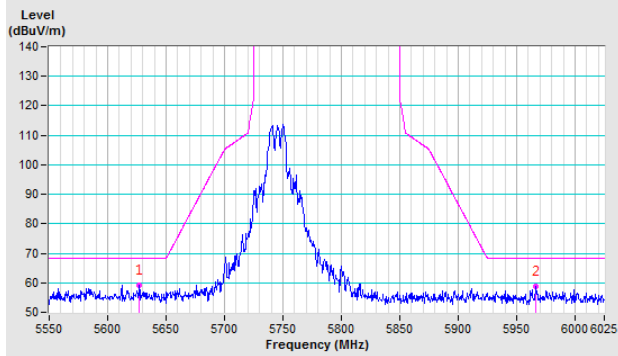

Vertical

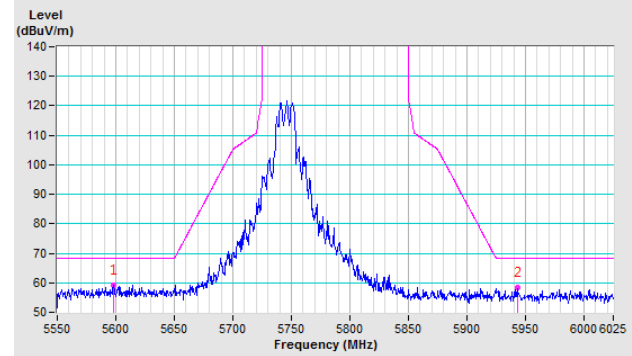

CH 157 5785 MHz

Horizontal

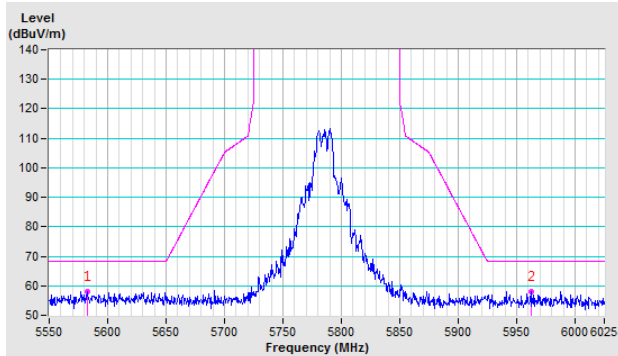

Vertical

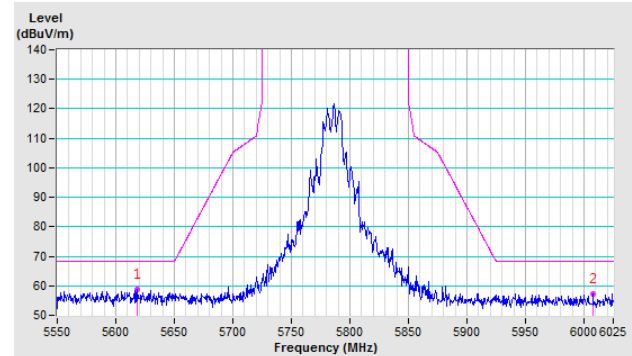

CH 165 5825 MHz

Horizontal

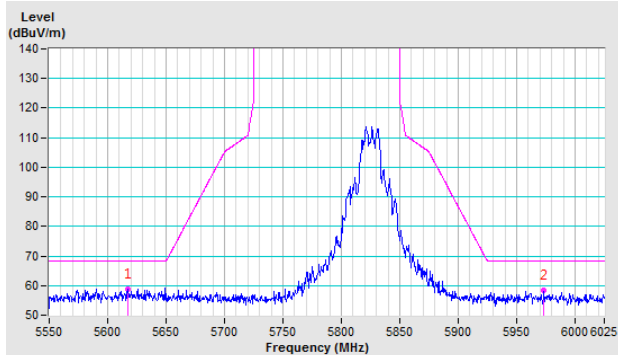

Vertical

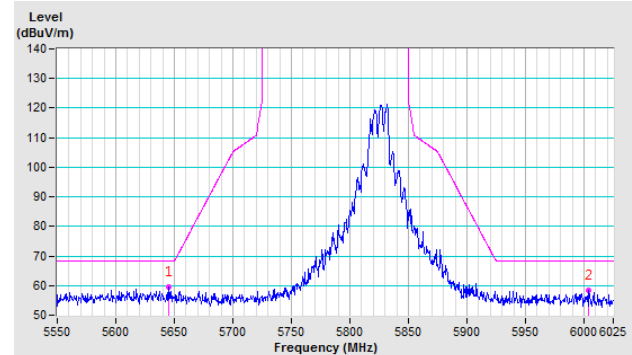

802.11ac (VHT20)

CH 149 5745 MHz

Horizontal

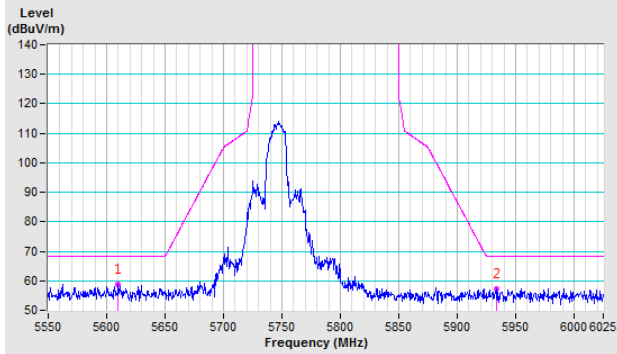

Vertical

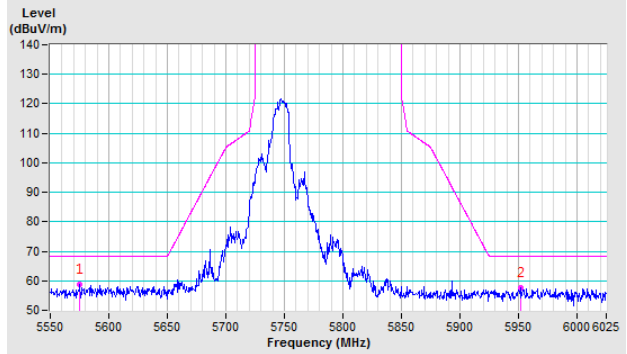

CH 157 5785 MHz

Horizontal

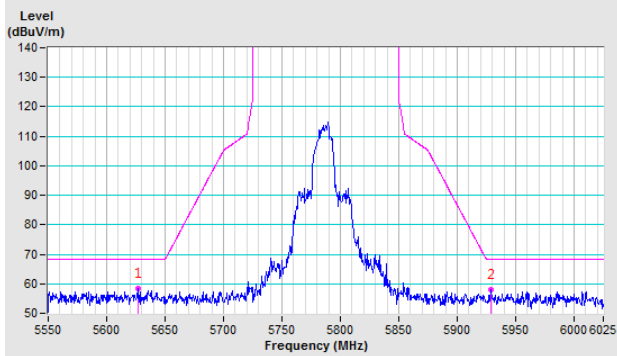

Vertical

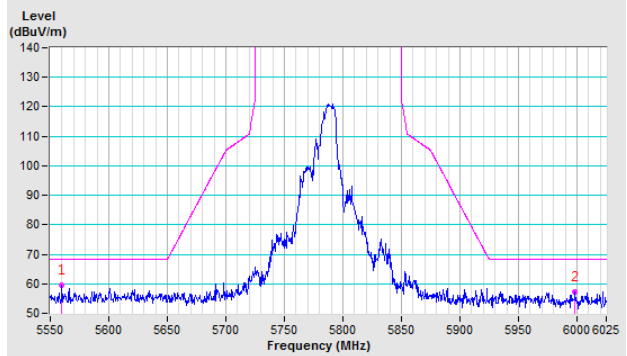

CH 165 5825 MHz

Horizontal

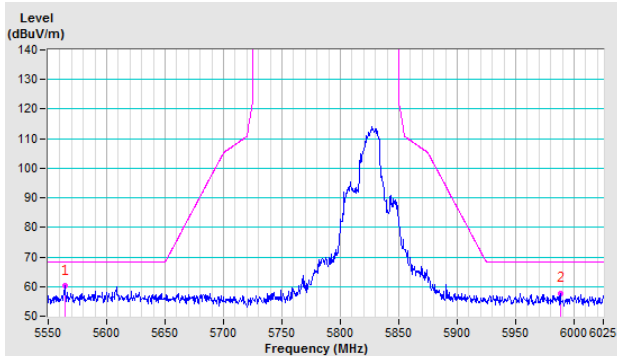

Vertical

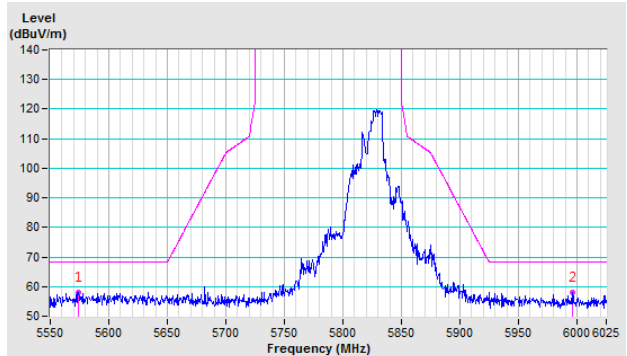

802.11ac (VHT40)

CH 151 5755 MHz

Horizontal

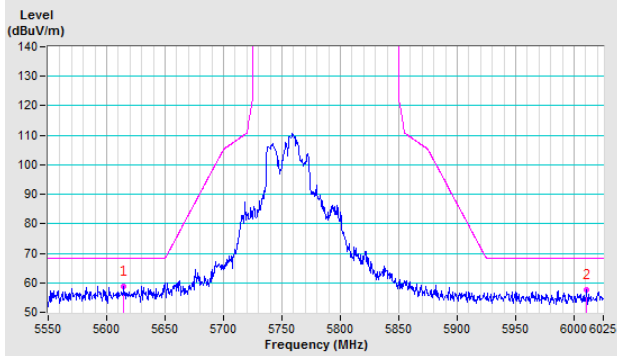

Vertical

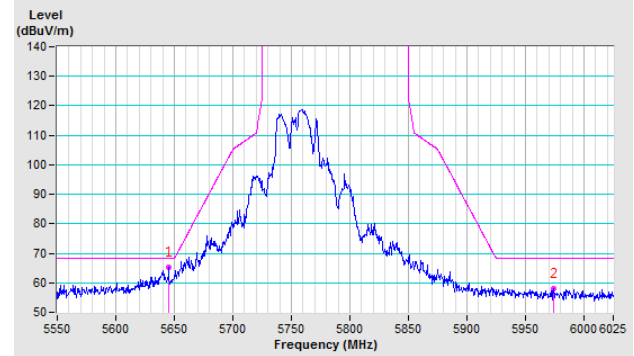

CH 159 5795 MHz

Horizontal

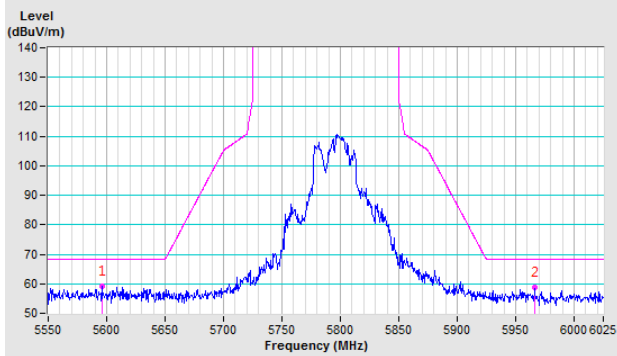

Vertical

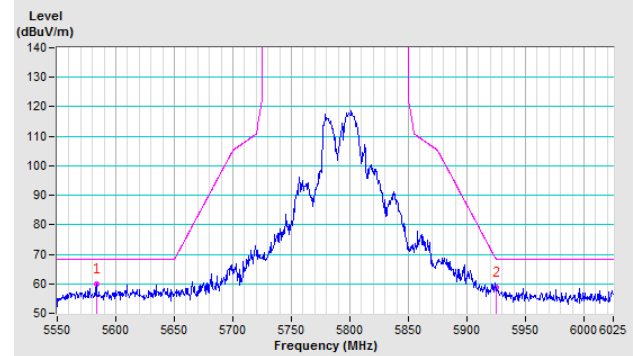

802.11ac (VHT80)

CH 155 5775 MHz

Horizontal

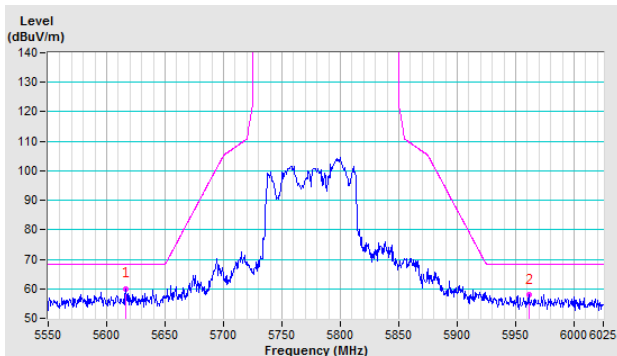

Vertical

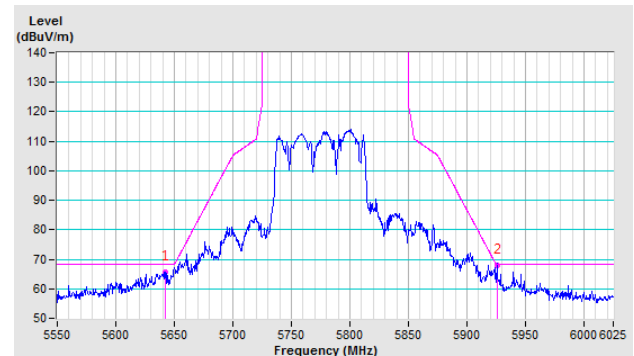

Radio 2

802.11a

CH 149 5745 MHz

Horizontal

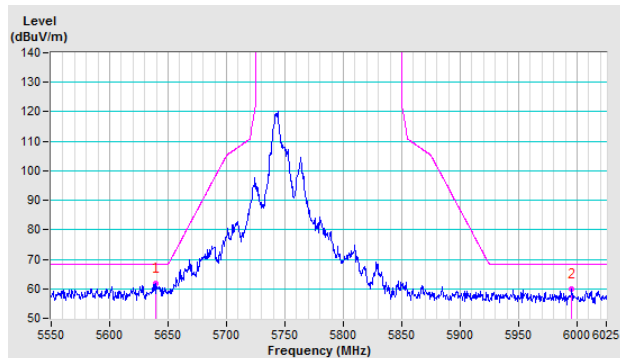

Vertical

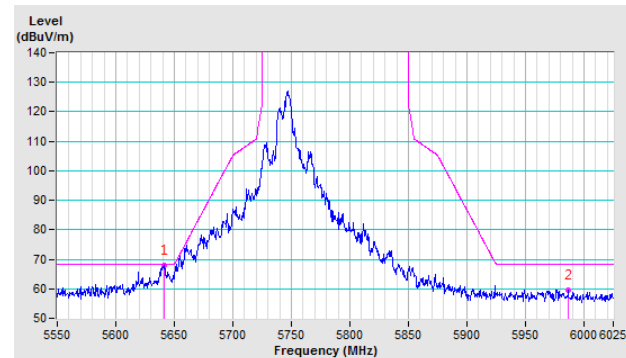

CH 157 5785 MHz

Horizontal

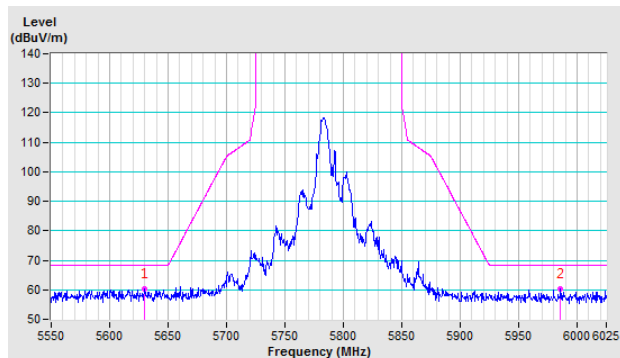

Vertical

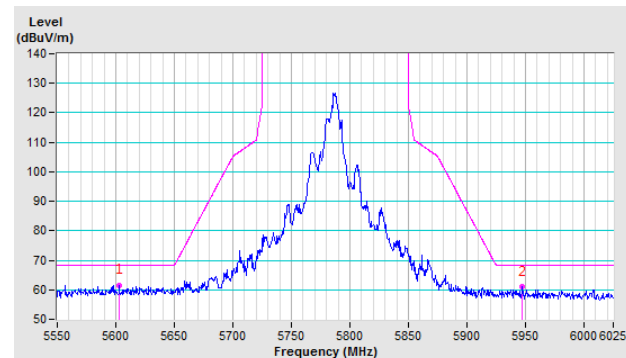

CH 165 5825 MHz

Horizontal

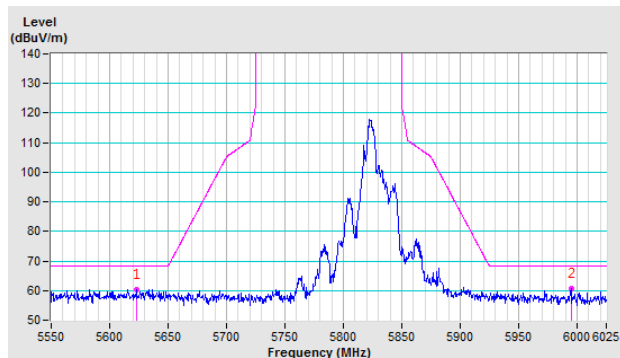

Vertical

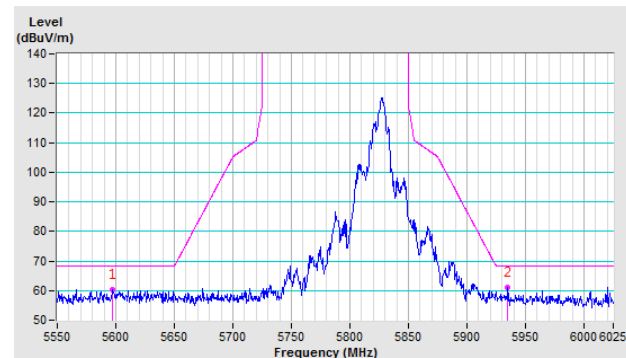

802.11ac (VHT20)

CH 149 5745 MHz

Horizontal

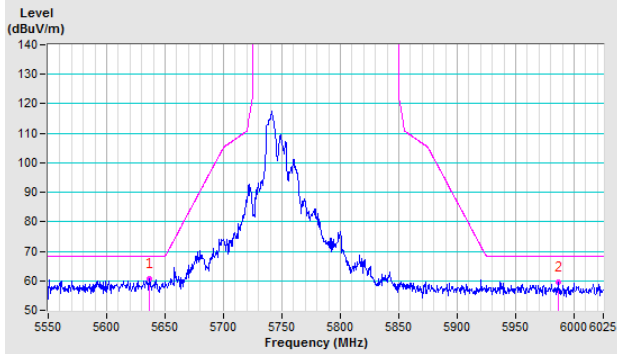

Vertical

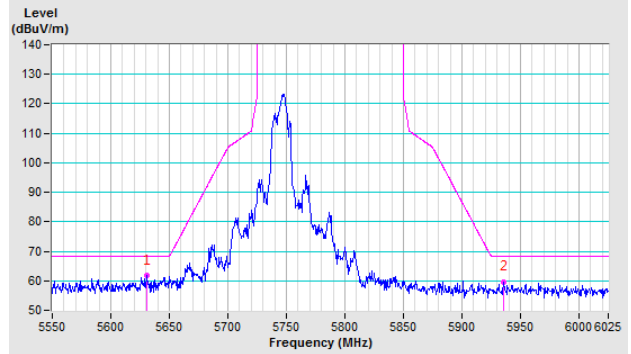

CH 157 5785 MHz

Horizontal

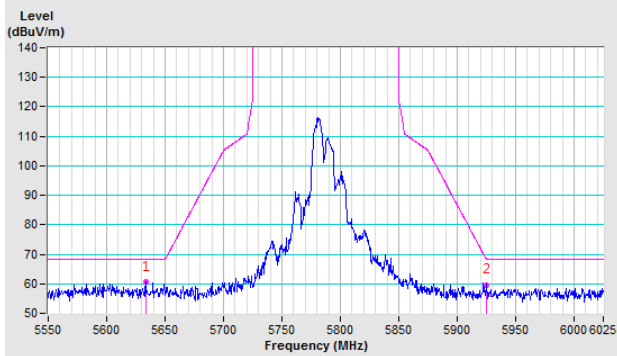

Vertical

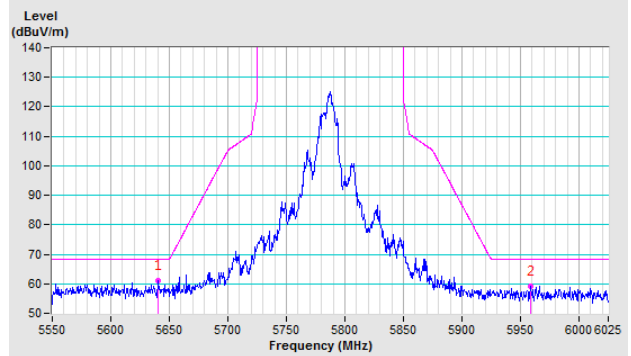

CH 165 5825 MHz

Horizontal

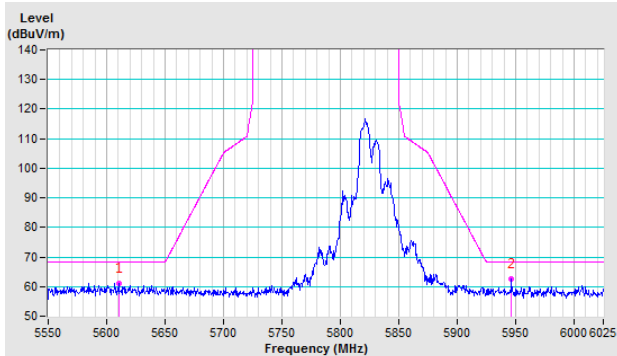

Vertical

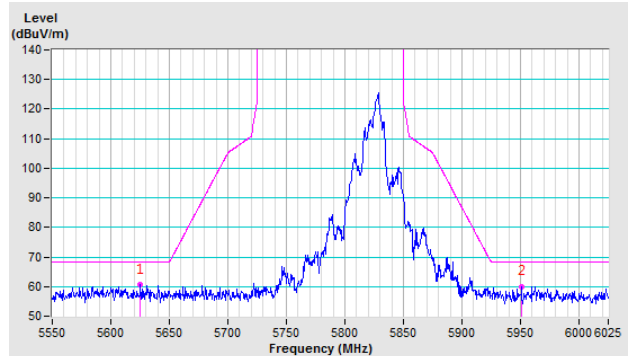

802.11ac (VHT40)

CH 151 5755 MHz

Horizontal

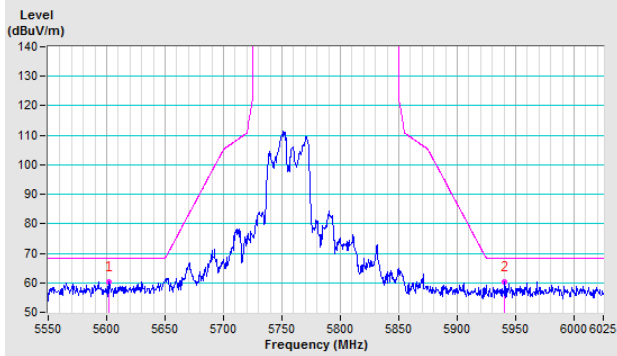

Vertical

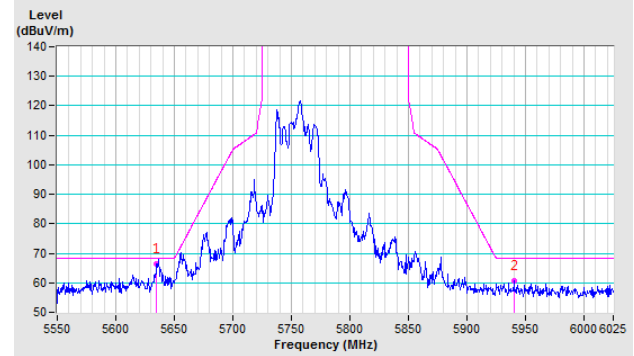

CH 159 5795 MHz

Horizontal

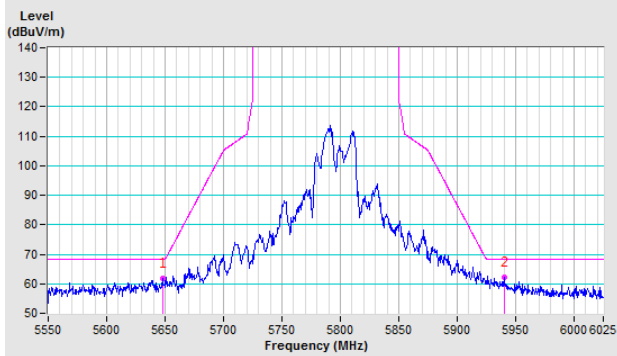

Vertical

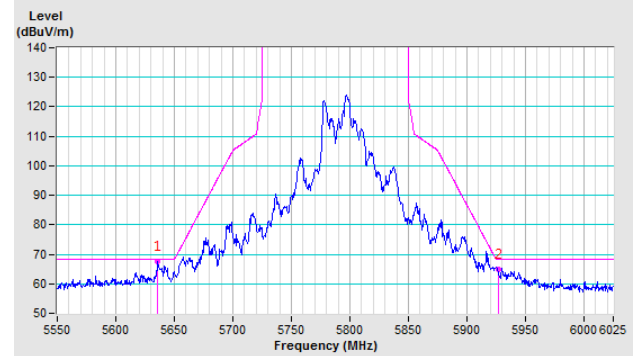

802.11ac (VHT80)

CH 155 5775 MHz

Horizontal

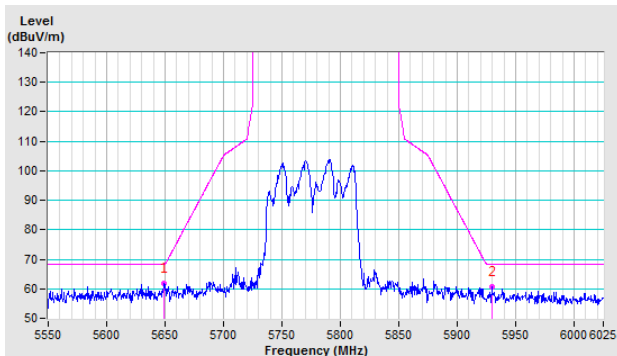

Vertical

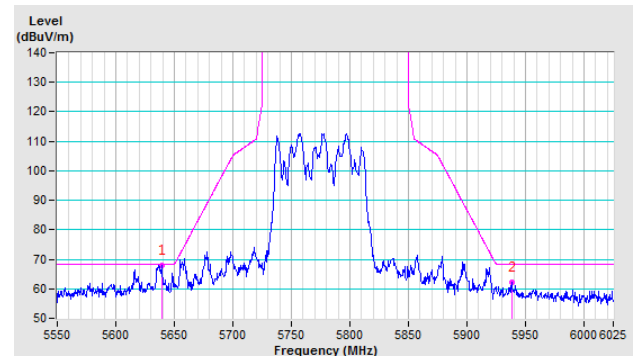

Appendix – Information on the Testing Laboratories

We, Bureau Veritas Consumer Products Services (H.K.) Ltd., Taoyuan Branch, were founded in 1988 to provide our best service in EMC, Radio, Telecom and Safety consultation. Our laboratories are FCC recognized accredited test firms and accredited according to ISO/IEC 17025.

If you have any comments, please feel free to contact us at the following:

Linko EMC/RF Lab

Tel: 886-2-26052180

Fax: 886-2-26051924

Hsin Chu EMC/RF/Telecom Lab

Tel: 886-3-6668565

Fax: 886-3-6668323

Hwa Ya EMC/RF/Safety Lab

Tel: 886-3-3183232

Fax: 886-3-3270892

Email: service.adt@tw.bureauveritas.com

Web Site: www.bureauveritas-adt.com

The address and road map of all our labs can be found in our web site also.

--- END ---