



FCC TEST REPORT (15.407)

REPORT NO.: RF130911E03-1 R1

MODEL NO.: S4A340A

FCC ID: UXX-S4A340A

RECEIVED: Sep. 11, 2013

TESTED: Sep. 16 to Oct. 21, 2013

ISSUED: Nov. 04, 2013

APPLICANT: Cradlepoint, Inc

ADDRESS: 805W. Franklin Street, Boise, ID 83702

ISSUED BY: Bureau Veritas Consumer Products Services
(H.K.) Ltd., Taoyuan Branch Hsin Chu Laboratory

LAB ADDRESS : No. 81-1, Lu Liao Keng, 9th Ling, Wu Lung Tsuen,
Chiung Lin Hsiang, Hsin Chu Hsien 307, Taiwan,
R.O.C.

TEST LOCATION (1): No. 81-1, Lu Liao Keng, 9th Ling, Wu Lung Tsuen,
Chiung Lin Hsiang, Hsin Chu Hsien 307, Taiwan,
R.O.C.

TEST LOCATION (2): No. 49, Ln. 206, Wende Rd., Shangshan Tsuen,
Chiung Lin Hsiang, Hsin Chu Hsien 307, Taiwan,
R.O.C.

This report should not be used by the client to claim product certification, approval, or endorsement by TAF or any government agencies.



This report is for your exclusive use. Any copying or replication of this report to or for any other person or entity, or use of our name or trademark, is permitted only with our prior written permission. This report sets forth our findings solely with respect to the test samples identified herein. The results set forth in this report are not indicative or representative of the quality or characteristics of the lot from which a test sample was taken or any similar or identical product unless specifically and expressly noted. Our report includes all of the tests requested by you and the results thereof based upon the information that you provided to us. You have 60 days from date of issuance of this report to notify us of any material error or omission caused by our negligence, provided, however, that such notice shall be in writing and shall specifically address the issue you wish to raise. A failure to raise such issue within the prescribed time shall constitute your unqualified acceptance of the completeness of this report, the tests conducted and the correctness of the report contents. Unless specific mention, the uncertainty of measurement has been explicitly taken into account to declare the compliance or non-compliance to the specification



A D T

Table of Contents

RELEASE CONTROL RECORD	4
1. CERTIFICATION	5
2. SUMMARY OF TEST RESULTS	6
2.1 MEASUREMENT UNCERTAINTY	7
3. GENERAL INFORMATION	8
3.1 GENERAL DESCRIPTION OF EUT	8
3.2 DESCRIPTION OF TEST MODES	12
3.2.1 TEST MODE APPLICABILITY AND TESTED CHANNEL DETAIL	13
3.3 GENERAL DESCRIPTION OF APPLIED STANDARDS	15
3.4 DUTY CYCLE OF TEST SIGNAL	16
3.5 DESCRIPTION OF SUPPORT UNITS	20
3.6 CONFIGURATION OF SYSTEM UNDER TEST	21
4. TEST TYPES AND RESULTS	22
4.1 CONDUCTED EMISSION MEASUREMENT	22
4.1.1 LIMITS OF CONDUCTED EMISSION MEASUREMENT	22
4.1.2 TEST INSTRUMENTS	22
4.1.3 TEST PROCEDURES	24
4.1.4 DEVIATION FROM TEST STANDARD	24
4.1.5 TEST SETUP	24
4.1.6 EUT OPERATING CONDITIONS	25
4.1.7 TEST RESULTS(MODE 1)	28
4.1.8 TEST RESULTS(MODE 2)	26
4.2 RADIATED EMISSION AND BANDEDGE MEASUREMENT	30
4.2.1 LIMITS OF RADIATED EMISSION AND BANDEDGE MEASUREMENT	30
4.2.2 LIMITS OF UNWANTED EMISSION OUT OF THE RESTRICTED BANDS	30
4.2.3 TEST INSTRUMENTS	31
4.2.4 TEST PROCEDURES	32
4.2.5 DEVIATION FROM TEST STANDARD	32
4.2.6 TEST SETUP	33
4.2.7 EUT OPERATING CONDITION	33
4.2.8 TEST RESULTS	34
4.3 TRANSMIT POWER MEASUREMENT	44
4.3.1 LIMITS OF TRANSMIT POWER MEASUREMENT	44
4.3.2 TEST INSTRUMENTS	44
4.3.3 TEST PROCEDURE	45
4.3.4 DEVIATION FROM TEST STANDARD	45
4.3.5 TEST SETUP	46
4.3.6 EUT OPERATING CONDITIONS	46
4.3.7 TEST RESULTS	47
4.4 PEAK POWER SPECTRAL DENSITY MEASUREMENT	51
4.4.1 LIMITS OF PEAK POWER SPECTRAL DENSITY MEASUREMENT	51
4.4.2 TEST INSTRUMENTS	51
4.4.3 TEST PROCEDURES	51
4.4.4 DEVIATION FROM TEST STANDARD	51
4.4.5 TEST SETUP	52
4.4.6 EUT OPERATING CONDITIONS	52
4.4.7 TEST RESULTS	53



A D T

4.5	PEAK POWER EXCURSION MEASUREMENT	56
4.5.1	LIMITS OF PEAK POWER EXCURSION MEASUREMENT	56
4.5.2	TEST INSTRUMENTS.....	56
4.5.3	TEST PROCEDURE.....	56
4.5.4	DEVIATION FROM TEST STANDARD	56
4.5.5	TEST SETUP	56
4.5.6	EUT OPERATING CONDITIONS	56
4.5.7	TEST RESULTS	57
4.6	FREQUENCY STABILITY.....	60
4.6.1	LIMITS OF FREQUENCY STABILITY MEASUREMENT	60
4.6.2	TEST INSTRUMENTS.....	60
4.6.3	TEST PROCEDURE.....	60
4.6.4	DEVIATION FROM TEST STANDARD	61
4.6.5	TEST SETUP	61
4.6.6	EUT OPERATING CONDITION.....	61
4.6.7	TEST RESULTS	62
5.	PHOTOGRAPHS OF THE TEST CONFIGURATION.....	63
6.	INFORMATION ON THE TESTING LABORATORIES	64
7.	APPENDIX A - MODIFICATIONS RECORDERS FOR ENGINEERING CHANGES TO THE EUT BY THE LAB.....	65



A D T

RELEASE CONTROL RECORD

ISSUE NO.	REASON FOR CHANGE	DATE ISSUED
RF130911E03-1	Original release	Oct. 24, 2013
RF130911E03-1 R1	Revise Antenna Spec (Set 3) for report typo.	Nov. 04, 2013



A D T

1. CERTIFICATION

PRODUCT: Integrated Mobile Broadband Router
BRAND NAME: cradlepoint
MODEL NO.: S4A340A
TEST SAMPLE: ENGINEERING SAMPLE
APPLICANT: Cradlepoint, Inc
TESTED: Sep. 16 to Oct. 21, 2013
STANDARDS: **FCC Part 15, Subpart E (Section 15.407)**
ANSI C63.10-2009

The above equipment (Model: S4A340A) has been tested by **Bureau Veritas Consumer Products Services (H.K.) Ltd., Taoyuan Branch**, and found compliance with the requirement of the above standards. The test record, data evaluation & Equipment Under Test (EUT) configurations represented herein are true and accurate accounts of the measurements of the sample's EMC characteristics under the conditions specified in this report.

PREPARED BY :

(Midoli Peng, Specialist)

DATE: Nov. 04, 2013

APPROVED BY :

(May Chen, Manager)

DATE: Nov. 04, 2013



A D T

2. SUMMARY OF TEST RESULTS

The EUT has been tested according to the following specifications:

For 5GHz, 5150~5250MHz

APPLIED STANDARD: FCC PART 15, SUBPART E (SECTION 15.407)			
STANDARD SECTION	TEST TYPE	RESULT	REMARK
15.407(b)(6)	AC Power Conducted Emission	PASS	Meet the requirement of limit. Minimum passing margin is -1.87dB at 0.47031MHz
15.407(b/1/2/3) (b)(5)	Spurious Emissions	PASS	Meet the requirement of limit. Minimum passing margin is -0.3dB at 5097.52MHz
15.407(a/1/2/3)	Transmit Power	PASS	Meet the requirement of limit.
15.407(a)(6)	Peak Power Excursion	PASS	Meet the requirement of limit.
15.407(a/1/2/3)	Peak Power Spectral Density	PASS	Meet the requirement of limit.
15.407(g)	Frequency Stability	PASS	Meet the requirement of limit.
15.203	Antenna Requirement	PASS	Antenna connector is R-SMA not a standard connector.

NOTE: The EUT was operating in 2.400 ~ 2.4835GHz, 5.15~5.25GHz and 5.725~5.850GHz frequencies band. This report was recorded the RF parameters including 5.15~5.25GHz. For the 2.400 ~ 2.4835GHz and 5.725~5.850GHz RF parameters was recorded in another test report.



A D T

2.1 MEASUREMENT UNCERTAINTY

Where relevant, the following measurement uncertainty levels have been estimated for tests performed on the EUT as specified in CISPR 16-4-2:

This uncertainty represents an expanded uncertainty expressed at approximately the 95% confidence level using a coverage factor of $k=2$.

Measurement	Value
Conducted emissions	2.98 dB
Radiated emissions (30MHz-1GHz)	5.46 dB
Radiated emissions (1GHz -6GHz)	3.54 dB
Radiated emissions (6GHz -18GHz)	4.08 dB
Radiated emissions (18GHz -40GHz)	4.11 dB



A D T

3. GENERAL INFORMATION

3.1 GENERAL DESCRIPTION OF EUT

PRODUCT	Integrated Mobile Broadband Router
MODEL NO.	S4A340A
POWER SUPPLY	DC 12V from power adapter
MODULATION TYPE	CCK, DQPSK, DBPSK for DSSS 64QAM, 16QAM, QPSK, BPSK for OFDM 256QAM for OFDM in 11ac mode only
MODULATION TECHNOLOGY	DSSS,OFDM
TRANSFER RATE	802.11b: up to 11Mbps 802.11a / g: up to 54Mbps 802.11n: up to 450Mbps 802.11ac: up to 1300Mbps
OPERATING FREQUENCY	For 15.407 5GHz: 5.18 ~ 5.24GHz For 15.247 2.4GHz: 2.412 ~ 2.462GHz 5GHz: 5.745 ~ 5.825GHz
NUMBER OF CHANNEL	For 15.407 4 for 802.11a, 802.11n (HT20), 802.11ac (VHT20) 2 for 802.11n (HT40), 802.11ac (VHT40) 1 for 802.11ac (VHT80) For 15.247 (2.4GHz) 11 for 802.11b, 802.11g, 802.11n (HT20) 7 for 802.11n (HT40) For 15.247 (5GHz) 5 for 802.11a, 802.11n (HT20), 802.11ac (VHT20) 2 for 802.11n (HT40), 802.11ac (VHT40) 1 for 802.11ac (VHT80)

MAXIMUM OUTPUT POWER	For 15.407 (5GHz) 802.11a: 48.195mW 802.11ac (VHT20): 28.658mW 802.11ac (VHT40): 48.870mW 802.11ac (VHT80): 48.557mW
	For 15.247 (2.4GHz) 802.11b: 437.522mW 802.11g: 251.768mW 802.11n (HT20): 557.816mW 802.11n (HT40): 99.349mW
	For 15.247 (5GHz) 802.11a: 274.157mW 802.11ac (VHT20): 747.107mW 802.11ac (VHT40): 599.259mW 802.11ac (VHT80): 306.036mW
	ANTENNA TYPE
	DATA CABLE
I/O PORTS	Refer to user's manual
ASSOCIATED DEVICES	Adapter x1

NOTE:

- The EUT must be supplied with a power adapter and following two different models could be chosen as following table:

No	Brand	Model No.	Spec.
1	HON-KWANG	HK-PH36-A12	Input: 100-240V, 1.5A, 50/60Hz AC input cable: 1.9m, unshielded Output: 12V, 3A DC output cable: 1.8m, unshielded
2	HON-KWANG	HK-AH-120A400-DH	Input: 100-240V, 1.6A, 50/60Hz AC input cable: 1.9m, unshielded Output: 12V, 4A DC output cable: 1.8m, unshielded

From the above adapters, the worst radiated emission was found in **Adapter 1**. Therefore only the test data of the modes were recorded in this report.



A D T

2. The EUT incorporates a MIMO function without beam forming.

MODULATION MODE	Tx/Rx FUNCTION
802.11a	1Tx(Diversity)/3Rx
802.11b	1Tx(Fixed chain 0)/3Rx
802.11g	1Tx(Diversity)/3Rx
802.11n (HT20)	3Tx/3Rx
802.11n (HT40)	3Tx/3Rx
802.11ac (VHT20)	3Tx/3Rx
802.11ac (VHT40)	3Tx/3Rx
802.11ac (VHT80)	3Tx/3Rx

Note: The modulation and bandwidth are similar for 802.11n mode for 20MHz (40MHz) and 802.11ac mode for 20MHz (40MHz), therefore investigated worst case to representative mode in test report. (Final test mode refer section 3.2.1)

3. The EUT could be applied with one USB Cellular Modem, therefore emission tests are added for simultaneously transmit between WLAN and USB Cellular Modem. The emission tests have been performed at the worst channel of both WLAN and USB Cellular Modem, the spurious emission of the simultaneous operation (WLAN & USB Cellular Modem) has been evaluated and no non-compliance found. < USB Cellular Modem only for test, not for sale >

Brand name	Model name	FCC ID	Spec.	Testing mode
SIERRA WIRELESS	MC7750	N7NMC7750	3G/LTE USB Dongle (Support LTE band 13 and WCDMA)	GPRS ch128, 824.2MHz

4. The antennas provided to the EUT, please refer to the following table:

Set 1									
Transmitter Circuit	Antenna Type	Gain(dBi) (Excludes cable loss)		Cable Loss (dB)		Net Gain (dBi)		Connector Type	Cable Length (cm)
		2.4GHz	5GHz	2.4GHz	5GHz	2.4GHz	5GHz		
Right Side Chain (0)	Dipole	5.03	5.59	1.2	2	3.83	3.59	R-SMA	18
In center Chain (1)	Dipole	5.03	5.59	1	1	4.03	4.59	R-SMA	11
Left Side Chain (2)	Dipole	5.03	5.59	1.2	2	3.83	3.59	R-SMA	18
Set 2									
Transmitter Circuit	Antenna Type	Gain(dBi) (Excludes cable loss)		Cable Loss (dB)		Net Gain (dBi)		Connector Type	Cable Length (cm)
		2.4GHz	5GHz	2.4GHz	5GHz	2.4GHz	5GHz		
Right Side Chain (0)	Dipole	4.7	4.7	1.2	2	3.5	2.7	R-SMA	18
In center Chain (1)	Dipole	4.7	4.7	1	1	3.7	3.7	R-SMA	11
Left Side Chain (2)	Dipole	4.7	4.7	1.2	2	3.5	2.7	R-SMA	18
Set 3									
Transmitter Circuit	Antenna Type	Gain(dBi) (Excludes cable loss)		Cable Loss (dB)		Net Gain (dBi)		Connector Type	Cable Length (cm)
		2.4GHz	5GHz	2.4GHz	5GHz	2.4GHz	5GHz		
Right Side Chain (0)	Dipole	3.8	5.5	1.2	2	2.6	3.5	R-SMA	18
In center Chain (1)	Dipole	3.8	5.5	1	1	2.8	4.5	R-SMA	11
Left Side Chain (2)	Dipole	3.8	5.5	1.2	2	2.6	3.5	R-SMA	18

Set 1 was chosen for final test.

5. When the EUT operating in 802.11n, the software operation, which is defined by manufacturer, MCS (Modulation and Coding Schemes) from 0 to 23.
6. When the EUT operating in 802.11ac, the software operation, which is defined by manufacturer, MCS (Modulation and Coding Schemes) from 0 to 9.
7. The above EUT information was declared by the manufacturer and for more detailed features description, please refer to the manufacturer's specifications or User's Manual.



A D T

3.2 DESCRIPTION OF TEST MODES

Operated in 5150 ~ 5250MHz band:

4 channels are provided for 802.11a, 802.11n (HT20), 802.11ac (VHT20):

CHANNEL	FREQUENCY	CHANNEL	FREQUENCY
36	5180 MHz	44	5220 MHz
40	5200 MHz	48	5240 MHz

2 channels are provided for 802.11n (HT40), 802.11ac (VHT40):

CHANNEL	FREQUENCY
38	5190 MHz
46	5230 MHz

1 channel is provided for 802.11ac (VHT80):

CHANNEL	FREQUENCY
42	5210 MHz

3.2.1 TEST MODE APPLICABILITY AND TESTED CHANNEL DETAIL

EUT CONFIGURE MODE	APPLICABLE TO				DESCRIPTION
	PLC	RE < 1G	RE [≥] 1G	APCM	
1	√	√	√	√	With adapter 1
2	√	-	-	-	With adapter 2

Where **PLC**: Power Line Conducted Emission **RE < 1G**: Radiated Emission below 1GHz
RE [≥] 1G: Radiated Emission above 1GHz **APCM**: Antenna Port Conducted Measurement

NOTE: 1. “-” means no effect.

2. The EUT had been pre-tested on the positioned of each 2 axis. The worst case was found when positioned on **X-plane**.

POWER LINE CONDUCTED EMISSION TEST:

- Pre-Scan has been conducted to determine the worst-case mode from all possible combinations between available modulations, data rates and antenna ports (if EUT with antenna diversity architecture).
- Following channel(s) was (were) selected for the final test as listed below.

MODE	AVAILABLE CHANNEL	TESTED CHANNEL	MODULATION TECHNOLOGY	MODULATION TYPE	DATA RATE (MBPS)
802.11ac (VHT40)	38 to 46	38	OFDM	BPSK	13.5

RADIATED EMISSION TEST (BELOW 1 GHz):

- Pre-Scan has been conducted to determine the worst-case mode from all possible combinations between available modulations, data rates and antenna ports (if EUT with antenna diversity architecture).
- Following channel(s) was (were) selected for the final test as listed below.

MODE	AVAILABLE CHANNEL	TESTED CHANNEL	MODULATION TECHNOLOGY	MODULATION TYPE	DATA RATE (Mbps)
802.11ac (VHT40)	38 to 46	38	OFDM	BPSK	13.5



A D T

RADIATED EMISSION TEST (ABOVE 1 GHz):

- Pre-Scan has been conducted to determine the worst-case mode from all possible combinations between available modulations, data rates and antenna ports (if EUT with antenna diversity architecture).
- Following channel(s) was (were) selected for the final test as listed below.

MODE	AVAILABLE CHANNEL	TESTED CHANNEL	MODULATION TECHNOLOGY	MODULATION TYPE	DATA RATE (Mbps)
802.11a	36 to 48	36, 40, 48	OFDM	BPSK	6
802.11ac (VHT20)	36 to 48	36, 40, 48	OFDM	BPSK	6.5
802.11ac (VHT40)	38 to 46	38, 46	OFDM	BPSK	13.5
802.11ac (VHT80)	42	42	OFDM	BPSK	29.3

ANTENNA PORT CONDUCTED MEASUREMENT:

- Pre-Scan has been conducted to determine the worst-case mode from all possible combinations between available modulations, data rates and antenna ports (if EUT with antenna diversity architecture).
- Following channel(s) was (were) selected for the final test as listed below.

MODE	AVAILABLE CHANNEL	TESTED CHANNEL	MODULATION TECHNOLOGY	MODULATION TYPE	DATA RATE (Mbps)
802.11a	36 to 48	36, 40, 48	OFDM	BPSK	6
802.11ac (VHT20)	36 to 48	36, 40, 48	OFDM	BPSK	6.5
802.11ac (VHT40)	38 to 46	38, 46	OFDM	BPSK	13.5
802.11ac (VHT80)	42	42	OFDM	BPSK	29.3

TEST CONDITION:

APPLICABLE TO	ENVIRONMENTAL CONDITIONS	INPUT POWER	TESTED BY
PLC	27deg. C, 56%RH	120Vac, 60Hz	Sean Huang
	28deg. C, 54%RH		
RE<1G	24deg. C, 66%RH	120Vac, 60Hz	Andy Ho
RE ³ 1G	30deg. C, 70%RH	120Vac, 60Hz	Gary Cheng
APCM	25deg. C, 60%RH	120Vac, 60Hz	Chilin Lee



3.3 GENERAL DESCRIPTION OF APPLIED STANDARDS

The EUT is a RF product. According to the specifications of the manufacturer, it must comply with the requirements of the following standards:

FCC Part 15, Subpart E (15.407)

789033 D01 General UNII Test Procedures v01 r03

662911 D01 Multiple Transmitter Output v01 r02

ANSI C63.10-2009

All test items have been performed and recorded as per the above standards.

Note: The EUT has been verified to comply with the requirements of FCC Part 15, Subpart B, Class B (DoC). The test report has been issued separately.

3.4 DUTY CYCLE OF TEST SIGNAL

If duty cycle of test signal is > 98 %, duty factor is not required.

If duty cycle of test signal is < 98%, duty factor shall be considered.

802.11a

BPSK: Duty cycle = 2.055 ms/2.075 ms = 0.990

QPSK: Duty cycle = 1.037 ms/1.059 ms = 0.979, Duty factor = $10 * \log(1/0.979) = 0.09$

16QAM: Duty cycle = 0.532 ms/0.549 ms = 0.969, Duty factor = $10 * \log(1/0.969) = 0.14$

64QAM: Duty cycle = 0.275 ms/0.293 ms = 0.939, Duty factor = $10 * \log(1/0.939) = 0.28$

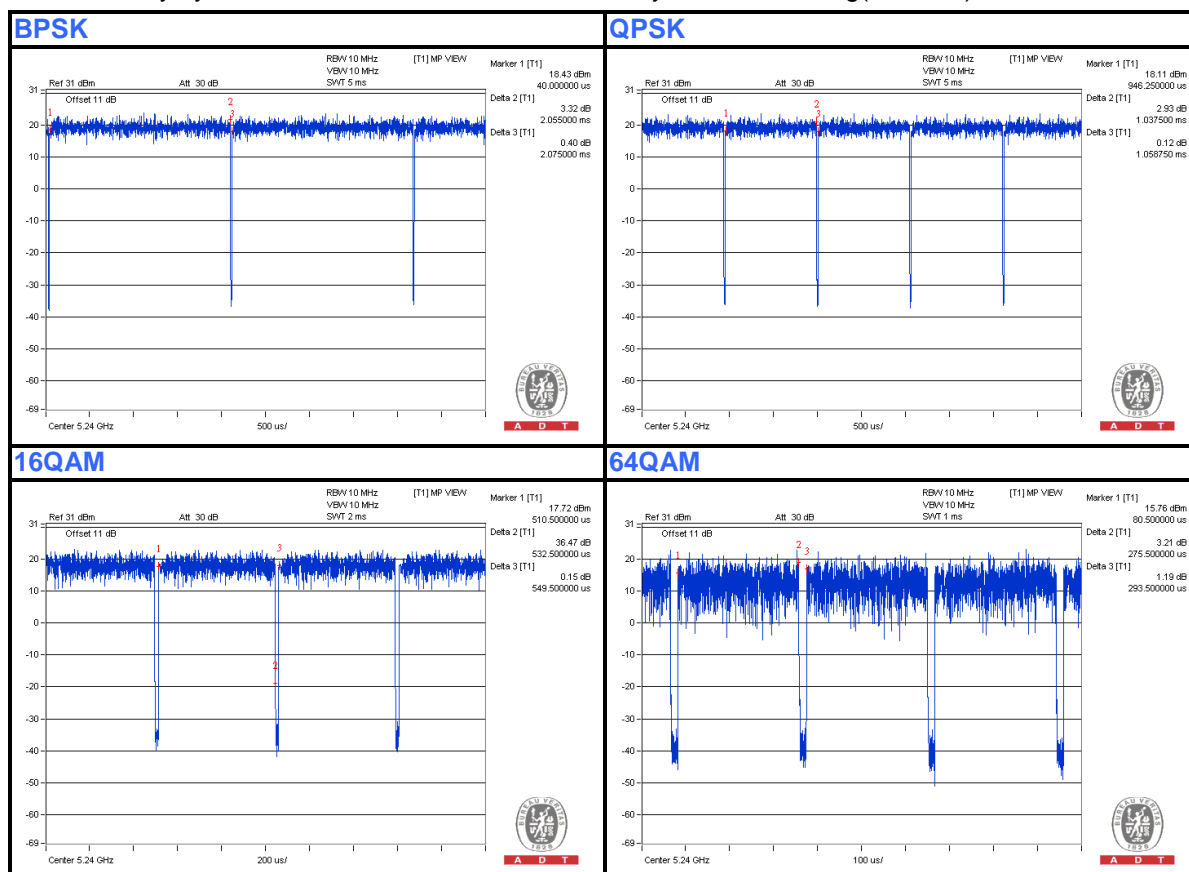



A D T

802.11ac (VHT20)

BPSK: Duty cycle = 1.916 ms/1.939 ms = 0.988

QPSK: Duty cycle = 0.984 ms/1.006 ms = 0.978, Duty factor = $10 * \log(1/0.978) = 0.1$

16QAM: Duty cycle = 0.513 ms/0.529 ms = 0.97, Duty factor = $10 * \log(1/0.97) = 0.13$

64QAM: Duty cycle = 0.278 ms/0.294 ms = 0.946, Duty factor = $10 * \log(1/0.946) = 0.24$

256QAM: Duty cycle = 0.202 ms/0.22 ms = 0.927, Duty factor = $10 * \log(1/0.927) = 0.33$

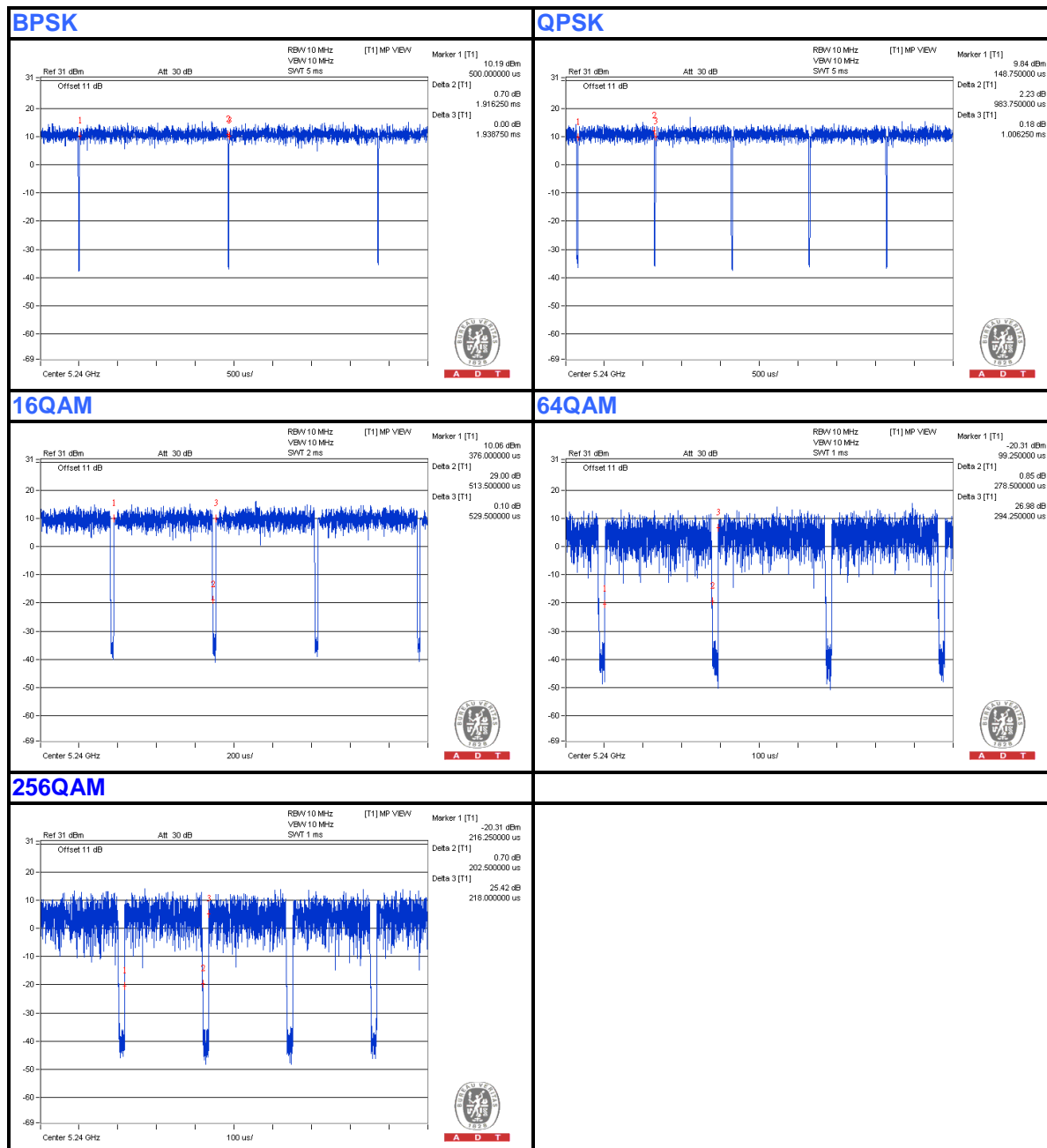



A D T

802.11ac (VHT40)

BPSK: Duty cycle = 0.941 ms/0.966 ms = 0.974, Duty factor = $10 * \log(1/0.974) = 0.11$

QPSK: Duty cycle = 0.496 ms/0.513 ms = 0.967, Duty factor = $10 * \log(1/0.967) = 0.15$

16QAM: Duty cycle = 0.268 ms/0.283 ms = 0.947, Duty factor = $10 * \log(1/0.947) = 0.24$

64QAM: Duty cycle = 0.155 ms/0.173 ms = 0.896, Duty factor = $10 * \log(1/0.896) = 0.48$

256QAM: Duty cycle = 0.116 ms/0.13 ms = 0.872, Duty factor = $10 * \log(1/0.872) = 0.59$

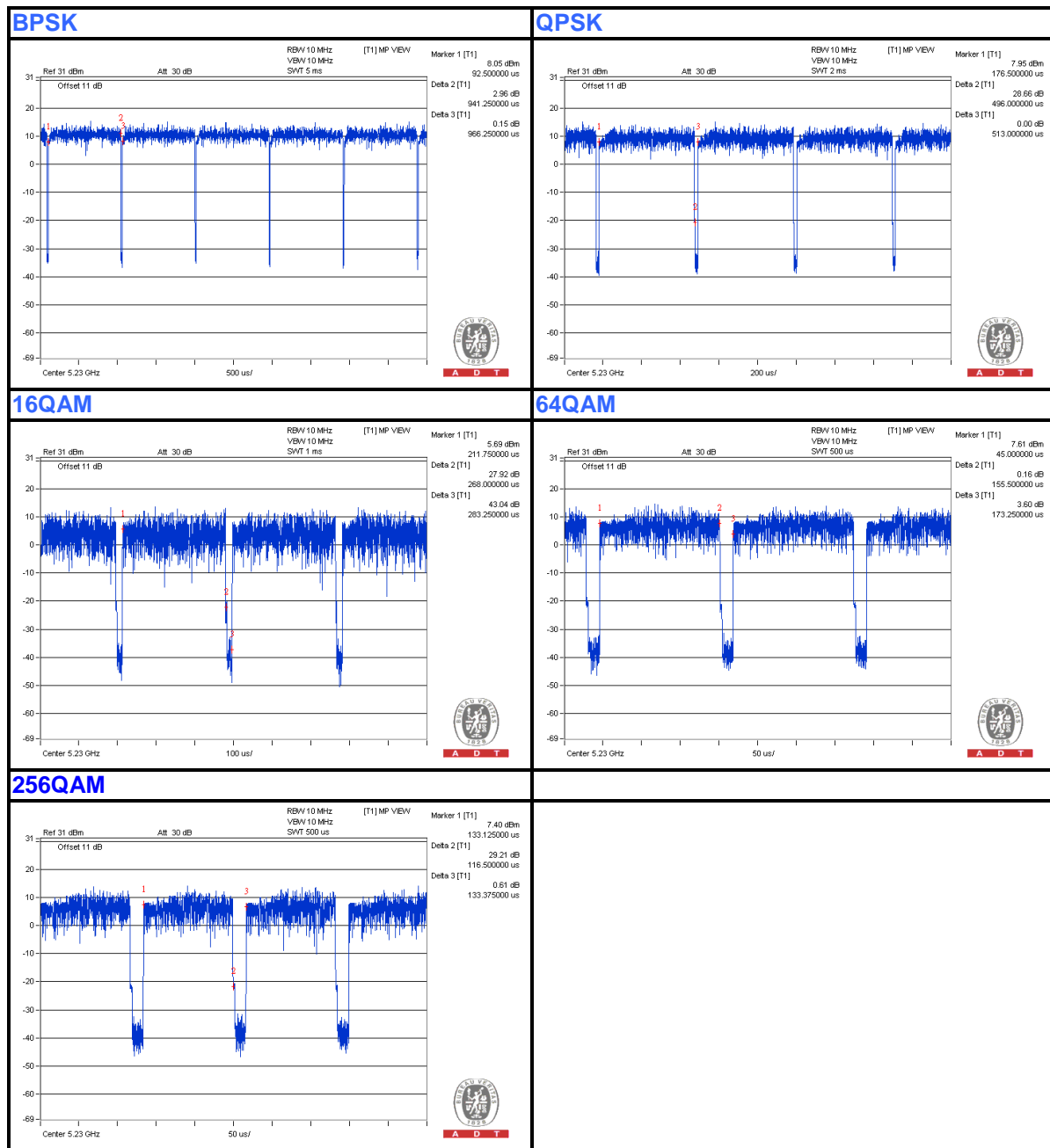



A D T

802.11ac (VHT80)

BPSK: Duty cycle = 0.461 ms/0.478 ms = 0.964, Duty factor = $10 * \log(1/0.964) = 0.16$

QPSK: Duty cycle = 0.254 ms/0.27 ms = 0.941, Duty factor = $10 * \log(1/0.941) = 0.27$

16QAM: Duty cycle = 0.15 ms/0.168 ms = 0.893, Duty factor = $10 * \log(1/0.893) = 0.49$

64QAM: Duty cycle = 0.097 ms/0.112 ms = 0.866, Duty factor = $10 * \log(1/0.866) = 0.62$

256QAM: Duty cycle = 0.075 ms/0.09 ms = 0.806, Duty factor = $10 * \log(1/0.806) = 0.93$

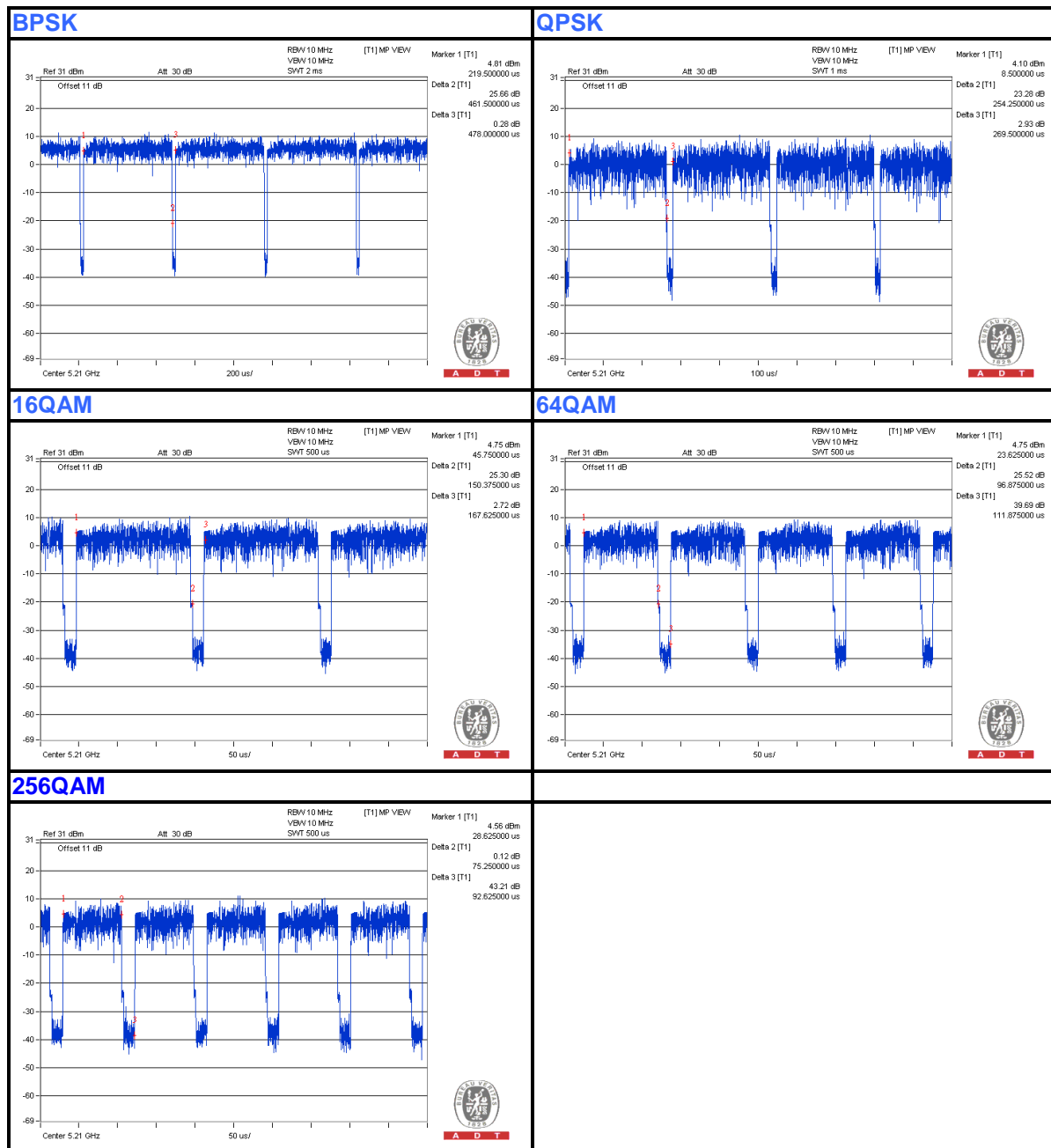



A D T

3.5 DESCRIPTION OF SUPPORT UNITS

The EUT has been tested as an independent unit together with other necessary accessories or support units. The following support units or accessories were used to form a representative test configuration during the tests.

NO.	PRODUCT	BRAND	MODEL NO.	SERIAL NO.	FCC ID
1	NOTEBOOK COMPUTER	DELL	PP27L	7YLB32S	FCC DoC
2	NOTEBOOK COMPUTER	DELL	E6420	482T3R1	FCC DoC
3	HUB	ZyXEL	ES-116P	S060H02000215	FCC DoC
4	3G/LTE USB Dongle	SIERRA WIRELESS	MC7750	NA	N7NMC7750
5	3G USB Dongle	SIERRA WIRELESS	AirCard 595U	NA	N7N-MC5725U
6	3G USB Dongle	HUAWEI	E219	NA	QISE219

NO.	SIGNAL CABLE DESCRIPTION OF THE ABOVE SUPPORT UNITS
1	UTP cable (10m)
2	UTP cable (10m)
3	UTP cable (10m)
4	NA
5	NA
6	3G USB Dongle cable(0.18m)

NOTE: All power cords of the above support units are non shielded (1.8m).

3.6 CONFIGURATION OF SYSTEM UNDER TEST

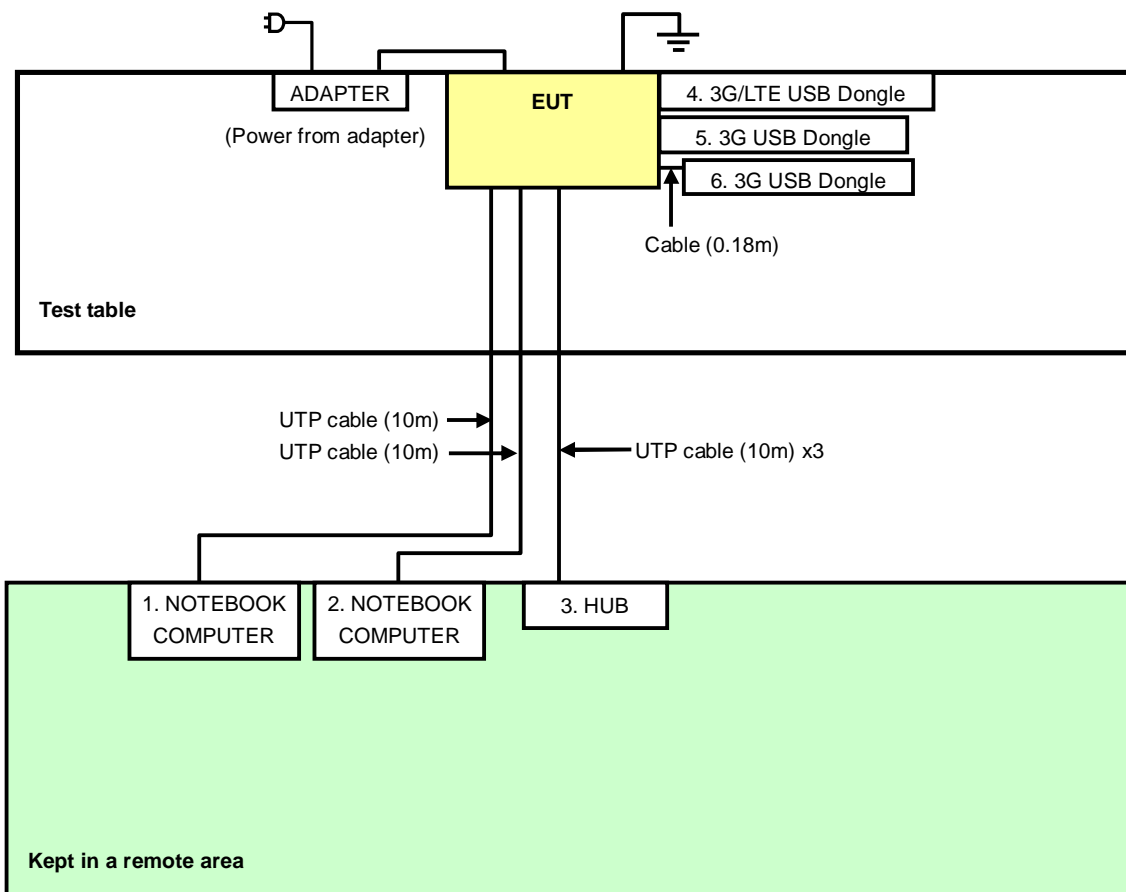



A D T

4. TEST TYPES AND RESULTS

4.1 CONDUCTED EMISSION MEASUREMENT

4.1.1 LIMITS OF CONDUCTED EMISSION MEASUREMENT

FREQUENCY OF EMISSION (MHz)	CONDUCTED LIMIT (dB μ V)	
	Quasi-peak	Average
0.15-0.5	66 to 56	56 to 46
0.5-5	56	46
5-30	60	50

- NOTE:** 1. The lower limit shall apply at the transition frequencies.
2. The limit decreases in line with the logarithm of the frequency in the range of 0.15 to 0.50 MHz.

4.1.2 TEST INSTRUMENTS

For test mode 1

DESCRIPTION & MANUFACTURER	MODEL NO.	SERIAL NO.	CALIBRATED DATE	CALIBRATED UNTIL
Test Receiver ROHDE & SCHWARZ	ESCS 30	100287	Feb. 28, 2013	Feb. 27, 2014
Line-Impedance Stabilization Network (for EUT) ROHDE & SCHWARZ	ENV216	100071	Nov. 09, 2012	Nov. 08, 2013
Line-Impedance Stabilization Network (for Peripheral) ROHDE & SCHWARZ	ESH3-Z5	8487731004	Oct. 29, 2012	Oct. 28, 2013
RF Cable (JYEBAO)	5DFB	COACAB-001	May 27, 2013	May 26, 2014
50 ohms Terminator	50	3	Oct. 23, 2012	Oct. 22, 2013
50 ohms Terminator	N/A	EMC-04	Oct. 16, 2012	Oct. 15, 2013
Software ADT	BV ADT_Cond_V7.3.7 .3	NA	NA	NA

Note:

1. The calibration interval of the above test instruments is 12 months and the calibrations are traceable to NML/ROC and NIST/USA.
2. The test was performed in Shielded Room No. A.
3. The VCCI Con A Registration No. is C-817.
4. Tested Date: Sep. 16, 2013



A D T

For test mode 2

DESCRIPTION & MANUFACTURER	MODEL NO.	SERIAL NO.	CALIBRATED DATE	CALIBRATED UNTIL
Test Receiver ROHDE & SCHWARZ	ESCS 30	100375	Mar. 08, 2013	Mar. 07, 2014
Line-Impedance Stabilization Network (for EUT) SCHWARZBECK	NSLK8127	8127-522	Sep. 05, 2013	Sep. 04, 2014
Line-Impedance Stabilization Network (for Peripheral)	ENV216	100072	June 06,2013	June 05,2014
RF Cable (JYEBAO)	5DFB	COCCAB-001	Mar. 11, 2013	Mar. 10, 2014
50 ohms Terminator	50	EMC-03	Sep. 24, 2013	Sep. 23, 2014
Software ADT	BV ADT_Cond_V7.3.7. 3	NA	NA	NA

Note:

1. The calibration interval of the above test instruments is 12 months and the calibrations are traceable to NML/ROC and NIST/USA.
2. The test was performed in Shielded Room No. C.
3. The VCCI Con C Registration No. is C-3611.
4. Tested Date: Oct. 21, 2013

4.1.3 TEST PROCEDURES

- a. The EUT was placed 0.4 meters from the conducting wall of the shielded room with EUT being connected to the power mains through a line impedance stabilization network (LISN). Other support units were connected to the power mains through another LISN.
- b. The two LISNs provide 50 ohm/ 50uH of coupling impedance for the measuring instrument.
- c. Both lines of the power mains connected to the EUT were checked for maximum conducted interference.
- d. The frequency range from 150kHz to 30MHz was searched. Emission level under (Limit – 20dB) was not recorded.

NOTE:

1. The resolution bandwidth of test receiver is 9kHz for Quasi-peak detection (QP) & Average detection (AV).

4.1.4 DEVIATION FROM TEST STANDARD

No deviation

4.1.5 TEST SETUP

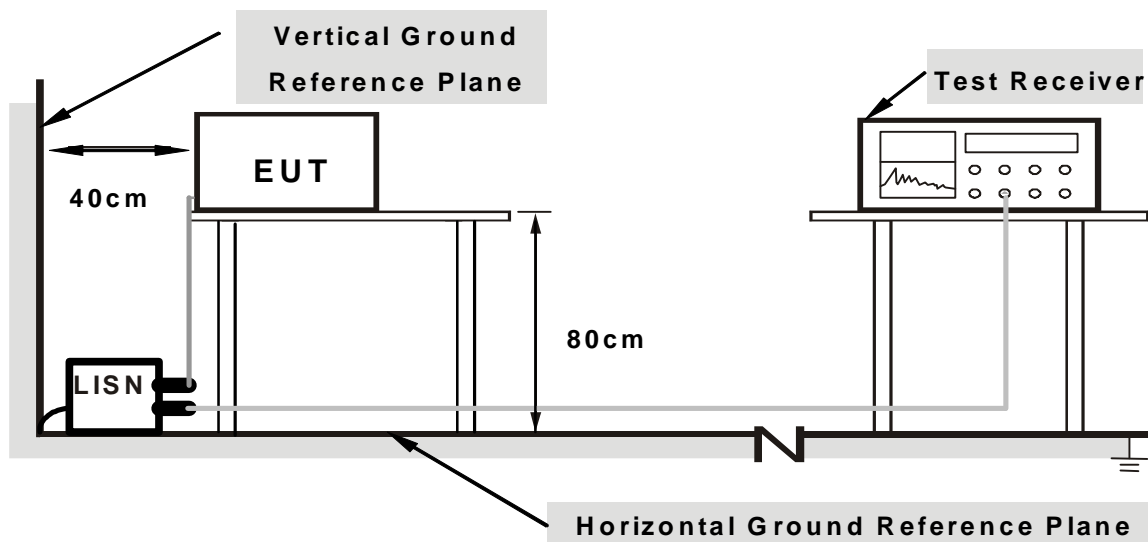

Note: 1.Support units were connected to second LISN.

For the actual test configuration, please refer to the related item – Photographs of the Test Configuration.

4.1.6 EUT OPERATING CONDITIONS

1. Placed the EUT on testing table.
2. Prepared computer system (support units 1 ~ 2) to act as communication partner.
3. The communication partner ran test program “Mtool” to enable EUT under transmission/receiving condition continuously.

4.1.7 TEST RESULTS(Mode 1)

PHASE	Line (L)	DETECTOR FUNCTION	Quasi-Peak (QP) / Average (AV)
--------------	----------	--------------------------	--------------------------------

No	Freq. [MHz]	Corr. Factor (dB)	Reading Value [dB (uV)]		Emission Level [dB (uV)]		Limit [dB (uV)]		Margin (dB)	
			Q.P.	AV.	Q.P.	AV.	Q.P.	AV.	Q.P.	AV.
1	0.18125	9.76	38.47	27.95	48.23	37.71	64.43	54.43	-16.20	-16.72
2	0.36484	9.79	31.65	18.77	41.44	28.56	58.62	48.62	-17.17	-20.05
3	0.43516	9.80	31.72	18.18	41.52	27.98	57.15	47.15	-15.63	-19.17
4	0.98594	9.82	22.98	9.47	32.80	19.29	56.00	46.00	-23.20	-26.71
5	1.63672	9.84	23.88	10.80	33.72	20.64	56.00	46.00	-22.28	-25.36
6	10.03125	10.03	18.79	8.38	28.82	18.41	60.00	50.00	-31.18	-31.59

REMARKS:

1. Q.P. and AV. are abbreviations of quasi-peak and average individually.
2. The emission levels of other frequencies were very low against the limit.
3. Margin value = Emission Level – Limit value
4. Correction Factor = Insertion loss + Cable loss
5. Emission Level = Correction Factor + Reading Value

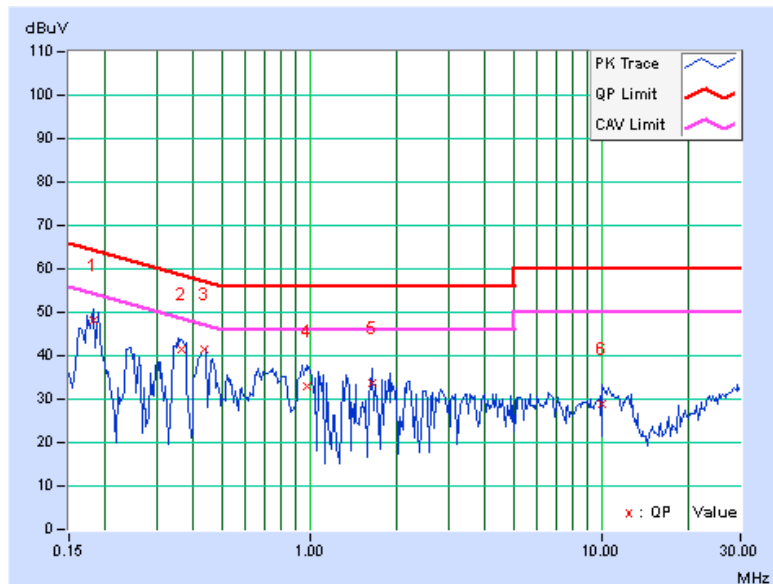

PHASE	Neutral (N)	DETECTOR FUNCTION	Quasi-Peak (QP) / Average (AV)
--------------	-------------	--------------------------	--------------------------------

No	Freq.	Corr.	Reading Value		Emission Level		Limit		Margin	
	[MHz]	(dB)	Q.P.	AV.	Q.P.	AV.	Q.P.	AV.	Q.P.	AV.
1	0.18516	9.75	38.76	27.71	48.51	37.46	64.25	54.25	-15.74	-16.79
2	0.36484	9.79	31.28	19.08	41.07	28.87	58.62	48.62	-17.55	-19.75
3	0.43906	9.80	31.66	18.50	41.46	28.30	57.08	47.08	-15.62	-18.78
4	1.33594	9.83	25.53	12.94	35.36	22.77	56.00	46.00	-20.64	-23.23
5	1.93750	9.85	23.62	9.96	33.47	19.81	56.00	46.00	-22.53	-26.19
6	28.73438	10.40	17.44	11.92	27.84	22.32	60.00	50.00	-32.16	-27.68

REMARKS:

1. Q.P. and AV. are abbreviations of quasi-peak and average individually.
2. The emission levels of other frequencies were very low against the limit.
3. Margin value = Emission Level – Limit value
4. Correction Factor = Insertion loss + Cable loss
5. Emission Level = Correction Factor + Reading Value

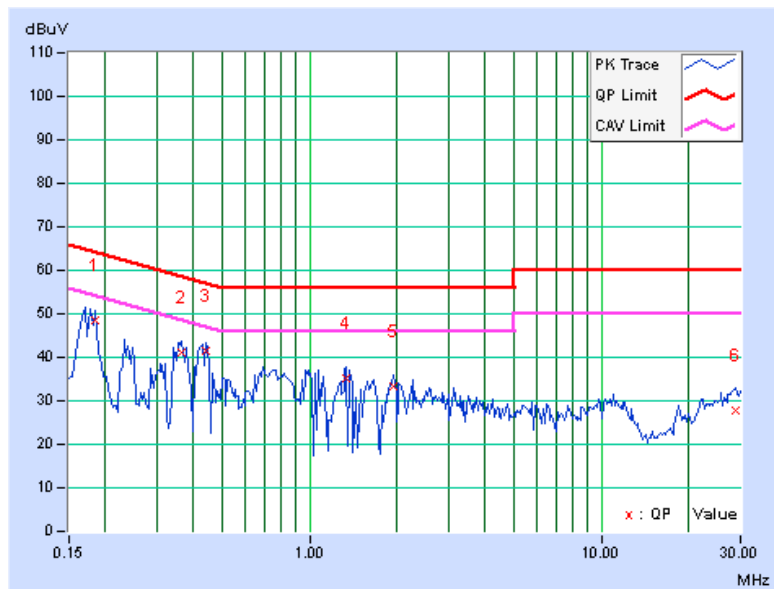

4.1.8 TEST RESULTS(Mode 2)

PHASE	Line (L)	DETECTOR FUNCTION	Quasi-Peak (QP) / Average (AV)
-------	----------	-------------------	--------------------------------

No	Freq. [MHz]	Corr. Factor (dB)	Reading Value [dB (uV)]		Emission Level [dB (uV)]		Limit [dB (uV)]		Margin (dB)	
			Q.P.	AV.	Q.P.	AV.	Q.P.	AV.	Q.P.	AV.
1	0.44297	0.14	42.98	42.12	43.12	42.26	57.01	47.01	-13.88	-4.74
2	0.47031	0.14	45.22	44.49	45.36	44.63	56.51	46.51	-11.14	-1.87
3	0.48594	0.14	41.13	30.89	41.27	31.03	56.24	46.24	-14.96	-15.20
4	0.82969	0.16	37.09	33.61	37.25	33.77	56.00	46.00	-18.75	-12.23
5	0.99766	0.17	34.72	30.54	34.89	30.71	56.00	46.00	-21.11	-15.29
6	1.41406	0.19	35.10	31.54	35.29	31.73	56.00	46.00	-20.71	-14.27

REMARKS:

1. Q.P. and AV. are abbreviations of quasi-peak and average individually.
2. The emission levels of other frequencies were very low against the limit.
3. Margin value = Emission Level – Limit value
4. Correction Factor = Insertion loss + Cable loss
5. Emission Level = Correction Factor + Reading Value

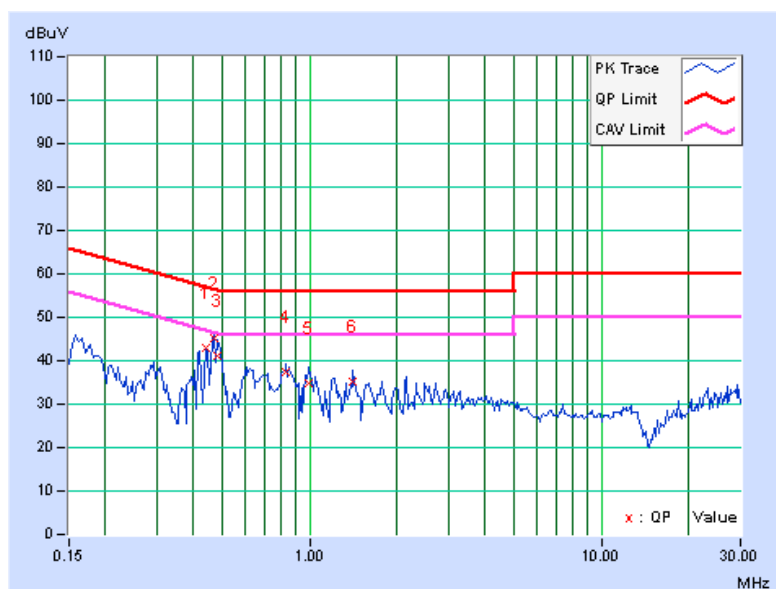

PHASE	Neutral (N)	DETECTOR FUNCTION	Quasi-Peak (QP) / Average (AV)
--------------	-------------	--------------------------	--------------------------------

No	Freq.	Corr.	Reading Value		Emission Level		Limit		Margin	
	[MHz]	(dB)	Q.P.	AV.	Q.P.	AV.	Q.P.	AV.	Q.P.	AV.
1	0.44244	0.14	42.65	42.61	42.79	42.75	57.02	47.02	-14.22	-4.26
2	0.47031	0.14	43.96	43.86	44.10	44.00	56.51	46.51	-12.40	-2.50
3	0.48594	0.14	40.99	34.83	41.13	34.97	56.24	46.24	-15.10	-11.26
4	0.62656	0.15	36.73	34.88	36.88	35.03	56.00	46.00	-19.12	-10.97
5	0.83359	0.16	37.32	34.29	37.48	34.45	56.00	46.00	-18.52	-11.55
6	0.99375	0.17	35.49	31.58	35.66	31.75	56.00	46.00	-20.34	-14.25

REMARKS:

1. Q.P. and AV. are abbreviations of quasi-peak and average individually.
2. The emission levels of other frequencies were very low against the limit.
3. Margin value = Emission Level – Limit value
4. Correction Factor = Insertion loss + Cable loss
5. Emission Level = Correction Factor + Reading Value

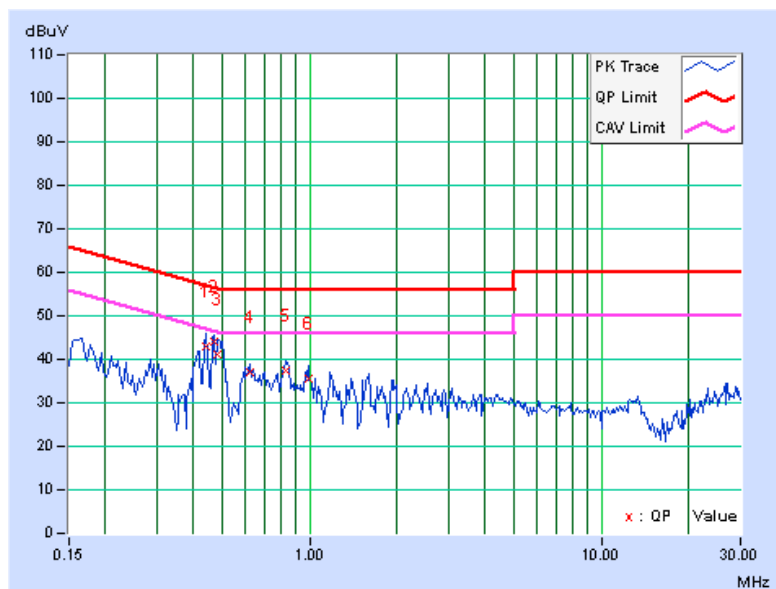



4.2 RADIATED EMISSION AND BANDEDGE MEASUREMENT

4.2.1 LIMITS OF RADIATED EMISSION AND BANDEDGE MEASUREMENT

Radiated emissions which fall in the restricted bands must comply with the radiated emission limits specified as below table:

Frequencies (MHz)	Field strength (microvolts/meter)	Measurement distance (meters)
0.009-0.490	2400/F(kHz)	300
0.490-1.705	24000/F(kHz)	30
1.705-30.0	30	30
30-88	100	3
88-216	150	3
216-960	200	3
Above 960	500	3

NOTE:

1. The lower limit shall apply at the transition frequencies.
2. Emission level (dBuV/m) = 20 log Emission level (uV/m).
3. For frequencies above 1000MHz, the field strength limits are based on average detector, however, the peak field strength of any emission shall not exceed the maximum permitted average limits, specified above by more than 20dB.

4.2.2 LIMITS OF UNWANTED EMISSION OUT OF THE RESTRICTED BANDS

APPLICABLE TO	LIMIT	
√	FIELD STRENGTH AT 3m (dBμV/m)	
	PK	AV
	74	54
-	EIRP LIMIT (dBm)	EQUIVALENT FIELD STRENGTH AT 3m (dBμV/m)
	PK	PK
	-27	68.3

NOTE:

1. The following formula is used to convert the equipment isotropic radiated power (eirp) to field strength:

$$E = \frac{1000000\sqrt{30P}}{3} \mu\text{V/m, where P is the eirp (Watts).$$



A D T

4.2.3 TEST INSTRUMENTS

DESCRIPTION & MANUFACTURER	MODEL NO.	SERIAL NO.	CALIBRATED DATE	CALIBRATED UNTIL
MXE EMI Receiver Agilent	N9038A	MY50010156	Jan. 16, 2013	Jan. 15, 2014
Pre-Amplifier Mini-Circuits	ZFL-1000VH2 B	AMP-ZFL-04	Nov. 14, 2012	Nov. 13, 2013
Trilog Broadband Antenna SCHWARZBECK	VULB 9168	9168-361	Mar. 25, 2013	Mar. 24, 2014
RF Cable	NA	CHHCAB_001	Oct. 07, 2012	Oct. 06, 2013
Horn_Antenna AISI	AIH.8018	0000220091110	Nov. 27, 2012	Nov. 26, 2013
Pre-Amplifier Agilent	8449B	3008A01923	Oct. 30, 2012	Oct. 29, 2013
RF Cable	NA	RF104-205 RF104-207 RF104-202	Dec. 26, 2012	Dec. 25, 2013
Spectrum Analyzer Agilent	E4446A	MY48250253	Aug. 28, 2013	Aug. 27, 2014
Pre-Amplifier SPACEK LABS	SLKka-48-6	9K16	Nov. 14, 2012	Nov. 13, 2013
Horn_Antenna SCHWARZBECK	BBHA 9170	9170-424	Oct. 12, 2012	Oct. 11, 2013
Software	ADT_Radiated _V8.7.07	NA	NA	NA
Antenna Tower & Turn Table CT	NA	NA	NA	NA

Note:

1. The calibration interval of the above test instruments is 12 months and the calibrations are traceable to NML/ROC and NIST/USA.
2. The horn antenna, preamplifier (model: 8449B) are used only for the measurement of emission frequency above 1GHz if tested.
- 3 The test was performed in 966 Chamber No. H.
4. The FCC Site Registration No. is 797305.
- 5 The CANADA Site Registration No. is IC 7450H-3.
- 6 Tested Date: Sep. 23 to 25, 2013

4.2.4 TEST PROCEDURES

- a. The EUT was placed on the top of a rotating table 0.8 meters above the ground at 3 meter chamber room for test. The table was rotated 360 degrees to determine the position of the highest radiation.
- b. The EUT was set 3 meters away from the interference-receiving antenna, which was mounted on the top of a variable-height antenna tower.
- c. The height of antenna is varied from one meter to four meters above the ground to determine the maximum value of the field strength. Both horizontal and vertical polarizations of the antenna are set to make the measurement.
- d. For each suspected emission, the EUT was arranged to its worst case and then the antenna was tuned to heights from 1 meter to 4 meters and the rotatable table was turned from 0 degrees to 360 degrees to find the maximum reading.
- e. The test-receiver system was set to quasi-peak detect function and specified bandwidth with maximum hold mode when the test frequency is below 1 GHz.
- f. The test-receiver system was set to peak and average detect function and specified bandwidth with maximum hold mode when the test frequency is above 1 GHz. If the peak reading value also meets average limit, measurement with the average detector is unnecessary.

NOTE:

1. The resolution bandwidth and video bandwidth of test receiver/spectrum analyzer is 120kHz for Quasi-peak detection (QP) at frequency below 1GHz.
2. The resolution bandwidth of test receiver/spectrum analyzer is 1 MHz and the video bandwidth is 3 MHz for Peak detection (PK) at frequency above 1GHz.
3. The resolution bandwidth of test receiver/spectrum analyzer is 1 MHz and the video bandwidth is 10 Hz for Average detection (AV) at frequency above 1GHz.
4. If the EUT transiting at duty cycle is < 98%, the duty cycle correction is required that emission.
5. All modes of operation were investigated and the worst-case emissions are reported.

4.2.5 DEVIATION FROM TEST STANDARD

No deviation

4.2.6 TEST SETUP

<Frequency Range below 1GHz>

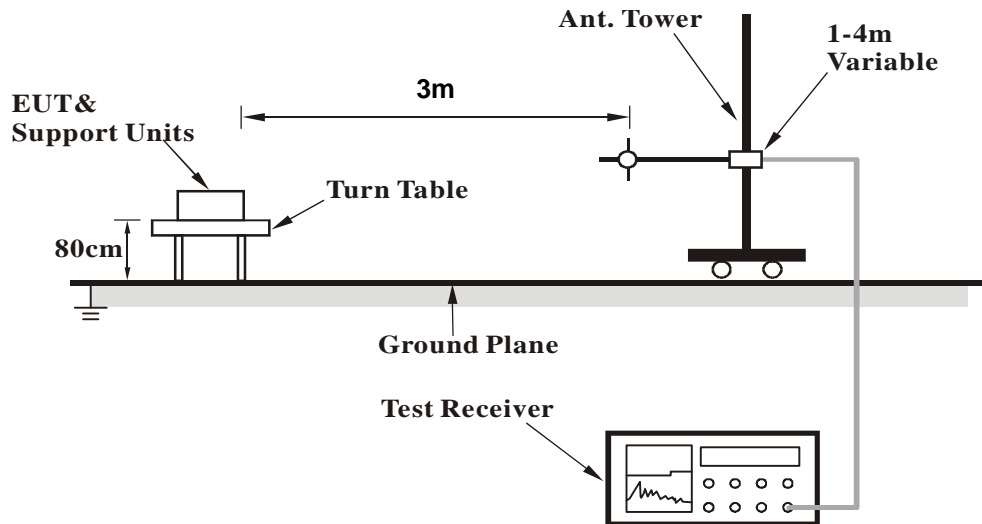

<Frequency Range above 1GHz>

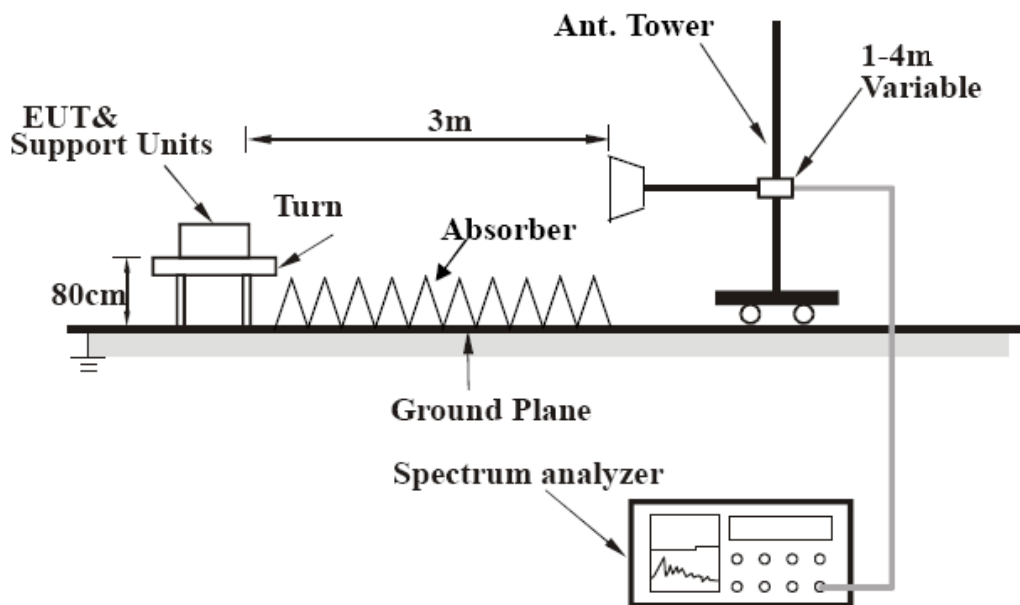

For the actual test configuration, please refer to the related item – Photographs of the Test Configuration.

4.2.7 EUT OPERATING CONDITION

Same as 4.1.6



A D T

4.2.8 TEST RESULTS

BELOW 1GHz WORST-CASE DATA

802.11ac (VHT40)

CHANNEL	TX Channel 38	DETECTOR FUNCTION	Quasi-Peak (QP)
FREQUENCY RANGE	Below 1GHz		

ANTENNA POLARITY & TEST DISTANCE: HORIZONTAL AT 3 M

NO.	FREQ. (MHz)	EMISSION LEVEL (dBuV/m)	LIMIT (dBuV/m)	MARGIN (dB)	ANTENNA HEIGHT (m)	TABLE ANGLE (Degree)	RAW VALUE (dBuV)	CORRECTION FACTOR (dB/m)
1	54.35	29.9 QP	40.0	-10.1	1.12 H	246	42.80	-12.87
2	85.00	31.3 QP	40.0	-8.7	2.00 H	228	50.29	-19.03
3	151.54	35.6 QP	43.5	-7.9	1.00 H	248	48.54	-12.96
4	199.31	35.1 QP	43.5	-8.4	1.00 H	140	51.46	-16.34
5	297.04	30.3 QP	46.0	-15.8	1.00 H	230	42.56	-12.31
6	480.03	38.9 QP	46.0	-7.2	2.00 H	118	46.88	-8.03

ANTENNA POLARITY & TEST DISTANCE: VERTICAL AT 3 M

NO.	FREQ. (MHz)	EMISSION LEVEL (dBuV/m)	LIMIT (dBuV/m)	MARGIN (dB)	ANTENNA HEIGHT (m)	TABLE ANGLE (Degree)	RAW VALUE (dBuV)	CORRECTION FACTOR (dB/m)
1	37.78	31.2 QP	40.0	-8.8	1.01 V	214	44.93	-13.72
2	62.54	37.5 QP	40.0	-2.5	1.00 V	252	51.34	-13.84
3	85.53	36.6 QP	40.0	-3.4	1.50 V	263	55.64	-19.06
4	197.86	35.6 QP	43.5	-7.9	1.00 V	158	51.79	-16.19
5	480.03	33.8 QP	46.0	-12.2	1.00 V	25	41.87	-8.03
6	500.01	33.4 QP	46.0	-12.6	1.00 V	283	40.93	-7.53

REMARKS:

1. Emission Level(dBuV/m) = Raw Value(dBuV) + Correction Factor(dB/m)
2. Correction Factor(dB/m) = Antenna Factor(dB/m) + Cable Factor(dB)
– Pre-Amplifier Factor(dB)
3. The other emission levels were very low against the limit.
4. Margin value = Emission Level – Limit value



A D T

ABOVE 1GHz DATA

802.11a

CHANNEL	TX Channel 36	DETECTOR FUNCTION	Peak (PK)
FREQUENCY RANGE	1GHz ~ 40GHz		Average (AV)

ANTENNA POLARITY & TEST DISTANCE: HORIZONTAL AT 3 M

NO.	FREQ. (MHz)	EMISSION LEVEL (dBuV/m)	LIMIT (dBuV/m)	MARGIN (dB)	ANTENNA HEIGHT (m)	TABLE ANGLE (Degree)	RAW VALUE (dBuV)	CORRECTION FACTOR (dB/m)
1	5098.00	54.9 PK	74.0	-19.1	1.00 H	222	12.79	42.11
2	5098.00	45.3 AV	54.0	-8.7	1.00 H	222	3.19	42.11
3	5150.00	54.2 PK	74.0	-19.8	1.00 H	222	11.95	42.25
4	5150.00	42.9 AV	54.0	-11.1	1.00 H	222	0.65	42.25
5	*5180.00	105.5 PK			1.00 H	222	63.17	42.33
6	*5180.00	96.0 AV			1.00 H	222	53.67	42.33
7	#10360.00	59.4 PK	74.0	-14.6	1.29 H	204	10.41	48.99
8	#10360.00	46.6 AV	54.0	-7.4	1.29 H	204	-2.39	48.99
9	15540.00	60.5 PK	74.0	-13.5	1.00 H	169	5.78	54.72
10	15540.00	48.3 AV	54.0	-5.7	1.00 H	169	-6.42	54.72

ANTENNA POLARITY & TEST DISTANCE: VERTICAL AT 3 M

NO.	FREQ. (MHz)	EMISSION LEVEL (dBuV/m)	LIMIT (dBuV/m)	MARGIN (dB)	ANTENNA HEIGHT (m)	TABLE ANGLE (Degree)	RAW VALUE (dBuV)	CORRECTION FACTOR (dB/m)
1	5021.00	56.9 PK	74.0	-17.1	1.08 V	178	14.91	41.99
2	5021.00	44.3 AV	54.0	-9.7	1.08 V	178	2.31	41.99
3	5107.00	63.1 PK	74.0	-10.9	1.08 V	178	20.97	42.13
4	5107.00	53.5 AV	54.0	-0.5	1.08 V	178	11.37	42.13
5	5150.00	73.0 PK	74.0	-1.0	1.08 V	178	30.75	42.25
6	5150.00	48.0 AV	54.0	-6.0	1.08 V	178	5.75	42.25
7	*5180.00	112.1 PK			1.08 V	178	69.77	42.33
8	*5180.00	101.7 AV			1.08 V	178	59.37	42.33
9	#10360.00	58.1 PK	74.0	-15.9	1.35 V	236	9.11	48.99
10	#10360.00	46.2 AV	54.0	-7.8	1.35 V	236	-2.79	48.99
11	15540.00	60.2 PK	74.0	-13.8	1.13 V	228	5.48	54.72
12	15540.00	48.0 AV	54.0	-6.0	1.13 V	228	-6.72	54.72

REMARKS:

1. Emission Level(dBuV/m) = Raw Value(dBuV) + Correction Factor(dB/m)
2. Correction Factor(dB/m) = Antenna Factor(dB/m) + Cable Factor(dB) – Pre-Amplifier Factor(dB)
3. The other emission levels were very low against the limit.
4. Margin value = Emission Level – Limit value
5. " * ": Fundamental frequency.
6. " # ": The radiated frequency is out of the restricted band.



A D T

CHANNEL	TX Channel 40	DETECTOR FUNCTION	Peak (PK)
FREQUENCY RANGE	1GHz ~ 40GHz		Average (AV)

ANTENNA POLARITY & TEST DISTANCE: HORIZONTAL AT 3 M

NO.	FREQ. (MHz)	EMISSION LEVEL (dBuV/m)	LIMIT (dBuV/m)	MARGIN (dB)	ANTENNA HEIGHT (m)	TABLE ANGLE (Degree)	RAW VALUE (dBuV)	CORRECTION FACTOR (dB/m)
1	*5200.00	105.0 PK			1.01 H	207	62.61	42.39
2	*5200.00	95.7 AV			1.01 H	207	53.31	42.39
3	#10400.00	59.1 PK	74.0	-14.9	1.28 H	198	10.43	48.67
4	#10400.00	46.2 AV	54.0	-7.8	1.28 H	198	-2.47	48.67
5	15600.00	60.2 PK	74.0	-13.8	1.03 H	168	5.54	54.66
6	15600.00	48.1 AV	54.0	-5.9	1.03 H	168	-6.56	54.66

ANTENNA POLARITY & TEST DISTANCE: VERTICAL AT 3 M

NO.	FREQ. (MHz)	EMISSION LEVEL (dBuV/m)	LIMIT (dBuV/m)	MARGIN (dB)	ANTENNA HEIGHT (m)	TABLE ANGLE (Degree)	RAW VALUE (dBuV)	CORRECTION FACTOR (dB/m)
1	5119.11	62.0 PK	74.0	-12.0	1.02 V	198	19.84	42.16
2	5119.11	52.5 AV	54.0	-1.5	1.02 V	198	10.34	42.16
3	*5200.00	109.9 PK			1.00 V	199	67.51	42.39
4	*5200.00	101.0 AV			1.00 V	199	58.61	42.39
5	#10400.00	57.7 PK	74.0	-16.3	1.40 V	236	9.03	48.67
6	#10400.00	46.0 AV	54.0	-8.0	1.40 V	236	-2.67	48.67
7	15600.00	59.8 PK	74.0	-14.2	1.09 V	220	5.14	54.66
8	15600.00	47.9 AV	54.0	-6.1	1.09 V	220	-6.76	54.66

REMARKS:

1. Emission Level(dBuV/m) = Raw Value(dBuV) + Correction Factor(dB/m)
2. Correction Factor(dB/m) = Antenna Factor(dB/m) + Cable Factor(dB) – Pre-Amplifier Factor(dB)
3. The other emission levels were very low against the limit.
4. Margin value = Emission Level – Limit value
5. " * ": Fundamental frequency.
6. " # ": The radiated frequency is out of the restricted band.



A D T

CHANNEL	TX Channel 48	DETECTOR FUNCTION	Peak (PK)
FREQUENCY RANGE	1GHz ~ 40GHz		Average (AV)

ANTENNA POLARITY & TEST DISTANCE: HORIZONTAL AT 3 M

NO.	FREQ. (MHz)	EMISSION LEVEL (dBuV/m)	LIMIT (dBuV/m)	MARGIN (dB)	ANTENNA HEIGHT (m)	TABLE ANGLE (Degree)	RAW VALUE (dBuV)	CORRECTION FACTOR (dB/m)
1	*5240.00	105.1 PK			1.02 H	227	62.67	42.43
2	*5240.00	95.8 AV			1.02 H	227	53.37	42.43
3	5401.12	54.0 PK	74.0	-20.0	1.03 H	216	11.47	42.53
4	5401.12	42.5 AV	54.0	-11.5	1.03 H	216	-0.03	42.53
5	#10480.00	59.5 PK	74.0	-14.5	1.24 H	196	10.37	49.13
6	#10480.00	46.9 AV	54.0	-7.1	1.24 H	196	-2.23	49.13
7	15720.00	60.7 PK	74.0	-13.3	1.00 H	153	6.64	54.06
8	15720.00	48.7 AV	54.0	-5.3	1.00 H	153	-5.36	54.06

ANTENNA POLARITY & TEST DISTANCE: VERTICAL AT 3 M

NO.	FREQ. (MHz)	EMISSION LEVEL (dBuV/m)	LIMIT (dBuV/m)	MARGIN (dB)	ANTENNA HEIGHT (m)	TABLE ANGLE (Degree)	RAW VALUE (dBuV)	CORRECTION FACTOR (dB/m)
1	*5240.00	110.4 PK			1.00 V	189	67.97	42.43
2	*5240.00	101.2 AV			1.00 V	189	58.77	42.43
3	5401.12	57.6 PK	74.0	-16.4	1.00 V	265	15.07	42.53
4	5401.12	45.4 AV	54.0	-8.6	1.00 V	265	2.87	42.53
5	#10480.00	58.2 PK	74.0	-15.8	1.34 V	238	9.07	49.13
6	#10480.00	46.2 AV	54.0	-7.8	1.34 V	238	-2.93	49.13
7	15720.00	59.9 PK	74.0	-14.1	1.17 V	236	5.84	54.06
8	15720.00	47.5 AV	54.0	-6.5	1.17 V	236	-6.56	54.06

REMARKS:

1. Emission Level(dBuV/m) = Raw Value(dBuV) + Correction Factor(dB/m)
2. Correction Factor(dB/m) = Antenna Factor(dB/m) + Cable Factor(dB)
– Pre-Amplifier Factor(dB)
3. The other emission levels were very low against the limit.
4. Margin value = Emission Level – Limit value
5. " * ": Fundamental frequency.
6. " # ": The radiated frequency is out of the restricted band.



A D T

802.11ac (VHT20)

CHANNEL	TX Channel 36	DETECTOR FUNCTION	Peak (PK)
FREQUENCY RANGE	1GHz ~ 40GHz		Average (AV)

ANTENNA POLARITY & TEST DISTANCE: HORIZONTAL AT 3 M

NO.	FREQ. (MHz)	EMISSION LEVEL (dBuV/m)	LIMIT (dBuV/m)	MARGIN (dB)	ANTENNA HEIGHT (m)	TABLE ANGLE (Degree)	RAW VALUE (dBuV)	CORRECTION FACTOR (dB/m)
1	5097.52	55.1 PK	74.0	-18.9	1.04 H	230	12.99	42.11
2	5097.52	45.4 AV	54.0	-8.6	1.04 H	230	3.29	42.11
3	*5180.00	107.7 PK			1.04 H	234	65.37	42.33
4	*5180.00	98.1 AV			1.04 H	234	55.77	42.33
5	#10360.00	59.5 PK	74.0	-14.5	1.33 H	195	10.51	48.99
6	#10360.00	46.9 AV	54.0	-7.1	1.33 H	195	-2.09	48.99
7	15540.00	60.8 PK	74.0	-13.2	1.00 H	171	6.08	54.72
8	15540.00	48.7 AV	54.0	-5.3	1.00 H	171	-6.02	54.72

ANTENNA POLARITY & TEST DISTANCE: VERTICAL AT 3 M

NO.	FREQ. (MHz)	EMISSION LEVEL (dBuV/m)	LIMIT (dBuV/m)	MARGIN (dB)	ANTENNA HEIGHT (m)	TABLE ANGLE (Degree)	RAW VALUE (dBuV)	CORRECTION FACTOR (dB/m)
1	5097.52	63.8 PK	74.0	-10.2	1.00 V	323	21.69	42.11
2	5097.52	53.7 AV	54.0	-0.3	1.00 V	323	11.59	42.11
3	*5180.00	113.9 PK			1.00 V	326	71.57	42.33
4	*5180.00	104.0 AV			1.00 V	326	61.67	42.33
5	#10360.00	58.2 PK	74.0	-15.8	1.39 V	230	9.21	48.99
6	#10360.00	46.5 AV	54.0	-7.5	1.39 V	230	-2.49	48.99
7	15540.00	60.2 PK	74.0	-13.8	1.15 V	219	5.48	54.72
8	15540.00	47.9 AV	54.0	-6.1	1.15 V	219	-6.82	54.72

REMARKS:

1. Emission Level(dBuV/m) = Raw Value(dBuV) + Correction Factor(dB/m)
2. Correction Factor(dB/m) = Antenna Factor(dB/m) + Cable Factor(dB) – Pre-Amplifier Factor(dB)
3. The other emission levels were very low against the limit.
4. Margin value = Emission Level – Limit value
5. " * ": Fundamental frequency.
6. " # ": The radiated frequency is out of the restricted band.



A D T

CHANNEL	TX Channel 40	DETECTOR FUNCTION	Peak (PK)
FREQUENCY RANGE	1GHz ~ 40GHz		Average (AV)

ANTENNA POLARITY & TEST DISTANCE: HORIZONTAL AT 3 M

NO.	FREQ. (MHz)	EMISSION LEVEL (dBuV/m)	LIMIT (dBuV/m)	MARGIN (dB)	ANTENNA HEIGHT (m)	TABLE ANGLE (Degree)	RAW VALUE (dBuV)	CORRECTION FACTOR (dB/m)
1	*5200.00	107.8 PK			1.01 H	237	65.41	42.39
2	*5200.00	98.3 AV			1.01 H	237	55.91	42.39
3	#10400.00	59.0 PK	74.0	-15.0	1.26 H	218	10.33	48.67
4	#10400.00	46.4 AV	54.0	-7.6	1.26 H	218	-2.27	48.67
5	15600.00	59.7 PK	74.0	-14.3	1.01 H	175	5.04	54.66
6	15600.00	47.8 AV	54.0	-6.2	1.01 H	175	-6.86	54.66

ANTENNA POLARITY & TEST DISTANCE: VERTICAL AT 3 M

NO.	FREQ. (MHz)	EMISSION LEVEL (dBuV/m)	LIMIT (dBuV/m)	MARGIN (dB)	ANTENNA HEIGHT (m)	TABLE ANGLE (Degree)	RAW VALUE (dBuV)	CORRECTION FACTOR (dB/m)
1	5122.30	63.3 PK	74.0	-10.7	1.00 V	327	21.13	42.17
2	5122.30	53.1 AV	54.0	-0.9	1.00 V	327	10.93	42.17
3	*5200.00	114.1 PK			1.00 V	327	71.71	42.39
4	*5200.00	103.8 AV			1.00 V	327	61.41	42.39
5	#10400.00	58.0 PK	74.0	-16.0	1.37 V	228	9.33	48.67
6	#10400.00	46.1 AV	54.0	-7.9	1.37 V	228	-2.57	48.67
7	15600.00	60.6 PK	74.0	-13.4	1.09 V	231	5.94	54.66
8	15600.00	48.2 AV	54.0	-5.8	1.09 V	231	-6.46	54.66

REMARKS:

- Emission Level(dBuV/m) = Raw Value(dBuV) + Correction Factor(dB/m)
- Correction Factor(dB/m) = Antenna Factor(dB/m) + Cable Factor(dB) – Pre-Amplifier Factor(dB)
- The other emission levels were very low against the limit.
- Margin value = Emission Level – Limit value
- " * ": Fundamental frequency.
- " # ": The radiated frequency is out of the restricted band.



A D T

CHANNEL	TX Channel 48	DETECTOR FUNCTION	Peak (PK)
FREQUENCY RANGE	1GHz ~ 40GHz		Average (AV)

ANTENNA POLARITY & TEST DISTANCE: HORIZONTAL AT 3 M

NO.	FREQ. (MHz)	EMISSION LEVEL (dBuV/m)	LIMIT (dBuV/m)	MARGIN (dB)	ANTENNA HEIGHT (m)	TABLE ANGLE (Degree)	RAW VALUE (dBuV)	CORRECTION FACTOR (dB/m)
1	*5240.00	108.1 PK			1.01 H	229	65.67	42.43
2	*5240.00	98.5 AV			1.01 H	229	56.07	42.43
3	5401.96	53.7 PK	74.0	-20.3	1.00 H	213	11.17	42.53
4	5401.96	42.4 AV	54.0	-11.6	1.00 H	213	-0.13	42.53
5	#10480.00	59.5 PK	74.0	-14.5	1.34 H	211	10.37	49.13
6	#10480.00	46.6 AV	54.0	-7.4	1.34 H	211	-2.53	49.13
7	15720.00	60.7 PK	74.0	-13.3	1.00 H	176	6.64	54.06
8	15720.00	48.4 AV	54.0	-5.6	1.00 H	176	-5.66	54.06

ANTENNA POLARITY & TEST DISTANCE: VERTICAL AT 3 M

NO.	FREQ. (MHz)	EMISSION LEVEL (dBuV/m)	LIMIT (dBuV/m)	MARGIN (dB)	ANTENNA HEIGHT (m)	TABLE ANGLE (Degree)	RAW VALUE (dBuV)	CORRECTION FACTOR (dB/m)
1	5082.52	60.5 PK	74.0	-13.5	1.00 V	323	18.42	42.08
2	5082.52	49.9 AV	54.0	-4.1	1.00 V	323	7.82	42.08
3	*5240.00	114.9 PK			1.02 V	325	72.47	42.43
4	*5240.00	105.1 AV			1.02 V	325	62.67	42.43
5	5401.96	60.0 PK	74.0	-14.0	1.00 V	277	17.47	42.53
6	5401.96	48.4 AV	54.0	-5.6	1.00 V	277	5.87	42.53
7	#10480.00	58.0 PK	74.0	-16.0	1.37 V	232	8.87	49.13
8	#10480.00	46.3 AV	54.0	-7.7	1.37 V	232	-2.83	49.13
9	15720.00	60.0 PK	74.0	-14.0	1.10 V	224	5.94	54.06
10	15720.00	47.7 AV	54.0	-6.3	1.10 V	224	-6.36	54.06

REMARKS:

1. Emission Level(dBuV/m) = Raw Value(dBuV) + Correction Factor(dB/m)
2. Correction Factor(dB/m) = Antenna Factor(dB/m) + Cable Factor(dB)
– Pre-Amplifier Factor(dB)
3. The other emission levels were very low against the limit.
4. Margin value = Emission Level – Limit value
5. " * ": Fundamental frequency.
6. " # ": The radiated frequency is out of the restricted band.



A D T

802.11ac (VHT40)

CHANNEL	TX Channel 38	DETECTOR FUNCTION	Peak (PK)
FREQUENCY RANGE	1GHz ~ 40GHz		Average (AV)

ANTENNA POLARITY & TEST DISTANCE: HORIZONTAL AT 3 M

NO.	FREQ. (MHz)	EMISSION LEVEL (dBuV/m)	LIMIT (dBuV/m)	MARGIN (dB)	ANTENNA HEIGHT (m)	TABLE ANGLE (Degree)	RAW VALUE (dBuV)	CORRECTION FACTOR (dB/m)
1	5147.75	53.4 PK	74.0	-20.6	1.00 H	222	11.15	42.25
2	5147.75	42.3 AV	54.0	-11.7	1.00 H	222	0.05	42.25
3	*5190.00	104.5 PK			1.00 H	228	62.14	42.36
4	*5190.00	94.2 AV			1.00 H	228	51.84	42.36
5	#10380.00	59.1 PK	74.0	-14.9	1.23 H	199	10.27	48.83
6	#10380.00	46.6 AV	54.0	-7.4	1.23 H	199	-2.23	48.83
7	15570.00	60.7 PK	74.0	-13.3	1.02 H	160	6.01	54.69
8	15570.00	48.7 AV	54.0	-5.3	1.02 H	160	-5.99	54.69

ANTENNA POLARITY & TEST DISTANCE: VERTICAL AT 3 M

NO.	FREQ. (MHz)	EMISSION LEVEL (dBuV/m)	LIMIT (dBuV/m)	MARGIN (dB)	ANTENNA HEIGHT (m)	TABLE ANGLE (Degree)	RAW VALUE (dBuV)	CORRECTION FACTOR (dB/m)
1	5147.75	65.6 PK	74.0	-8.4	1.00 V	323	23.35	42.25
2	5147.75	53.4 AV	54.0	-0.6	1.00 V	323	11.15	42.25
3	*5190.00	111.4 PK			1.00 V	328	69.04	42.36
4	*5190.00	101.3 AV			1.00 V	328	58.94	42.36
5	#10380.00	57.9 PK	74.0	-16.1	1.40 V	232	9.07	48.83
6	#10380.00	46.2 AV	54.0	-7.8	1.40 V	232	-2.63	48.83
7	15570.00	60.4 PK	74.0	-13.6	1.17 V	225	5.71	54.69
8	15570.00	48.3 AV	54.0	-5.7	1.17 V	225	-6.39	54.69

REMARKS:

1. Emission Level(dBuV/m) = Raw Value(dBuV) + Correction Factor(dB/m)
2. Correction Factor(dB/m) = Antenna Factor(dB/m) + Cable Factor(dB) – Pre-Amplifier Factor(dB)
3. The other emission levels were very low against the limit.
4. Margin value = Emission Level – Limit value
5. " * ": Fundamental frequency.
6. " # ": The radiated frequency is out of the restricted band.



A D T

CHANNEL	TX Channel 46	DETECTOR FUNCTION	Peak (PK)
FREQUENCY RANGE	1GHz ~ 40GHz		Average (AV)

ANTENNA POLARITY & TEST DISTANCE: HORIZONTAL AT 3 M

NO.	FREQ. (MHz)	EMISSION LEVEL (dBuV/m)	LIMIT (dBuV/m)	MARGIN (dB)	ANTENNA HEIGHT (m)	TABLE ANGLE (Degree)	RAW VALUE (dBuV)	CORRECTION FACTOR (dB/m)
1	*5230.00	104.3 PK			1.04 H	218	61.88	42.42
2	*5230.00	94.0 AV			1.04 H	218	51.58	42.42
3	5385.46	53.6 PK	74.0	-20.4	1.00 H	228	11.07	42.53
4	5385.46	42.6 AV	54.0	-11.4	1.00 H	228	0.07	42.53
5	#10460.00	59.6 PK	74.0	-14.4	1.23 H	209	10.59	49.01
6	#10460.00	46.9 AV	54.0	-7.1	1.23 H	209	-2.11	49.01
7	15690.00	61.1 PK	74.0	-12.9	1.00 H	174	7.02	54.08
8	15690.00	48.8 AV	54.0	-5.2	1.00 H	174	-5.28	54.08

ANTENNA POLARITY & TEST DISTANCE: VERTICAL AT 3 M

NO.	FREQ. (MHz)	EMISSION LEVEL (dBuV/m)	LIMIT (dBuV/m)	MARGIN (dB)	ANTENNA HEIGHT (m)	TABLE ANGLE (Degree)	RAW VALUE (dBuV)	CORRECTION FACTOR (dB/m)
1	5147.30	61.8 PK	74.0	-12.2	1.00 V	326	19.55	42.25
2	5147.30	51.4 AV	54.0	-2.6	1.00 V	326	9.15	42.25
3	*5230.00	111.8 PK			1.00 V	325	69.38	42.42
4	*5230.00	102.1 AV			1.00 V	325	59.68	42.42
5	5385.46	58.3 PK	74.0	-15.7	1.00 V	266	15.77	42.53
6	5385.46	46.5 AV	54.0	-7.5	1.00 V	266	3.97	42.53
7	#10460.00	58.7 PK	74.0	-15.3	1.30 V	226	9.69	49.01
8	#10460.00	46.5 AV	54.0	-7.5	1.30 V	226	-2.51	49.01
9	15690.00	59.9 PK	74.0	-14.1	1.13 V	223	5.82	54.08
10	15690.00	47.8 AV	54.0	-6.2	1.13 V	223	-6.28	54.08

REMARKS:

1. Emission Level(dBuV/m) = Raw Value(dBuV) + Correction Factor(dB/m)
2. Correction Factor(dB/m) = Antenna Factor(dB/m) + Cable Factor(dB)
– Pre-Amplifier Factor(dB)
3. The other emission levels were very low against the limit.
4. Margin value = Emission Level – Limit value
5. " * ": Fundamental frequency.
6. " # ": The radiated frequency is out of the restricted band.



A D T

802.11ac (VHT80)

CHANNEL	TX Channel 42	DETECTOR FUNCTION	Peak (PK)
FREQUENCY RANGE	1GHz ~ 40GHz		Average (AV)

ANTENNA POLARITY & TEST DISTANCE: HORIZONTAL AT 3 M

NO.	FREQ. (MHz)	EMISSION LEVEL (dBuV/m)	LIMIT (dBuV/m)	MARGIN (dB)	ANTENNA HEIGHT (m)	TABLE ANGLE (Degree)	RAW VALUE (dBuV)	CORRECTION FACTOR (dB/m)
1	5147.43	53.6 PK	74.0	-20.4	1.00 H	224	11.35	42.25
2	5147.43	42.4 AV	54.0	-11.6	1.00 H	224	0.15	42.25
3	*5210.00	100.4 PK			1.03 H	222	58.00	42.40
4	*5210.00	90.3 AV			1.03 H	222	47.90	42.40
5	5366.66	53.3 PK	74.0	-20.7	1.00 H	228	10.78	42.52
6	5366.66	42.2 AV	54.0	-11.8	1.00 H	228	-0.32	42.52
7	#10420.00	59.3 PK	74.0	-14.7	1.23 H	195	10.52	48.78
8	#10420.00	46.5 AV	54.0	-7.5	1.23 H	195	-2.28	48.78
9	15630.00	60.6 PK	74.0	-13.4	1.05 H	184	6.13	54.47
10	15630.00	48.5 AV	54.0	-5.5	1.05 H	184	-5.97	54.47

ANTENNA POLARITY & TEST DISTANCE: VERTICAL AT 3 M

NO.	FREQ. (MHz)	EMISSION LEVEL (dBuV/m)	LIMIT (dBuV/m)	MARGIN (dB)	ANTENNA HEIGHT (m)	TABLE ANGLE (Degree)	RAW VALUE (dBuV)	CORRECTION FACTOR (dB/m)
1	5147.43	67.2 PK	74.0	-6.8	1.00 V	328	24.95	42.25
2	5147.43	53.4 AV	54.0	-0.6	1.00 V	328	11.15	42.25
3	*5210.00	108.2 PK			1.00 V	326	65.80	42.40
4	*5210.00	96.0 AV			1.00 V	326	53.60	42.40
5	5366.66	56.8 PK	74.0	-17.2	1.00 V	330	14.28	42.52
6	5366.66	44.3 AV	54.0	-9.7	1.00 V	330	1.78	42.52
7	#10420.00	58.5 PK	74.0	-15.5	1.29 V	236	9.72	48.78
8	#10420.00	46.6 AV	54.0	-7.4	1.29 V	236	-2.18	48.78
9	15630.00	59.7 PK	74.0	-14.3	1.17 V	234	5.23	54.47
10	15630.00	47.6 AV	54.0	-6.4	1.17 V	234	-6.87	54.47

REMARKS:

1. Emission Level(dBuV/m) = Raw Value(dBuV) + Correction Factor(dB/m)
2. Correction Factor(dB/m) = Antenna Factor(dB/m) + Cable Factor(dB) – Pre-Amplifier Factor(dB)
3. The other emission levels were very low against the limit.
4. Margin value = Emission Level – Limit value
5. " * ": Fundamental frequency.
6. " # ": The radiated frequency is out of the restricted band.



A D T

4.3 TRANSMIT POWER MEASUREMENT

4.3.1 LIMITS OF TRANSMIT POWER MEASUREMENT

Frequency Band	Limit
5.15 – 5.25GHz	The lesser of 50mW (17dBm) or 4dBm + 10logB
5.25 – 5.35GHz	The lesser of 250mW (24dBm) or 11dBm + 10logB
5.47 – 5.725GHz	The lesser of 250mW (24dBm) or 11dBm + 10logB
5.725 – 5.825GHz	The lesser of 1W (30dBm) or 17dBm + 10logB

Note: Where B is the 26dB emission bandwidth in MHz.

Per KDB 662911 D01 Multiple Transmitter Output v01r02 Method of conducted output power measurement on IEEE 802.11 devices,

Array Gain = 0 dB (i.e., no array gain) for NANT ≤ 4;

Array Gain = 0 dB (i.e., no array gain) for channel widths ≥ 40 MHz for any NANT;

Array Gain = 5 log(NANT/NSS) dB or 3 dB, whichever is less for 20-MHz channel widths with NANT ≥ 5.

For power measurements on all other devices: Array Gain = 10 log(NANT/NSS) dB.

4.3.2 TEST INSTRUMENTS

FOR POWER OUTPUT MEASUREMENT

DESCRIPTION & MANUFACTURER	MODEL NO.	SERIAL NO.	CALIBRATED DATE	CALIBRATED UNTIL
Power meter Anritsu	ML2495A	0824006	May 20, 2013	May 19, 2014
Power sensor Anritsu	MA2411B	0738172	May 20, 2013	May 19, 2014

Note:

1. The calibration interval of the above test instruments is 12 months and the calibrations are traceable to NML/ROC and NIST/USA.
2. Tested date : Sep. 23, 2013



A D T

FOR 26dB OCCUPIED BANDWIDTH

DESCRIPTION & MANUFACTURER	MODEL NO.	SERIAL NO.	CALIBRATED DATE	CALIBRATED UNTIL
Spectrum Analyzer R&S	FSP 40	100036	Jan. 21, 2013	Jan. 20, 2014

Note:

1. The calibration interval of the above test instruments is 12 months and the calibrations are traceable to NML/ROC and NIST/USA.
2. Tested date : Sep. 23, 2013

4.3.3 TEST PROCEDURE

FOR POWER OUTPUT MEASUREMENT

Method PM is used to perform output power measurement, trigger and gating function of wide band power meter is enabled to measure max output power of TX on burst. Duty factor is not added to measured value.

FOR 26dB OCCUPIED BANDWIDTH

1. Set RBW = approximately 1% of the emission bandwidth.
2. Set the VBW > RBW.
3. Detector = Peak.
4. Trace mode = max hold.
5. Measure the maximum width of the emission that is 26 dB down from the peak of the emission. Compare this with the RBW setting of the analyzer. Readjust RBW and repeat measurement as needed until the RBW/EBW ratio is approximately 1%.

4.3.4 DEVIATION FROM TEST STANDARD

No deviation

4.3.5 TEST SETUP

FOR POWER OUTPUT MEASUREMENT

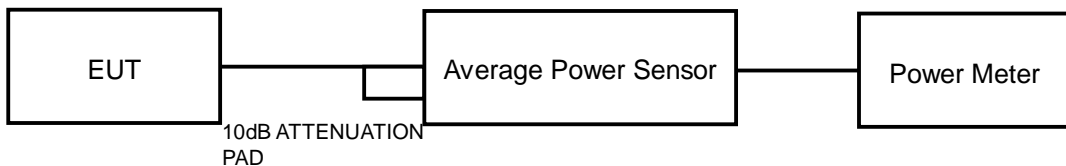

FOR 26dB OCCUPIED BANDWIDTH

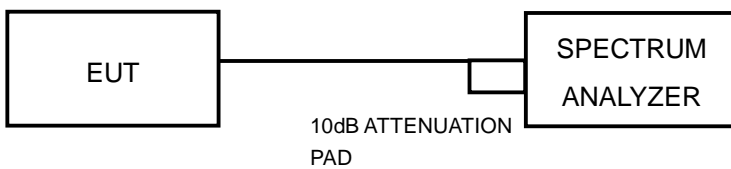

4.3.6 EUT OPERATING CONDITIONS

The software provided by client to enable the EUT under transmission condition continuously at specific channel frequencies individually.



A D T

4.3.7 TEST RESULTS

802.11a

CONDUCTED POWER:

CHANNEL	CHANNEL FREQUENCY (MHz)	AVERAGE POWER (mW)	AVERAGE POWER (dBm)	POWER LIMIT (dBm)	PASS/FAIL
36	5180	48.195	16.83	17	PASS
40	5200	47.643	16.78	17	PASS
48	5240	46.666	16.69	17	PASS

26dB OCCUPIED BANDWIDTH:

CHANNEL	CHANNEL FREQUENCY (MHz)	26dBc BANDWIDTH (MHz)
36	5180	20.55
40	5200	20.55
48	5240	20.58

Note: For FCC output power limitation is determined based on 26dBc bandwidth.

Power Limit = 4dBm + 10logB < UNII Band 1>			
Channel Number	Freq.(MHz)	Min. B(MHz)	Determined Conducted Limit (dBm)
36	5180	20.55	17.12 > 17
40	5200	20.55	17.12 > 17
48	5240	20.58	17.13 > 17



A D T

802.11ac (VHT20)

CONDUCTED POWER:

CHAN.	CHAN. FREQ. (MHz)	AVERAGE POWER (dBm)			TOTAL POWER (mW)	TOTAL POWER (dBm)	POWER LIMIT (dBm)	PASS/FAIL
		CHAIN 0	CHAIN 1	CHAIN 2				
36	5180	9.52	9.56	9.61	27.131	14.33	17	PASS
40	5200	9.42	9.65	9.71	27.330	14.37	17	PASS
48	5240	9.65	9.87	9.88	28.658	14.57	17	PASS

26dB OCCUPIED BANDWIDTH:

CHANNEL	CHANNEL FREQUENCY (MHz)	26dBc BANDWIDTH (MHz)		
		CHAIN 0	CHAIN 1	CHAIN 2
36	5180	20.87	20.66	20.51
40	5200	20.83	20.69	20.81
48	5240	20.85	20.70	20.61

Note: For FCC output power limitation is determined based on 26dBc bandwidth.

Power Limit = 4dBm + 10logB < UNII Band 1 >			
Channel Number	Freq.(MHz)	Min. B(MHz)	Determined Conducted Limit (dBm)
36	5180	20.51	17.11 > 17
40	5200	20.69	17.15 > 17
48	5240	20.61	17.14 > 17



A D T

802.11ac (VHT40)

CONDUCTED POWER:

CHAN.	CHAN. FREQ. (MHz)	AVERAGE POWER (dBm)			TOTAL POWER (mW)	TOTAL POWER (dBm)	POWER LIMIT (dBm)	PASS/FAIL
		CHAIN 0	CHAIN 1	CHAIN 2				
38	5190	11.96	12.43	11.95	48.870	16.89	17	PASS
46	5230	11.89	12.44	11.97	48.732	16.88	17	PASS

26dB OCCUPIED BANDWIDTH:

CHANNEL	CHANNEL FREQUENCY (MHz)	26dBc BANDWIDTH (MHz)		
		CHAIN 0	CHAIN 1	CHAIN 2
38	5190	41.57	41.18	41.05
46	5230	41.46	41.52	41.26

Note: For FCC output power limitation is determined based on 26dBc bandwidth.

Power Limit = 4dBm + 10logB < UNII Band 1 >			
Channel Number	Freq.(MHz)	Min. B(MHz)	Determined Conducted Limit (dBm)
38	5190	41.05	20.13 > 17
46	5230	41.26	20.15 > 17



A D T

802.11ac (VHT80)

CONDUCTED POWER:

CHAN.	CHAN. FREQ. (MHz)	AVERAGE POWER (dBm)			TOTAL POWER (mW)	TOTAL POWER (dBm)	POWER LIMIT (dBm)	PASS / FAIL
		CHAIN 0	CHAIN 1	CHAIN 2				
42	5210	11.83	12.32	12.11	48.557	16.86	17	PASS

26dB OCCUPIED BANDWIDTH:

CHANNEL	CHANNEL FREQUENCY (MHz)	26dBc BANDWIDTH (MHz)		
		CHAIN 0	CHAIN 1	CHAIN 2
42	5210	83.57	82.64	82.29

Note: For FCC output power limitation is determined based on 26dBc bandwidth.

Power Limit = 4dBm + 10logB < UNII Band 1 >			
Channel Number	Freq.(MHz)	Min. B(MHz)	Determined Conducted Limit (dBm)
42	5210	82.29	23.15 > 17



A D T

4.4 PEAK POWER SPECTRAL DENSITY MEASUREMENT

4.4.1 LIMITS OF PEAK POWER SPECTRAL DENSITY MEASUREMENT

Frequency Band	Limit
5.15 ~ 5.25GHz	4dBm
5.25 ~ 5.35GHz	11dBm
5.47 – 5.725GHz	11dBm
5.725 ~ 5.825GHz	17dBm

4.4.2 TEST INSTRUMENTS

DESCRIPTION & MANUFACTURER	MODEL NO.	SERIAL NO.	CALIBRATED DATE	CALIBRATED UNTIL
Spectrum Analyzer R&S	FSP 40	100036	Jan. 21, 2013	Jan. 20, 2014

Note:

1. The calibration interval of the above test instruments is 12 months and the calibrations are traceable to NML/ROC and NIST/USA.
2. Tested date : Sep. 23, 2013

4.4.3 TEST PROCEDURES

1. Set span to encompass the entire emission bandwidth (EBW) of the signal.
2. Set RBW = 1 MHz, Set VBW ≥ 3 MHz, Detector = RMS
3. Sweep time = auto, trigger set to “free run”.
4. Trace average at least 100 traces in power averaging mode.
5. Record the max value and for duty cycle of test signal is < 98% add 10 log (1/duty cycle)

4.4.4 DEVIATION FROM TEST STANDARD

No deviation

4.4.5 TEST SETUP

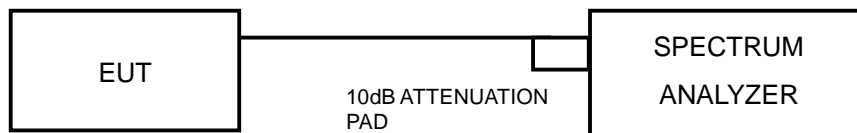

4.4.6 EUT OPERATING CONDITIONS

Same as 4.3.6



A D T

4.4.7 TEST RESULTS

802.11a

CHANNEL	CHANNEL FREQUENCY (MHz)	PSD (dBm)	MAXIMUM LIMIT (dBm)	PASS/FAIL
36	5180	3.62	4	PASS
40	5200	3.52	4	PASS
48	5240	3.78	4	PASS

802.11ac (VHT20)

CHANNEL	CHANNEL FREQUENCY (MHz)	PSD (dBm)			TOTAL POWER DENSITY (dBm)	MAX. LIMIT (dBm)	PASS/FAIL
		CHAIN 0	CHAIN 1	CHAIN 2			
36	5180	-4.23	-4.35	-4.01	0.58	1.29	PASS
40	5200	-4.48	-3.98	-4.24	0.54	1.29	PASS
48	5240	-4.26	-4.00	-4.11	0.65	1.29	PASS

- NOTE:** 1. Method a) of power density measurement of KDB 662911 is using for calculating total power density. Total power density is summing entire spectra across corresponding frequency bins on the various outputs by computer.
2. Directional gain = $10 \log[(10^{G1/20} + 10^{G2/20} + 10^{G3/20})^2 / 3] = 8.71 \text{ dBi} > 6 \text{ dBi}$, so the power density limit shall be reduced to $4 - (8.71 - 6) = 1.29 \text{ dBm}$.



A D T

802.11ac (VHT40)

CHANNEL	CHANNEL FREQUENCY (MHz)	PSD W/O DUTY FACTOR (dBm)			DUTY FACTOR (dB)	TOTAL PSD WITH DUTY FACTOR (dBm)	MAX. LIMIT (dBm)	PASS/FAIL
		CHAIN 0	CHAIN 1	CHAIN 2				
38	5190	-4.97	-4.57	-4.58	0.11	0.18	1.29	PASS
46	5230	-4.40	-4.14	-4.51	0.11	0.53	1.29	PASS

- NOTE:** 1. Method a) of power density measurement of KDB 662911 is using for calculating total power density. Total power density is summing entire spectra across corresponding frequency bins on the various outputs by computer.
2. Directional gain = $10 \log[(10^{G1/20} + 10^{G2/20} + 10^{G3/20})^2 / 3]$ = 8.71dBi > 6dBi , so the power density limit shall be reduced to $4-(8.71-6)$ = 1.29dBm.
3. Refer to section 3.4 for duty cycle spectrum plot.

802.11ac (VHT80)

CHANNEL	CHANNEL FREQUENCY (MHz)	PSD W/O DUTY FACTOR (dBm)			DUTY FACTOR (dBm)	TOTAL PSD WITH DUTY FACTOR (dBm)	MAX. LIMIT (dBm)	PASS/FAIL
		CHAIN 0	CHAIN 1	CHAIN 2				
42	5210	-7.87	-7.13	-7.39	0.16	-2.52	1.29	PASS

- NOTE:** 1. Method a) of power density measurement of KDB 662911 is using for calculating total power density. Total power density is summing entire spectra across corresponding frequency bins on the various outputs by computer.
2. Directional gain = $10 \log[(10^{G1/20} + 10^{G2/20} + 10^{G3/20})^2 / 3]$ = 8.71dBi > 6dBi , so the power density limit shall be reduced to $4-(8.71-6)$ = 1.29dBm.
3. Refer to section 3.4 for duty cycle spectrum plot.



A D T

SPECTRUM PLOT OF WORST VALUE

802.11a / CH48

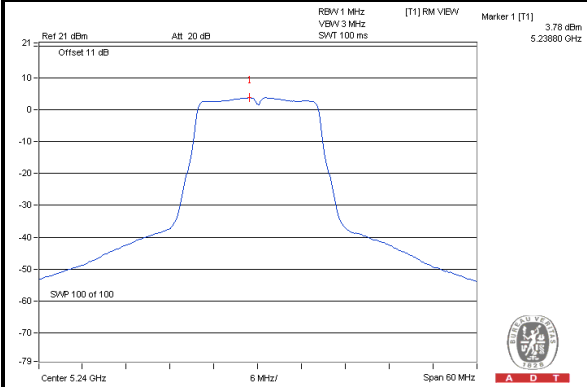

802.11ac (VHT20) / CH48 <chain 1>

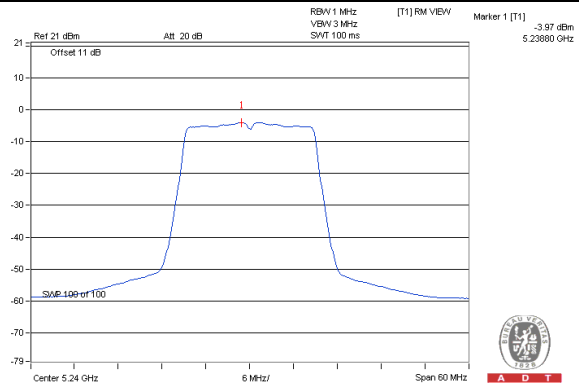

802.11ac (VHT40) / CH46 <chain 1>

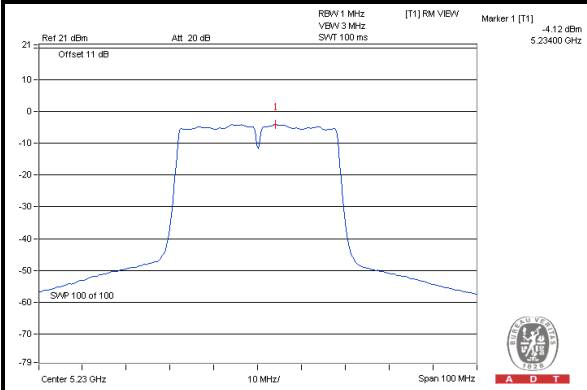

802.11ac (VHT80) / CH42 <chain 1>

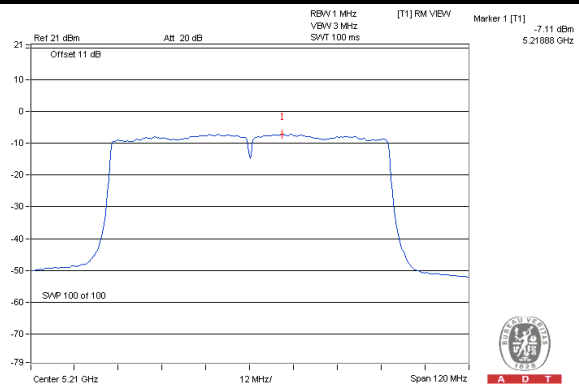

4.5 PEAK POWER EXCURSION MEASUREMENT

4.5.1 LIMITS OF PEAK POWER EXCURSION MEASUREMENT

Shall not exceed 13 dB

4.5.2 TEST INSTRUMENTS

DESCRIPTION & MANUFACTURER	MODEL NO.	SERIAL NO.	CALIBRATED DATE	CALIBRATED UNTIL
Spectrum Analyzer R&S	FSP 40	100036	Jan. 21, 2013	Jan. 20, 2014

Note:

1. The calibration interval of the above test instruments is 12 months and the calibrations are traceable to NML/ROC and NIST/USA.
2. Tested date : Sep. 23, 2013

4.5.3 TEST PROCEDURE

1. Set RBW = 1 MHz, VBW \geq 3 MHz, Detector = peak.
2. Trace mode = max-hold. Allow the sweeps to continue until the trace stabilizes.
3. Use the peak search function to find the peak of the spectrum.
4. Measure the PPSD.
5. Compute the ratio of the maximum of the peak-max-hold spectrum to the PPSD.

4.5.4 DEVIATION FROM TEST STANDARD

No deviation

4.5.5 TEST SETUP

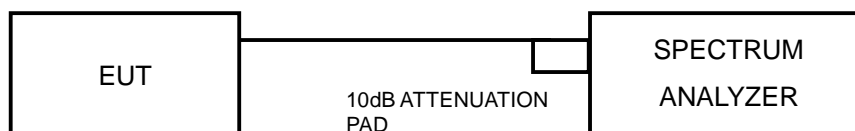

4.5.6 EUT OPERATING CONDITIONS

The software provided by client to enable the EUT under transmission condition continuously at specific channel frequencies individually.



A D T

4.5.7 TEST RESULTS

MODULATION MODE	MODULATION TYPE	CHAN. FREQ. (MHz)	PEAK VALUE (dBm)	PPSD WITHOUT DUTY FACTOR (dBm)	PPSD WITH DUTY FACTOR (dBm)	PEAK EXCURSION (dB)	LIMIT (dB)	PASS /FAIL
802.11a	BPSK	5240	12.25	3.78	3.78	8.47	13	PASS
	QPSK		12.1	3.83	3.92	8.18	13	PASS
	16QAM		13.04	3.81	3.95	9.09	13	PASS
	64QAM		12.22	3.79	4.07	8.15	13	PASS
802.11ac (VHT20)	BPSK	5240	4.56	-4.25	-4.25	8.81	13	PASS
	QPSK		5.31	-4.54	-4.44	9.75	13	PASS
	16QAM		5.6	-4.39	-4.26	9.86	13	PASS
	64QAM		6.06	-4.62	-4.38	10.44	13	PASS
	256QAM		5.64	-4.55	-4.22	9.86	13	PASS
802.11ac (VHT40)	BPSK	5230	4.73	-4.34	-4.23	8.96	13	PASS
	QPSK		5.32	-4.48	-4.33	9.65	13	PASS
	16QAM		5.58	-4.7	-4.46	10.04	13	PASS
	64QAM		6.08	-4.54	-4.06	10.14	13	PASS
	256QAM		5.32	-4.83	-4.24	9.56	13	PASS
802.11ac (VHT80)	BPSK	5210	0.96	-7.87	-7.71	8.67	13	PASS
	QPSK		2.11	-8	-7.73	9.84	13	PASS
	16QAM		2.99	-7.93	-7.44	10.43	13	PASS
	64QAM		2.01	-8	-7.38	9.39	13	PASS
	256QAM		2.54	-8.13	-7.20	9.74	13	PASS



A D T

SPECTRUM PLOT OF WORST VALUE

802.11a / 16QAM

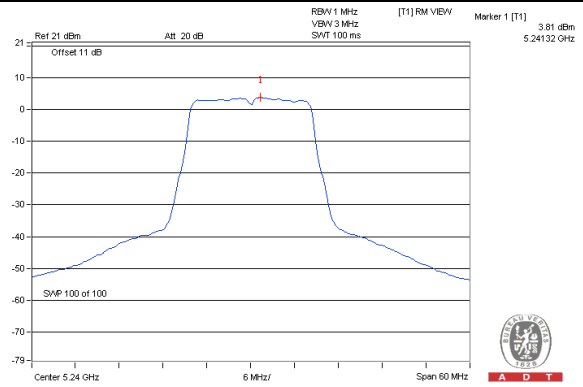
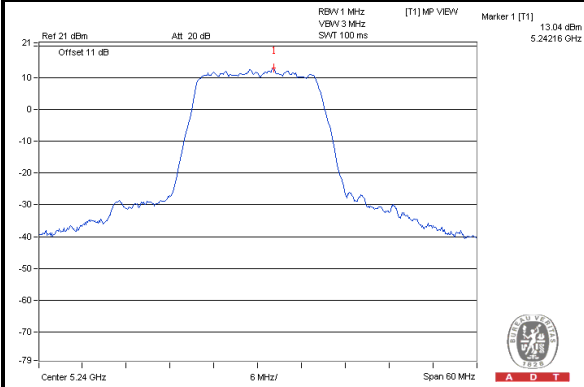

802.11ac (VHT20) / 64QAM

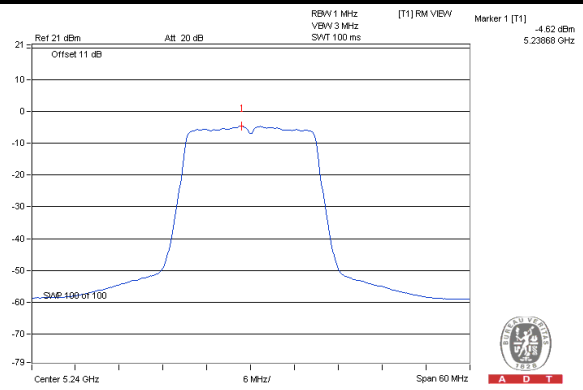
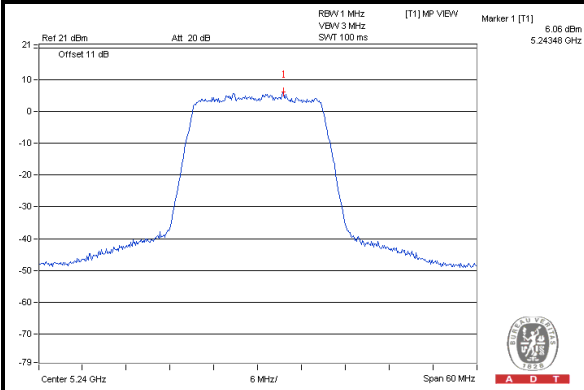



A D T

SPECTRUM PLOT OF WORST VALUE

802.11ac (VHT40) / 64QAM

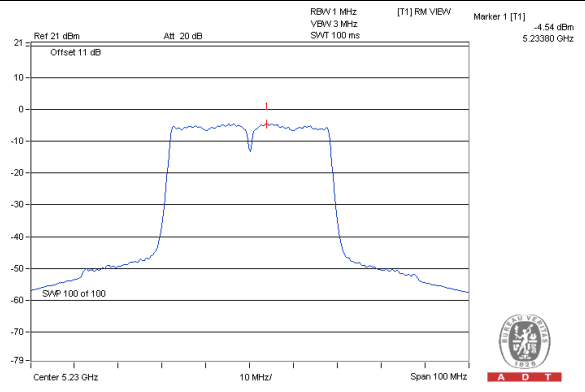
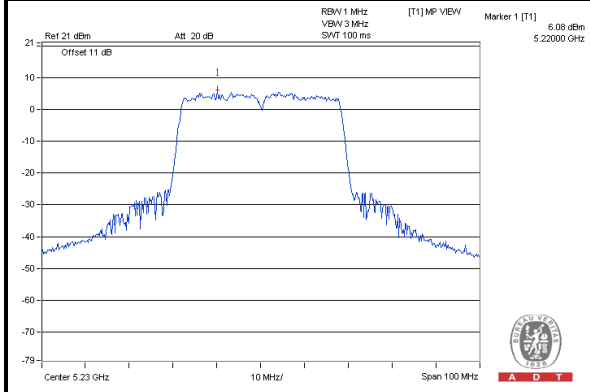

802.11ac (VHT80) / 16QAM

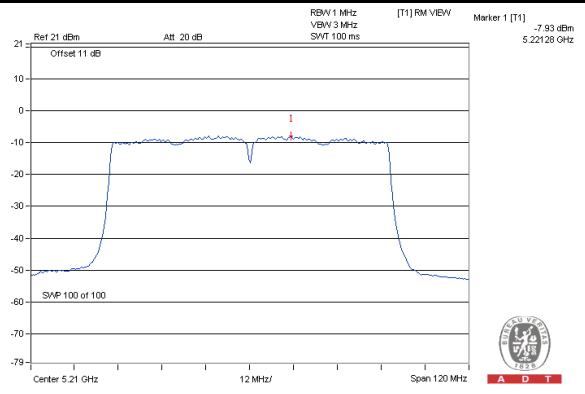
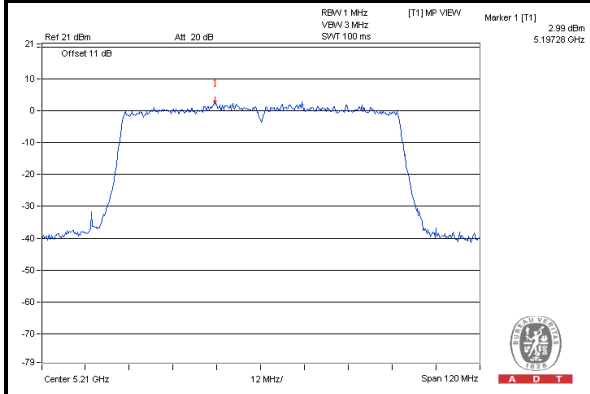

4.6 FREQUENCY STABILITY

4.6.1 LIMITS OF FREQUENCY STABILITY MEASUREMENT

The frequency of the carrier signal shall be maintained within band of operation

4.6.2 TEST INSTRUMENTS

DESCRIPTION & MANUFACTURER	MODEL NO.	SERIAL NO.	CALIBRATED DATE	CALIBRATED UNTIL
Spectrum Analyzer R&S	FSP 40	100036	Jan. 21, 2013	Jan. 20, 2014
Temperature & Humidity Chamber GIANTFORCE	GTH-150-40 -SP-AR	MAA0812-008	Jan. 17, 2013	Jan. 16, 2014

Note:

1. The calibration interval of the above test instruments is 12 months and the calibrations are traceable to NML/ROC and NIST/USA.
2. Tested date : Sep. 23, 2013

4.6.3 TEST PROCEDURE

1. The EUT was placed inside the environmental test chamber and powered by nominal AC voltage.
2. Turn the EUT on and couple its output to a spectrum analyzer.
3. Turn the EUT off and set the chamber to the highest temperature specified.
4. Allow sufficient time (approximately 30 min) for the temperature of the chamber to stabilize, turn the EUT on and measure the operating frequency after 2, 5, and 10 minutes.
5. Repeat step 2 and 3 with the temperature chamber set to the lowest temperature.
6. The test chamber was allowed to stabilize at +20 degree C for a minimum of 30 minutes. The supply voltage was then adjusted on the EUT from 85% to 115% and the frequency record.

4.6.4 DEVIATION FROM TEST STANDARD

No deviation

4.6.5 TEST SETUP

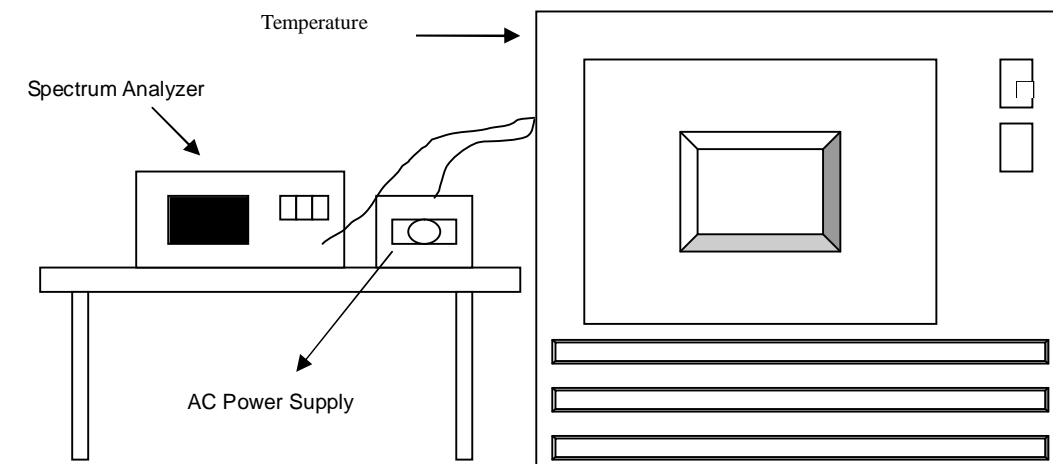

4.6.6 EUT OPERATING CONDITION

Set the EUT transmit at un-modulation mode to test frequency stability.



A D T

4.6.7 TEST RESULTS

FREQUENCY STABILITY VERSUS TEMP.									
OPERATING FREQUENCY: 5240MHz									
TEMP. (°C)	POWER SUPPLY (Vac)	0 MINUTE		2 MINUTE		5 MINUTE		10 MINUTE	
		Measured Frequency	Frequency Drift	Measured Frequency	Frequency Drift	Measured Frequency	Frequency Drift	Measured Frequency	Frequency Drift
		(MHz)	%	(MHz)	%	(MHz)	%	(MHz)	%
50	120	5239.9759	-0.00046	5239.976	-0.00046	5239.9729	-0.00052	5239.9758	-0.00046
40	120	5239.9863	-0.00026	5239.9832	-0.00032	5239.9852	-0.00028	5239.9828	-0.00033
30	120	5240.0167	0.00032	5240.0198	0.00038	5240.0103	0.00020	5240.0148	0.00028
20	120	5239.9769	-0.00044	5239.9797	-0.00039	5239.98	-0.00038	5239.9795	-0.00039
10	120	5239.9913	-0.00017	5239.9969	-0.00006	5239.9932	-0.00013	5239.9937	-0.00012
0	120	5240.0006	0.00001	5239.9989	-0.00002	5240.0059	0.00011	5239.9989	-0.00002
-10	120	5240.0218	0.00042	5240.0192	0.00037	5240.018	0.00034	5240.0272	0.00052
-20	120	5240.0048	0.00009	5240.0029	0.00006	5240.0103	0.00020	5240.0108	0.00021
-30	120	5240.02	0.00038	5240.0163	0.00031	5240.0197	0.00038	5240.0218	0.00042

FREQUENCY STABILITY VERSUS VOLTAGE									
OPERATING FREQUENCY: 5240MHz									
TEMP. (°C)	POWER SUPPLY (Vac)	0 MINUTE		2 MINUTE		5 MINUTE		10 MINUTE	
		Measured Frequency	Frequency Drift	Measured Frequency	Frequency Drift	Measured Frequency	Frequency Drift	Measured Frequency	Frequency Drift
		(MHz)	%	(MHz)	%	(MHz)	%	(MHz)	%
20	138	5239.9775	-0.00043	5239.9787	-0.00041	5239.9806	-0.00037	5239.9794	-0.00039
	120	5239.9769	-0.00044	5239.9797	-0.00039	5239.98	-0.00038	5239.9795	-0.00039
	102	5239.9767	-0.00044	5239.9795	-0.00039	5239.9794	-0.00039	5239.98	-0.00038



A D T

5. PHOTOGRAPHS OF THE TEST CONFIGURATION

Please refer to the attached file (Test Setup Photo).





6. INFORMATION ON THE TESTING LABORATORIES

We, Bureau Veritas Consumer Products Services (H.K.) Ltd., Taoyuan Branch, were founded in 1988 to provide our best service in EMC, Radio, Telecom and Safety consultation. Our laboratories are accredited and approved according to ISO/IEC 17025.

If you have any comments, please feel free to contact us at the following:

Linko EMC/RF Lab:

Tel: 886-2-26052180

Fax: 886-2-26052943

Hsin Chu EMC/RF Lab:

Tel: 886-3-5935343

Fax: 886-3-5935342

Hwa Ya EMC/RF/Safety/Telecom Lab:

Tel: 886-3-3183232

Fax: 886-3-3270892

Email: service.adt@tw.bureauveritas.com

Web Site: www.bureauveritas-adt.com

The address and road map of all our labs can be found in our web site also.



A D T

7.APPENDIX A - MODIFICATIONS RECORDERS FOR ENGINEERING CHANGES TO THE EUT BY THE LAB

No modifications were made to the EUT by the lab during the test.

--- END ---