



A D T

# SAR TEST REPORT

**REPORT NO.:** SA991130E02A

**MODEL NO.:** PHS2000W

**FCC ID:** UXX-PHS2000W

**RECEIVED:** Jan. 04, 2011

**TESTED:** Jan. 04 ~ Jan. 10, 2011

**ISSUED:** Jan. 21, 2011

**APPLICANT:** Cradlepoint, Inc.

**ADDRESS:** 805 W. Franklin Street, Boise, ID 83702

**ISSUED BY:** Bureau Veritas Consumer Products Services  
(H.K.) Ltd., Taoyuan Branch

**LAB ADDRESS:** No. 47, 14th Ling, Chia Pau Tsuen, Lin Kou  
Hsiang, Taipei Hsien 244, Taiwan, R.O.C.

**TEST LOCATION:** No. 19, Hwa Ya 2nd Rd, Wen Hwa Tsuen, Kwei  
Shan Hsiang, Taoyuan Hsien 333, Taiwan, R.O.C.

This test report consists of 49 pages in total except Appendix. It may be duplicated completely for legal use with the approval of the applicant. It should not be reproduced except in full, without the written approval of our laboratory. The client should not use it to claim product certification, approval, or endorsement by TAF or any government agency. The test results in the report only apply to the tested sample.





A D T

## TABLE OF CONTENTS

RELEASE CONTROL RECORD.....	3
1. CERTIFICATION .....	4
2. GENERAL INFORMATION .....	5
2.1 GENERAL DESCRIPTION OF EUT .....	5
2.2 GENERAL DESCRIPTION OF APPLIED STANDARDS .....	9
2.3 GENERAL INFORMATION OF THE SAR SYSTEM .....	9
2.4 TEST EQUIPMENT .....	13
2.5 GENERAL DESCRIPTION OF THE SPATIAL PEAK SAR EVALUATION .....	14
3. DESCRIPTION OF SUPPORT UNITS.....	17
4. RECIPES FOR TISSUE SIMULATING LIQUIDS .....	18
5. SYSTEM VALIDATION.....	21
5.1 TEST PROCEDURE .....	21
5.2 VALIDATION RESULTS .....	22
5.3 SYSTEM VALIDATION UNCERTAINTIES.....	23
6. 802.16e/WIMAX DEVICE AND SYSTEM OPERATING PARAMETERS .....	24
7. WIMAX/802.16E DEVICE SPECIFICATION .....	26
7.1 WIMAX ZONE TYPES .....	26
7.2 POWER MEASUREMENT .....	26
7.3 DUTY FACTOR .....	33
7.4 SCALING FACTOR .....	34
8. TEST SETUP .....	36
9. TEST RESULTS .....	38
9.1 TEST PROCEDURES.....	38
9.2 MEASURED SAR RESULTS .....	40
9.3 SIMULTANEOUS TRANSMISSION CONFIGURATION .....	42
9.4 NO SIMULTANEOUS SAR JUSTIFICATION .....	43
10. SAR LIMITS .....	45
11. SAR ERROR CONSIDERATION .....	46
12. INFORMATION ON THE TESTING LABORATORIES.....	49
APPENDIX A: TEST CONFIGURATIONS AND TEST DATA	
APPENDIX B: ADT SAR MEASUREMENT SYSTEM	
APPENDIX C: PHOTOGRAPHS OF SYSTEM VALIDATION	
APPENDIX D: SYSTEM CERTIFICATE & CALIBRATION	



A D T

## RELEASE CONTROL RECORD

ISSUE NO.	REASON FOR CHANGE	DATE ISSUED
Original release	N/A	Jan. 21, 2011



## 1. CERTIFICATION

**PRODUCT:** TableRock  
**MODEL NO.:** PHS2000W  
**BRAND:** Cradlepoint  
**APPLICANT:** Cradlepoint, Inc.  
**TESTED:** Jan. 04 ~ Jan. 10, 2011  
**TEST SAMPLE:** Engineering Sample  
**STANDARDS:** **FCC Part 2 (Section 2.1093)**  
**FCC OET Bulletin 65, Supplement C (01-01)**  
**RSS-102**

The above equipment (model: PHS2000W) has been tested by **Bureau Veritas Consumer Products Services (H.K.) Ltd., Taoyuan Branch**, and found compliance with the requirement of the above standards. The test record, data evaluation & Equipment Under Test (EUT) configurations represented herein are true and accurate accounts of the measurements of the sample's EMC characteristics under the conditions specified in this report.

PREPARED BY : Andrea Hsia , DATE : Jan. 21, 2011  
Andrea Hsia / Specialist

APPROVED BY : Gary Chang , DATE : Jan. 21, 2011  
Gary Chang / Assistant Manager



## 2. GENERAL INFORMATION

### 2.1 GENERAL DESCRIPTION OF EUT

#### FOR WiMAX function

<b>PRODUCT</b>	TableRock	
<b>MODEL NO.</b>	PHS2000W	
<b>FCC ID</b>	UXX-PHS2000W	
<b>POWER SUPPLY</b>	DC 5V from adapter or DC 5V from dock or DC 3.7V from battery	
<b>CODED TYPE/MODULATION/ CODING RATE</b>	<b>UL</b>	QPSK: 1/2, 3/4
		16QAM: 1/2, 3/4
	<b>DL</b>	QPSK: 1/2, 3/4
		16QAM: 1/2, 3/4 64QAM: 1/2, 2/3, 3/4, 5/6
<b>MULTIPLE ACCESS METHOD</b>	FDMA	
<b>MODULATION TECHNOLOGY</b>	OFDMA	
<b>TX / RX FUNCTION</b>	1TX / 2RX , supports TX diversity	
<b>OPERATING FREQUENCY</b>	5MHz: 2498.5MHz ~ 2687.5MHz 10MHz: 2501MHz ~ 2685MHz	
<b>CHANNEL BANDWIDTH</b>	5MHz, 10MHz	
<b>AVERAGE SAR (1g)</b>	0.370W/kg	
<b>ANTENNA TYPE</b>	Please see note 2	
<b>DATA CABLE</b>	Micro USB cable (Shielded, 1.0m)	
<b>I/O PORTS</b>	USB port x 1 Micro USB port x 1 10 pin connector port x 1 Antenna port x 2	
<b>ACCESSORY DEVICES</b>	Adapter x 1, Battery x 1. Micro USB cable x 1, Dock x 1	



A D T

**FOR WLAN function**

<b>PRODUCT</b>	TableRock					
<b>MODEL NO.</b>	PHS2000W					
<b>FCC ID</b>	UXX-PHS2000W					
<b>POWER SUPPLY</b>	DC 5V from adapter or DC 5V from dock or DC 3.7V from battery					
<b>MODULATION TYPE</b>	CCK, DQPSK, DBPSK for DSSS 64QAM, 16QAM, QPSK, BPSK for OFDM					
<b>MODULATION TECHNOLOGY</b>	DSSS, OFDM					
<b>TRANSFER RATE</b>	802.11b: 11 / 5.5 / 2 / 1Mbps 802.11g: 54 / 48 / 36 / 24 / 18 / 12 / 9 / 6Mbps 802.11n (20MHz, 800ns GI): 130 / 117 / 104 / 78 / 65 / 58.5 / 52 / 39 / 26 / 19.5 / 13 / 6.5Mbps 802.11n (40MHz, 800ns GI): 270 / 243 / 216 / 162 / 135 / 121.5 / 108 / 81 / 54 / 40.5 / 27 / 13.5Mbps					
<b>OPERATING FREQUENCY</b>	2412MHz ~ 2462MHz					
<b>NUMBER OF CHANNEL</b>	11 for 802.11b, 802.11g, 802.11n (20MHz) 7 for 802.11n (40MHz)					
<b>CHANNEL FREQUENCIES UNDER TEST AND ITS CONDUCTED OUTPUT POWER</b>	<b>ANT 1</b>					
	<b>802.11b</b>			<b>802.11g</b>		
	<b>CH</b>	<b>Peak (dBm)</b>	<b>Avg (dBm)</b>	<b>Peak (dBm)</b>	<b>Avg (dBm)</b>	
	2412	14.1	11.9	16.2	7.2	
	2437	14.2	11.9	16.7	7.4	
	2462	14.0	11.7	15.9	7.2	
	<b>802.11n (20MHz)</b>			<b>802.11n (40MHz)</b>		
	<b>CH</b>	<b>Peak (dBm)</b>	<b>Avg (dBm)</b>	<b>CH</b>	<b>Peak (dBm)</b>	<b>Avg (dBm)</b>
	2412	16.5	7.1	2422	15.8	7.2
	2437	16.5	7.2	2437	16.0	7.3
	2462	16.2	7.3	2452	15.8	7.1
	<b>ANT 2</b>					
	<b>802.11b</b>			<b>802.11g</b>		
	<b>CH</b>	<b>Peak (dBm)</b>	<b>Avg (dBm)</b>	<b>Peak (dBm)</b>	<b>Avg (dBm)</b>	
	2412	13.9	11.7	16.1	7.0	
	2437	14.1	11.9	16.5	7.3	
	2462	13.8	11.5	15.7	6.9	
	<b>802.11n (20MHz)</b>			<b>802.11n (40MHz)</b>		
<b>CH</b>	<b>Peak (dBm)</b>	<b>Avg (dBm)</b>	<b>CH</b>	<b>Peak (dBm)</b>	<b>Avg (dBm)</b>	
2412	16.3	6.9	2422	15.7	7.1	
2437	16.4	7.1	2437	15.9	7.2	
2462	16.1	6.8	2452	15.7	7.1	

<b>AVERAGE SAR (1g)</b>	0.038W/kg
<b>ANTENNA TYPE</b>	Please see note 2
<b>DATA CABLE</b>	Micro USB cable (Shielded, 1.0m)
<b>I/O PORTS</b>	USB port x 1 Micro USB port x 1 10 pin connector port x 1 Antenna port x 2
<b>ASSOCIATED DEVICES</b>	Adapter x 1, Battery x 1, Micro USB cable x 1, Dock x 1

**NOTE:**

1. There are two sets of antennas provided to this EUT, please refer to the following table:

<b>Set 1 for WiMAX antenna</b>						
Antenna	Antenna Type	Antenna Connector	Gain (dBi)	Cable Length(mm)	Frequency range (MHz)	Diversity Function
1	PCB	I-PEX	2	30	2500~2700	YES
2	PCB	I-PEX	2	45	2500~2700	YES
<b>Set 2 for WIFI antenna</b>						
Antenna	Antenna Type	Antenna Connector	Gain (dBi)	Cable Length(mm)	Frequency range (MHz)	Diversity Function
1	PIFA	NA	1	NA	2412~2472	YES
2	PIFA	NA	1	NA	2412~2472	YES

2. There is one set of antenna provided to this dock, please refer to the following table:

Antenna	Antenna Type	Antenna Connector	Gain (dBi)	Cable Length(mm)	Frequency range (MHz)	Diversity Function
1	PCB	TS-9	5	140	2500~2700	YES
2	PCB	TS-9	5	140	2500~2700	YES

3. The EUT could be supplied with 3.7V battery, dock or the following power adapter which will be sold together with the EUT:

Item	Brand	Model No.	Spec.
Adapter	Tenpao	S012UM0500180	AC I/P: 100-240V, 50/60Hz, 400mA DC O/P: 5V, 1800mA
Battery	ETI CA	0340-1371080001 (BP08-000720)	DC 3.7V, 1900mAh
Dock	Cradlepoint	PHS2000WD	

4. The EUT could be applied with one 3G card and following three different models could be chosen: <only for test, not for sale>

No.	Brand	Model No.	FCC ID
1	SIERRA WIRELESS	AirCard 875U	N7N-MC8775U
2	HUAWEI	E169u	QISE169
3	D-Link	DWM-156	KA2WM156A2

\*\*The EUT was pre-tested in chamber with above 3G cards, the worst case was found in model no.: **AirCard 875U**. Therefore only the test data of the mode was recorded in this report.



5. For the EUT Modulation type and coding rate. After pre-testing items of output power and spurious emissions, QPSK-1/2 was found to be 5MHz & 10MHz worst case, and was selected for the final test configuration.

Up Link		Down Link	
Modulation	Coding rate	Modulation	Coding rate
QPSK	1/2	QPSK	1/2
	3/4		3/4
16QAM	1/2	16QAM	1/2
	3/4		3/4
		64QAM	1/2
			2/3
			3/4
			5/6

6. The EUT is 1 \* 2 spatial SIMO (1Tx & 2Rx) without beam forming function.
7. The EUT embedded a firmware for testing that needs to control from Notebook computer to let EUT with different DL/UL ration.
8. The device has different DL/UL ration in normal operation. It was tested with (DL:UL= 29:18) duty cycle mode for 5MHz and 10MHz, which is the worse mode, and controlled by software. (The detail duty cycle refer to appendix A).
9. The EUT incorporates a SIMO function with 802.11n.
10. The EUT is 1 \* 2 spatial SIMO (1Tx & 2Rx) without beam forming function. The 11b/g legacy mode is limited to single transmitter only.
11. The EUT complies with 802.11n standards and backwards compatible with 802.11b, 802.11g products.
12. The EUT, operates in the 2.4GHz frequency range, lets you connect IEEE 802.11g or IEEE 802.11b and 802.11n technique devices to the network.
13. The above EUT information was declared by the manufacturer and for more detailed features description, please refer to the manufacturer's specifications or User's Manual.





A D T

14. The EUT complies with 802.11n standards and backwards compatible with 802.11b, 802.11g products.
15. The EUT, operates in the 2.4GHz frequency range, lets you connect IEEE 802.11g or IEEE 802.11b and 802.11n technique devices to the network.
16. The EUT embedded a firmware for testing that needs to control from Notebook computer to let EUT with different DL/UL ration.
17. The device has different DL/UL ration in normal operation. It was tested with (DL:UL= 29:18) duty cycle mode for 5MHz and 10MHz, which is the worse mode, and controlled by software. (The detail duty cycle refer to appendix A).
18. The above EUT information was declared by the manufacturer and for more detailed features description, please refer to the manufacturer's specifications or User's Manual.

## 2.2 GENERAL DESCRIPTION OF APPLIED STANDARDS

According to the specifications of the manufacturer, this product must comply with the requirements of the following standards:

**FCC Part 2 (2.1093)**

**FCC OET Bulletin 65, Supplement C (01- 01)**

**RSS-102**

**IEEE 1528-2003**

All test items have been performed and recorded as per the above standards.

## 2.3 GENERAL INFORMATION OF THE SAR SYSTEM

DASY5 (software 5.2 Build 162) consists of high precision robot, probe alignment sensor, phantom, robot controller, controlled measurement server and near-field probe. The robot includes six axes that can move to the precision position of the DASY5 software defined. The DASY5 software can define the area that is detected by the probe. The robot is connected to controlled box. Controlled measurement server is connected to the controlled robot box. The DAE includes amplifier, signal multiplexing, AD converter, offset measurement and surface detection. It is connected to the Electro-optical coupler (ECO). The ECO performs the conversion from the optical into digital electric signal of the DAE and transfers data to the PC.



A D T

## EX3DV4 ISOTROPIC E-FIELD PROBE

<b>CONSTRUCTION</b>	Symmetrical design with triangular core Built-in shielding against static charges PEEK enclosure material (resistant to organic solvents, e.g., DGBE)
<b>FREQUENCY</b>	10 MHz to > 6 GHz Linearity: $\pm 0.2$ dB (30 MHz to 6 GHz)
<b>DIRECTIVITY</b>	$\pm 0.3$ dB in HSL (rotation around probe axis) $\pm 0.5$ dB in tissue material (rotation normal to probe axis)
<b>DYNAMIC RANGE</b>	10 $\mu$ W/g to > 100 mW/g Linearity: $\pm 0.2$ dB (noise: typically < 1 $\mu$ W/g)
<b>DIMENSIONS</b>	Overall length: 330 mm (Tip: 20 mm) Tip diameter: 2.5 mm (Body: 12 mm) Typical distance from probe tip to dipole centers: 1 mm
<b>APPLICATION</b>	High precision dosimetric measurements in any exposure scenario (e.g., very strong gradient fields). Only probe which enables compliance testing for frequencies up to 6 GHz with precision of better 30%.

### NOTE

1. The Probe parameters have been calibrated by the SPEAG. Please reference "APPENDIX D" for the Calibration Certification Report.
2. For frequencies above 800MHz, calibration in a rectangular wave-guide is used, because wave-guide size is manageable.
3. For frequencies below 800MHz, temperature transfer calibration is used because the wave-guide size becomes relatively large.

## TWIN SAM V4.0

<b>CONSTRUCTION</b>	The shell corresponds to the specifications of the Specific Anthropomorphic Mannequin (SAM) phantom defined in IEEE 1528-2003, EN 62209-1 and IEC 62209. It enables the dosimetric evaluation of left and right hand phone usage as well as body mounted usage at the flat phantom region. A cover prevents evaporation of the liquid. Reference markings on the phantom allow the complete setup of all predefined phantom positions and measurement grids by manually teaching three points with the robot.
<b>SHELL THICKNESS</b>	$2 \pm 0.2$ mm
<b>FILLING VOLUME</b>	Approx. 25liters
<b>DIMENSIONS</b>	Height: 810mm; Length: 1000mm; Width: 500mm



## SYSTEM VALIDATION KITS:

<b>CONSTRUCTION</b>	Symmetrical dipole with 1/4 balun enables measurement of feedpoint impedance with NWA matched for use near flat phantoms filled with brain simulating solutions. Includes distance holder and tripod adaptor
<b>CALIBRATION</b>	Calibrated SAR value for specified position and input power at the flat phantom in brain simulating solutions
<b>FREQUENCY</b>	2450, 2600MHz
<b>RETURN LOSS</b>	> 20dB at specified validation position
<b>POWER CAPABILITY</b>	> 100W (f < 1GHz); > 40W (f > 1GHz)
<b>OPTIONS</b>	Dipoles for other frequencies or solutions and other calibration conditions upon request

## DEVICE HOLDER FOR SAM TWIN PHANTOM

<b>CONSTRUCTION</b>	The device holder for the mobile phone device is designed to cope with different positions given in the standard. It has two scales for the device rotation (with respect to the body axis) and the device inclination (with respect to the line between the ear reference points). The rotation centers for both scales is the ear reference point (ERP). Thus the device needs no repositioning when changing the angles. The holder has been made out of low-loss POM material having the following dielectric parameters: relative permittivity $\epsilon = 3$ and loss tangent $\delta = 0.02$ . The amount of dielectric material has been reduced in the closest vicinity of the device, since measurements have suggested that the influence of the clamp on the test results could thus be lowered. The device holder for the portable device makes up of the polyethylene foam. The dielectric parameters of material close to the dielectric parameters of the air.
---------------------	--



## DATA ACQUISITION ELECTRONICS

### CONSTRUCTION

The data acquisition electronics (DAE3) consists of a highly sensitive electrometer grade preamplifier with auto-zeroing, a channel and gain-switching multiplex, a fast 16 bit AD converter and a command decoder and control logic unit. Transmission to the measurement server is accomplished through an optical downlink for data and status information as well as an optical uplink for commands and the clock. The mechanical probe is mounting device includes two different sensor systems for frontal and sideways probe contacts. They are used for mechanical surface detection and probe collision detection. The input impedance of the DAE3 box is 200M $\Omega$ ; the inputs are symmetrical and floating. Common mode rejection is above 80 dB.



A D T

## 2.4 TEST EQUIPMENT

### FOR SAR MEASUREMENT

ITEM	NAME	BRAND	TYPE	SERIES NO.	DATE OF CALIBRATION	DUE DATE OF CALIBRATION
1	SAM Phantom	S & P	QD000 P40 CA	TP-1485	NA	NA
2	Signal Generator	Agilent	E8257C	MY43320668	Feb. 23, 2010	Feb. 22, 2011
3	E-Field Probe	S & P	EX3DV4	3590	Mar. 25, 2010	Mar. 24, 2011
4	DAE	S & P	DAE 4	861	Jan. 22, 2010	Jan. 21, 2011
5	Robot Positioner	Staubli Unimation	NA	NA	NA	NA
6	Validation Dipole	S & P	D2450V2	737	Feb. 19, 2010	Feb. 18, 2011
7			D2600V2	1020	Jan. 27, 2010	Jan. 26, 2011

**NOTE:** Before starting the measurement, all test equipment shall be warmed up for 30min.

### FOR TISSUE PROPERTY

ITEM	NAME	BRAND	TYPE	SERIES NO.	DATE OF CALIBRATION	DUE DATE OF CALIBRATION
1	Network Analyzer	Agilent	E5071C	MY46104190	Apr. 06, 2010	Apr. 05, 2011
2	Dielectric Probe	Agilent	85070D	US01440176	NA	NA

**NOTE:**

1. Before starting, all test equipment shall be warmed up for 30min.
2. The tolerance ( $k=1$ ) specified by Agilent for general dielectric measurements, deriving from inaccuracies in the calibration data, analyzer drift, and random errors, are usually  $\pm 2.5\%$  and  $\pm 5\%$  for measured permittivity and conductivity, respectively. However, the tolerances for the conductivity is smaller for material with large loss tangents, i.e., less than  $\pm 2.5\%$  ( $k=1$ ). It can be substantially smaller if more accurate methods are applied.



## 2.5 GENERAL DESCRIPTION OF THE SPATIAL PEAK SAR EVALUATION

The DASY5 post-processing software (SEMCAD) automatically executes the following procedures to calculate the field units from the micro-volt readings at the probe connector. The parameters used in the evaluation are stored in the configuration modules of the software:

Probe parameters:	- Sensitivity	Norm <sub>i</sub> , a <sub>i0</sub> , a <sub>i1</sub> , a <sub>i2</sub>
	- Conversion factor	ConvF <sub>i</sub>
	- Diode compression point	dcp <sub>i</sub>
Device parameters:	- Frequency	F
	- Crest factor	Cf
Media parameters:	- Conductivity	σ
	- Density	ρ

The first step of the evaluation is a linearization of the filtered input signal to account for the compression characteristics of the detector diode. The compensation depends on the input signal, the diode type and the DC-transmission factor from the diode to the evaluation electronics. If the exciting field is pulsed, the crest factor of the signal must be known to correctly compensate for peak power. The formula for each channel can be given as:

$$V_i = U_i + U_i^2 \cdot \frac{cf}{dcp_i}$$

V <sub>i</sub>	=compensated signal of channel i	(i = x, y, z)
U <sub>i</sub>	=input signal of channel i	(i = x, y, z)
Cf	=crest factor of exciting field	(DASY parameter)
dcp <sub>i</sub>	=diode compression point	(DASY parameter)

From the compensated input signals the primary field data for each channel can be evaluated:

$$\text{E-field probes: } E_i = \sqrt{\frac{V_i}{\text{Norm}_i \cdot \text{ConvF}}}$$

$$\text{H-field probes: } H_i = \sqrt{V_i} \cdot \frac{a_{i0} + a_{i1}f + a_{i2}f^2}{f}$$

- $V_i$  = compensated signal of channel  $i$  ( $i = x, y, z$ )
- $\text{Norm}_i$  = sensor sensitivity of channel  $i$   $\mu\text{V}/(\text{V/m})^2$  for E-field Probes ( $i = x, y, z$ )
- $\text{ConvF}$  = sensitivity enhancement in solution
- $a_{ij}$  = sensor sensitivity factors for H-field probes
- $f$  = carrier frequency [GHz]
- $E_i$  = electric field strength of channel  $i$  in V/m
- $H_i$  = magnetic field strength of channel  $i$  in A/m

The RSS value of the field components gives the total field strength (Hermitian magnitude):

$$E_{tot} = \sqrt{E_x^2 + E_y^2 + E_z^2}$$

The primary field data are used to calculate the derived field units.

$$\text{SAR} = E_{tot}^2 \cdot \frac{\sigma}{\rho \cdot 1'000}$$

- $\text{SAR}$  = local specific absorption rate in mW/g
- $E_{tot}$  = total field strength in V/m
- $\sigma$  = conductivity in [mho/m] or [Siemens/m]
- $\rho$  = equivalent tissue density in g/cm<sup>3</sup>

Note that the density is set to 1, to account for actual head tissue density rather than the density of the tissue simulating liquid. The entire evaluation of the spatial peak values is performed within the Post-processing engine (SEMCAD). The system always gives the maximum values for the 1g and 10g cubes. The algorithm to find the cube with highest averaged SAR is divided into the following stages:

1. The extraction of the measured data (grid and values) from the Zoom Scan
2. The calculation of the SAR value at every measurement point based on all stored data (A/D values and measurement parameters)
3. The generation of a high-resolution mesh within the measured volume
4. The interpolation of all measured values from the measurement grid to the high-resolution grid
5. The extrapolation of the entire 3-D field distribution to the phantom surface over the distance from sensor to surface
6. The calculation of the averaged SAR within masses of 1g and 10g.

The probe is calibrated at the center of the dipole sensors that is located 1 to 2.7mm away from the probe tip. During measurements, the probe stops shortly above the phantom surface, depending on the probe and the surface detecting system. Both distances are included as parameters in the probe configuration file. The software always knows exactly how far away the measured point is from the surface. As the probe cannot directly measure at the surface, the values between the deepest measured point and the surface must be extrapolated. The angle between the probe axis and the surface normal line is less than 30 degree.





The maximum search is automatically performed after each area scan measurement. It is based on splines in two or three dimensions. The procedure can find the maximum for most SAR distributions even with relatively large grid spacing. After the area scanning measurement, the probe is automatically moved to a position at the interpolated maximum. The following scan can directly use this position for reference, e.g., for a finer resolution grid or the cube evaluations. The 1g and 10g peak evaluations are only available for the predefined cube 7 x 7 x 7 scans. The routines are verified and optimized for the grid dimensions used in these cube measurements. The measured volume of 30 x 30 x 30mm contains about 30g of tissue. The first procedure is an extrapolation (incl. boundary correction) to get the points between the lowest measured plane and the surface. The next step uses 3D interpolation to get all points within the measured volume in a 1mm grid (42875 points). In the last step, a 1g cube is placed numerically into the volume and its averaged SAR is calculated. This cube is moved around until the highest averaged SAR is found. If the highest SAR is found at the edge of the measured volume, the system will issue a warning: higher SAR values might be found outside of the measured volume. In that case the cube measurement can be repeated, using the new interpolated maximum as the center.

### **3. DESCRIPTION OF SUPPORT UNITS**

The EUT has been tested as an independent unit.

#### 4. RECIPES FOR TISSUE SIMULATING LIQUIDS

For the measurement of the field distribution inside the SAM phantom, the phantom must be filled with 25 liters of tissue simulation liquid.

The following ingredients are used :

- **WATER-** Deionized water (pure H<sub>2</sub>O), resistivity  $\geq 16$  M - as basis for the liquid
- **DGMBE-** Diethylenglycol-monobuthyl ether (DGMBE), Fluka Chemie GmbH, CAS # 112-34-5 - to reduce relative permittivity

##### THE RECIPES FOR 2450MHz SIMULATING LIQUID TABLE

INGREDIENT	BODY SIMULATING LIQUID 2450MHz (MSL-2450)
Water	69.83%
DGMBE	30.17%
Dielectric Parameters at 22°C	f= 2450MHz $\epsilon = 52.7 \pm 5\%$ $\sigma = 1.95 \pm 5\%$ S/m

##### THE RECIPES FOR 2600MHz SIMULATING LIQUID TABLE

Ingredient	Muscle Simulating Liquid 2600MHz (MSL-2600)
Water	69.83%
DGMBE	30.17%
Salt	NA
Dielectric Parameters at 22°C	f= 2600MHz $\epsilon = 52.5 \pm 5\%$ $\sigma = 2.16 \pm 5\%$ S/m

Testing the liquids using the Agilent Network Analyzer E8358A and Agilent Dielectric Probe Kit 85070D. The testing procedure is following as

1. Turn Network Analyzer on and allow at least 30min. warm up.
2. Mount dielectric probe kit so that interconnecting cable to Network Analyzer will not be moved during measurements or calibration.
3. Pour de-ionized water and measure water temperature ( $\pm 1^\circ$ ).
4. Set water temperature in Agilent-Software (Calibration Setup).
5. Perform calibration.
6. Validate calibration with dielectric material of known properties (e.g. polished ceramic slab with  $>8\text{mm}$  thickness  $\epsilon' = 10.0$ ,  $\epsilon'' = 0.0$ ). If measured parameters do not fit within tolerance, repeat calibration ( $\pm 0.2$  for  $\epsilon'$ :  $\pm 0.1$  for  $\epsilon''$ ).
7. Conductivity can be calculated from  $\epsilon''$  by  $\sigma = \omega \epsilon_0 \epsilon'' = \epsilon'' f [\text{GHz}] / 18$ .
8. Measure liquid shortly after calibration. Repeat calibration every hour.
9. Stir the liquid to be measured. Take a sample ( $\sim 50\text{ml}$ ) with a syringe from the center of the liquid container.
10. Pour the liquid into a small glass flask. Hold the syringe at the bottom of the flask to avoid air bubbles.
11. Put the dielectric probe in the glass flask. Check that there are no air bubbles in front of the opening in the dielectric probe kit.
12. Perform measurements.
13. Adjust medium parameters in DASY5 for the frequencies necessary for the measurements ('Setup Config', select medium (e.g. Brain 900MHz) and press 'Option'-button.
14. Select the current medium for the frequency of the validation (e.g. Setup Medium Brain 900MHz).



A D T

**FOR SIMULATING LIQUID**

<b>LIQUID TYPE</b>		MSL-2450			
<b>SIMULATING LIQUID TEMP.</b>		20.5			
<b>TEST DATE</b>		Jan. 04, 2011			
<b>TESTED BY</b>		Sam Onn			
<b>FREQ. (MHz)</b>	<b>LIQUID PARAMETER</b>	<b>STANDARD VALUE</b>	<b>MEASUREMENT VALUE</b>	<b>ERROR PERCENTAGE (%)</b>	<b>LIMIT(%)</b>
2437	Permittivity ( $\epsilon$ )	52.72	54.20	2.81	±5
2450		52.70	54.04	2.54	
2437	Conductivity ( $\sigma$ ) S/m	1.94	1.96	1.03	
2450		1.95	1.98	1.54	

<b>LIQUID TYPE</b>		MSL-2600			
<b>SIMULATING LIQUID TEMP.</b>		21.3			
<b>TEST DATE</b>		Jan. 10, 2011			
<b>TESTED BY</b>		Sam Onn			
<b>FREQ. (MHz)</b>	<b>LIQUID PARAMETER</b>	<b>STANDARD VALUE</b>	<b>MEASUREMENT VALUE</b>	<b>ERROR PERCENTAGE (%)</b>	<b>LIMIT(%)</b>
2498.5	Permittivity ( $\epsilon$ )	52.64	53.68	1.98	±5
2587.0		52.53	53.39	1.64	
2593.0		52.52	53.34	1.56	
2600.0		52.51	53.21	1.33	
2498.5	Conductivity ( $\sigma$ ) S/m	2.02	2.06	1.98	
2587.0		2.14	2.15	0.47	
2593.0		2.15	2.16	0.47	
2600.0		2.16	2.17	0.46	



## 5. SYSTEM VALIDATION

The system validation was performed in the flat phantom with equipment listed in the following table. Since the SAR value is calculated from the measured electric field, dielectric constant and conductivity of the body tissue and the SAR is proportional to the square of the electric field. So, the SAR value will be also proportional to the RF power input to the system validation dipole under the same test environment. In our system validation test, 250mW RF input power was used.

### 5.1 TEST PROCEDURE

Before the system performance check, we need only to tell the system which components (probe, medium, and device) are used for the system performance check; the system will take care of all parameters. The dipole must be placed beneath the flat section of the SAM Twin Phantom with the correct distance holder in place. The distance holder should touch the phantom surface with a light pressure at the reference marking (little cross) and be oriented parallel to the long side of the phantom. Accurate positioning is not necessary, since the system will search for the peak SAR location, except that the dipole arms should be parallel to the surface. The device holder for mobile phones can be left in place but should be rotated away from the dipole.

1. The "Power Reference Measurement" and "Power Drift Measurement" jobs are located at the beginning and end of the batch process. They measure the field drift at one single point in the liquid over the complete procedure. The indicated drift is mainly the variation of the amplifier output power. If it is too high (above  $\pm 0.1$  dB), the system performance check should be repeated; some amplifiers have very high drift during warm-up. A stable amplifier gives drift results in the DASY system below  $\pm 0.02$ dB.
2. The "Surface Check" job tests the optical surface detection system of the DASY system by repeatedly detecting the surface with the optical and mechanical surface detector and comparing the results. The output gives the detecting heights of both systems, the difference between the two systems and the standard deviation of the detection repeatability. Air bubbles or refraction in the liquid due to separation of the sugar-water mixture gives poor repeatability (above  $\pm 0.1$ mm). In that case it is better to abort the system performance check and stir the liquid.

3. The "Area Scan" job measures the SAR above the dipole on a plane parallel to the surface. It is used to locate the approximate location of the peak SAR. The proposed scan uses large grid spacing for faster measurement; due to the symmetric field, the peak detection is reliable. If a finer graphic is desired, the grid spacing can be reduced. Grid spacing and orientation have no influence on the SAR result.
4. The "Zoom Scan" job measures the field in a volume around the peak SAR value assessed in the previous "Area Scan" job (for more information see the application note on SAR evaluation).

About the validation dipole positioning uncertainty, the constant and low loss dielectric spacer is used to establish the correct distance between the top surface of the dipole and the bottom surface of the phantom, the error component introduced by the uncertainty of the distance between the liquid (i.e., phantom shell) and the validation dipole in the DASYS system is less than  $\pm 0.1\text{mm}$ .

$$SAR_{tolerance} [\%] = 100 \times \left( \frac{(a + d)^2}{a^2} - 1 \right)$$

As the closest distance is 10mm, the resulting tolerance  $SAR_{tolerance}[\%]$  is  $<2\%$ .

## 5.2 VALIDATION RESULTS

SYSTEM VALIDATION TEST OF SIMULATING LIQUID					
FREQUENCY (MHz)	REQUIRED SAR (mW/g)	MEASURED SAR (mW/g)	DEVIATION (%)	SEPARATION DISTANCE	TESTED DATE
MSL 2450	13.1 (1g)	12.3	-6.11	10mm	Jan. 04, 2011
MSL 2600	13.9 (1g)	13.1	-5.76	10mm	Jan. 10, 2011

**NOTE:** Please see Appendix for the photo of system validation test.

### 5.3 SYSTEM VALIDATION UNCERTAINTIES

In the table below, the system validation uncertainty with respect to the analytically assessed SAR value of a dipole source as given in the IEEE 1528 standard is given. This uncertainty is smaller than the expected uncertainty for mobile phone measurements due to the simplified setup and the symmetric field distribution.

Error Description	Tolerance (±%)	Probability Distribution	Divisor	(C <sub>i</sub> )		Standard Uncertainty (±%)		(v <sub>i</sub> )
				(1g)	(10g)	(1g)	(10g)	
<b>Measurement System</b>								
Probe Calibration	5.50	Normal	1	1	1	5.50	5.50	∞
Axial Isotropy	0.25	Rectangular	√3	0.7	0.7	0.10	0.10	∞
Hemispherical Isotropy	1.30	Rectangular	√3	0.7	0.7	0.53	0.53	∞
Boundary effects	1.00	Rectangular	√3	1	1	0.58	0.58	∞
Linearity	0.30	Rectangular	√3	1	1	0.17	0.17	∞
System Detection Limits	1.00	Rectangular	√3	1	1	0.58	0.58	∞
Readout Electronics	0.30	Normal	1	1	1	0.30	0.30	∞
Response Time	0.80	Rectangular	√3	1	1	0.46	0.46	∞
Integration Time	2.60	Rectangular	√3	1	1	1.50	1.50	∞
RF Ambient Noise	3.00	Rectangular	√3	1	1	1.73	1.73	9
RF Ambient Reflections	3.00	Rectangular	√3	1	1	1.73	1.73	9
Probe Positioner	0.40	Rectangular	√3	1	1	0.23	0.23	∞
Probe Positioning	2.90	Rectangular	√3	1	1	1.67	1.67	∞
Max. SAR Eval.	1.00	Rectangular	√3	1	1	0.58	0.58	∞
<b>Test sample related</b>								
Sample positioning	1.90	Normal	1	1	1	1.90	1.90	4
Device holder	2.80	Normal	1	1	1	2.80	2.80	4
Output power variation-SAR drift	4.50	Rectangular	√3	1	1	2.60	2.60	1
<b>Dipole Related</b>								
Dipole Axis to Liquid Distance	1.60	Rectangular	√3	1	1	0.92	0.92	4
Input Power Drift	1.41	Rectangular	√3	1	1	0.82	0.82	1
<b>Phantom and Tissue parameters</b>								
Phantom Uncertainty	4.00	Rectangular	√3	1	1	2.31	2.31	∞
Liquid Conductivity (target)	5.00	Rectangular	√3	0.64	0.43	1.85	1.24	∞
Liquid Conductivity (measurement)	1.54	Normal	1	0.64	0.43	0.99	0.66	9
Liquid Permittivity (target)	5.00	Rectangular	√3	0.6	0.49	1.73	1.41	∞
Liquid Permittivity (measurement)	2.81	Normal	1	0.6	0.49	1.69	1.38	9
<b>Combined Standard Uncertainty</b>						<b>8.85</b>	<b>8.60</b>	
<b>Coverage Factor for 95%</b>						<b>Kp=2</b>		
<b>Expanded Uncertainty (K=2)</b>						<b>17.69</b>	<b>17.19</b>	

**NOTE:** About the system validation uncertainty assessment, please reference the section 7.



## 6. 802.16e/WiMax DEVICE AND SYSTEM OPERATING PARAMETERS

Description	Parameter		Comment
FCC ID	UXX-PHS2000W		Identify all related FCC ID
Radio Service	Part 27M		Rule parts
Transmit Frequency Range (MHz)	5 MHz BW: 2498.5 – 2687.5 MHz 10MHz BW:2501 - 2685 MHz		System parameter
System/Channel Bandwidth (MHz)	5MHz/10MHz		System parameter
System Profile	Revision 1.7.0		Defined by WiMAX Forum
Modulation Schemes	QPSK1/2, QPSK3/4 16QAM1/2, 16QAM3/4		Identify all applicable UL modulations
Sampling Factor	28/25		System parameter
Sampling Frequency (MHz)	5 MHz BW:5.6MHz 10MHz BW:11.2MHz		(Fs)
Sample Time (ns)	89.3ns/ 10 MHz 178.58ns / 5MHz		(1/Fs)
FFT Size (NFFT)	1024 / 10MHz 512 / 5 MHz		(NFFT)
Sub-Carrier Spacing (kHz)	10.9375KHz		(Δf)
Useful Symbol time (μs)	91.43us		(Tb=1/Δf)
Guard Time (μs)	11.43us		(Tg=Tb/cp); cp = cyclic prefix
OFDMA Symbol Time (μs)	102.857us		(Ts=Tb+Tg)
Frame Size (ms)	5ms		System parameter
TTG + RTG (μs or number of symbols)	165.7143us		Idle time, system parameter
Number of DL OFDMA Symbols per Frame	Max:29		Identify the allowed & maximum symbols, including both traffic & control symbols
Number of UL OFDMA Symbols per Frame	Max:18		
DL:UL Symbol Ratio	Max 29:18		For determining UL duty factor
Power Class (dBm) Identify power	Power class 2 23.5dBm+/-0.5		Identify power class and tolerance
Wave1 / Wave2	Wave2: Two antennas for TX/RX diversity. ANT1 and ANT2 cannot transmit simultaneously.		Describe antenna diversity info and MIMO requirements separately
UL Zone Types (FUSC, PUSC, OFUSC, OPUSC, AMC, TUSC1, TUSC2)	PUSC only.		Describe separately the symbol and sub-carrier/sub-channel structures applicable to each zone type
Maximum Number of UL Sub-Carriers	<b>10 MHz BW</b>	<b>5 MHz BW</b>	Identify the allowed and tested / to be tested parameters; include separate explanations on the types of control symbols and how the power levels are determined
	841	409	
UL Burst Maximum Average Power (dBm)	<b>ANT 1 ( Main)</b>	<b>ANT 2 (AUX)</b>	
	24dBm @ 10MHz 24dBm @ 5MHz	24dBm @ 10MHz 24dBm @ 5MHz	
Number and type of UL Control Symbols	3pusc symbols (used for ranging, CQICH and ACK/NACK)		





UL Control Symbol Maximum Average Power	<b>ANT 1(Main)</b>	<b>Calculation</b>	
	35.88mW for 10MHz / QPSK	251.19mW x 5/35	
	35.88mW for 10MHz / 16QAM	251.19mW x 5/35	
	73.88mW for 5MHz / QPSK	251.19 mW x 5/17	
	73.88mW for 5MHz / 16QAM	251.19 mW x 5/17	
	<b>ANT 2 (AUX)</b>	<b>Calculation</b>	
	35.88mW for 10MHz / QPSK	251.19mW x 5/35	
	35.88mW for 10MHz / 16QAM	251.19mW x 5/35	
	73.88 mW for 5MHz / QPSK	251.19 mW x 5/17	
	73.88 mW for 5MHz / 16QAM	251.19 mW x 5/17	
UL Burst Peak-to-Average Power Ratio (PAR)	With DL:UL ratio=29:18, PAR is between 7.41 to 8.08 dB.		Identify the expected range and measured/tested PAR; explain separately the methods used / to be used to address SAR probe calibration and measurement error issues
Frame Averaged UL Transmission Duty Factor (%)	<p>The duty cycle is 31.25%.  <math>15/48 = 0.3125</math>            Crest factor is <math>1/0.3125=3.2</math> with 29:18 DL:UL ratio.            Control symbols are accounted by S.F. (scaling factor)  <math>S.F. = (CCP \times 3 \text{ control symbols} + MROP \times 15 \text{ Traffic symbols}) / (\text{actual\_OP} \times 15)</math>            CCP: Control Channel Power            MROP: Maximum Rated Output Power            Actual_OP: actual (measured) maximum power</p>		Show calculations separately and explain how the applicable CF (crest factor) used / to be use in the SAR measurements is derived and how the control symbols are accounted for

## 7. WIMAX/802.16e DEVICE SPECIFICATION

### 7.1 WIMAX ZONE TYPES

The device and its system are both transmitting using only PUSC zone type. This enables multiple users to transmit simultaneously within the system. FUSC, AMC and other zone types are not used by the test device for uplink transmission. The maximum DL:UL symbol ratio can be determined according to the PUSC requirements. The system transmit an odd number of symbols using DL-PUSC consisting of even multiples of traffics and control symbols plus one symbol for the preamble. Multiples of three symbols are transmitted by the device using UL-PUSC. The OFDMA symbol time allows up to 48 downlink and uplink symbols in each 5 ms frame. TTG and RTG are also included in each frame as DL/UL transmission gaps; therefore, the system can only allow 47 or less symbols per frame.

### 7.2 POWER MEASUREMENT

Set the transmitter under transmission condition continuously at specific mode with maximum output. The power meter was used to read the response of the power sensor. Record the power level and PK to AV ratio.

The maximum conducted output power is measured for the uplink burst at DL:UL ratio=29:18 that is measured for the uplink bursts through triggering and gating.

An Anritus wideband power meter was used for measuring this item. The power was taken during the burst-on period (exclude 3 control symbols ) by means of triggering and gating function.



A D T

The measured results are as below table:

Output power table of Antenna 1

Channel BW	UL zone type / DL/UL Ratio	Channel Frequency (MHz)	Conducted Power (dBm)		Peak to Average ratio (dB)	UL modulation
			AV	PK		
5MHz	PUSC / 29:18	2498.5	23.82	31.47	7.65	QPSK
			23.67	31.08	7.41	16QAM
		2587.0	23.88	31.48	7.6	QPSK
			23.73	31.21	7.47	16QAM
		2687.5	23.60	31.34	7.74	QPSK
			23.63	31.26	7.63	16QAM
10MHz	PUSC / 29:18	2501	23.27	31.11	7.84	QPSK
			23.20	31.04	7.84	16QAM
		2593	23.48	31.23	7.75	QPSK
			23.30	31.11	7.82	16QAM
		2685	23.26	31.18	7.92	QPSK
			23.24	31.11	7.87	16QAM



A D T

### Bandwidth 5MHz / Modulation : QPSK 2587MHz

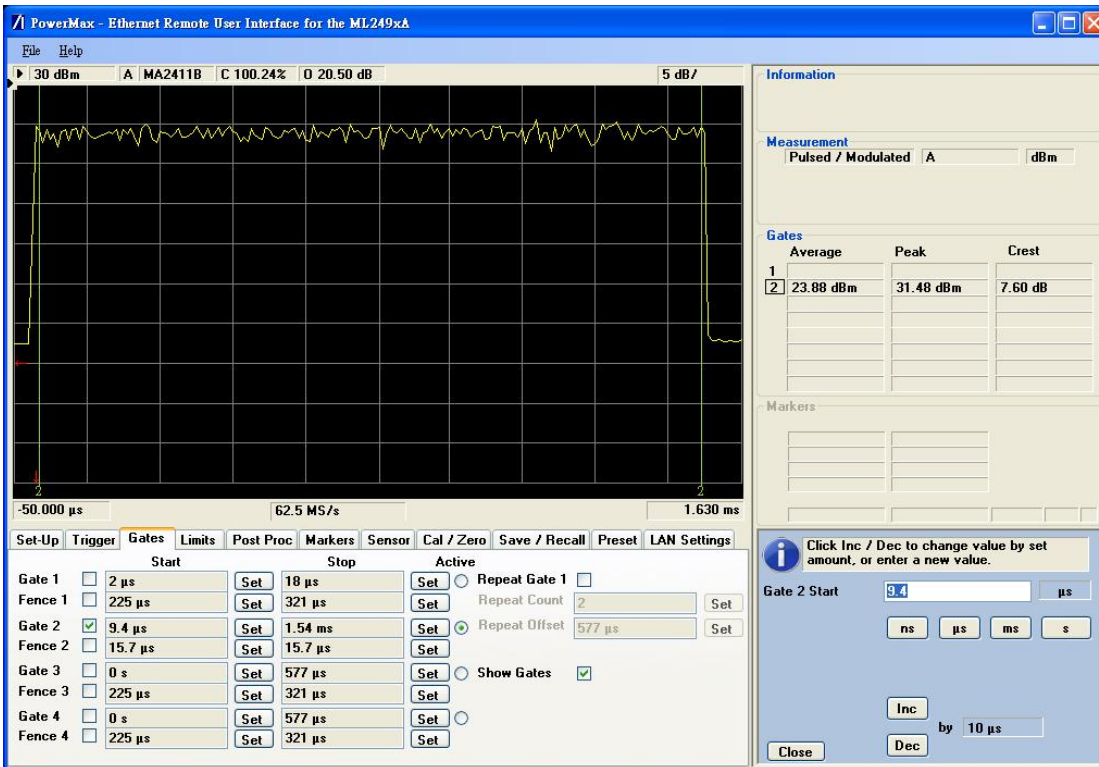

### Bandwidth 5MHz / Modulation : 16QAM 2587MHz

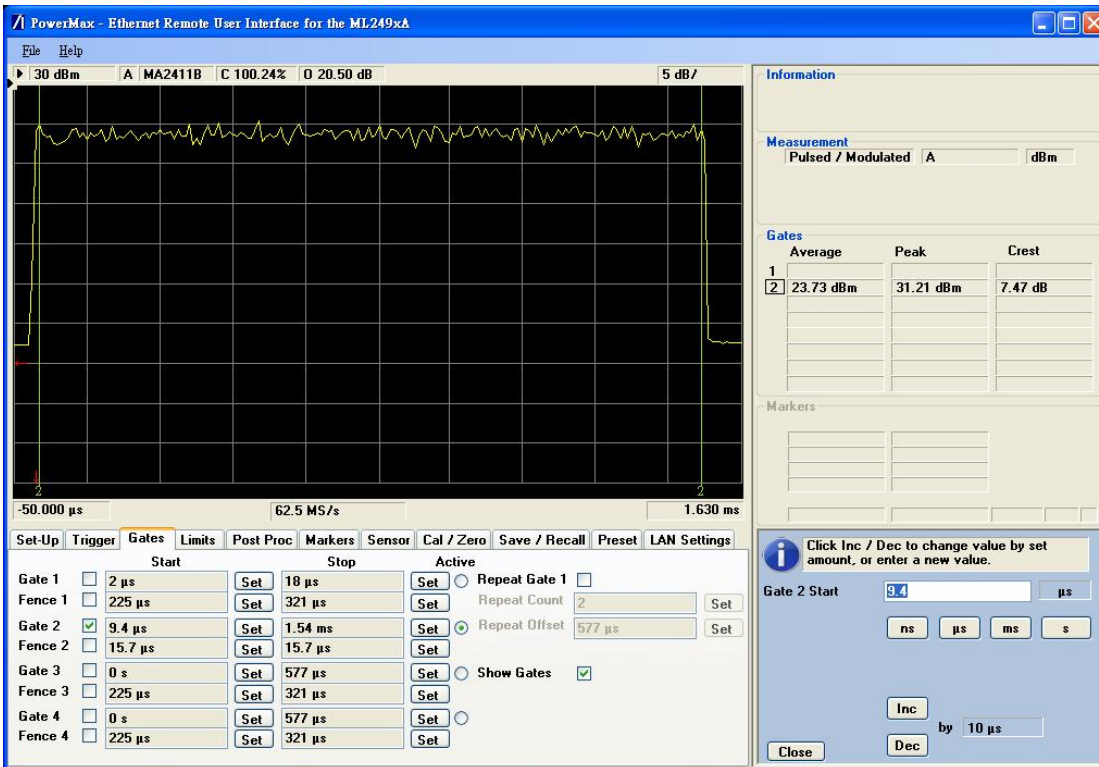



A D T

### Bandwidth 10MHz / Modulation : QPSK 2593MHz

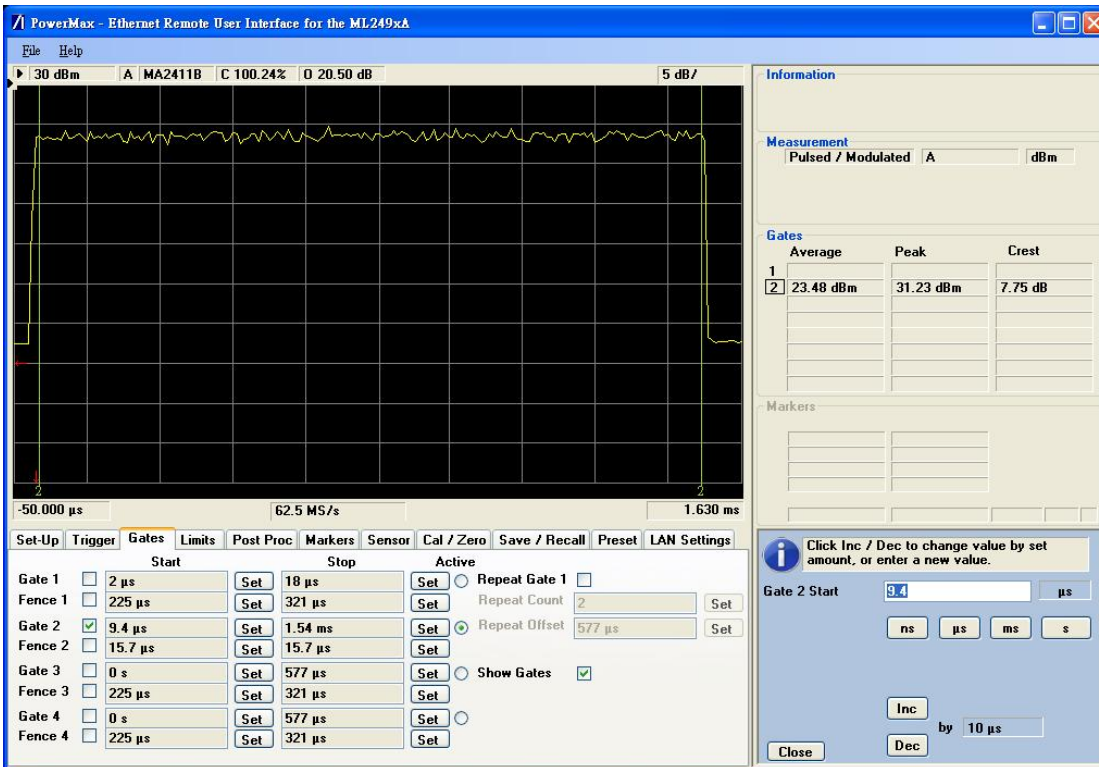

### Bandwidth 10MHz / Modulation : 16QAM 2593MHz





Output power table of Antenna 2

Channel BW	UL zone type / DL/UL Ratio	Channel Frequency (MHz)	Conducted Power (dBm)		Peak to Average ratio (dB)	UL modulation
			AV	PK		
5MHz	PUSC / 29:18	2498.5	23.63	31.35	7.72	QPSK
			23.61	31.06	7.45	16QAM
		2587.0	23.54	31.23	7.69	QPSK
			23.38	31.20	7.82	16QAM
		2687.5	23.20	31.23	8.03	QPSK
			23.21	31.22	8.01	16QAM
10MHz	PUSC / 29:18	2501	23.14	30.96	7.82	QPSK
			23.10	31.11	8.00	16QAM
		2593	23.28	30.99	7.70	QPSK
			23.23	31.16	7.93	16QAM
		2685	23.03	31.05	8.02	QPSK
			23.08	31.16	8.08	16QAM



A D T

### Bandwidth 5MHz / Modulation : QPSK 2587MHz

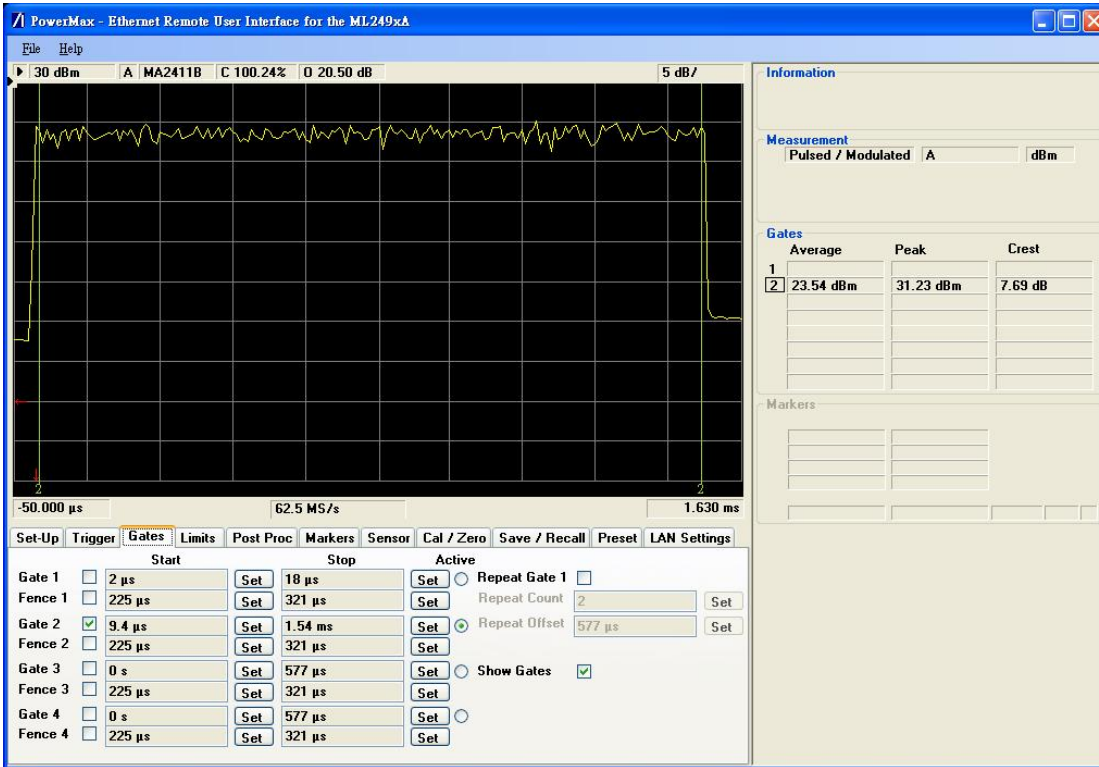

### Bandwidth 5MHz / Modulation : 16QAM 2587MHz

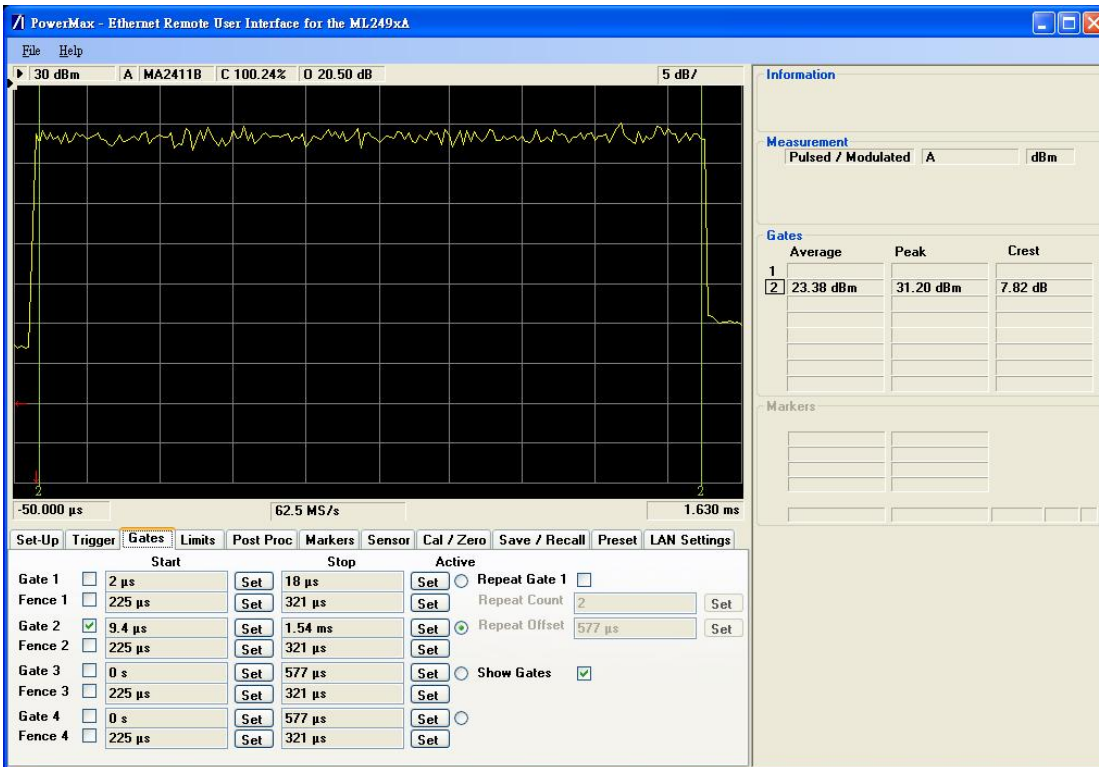





A D T

### Bandwidth 10MHz / Modulation : QPSK 2593MHz

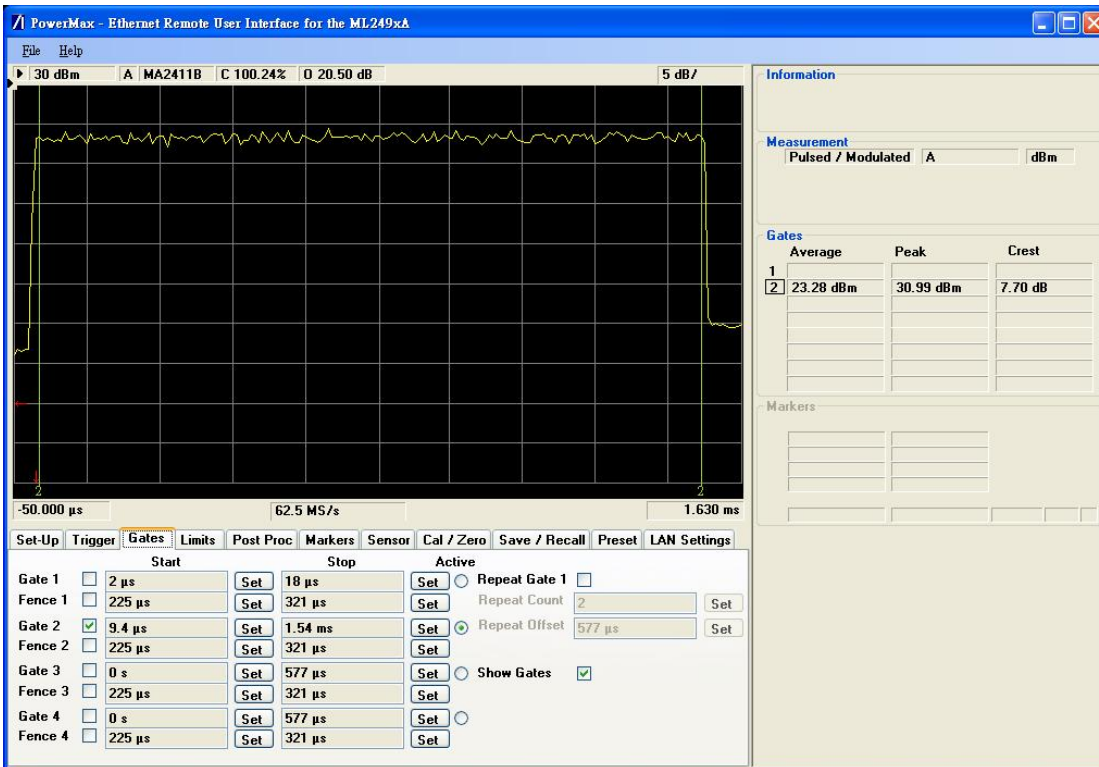

### Bandwidth 10MHz / Modulation : 16QAM 2593MHz

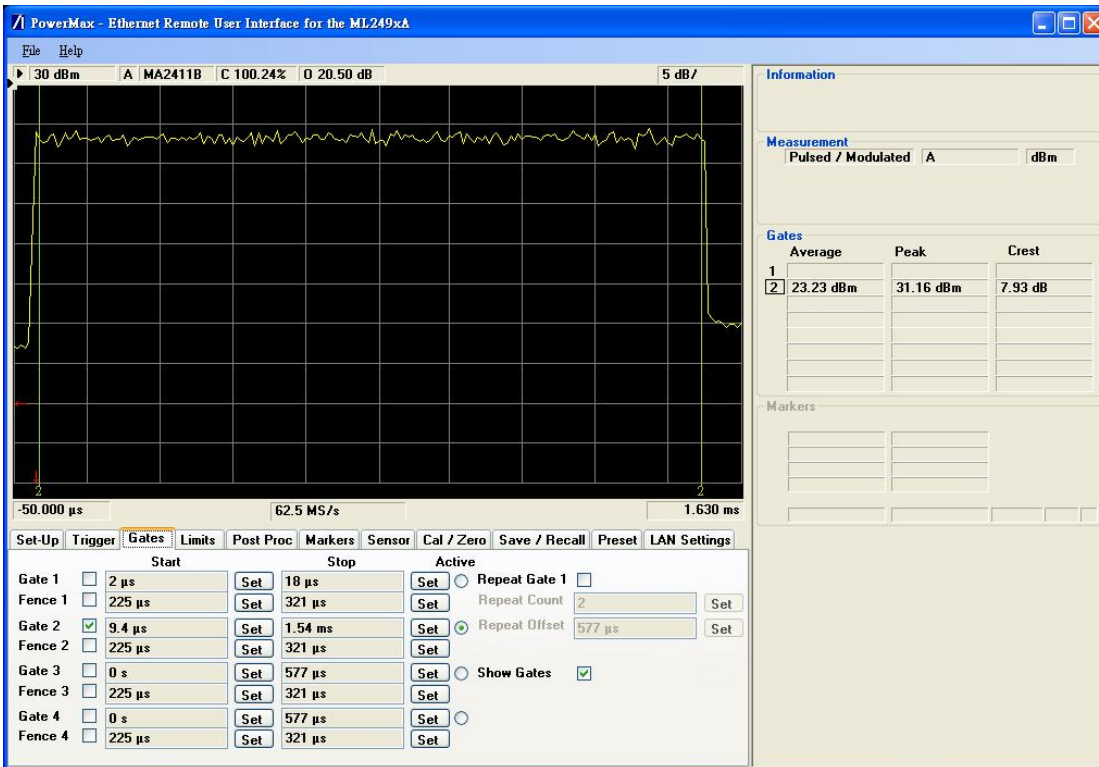





### 7.3 DUTY FACTOR

The transmitter maximum DL/UL symbol ratio is 29:18 with 15 traffic symbol transmitting at the max. power and three control symbols are not activate nor used in the SAR measurement, the duty cycle =  $15/48 = 0.3125$ .

Duty Factor =  $1/(\text{duty cycle}) = 3.2$  for this periodic pulse signal device.

The SAR measurement is compensated using factors is as the below list:

Channel BW	UL zone type	DL/UL Ratio	UL duty cycle	cf factor	UL modulation
5MHz	PUSC	29/18	32%	3.2	QPSK-1/2 QPSK-3/4 16QAM-1/2 16QAM-3/4
10MHz	PUSC	29/18	32%	3.2	QPSK-1/2 QPSK-3/4 16QAM-1/2 16QAM-3/4

Test plot of Duty cycle (Only show the plots of 5MHz / QPSK / middle channel)

## 7.4 SCALING FACTOR

Step-by-step control symbols Power and scaling parameters are as the following calculation:

- a. **Maximum Rated Output Power (MROP)** is provided by applicant.

Maximum Rated Output Power (MROP) Used to Calculate the Scaling Factor		
Mode	Antenna 1	Antenna 2
10MHz/QPSK	24dBm / 251.19 mW	24dBm / 251.19 mW
10MHz/16QAM	24dBm / 251.19 mW	24dBm / 251.19 mW
5MHz/QPSK	24dBm / 251.19 mW	24dBm / 251.19 mW
5MHz/16QAM	24dBm / 251.19 mW	24dBm / 251.19 mW

- b. For 10MHz Channel BW: The control channels may occupy up to 5 slots during normal operation. A slot is a sub-channel with the duration of 3 symbols. There are a total of 35 slots in the 10 MHz channel configuration. A maximum of two simultaneous CQICH reports are possible, which can occupy up to 2 slots. A maximum of three slots can be used for HARQ ACK/NAK by the five possible DL HARQ bursts in the previous DL frame. The 5 ACK/NAK bits each occupies ½ a slot. These 5 slots correspond to 5/35 of the total number of uplink slots.

Antenna 1	Calculation
35.88mW for 10MHz / QPSK	251.19mW x 5/35
35.88mW for 10MHz / 16QAM	251.19mW x 5/35

Antenna 2	Calculation
35.88mW for 10MHz / QPSK	251.19mW x 5/35
35.88mW for 10MHz / 16QAM	251.19mW x 5/35

- c. For 5 MHz Channel BW: The control channels may occupy up to 5 slots during normal operation. A slot is a sub-channel with the duration of 3 symbols. There are a total of 17 slots in 5 MHz channel configuration. A maximum of two simultaneous CQICH reports are possible, which can occupy up to 2 slots. A maximum of three slots can be used for HARQ ACK/NAK by the five possible DL HARQ bursts in the previous DL frame. The 5 ACK/NAK bits each occupies ½ a slot. These 5 slots correspond to 5/17 of the total number of uplink slots.

Antenna 1	Calculation
73.88 mW for 5MHz / QPSK	251.19 mW x 5/17
73.88 mW for 5MHz / 16QAM	251.19 mW x 5/17

Antenna 2	Calculation
73.88 mW for 5MHz / QPSK	251.19 mW x 5/17
73.88 mW for 5MHz / 16QAM	251.19 mW x 5/17

- d. The target output power for DL:UL ratio of 29:18 is calculated as the following:

$$\text{Target output power} = (\text{CCP} \times 3) + (\text{MROP} \times 15)$$

Modulation	Channel Bandwidth	29:18 DL:UL Ratio Power /mW	TX antenna
QPSK	10 MHz	$(35.88 \times 3) + (251.19 \times 15) = 3875.49$	1
16QAM	10 MHz	$(35.88 \times 3) + (251.19 \times 15) = 3875.49$	
QPSK	5 MHz	$(73.88 \times 3) + (251.19 \times 15) = 3989.49$	
16QAM	5 MHz	$(73.88 \times 3) + (251.19 \times 15) = 3989.49$	
QPSK	10 MHz	$(35.88 \times 3) + (251.19 \times 15) = 3875.49$	2
16QAM	10 MHz	$(35.88 \times 3) + (251.19 \times 15) = 3875.49$	
QPSK	5 MHz	$(73.88 \times 3) + (251.19 \times 15) = 3989.49$	
16QAM	5 MHz	$(73.88 \times 3) + (251.19 \times 15) = 3989.49$	



Scaling factor for Antenna 1 and 2 are shown on below tables.

Scaling factor

Freq./MHz	Measured Power (mW)	Number of Traffic Symbols	29:18 Traffic Symbol Power (Actual OP x 15) (mW)	29:18 Rated Power ((CCP x 3) + (MROP x 15)) (mW)	Scaling Factor (rated power/traffic power)
<b>10MHz / QPSK / antenna 1</b>					
2501	212.32	15	3184.80	3875.49	1.22
2593	222.84	15	3342.60	3875.49	1.16
2685	211.84	15	3177.60	3875.49	1.22
<b>10MHz / 16QAM / antenna 1</b>					
2501	208.92	15	3133.80	3875.49	1.24
2593	213.80	15	3207.00	3875.49	1.21
2685	210.86	15	3162.90	3875.49	1.23
<b>5MHz / QPSK / antenna 1</b>					
2498.5	240.99	15	3614.85	3989.49	1.10
2587	244.34	15	3665.10	3989.49	1.09
2687.5	229.09	15	3436.35	3989.49	1.16
<b>5MHz / 16QAM / antenna 1</b>					
2498.5	232.81	15	3492.15	3989.49	1.14
2587	236.05	15	3540.75	3989.49	1.13
2687.5	230.67	15	3460.05	3989.49	1.15
<b>10MHz / QPSK / antenna 2</b>					
2501	206.06	15	3090.90	3875.49	1.25
2593	212.81	15	3192.15	3875.49	1.21
2685	200.91	15	3013.65	3875.49	1.29
<b>10MHz / 16QAM / antenna 2</b>					
2501	204.17	15	3062.55	3875.49	1.27
2593	210.38	15	3155.7	3875.49	1.23
2685	203.24	15	3048.6	3875.49	1.27
<b>5MHz / QPSK / antenna 2</b>					
2498.5	230.67	15	3460.05	3989.49	1.15
2587	225.94	15	3389.1	3989.49	1.18
2687.5	208.93	15	3133.95	3989.49	1.27
<b>5MHz / 16QAM / antenna 2</b>					
2498.5	229.61	15	3444.15	3989.49	1.16
2587	217.77	15	3266.55	3989.49	1.22
2687.5	209.41	15	3141.15	3989.49	1.27

## 8. TEST SETUP

a. The test set-up is shown in the below picture.

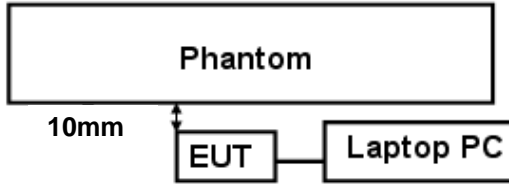

Linking up through air interface

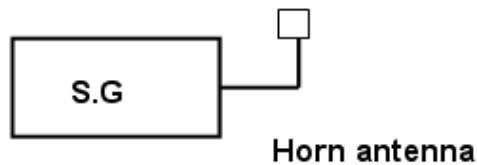

Output power of S.G is - 20dBm

Horn antenna has 10.6dBi gain at 2.5GHz

Distance between horn antenna and EUT is 4m

Figure 2 (For SAR measurement)

The Beceem test tool is used on the laptop.

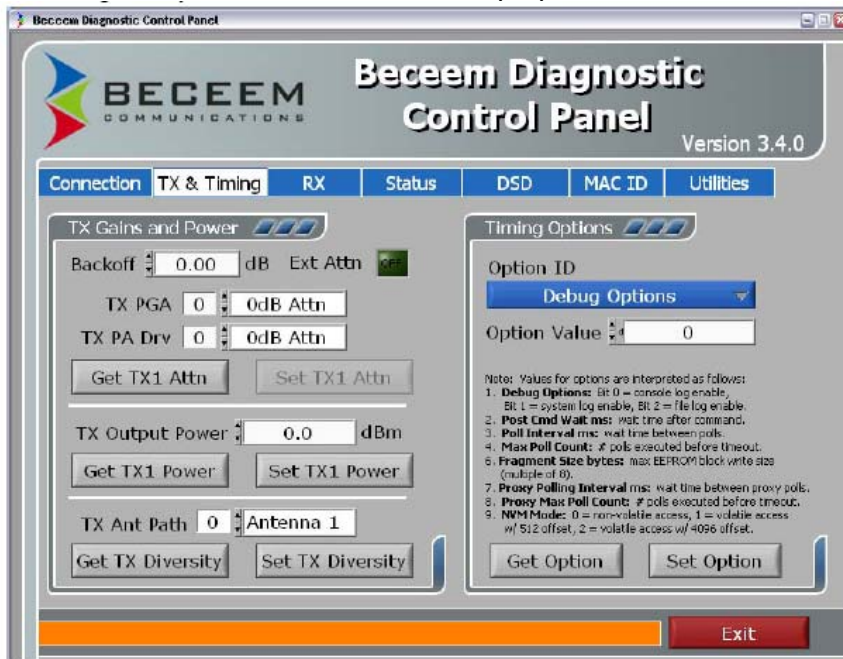

Under normal operating conditions the BS would be responsible for controlling the MS Tx power. When working with a BS, the MS cannot Tx at a power greater than the max power requested by Kannon.

On the network side, there is a vector signal generator as below:

Agilent E4438C ESG with below options:

N7613A: Signal Studio for 802.16-2004 WiMAX

N7615B: Signal studio for 802.16 WiMAX

Software is loaded into the E4438C ESG that produces an output signal that looks like a 29:18 WiMAX frame, the EUT detects the “network” and begins to transmit based on the commands from the ESG signal and the measurements are then taken on the EUT.

**b. Communication Test Set Details**

Modulation and channel bandwidth is controlled by the BSE, the test set details are listed below.

<b>Bandwidth</b>	10MHz	5MHz	10MHz	5MHz	10MHz	5MHz	10MHz	5MHz
<b>FFT size</b>	1024	512	1024	512	1024	512	1024	512
<b>DL/UL ratio</b>	29:18							
Up link								
<b>MCS</b>	PUSC	PUSC	PUSC	PUSC	PUSC	PUSC	PUSC	PUSC
<b>Up link</b>	QPSK-1/2	16QAM-3/4	QPSK-3/4	16QAM-1/2	QPSK-3/4	16QAM-1/2	QPSK-3/4	16QAM-1/2

## 9. TEST RESULTS

### 9.1 TEST PROCEDURES

The EUT plugged into the notebook. Use the software to control the EUT channel and transmission power. Then record the conducted power before the testing. Place the EUT to the specific test location. After the testing, must writing down the conducted power of the EUT into the report. The SAR value was calculated via the 3D spline interpolation algorithm that has been implemented in the software of DASY5 SAR measurement system manufactured and calibrated by SPEAG. According to the IEEE 1528 standards, the recommended procedure for assessing the peak spatial-average SAR value consists of the following steps:

- Power reference measurement
- Verification of the power reference measurement
- Area scan
- Zoom scan
- Power reference measurement

The area scan was performed for the highest spatial SAR location. The zoom scan was performed for SAR value averaged over 1g and 10g spatial volumes.



In the zoom scan, the distance between the measurement point at the probe sensor location (geometric center behind the probe tip) and the phantom surface is 2mm and maintained at a constant distance of  $\pm 0.5\text{mm}$  during a zoom scan to determine peak SAR locations. The distance is 2mm between the first measurement point and the bottom surface of the phantom. The secondary measurement point to the bottom surface of the phantom is with 8mm separation distance. The cube size is  $7 \times 7 \times 7$  points consists of 343 points and the grid space is 5mm.

The measurement time is 0.5s at each point of the zoom scan. The probe boundary effect compensation shall be applied during the SAR test. Because of the tip of the probe to the Phantom surface separated distances are longer than half a tip probe diameter.

In the area scan, the separation distance is 2mm between the each measurement point and the phantom surface. The scan size shall be included the transmission portion of the EUT. The measurement time is the same as the zoom scan. At last the reference power drift shall be less than  $\pm 5\%$ .



A D T

## 9.2 MEASURED SAR RESULTS

### FOR WiMAX: For 5MHz

SAR ( W/ kg )			Top		Bottom		Back Edge		Right Edge	
ANTENNA			Ant. 1							
Channel	Freq (MHz)	Scaling factor	Meas.	Scaled	Meas.	Scaled	Meas.	Scaled	Meas.	Scaled
Middle	2587	1.09	0.080	0.087	0.028	0.031	0.00922	0.010	0.181	0.197

SAR ( W/ kg )			Top		Bottom		Back Edge		Left Edge	
ANTENNA			Ant. 2							
Channel	Freq (MHz)	Scaling factor	Meas.	Scaled	Meas.	Scaled	Meas.	Scaled	Meas.	Scaled
Low	2498.5	1.15	0.135	0.155	0.102	0.117	0.0095	0.011	0.322	0.370

### For 10MHz

SAR ( W/ kg )			Top		Bottom		Back Edge		Right Edge	
ANTENNA			Ant. 1							
Channel	Freq (MHz)	Scaling factor	Meas.	Scaled	Meas.	Scaled	Meas.	Scaled	Meas.	Scaled
Middle	2593	1.16	0.073	0.085	0.033	0.038	0.00957	0.011	0.184	0.213

SAR ( W/ kg )			Top		Bottom		Back Edge		Left Edge	
ANTENNA			Ant. 2							
Channel	Freq (MHz)	Scaling factor	Meas.	Scaled	Meas.	Scaled	Meas.	Scaled	Meas.	Scaled
Middle	2593	1.21	0.201	0.243	0.144	0.174	0.0096	0.012	0.246	0.298

#### NOTE:

1. In this testing, the limit for General Population Spatial Peak averaged over 1g, **1.6 W/kg**, is applied.
2. Please see the Appendix A for the data.
3. The variation of the EUT conducted power measured before and after SAR testing should not over 5%.
4. Since 16QAM maximum output power is  $\leq \frac{1}{4}$  dB higher than QPSK and QPSK SAR is  $< 0.8$  W/kg, 16QAM SAR is not needed





A D T

**FOR WIFI:**

Stand-alone SAR (1g)					
Position	BODY				
	Top	Bottom	Front Edge	Left Edge	Right Edge
<b>11b</b>					
<b>Ant 1: 2437MHz</b>	0.024	0.036	0.027	<b>0.038</b>	-
<b>Ant 2: 2437MHz</b>	0.015	0.011	0.00897	0.00293	0.00221

**NOTE:**

1. In this testing, the limit for General Population Spatial Peak averaged over 1g, **1.6 W/kg**, is applied.
2. Please see the Appendix A for the data.
3. The variation of the EUT conducted power measured before and after SAR testing should not over 5%.
4. SAR is not required for 802.11g / 11n 20MHz / 11 n 40MHz channels since the maximum average output power is less than ¼ dB higher than that measured on the corresponding 802.11b channels
5. Per KDB 447498, when 1-g SAR for the highest output channel is less than 0.8 W/kg, where the transmission band corresponding to all channels is ≤ 100 MHz, testing for the other channels is not required



### 9.3 SIMULTANEOUS TRANSMISSION CONFIGURATION

The device has WiFi and WiMAX function and supports external 3G dongle.

Simultaneous transmission mode for the device is as below

1. WiFi + WiMAX
2. WiFi + external dongle

WiMAX and external dongle can Not work at the same time.

All possible combinations of simultaneous transmission configuration	
1	WiFi antenna 1+ WiMAX antenna 1
2	WiFi antenna 1+ WiMAX antenna 2
3	WiFi antenna 2+ WiMAX antenna 1
4	WiFi antenna 2+ WiMAX antenna 2
5	WiFi antenna 1+ External dongle
6	WiFi antenna 2+ External dongle



### 9.4 NO SIMULTANEOUS SAR JUSTIFICATION

The device has WiFi and WiMAX function and supports external 3G dongle.

Simultaneous transmission mode for the device is as below

1. WiFi + WiMAX
2. WiFi + external dongle

WiMAX and external dongle can Not work at the same time.

#### WiFi and WiMAX

Simultaneous Transmission Configurations		WiFi Max. SAR (W/Kg ) (1g)	WiMAX Max. Scaled SAR (W/Kg ) (1g)	all SAR <sub>1g</sub> (W/Kg ) (1g)
1	WiFi antenna 1+ WiMAX antenna 1	0.038	0.213	0.251
2	WiFi antenna 1+ WiMAX antenna 2	0.038	0.370	0.408
3	WiFi antenna 2+ WiMAX antenna 1	0.015	0.213	0.228
4	WiFi antenna 2+ WiMAX antenna 2	0.015	0.370	0.385

Since the sum of SAR value is less than 1.6 W/kg, therefore simultaneous Transmission SAR for WiFi and WiMAX is not required

#### WiFi and external dongle

Simultaneous Transmission Configurations		WiFi SAR (W/Kg )(1g)	External dongle (W/Kg ) (1g)	Separation distance(cm)	SPLSR <sub>xy</sub>
5	WiFi antenna 1+ External dongle	0.038	1.6	11.4*	0.14
6	WiFi antenna 2+ External dongle	0.015	1.6	12.1*	0.13

Since the **SPLSR<sub>xy</sub>** is less than 0.3, therefore simultaneous Transmission SAR for WiFi and external dongle is not required

WiFi antenna 1 test plot

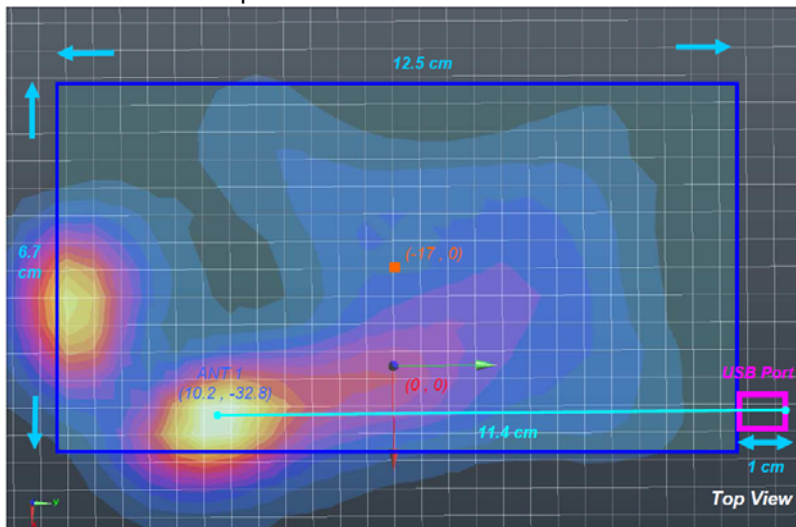

WiFi antenna 2 test plot

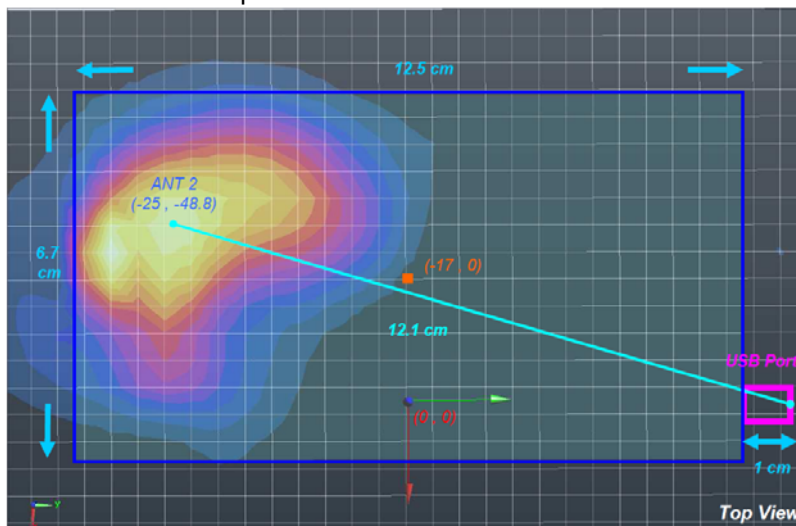

Combined test plot

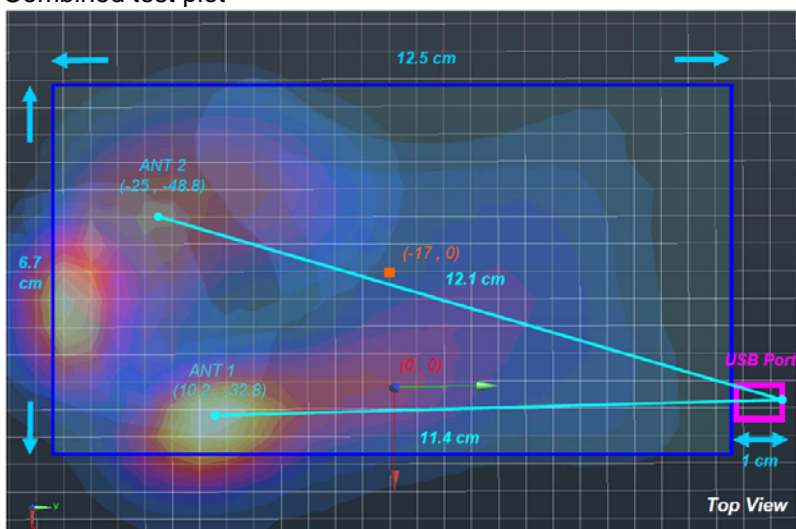



A D T

## 10. SAR LIMITS

HUMAN EXPOSURE	SAR (W/kg)	
	(GENERAL POPULATION / UNCONTROLLED EXPOSURE ENVIRONMENT)	(OCCUPATIONAL / CONTROLLED EXPOSURE ENVIRONMENT)
Spatial Average (whole body)	0.08	0.4
Spatial Peak (averaged over 1 g)	<b>1.6</b>	8.0
Spatial Peak (hands / wrists / feet / ankles averaged over 10 g)	4.0	20.0

**NOTE:** This limits accord to 47 CFR 2.1093 – Safety Limit.

## 11. SAR ERROR CONSIDERATION

In order to estimate the measurement error due to PAR issues, the configuration with the highest SAR in each channel bandwidth and frequency band is measured at various power level. Test conditions are as below

Test position: Bottom  
 Test frequency: 2593MHz for 5MHz bandwidth  
 2685MHz for 10MHz bandwidth  
 Modulation: QPSK 1/2, 16QAM 1/2

By tuning different power on this EUT and measuring the relative SAR to verify the high PAR of OFDM/OFDMA is as below:

For 5MHz / QPSK / 2498.5MHz / Left Edge

SAR (W/kg)	Power (mW)	12.79	25.70	51.29	102.33	204.17	224.91
5MHz	Point SAR	0.036	0.074	0.149	0.297	0.612	0.694
	Linear line	0.036	0.072	0.144	0.288	0.575	0.633
	Deviation(%)	0.00%	2.78%	3.47%	3.13%	6.43%	9.64%

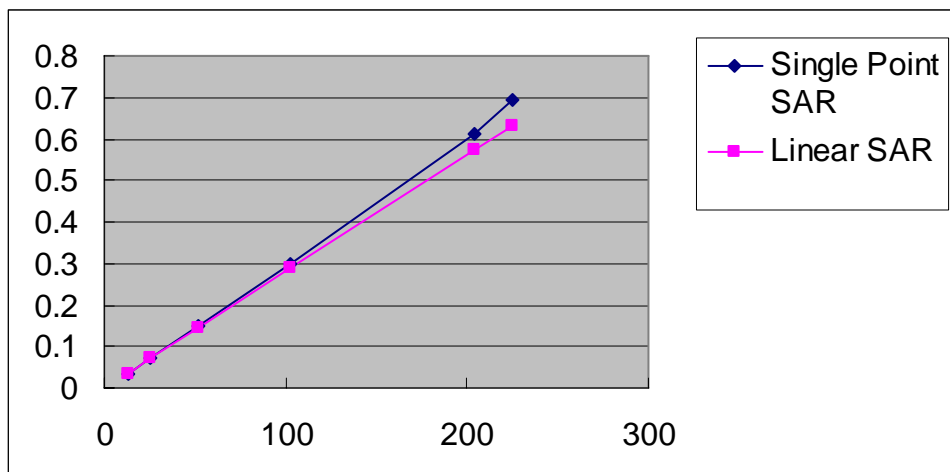

For 5MHz / 16QAM / 2498.5MHz / Left Edge

SAR (W/kg)	Power (mW)	12.68	25.47	50.58	103.75	202.77	224.91
5MHz	Point SAR	0.035	0.071	0.142	0.29	0.594	0.673
	Linear line	0.035	0.07	0.14	0.286	0.56	0.621
	Deviation(%)	0.00%	1.43%	1.43%	1.40%	6.07%	8.37%

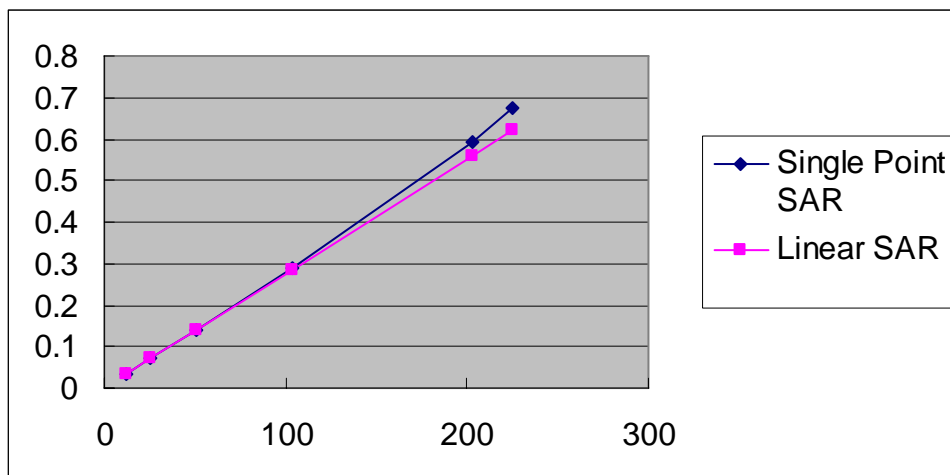

For 10MHz / QPSK / 2593MHz / Left Edge

SAR (W/kg)	Power (mW)	12.74	25.53	50.35	101.16	201.37	216.27
10MHz	Point SAR	0.03	0.064	0.124	0.254	0.51	0.554
	Linear line	0.03	0.06	0.119	0.238	0.474	0.509
	Deviation(%)	0.00%	6.67%	4.20%	6.72%	7.59%	8.84%

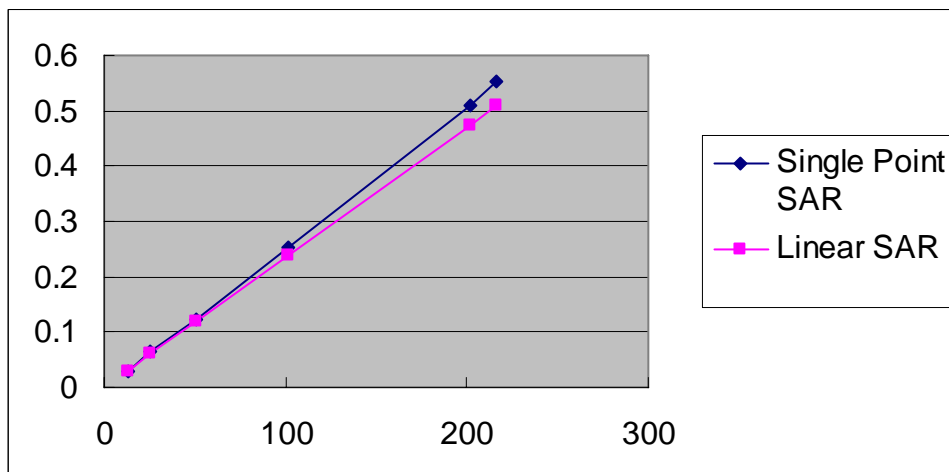

For 10MHz / 16QAM / 2593MHz / Left Edge

SAR (W/kg)	Power (mW)	12.88	25.29	50.58	101.62	202.30	213.80
10MHz	Point SAR	0.031	0.063	0.124	0.253	0.513	0.543
	Linear line	0.031	0.061	0.122	0.245	0.487	0.515
	Deviation(%)	0.00%	3.28%	1.64%	3.27%	5.34%	5.44%

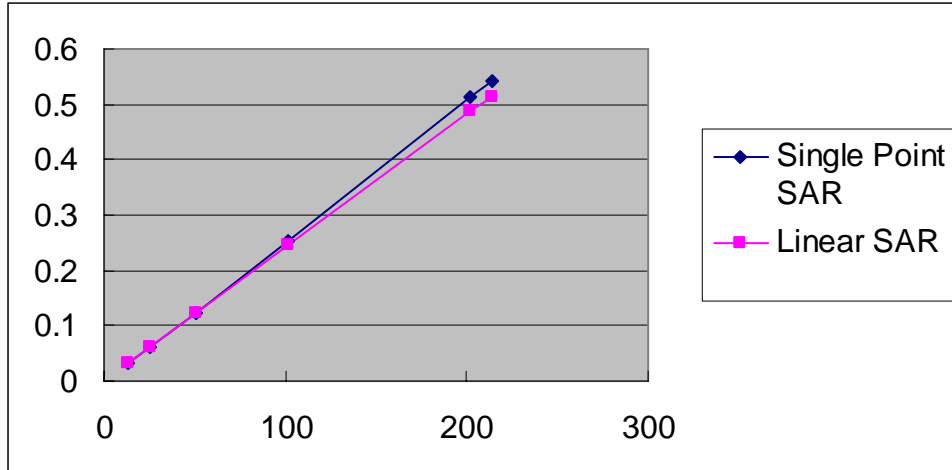





## 12. INFORMATION ON THE TESTING LABORATORIES

We, Bureau Veritas Consumer Products Services (H.K.) Ltd., Taoyuan Branch, were founded in 1988 to provide our best service in EMC, Radio, Telecom and Safety consultation. Our laboratories are accredited and approved according to ISO/IEC 17025.

Copies of accreditation certificates of our laboratories obtained from approval agencies can be downloaded from our web site: [www.adt.com.tw/index.5/phtml](http://www.adt.com.tw/index.5/phtml). If you have any comments, please feel free to contact us at the following:

**Linko EMC/RF Lab:**

Tel: 886-2-26052180

Fax: 886-2-26051924

**Hsin Chu EMC/RF Lab:**

Tel: 886-3-5935343

Fax: 886-3-5935342

**Hwa Ya EMC/RF/Safety/Telecom Lab:**

Tel: 886-3-3183232

Fax: 886-3-3185050

**Web Site:** [www.adt.com.tw](http://www.adt.com.tw)

The address and road map of all our labs can be found in our web site also.

---END---



香港商立德國際商品試驗有限公司桃園分公司

Bureau Veritas Consumer Products Services (H.K.) Ltd., Taoyuan Branch

A D T

## APPENDIX A: TEST DATA

DUT: TabletRock ; MODEL Name: PHS2000W

### Liquid Level Photo

Tissue 2600MHz D=150mm





## M01-WiMax 5M-Ch354 / Ant 1

Communication System: Wimax\_2.6GHz 5M ; Frequency: 2587 MHz ; Duty Cycle: 1:3.24 ; Modulation type: QPSK

Medium: MSL2600 Medium parameters used:  $f = 2587$  MHz;  $\sigma = 2.15$  mho/m;  $\epsilon_r = 53.39$ ;  $\rho = 1000$  kg/m<sup>3</sup>

Phantom section: Flat Section ; Separation distance : 10 mm (The top side of the EUT to the Phantom)

DASY5 Configuration:

- Probe: EX3DV4 - SN3590; ConvF(8.04, 8.04, 8.04); Calibrated: 2010/3/25
- Sensor-Surface: 2mm (Mechanical Surface Detection)
- Electronics: DAE4 Sn861; Calibrated: 2010/1/22
- Phantom: SAM with CRP; Type: SAM; Serial: TP-1485
- Measurement SW: DASY5, V5.2 Build 162; SEMCAD X Version 14.0 Build 61

**Flat-Section MSL/Flat Section 10mm/Area Scan (13x20x1):** Measurement grid: dx=8mm, dy=8mm

Maximum value of SAR (measured) = 0.113 mW/g

**Flat-Section MSL/Flat Section 10mm/Zoom Scan (7x7x7)/Cube 0:** Measurement grid: dx=5mm, dy=5mm, dz=5mm

Reference Value = 1.53 V/m; Power Drift = 0.120 dB

Peak SAR (extrapolated) = 0.172 W/kg

**SAR(1 g) = 0.080 mW/g; SAR(10 g) = 0.037 mW/g**

Maximum value of SAR (measured) = 0.123 mW/g

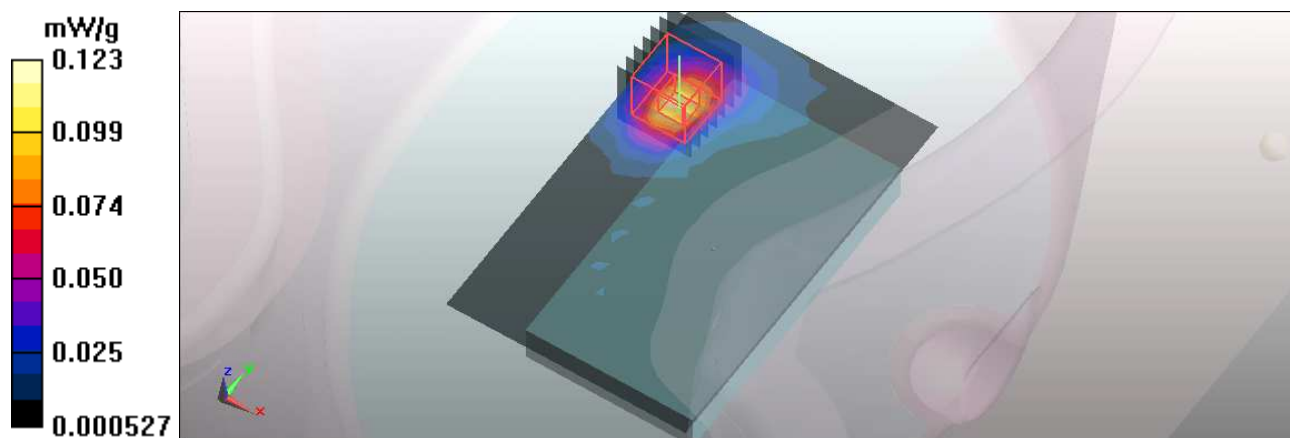



## M02-WiMax 5M-Ch354 / Ant 1

Communication System: Wimax\_2.6GHz 5M ; Frequency: 2587 MHz ; Duty Cycle: 1:3.24 ; Modulation type: QPSK

Medium: MSL2600 Medium parameters used:  $f = 2587$  MHz;  $\sigma = 2.15$  mho/m;  $\epsilon_r = 53.39$ ;  $\rho = 1000$  kg/m<sup>3</sup>

Phantom section: Flat Section ; Separation distance : 10 mm (The bottom side of the EUT to the Phantom)

DASY5 Configuration:

- Probe: EX3DV4 - SN3590; ConvF(8.04, 8.04, 8.04); Calibrated: 2010/3/25
- Sensor-Surface: 2mm (Mechanical Surface Detection)
- Electronics: DAE4 Sn861; Calibrated: 2010/1/22
- Phantom: SAM with CRP; Type: SAM; Serial: TP-1485
- Measurement SW: DASY5, V5.2 Build 162; SEMCAD X Version 14.0 Build 61

**Flat-Section MSL/Flat Section 10mm/Area Scan (13x20x1):** Measurement grid: dx=8mm, dy=8mm

Maximum value of SAR (measured) = 0.041 mW/g

**Flat-Section MSL/Flat Section 10mm/Zoom Scan (7x7x7)/Cube 0:** Measurement grid: dx=5mm, dy=5mm, dz=5mm

Reference Value = 1.07 V/m; Power Drift = 0.118 dB

Peak SAR (extrapolated) = 0.066 W/kg

**SAR(1 g) = 0.028 mW/g; SAR(10 g) = 0.012 mW/g**

Maximum value of SAR (measured) = 0.043 mW/g

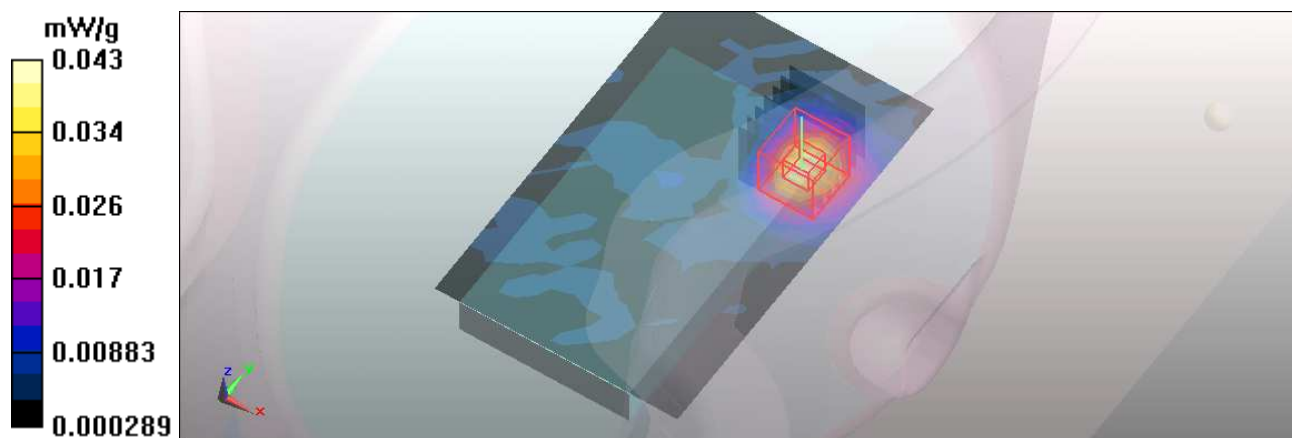



## M03-WiMax 5M-Ch354 / Ant 1

Communication System: Wimax\_2.6GHz 5M ; Frequency: 2587 MHz ; Duty Cycle: 1:3.24 ; Modulation type: QPSK

Medium: MSL2600 Medium parameters used:  $f = 2587$  MHz;  $\sigma = 2.15$  mho/m;  $\epsilon_r = 53.39$ ;  $\rho = 1000$  kg/m<sup>3</sup>

Phantom section: Flat Section ; Separation distance : 10 mm (The right edge side of the EUT to the Phantom)

DASY5 Configuration:

- Probe: EX3DV4 - SN3590; ConvF(8.04, 8.04, 8.04); Calibrated: 2010/3/25
- Sensor-Surface: 2mm (Mechanical Surface Detection)
- Electronics: DAE4 Sn861; Calibrated: 2010/1/22
- Phantom: SAM with CRP; Type: SAM; Serial: TP-1485
- Measurement SW: DASY5, V5.2 Build 162; SEMCAD X Version 14.0 Build 61

**Flat-Section MSL/Flat Section 10mm/Area Scan (8x20x1):** Measurement grid: dx=8mm, dy=8mm

Maximum value of SAR (measured) = 0.235 mW/g

**Flat-Section MSL/Flat Section 10mm/Zoom Scan (7x7x7)/Cube 0:** Measurement grid: dx=5mm, dy=5mm, dz=5mm

Reference Value = 1.49 V/m; Power Drift = 0.135 dB

Peak SAR (extrapolated) = 0.407 W/kg

**SAR(1 g) = 0.181 mW/g; SAR(10 g) = 0.075 mW/g**

Maximum value of SAR (measured) = 0.294 mW/g

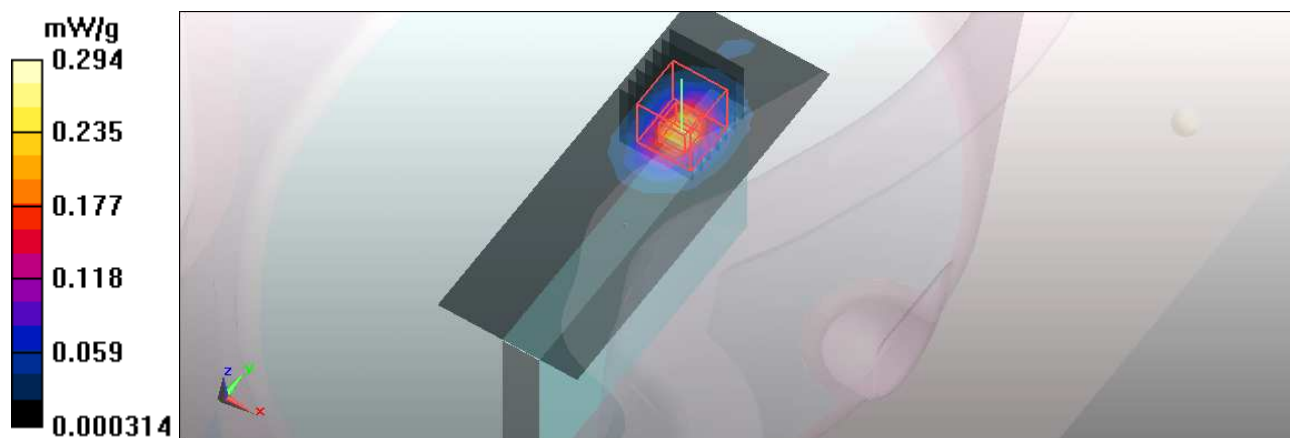

## M04-WiMax 5M-Ch354 / Ant 1

Communication System: Wimax\_2.6GHz 5M ; Frequency: 2587 MHz ; Duty Cycle: 1:3.24 ; Modulation type: QPSK

Medium: MSL2600 Medium parameters used:  $f = 2587$  MHz;  $\sigma = 2.15$  mho/m;  $\epsilon_r = 53.39$ ;  $\rho = 1000$  kg/m<sup>3</sup>

Phantom section: Flat Section ; Separation distance : 10 mm (The back edge side of the EUT to the Phantom)

DASY5 Configuration:

- Probe: EX3DV4 - SN3590; ConvF(8.04, 8.04, 8.04); Calibrated: 2010/3/25
- Sensor-Surface: 2mm (Mechanical Surface Detection)
- Electronics: DAE4 Sn861; Calibrated: 2010/1/22
- Phantom: SAM with CRP; Type: SAM; Serial: TP-1485
- Measurement SW: DASY5, V5.2 Build 162; SEMCAD X Version 14.0 Build 61

**Flat-Section MSL/Flat Section 10mm/Area Scan (7x17x1):** Measurement grid: dx=8mm, dy=8mm

Maximum value of SAR (measured) = 0.014 mW/g

**Flat-Section MSL/Flat Section 10mm/Zoom Scan (7x7x7)/Cube 0:** Measurement grid: dx=5mm, dy=5mm, dz=5mm

Reference Value = 0.480 V/m; Power Drift = 0.196 dB

Peak SAR (extrapolated) = 0.025 W/kg

**SAR(1 g) = 0.00922 mW/g; SAR(10 g) = 0.00446 mW/g**

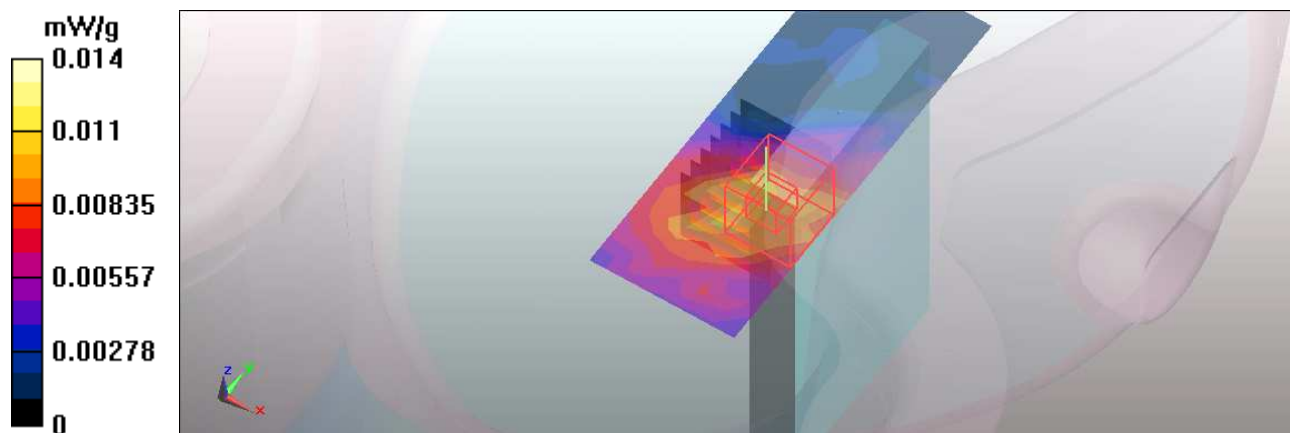



## M05-WiMax 5M-Ch0 / Ant 2

Communication System: Wimax\_2.6GHz 5M ; Frequency: 2498.5 MHz ; Duty Cycle: 1:3.24 ;  
Modulation type: QPSK

Medium: MSL2600 Medium parameters used:  $f = 2498.5$  MHz;  $\sigma = 2.06$  mho/m;  $\epsilon_r = 53.68$ ;  $\rho = 1000$  kg/m<sup>3</sup>

Phantom section: Flat Section ; Separation distance : 10 mm (The top side of the EUT to the Phantom)

DASY5 Configuration:

- Probe: EX3DV4 - SN3590; ConvF(8.04, 8.04, 8.04); Calibrated: 2010/3/25
- Sensor-Surface: 2mm (Mechanical Surface Detection)
- Electronics: DAE4 Sn861; Calibrated: 2010/1/22
- Phantom: SAM with CRP; Type: SAM; Serial: TP-1485
- Measurement SW: DASY5, V5.2 Build 162; SEMCAD X Version 14.0 Build 61

**Flat-Section MSL/Flat Section 10mm/Area Scan (13x20x1):** Measurement grid: dx=8mm, dy=8mm

Maximum value of SAR (measured) = 0.173 mW/g

**Flat-Section MSL/Flat Section 10mm/Zoom Scan (7x7x7)/Cube 0:** Measurement grid: dx=5mm, dy=5mm, dz=5mm

Reference Value = 2.35 V/m; Power Drift = 0.127 dB

Peak SAR (extrapolated) = 0.265 W/kg

**SAR(1 g) = 0.135 mW/g; SAR(10 g) = 0.065 mW/g**

Maximum value of SAR (measured) = 0.200 mW/g

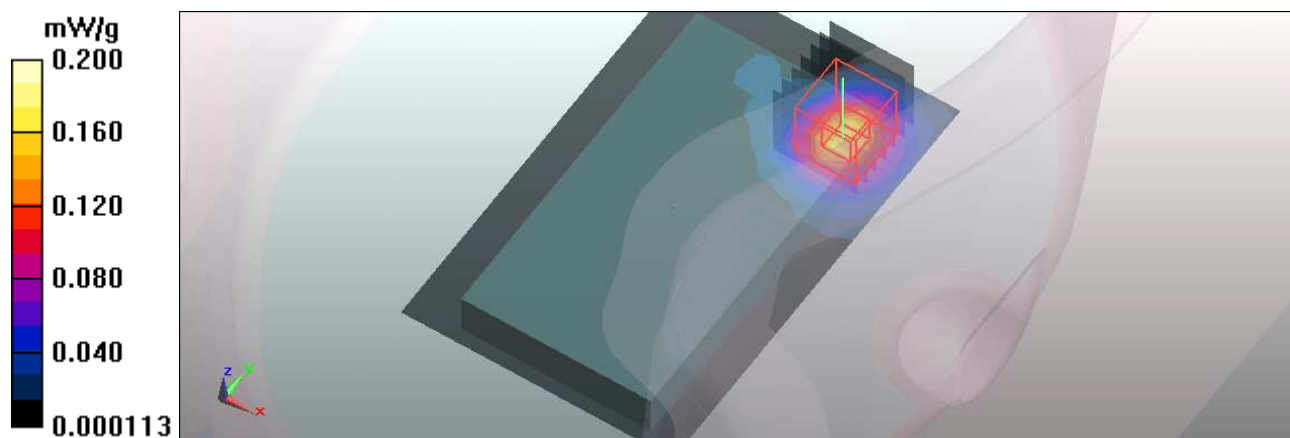





## M06-WiMax 5M-Ch0 / Ant 2

Communication System: Wimax\_2.6GHz 5M ; Frequency: 2498.5 MHz ; Duty Cycle: 1:3.24 ;  
Modulation type: QPSK

Medium: MSL2600 Medium parameters used:  $f = 2498.5$  MHz;  $\sigma = 2.06$  mho/m;  $\epsilon_r = 53.68$ ;  $\rho = 1000$  kg/m<sup>3</sup>

Phantom section: Flat Section ; Separation distance : 10 mm (The bottom side of the EUT to the Phantom)

DASY5 Configuration:

- Probe: EX3DV4 - SN3590; ConvF(8.04, 8.04, 8.04); Calibrated: 2010/3/25
- Sensor-Surface: 2mm (Mechanical Surface Detection)
- Electronics: DAE4 Sn861; Calibrated: 2010/1/22
- Phantom: SAM with CRP; Type: SAM; Serial: TP-1485
- Measurement SW: DASY5, V5.2 Build 162; SEMCAD X Version 14.0 Build 61

**Flat-Section MSL/Flat Section 10mm/Area Scan (13x20x1):** Measurement grid: dx=8mm, dy=8mm

Maximum value of SAR (measured) = 0.149 mW/g

**Flat-Section MSL/Flat Section 10mm/Zoom Scan (7x7x7)/Cube 0:** Measurement grid: dx=5mm, dy=5mm, dz=5mm

Reference Value = 2.04 V/m; Power Drift = 0.151 dB

Peak SAR (extrapolated) = 0.199 W/kg

**SAR(1 g) = 0.102 mW/g; SAR(10 g) = 0.050 mW/g**

Maximum value of SAR (measured) = 0.148 mW/g

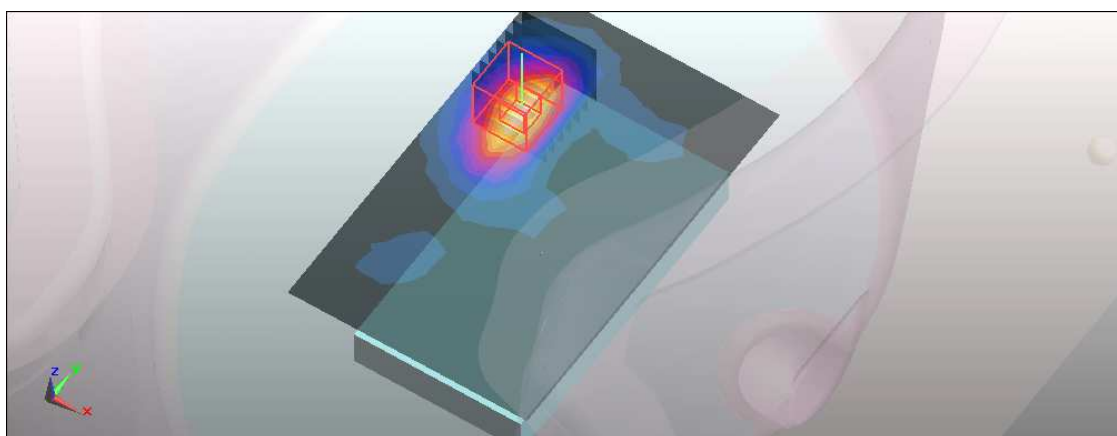
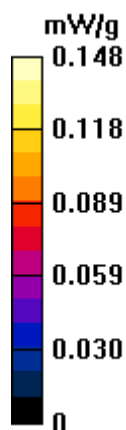



## M07-WiMax 5M-Ch0 / Ant 2

Communication System: Wimax\_2.6GHz 5M ; Frequency: 2498.5 MHz ; Duty Cycle: 1:3.24 ;  
Modulation type: QPSK

Medium: MSL2600 Medium parameters used:  $f = 2498.5$  MHz;  $\sigma = 2.06$  mho/m;  $\epsilon_r = 53.68$ ;  $\rho = 1000$  kg/m<sup>3</sup>

Phantom section: Flat Section ; Separation distance : 10 mm (The left edge side of the EUT to the Phantom)

DASY5 Configuration:

- Probe: EX3DV4 - SN3590; ConvF(8.04, 8.04, 8.04); Calibrated: 2010/3/25
- Sensor-Surface: 2mm (Mechanical Surface Detection)
- Electronics: DAE4 Sn861; Calibrated: 2010/1/22
- Phantom: SAM with CRP; Type: SAM; Serial: TP-1485
- Measurement SW: DASY5, V5.2 Build 162; SEMCAD X Version 14.0 Build 61

**Flat-Section MSL/Flat Section 10mm/Area Scan (8x20x1):** Measurement grid: dx=8mm, dy=8mm

Maximum value of SAR (measured) = 0.470 mW/g

**Flat-Section MSL/Flat Section 10mm/Zoom Scan (7x7x7)/Cube 0:** Measurement grid: dx=5mm, dy=5mm, dz=5mm

Reference Value = 3.37 V/m; Power Drift = -0.042 dB

Peak SAR (extrapolated) = 0.651 W/kg

**SAR(1 g) = 0.322 mW/g; SAR(10 g) = 0.151 mW/g**

Maximum value of SAR (measured) = 0.487 mW/g

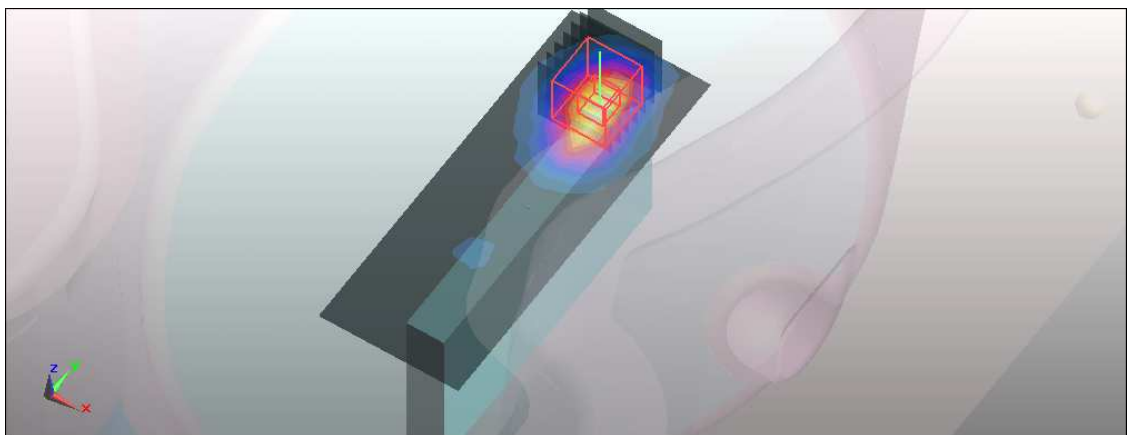
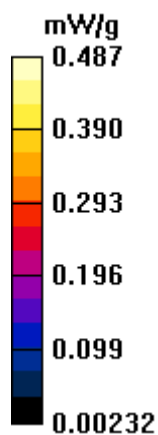



香港商立德國際商品試驗有限公司桃園分公司

Bureau Veritas Consumer Products Services (H.K.) Ltd., Taoyuan Branch

A D T

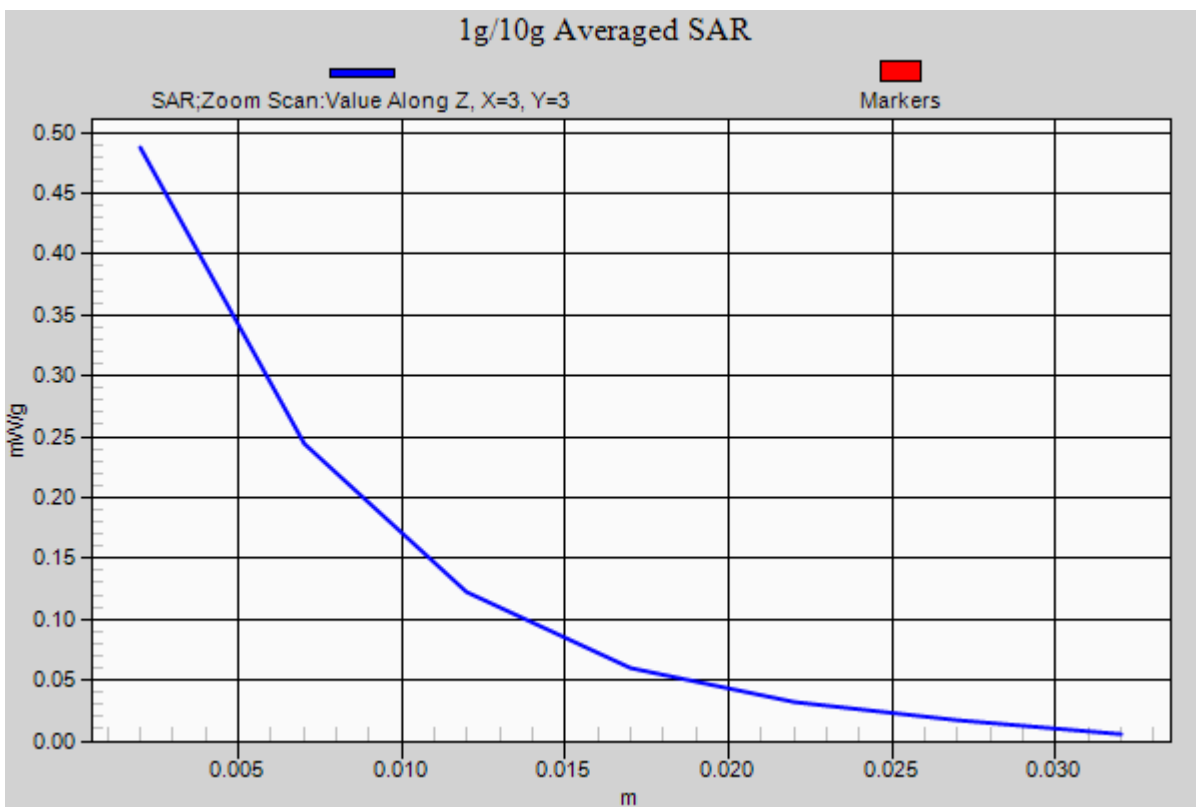



### M08-WiMax 5M-Ch0 / Ant 2

Communication System: 802.11b ; Frequency: 2498.5 MHz ; Duty Cycle: 1:3.24 ; Modulation type: QPSK

Medium: MSL2600 Medium parameters used :  $f = 2498.5 \text{ MHz}$ ;  $\sigma = 2.06 \text{ mho/m}$ ;  $\epsilon_r = 53.68$ ;  $\rho = 1000 \text{ kg/m}^3$

Phantom section: Flat Section ; Separation distance : 10 mm (The back edge side of the EUT to the Phantom)

DASY5 Configuration:

- Probe: EX3DV4 - SN3590; ConvF(8.04, 8.04, 8.04); Calibrated: 2010/3/25
- Sensor-Surface: 2mm (Mechanical Surface Detection)
- Electronics: DAE4 Sn861; Calibrated: 2010/1/22
- Phantom: SAM with CRP; Type: SAM; Serial: TP-1485
- Measurement SW: DASY5, V5.2 Build 162; SEMCAD X Version 14.0 Build 61

**Flat-Section MSL/Flat Section 10mm /Area Scan (12x18x1):** Measurement grid:  $dx=8\text{mm}$ ,  $dy=8\text{mm}$

Maximum value of SAR (measured) = 0.015 mW/g

**Flat-Section MSL/Flat Section 10mm /Zoom Scan (7x7x7)/Cube 0:** Measurement grid:  $dx=5\text{mm}$ ,  $dy=5\text{mm}$ ,  $dz=5\text{mm}$

Reference Value = 1.55 V/m; Power Drift = -0.113 dB

Peak SAR (extrapolated) = 0.025 W/kg

**SAR(1 g) = 0.0095 mW/g; SAR(10 g) = 0.0047 mW/g**

Maximum value of SAR (measured) = 0.014 mW/g

**Flat-Section MSL/Flat Section 10mm /Zoom Scan (7x7x7)/Cube 1:** Measurement grid:  $dx=5\text{mm}$ ,  $dy=5\text{mm}$ ,  $dz=5\text{mm}$

Reference Value = 1.55 V/m; Power Drift = -0.113 dB

Peak SAR (extrapolated) = 0.019 W/kg

**SAR(1 g) = 0.00949 mW/g; SAR(10 g) = 0.00553 mW/g**

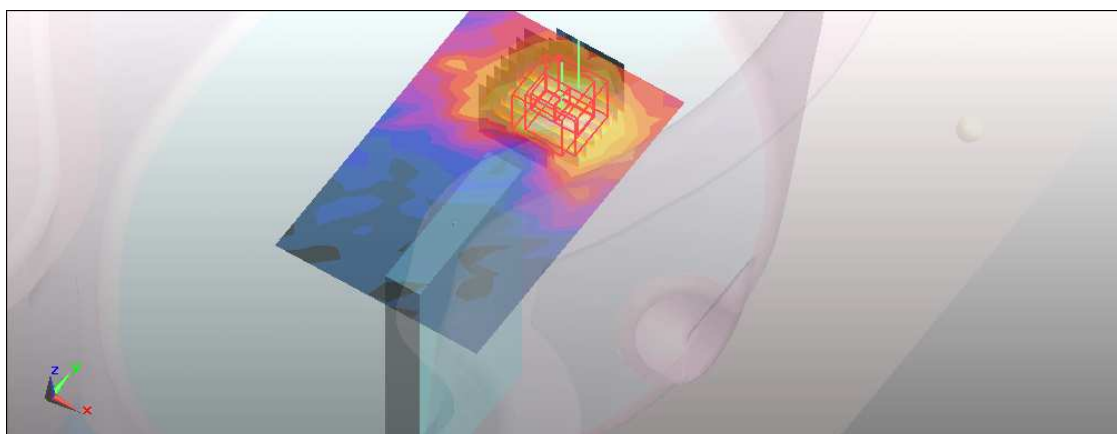
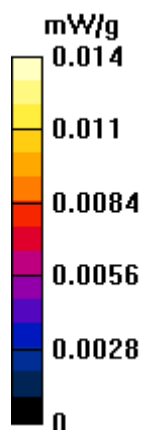



## M09-WiMax 10M-Ch368 / Ant 1

Communication System: Wimax\_2.6GHz 10M ; Frequency: 2593 MHz ; Duty Cycle: 1:3.24  
Medium: MSL2600 Medium parameters used:  $f = 2593$  MHz;  $\sigma = 2.16$  mho/m;  $\epsilon_r = 53.34$ ;  $\rho = 1000$  kg/m<sup>3</sup>

Phantom section: Flat Section ; DUT test position : Body ; Modulation Type: QPSK  
Separation Distance : 10 mm ( The top side of the EUT to the Phantom)

DASY5 Configuration:

- Probe: EX3DV4 - SN3590; ConvF(8.04, 8.04, 8.04); Calibrated: 2010/3/25
- Sensor-Surface: 2mm (Mechanical Surface Detection)
- Electronics: DAE4 Sn861; Calibrated: 2010/1/22
- Phantom: SAM with CRP; Type: SAM; Serial: TP-1485
- Measurement SW: DASY5, V5.2 Build 162; SEMCAD X Version 14.0 Build 61

**Flat-Section MSL/Flat Section 10mm Mid /Area Scan (13x20x1):** Measurement grid:

$dx=8$ mm,  $dy=8$ mm

Maximum value of SAR (measured) = 0.116 mW/g

**Flat-Section MSL/Flat Section 10mm Mid /Zoom Scan (7x7x7)/Cube 0:** Measurement

grid:  $dx=5$ mm,  $dy=5$ mm,  $dz=5$ mm

Reference Value = 1.64 V/m; Power Drift = 0.173 dB

Peak SAR (extrapolated) = 0.155 W/kg

**SAR(1 g) = 0.073 mW/g; SAR(10 g) = 0.034 mW/g**

Maximum value of SAR (measured) = 0.112 mW/g

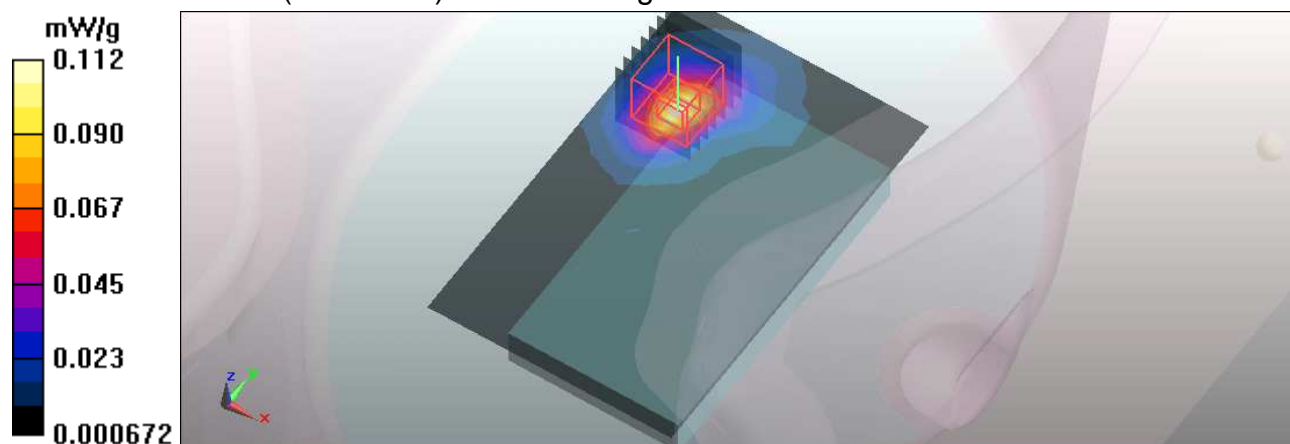



## M10-WiMax 10M-Ch368 / Ant 1

Communication System: Wimax\_2.6GHz 10M ; Frequency: 2593 MHz ; Duty Cycle: 1:3.24  
Medium: MSL2600 Medium parameters used:  $f = 2593$  MHz;  $\sigma = 2.16$  mho/m;  $\epsilon_r = 53.34$ ;  $\rho = 1000$  kg/m<sup>3</sup>

Phantom section: Flat Section ; DUT test position : Body ; Modulation Type: QPSK  
Separation Distance : 10 mm ( The bottom side of the EUT to the Phantom)

### DASY5 Configuration:

- Probe: EX3DV4 - SN3590; ConvF(8.04, 8.04, 8.04); Calibrated: 2010/3/25
- Sensor-Surface: 2mm (Mechanical Surface Detection)
- Electronics: DAE4 Sn861; Calibrated: 2010/1/22
- Phantom: SAM with CRP; Type: SAM; Serial: TP-1485
- Measurement SW: DASY5, V5.2 Build 162; SEMCAD X Version 14.0 Build 61

**Flat-Section MSL/Flat Section 10mm /Area Scan (13x20x1):** Measurement grid: dx=8mm, dy=8mm

Maximum value of SAR (measured) = 0.050 mW/g

**Flat-Section MSL/Flat Section 10mm /Zoom Scan (7x7x7)/Cube 0:** Measurement grid: dx=5mm, dy=5mm, dz=5mm

Reference Value = 1.06 V/m; Power Drift = 0.193 dB

Peak SAR (extrapolated) = 0.096 W/kg

**SAR(1 g) = 0.033 mW/g; SAR(10 g) = 0.0078 mW/g**

Maximum value of SAR (measured) = 0.059 mW/g

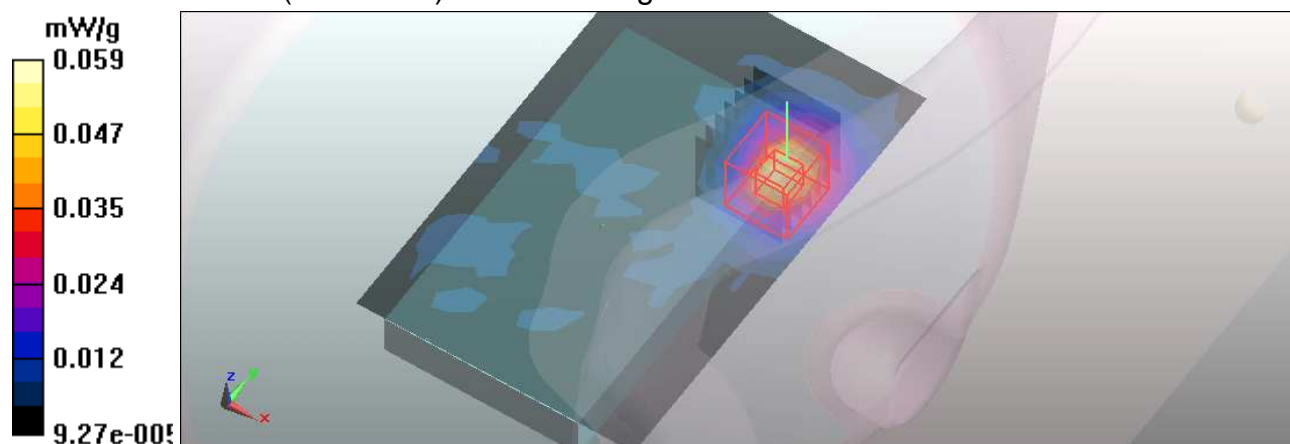



## M11-WiMax 10M-Ch368 / Ant 1

Communication System: Wimax\_2.6GHz 10M ; Frequency: 2593 MHz ; Duty Cycle: 1:3.24  
Medium: MSL2600 Medium parameters used:  $f = 2593$  MHz;  $\sigma = 2.16$  mho/m;  $\epsilon_r = 53.34$ ;  $\rho = 1000$  kg/m<sup>3</sup>

Phantom section: Flat Section ; DUT test position : Body ; Modulation Type: QPSK  
Separation Distance : 10 mm ( The right edge side of the EUT to the Phantom)

DASY5 Configuration:

- Probe: EX3DV4 - SN3590; ConvF(8.04, 8.04, 8.04); Calibrated: 2010/3/25
- Sensor-Surface: 2mm (Mechanical Surface Detection)
- Electronics: DAE4 Sn861; Calibrated: 2010/1/22
- Phantom: SAM with CRP; Type: SAM; Serial: TP-1485
- Measurement SW: DASY5, V5.2 Build 162; SEMCAD X Version 14.0 Build 61

**Flat-Section MSL/Flat Section 10mm /Area Scan (8x20x1):** Measurement grid: dx=8mm, dy=8mm

Maximum value of SAR (measured) = 0.262 mW/g

**Flat-Section MSL/Flat Section 10mm /Zoom Scan (7x7x7)/Cube 0:** Measurement grid: dx=5mm, dy=5mm, dz=5mm

Reference Value = 2.34 V/m; Power Drift = 0.141 dB

Peak SAR (extrapolated) = 0.404 W/kg

**SAR(1 g) = 0.184 mW/g; SAR(10 g) = 0.079 mW/g**

Maximum value of SAR (measured) = 0.293 mW/g

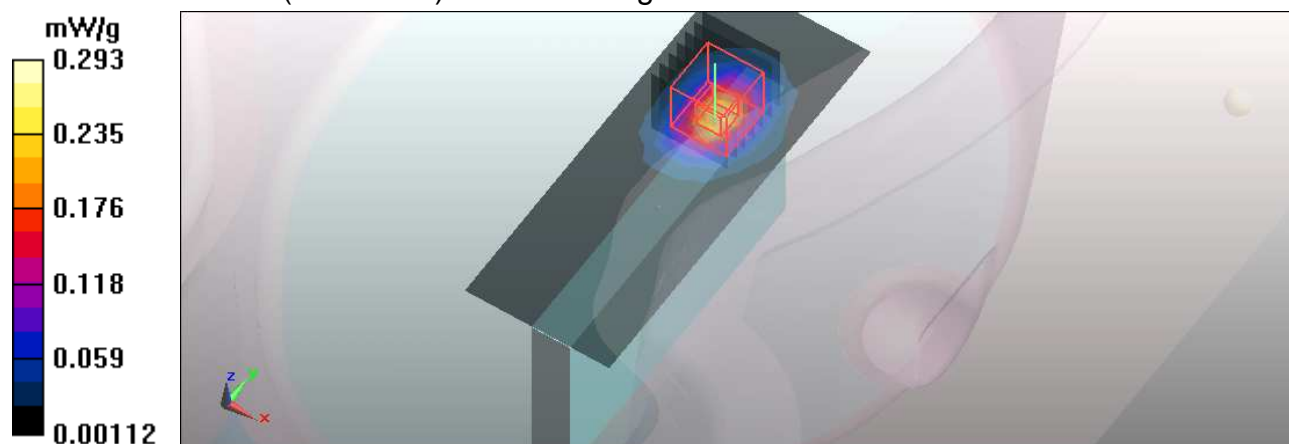

## M12-WiMax 10M-Ch368 / Ant 1

Communication System: Wimax\_2.6GHz 10M ; Frequency: 2593 MHz ; Duty Cycle: 1:3.24  
Medium: MSL2600 Medium parameters used:  $f = 2593$  MHz;  $\sigma = 2.16$  mho/m;  $\epsilon_r = 53.34$ ;  $\rho = 1000$  kg/m<sup>3</sup>

Phantom section: Flat Section ; DUT test position : Body ; Modulation Type: QPSK

Separation Distance : 10 mm ( The back edge side of the EUT to the Phantom)

### DASY5 Configuration:

- Probe: EX3DV4 - SN3590; ConvF(8.04, 8.04, 8.04); Calibrated: 2010/3/25
- Sensor-Surface: 2mm (Mechanical Surface Detection)
- Electronics: DAE4 Sn861; Calibrated: 2010/1/22
- Phantom: SAM with CRP; Type: SAM; Serial: TP-1485
- Measurement SW: DASY5, V5.2 Build 162; SEMCAD X Version 14.0 Build 61

**Flat-Section MSL/Flat Section 10mm /Area Scan (7x17x1):** Measurement grid: dx=8mm, dy=8mm

Maximum value of SAR (measured) = 0.015 mW/g

**Flat-Section MSL/Flat Section 10mm /Zoom Scan (7x7x7)/Cube 0:** Measurement grid: dx=5mm, dy=5mm, dz=5mm

Reference Value = 1.21 V/m; Power Drift = 0.104 dB

Peak SAR (extrapolated) = 0.033 W/kg

**SAR(1 g) = 0.00957 mW/g; SAR(10 g) = 0.0046 mW/g**

Maximum value of SAR (measured) = 0.017 mW/g

**Flat-Section MSL/Flat Section 10mm /Zoom Scan (7x7x7)/Cube 1:** Measurement grid: dx=5mm, dy=5mm, dz=5mm

Reference Value = 1.21 V/m; Power Drift = 0.104 dB

Peak SAR (extrapolated) = 0.032 W/kg

**SAR(1 g) = 0.00897 mW/g; SAR(10 g) = 0.00441 mW/g**

Maximum value of SAR (measured) = 0.016 mW/g

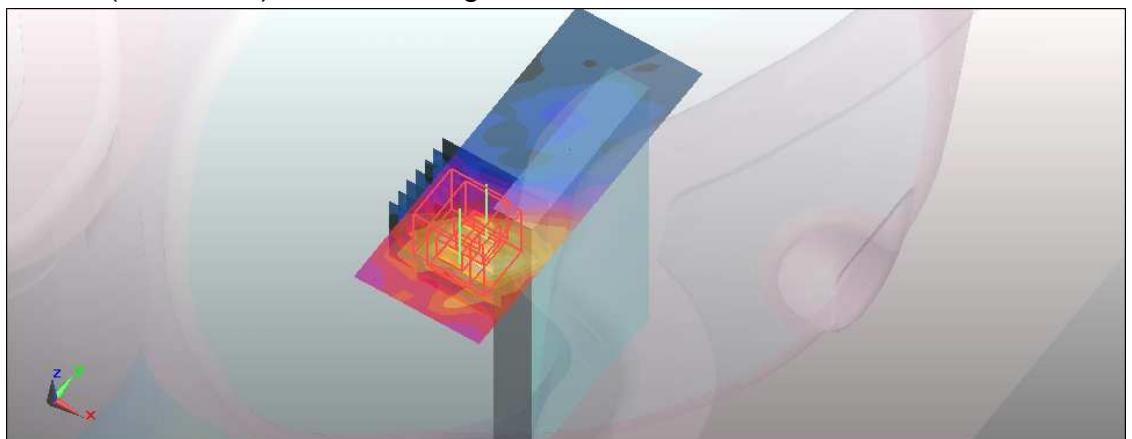
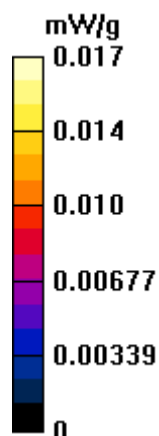



## M13-WiMax 10M-Ch368 / Ant 2

Communication System: Wimax\_2.6GHz 10M ; Frequency: 2593 MHz ; Duty Cycle: 1:3.24  
Medium: MSL2600 Medium parameters used:  $f = 2593$  MHz;  $\sigma = 2.16$  mho/m;  $\epsilon_r = 53.34$ ;  $\rho = 1000$  kg/m<sup>3</sup>

Phantom section: Flat Section ; DUT test position : Body ; Modulation Type: QPSK  
Separation Distance : 10 mm ( The top side of the EUT to the Phantom)

DASY5 Configuration:

- Probe: EX3DV4 - SN3590; ConvF(8.04, 8.04, 8.04); Calibrated: 2010/3/25
- Sensor-Surface: 2mm (Mechanical Surface Detection)
- Electronics: DAE4 Sn861; Calibrated: 2010/1/22
- Phantom: SAM with CRP; Type: SAM; Serial: TP-1485
- Measurement SW: DASY5, V5.2 Build 162; SEMCAD X Version 14.0 Build 61

**Flat-Section MSL/Flat Section 10mm Mid /Area Scan (13x20x1):** Measurement grid:

$dx=8$ mm,  $dy=8$ mm

Maximum value of SAR (measured) = 0.276 mW/g

**Flat-Section MSL/Flat Section 10mm Mid /Zoom Scan (7x7x7)/Cube 0:** Measurement

grid:  $dx=5$ mm,  $dy=5$ mm,  $dz=5$ mm

Reference Value = 0.950 V/m; Power Drift = 0.139 dB

Peak SAR (extrapolated) = 0.422 W/kg

**SAR(1 g) = 0.201 mW/g; SAR(10 g) = 0.093 mW/g**

Maximum value of SAR (measured) = 0.311 mW/g

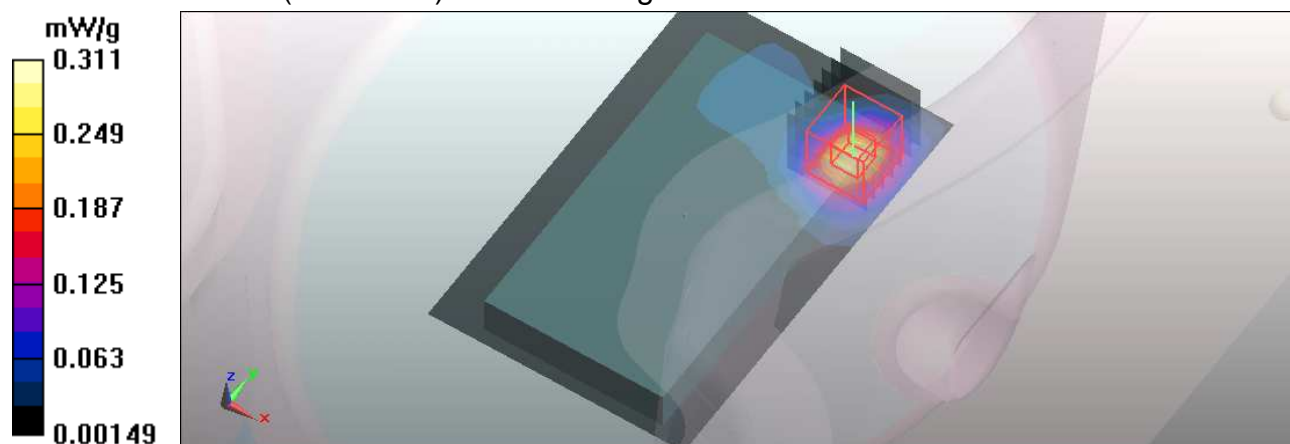





## M14-WiMax 10M-Ch368 / Ant 2

Communication System: Wimax\_2.6GHz 10M ; Frequency: 2593 MHz ; Duty Cycle: 1:3.24  
Medium: MSL2600 Medium parameters used:  $f = 2593$  MHz;  $\sigma = 2.16$  mho/m;  $\epsilon_r = 53.34$ ;  $\rho = 1000$  kg/m<sup>3</sup>

Phantom section: Flat Section ; DUT test position : Body ; Modulation Type: QPSK  
Separation Distance : 10 mm ( The bottom side of the EUT to the Phantom)

DASY5 Configuration:

- Probe: EX3DV4 - SN3590; ConvF(8.04, 8.04, 8.04); Calibrated: 2010/3/25
- Sensor-Surface: 2mm (Mechanical Surface Detection)
- Electronics: DAE4 Sn861; Calibrated: 2010/1/22
- Phantom: SAM with CRP; Type: SAM; Serial: TP-1485
- Measurement SW: DASY5, V5.2 Build 162; SEMCAD X Version 14.0 Build 61

**Flat-Section MSL/Flat Section 10mm Mid /Area Scan (13x20x1):** Measurement grid:

$dx=8$ mm,  $dy=8$ mm

Maximum value of SAR (measured) = 0.220 mW/g

**Flat-Section MSL/Flat Section 10mm Mid /Zoom Scan (7x7x7)/Cube 0:** Measurement

grid:  $dx=5$ mm,  $dy=5$ mm,  $dz=5$ mm

Reference Value = 2.76 V/m; Power Drift = 0.118 dB

Peak SAR (extrapolated) = 0.299 W/kg

**SAR(1 g) = 0.144 mW/g; SAR(10 g) = 0.069 mW/g**

Maximum value of SAR (measured) = 0.217 mW/g

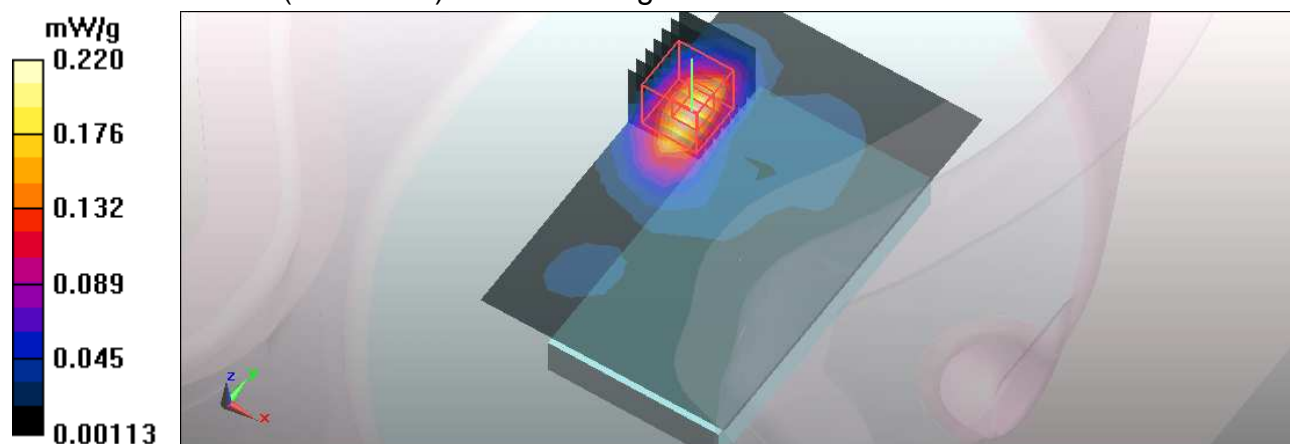

## M15-WiMax 10M-Ch368 / Ant 2

Communication System: Wimax\_2.6GHz 10M ; Frequency: 2593 MHz ; Duty Cycle: 1:3.24  
Medium: MSL2600 Medium parameters used:  $f = 2593$  MHz;  $\sigma = 2.16$  mho/m;  $\epsilon_r = 53.34$ ;  $\rho = 1000$  kg/m<sup>3</sup>

Phantom section: Flat Section ; DUT test position : Body ; Modulation Type: QPSK  
Separation Distance : 10 mm ( The left edge side of the EUT to the Phantom)

DASY5 Configuration:

- Probe: EX3DV4 - SN3590; ConvF(8.04, 8.04, 8.04); Calibrated: 2010/3/25
- Sensor-Surface: 2mm (Mechanical Surface Detection)
- Electronics: DAE4 Sn861; Calibrated: 2010/1/22
- Phantom: SAM with CRP; Type: SAM; Serial: TP-1485
- Measurement SW: DASY5, V5.2 Build 162; SEMCAD X Version 14.0 Build 61

**Flat-Section MSL/Flat Section 10mm Mid /Area Scan (8x20x1):** Measurement grid:

$dx=8$ mm,  $dy=8$ mm

Maximum value of SAR (measured) = 0.379 mW/g

**Flat-Section MSL/Flat Section 10mm Mid /Zoom Scan (7x7x7)/Cube 0:** Measurement

grid:  $dx=5$ mm,  $dy=5$ mm,  $dz=5$ mm

Reference Value = 3.82 V/m; Power Drift = -0.102 dB

Peak SAR (extrapolated) = 0.509 W/kg

**SAR(1 g) = 0.246 mW/g; SAR(10 g) = 0.114 mW/g**

Maximum value of SAR (measured) = 0.373 mW/g

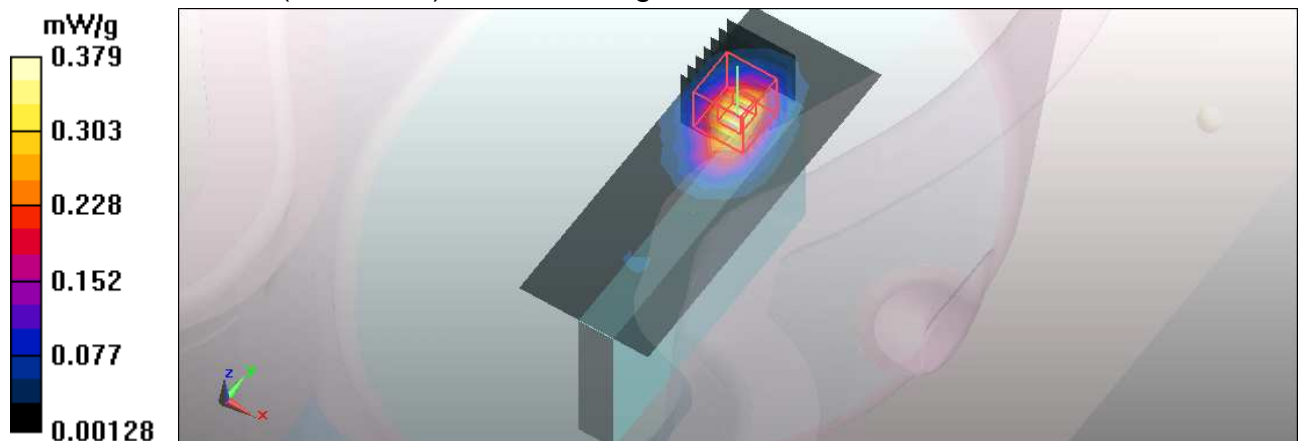



## M16-WiMax 10M-Ch368 / Ant 2

Communication System: Wimax\_2.6GHz 10M ; Frequency: 2593 MHz ; Duty Cycle: 1:3.24  
Medium: MSL2600 Medium parameters used:  $f = 2593$  MHz;  $\sigma = 2.16$  mho/m;  $\epsilon_r = 53.34$ ;  $\rho = 1000$  kg/m<sup>3</sup>

Phantom section: Flat Section ; DUT test position : Body ; Modulation Type: QPSK  
Separation Distance : 10 mm ( The back edge side of the EUT to the Phantom)

### DASY5 Configuration:

- Probe: EX3DV4 - SN3590; ConvF(8.04, 8.04, 8.04); Calibrated: 2010/3/25
- Sensor-Surface: 2mm (Mechanical Surface Detection)
- Electronics: DAE4 Sn861; Calibrated: 2010/1/22
- Phantom: SAM with CRP; Type: SAM; Serial: TP-1485
- Measurement SW: DASY5, V5.2 Build 162; SEMCAD X Version 14.0 Build 61

**Flat-Section MSL/Flat Section 10mm Mid /Area Scan (12x18x1):** Measurement grid:  
dx=8mm, dy=8mm

Maximum value of SAR (measured) = 0.016 mW/g

**Flat-Section MSL/Flat Section 10mm Mid /Zoom Scan (7x7x7)/Cube 0:** Measurement grid: dx=5mm, dy=5mm, dz=5mm

Reference Value = 1.14 V/m; Power Drift = 0.183 dB

Peak SAR (extrapolated) = 0.040 W/kg

**SAR(1 g) = 0.00831 mW/g; SAR(10 g) = 0.00361 mW/g**

Maximum value of SAR (measured) = 0.024 mW/g

**Flat-Section MSL/Flat Section 10mm Mid /Zoom Scan (7x7x7)/Cube 1:** Measurement grid: dx=5mm, dy=5mm, dz=5mm

Reference Value = 1.14 V/m; Power Drift = 0.183 dB

Peak SAR (extrapolated) = 0.067 W/kg

**SAR(1 g) = 0.0096 mW/g; SAR(10 g) = 0.00435 mW/g**

Maximum value of SAR (measured) = 0.067 mW/g

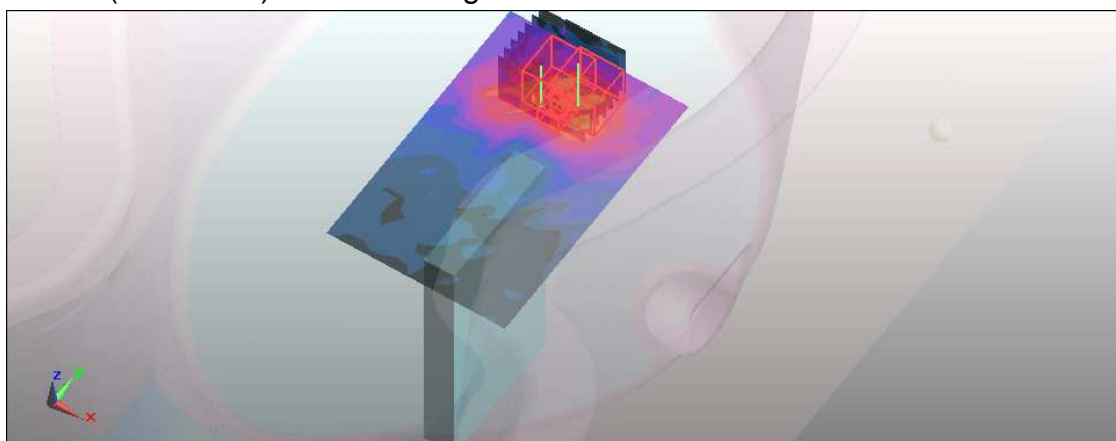
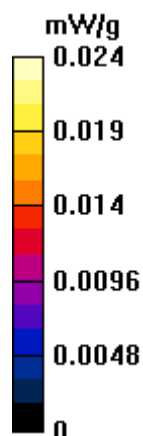



## System Performance Check-D2600V2-MSL2600 MHz

DUT: Dipole 2600 MHz ; Type: D2600V2 ; Serial: D2600V2 - SN:1020 ; Test Frequency: 2600 MHz

Communication System: CW ; Frequency: 2600 MHz; Duty Cycle: 1:1; Modulation type: CW  
Medium: MSL2600; Medium parameters used:  $f = 2600$  MHz;  $\sigma = 2.17$  mho/m;  $\epsilon_r = 53.21$ ;  $\rho = 1000$  kg/m<sup>3</sup> ; Liquid level : 150 mm  
Phantom section: Flat Section ; Separation distance : 10 mm (The feet point of the dipole to the Phantom) Air temp. : 22.1 degrees ; Liquid temp. : 21.3 degrees

DASY5 Configuration:

- Probe: EX3DV4 - SN3590; ConvF(8.04, 8.04, 8.04); Calibrated: 2010/3/25
- Sensor-Surface: 2mm (Mechanical Surface Detection)
- Electronics: DAE4 Sn861; Calibrated: 2010/1/22
- Phantom: SAM with CRP; Type: SAM; Serial: TP-1485
- Measurement SW: DASY5, V5.2 Build 162; SEMCAD X Version 14.0 Build 61

**System Performance Check at Frequencies above 1 GHz/d=10mm, Pin=250 mW, dist=2.0mm (EX-Probe)/Area Scan (7x7x1):** Measurement grid: dx=15mm, dy=15mm  
Maximum value of SAR (measured) = 20.3 mW/g

**System Performance Check at Frequencies above 1 GHz/d=10mm, Pin=250 mW, dist=2.0mm (EX-Probe)/Zoom Scan (7x7x7)/Cube 0:** Measurement grid: dx=5mm, dy=5mm, dz=5mm

Reference Value = 99.8 V/m; Power Drift = -0.050 dB

Peak SAR (extrapolated) = 29.4 W/kg

**SAR(1 g) = 13.1 mW/g; SAR(10 g) = 5.84 mW/g**

Maximum value of SAR (measured) = 20.9 mW/g

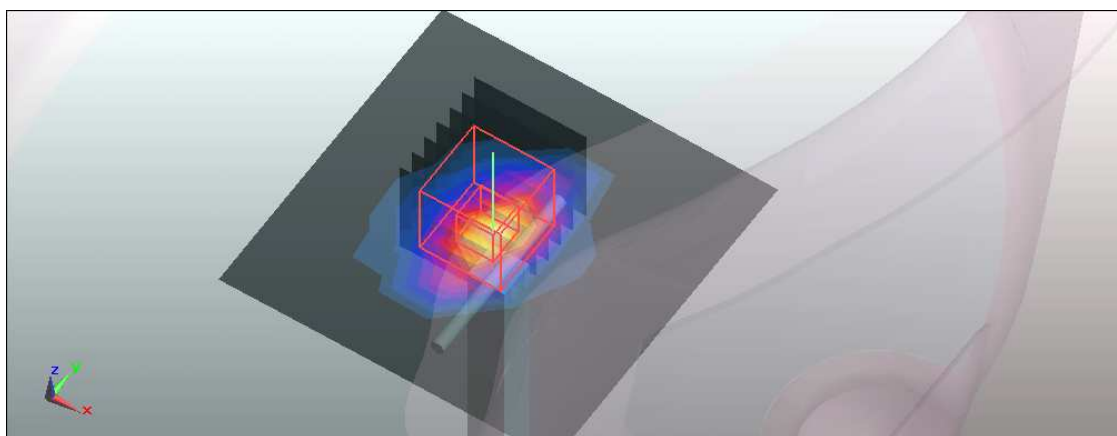
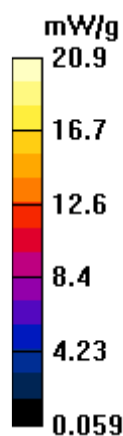



香港商立德國際商品試驗有限公司桃園分公司

Bureau Veritas Consumer Products Services (H.K.) Ltd., Taoyuan Branch

**APPENDIX A: TEST DATA**

DUT: TabletRock ; Model Name: PHS2000W

**Liquid Level Photo**

Tissue 2450MHz D=150mm





## M01-11b-Ch6 / Ant 1

Communication System: 802.11b ; Frequency: 2437 MHz ; Duty Cycle: 1:1 ; Modulation type: DBPSK  
Medium: MSL2450 Medium parameters used:  $f = 2437$  MHz;  $\sigma = 1.96$  mho/m;  $\epsilon_r = 54.2$ ;  $\rho = 1000$  kg/m<sup>3</sup>

Phantom section: Flat Section ; Separation distance : 10 mm (The top side of the EUT to the Phantom)

DASY5 Configuration:

- Probe: EX3DV4 - SN3590; ConvF(8.2, 8.2, 8.2); Calibrated: 2010/3/25
- Sensor-Surface: 2mm (Mechanical Surface Detection)
- Electronics: DAE4 Sn861; Calibrated: 2010/1/22
- Phantom: SAM with CRP; Type: SAM; Serial: TP-1485
- Measurement SW: DASY5, V5.2 Build 162; SEMCAD X Version 14.0 Build 61

**Flat-Section MSL/Flat Section 10mm/Area Scan (13x20x1):** Measurement grid: dx=8mm, dy=8mm

Maximum value of SAR (measured) = 0.038 mW/g

**Flat-Section MSL/Flat Section 10mm/Zoom Scan (7x7x7)/Cube 0:** Measurement grid: dx=5mm, dy=5mm, dz=5mm

Reference Value = 3.9 V/m; Power Drift = -0.149 dB

Peak SAR (extrapolated) = 0.041 W/kg

**SAR(1 g) = 0.021 mW/g; SAR(10 g) = 0.011 mW/g**

Maximum value of SAR (measured) = 0.032 mW/g

**Flat-Section MSL/Flat Section 10mm/Zoom Scan (7x7x7)/Cube 1:** Measurement grid: dx=5mm, dy=5mm, dz=5mm

Reference Value = 3.9 V/m; Power Drift = -0.149 dB

Peak SAR (extrapolated) = 0.071 W/kg

**SAR(1 g) = 0.024 mW/g; SAR(10 g) = 0.011 mW/g**

Maximum value of SAR (measured) = 0.035 mW/g

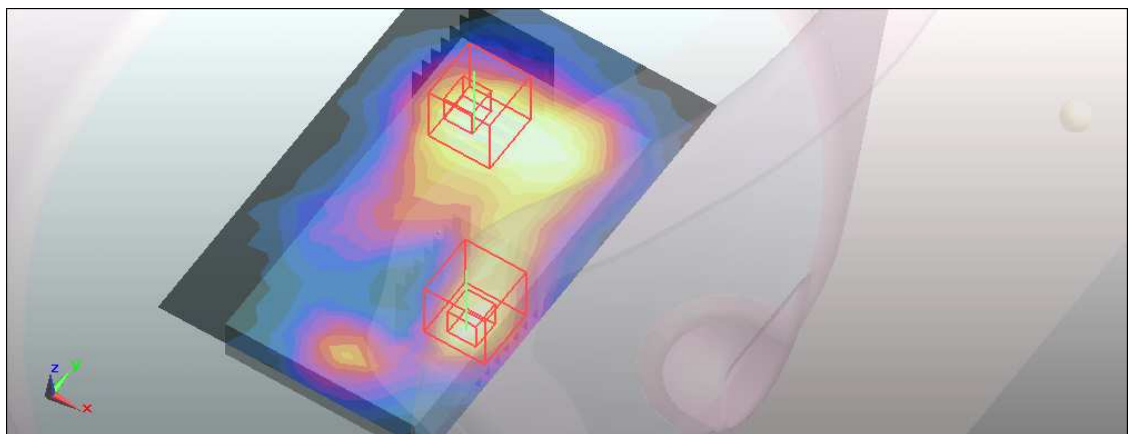
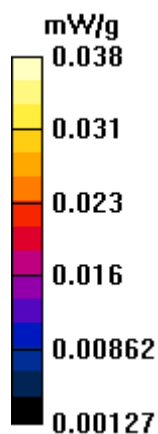



## M02-11b-Ch6 / Ant 1

Communication System: 802.11b ; Frequency: 2437 MHz ; Duty Cycle: 1:1 ; Modulation type: DBPSK  
Medium: MSL2450 Medium parameters used:  $f = 2437$  MHz;  $\sigma = 1.96$  mho/m;  $\epsilon_r = 54.2$ ;  $\rho = 1000$  kg/m<sup>3</sup>

Phantom section: Flat Section ; Separation distance : 10 mm (The bottom side of the EUT to the Phantom)

DASY5 Configuration:

- Probe: EX3DV4 - SN3590; ConvF(8.2, 8.2, 8.2); Calibrated: 2010/3/25
- Sensor-Surface: 2mm (Mechanical Surface Detection)
- Electronics: DAE4 Sn861; Calibrated: 2010/1/22
- Phantom: SAM with CRP; Type: SAM; Serial: TP-1485
- Measurement SW: DASY5, V5.2 Build 162; SEMCAD X Version 14.0 Build 61

**Flat-Section MSL/Flat Section 10mm/Area Scan (13x20x1):** Measurement grid: dx=8mm, dy=8mm

Maximum value of SAR (measured) = 0.053 mW/g

**Flat-Section MSL/Flat Section 10mm/Zoom Scan (7x7x7)/Cube 0:** Measurement grid: dx=5mm, dy=5mm, dz=5mm

Reference Value = 4.06 V/m; Power Drift = 0.157 dB

Peak SAR (extrapolated) = 0.072 W/kg

**SAR(1 g) = 0.036 mW/g; SAR(10 g) = 0.018 mW/g**

**Flat-Section MSL/Flat Section 10mm/Zoom Scan (7x7x7)/Cube 1:** Measurement grid: dx=5mm, dy=5mm, dz=5mm

Reference Value = 4.06 V/m; Power Drift = 0.157 dB

Peak SAR (extrapolated) = 0.070 W/kg

**SAR(1 g) = 0.036 mW/g; SAR(10 g) = 0.018 mW/g**

Maximum value of SAR (measured) = 0.052 mW/g

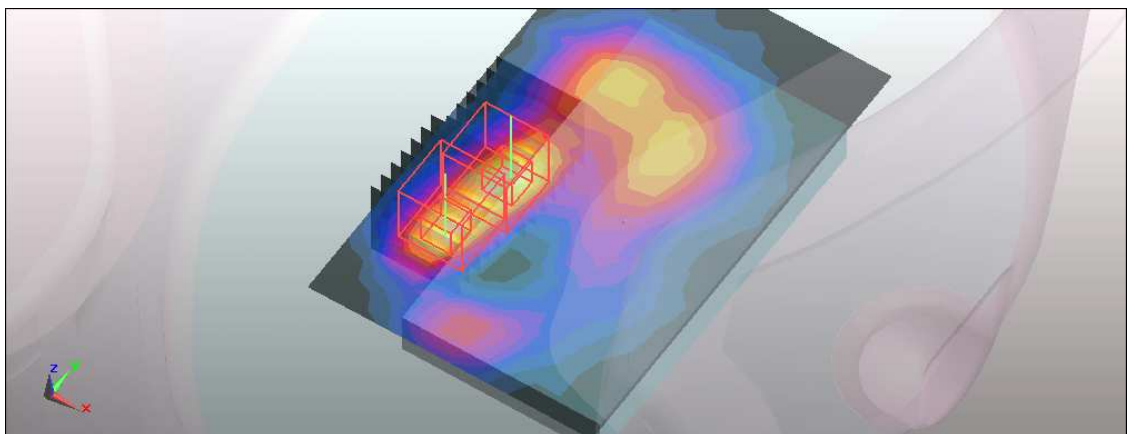
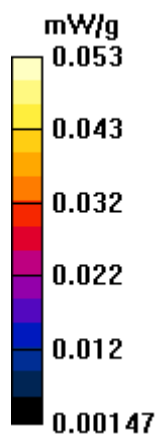



## M03-11b-Ch6 / Ant 1

Communication System: 802.11b ; Frequency: 2437 MHz ; Duty Cycle: 1:1 ; Modulation type: DBPSK  
Medium: MSL2450 Medium parameters used:  $f = 2437$  MHz;  $\sigma = 1.96$  mho/m;  $\epsilon_r = 54.2$ ;  $\rho = 1000$  kg/m<sup>3</sup>

Phantom section: Flat Section ; Separation distance : 10 mm (The left edge side of the EUT to the Phantom)

DASY5 Configuration:

- Probe: EX3DV4 - SN3590; ConvF(8.2, 8.2, 8.2); Calibrated: 2010/3/25
- Sensor-Surface: 2mm (Mechanical Surface Detection)
- Electronics: DAE4 Sn861; Calibrated: 2010/1/22
- Phantom: SAM with CRP; Type: SAM; Serial: TP-1485
- Measurement SW: DASY5, V5.2 Build 162; SEMCAD X Version 14.0 Build 61

**Flat-Section MSL/Flat Section 10mm/Area Scan (7x20x1):** Measurement grid: dx=8mm, dy=8mm

Maximum value of SAR (measured) = 0.054 mW/g

**Flat-Section MSL/Flat Section 10m/Zoom Scan (7x7x7)/Cube 0:** Measurement grid: dx=5mm, dy=5mm, dz=5mm

Reference Value = 3.76 V/m; Power Drift = -0.146 dB

Peak SAR (extrapolated) = 0.073 W/kg

**SAR(1 g) = 0.038 mW/g; SAR(10 g) = 0.019 mW/g**

Maximum value of SAR (measured) = 0.055 mW/g

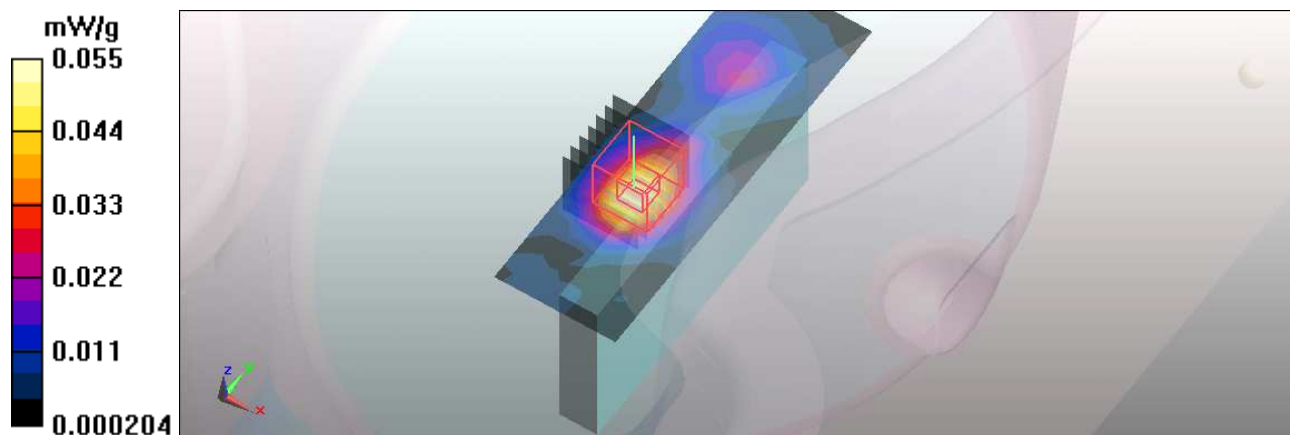





## M04-11b-Ch6 / Ant 1

Communication System: 802.11b ; Frequency: 2437 MHz ; Duty Cycle: 1:1 ; Modulation type: DBPSK  
Medium: MSL2450 Medium parameters used:  $f = 2437$  MHz;  $\sigma = 1.96$  mho/m;  $\epsilon_r = 54.2$ ;  $\rho = 1000$  kg/m<sup>3</sup>

Phantom section: Flat Section ; Separation distance : 10 mm (The front edge side of the EUT to the Phantom)

DASY5 Configuration:

- Probe: EX3DV4 - SN3590; ConvF(8.2, 8.2, 8.2); Calibrated: 2010/3/25
- Sensor-Surface: 2mm (Mechanical Surface Detection)
- Electronics: DAE4 Sn861; Calibrated: 2010/1/22
- Phantom: SAM with CRP; Type: SAM; Serial: TP-1485
- Measurement SW: DASY5, V5.2 Build 162; SEMCAD X Version 14.0 Build 61

**Flat-Section MSL/Flat Section 10mm/Area Scan (7x14x1):** Measurement grid: dx=8mm, dy=8mm

Maximum value of SAR (measured) = 0.040 mW/g

**Flat-Section MSL/Flat Section 10mm/Zoom Scan (7x7x7)/Cube 0:** Measurement grid: dx=5mm, dy=5mm, dz=5mm

Reference Value = 3.57 V/m; Power Drift = 0.0045 dB

Peak SAR (extrapolated) = 0.065 W/kg

**SAR(1 g) = 0.027 mW/g; SAR(10 g) = 0.013 mW/g**

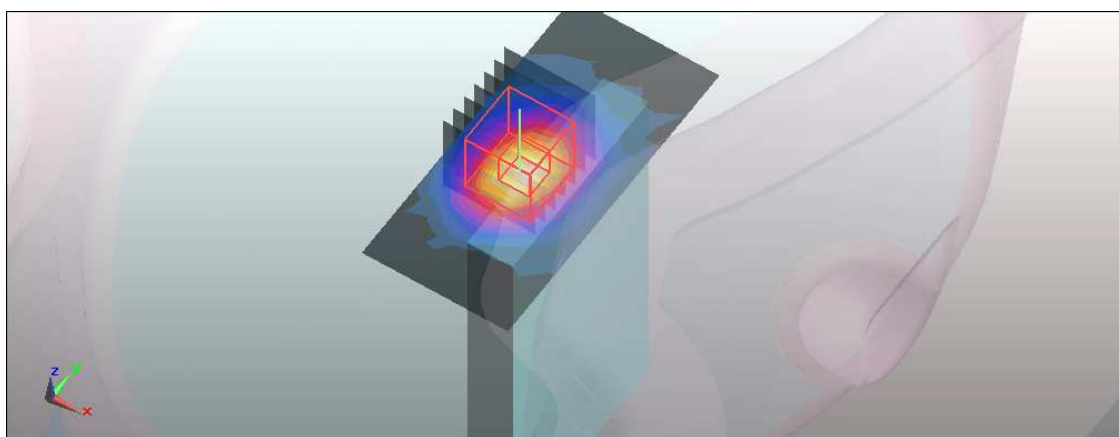
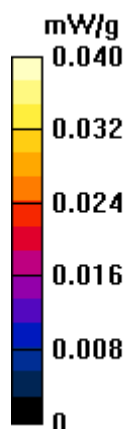

## M05-11b-Ch6 / Ant 2

Communication System: 802.11b ; Frequency: 2437 MHz ; Duty Cycle: 1:1 ; Modulation type: DBPSK  
Medium: MSL2450 Medium parameters used:  $f = 2437$  MHz;  $\sigma = 1.96$  mho/m;  $\epsilon_r = 54.2$ ;  $\rho = 1000$  kg/m<sup>3</sup>

Phantom section: Flat Section ; Separation distance : 10 mm (The top side of the EUT to the Phantom)

DASY5 Configuration:

- Probe: EX3DV4 - SN3590; ConvF(8.2, 8.2, 8.2); Calibrated: 2010/3/25
- Sensor-Surface: 2mm (Mechanical Surface Detection)
- Electronics: DAE4 Sn861; Calibrated: 2010/1/22
- Phantom: SAM with CRP; Type: SAM; Serial: TP-1485
- Measurement SW: DASY5, V5.2 Build 162; SEMCAD X Version 14.0 Build 61

**Flat-Section MSL/Flat Section 10mm/Area Scan (13x20x1):** Measurement grid: dx=8mm, dy=8mm

Maximum value of SAR (measured) = 0.022 mW/g

**Flat-Section MSL/Flat Section 10mm/Zoom Scan (7x7x7)/Cube 0:** Measurement grid: dx=5mm, dy=5mm, dz=5mm

Reference Value = 1.51 V/m; Power Drift = -0.167 dB

Peak SAR (extrapolated) = 0.027 W/kg

**SAR(1 g) = 0.015 mW/g; SAR(10 g) = 0.00868 mW/g**

Maximum value of SAR (measured) = 0.021 mW/g

**Flat-Section MSL/Flat Section 10mm/Zoom Scan (7x7x7)/Cube 1:** Measurement grid: dx=5mm, dy=5mm, dz=5mm

Reference Value = 1.51 V/m; Power Drift = -0.167 dB

Peak SAR (extrapolated) = 0.026 W/kg

**SAR(1 g) = 0.014 mW/g; SAR(10 g) = 0.00777 mW/g**

Maximum value of SAR (measured) = 0.020 mW/g

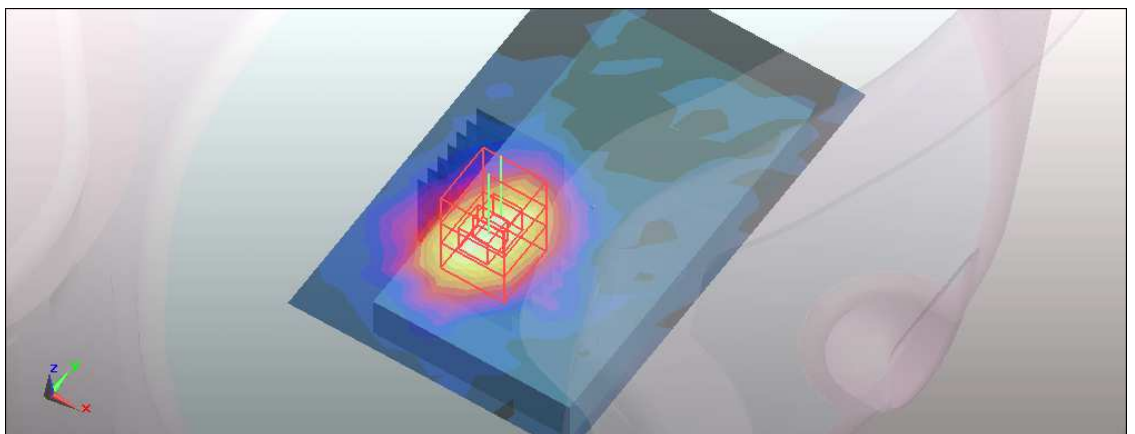
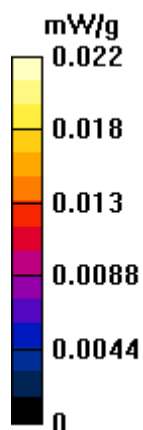



## M06-11b-Ch6 / Ant 2

Communication System: 802.11b ; Frequency: 2437 MHz ; Duty Cycle: 1:1 ; Modulation type: DBPSK  
Medium: MSL2450 Medium parameters used:  $f = 2437$  MHz;  $\sigma = 1.96$  mho/m;  $\epsilon_r = 54.2$ ;  $\rho = 1000$  kg/m<sup>3</sup>

Phantom section: Flat Section ; Separation distance : 10 mm (The bottom side of the EUT to the Phantom)

DASY5 Configuration:

- Probe: EX3DV4 - SN3590; ConvF(8.2, 8.2, 8.2); Calibrated: 2010/3/25
- Sensor-Surface: 2mm (Mechanical Surface Detection)
- Electronics: DAE4 Sn861; Calibrated: 2010/1/22
- Phantom: SAM with CRP; Type: SAM; Serial: TP-1485
- Measurement SW: DASY5, V5.2 Build 162; SEMCAD X Version 14.0 Build 61

**Flat-Section MSL/Flat Section 10mm/Area Scan (13x20x1):** Measurement grid: dx=8mm, dy=8mm

Maximum value of SAR (measured) = 0.015 mW/g

**Flat-Section MSL/Flat Section 10mm/Zoom Scan (7x7x7)/Cube 0:** Measurement grid: dx=5mm, dy=5mm, dz=5mm

Reference Value = 0.630 V/m; Power Drift = 0.182 dB

Peak SAR (extrapolated) = 0.021 W/kg

**SAR(1 g) = 0.011 mW/g; SAR(10 g) = 0.00578 mW/g**

Maximum value of SAR (measured) = 0.017 mW/g

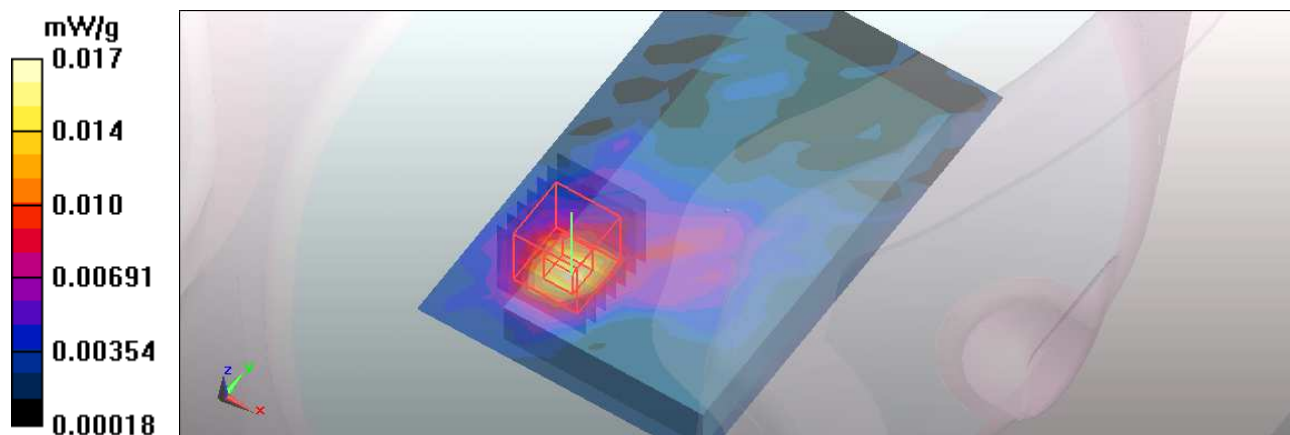



## M07-11b-Ch6 / Ant 2

Communication System: 802.11b ; Frequency: 2437 MHz ; Duty Cycle: 1:1 ; Modulation type: DBPSK  
Medium: MSL2450 Medium parameters used:  $f = 2437$  MHz;  $\sigma = 1.96$  mho/m;  $\epsilon_r = 54.2$ ;  $\rho = 1000$  kg/m<sup>3</sup>

Phantom section: Flat Section ; Separation distance : 10 mm (The left edge side of the EUT to the Phantom)

DASY5 Configuration:

- Probe: EX3DV4 - SN3590; ConvF(8.2, 8.2, 8.2); Calibrated: 2010/3/25
- Sensor-Surface: 2mm (Mechanical Surface Detection)
- Electronics: DAE4 Sn861; Calibrated: 2010/1/22
- Phantom: SAM with CRP; Type: SAM; Serial: TP-1485
- Measurement SW: DASY5, V5.2 Build 162; SEMCAD X Version 14.0 Build 61

**Flat-Section MSL/Flat Section 10mm/Area Scan (9x20x1):** Measurement grid: dx=8mm, dy=8mm

Maximum value of SAR (measured) = 0.00436 mW/g

**Flat-Section MSL/Flat Section 10mm/Zoom Scan (7x7x7)/Cube 0:** Measurement grid: dx=5mm, dy=5mm, dz=5mm

Reference Value = 0.870 V/m; Power Drift = -0.176 dB

Peak SAR (extrapolated) = 0.00357 W/kg

**SAR(1 g) = 0.0014 mW/g; SAR(10 g) = 0.000765 mW/g**

Maximum value of SAR (measured) = 0.00323 mW/g

**Flat-Section MSL/Flat Section 10mm/Zoom Scan (7x7x7)/Cube 1:** Measurement grid: dx=5mm, dy=5mm, dz=5mm

Reference Value = 0.870 V/m; Power Drift = -0.176 dB

Peak SAR (extrapolated) = 0.00767 W/kg

**SAR(1 g) = 0.00293 mW/g; SAR(10 g) = 0.00146 mW/g**

Maximum value of SAR (measured) = 0.00452 mW/g

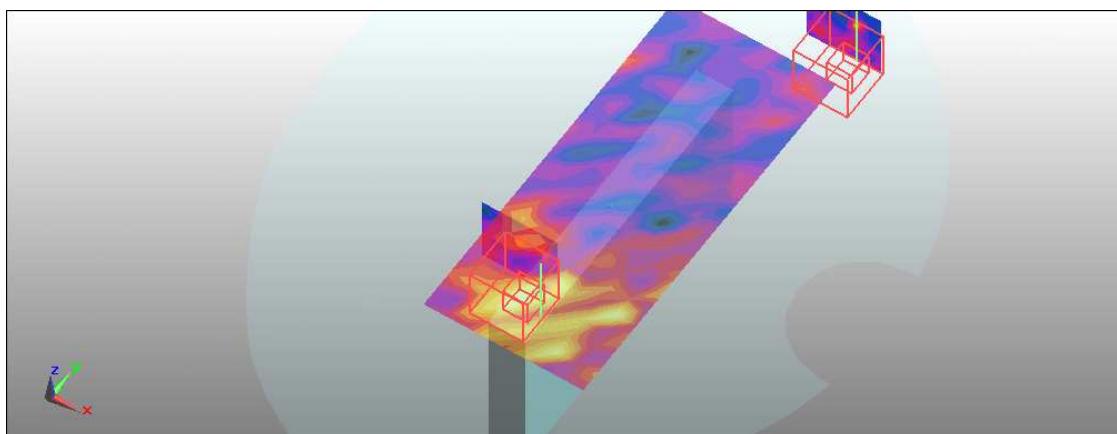
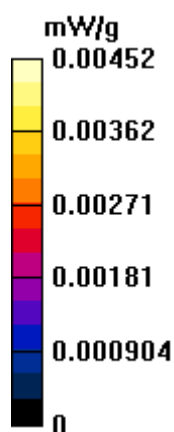



## M08-11b-Ch6 / Ant 2

Communication System: 802.11b ; Frequency: 2437 MHz ; Duty Cycle: 1:1 ; Modulation type: DBPSK  
Medium: MSL2450 Medium parameters used:  $f = 2437$  MHz;  $\sigma = 1.96$  mho/m;  $\epsilon_r = 54.2$ ;  $\rho = 1000$  kg/m<sup>3</sup>

Phantom section: Flat Section ; Separation distance : 10 mm (The front edge side of the EUT to the Phantom)

DASY5 Configuration:

- Probe: EX3DV4 - SN3590; ConvF(8.2, 8.2, 8.2); Calibrated: 2010/3/25
- Sensor-Surface: 2mm (Mechanical Surface Detection)
- Electronics: DAE4 Sn861; Calibrated: 2010/1/22
- Phantom: SAM with CRP; Type: SAM; Serial: TP-1485
- Measurement SW: DASY5, V5.2 Build 162; SEMCAD X Version 14.0 Build 61

**Flat-Section MSL/Flat Section 10mm/Area Scan (7x14x1):** Measurement grid: dx=8mm, dy=8mm

Maximum value of SAR (measured) = 0.014 mW/g

**Flat-Section MSL/Flat Section 10mm/Zoom Scan (7x7x7)/Cube 0:** Measurement grid: dx=5mm, dy=5mm, dz=5mm

Reference Value = 1.8 V/m; Power Drift = 0.123 dB

Peak SAR (extrapolated) = 0.021 W/kg

**SAR(1 g) = 0.00897 mW/g; SAR(10 g) = 0.00415 mW/g**

Maximum value of SAR (measured) = 0.015 mW/g

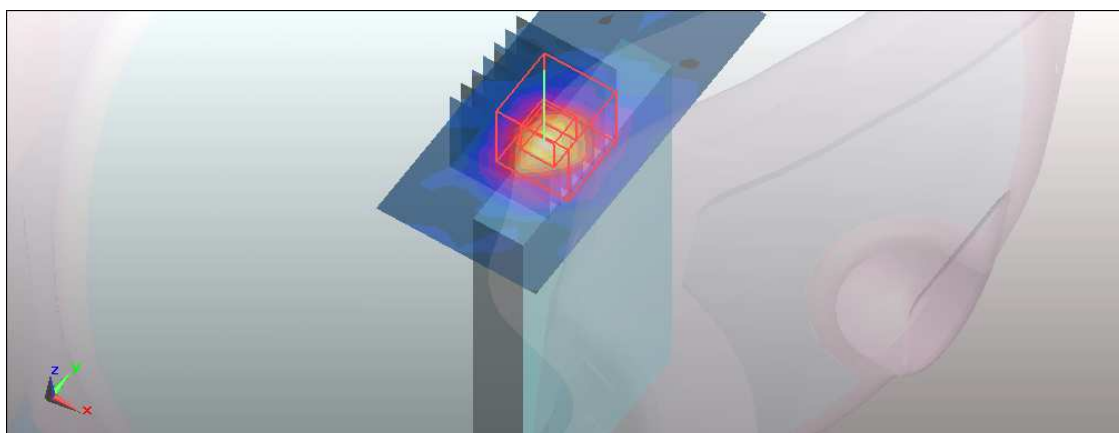
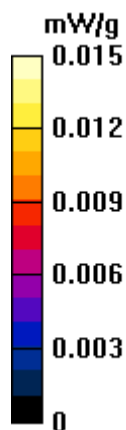



### M09-11b-Ch6 / Ant 2

Communication System: 802.11b ; Frequency: 2437 MHz ; Duty Cycle: 1:1 ; Modulation type: DBPSK  
Medium: MSL2450 Medium parameters used:  $f = 2437$  MHz;  $\sigma = 1.96$  mho/m;  $\epsilon_r = 54.2$ ;  $\rho = 1000$  kg/m<sup>3</sup>

Phantom section: Flat Section ; Separation distance : 10 mm (The right edge side of the EUT to the Phantom)

DASY5 Configuration:

- Probe: EX3DV4 - SN3590; ConvF(8.2, 8.2, 8.2); Calibrated: 2010/3/25
- Sensor-Surface: 2mm (Mechanical Surface Detection)
- Electronics: DAE4 Sn861; Calibrated: 2010/1/22
- Phantom: SAM with CRP; Type: SAM; Serial: TP-1485
- Measurement SW: DASY5, V5.2 Build 162; SEMCAD X Version 14.0 Build 61

**Flat-Section MSL/Flat Section 10mm/Area Scan (9x20x1):** Measurement grid: dx=8mm, dy=8mm

Maximum value of SAR (measured) = 0.00433 mW/g

**Flat-Section MSL/Flat Section 10mm/Zoom Scan (7x7x7)/Cube 0:** Measurement grid: dx=5mm, dy=5mm, dz=5mm

Reference Value = 0.643 V/m; Power Drift = -0.127 dB

Peak SAR (extrapolated) = 0.00649 W/kg

**SAR(1 g) = 0.00184 mW/g; SAR(10 g) = 0.0009 mW/g**

Maximum value of SAR (measured) = 0.00302 mW/g

**Flat-Section MSL/Flat Section 10mm/Zoom Scan (7x7x7)/Cube 1:** Measurement grid: dx=5mm, dy=5mm, dz=5mm

Reference Value = 0.643 V/m; Power Drift = -0.127 dB

Peak SAR (extrapolated) = 0.00461 W/kg

**SAR(1 g) = 0.00221 mW/g; SAR(10 g) = 0.00119 mW/g**

Maximum value of SAR (measured) = 0.00444 mW/g

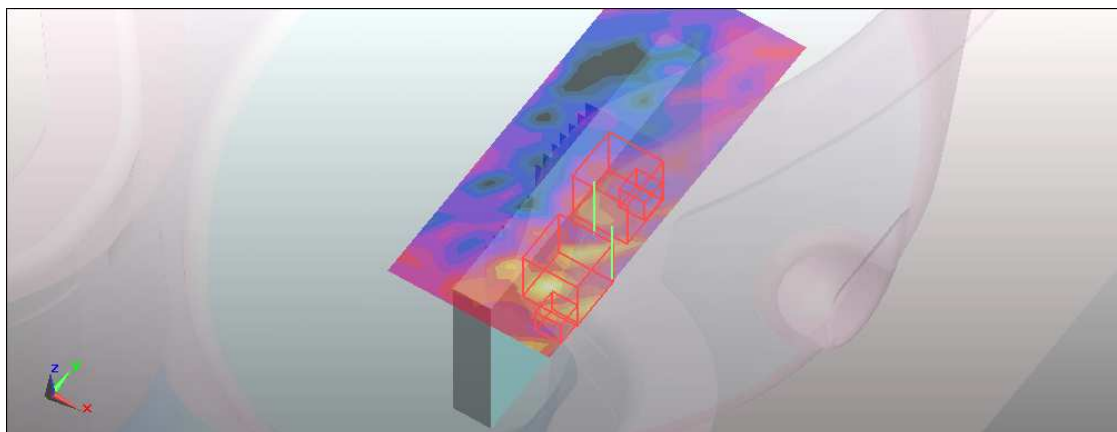
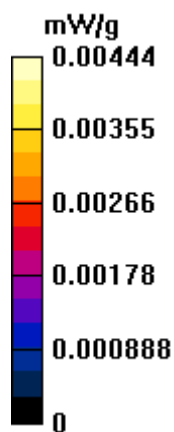





## System Performance Check-D2450V2-MSL2450 MHz

DUT: Dipole 2450 MHz D2450V2 ; Type: D2450V2 ; Serial: D2450V2 - SN:737 ; Test Frequency: 2450 MHz

Communication System: CW ; Frequency: 2450 MHz; Duty Cycle: 1:1; Modulation type: CW  
Medium: MSL2450; Medium parameters used:  $f = 2450$  MHz;  $\sigma = 1.98$  mho/m;  $\epsilon_r = 54.04$ ;  $\rho = 1000$  kg/m<sup>3</sup> ; Liquid level : 150 mm

Phantom section: Flat Section ; Separation distance : 10 mm (The feet point of the dipole to the Phantom) Air temp. : 21.7 degrees ; Liquid temp. : 20.5 degrees

DASY5 Configuration:

- Probe: EX3DV4 - SN3590; ConvF(8.2, 8.2, 8.2); Calibrated: 2010/3/25
- Sensor-Surface: 2mm (Mechanical Surface Detection)
- Electronics: DAE4 Sn861; Calibrated: 2010/1/22
- Phantom: SAM with CRP; Type: SAM; Serial: TP-1485
- Measurement SW: DASY5, V5.2 Build 162; SEMCAD X Version 14.0 Build 61

**System Performance Check at Frequencies above 1 GHz/d=10mm, Pin=250 mW, dist=2.0mm (EX-Probe)/Area Scan (7x7x1):** Measurement grid: dx=15mm, dy=15mm  
Maximum value of SAR (measured) = 12.1 mW/g

**System Performance Check at Frequencies above 1 GHz/d=10mm, Pin=250 mW, dist=2.0mm (EX-Probe)/Zoom Scan (7x7x7)/Cube 0:** Measurement grid: dx=5mm, dy=5mm, dz=5mm

Reference Value = 98.8 V/m; Power Drift = -0.061 dB

Peak SAR (extrapolated) = 26.5 W/kg

**SAR(1 g) = 12.3 mW/g; SAR(10 g) = 5.58 mW/g**

Maximum value of SAR (measured) = 19.2 mW/g

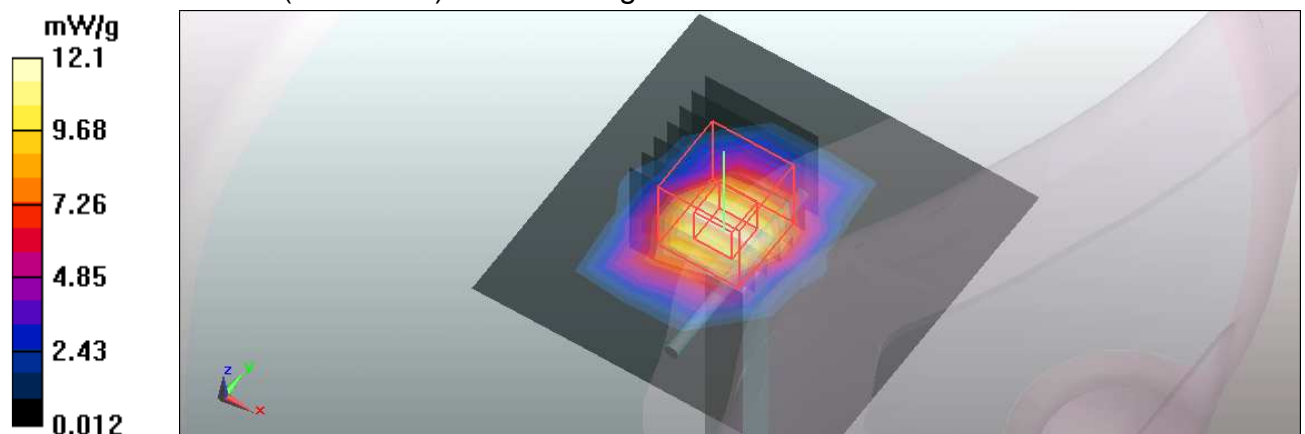

## APPENDIX B: BV ADT SAR MEASUREMENT SYSTEM

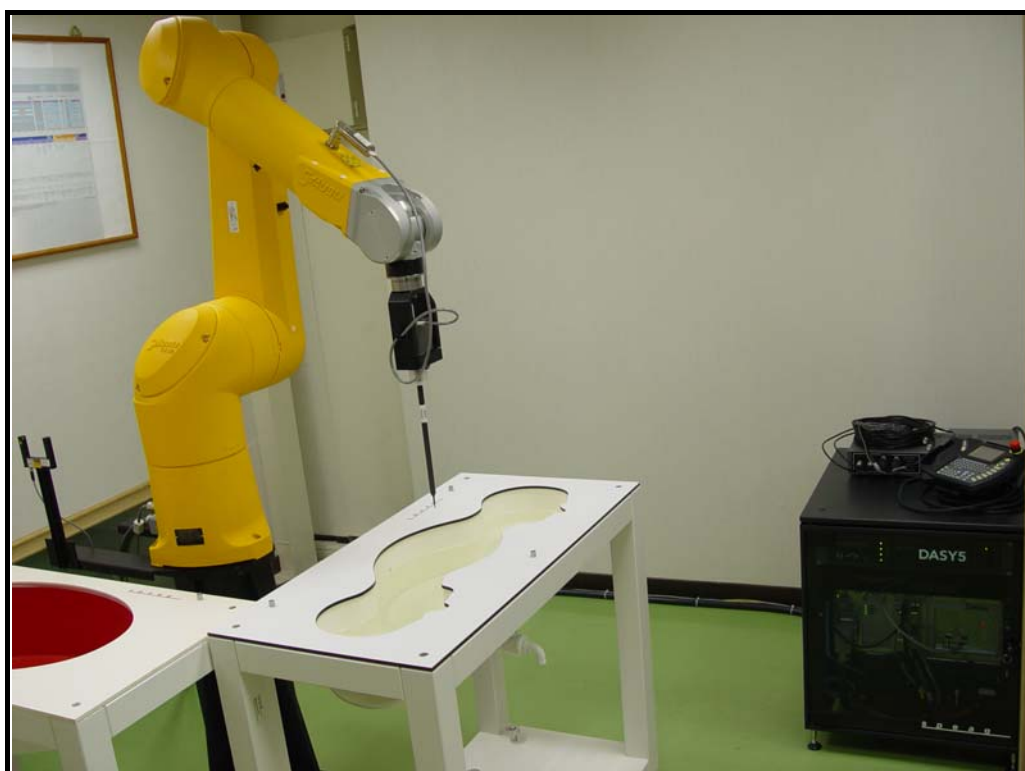



## APPENDIX C: PHOTOGRAPHS OF SYSTEM VALIDATION

