



A D T

FCC TEST REPORT (15.247)

REPORT NO.: RF991206C18
MODEL NO.: MBR1400
FCC ID: UXX-MBR1400
RECEIVED: Dec. 06, 2010
TESTED: Dec. 10 ~ Dec. 22, 2010
ISSUED: Dec. 24, 2010

APPLICANT: Cradlepoint, Inc.

ADDRESS: 1199 Shoreline Lane, Suite 301 Boise, ID 83702

ISSUED BY: Bureau Veritas Consumer Products Services (H.K.)
Ltd., Taoyuan Branch

LAB ADDRESS: No. 47, 14th Ling, Chia Pau Tsuen, Lin Kou Hsiang,
Taipei Hsien 244, Taiwan, R.O.C.

TEST LOCATION: No. 19, Hwa Ya 2nd Rd, Wen Hwa Tsuen, Kwei
Shan Hsiang, Taoyuan Hsien 333, Taiwan, R.O.C.

This test report consists of 124 pages in total. It may be duplicated completely for legal use with the approval of the applicant. It should not be reproduced except in full, without the written approval of our laboratory. The client should not use it to claim product certification, approval or endorsement by TAF or any government agency. The test results in the report only apply to the tested sample.





A D T

TABLE OF CONTENTS

RELEASE CONTROL RECORD	5
1. CERTIFICATION.....	6
2. SUMMARY OF TEST RESULTS	7
2.1 MEASUREMENT UNCERTAINTY	7
3. GENERAL INFORMATION.....	8
3.1 GENERAL DESCRIPTION OF EUT	8
3.2 DESCRIPTION OF TEST MODES	10
3.2.1 CONFIGURATION OF SYSTEM UNDER TEST	11
3.2.2 TEST MODE APPLICABILITY AND TESTED CHANNEL DETAIL	12
3.3 GENERAL DESCRIPTION OF APPLIED STANDARDS	16
3.4 DESCRIPTION OF SUPPORT UNITS	17
4. TEST TYPES AND RESULTS (FOR 2.4GHz BAND)	18
4.1 RADIATED EMISSION MEASUREMENT	18
4.1.1 LIMITS OF RADIATED EMISSION MEASUREMENT	18
4.1.2 TEST INSTRUMENTS.....	19
4.1.3 TEST PROCEDURES	20
4.1.4 DEVIATION FROM TEST STANDARD.....	20
4.1.5 TEST SETUP	21
4.1.6 EUT OPERATING CONDITIONS	21
4.1.7 TEST RESULTS	22
4.2 CONDUCTED EMISSION MEASUREMENT	36
4.2.1 LIMITS OF CONDUCTED EMISSION MEASUREMENT	36
4.2.2 TEST INSTRUMENTS.....	36
4.2.3 TEST PROCEDURES	37
4.2.4 DEVIATION FROM TEST STANDARD.....	37
4.2.5 TEST SETUP	38
4.2.6 EUT OPERATING CONDITIONS	38
4.2.7 TEST RESULTS	39
4.3 6dB BANDWIDTH MEASUREMENT	43
4.3.1 LIMITS OF 6dB BANDWIDTH MEASUREMENT	43
4.3.2 TEST INSTRUMENTS.....	43
4.3.3 TEST PROCEDURE.....	43
4.3.4 DEVIATION FROM TEST STANDARD.....	43
4.3.5 TEST SETUP	44
4.3.6 EUT OPERATING CONDITIONS	44
4.3.7 TEST RESULTS	45
4.4 MAXIMUM OUTPUT POWER	49



A D T

4.4.1	LIMITS OF MAXIMUM OUTPUT POWER MEASUREMENT	49
4.4.2	INSTRUMENTS	49
4.4.3	TEST PROCEDURES	49
4.4.4	DEVIATION FROM TEST STANDARD.....	50
4.4.5	TEST SETUP	50
4.4.6	EUT OPERATING CONDITIONS	50
4.4.7	TEST RESULTS	51
4.5	POWER SPECTRAL DENSITY MEASUREMENT	52
4.5.1	LIMITS OF POWER SPECTRAL DENSITY MEASUREMENT	52
4.5.2	TEST INSTRUMENTS.....	52
4.5.3	TEST PROCEDURE.....	52
4.5.4	DEVIATION FROM TEST STANDARD.....	53
4.5.5	TEST SETUP	53
4.5.6	EUT OPERATING CONDITION.....	53
4.5.7	TEST RESULTS	54
4.6	BAND EDGES MEASUREMENT	58
4.6.1	LIMITS OF BAND EDGES MEASUREMENT	58
4.6.2	TEST INSTRUMENTS.....	58
4.6.3	TEST PROCEDURE.....	59
4.6.4	DEVIATION FROM TEST STANDARD.....	59
4.6.5	EUT OPERATING CONDITION.....	59
4.6.6	TEST RESULTS	60
5.	TEST TYPES AND RESULTS (FOR 5.0GHz BAND).....	76
5.1	RADIATED EMISSION MEASUREMENT	76
5.1.1	LIMITS OF RADIATED EMISSION MEASUREMENT.....	76
5.1.2	TEST INSTRUMENTS.....	77
5.1.3	TEST PROCEDURES	78
5.1.4	DEVIATION FROM TEST STANDARD.....	78
5.1.5	TEST SETUP	79
5.1.6	EUT OPERATING CONDITIONS	79
5.1.7	TEST RESULTS	80
5.2	CONDUCTED EMISSION MEASUREMENT	90
5.2.1	LIMITS OF CONDUCTED EMISSION MEASUREMENT	90
5.2.2	TEST INSTRUMENTS.....	90
5.2.3	TEST PROCEDURES	91
5.2.4	DEVIATION FROM TEST STANDARD.....	91
5.2.5	TEST SETUP.....	92
5.2.6	EUT OPERATING CONDITIONS	92
5.2.7	TEST RESULTS	93



A D T

5.3	6dB BANDWIDTH MEASUREMENT	97
5.3.1	LIMITS OF 6dB BANDWIDTH MEASUREMENT	97
5.3.2	TEST INSTRUMENTS.....	97
5.3.3	TEST PROCEDURE.....	97
5.3.4	DEVIATION FROM TEST STANDARD.....	98
5.3.5	TEST SETUP	98
5.3.6	EUT OPERATING CONDITIONS	98
5.3.7	TEST RESULTS	99
5.4	MAXIMUM OUTPUT POWER.....	102
5.4.1	LIMITS OF MAXIMUM OUTPUT POWER MEASUREMENT.....	102
5.4.2	INSTRUMENTS.....	102
5.4.3	TEST PROCEDURES	102
5.4.4	DEVIATION FROM TEST STANDARD.....	103
5.4.5	TEST SETUP.....	103
5.4.6	EUT OPERATING CONDITIONS	103
5.4.7	TEST RESULTS	104
5.5	POWER SPECTRAL DENSITY MEASUREMENT	105
5.5.1	LIMITS OF POWER SPECTRAL DENSITY MEASUREMENT	105
5.5.2	TEST INSTRUMENTS.....	105
5.5.3	TEST PROCEDURE.....	105
5.5.4	DEVIATION FROM TEST STANDARD.....	106
5.5.5	TEST SETUP	106
5.5.6	EUT OPERATING CONDITION.....	106
5.5.7	TEST RESULTS	107
5.6	BAND EDGES MEASUREMENT	110
5.6.1	LIMITS OF BAND EDGES MEASUREMENT.....	110
5.6.2	TEST INSTRUMENTS.....	110
5.6.3	TEST PROCEDURE.....	111
5.6.4	DEVIATION FROM TEST STANDARD.....	112
5.6.5	EUT OPERATING CONDITION.....	112
5.6.6	TEST RESULTS	112
6.	PHOTOGRAPHS OF THE TEST CONFIGURATION.....	122
7.	INFORMATION ON THE TESTING LABORATORIES	123
8.	APPENDIX A - MODIFICATIONS RECORDERS FOR ENGINEERING CHANGES TO THE EUT BY THE LAB.....	124



A D T

RELEASE CONTROL RECORD

ISSUE NO.	REASON FOR CHANGE	DATE ISSUED
Original release	N/A	Dec. 24, 2010



A D T

1. CERTIFICATION

PRODUCT: Mobile Broadband Router

MODEL: MBR1400

BRAND: cradlepoint

APPLICANT: Cradlepoint, Inc.

TESTED: Dec. 10 ~ Dec. 22, 2010

TEST SAMPLE: ENGINEERING SAMPLE

STANDARDS: **FCC Part 15, Subpart C (Section 15.247)**

ANSI C63.4-2003

ANSI C63.10-2009

The above equipment (Model: MBR1400) has been tested by **Bureau Veritas Consumer Products Services (H.K.) Ltd., Taoyuan Branch**, and found compliance with the requirement of the above standards. The test record, data evaluation & Equipment Under Test (EUT) configurations represented herein are true and accurate accounts of the measurements of the sample's EMC characteristics under the conditions specified in this report.

PREPARED BY :  , DATE : Dec. 24, 2010
Joanna Wang / Senior Specialist

APPROVED BY :  , DATE : Dec. 24, 2010
Gary Chang / Assistant Manager

2. SUMMARY OF TEST RESULTS

The EUT has been tested according to the following specifications:

APPLIED STANDARD: FCC PART 15, SUBPART C (SECTION 15.247)			
STANDARD SECTION	TEST TYPE AND LIMIT	RESULT	REMARK
15.207	AC Power Conducted Emission	PASS	Meet the requirement of limit. Minimum passing margin is -6.69dB at 0.197MHz.
15.247(a)(2)	Spectrum Bandwidth of a Direct Sequence Spread Spectrum System Limit: min. 500kHz	PASS	Meet the requirement of limit.
15.247(b)	Maximum Output Power Limit: max. 30dBm	PASS	Meet the requirement of limit.
15.247(d)	Radiated Emissions Limit: Table 15.209	PASS	Meet the requirement of limit. Minimum passing margin is -0.9dB at 5725.0MHz.
15.247(e)	Power Spectral Density Limit: max. 8dBm	PASS	Meet the requirement of limit.
15.247(d)	Band Edge Measurement Limit: 20dB less than the peak value of fundamental frequency	PASS	Meet the requirement of limit.
15.203	Antenna Requirement	PASS	Antenna connector is R-SMA not a standard connector.

2.1 MEASUREMENT UNCERTAINTY

Where relevant, the following measurement uncertainty levels have been estimated for tests performed on the EUT as specified in CISPR 16-4-2:

MEASUREMENT	FREQUENCY	UNCERTAINTY
Conducted emissions	150kHz~30MHz	2.44dB
Radiated emissions	30MHz ~ 200MHz	3.19dB
	200MHz ~1000MHz	3.21dB
	1GHz ~ 18GHz	2.26dB
	18GHz ~ 40GHz	1.94dB

This uncertainty represents an expanded uncertainty expressed at approximately the 95% confidence level using a coverage factor of $k = 2$.



3. GENERAL INFORMATION

3.1 GENERAL DESCRIPTION OF EUT

EUT	Mobile Broadband Router
MODEL NO.	MBR1400
FCC ID	UXX-MBR1400
POWER SUPPLY	12Vdc (adapter)
MODULATION TYPE	CCK, DQPSK, DBPSK for DSSS 64QAM, 16QAM, QPSK, BPSK for OFDM
MODULATION TECHNOLOGY	DSSS, OFDM
TRANSFER RATE	802.11b: 11.0/ 5.5/ 2.0/ 1.0Mbps 802.11g: 54.0/ 48.0/ 36.0/ 24.0/ 18.0/ 12.0/ 9.0/ 6.0Mbps 802.11a: 54.0/ 48.0/ 36.0/ 24.0/ 18.0/ 12.0/ 9.0/ 6.0Mbps 802.11n: up to 450.0Mbps
OPERATING FREQUENCY	2.4GHz: 2412 ~ 2462MHz 5.0GHz: 5745 ~ 5825MHz
NUMBER OF CHANNEL	2.4GHz: 11 for 802.11b, 802.11g, 802.11n (20MHz) 7 for 802.11n (40MHz) 5.0GHz: 5 for 802.11a, 802.11n (20MHz) 2 for 802.11n (40MHz)
OUTPUT POWER	404.9mW for 2412 ~ 2462MHz 351.2mW for 5745 ~ 5825MHz
ANTENNA TYPE	Dipole antenna with 5dBi gain
ANTENNA CONNECTOR	R-SMA
DATA CABLE	NA
I/O PORTS	Refer to user's manual
ACCESSORY DEVICES	adapter

NOTE:

1. The test data are separated into following test reports.

	TEST STANDARD	REFERENCE REPORT
WLAN 802.11b/g, 802.11n	FCC Part 15, Subpart C (Section 15.247)	RF991206C18
WLAN 802.11a, 802.11n (5745~5825 MHz)		
WLAN 802.11a, 802.11n (5180~ 5240MHz)	FCC Part 15, Subpart E (Section 15.407)	RF991206C18-1

2. The frequency bands used in this EUT are listed as follows:

Frequency Band (MHz)	2412~2462	5180~5240	5745~5825
802.11b	√		
802.11g	√		
802.11a		√	√
802.11n (20MHz)	√	√	√
802.11n (40MHz)	√	√	√

3. The EUT consumes power from the following adapters:

ADAPTER 1	
BRAND:	LEI
MODEL:	MU18-D120150-A1
INPUT:	100-240Vac, 50-60Hz, 0.6A
OUTPUT:	12Vdc, 1.5A
POWER LINE:	1.5m non-shielded cable without core

ADAPTER 2	
BRAND:	TENPAO
MODEL:	S018EM1200150
INPUT:	100-240Vac, 50-60Hz, 500mA
OUTPUT:	12Vdc, 1.5A
POWER LINE:	1.5m non-shielded cable without core

4. The EUT incorporates a MIMO function. Physically, the EUT provides three completed transmitters and three receivers.

MODULATION MODE	TX FUNCTION
802.11b	3TX
802.11g	3TX
802.11a	3TX
802.11n (20MHz)	3TX
802.11n (40MHz)	3TX

5. Co-transmitting emission of WLAN and 3G dongle/Express card have been evaluated and no non-compliance detected.
6. The above EUT information is declared by manufacturer and for more detailed features description, please refer to the manufacturer's specifications or user's manual.



3.2 DESCRIPTION OF TEST MODES

FOR 2.4GHz:

11 channels are provided for 802.11b, 802.11g and 802.11n (20MHz):

CHANNEL	FREQUENCY	CHANNEL	FREQUENCY
1	2412MHz	7	2442MHz
2	2417MHz	8	2447MHz
3	2422MHz	9	2452MHz
4	2427MHz	10	2457MHz
5	2432MHz	11	2462MHz
6	2437MHz		

7 channels are provided for 802.11n (40MHz):

CHANNEL	FREQUENCY	CHANNEL	FREQUENCY
1	2422MHz	5	2442MHz
2	2427MHz	6	2447MHz
3	2432MHz	7	2452MHz
4	2437MHz		

FOR 5.0GHz (5745 ~ 5825MHz):

5 channels are provided for 802.11a, 802.11n (20MHz):

CHANNEL	FREQUENCY	CHANNEL	FREQUENCY
149	5745MHz	161	5805MHz
153	5765MHz	165	5825MHz
157	5785MHz		

2 channels are provided for 802.11n (40MHz):

CHANNEL	FREQUENCY	CHANNEL	FREQUENCY
151	5755MHz	159	5795MHz

3.2.1 CONFIGURATION OF SYSTEM UNDER TEST

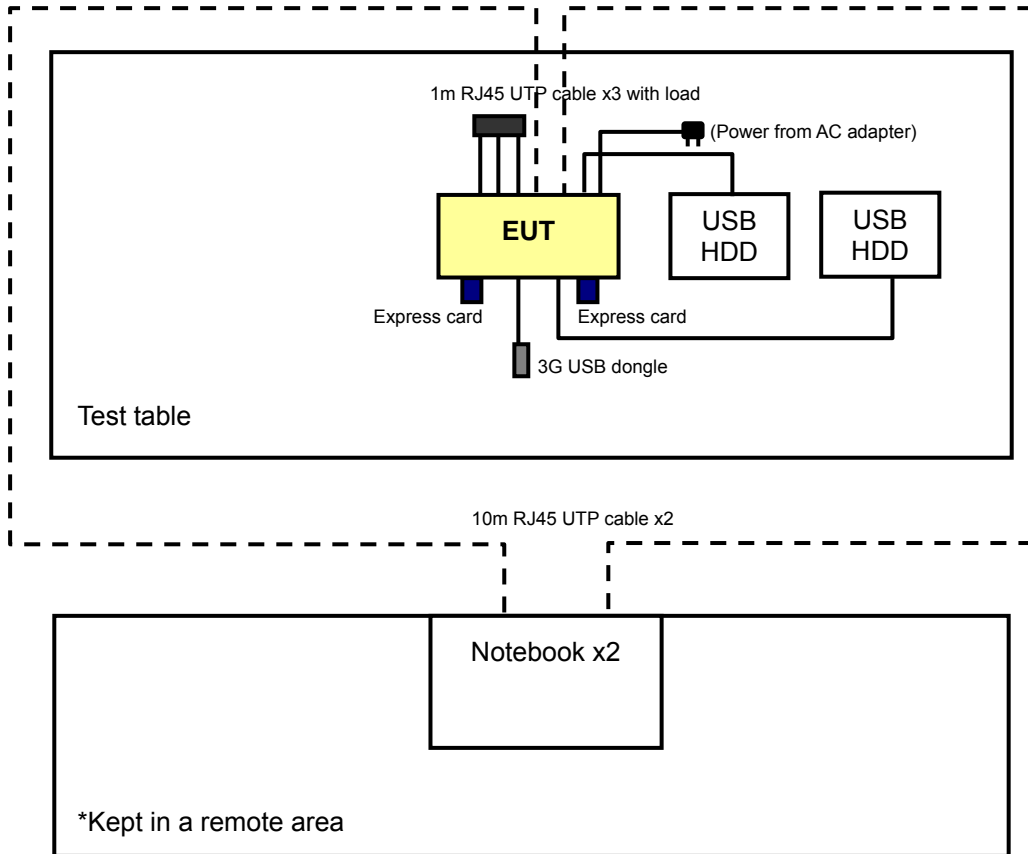



A D T

3.2.2 TEST MODE APPLICABILITY AND TESTED CHANNEL DETAIL

FOR 2.4GHz:

EUT CONFIGURE MODE	APPLICABLE TO				DESCRIPTION
	RE \geq 1G	RE<1G	PLC	APCM	
A	√	√	√	√	Power from adapter 1
B	-	√	√	-	Power from adapter 2

Where **RE \geq 1G**: Radiated Emission above 1GHz **RE<1G**: Radiated Emission below 1GHz
PLC: Power Line Conducted Emission **APCM**: Antenna Port Conducted Measurement

NOTE: "-": Means no effect.

RADIATED EMISSION TEST (ABOVE 1GHz):

- Pre-Scan has been conducted to determine the worst-case mode from all possible combinations between available modulations, XYZ axis and antenna ports (if EUT with antenna diversity architecture).
- Following channel(s) was (were) selected for the final test as listed below.

EUT CONFIGURE MODE	MODE	AVAILABLE CHANNEL	TESTED CHANNEL	MODULATION TECHNOLOGY	MODULATION TYPE	DATA RATE (Mbps)	AXIS
A	802.11b	1 to 11	1, 6, 11	DSSS	DBPSK	1.0	X
A	802.11g	1 to 11	1, 6, 11	OFDM	BPSK	6.0	X
A	802.11n (20MHz)	1 to 11	1, 6, 11	OFDM	BPSK	7.2	X
A	802.11n (40MHz)	1 to 7	1, 4, 7	OFDM	BPSK	15.0	X

RADIATED EMISSION TEST (BELOW 1GHz):

- Pre-Scan has been conducted to determine the worst-case mode from all possible combinations between available modulations, XYZ axis and antenna ports (if EUT with antenna diversity architecture).
- Following channel(s) was (were) selected for the final test as listed below.

EUT CONFIGURE MODE	MODE	AVAILABLE CHANNEL	TESTED CHANNEL	MODULATION TECHNOLOGY	MODULATION TYPE	DATA RATE (Mbps)	AXIS
A, B	802.11n (20MHz)	1 to 11	11	OFDM	BPSK	7.2	X

POWER LINE CONDUCTED EMISSION TEST:

- Pre-Scan has been conducted to determine the worst-case mode from all possible combinations between available modulations, data rates and antenna ports (if EUT with antenna diversity architecture).
- Following channel(s) was (were) selected for the final test as listed below.

EUT CONFIGURE MODE	MODE	AVAILABLE CHANNEL	TESTED CHANNEL	MODULATION TECHNOLOGY	MODULATION TYPE	DATA RATE (Mbps)
A, B	802.11n (20MHz)	1 to 11	11	OFDM	BPSK	7.2



BANDEDGE MEASUREMENT:

- Pre-Scan has been conducted to determine the worst-case mode from all possible combinations between available modulations, data rates and antenna ports (if EUT with antenna diversity architecture).
- Following channel(s) was (were) selected for the final test as listed below.

EUT CONFIGURE MODE	MODE	AVAILABLE CHANNEL	TESTED CHANNEL	MODULATION TECHNOLOGY	MODULATION TYPE	DATA RATE (Mbps)
A	802.11b	1 to 11	1, 11	DSSS	DBPSK	1.0
A	802.11g	1 to 11	1, 11	OFDM	BPSK	6.0
A	802.11n (20MHz)	1 to 11	1, 11	OFDM	BPSK	7.2
A	802.11n (40MHz)	1 to 7	1, 7	OFDM	BPSK	15.0

ANTENNA PORT CONDUCTED MEASUREMENT:

- Pre-Scan has been conducted to determine the worst-case mode from all possible combinations between available modulations, data rates and antenna ports (if EUT with antenna diversity architecture).
- Following channel(s) was (were) selected for the final test as listed below.

EUT CONFIGURE MODE	MODE	AVAILABLE CHANNEL	TESTED CHANNEL	MODULATION TECHNOLOGY	MODULATION TYPE	DATA RATE (Mbps)
A	802.11b	1 to 11	1, 6, 11	DSSS	DBPSK	1.0
A	802.11g	1 to 11	1, 6, 11	OFDM	BPSK	6.0
A	802.11n (20MHz)	1 to 11	1, 6, 11	OFDM	BPSK	7.2
A	802.11n (40MHz)	1 to 7	1, 4, 7	OFDM	BPSK	15.0

TEST CONDITION:

APPLICABLE TO	ENVIRONMENTAL CONDITIONS	INPUT POWER	TESTED BY
RE≥1G	28deg. C, 68%RH, 1010 hPa	120Vac, 60Hz	Sun Lin
RE<1G	25deg. C, 68%RH, 1006 hPa	120Vac, 60Hz	Match Tsui
PLC	20deg. C, 60%RH, 1009 hPa	120Vac, 60Hz	Match Tsui
APCM	25deg. C, 65%RH, 1006 hPa	120Vac, 60Hz	Match Tsui



A D T

FOR 5.745 ~ 5.825GHz:

EUT CONFIGURE MODE	APPLICABLE TO				DESCRIPTION
	RE≥1G	RE<1G	PLC	APCM	
A	√	√	√	√	Power from adapter 1
B	-	√	√	-	Power from adapter 2

Where **PLC:** Power Line Conducted Emission **RE<1G:** Radiated Emission below 1GHz
RE≥1G: Radiated Emission above 1GHz **APCM:** Antenna Port Conducted Measurement

NOTE: "-": Means no effect.

RADIATED EMISSION TEST (ABOVE 1GHz):

- Pre-Scan has been conducted to determine the worst-case mode from all possible combinations between available modulations, XYZ axis and antenna ports (if EUT with antenna diversity architecture).
- Following channel(s) was (were) selected for the final test as listed below.

EUT CONFIGURE MODE	MODE	AVAILABLE CHANNEL	TESTED CHANNEL	MODULATION TECHNOLOGY	MODULATION TYPE	DATA RATE (Mbps)	AXIS
A	802.11a	149 to 165	149, 157, 165	OFDM	BPSK	6.0	Z
A	802.11n (20MHz)	149 to 165	149, 157, 165	OFDM	BPSK	7.2	Z
A	802.11n (40MHz)	151 to 159	151, 159	OFDM	BPSK	15.0	Z

RADIATED EMISSION TEST (BELOW 1GHz):

- Pre-Scan has been conducted to determine the worst-case mode from all possible combinations between available modulations, XYZ axis and antenna ports (if EUT with antenna diversity architecture).
- Following channel(s) was (were) selected for the final test as listed below.

EUT CONFIGURE MODE	MODE	AVAILABLE CHANNEL	TESTED CHANNEL	MODULATION TECHNOLOGY	MODULATION TYPE	DATA RATE (Mbps)	AXIS
A, B	802.11a	149 to 165	149	OFDM	BPSK	6.0	Z

POWER LINE CONDUCTED EMISSION TEST:

- Pre-Scan has been conducted to determine the worst-case mode from all possible combinations between available modulations, data rates and antenna ports (if EUT with antenna diversity architecture).
- Following channel(s) was (were) selected for the final test as listed below.

EUT CONFIGURE MODE	MODE	AVAILABLE CHANNEL	TESTED CHANNEL	MODULATION TECHNOLOGY	MODULATION TYPE	DATA RATE (Mbps)
A, B	802.11a	149 to 165	149	OFDM	BPSK	6.0

BANDEDGE MEASUREMENT:

- Pre-Scan has been conducted to determine the worst-case mode from all possible combinations between available modulations, data rates and antenna ports (if EUT with antenna diversity architecture).
- Following channel(s) was (were) selected for the final test as listed below.

EUT CONFIGURE MODE	MODE	AVAILABLE CHANNEL	TESTED CHANNEL	MODULATION TECHNOLOGY	MODULATION TYPE	DATA RATE (Mbps)
A	802.11a	149 to 165	149, 165	OFDM	BPSK	6.0
A	802.11n (20MHz)	149 to 165	149, 165	OFDM	BPSK	7.2
A	802.11n (40MHz)	151 to 159	151, 159	OFDM	BPSK	15.0

ANTENNA PORT CONDUCTED MEASUREMENT:

- Pre-Scan has been conducted to determine the worst-case mode from all possible combinations between available modulations, data rates and antenna ports (if EUT with antenna diversity architecture).
- Following channel(s) was (were) selected for the final test as listed below.

EUT CONFIGURE MODE	MODE	AVAILABLE CHANNEL	TESTED CHANNEL	MODULATION TECHNOLOGY	MODULATION TYPE	DATA RATE (Mbps)
A	802.11a	149 to 165	149, 157, 165	OFDM	BPSK	6.0
A	802.11n (20MHz)	149 to 165	149, 157, 165	OFDM	BPSK	7.2
A	802.11n (40MHz)	151 to 159	151, 159	OFDM	BPSK	15.0

TEST CONDITION:

APPLICABLE TO	ENVIRONMENTAL CONDITIONS	INPUT POWER	TESTED BY
RE≥1G	25deg. C, 68%RH, 1006 hPa	120Vac, 60Hz	Sun Lin
RE<1G	28deg. C, 68%RH, 1010 hPa	120Vac, 60Hz	Match Tsui
PLC	20deg. C, 60%RH, 1009 hPa	120Vac, 60Hz	Match Tsui
APCM	25deg. C, 65%RH, 1006 hPa	120Vac, 60Hz	Match Tsui



A D T

3.3 GENERAL DESCRIPTION OF APPLIED STANDARDS

The EUT is a RF Product. According to the specifications of the manufacturer, it must comply with the requirements of the following standards:

FCC Part 15, Subpart C (15.247)

ANSI C63.4-2003

ANSI C63.10-2009

All test items have been performed and recorded as per the above standards.

NOTE: The EUT is also considered as a kind of computer peripheral, because the connection to computer is necessary for typical use. It has been verified to comply with the requirements of FCC Part 15, Subpart B, Class B (DoC). The test report has been issued separately.



3.4 DESCRIPTION OF SUPPORT UNITS

The EUT has been tested as an independent unit together with other necessary accessories or support units. The following support units or accessories were used to form a representative test configuration during the tests.

NO.	PRODUCT	BRAND	MODEL NO.	SERIAL NO.	FCC ID
1	NOTEBOOK	HP	n6000	CNU3480WP2	N/A
2	NOTEBOOK	DELL	D600	N09-00319	QDS-BRCM1005-D
3	EXTERNAL HARD DISK	Terasys	F12-UF	A0100222-4860009	FCC DoC Approved
4	EXTERNAL HARD DISK	Terasys	F12-UF	A0100222-4860017	FCC DoC Approved
5	USB DONGLE	HUAWEI	E219	N/A	QISE219
6	EXPRESS CARD	HUAWEI	E870	N/A	QISE870
7	EXPRESS CARD	SIERRA WIRELESS	AirCard 880E	N/A	N7NAC880E

NO.	SIGNAL CABLE DESCRIPTION OF THE ABOVE SUPPORT UNITS
1	10m UTP RJ45 cable
2	10m UTP RJ45 cable
3	1.5 m shielded cable, terminated with USB connector, w/o core.
4	1.5 m shielded cable, terminated with USB connector, w/o core.
5	N/A
6	N/A
7	N/A

- NOTE:**
1. All power cords of the above support units are non shielded (1.8m).
 2. Items 1-2 acted as communication partner to transfer data.
 3. Items 5-7 are provided by client.



A D T

4. TEST TYPES AND RESULTS (FOR 2.4GHz BAND)

4.1 RADIATED EMISSION MEASUREMENT

4.1.1 LIMITS OF RADIATED EMISSION MEASUREMENT

Emissions radiated outside of the specified bands, shall be according to the general radiated limits in 15.209 as following:

FREQUENCIES (MHz)	FIELD STRENGTH (microvolts/meter)	MEASUREMENT DISTANCE (meters)
0.009 ~ 0.490	2400/F(kHz)	300
0.490 ~ 1.705	24000/F(kHz)	30
1.705 ~ 30.0	30	30
30 ~ 88	100	3
88 ~ 216	150	3
216 ~ 960	200	3
Above 960	500	3

NOTE:

1. The lower limit shall apply at the transition frequencies.
2. Emission level (dBuV/m) = 20 log Emission level (uV/m).
3. As shown in 15.35(b), for frequencies above 1000MHz, the field strength limits are based on average detector, however, the peak field strength of any emission shall not exceed the maximum permitted average limits, specified above by more than 20dB under any condition of modulation.



A D T

4.1.2 TEST INSTRUMENTS

DESCRIPTION & MANUFACTURER	MODEL NO.	SERIAL NO.	DATE OF CALIBRATION	DUE DATE OF CALIBRATION
Test Receiver ROHDE & SCHWARZ	ESI7	838496/016	Dec. 29, 2009	Dec. 28, 2010
Spectrum Analyzer ROHDE & SCHWARZ	FSP40	100039	Jan. 11, 2010	Jan. 10, 2011
BILOG Antenna SCHWARZBECK	VULB9168	9168-155	Apr. 28, 2010	Apr. 27, 2011
HORN Antenna SCHWARZBECK	BBHA 9120D	9120D-408	Jan. 05, 2010	Jan. 04, 2011
HORN Antenna SCHWARZBECK	BBHA 9170	BBHA9170242	Dec. 25, 2009	Dec. 24, 2010
Preamplifier Agilent	8449B	3008A01961	Nov. 02, 2010	Nov. 01, 2011
Preamplifier Agilent	8447D	2944A10738	Nov. 02, 2010	Nov. 01, 2011
RF signal cable HUBER+SUHNNER	SUCOFLEX 104	274041/4	Aug. 21, 2010	Aug. 20, 2011
RF signal cable HUBER+SUHNNER	SUCOFLEX 104	283397/4	Aug. 21, 2010	Aug. 20, 2011
Software ADT.	ADT_Radiated_ V7.6.15.9.2	NA	NA	NA
Antenna Tower inn-co GmbH	MA 4000	010303	NA	NA
Antenna Tower Controller inn-co GmbH	CO2000	019303	NA	NA
Turn Table ADT.	TT100.	TT93021704	NA	NA
Turn Table Controller ADT.	SC100.	SC93021704	NA	NA

- NOTE:**
1. The calibration interval of the above test instruments is 12 months and the calibrations are traceable to NML/ROC and NIST/USA.
 2. The test was performed in HwaYa Chamber 4.
 3. The horn antenna and HP preamplifier (model: 8449B) are used only for the measurement of emission frequency above 1GHz if tested.
 4. The FCC Site Registration No. is 988962.
 5. The IC Site Registration No. is IC7450F-4.



A D T

4.1.3 TEST PROCEDURES

- a. The EUT was placed on the top of a rotating table 0.8 meters above the ground at a 3 meters semi-anechoic chamber. The table was rotated 360 degrees to determine the position of the highest radiation.
- b. The EUT was set 3 meters away from the interference-receiving antenna, which was mounted on the top of a variable-height antenna tower.
- c. The antenna is a broadband antenna, and its height is varied from one meter to four meters above the ground to determine the maximum value of the field strength. Both horizontal and vertical polarizations of the antenna are set to make the measurement.
- d. For each suspected emission, the EUT was arranged to its worst case and then the antenna was tuned to heights from 1 meter to 4 meters and the rotatable table was turned from 0 degrees to 360 degrees to find the maximum reading.
- e. The test-receiver system was set to Peak Detect Function and Specified Bandwidth with Maximum Hold Mode.
- f. If the emission level of the EUT in peak mode was lower than the limit specified, then testing could be stopped and the peak values of the EUT would be reported. Otherwise the emissions would be re-tested one by one using peak, quasi-peak or average method as specified and then reported in a data sheet.

NOTE:

1. The resolution bandwidth and video bandwidth of test receiver/spectrum analyzer is 120kHz for Quasi-peak detection at frequency below 1GHz.
2. The resolution bandwidth of test receiver/spectrum analyzer is 100kHz and video bandwidth is 300kHz for Peak detection at frequency above 1GHz.
3. The resolution bandwidth of test receiver/spectrum analyzer is 1MHz and the video bandwidth is 1kHz for Average detection (AV) at frequency above 1GHz.
4. All modes of operation were investigated and the worst-case emissions are reported.

4.1.4 DEVIATION FROM TEST STANDARD

No deviation.

4.1.5 TEST SETUP

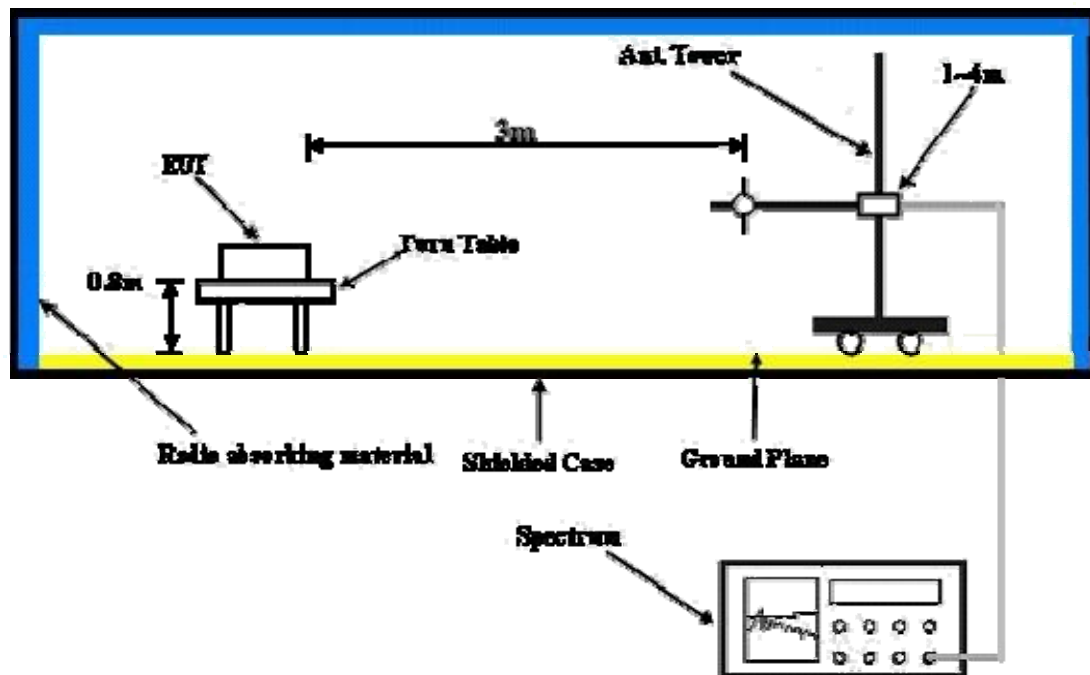

For the actual test configuration, please refer to the attached file (Test Setup Photo).

4.1.6 EUT OPERATING CONDITIONS

- a. Placed the EUT on the testing table.
- b. Prepared notebooks outside of testing area to act as a communication partners.
- c. The communication partners connected with EUT via a RJ45 UTP cable and run a test program (provided by manufacturer) to enable EUT under transmission condition continuously at specific channel frequency.
- d. The communication partner sent data to EUT by command "PING".
- e. The necessary accessories enable the EUT in full functions.



A D T

4.1.7 TEST RESULTS

802.11b

EUT TEST CONDITION		MEASUREMENT DETAIL	
CHANNEL	Channel 1	FREQUENCY RANGE	1 ~ 25GHz
INPUT POWER	120Vac, 60 Hz	DETECTOR FUNCTION	Peak (PK) Average (AV)
ENVIRONMENTAL CONDITIONS	25deg. C, 68%RH 1006 hPa	TESTED BY	Match Tsui

ANTENNA POLARITY & TEST DISTANCE: HORIZONTAL AT 3 M								
NO.	FREQ. (MHz)	EMISSION LEVEL (dBuV/m)	LIMIT (dBuV/m)	MARGIN (dB)	ANTENNA HEIGHT (m)	TABLE ANGLE (Degree)	RAW VALUE (dBuV)	CORRECTION FACTOR (dB/m)
1	2390.00	53.9 PK	74.0	-20.1	1.08 H	15	23.40	30.50
2	2390.00	45.2 AV	54.0	-8.8	1.08 H	15	14.70	30.50
3	*2412.00	104.2 PK			1.06 H	20	73.60	30.60
4	*2412.00	100.6 AV			1.06 H	20	70.00	30.60
5	4824.00	44.1 PK	74.0	-29.9	1.00 H	0	8.00	36.10
6	4824.00	31.3 AV	54.0	-22.7	1.00 H	0	-4.80	36.10
ANTENNA POLARITY & TEST DISTANCE: VERTICAL AT 3 M								
NO.	FREQ. (MHz)	EMISSION LEVEL (dBuV/m)	LIMIT (dBuV/m)	MARGIN (dB)	ANTENNA HEIGHT (m)	TABLE ANGLE (Degree)	RAW VALUE (dBuV)	CORRECTION FACTOR (dB/m)
1	2390.00	62.6 PK	74.0	-11.4	1.06 V	170	32.10	30.50
2	2390.00	52.7 AV	54.0	-1.3	1.06 V	170	22.20	30.50
3	*2412.00	116.1 PK			1.05 V	173	85.50	30.60
4	*2412.00	112.3 AV			1.05 V	173	81.70	30.60
5	4824.00	45.4 PK	74.0	-28.6	1.00 V	174	9.30	36.10
6	4824.00	35.5 AV	54.0	-18.5	1.00 V	174	-0.60	36.10

- REMARKS:**
1. Emission level (dBuV/m) = Raw Value (dBuV) + Correction Factor (dB/m).
 2. Correction Factor (dB/m) = Antenna Factor (dB/m) + Cable Factor (dB).
 3. The other emission levels were very low against the limit.
 4. Margin value = Emission level – Limit value.
 5. “ * ”: Fundamental frequency.



A D T

EUT TEST CONDITION		MEASUREMENT DETAIL	
CHANNEL	Channel 6	FREQUENCY RANGE	1 ~ 25GHz
INPUT POWER	120Vac, 60 Hz	DETECTOR FUNCTION	Peak (PK) Average (AV)
ENVIRONMENTAL CONDITIONS	25deg. C, 68%RH 1006 hPa	TESTED BY	Match Tsui

ANTENNA POLARITY & TEST DISTANCE: HORIZONTAL AT 3 M								
NO.	FREQ. (MHz)	EMISSION LEVEL (dBuV/m)	LIMIT (dBuV/m)	MARGIN (dB)	ANTENNA HEIGHT (m)	TABLE ANGLE (Degree)	RAW VALUE (dBuV)	CORRECTION FACTOR (dB/m)
1	2381.00	48.0 PK	74.0	-26.0	1.11 H	14	17.60	30.40
2	2381.00	40.4 AV	54.0	-13.6	1.11 H	14	10.00	30.40
3	*2437.00	103.6 PK			1.00 H	179	73.00	30.60
4	*2437.00	99.8 AV			1.00 H	179	69.20	30.60
5	4874.00	44.6 PK	74.0	-29.4	1.00 H	0	8.40	36.20
6	4874.00	31.8 AV	54.0	-22.2	1.00 H	0	-4.40	36.20
ANTENNA POLARITY & TEST DISTANCE: VERTICAL AT 3 M								
NO.	FREQ. (MHz)	EMISSION LEVEL (dBuV/m)	LIMIT (dBuV/m)	MARGIN (dB)	ANTENNA HEIGHT (m)	TABLE ANGLE (Degree)	RAW VALUE (dBuV)	CORRECTION FACTOR (dB/m)
1	2381.00	59.8 PK	74.0	-14.2	1.09 V	158	29.40	30.40
2	2381.00	50.5 AV	54.0	-3.5	1.09 V	158	20.10	30.40
3	*2437.00	115.7 PK			1.09 V	165	85.10	30.60
4	*2437.00	111.8 AV			1.09 V	165	81.20	30.60
5	4874.00	45.9 PK	74.0	-28.1	1.00 V	181	9.70	36.20
6	4874.00	35.6 AV	54.0	-18.4	1.00 V	181	-0.60	36.20

- REMARKS:**
1. Emission level (dBuV/m) = Raw Value (dBuV) + Correction Factor (dB/m).
 2. Correction Factor (dB/m) = Antenna Factor (dB/m) + Cable Factor (dB).
 3. The other emission levels were very low against the limit.
 4. Margin value = Emission level – Limit value.
 5. “ * “: Fundamental frequency.



A D T

EUT TEST CONDITION		MEASUREMENT DETAIL	
CHANNEL	Channel 11	FREQUENCY RANGE	1 ~ 25GHz
INPUT POWER	120Vac, 60 Hz	DETECTOR FUNCTION	Peak (PK) Average (AV)
ENVIRONMENTAL CONDITIONS	25deg. C, 68%RH 1006 hPa	TESTED BY	Match Tsui

ANTENNA POLARITY & TEST DISTANCE: HORIZONTAL AT 3 M								
NO.	FREQ. (MHz)	EMISSION LEVEL (dBuV/m)	LIMIT (dBuV/m)	MARGIN (dB)	ANTENNA HEIGHT (m)	TABLE ANGLE (Degree)	RAW VALUE (dBuV)	CORRECTION FACTOR (dB/m)
1	*2462.00	103.9 PK			1.35 H	360	73.20	30.70
2	*2462.00	100.2 AV			1.35 H	360	69.50	30.70
3	2483.50	54.4 PK	74.0	-19.6	1.35 H	360	23.60	30.80
4	2483.50	43.2 AV	54.0	-10.8	1.35 H	360	12.40	30.80
5	4924.00	45.3 PK	74.0	-28.7	1.01 H	350	9.00	36.30
6	4924.00	32.2 AV	54.0	-21.8	1.01 H	350	-4.10	36.30

ANTENNA POLARITY & TEST DISTANCE: VERTICAL AT 3 M								
NO.	FREQ. (MHz)	EMISSION LEVEL (dBuV/m)	LIMIT (dBuV/m)	MARGIN (dB)	ANTENNA HEIGHT (m)	TABLE ANGLE (Degree)	RAW VALUE (dBuV)	CORRECTION FACTOR (dB/m)
1	*2462.00	114.9 PK			1.12 V	269	84.20	30.70
2	*2462.00	111.5 AV			1.12 V	269	80.80	30.70
3	2498.00	55.7 PK	74.0	-18.3	1.09 V	269	24.80	30.90
4	2498.00	46.4 AV	54.0	-7.6	1.09 V	269	15.50	30.90
5	4924.00	46.5 PK	74.0	-27.5	1.01 V	188	10.20	36.30
6	4924.00	36.5 AV	54.0	-17.5	1.01 V	188	0.20	36.30

- REMARKS:**
1. Emission level (dBuV/m) = Raw Value (dBuV) + Correction Factor (dB/m).
 2. Correction Factor (dB/m) = Antenna Factor (dB/m) + Cable Factor (dB).
 3. The other emission levels were very low against the limit.
 4. Margin value = Emission level – Limit value.
 5. “ * “: Fundamental frequency.



A D T

802.11g

EUT TEST CONDITION		MEASUREMENT DETAIL	
CHANNEL	Channel 1	FREQUENCY RANGE	1 ~ 25GHz
INPUT POWER	120Vac, 60 Hz	DETECTOR FUNCTION	Peak (PK) Average (AV)
ENVIRONMENTAL CONDITIONS	25deg. C, 68%RH 1006 hPa	TESTED BY	Match Tsui

ANTENNA POLARITY & TEST DISTANCE: HORIZONTAL AT 3 M								
NO.	FREQ. (MHz)	EMISSION LEVEL (dBuV/m)	LIMIT (dBuV/m)	MARGIN (dB)	ANTENNA HEIGHT (m)	TABLE ANGLE (Degree)	RAW VALUE (dBuV)	CORRECTION FACTOR (dB/m)
1	2390.00	53.6 PK	74.0	-20.4	1.05 H	18	23.10	30.50
2	2390.00	43.6 AV	54.0	-10.4	1.05 H	18	13.10	30.50
3	*2412.00	101.3 PK			1.06 H	22	70.70	30.60
4	*2412.00	92.5 AV			1.06 H	22	61.90	30.60
5	4824.00	42.5 PK	74.0	-31.5	1.04 H	0	6.40	36.10
6	4824.00	30.5 AV	54.0	-23.5	1.04 H	0	-5.60	36.10
ANTENNA POLARITY & TEST DISTANCE: VERTICAL AT 3 M								
NO.	FREQ. (MHz)	EMISSION LEVEL (dBuV/m)	LIMIT (dBuV/m)	MARGIN (dB)	ANTENNA HEIGHT (m)	TABLE ANGLE (Degree)	RAW VALUE (dBuV)	CORRECTION FACTOR (dB/m)
1	2390.00	66.5 PK	74.0	-7.5	1.08 V	247	36.00	30.50
2	2390.00	50.8 AV	54.0	-3.2	1.08 V	247	20.30	30.50
3	*2412.00	112.8 PK			1.16 V	3	82.20	30.60
4	*2412.00	103.6 AV			1.16 V	3	73.00	30.60
5	4824.00	42.7 PK	74.0	-31.3	1.03 V	0	6.60	36.10
6	4824.00	30.9 AV	54.0	-23.1	1.03 V	0	-5.20	36.10

- REMARKS:**
1. Emission level (dBuV/m) = Raw Value (dBuV) + Correction Factor (dB/m).
 2. Correction Factor (dB/m) = Antenna Factor (dB/m) + Cable Factor (dB).
 3. The other emission levels were very low against the limit.
 4. Margin value = Emission level – Limit value.
 5. “ * “: Fundamental frequency.



A D T

EUT TEST CONDITION		MEASUREMENT DETAIL	
CHANNEL	Channel 6	FREQUENCY RANGE	1 ~ 25GHz
INPUT POWER	120Vac, 60 Hz	DETECTOR FUNCTION	Peak (PK) Average (AV)
ENVIRONMENTAL CONDITIONS	25deg. C, 68%RH 1006 hPa	TESTED BY	Match Tsui

ANTENNA POLARITY & TEST DISTANCE: HORIZONTAL AT 3 M								
NO.	FREQ. (MHz)	EMISSION LEVEL (dBuV/m)	LIMIT (dBuV/m)	MARGIN (dB)	ANTENNA HEIGHT (m)	TABLE ANGLE (Degree)	RAW VALUE (dBuV)	CORRECTION FACTOR (dB/m)
1	2385.00	51.5 PK	74.0	-22.5	1.33 H	15	21.00	30.50
2	2385.00	42.9 AV	54.0	-11.1	1.33 H	15	12.40	30.50
3	*2437.00	101.7 PK			1.33 H	15	71.10	30.60
4	*2437.00	92.8 AV			1.33 H	15	62.20	30.60
5	4874.00	42.8 PK	74.0	-31.2	1.09 H	360	6.60	36.20
6	4874.00	31.0 AV	54.0	-23.0	1.09 H	360	-5.20	36.20
ANTENNA POLARITY & TEST DISTANCE: VERTICAL AT 3 M								
NO.	FREQ. (MHz)	EMISSION LEVEL (dBuV/m)	LIMIT (dBuV/m)	MARGIN (dB)	ANTENNA HEIGHT (m)	TABLE ANGLE (Degree)	RAW VALUE (dBuV)	CORRECTION FACTOR (dB/m)
1	2385.00	60.1 PK	74.0	-13.9	1.19 V	333	29.60	30.50
2	2385.00	50.7 AV	54.0	-3.3	1.19 V	333	20.20	30.50
3	*2437.00	112.1 PK			1.15 V	352	81.50	30.60
4	*2437.00	103.6 AV			1.15 V	352	73.00	30.60
5	4874.00	42.9 PK	74.0	-31.1	1.19 V	360	6.70	36.20
6	4874.00	31.4 AV	54.0	-22.6	1.19 V	360	-4.80	36.20

- REMARKS:**
1. Emission level (dBuV/m) = Raw Value (dBuV) + Correction Factor (dB/m).
 2. Correction Factor (dB/m) = Antenna Factor (dB/m) + Cable Factor (dB).
 3. The other emission levels were very low against the limit.
 4. Margin value = Emission level – Limit value.
 5. “ * “: Fundamental frequency.



A D T

EUT TEST CONDITION		MEASUREMENT DETAIL	
CHANNEL	Channel 11	FREQUENCY RANGE	1 ~ 25GHz
INPUT POWER	120Vac, 60 Hz	DETECTOR FUNCTION	Peak (PK) Average (AV)
ENVIRONMENTAL CONDITIONS	25deg. C, 68%RH 1006 hPa	TESTED BY	Match Tsui

ANTENNA POLARITY & TEST DISTANCE: HORIZONTAL AT 3 M								
NO.	FREQ. (MHz)	EMISSION LEVEL (dBuV/m)	LIMIT (dBuV/m)	MARGIN (dB)	ANTENNA HEIGHT (m)	TABLE ANGLE (Degree)	RAW VALUE (dBuV)	CORRECTION FACTOR (dB/m)
1	*2462.00	102.0 PK			1.04 H	22	71.30	30.70
2	*2462.00	92.8 AV			1.04 H	22	62.10	30.70
3	2483.50	53.0 PK	74.0	-21.0	1.04 H	22	22.20	30.80
4	2483.50	43.0 AV	54.0	-11.0	1.04 H	22	12.20	30.80
5	4924.00	42.9 PK	74.0	-31.1	1.00 H	360	6.60	36.30
6	4924.00	31.1 AV	54.0	-22.9	1.00 H	360	-5.20	36.30
ANTENNA POLARITY & TEST DISTANCE: VERTICAL AT 3 M								
NO.	FREQ. (MHz)	EMISSION LEVEL (dBuV/m)	LIMIT (dBuV/m)	MARGIN (dB)	ANTENNA HEIGHT (m)	TABLE ANGLE (Degree)	RAW VALUE (dBuV)	CORRECTION FACTOR (dB/m)
1	*2462.00	113.7 PK			1.06 V	174	83.00	30.70
2	*2462.00	104.2 AV			1.06 V	174	73.50	30.70
3	2483.50	62.8 PK	74.0	-11.2	1.10 V	175	32.00	30.80
4	2483.50	46.5 AV	54.0	-7.5	1.10 V	175	15.70	30.80
5	4924.00	44.2 PK	74.0	-29.8	1.10 V	0	7.90	36.30
6	4924.00	31.5 AV	54.0	-22.5	1.10 V	0	-4.80	36.30

- REMARKS:**
1. Emission level (dBuV/m) = Raw Value (dBuV) + Correction Factor (dB/m).
 2. Correction Factor (dB/m) = Antenna Factor (dB/m) + Cable Factor (dB).
 3. The other emission levels were very low against the limit.
 4. Margin value = Emission level – Limit value.
 5. “ * “: Fundamental frequency.



A D T

802.11n (20MHz)

EUT TEST CONDITION		MEASUREMENT DETAIL	
CHANNEL	Channel 1	FREQUENCY RANGE	1 ~ 25GHz
INPUT POWER	120Vac, 60 Hz	DETECTOR FUNCTION	Peak (PK) Average (AV)
ENVIRONMENTAL CONDITIONS	25deg. C, 68%RH 1006 hPa	TESTED BY	Match Tsui

ANTENNA POLARITY & TEST DISTANCE: HORIZONTAL AT 3 M								
NO.	FREQ. (MHz)	EMISSION LEVEL (dBuV/m)	LIMIT (dBuV/m)	MARGIN (dB)	ANTENNA HEIGHT (m)	TABLE ANGLE (Degree)	RAW VALUE (dBuV)	CORRECTION FACTOR (dB/m)
1	2390.00	52.7 PK	74.0	-21.3	1.10 H	350	22.20	30.50
2	2390.00	43.1 AV	54.0	-10.9	1.10 H	350	12.60	30.50
3	*2412.00	100.9 PK			1.13 H	355	70.30	30.60
4	*2412.00	91.9 AV			1.13 H	355	61.30	30.60
5	4824.00	42.8 PK	74.0	-31.2	1.10 H	0	6.70	36.10
6	4824.00	31.0 AV	54.0	-23.0	1.10 H	0	-5.10	36.10
ANTENNA POLARITY & TEST DISTANCE: VERTICAL AT 3 M								
NO.	FREQ. (MHz)	EMISSION LEVEL (dBuV/m)	LIMIT (dBuV/m)	MARGIN (dB)	ANTENNA HEIGHT (m)	TABLE ANGLE (Degree)	RAW VALUE (dBuV)	CORRECTION FACTOR (dB/m)
1	2390.00	71.9 PK	74.0	-2.1	1.10 V	152	41.40	30.50
2	2390.00	52.6 AV	54.0	-1.4	1.10 V	152	22.10	30.50
3	*2412.00	112.4 PK			1.15 V	360	81.80	30.60
4	*2412.00	103.1 AV			1.15 V	360	72.50	30.60
5	4824.00	43.5 PK	74.0	-30.5	1.10 V	360	7.40	36.10
6	4824.00	31.0 AV	54.0	-23.0	1.10 V	360	-5.10	36.10

- REMARKS:**
1. Emission level (dBuV/m) = Raw Value (dBuV) + Correction Factor (dB/m).
 2. Correction Factor (dB/m) = Antenna Factor (dB/m) + Cable Factor (dB).
 3. The other emission levels were very low against the limit.
 4. Margin value = Emission level – Limit value.
 5. “ * “: Fundamental frequency.



A D T

EUT TEST CONDITION		MEASUREMENT DETAIL	
CHANNEL	Channel 6	FREQUENCY RANGE	1 ~ 25GHz
INPUT POWER	120Vac, 60 Hz	DETECTOR FUNCTION	Peak (PK) Average (AV)
ENVIRONMENTAL CONDITIONS	25deg. C, 68%RH 1006 hPa	TESTED BY	Match Tsui

ANTENNA POLARITY & TEST DISTANCE: HORIZONTAL AT 3 M								
NO.	FREQ. (MHz)	EMISSION LEVEL (dBuV/m)	LIMIT (dBuV/m)	MARGIN (dB)	ANTENNA HEIGHT (m)	TABLE ANGLE (Degree)	RAW VALUE (dBuV)	CORRECTION FACTOR (dB/m)
1	2385.00	52.6 PK	74.0	-21.4	1.20 H	350	22.10	30.50
2	2385.00	43.4 AV	54.0	-10.6	1.20 H	350	12.90	30.50
3	*2437.00	102.0 PK			1.29 H	355	71.40	30.60
4	*2437.00	92.9 AV			1.29 H	355	62.30	30.60
5	4874.00	42.9 PK	74.0	-31.1	1.03 H	0	6.70	36.20
6	4874.00	31.1 AV	54.0	-22.9	1.03 H	0	-5.10	36.20
ANTENNA POLARITY & TEST DISTANCE: VERTICAL AT 3 M								
NO.	FREQ. (MHz)	EMISSION LEVEL (dBuV/m)	LIMIT (dBuV/m)	MARGIN (dB)	ANTENNA HEIGHT (m)	TABLE ANGLE (Degree)	RAW VALUE (dBuV)	CORRECTION FACTOR (dB/m)
1	2385.00	63.2 PK	74.0	-10.8	1.07 V	168	32.70	30.50
2	2385.00	52.5 AV	54.0	-1.5	1.07 V	168	22.00	30.50
3	*2437.00	113.6 PK			1.06 V	166	83.00	30.60
4	*2437.00	104.5 AV			1.06 V	166	73.90	30.60
5	4874.00	43.6 PK	74.0	-30.4	1.06 V	360	7.40	36.20
6	4874.00	31.5 AV	54.0	-22.5	1.06 V	360	-4.70	36.20

- REMARKS:**
1. Emission level (dBuV/m) = Raw Value (dBuV) + Correction Factor (dB/m).
 2. Correction Factor (dB/m) = Antenna Factor (dB/m) + Cable Factor (dB).
 3. The other emission levels were very low against the limit.
 4. Margin value = Emission level – Limit value.
 5. “ * “: Fundamental frequency.



A D T

EUT TEST CONDITION		MEASUREMENT DETAIL	
CHANNEL	Channel 11	FREQUENCY RANGE	1 ~ 25GHz
INPUT POWER	120Vac, 60 Hz	DETECTOR FUNCTION	Peak (PK) Average (AV)
ENVIRONMENTAL CONDITIONS	25deg. C, 68%RH 1006 hPa	TESTED BY	Match Tsui

ANTENNA POLARITY & TEST DISTANCE: HORIZONTAL AT 3 M								
NO.	FREQ. (MHz)	EMISSION LEVEL (dBuV/m)	LIMIT (dBuV/m)	MARGIN (dB)	ANTENNA HEIGHT (m)	TABLE ANGLE (Degree)	RAW VALUE (dBuV)	CORRECTION FACTOR (dB/m)
1	*2462.00	102.3 PK			1.31 H	360	71.60	30.70
2	*2462.00	93.1 AV			1.31 H	360	62.40	30.70
3	2483.50	54.7 PK	74.0	-19.3	1.29 H	290	23.90	30.80
4	2483.50	44.9 AV	54.0	-9.1	1.29 H	290	14.10	30.80
5	4924.00	42.7 PK	74.0	-31.3	1.00 H	0	6.40	36.30
6	4924.00	30.9 AV	54.0	-23.1	1.00 H	0	-5.40	36.30
ANTENNA POLARITY & TEST DISTANCE: VERTICAL AT 3 M								
NO.	FREQ. (MHz)	EMISSION LEVEL (dBuV/m)	LIMIT (dBuV/m)	MARGIN (dB)	ANTENNA HEIGHT (m)	TABLE ANGLE (Degree)	RAW VALUE (dBuV)	CORRECTION FACTOR (dB/m)
1	*2462.00	113.9 PK			1.10 V	159	83.20	30.70
2	*2462.00	104.7 AV			1.10 V	159	74.00	30.70
3	2483.50	65.7 PK	74.0	-8.3	1.10 V	140	34.90	30.80
4	2483.50	49.6 AV	54.0	-4.4	1.10 V	140	18.80	30.80
5	4924.00	43.0 PK	74.0	-31.0	1.06 V	333	6.70	36.30
6	4924.00	31.6 AV	54.0	-22.4	1.06 V	333	-4.70	36.30

- REMARKS:**
1. Emission level (dBuV/m) = Raw Value (dBuV) + Correction Factor (dB/m).
 2. Correction Factor (dB/m) = Antenna Factor (dB/m) + Cable Factor (dB).
 3. The other emission levels were very low against the limit.
 4. Margin value = Emission level – Limit value.
 5. “ * “: Fundamental frequency.



A D T

802.11n (40MHz)

EUT TEST CONDITION		MEASUREMENT DETAIL	
CHANNEL	Channel 1	FREQUENCY RANGE	1 ~ 25GHz
INPUT POWER	120Vac, 60 Hz	DETECTOR FUNCTION	Peak (PK) Average (AV)
ENVIRONMENTAL CONDITIONS	25deg. C, 68%RH 1006 hPa	TESTED BY	Match Tsui

ANTENNA POLARITY & TEST DISTANCE: HORIZONTAL AT 3 M								
NO.	FREQ. (MHz)	EMISSION LEVEL (dBuV/m)	LIMIT (dBuV/m)	MARGIN (dB)	ANTENNA HEIGHT (m)	TABLE ANGLE (Degree)	RAW VALUE (dBuV)	CORRECTION FACTOR (dB/m)
1	*2422.00	95.7 PK			1.02 H	352	65.10	30.60
2	*2422.00	86.5 AV			1.02 H	352	55.90	30.60
3	2483.50	55.2 PK	74.0	-18.8	1.07 H	322	24.40	30.80
4	2483.50	42.8 AV	54.0	-11.2	1.07 H	322	12.00	30.80
5	4824.00	42.8 PK	74.0	-31.2	1.08 H	99	6.70	36.10
6	4824.00	31.3 AV	54.0	-22.7	1.08 H	99	-4.80	36.10
ANTENNA POLARITY & TEST DISTANCE: VERTICAL AT 3 M								
NO.	FREQ. (MHz)	EMISSION LEVEL (dBuV/m)	LIMIT (dBuV/m)	MARGIN (dB)	ANTENNA HEIGHT (m)	TABLE ANGLE (Degree)	RAW VALUE (dBuV)	CORRECTION FACTOR (dB/m)
1	2390.00	67.3 PK	74.0	-6.7	1.13 V	205	36.80	30.50
2	2390.00	52.3 AV	54.0	-1.7	1.13 V	205	21.80	30.50
3	*2422.00	106.8 PK			1.12 V	158	76.20	30.60
4	*2422.00	97.8 AV			1.12 V	158	67.20	30.60
5	4824.00	44.8 PK	74.0	-29.2	1.08 V	299	8.70	36.10
6	4824.00	31.7 AV	54.0	-22.3	1.08 V	299	-4.40	36.10

- REMARKS:**
1. Emission level (dBuV/m) = Raw Value (dBuV) + Correction Factor (dB/m).
 2. Correction Factor (dB/m) = Antenna Factor (dB/m) + Cable Factor (dB).
 3. The other emission levels were very low against the limit.
 4. Margin value = Emission level – Limit value.
 5. “ * ”: Fundamental frequency.



A D T

EUT TEST CONDITION		MEASUREMENT DETAIL	
CHANNEL	Channel 4	FREQUENCY RANGE	1 ~ 25GHz
INPUT POWER	120Vac, 60 Hz	DETECTOR FUNCTION	Peak (PK) Average (AV)
ENVIRONMENTAL CONDITIONS	25deg. C, 68%RH 1006 hPa	TESTED BY	Match Tsui

ANTENNA POLARITY & TEST DISTANCE: HORIZONTAL AT 3 M								
NO.	FREQ. (MHz)	EMISSION LEVEL (dBuV/m)	LIMIT (dBuV/m)	MARGIN (dB)	ANTENNA HEIGHT (m)	TABLE ANGLE (Degree)	RAW VALUE (dBuV)	CORRECTION FACTOR (dB/m)
1	2390.00	53.3 PK	74.0	-20.7	1.04 H	14	22.80	30.50
2	2390.00	44.2 AV	54.0	-9.8	1.04 H	14	13.70	30.50
3	*2437.00	100.8 PK			1.02 H	14	70.20	30.60
4	*2437.00	92.1 AV			1.02 H	14	61.50	30.60
5	2483.50	52.6 PK	74.0	-21.4	1.02 H	14	21.80	30.80
6	2483.50	43.1 AV	54.0	-10.9	1.02 H	14	12.30	30.80
7	4874.00	43.1 PK	74.0	-30.9	1.05 H	360	6.90	36.20
8	4874.00	31.0 AV	54.0	-23.0	1.05 H	360	-5.20	36.20
ANTENNA POLARITY & TEST DISTANCE: VERTICAL AT 3 M								
NO.	FREQ. (MHz)	EMISSION LEVEL (dBuV/m)	LIMIT (dBuV/m)	MARGIN (dB)	ANTENNA HEIGHT (m)	TABLE ANGLE (Degree)	RAW VALUE (dBuV)	CORRECTION FACTOR (dB/m)
1	2390.00	63.3 PK	74.0	-10.7	1.15 V	37	32.80	30.50
2	2390.00	49.1 AV	54.0	-4.9	1.15 V	37	18.60	30.50
3	*2437.00	112.2 PK			1.13 V	342	81.60	30.60
4	*2437.00	103.5 AV			1.13 V	342	72.90	30.60
5	2483.50	59.9 PK	74.0	-14.1	1.11 V	341	29.10	30.80
6	2483.50	46.5 AV	54.0	-7.5	1.11 V	341	15.70	30.80
7	4874.00	44.5 PK	74.0	-29.5	1.11 V	360	8.30	36.20
8	4874.00	31.5 AV	54.0	-22.5	1.11 V	360	-4.70	36.20

- REMARKS:**
1. Emission level (dBuV/m) = Raw Value (dBuV) + Correction Factor (dB/m).
 2. Correction Factor (dB/m) = Antenna Factor (dB/m) + Cable Factor (dB).
 3. The other emission levels were very low against the limit.
 4. Margin value = Emission level – Limit value.
 5. “ * “: Fundamental frequency.



A D T

EUT TEST CONDITION		MEASUREMENT DETAIL	
CHANNEL	Channel 7	FREQUENCY RANGE	1 ~ 25GHz
INPUT POWER	120Vac, 60 Hz	DETECTOR FUNCTION	Peak (PK) Average (AV)
ENVIRONMENTAL CONDITIONS	25deg. C, 68%RH 1006 hPa	TESTED BY	Match Tsui

ANTENNA POLARITY & TEST DISTANCE: HORIZONTAL AT 3 M								
NO.	FREQ. (MHz)	EMISSION LEVEL (dBuV/m)	LIMIT (dBuV/m)	MARGIN (dB)	ANTENNA HEIGHT (m)	TABLE ANGLE (Degree)	RAW VALUE (dBuV)	CORRECTION FACTOR (dB/m)
1	*2452.00	99.7 PK			1.00 H	355	69.00	30.70
2	*2452.00	91.6 AV			1.00 H	355	60.90	30.70
3	2483.50	57.9 PK	74.0	-16.1	1.00 H	355	27.10	30.80
4	2483.50	45.3 AV	54.0	-8.7	1.00 H	355	14.50	30.80
5	4904.00	43.0 PK	74.0	-31.0	1.10 H	0	6.80	36.20
6	4904.00	31.1 AV	54.0	-22.9	1.10 H	0	-5.10	36.20
ANTENNA POLARITY & TEST DISTANCE: VERTICAL AT 3 M								
NO.	FREQ. (MHz)	EMISSION LEVEL (dBuV/m)	LIMIT (dBuV/m)	MARGIN (dB)	ANTENNA HEIGHT (m)	TABLE ANGLE (Degree)	RAW VALUE (dBuV)	CORRECTION FACTOR (dB/m)
1	*2452.00	111.6 PK			1.14 V	345	80.90	30.70
2	*2452.00	102.2 AV			1.14 V	345	71.50	30.70
3	2483.50	65.8 PK	74.0	-8.2	1.08 V	176	35.00	30.80
4	2483.50	52.4 AV	54.0	-1.6	1.08 V	176	21.60	30.80
5	4904.00	44.7 PK	74.0	-29.3	1.07 V	360	8.50	36.20
6	4904.00	31.7 AV	54.0	-22.3	1.07 V	360	-4.50	36.20

- REMARKS:**
1. Emission level (dBuV/m) = Raw Value (dBuV) + Correction Factor (dB/m).
 2. Correction Factor (dB/m) = Antenna Factor (dB/m) + Cable Factor (dB).
 3. The other emission levels were very low against the limit.
 4. Margin value = Emission level – Limit value.
 5. “ * “: Fundamental frequency.



A D T

BELOW 1GHz WORST-CASE DATA : 802.11a

EUT TEST CONDITION		MEASUREMENT DETAIL	
CHANNEL	Channel 149	FREQUENCY RANGE	Below 1000MHz
INPUT POWER	120Vac, 60 Hz	DETECTOR FUNCTION	Quasi-Peak
ENVIRONMENTAL CONDITIONS	28deg. C, 68%RH 1010 hPa	TESTED BY	Sun Lin
TEST MODE	A		

ANTENNA POLARITY & TEST DISTANCE: HORIZONTAL AT 3 M								
NO.	FREQ. (MHz)	EMISSION LEVEL (dBuV/m)	LIMIT (dBuV/m)	MARGIN (dB)	ANTENNA HEIGHT (m)	TABLE ANGLE (Degree)	RAW VALUE (dBuV)	CORRECTION FACTOR (dB/m)
1	125.17	33.7 QP	43.5	-9.8	1.25 H	106	21.50	12.20
2	249.60	37.7 QP	46.0	-8.3	1.00 H	181	23.20	14.50
3	375.98	40.4 QP	46.0	-5.6	1.00 H	163	22.30	18.10
4	500.42	42.4 QP	46.0	-3.6	1.75 H	160	20.70	21.70
5	626.80	39.4 QP	46.0	-6.6	1.50 H	1	14.80	24.60
6	753.18	37.8 QP	46.0	-8.2	1.00 H	190	10.40	27.40
ANTENNA POLARITY & TEST DISTANCE: VERTICAL AT 3 M								
NO.	FREQ. (MHz)	EMISSION LEVEL (dBuV/m)	LIMIT (dBuV/m)	MARGIN (dB)	ANTENNA HEIGHT (m)	TABLE ANGLE (Degree)	RAW VALUE (dBuV)	CORRECTION FACTOR (dB/m)
1	47.40	37.8 QP	40.0	-2.2	1.25 V	286	23.70	14.10
2	105.73	34.7 QP	43.5	-8.8	1.00 V	190	22.70	12.00
3	249.60	33.4 QP	46.0	-12.6	1.00 V	298	18.90	14.50
4	375.98	42.1 QP	46.0	-3.9	1.50 V	133	24.00	18.10
5	500.42	41.6 QP	46.0	-4.4	1.75 V	184	19.90	21.70
6	626.80	39.4 QP	46.0	-6.6	1.50 V	178	14.80	24.60

- REMARKS:**
1. Emission level (dBuV/m) = Raw Value (dBuV) + Correction Factor (dB/m).
 2. Correction Factor (dB/m) = Antenna Factor (dB/m) + Cable Factor (dB).
 3. The other emission levels were very low against the limit.
 4. Margin value = Emission level – Limit value.



A D T

EUT TEST CONDITION		MEASUREMENT DETAIL	
CHANNEL	Channel 149	FREQUENCY RANGE	Below 1000MHz
INPUT POWER	120Vac, 60 Hz	DETECTOR FUNCTION	Quasi-Peak
ENVIRONMENTAL CONDITIONS	28deg. C, 68%RH 1010 hPa	TESTED BY	Sun Lin
TEST MODE	B		

ANTENNA POLARITY & TEST DISTANCE: HORIZONTAL AT 3 M								
NO.	FREQ. (MHz)	EMISSION LEVEL (dBuV/m)	LIMIT (dBuV/m)	MARGIN (dB)	ANTENNA HEIGHT (m)	TABLE ANGLE (Degree)	RAW VALUE (dBuV)	CORRECTION FACTOR (dB/m)
1	96.01	34.2 QP	43.5	-9.3	1.75 H	289	23.60	10.60
2	249.60	38.1 QP	46.0	-7.9	1.75 H	64	23.60	14.50
3	375.98	38.6 QP	46.0	-7.4	1.00 H	238	20.50	18.10
4	500.42	41.1 QP	46.0	-4.9	1.75 H	61	19.40	21.70
5	626.80	39.3 QP	46.0	-6.7	1.00 H	205	14.70	24.60
6	751.23	37.0 QP	46.0	-9.0	1.75 H	40	9.60	27.40
ANTENNA POLARITY & TEST DISTANCE: VERTICAL AT 3 M								
NO.	FREQ. (MHz)	EMISSION LEVEL (dBuV/m)	LIMIT (dBuV/m)	MARGIN (dB)	ANTENNA HEIGHT (m)	TABLE ANGLE (Degree)	RAW VALUE (dBuV)	CORRECTION FACTOR (dB/m)
1	43.82	31.6 QP	40.0	-8.4	1.00 V	358	16.80	14.80
2	101.84	37.6 QP	43.5	-5.9	1.25 V	289	25.60	12.00
3	375.98	41.7 QP	46.0	-4.3	1.50 V	349	23.60	18.10
4	500.42	42.0 QP	46.0	-4.0	1.25 V	112	20.30	21.70
5	626.80	40.1 QP	46.0	-5.9	1.50 V	40	15.50	24.60
6	751.23	40.3 QP	46.0	-5.7	1.25 V	154	12.90	27.40

- REMARKS:**
1. Emission level (dBuV/m) = Raw Value (dBuV) + Correction Factor (dB/m).
 2. Correction Factor (dB/m) = Antenna Factor (dB/m) + Cable Factor (dB).
 3. The other emission levels were very low against the limit.
 4. Margin value = Emission level – Limit value.



4.2 CONDUCTED EMISSION MEASUREMENT

4.2.1 LIMITS OF CONDUCTED EMISSION MEASUREMENT

FREQUENCY OF EMISSION (MHz)	CONDUCTED LIMIT (dBµV)	
	Quasi-peak	Average
0.15 ~ 0.5	66 to 56	56 to 46
0.5 ~ 5	56	46
5 ~ 30	60	50

- NOTE:** 1. The lower limit shall apply at the transition frequencies.
 2. The limit decreases in line with the logarithm of the frequency in the range of 0.15 to 0.50MHz.
 3. All emanations from a class A/B digital device or system, including any network of conductors and apparatus connected thereto, shall not exceed the level of field strengths specified above.

4.2.2 TEST INSTRUMENTS

DESCRIPTION & MANUFACTURER	MODEL NO.	SERIAL NO.	DATE OF CALIBRATION	DUE DATE OF CALIBRATION
Test Receiver ROHDE & SCHWARZ	ESCS30	100291	Nov. 30, 2010	Nov. 29, 2011
RF signal cable Woken	5D-FB	Cable-HYC01-01	Dec. 30, 2009	Dec. 29, 2010
LISN ROHDE & SCHWARZ	ESH3-Z5	100312	Jun. 28, 2010	Jun. 27, 2011
LISN ROHDE & SCHWARZ	ESH3-Z5	835239/001	Feb. 10, 2010	Feb. 09, 2011
V-LISN SCHWARZBECK	NNBL 8226-2	8226-142	Jul. 12, 2010	Jul. 11, 2011
Software ADT	ADT_Cond_ V7.3.7	NA	NA	NA

- NOTE:** 1. The calibration interval of the above test instruments is 12 months and the calibrations are traceable to NML/ROC and NIST/USA.
 2. The test was performed in HwaYa Shielded Room 1.
 3. The VCCI Site Registration No. is C-2040.



A D T

4.2.3 TEST PROCEDURES

- a. The EUT was placed 0.4 meters from the conducting wall of the shielded room with EUT being connected to the power mains through a line impedance stabilization network (LISN). Other support units were connected to the power mains through another LISN. The two LISNs provide 50 ohm/ 50uH of coupling impedance for the measuring instrument.
- b. Both lines of the power mains connected to the EUT were checked for maximum conducted interference.
- c. The frequency range from 150kHz to 30MHz was searched. Emission levels under (Limit - 20dB) was not recorded.

NOTE: All modes of operation were investigated and the worst-case emissions are reported.

4.2.4 DEVIATION FROM TEST STANDARD

No deviation.

4.2.5 TEST SETUP

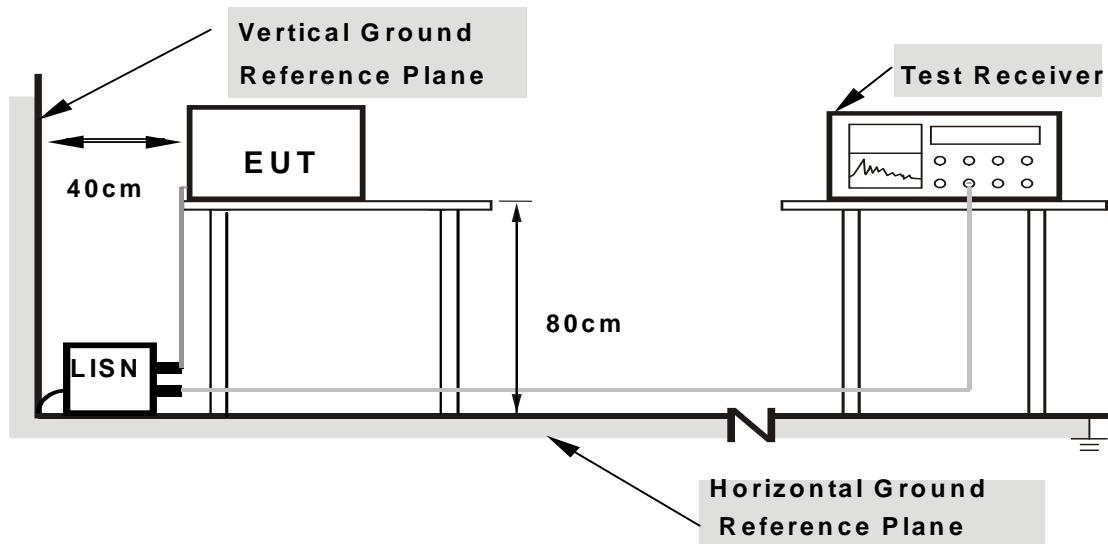

- Note:**
1. Support units were connected to second LISN.
 2. Both of LISNs (AMN) are 80 cm from EUT and at least 80 from other units and other metal planes

For the actual test configuration, please refer to the attached file (Test Setup Photo).

4.2.6 EUT OPERATING CONDITIONS

Same as 4.1.6.

4.2.7 TEST RESULTS

CONDUCTED WORST-CASE DATA : 802.11n (20MHz)

PHASE	Line 1	6dB BANDWIDTH	9kHz
TEST MODE	A		

No	Freq. [MHz]	Corr. Factor (dB)	Reading Value		Emission Level		Limit		Margin	
			[dB (uV)]		[dB (uV)]		[dB (uV)]		(dB)	
			Q.P.	AV.	Q.P.	AV.	Q.P.	AV.	Q.P.	AV.
1	0.150	0.12	48.55	-	48.67	-	66.00	56.00	-17.33	-
2	0.197	0.11	56.94	41.90	57.05	42.01	63.74	53.74	-6.69	-11.73
3	0.248	0.11	47.81	-	47.92	-	61.84	51.84	-13.91	-
4	0.326	0.12	38.98	-	39.10	-	59.56	49.56	-20.46	-
5	2.922	0.30	25.99	-	26.29	-	56.00	46.00	-29.71	-
6	14.234	0.99	34.41	-	35.40	-	60.00	50.00	-24.60	-

- REMARKS:**
1. Q.P. and AV. are abbreviations of quasi-peak and average individually.
 2. "-": The Quasi-peak reading value also meets average limit and measurement with the average detector is unnecessary.
 3. The emission levels of other frequencies were very low against the limit.
 4. Margin value = Emission level - Limit value
 5. Correction factor = Insertion loss + Cable loss
 6. Emission Level = Correction Factor + Reading Value.

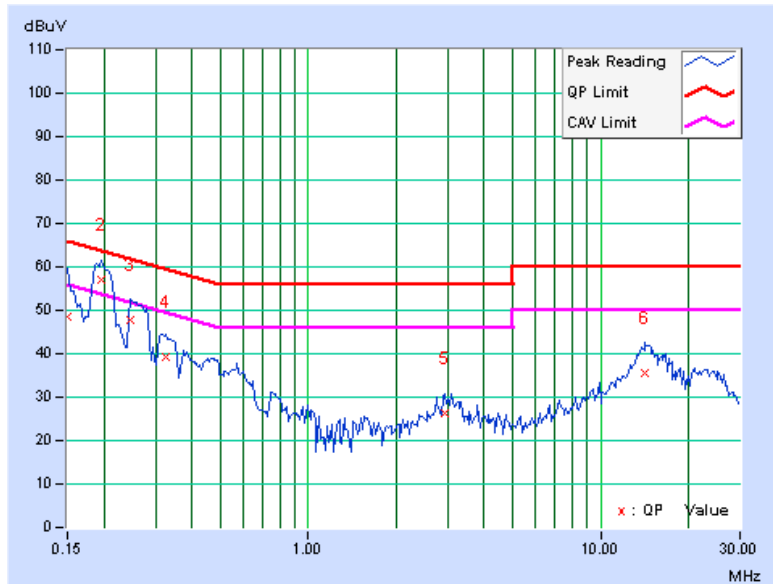

PHASE	Line 2	6dB BANDWIDTH	9kHz
TEST MODE	A		

No	Freq. [MHz]	Corr. Factor (dB)	Reading Value		Emission Level		Limit		Margin	
			[dB (uV)]		[dB (uV)]		[dB (uV)]		(dB)	
			Q.P.	AV.	Q.P.	AV.	Q.P.	AV.	Q.P.	AV.
1	0.150	0.10	48.10	-	48.20	-	66.00	56.00	-17.80	-
2	0.189	0.10	57.24	40.87	57.34	40.97	64.08	54.08	-6.74	-13.11
3	0.252	0.11	48.76	-	48.87	-	61.71	51.71	-12.84	-
4	0.474	0.13	37.60	-	37.73	-	56.44	46.44	-18.71	-
5	3.051	0.28	26.86	-	27.14	-	56.00	46.00	-28.86	-
6	13.582	0.82	35.69	-	36.51	-	60.00	50.00	-23.49	-

- REMARKS:**
1. Q.P. and AV. are abbreviations of quasi-peak and average individually.
 2. "-": The Quasi-peak reading value also meets average limit and measurement with the average detector is unnecessary.
 3. The emission levels of other frequencies were very low against the limit.
 4. Margin value = Emission level - Limit value
 5. Correction factor = Insertion loss + Cable loss
 6. Emission Level = Correction Factor + Reading Value.

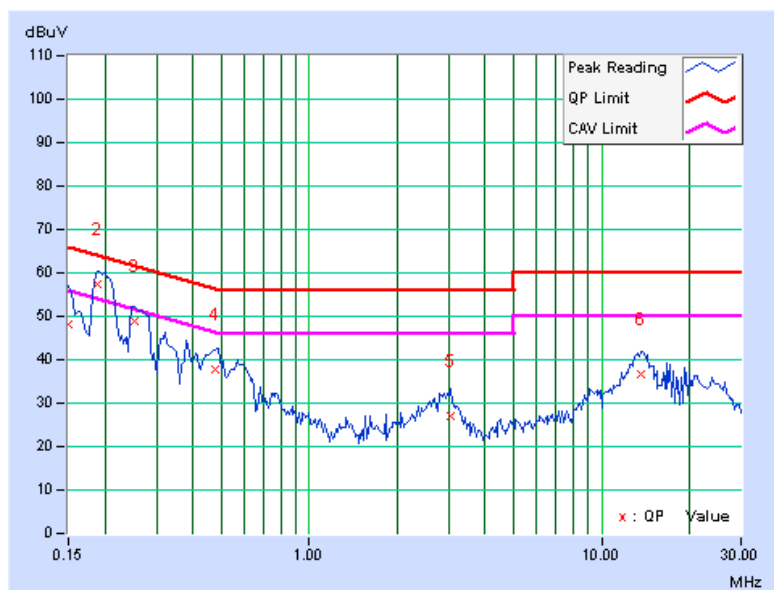

PHASE	Line 1	6dB BANDWIDTH	9kHz
TEST MODE	B		

No	Freq. [MHz]	Corr. Factor (dB)	Reading Value		Emission Level		Limit		Margin	
			[dB (uV)]		[dB (uV)]		[dB (uV)]		(dB)	
			Q.P.	AV.	Q.P.	AV.	Q.P.	AV.	Q.P.	AV.
1	0.166	0.12	53.19	-	53.31	-	65.18	55.18	-11.87	-
2	0.197	0.11	48.39	-	48.50	-	63.74	53.74	-15.24	-
3	0.236	0.11	43.34	-	43.45	-	62.24	52.24	-18.78	-
4	0.638	0.15	36.79	-	36.94	-	56.00	46.00	-19.06	-
5	1.758	0.23	29.43	-	29.66	-	56.00	46.00	-26.34	-
6	16.168	1.16	30.39	-	31.55	-	60.00	50.00	-28.45	-

- REMARKS:**
1. Q.P. and AV. are abbreviations of quasi-peak and average individually.
 2. "-": The Quasi-peak reading value also meets average limit and measurement with the average detector is unnecessary.
 3. The emission levels of other frequencies were very low against the limit.
 4. Margin value = Emission level - Limit value
 5. Correction factor = Insertion loss + Cable loss
 6. Emission Level = Correction Factor + Reading Value.

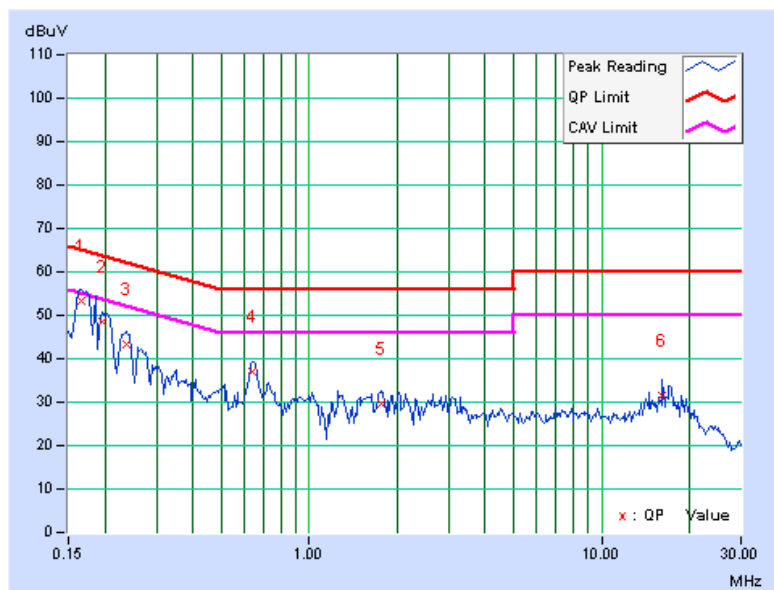

PHASE	Line 2	6dB BANDWIDTH	9kHz
TEST MODE	B		

No	Freq. [MHz]	Corr.	Reading Value		Emission Level		Limit		Margin	
		Factor	[dB (uV)]		[dB (uV)]		[dB (uV)]		(dB)	
		(dB)	Q.P.	AV.	Q.P.	AV.	Q.P.	AV.	Q.P.	AV.
1	0.166	0.10	52.63	-	52.73	-	65.18	55.18	-12.45	-
2	0.201	0.10	47.65	-	47.75	-	63.58	53.58	-15.83	-
3	0.228	0.10	42.16	-	42.26	-	62.52	52.52	-20.26	-
4	0.642	0.14	37.85	-	37.99	-	56.00	46.00	-18.01	-
5	3.453	0.30	28.51	-	28.81	-	56.00	46.00	-27.19	-
6	16.605	1.05	33.10	-	34.15	-	60.00	50.00	-25.85	-

- REMARKS:**
1. Q.P. and AV. are abbreviations of quasi-peak and average individually.
 2. "-": The Quasi-peak reading value also meets average limit and measurement with the average detector is unnecessary.
 3. The emission levels of other frequencies were very low against the limit.
 4. Margin value = Emission level - Limit value
 5. Correction factor = Insertion loss + Cable loss
 6. Emission Level = Correction Factor + Reading Value.

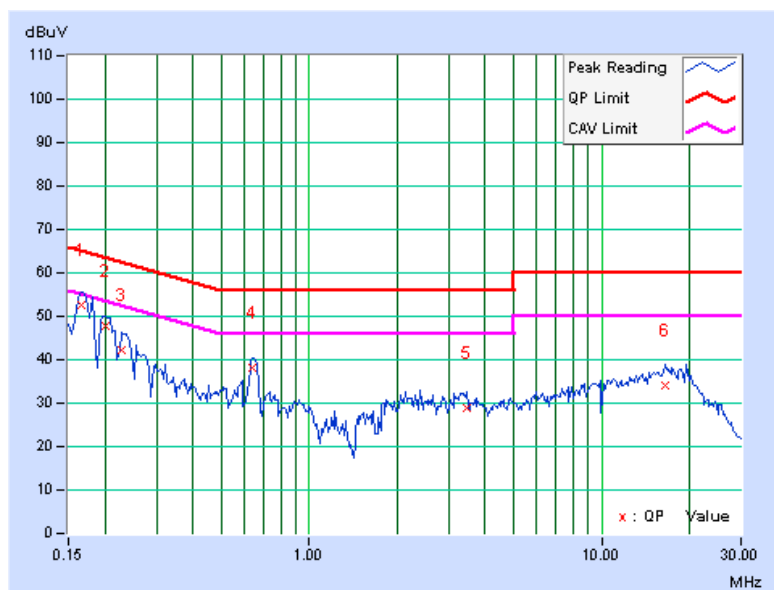



A D T

4.3 6dB BANDWIDTH MEASUREMENT

4.3.1 LIMITS OF 6dB BANDWIDTH MEASUREMENT

The minimum of 6dB Bandwidth Measurement is 0.5 MHz.

4.3.2 TEST INSTRUMENTS

DESCRIPTION & MANUFACTURER	MODEL NO.	SERIAL NO.	DATE OF CALIBRATION	DUE DATE OF CALIBRATION
R&S SPECTRUM ANALYZER	FSP40	100039	Jan. 11, 2010	Jan. 10, 2011

NOTE: The calibration interval of the above test instruments is 12 months and the calibrations are traceable to NML/ROC and NIST/USA.

4.3.3 TEST PROCEDURE

The transmitter output was connected to the spectrum analyzer through an attenuator. The bandwidth of the fundamental frequency was measured by spectrum analyzer with 100kHz RBW and 300kHz VBW. The 6dB bandwidth is defined as the total spectrum the power of which is higher than peak power minus 6dB.

4.3.4 DEVIATION FROM TEST STANDARD

No deviation.

4.3.5 TEST SETUP

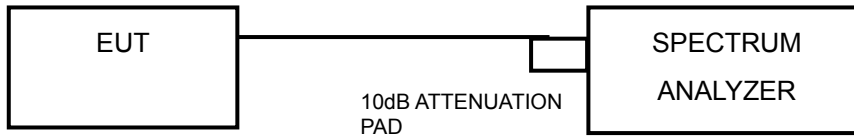

4.3.6 EUT OPERATING CONDITIONS

The software provided by client to enable the EUT under transmission condition continuously at lowest, middle and highest channel frequencies individually.



A D T

4.3.7 TEST RESULTS

802.11b

CHANNEL	CHANNEL FREQUENCY (MHz)	6dB BANDWIDTH (MHz)			MINIMUM LIMIT (MHz)	PASS / FAIL
		CHAIN 0	CHAIN 1	CHAIN 1		
1	2412	12.61	12.17	12.21	0.5	PASS
6	2437	12.21	12.36	12.19	0.5	PASS
11	2462	12.63	11.63	12.17	0.5	PASS

FOR CHAIN 0: CH 11

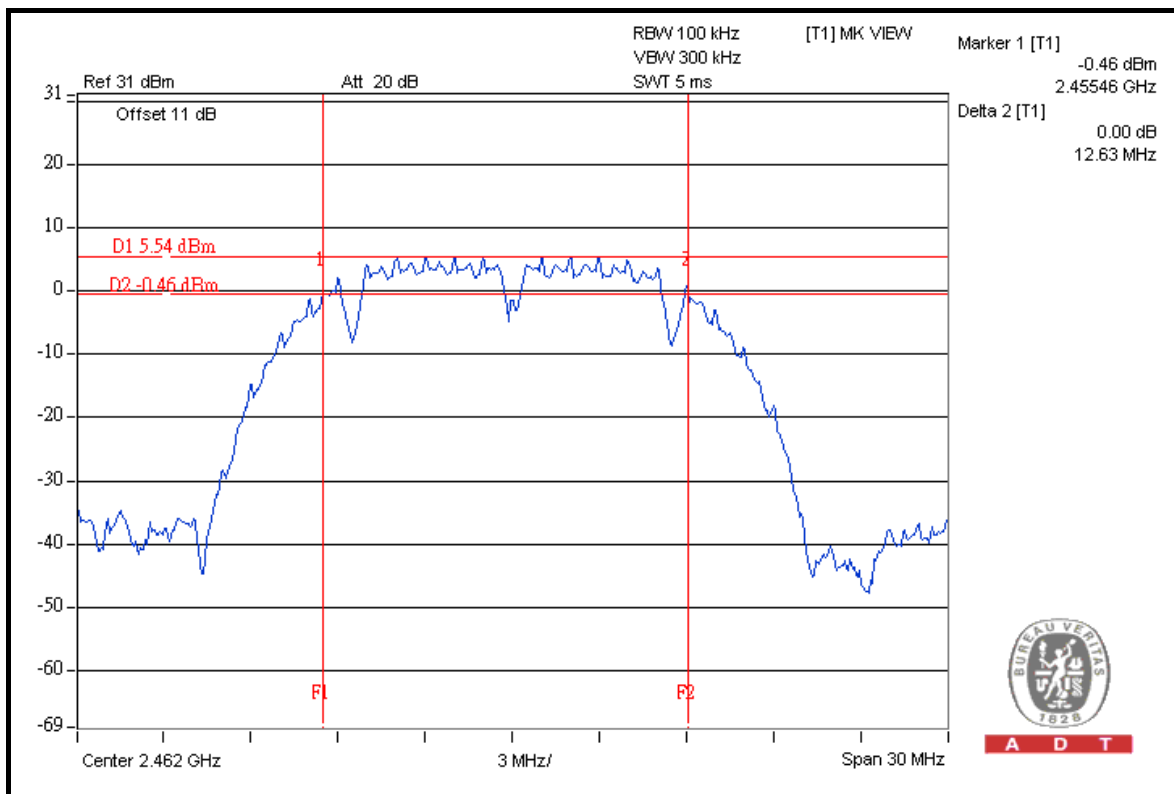



A D T

802.11g

CHANNEL	CHANNEL FREQUENCY (MHz)	6dB BANDWIDTH (MHz)			MINIMUM LIMIT (MHz)	PASS / FAIL
		CHAIN 0	CHAIN 1	CHAIN 1		
1	2412	16.51	16.52	16.55	0.5	PASS
6	2437	16.52	16.65	16.55	0.5	PASS
11	2462	16.48	16.51	16.55	0.5	PASS

FOR CHAIN 1: CH 6

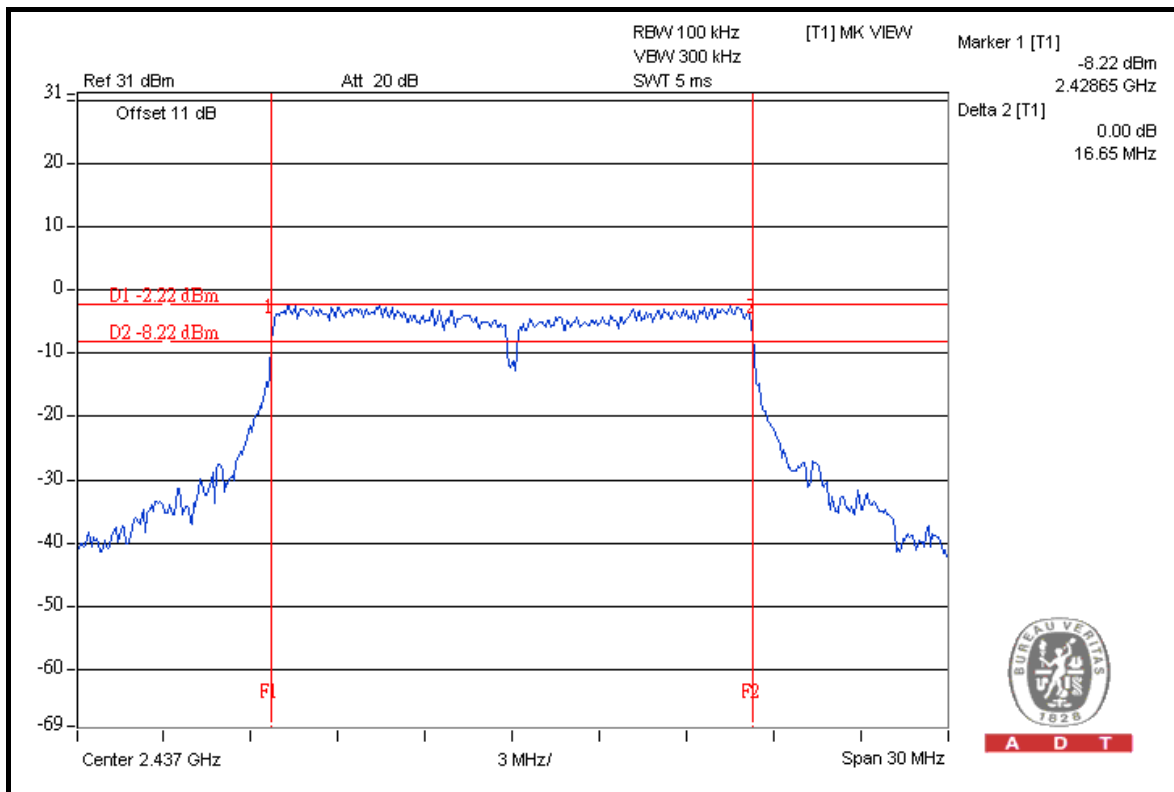



A D T

802.11n (20MHz)

CHANNEL	CHANNEL FREQUENCY (MHz)	6dB BANDWIDTH (MHz)			MINIMUM LIMIT (MHz)	PASS / FAIL
		CHAIN 0	CHAIN 1	CHAIN 1		
1	2412	17.64	17.40	17.68	0.5	PASS
6	2437	17.67	17.68	17.65	0.5	PASS
11	2462	17.26	17.02	17.40	0.5	PASS

FOR CHAIN 1: CH 6

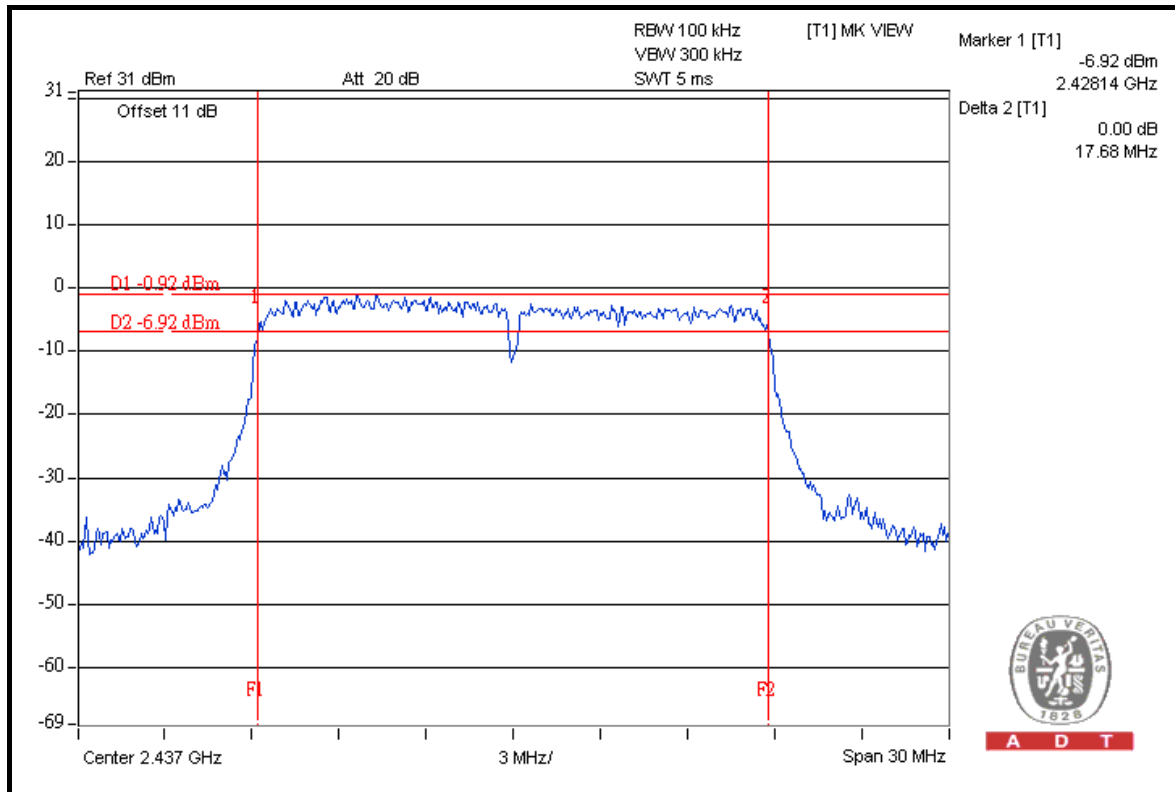

A D T



A D T

802.11n (40MHz)

CHANNEL	CHANNEL FREQUENCY (MHz)	6dB BANDWIDTH (MHz)			MINIMUM LIMIT (MHz)	PASS / FAIL
		CHAIN 0	CHAIN 1	CHAIN 1		
1	2422	36.43	36.44	36.31	0.5	PASS
4	2437	36.06	36.44	36.11	0.5	PASS
7	2452	35.13	35.32	35.89	0.5	PASS

FOR CHAIN 1: CH 4

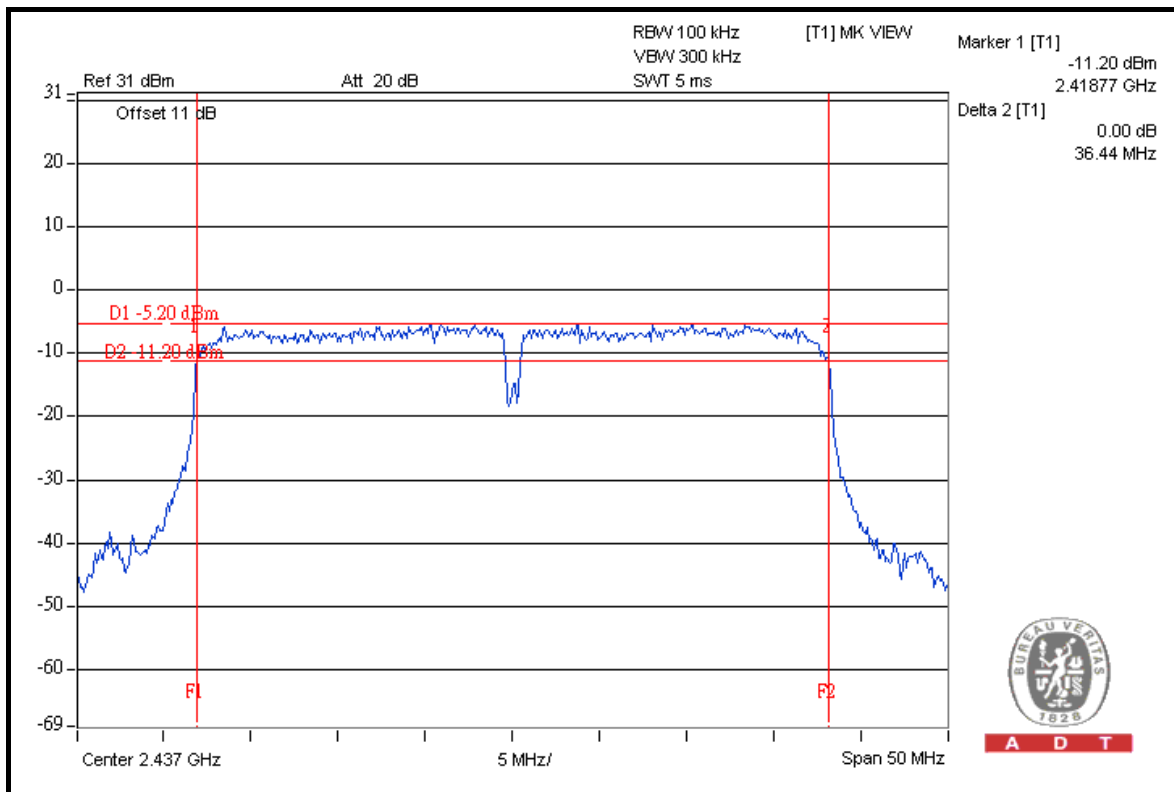

4.4 MAXIMUM OUTPUT POWER

4.4.1 LIMITS OF MAXIMUM OUTPUT POWER MEASUREMENT

The Maximum Output Power Measurement is 30dBm.

4.4.2 INSTRUMENTS

DESCRIPTION & MANUFACTURER	MODEL NO.	SERIAL NO.	DATE OF CALIBRATION	DUE DATE OF CALIBRATION
High Speed Peak Power Meter	ML2495A	0842014	Apr. 21, 2010	Apr. 20, 2011
Power Sensor	MA2411B	0738404	Apr. 21, 2010	Apr. 20, 2011

NOTE:

1. The calibration interval of the above test instruments is 12 months and the calibrations are traceable to NML/ROC and NIST/USA.
2. Measurement Bandwidth of ML2495A is 65MHz greater than 6dB bandwidth of emission.

4.4.3 TEST PROCEDURES

A power sensor was used on the output port of the EUT. A power meter was used to read the response of the power sensor. Record the power level.

4.4.4 DEVIATION FROM TEST STANDARD

No deviation.

4.4.5 TEST SETUP

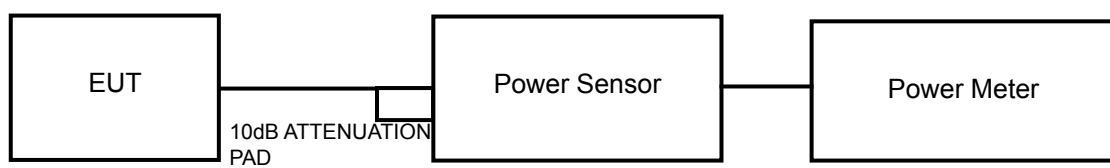

4.4.6 EUT OPERATING CONDITIONS

Same as Item 4.3.6.



4.4.7 TEST RESULTS

802.11b

CHAN.	CHAN. FREQ. (MHz)	POWER OUTPUT (dBm)			TOTAL POWER (mW)	TOTAL POWER (dBm)	POWER LIMIT (dBm)	PASS / FAIL
		CHAIN 0	CHAIN 1	CHAIN 2				
1	2412	19.6	19.7	19.8	281.8	24.5	26.2	PASS
6	2437	20.0	20.1	19.9	302.0	24.8	26.2	PASS
11	2462	20.6	20.6	20.5	338.8	25.3	26.2	PASS

Directional gain = 5dBi + 10log(3) = 9.8dBi > 6dBi, so the conducted power limit shall be reduced to 30 - (9.8 - 6) = 26.2dBm

802.11g

CHAN.	CHAN. FREQ. (MHz)	POWER OUTPUT (dBm)			TOTAL POWER (mW)	TOTAL POWER (dBm)	POWER LIMIT (dBm)	PASS / FAIL
		CHAIN 0	CHAIN 1	CHAIN 2				
1	2412	20.2	20.6	20.1	323.59	25.1	26.2	PASS
6	2437	20.7	20.3	20.3	331.13	25.2	26.2	PASS
11	2462	20.3	20.6	20.6	338.84	25.3	26.2	PASS

Directional gain = 5dBi + 10log(3) = 9.8dBi > 6dBi, so the conducted power limit shall be reduced to 30 - (9.8 - 6) = 26.2dBm

802.11n (20MHz)

CHAN.	CHAN. FREQ. (MHz)	POWER OUTPUT (dBm)			TOTAL POWER (mW)	TOTAL POWER (dBm)	POWER LIMIT (dBm)	PASS / FAIL
		CHAIN 0	CHAIN 1	CHAIN 2				
1	2412	20.3	20.2	20.3	319.0	25.0	30	PASS
6	2437	21.2	21.0	20.7	375.2	25.7	30	PASS
11	2462	21.4	21.1	21.4	404.9	26.1	30	PASS

802.11n (40MHz)

CHAN.	CHAN. FREQ. (MHz)	POWER OUTPUT (dBm)			TOTAL POWER (mW)	TOTAL POWER (dBm)	POWER LIMIT (dBm)	PASS / FAIL
		CHAIN 0	CHAIN 1	CHAIN 2				
1	2412	18.2	16.9	16.7	161.8	22.1	30	PASS
6	2437	21.2	21.2	21.4	401.7	26.0	30	PASS
11	2462	20.9	20.8	20.8	363.5	25.6	30	PASS



4.5 POWER SPECTRAL DENSITY MEASUREMENT

4.5.1 LIMITS OF POWER SPECTRAL DENSITY MEASUREMENT

The Maximum of Power Spectral Density Measurement is 8dBm.

4.5.2 TEST INSTRUMENTS

DESCRIPTION & MANUFACTURER	MODEL NO.	SERIAL NO.	DATE OF CALIBRATION	DUE DATE OF CALIBRATION
R&S SPECTRUM ANALYZER	FSP40	100039	Jan. 11, 2010	Jan. 10, 2011

NOTE: The calibration interval of the above test instruments is 12 months and the calibrations are traceable to NML/ROC and NIST/USA.

4.5.3 TEST PROCEDURE

The transmitter output was connected to the spectrum analyzer through an attenuator, the bandwidth of the fundamental frequency was measured with the spectrum analyzer using 3kHz RBW and 30kHz VBW, set sweep time = span/3kHz. The power spectral density was measured and recorded.

The sweep time is allowed to be longer than span/3kHz for a full response of the mixer in the spectrum analyzer.

4.5.4 DEVIATION FROM TEST STANDARD

No deviation

4.5.5 TEST SETUP

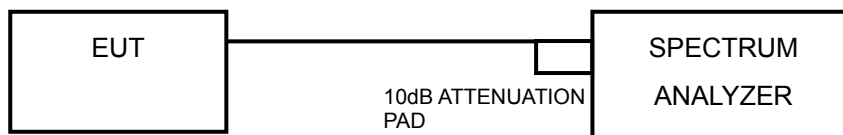

4.5.6 EUT OPERATING CONDITION

Same as Item 4.3.6

4.5.7 TEST RESULTS

802.11b

CHAN.	CHAN. FREQ. (MHz)	RF POWER LEVEL IN 3kHz BW (dBm)			TOTAL POWER DENSITY (mW)	TOTAL POWER DENSITY (dBm)	MAX. LIMIT (dBm)	PASS / FAIL
		CHAIN 0	CHAIN 1	CHAIN 2				
1	2412	-13.4	-12.8	-13.3	0.1	-8.4	4.2	PASS
6	2437	-13.1	-12.6	-13.4	0.2	-8.2	4.2	PASS
11	2462	-12.4	-12.1	-12.4	0.2	-7.5	4.2	PASS

Directional gain = $5\text{dBi} + 10\log(3) = 9.8\text{dBi} > 6\text{dBi}$, so the conducted power limit shall be reduced to $8 - (9.8 - 6) = 4.2\text{dBm}$

FOR CHAIN 1: CH 11

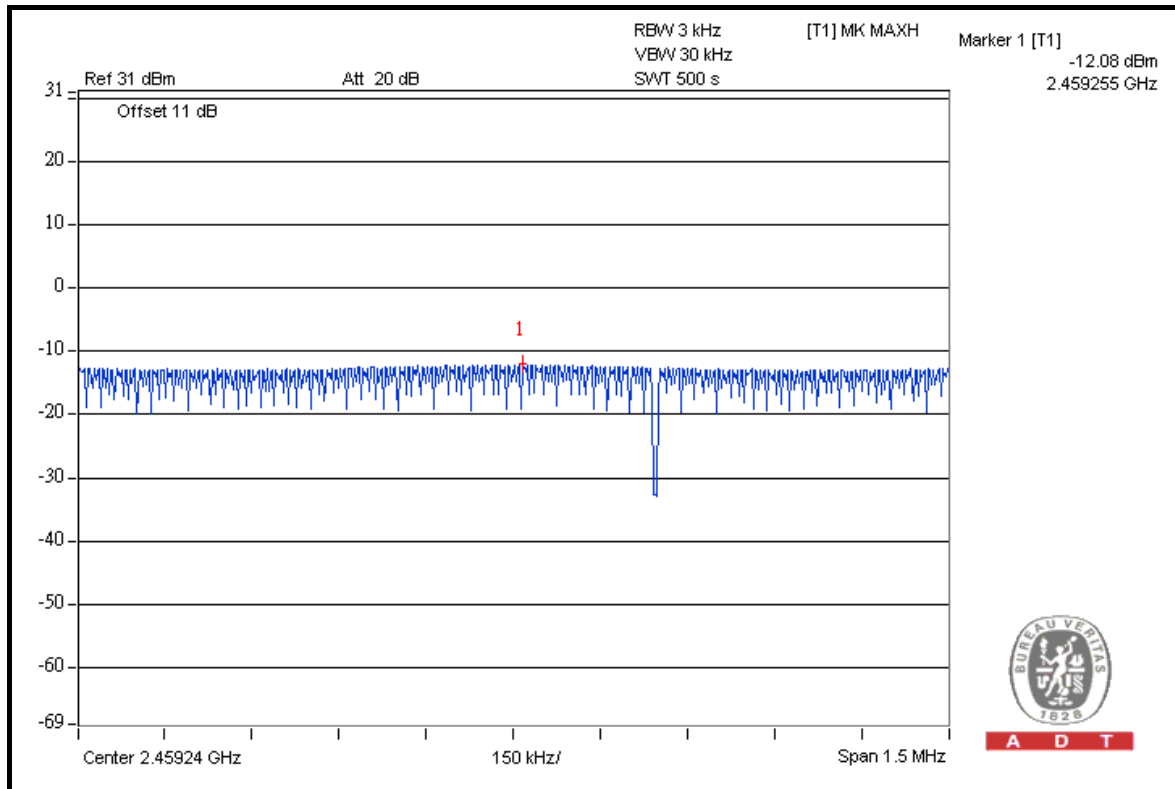



A D T

802.11g

CHAN.	CHAN. FREQ. (MHz)	RF POWER LEVEL IN 3kHz BW (dBm)			TOTAL POWER DENSITY (mW)	TOTAL POWER DENSITY (dBm)	MAX. LIMIT (dBm)	PASS / FAIL
		CHAIN 0	CHAIN 1	CHAIN 2				
1	2412	-16.2	-15.4	-17.1	0.1	-11.4	4.2	PASS
6	2437	-15.8	-15.9	-16.9	0.1	-11.4	4.2	PASS
11	2462	-16.2	-15.5	-16.4	0.1	-11.2	4.2	PASS

Directional gain = $5\text{dBi} + 10\log(3) = 9.8\text{dBi} > 6\text{dBi}$, so the conducted power limit shall be reduced to $8 - (9.8 - 6) = 4.2\text{dBm}$

FOR CHAIN 1: CH 1

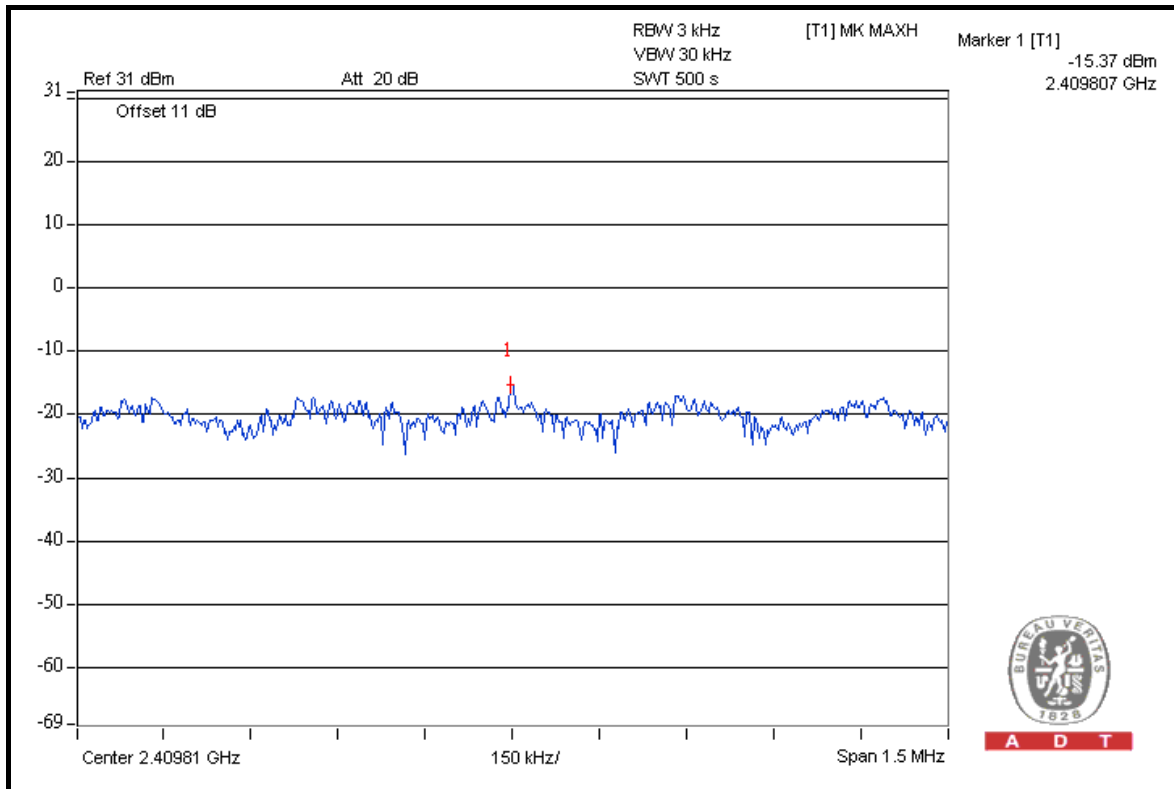



A D T

802.11n (20MHz)

CHAN.	CHAN. FREQ. (MHz)	RF POWER LEVEL IN 3kHz BW (dBm)			TOTAL POWER DENSITY (mW)	TOTAL POWER DENSITY (dBm)	MAX. LIMIT (dBm)	PASS / FAIL
		CHAIN 0	CHAIN 1	CHAIN 2				
1	2412	-15.1	-15.3	-15.1	0.1	-10.4	8	PASS
6	2437	-14.3	-14.4	-14.7	0.1	-9.7	8	PASS
11	2462	-14.0	-14.3	-14.0	0.1	-9.3	8	PASS

FOR CHAIN 0: CH 11

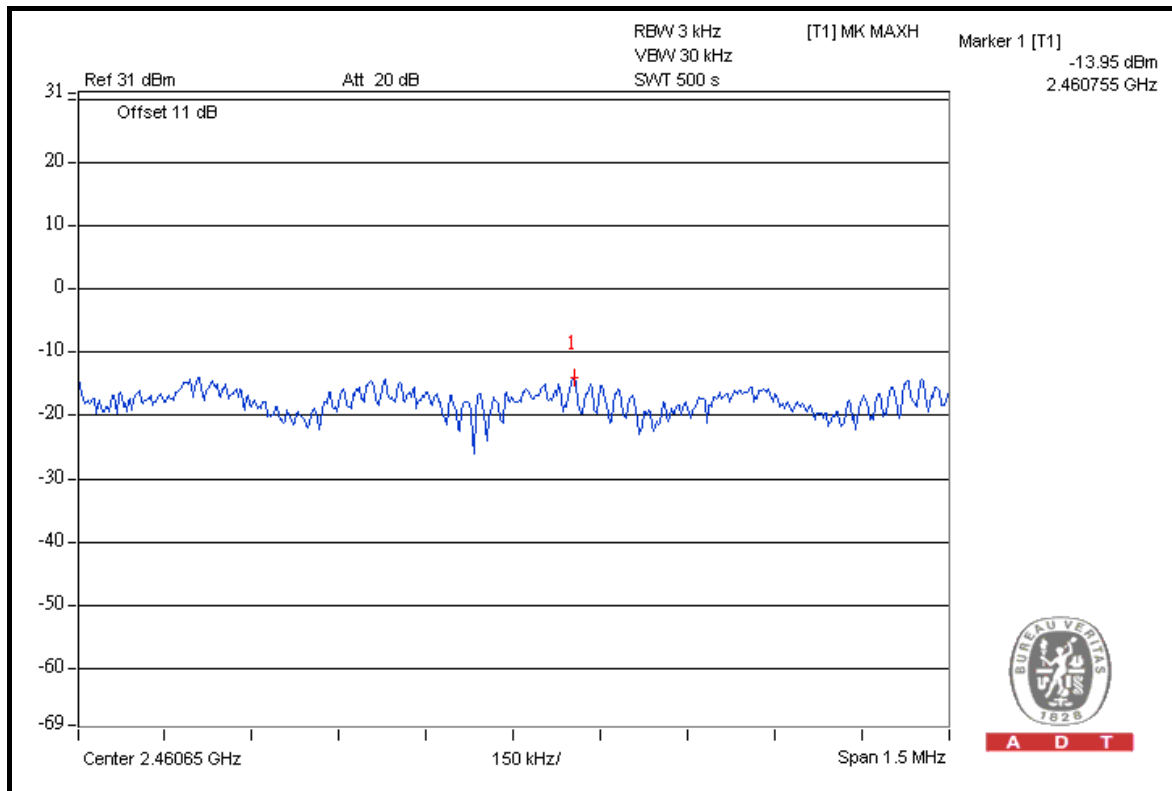



A D T

802.11n (40MHz)

CHAN.	CHAN. FREQ. (MHz)	RF POWER LEVEL IN 3kHz BW (dBm)			TOTAL POWER DENSITY (mW)	TOTAL POWER DENSITY (dBm)	MAX. LIMIT (dBm)	PASS / FAIL
		CHAIN 0	CHAIN 1	CHAIN 2				
1	2422	-23.8	-23.1	-21.8	0.0	-18.1	8	PASS
4	2437	-20.7	-19.0	-16.9	0.0	-13.8	8	PASS
7	2452	-21.1	-19.4	-17.6	0.0	-14.3	8	PASS

FOR CHAIN 2: CH 4

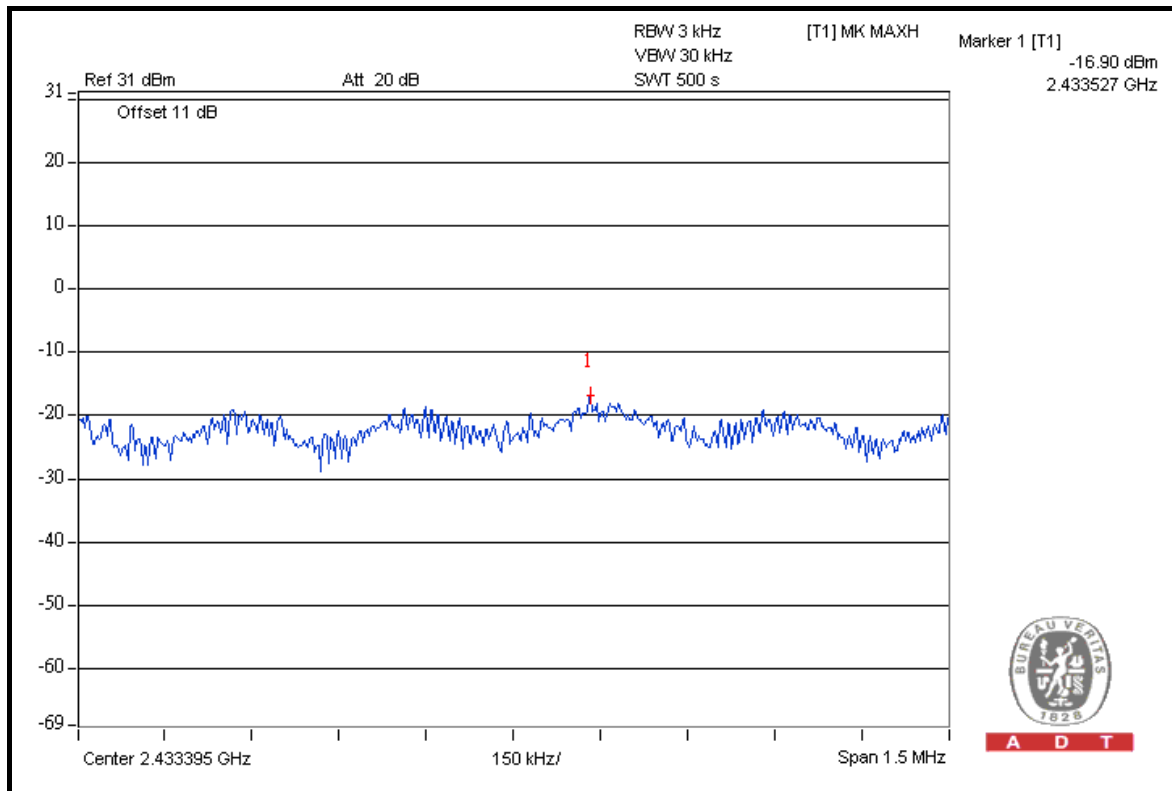



A D T

4.6 BAND EDGES MEASUREMENT

4.6.1 LIMITS OF BAND EDGES MEASUREMENT

Below -20 dB of the highest emission level of operating band (in 100kHz Resolution Bandwidth).

4.6.2 TEST INSTRUMENTS

DESCRIPTION & MANUFACTURER	MODEL NO.	SERIAL NO.	DATE OF CALIBRATION	DUE DATE OF CALIBRATION
Test Receiver ROHDE & SCHWARZ	ESI7	838496/016	Dec. 29, 2009	Dec. 28, 2010
Spectrum Analyzer ROHDE & SCHWARZ	FSP40	100039	Jan. 11, 2010	Jan. 10, 2011
BILOG Antenna SCHWARZBECK	VULB9168	9168-155	Apr. 28, 2010	Apr. 27, 2011
HORN Antenna SCHWARZBECK	BBHA 9120D	9120D-408	Jan. 05, 2010	Jan. 04, 2011
HORN Antenna SCHWARZBECK	BBHA 9170	BBHA9170242	Dec. 25, 2009	Dec. 24, 2010
Preamplifier Agilent	8449B	3008A01961	Nov. 02, 2010	Nov. 01, 2011
Preamplifier Agilent	8447D	2944A10738	Nov. 02, 2010	Nov. 01, 2011
RF signal cable HUBER+SUHNNER	SUCOFLEX 104	274041/4	Aug. 21, 2010	Aug. 20, 2011
RF signal cable HUBER+SUHNNER	SUCOFLEX 104	283397/4	Aug. 21, 2010	Aug. 20, 2011
Software ADT.	ADT_Radiated_ V7.6.15.9.2	NA	NA	NA
Antenna Tower inn-co GmbH	MA 4000	010303	NA	NA
Antenna Tower Controller inn-co GmbH	CO2000	019303	NA	NA
Turn Table ADT.	TT100.	TT93021704	NA	NA
Turn Table Controller ADT.	SC100.	SC93021704	NA	NA

NOTE: The calibration interval of the above test instruments is 12 months and the calibrations are traceable to NML/ROC and NIST/USA.



A D T

4.6.3 TEST PROCEDURE

- a. The EUT was placed on the top of a rotating table 0.8 meters above the ground at a 3 meter semi-anechoic chamber. The table was rotated 360 degrees to determine the position of the highest radiation.
- b. The EUT was set 3 meters away from the interference-receiving antenna, which was mounted on the top of a variable-height antenna tower.
- c. The antenna is a broadband antenna, and its height is varied from one meter to four meters above the ground to determine the maximum value of the field strength. Both horizontal and vertical polarizations of the antenna are set to make the measurement.
- d. For each suspected emission, the EUT was arranged to its worst case and then the antenna was tuned to heights from 1 meter to 4 meters and the rotatable table was turned from 0 degrees to 360 degrees to find the maximum reading.
- e. Set both RBW and VBW of spectrum analyzer to 100kHz and 300kHz with suitable frequency span including 100MHz bandwidth from band edge. The band edges was measured and recorded.

The spectrum plots (Peak RBW = 100kHz, VBW = 300kHz) are attached on the following pages.

NOTE: The resolution bandwidth of test receiver/spectrum analyzer is 1MHz and the video bandwidth is 1kHz for Average detection (AV) at frequency above 1GHz.

4.6.4 DEVIATION FROM TEST STANDARD

No deviation.

4.6.5 EUT OPERATING CONDITION

Same as Item 4.3.6.



4.6.6 TEST RESULTS

The spectrum plots are attached on the following pages. D1 line indicates the highest level, and D2 line indicates the 20dB offset below D1. It shows compliance with the requirement in part 15.247(d).

802.11b

RESTRICT BAND (2310 ~ 2390 MHz)

FREQUENCY (MHz)	FUNDAMENTAL EMISSION (dBuV/m)	DELTA (dB)	MAXIMUM FIELD STRENGTH IN RESTRICT BAND (dBuV/m)	LIMIT (dBuV/m)
2412.00 (PK)	116.1	54.64	61.46	74.00
2412.00 (AV)	112.3	59.59	52.71	54.00

RESTRICT BAND (2483.5 ~ 2500 MHz)

FREQUENCY (MHz)	FUNDAMENTAL EMISSION (dBuV/m)	DELTA (dB)	MAXIMUM FIELD STRENGTH IN RESTRICT BAND (dBuV/m)	LIMIT (dBuV/m)
2462.00 (PK)	114.9	60.34	54.56	74.00
2462.00 (AV)	111.5	69.79	41.71	54.00

NOTE:

1. Delta = Amplitude between the peak of the fundamental and the peak of the band edge emission. Please check following 3 pages.
2. Maximum field strength in restrict band = Fundamental emission – Delta.



A D T

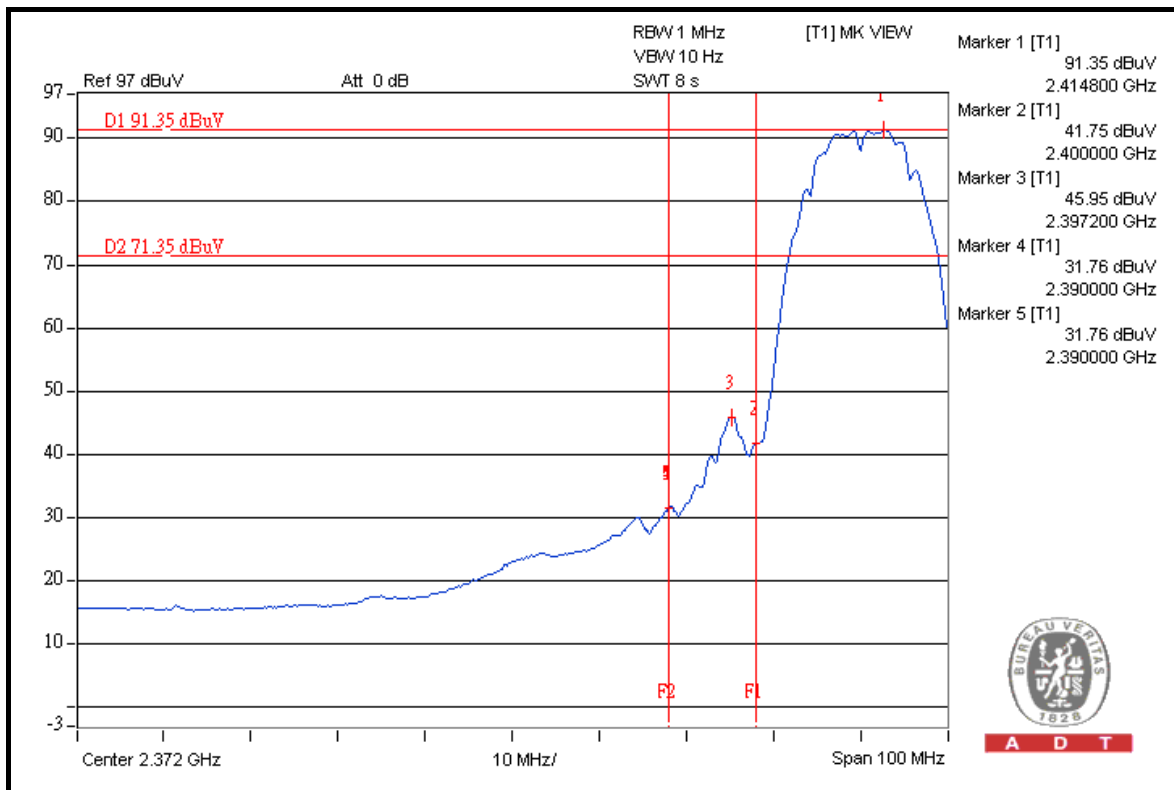
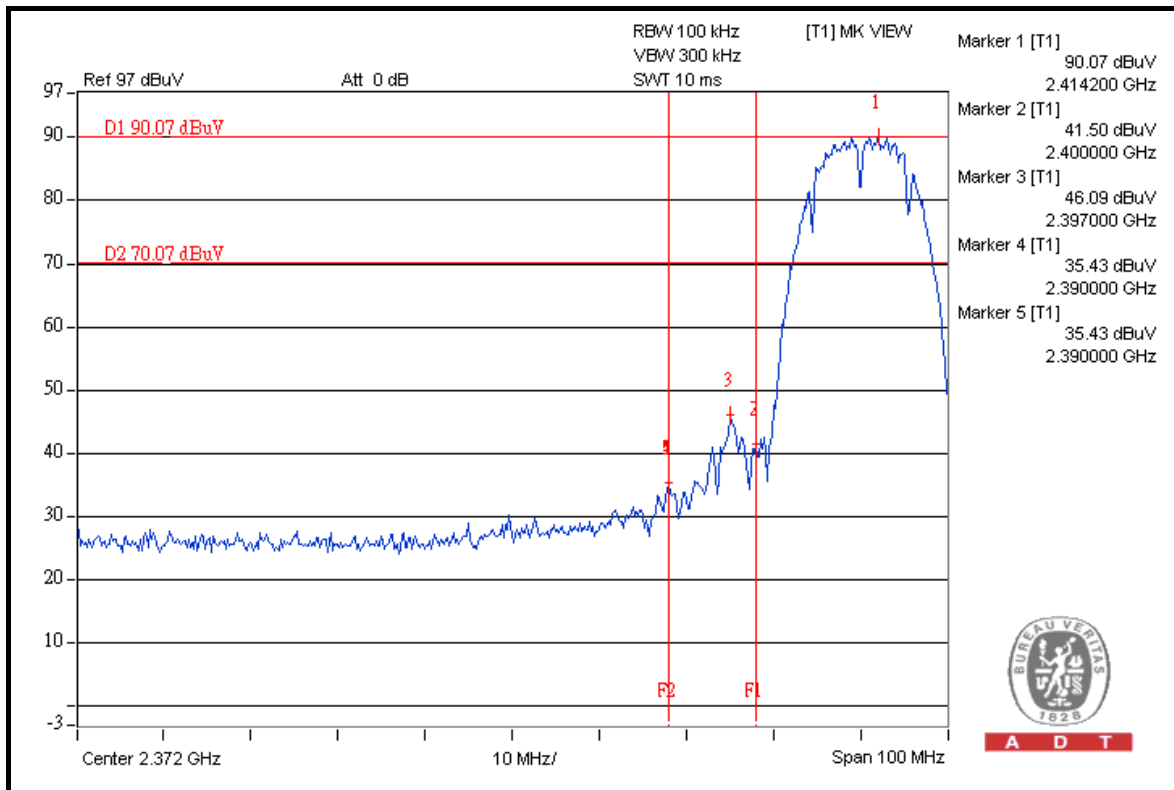



A D T

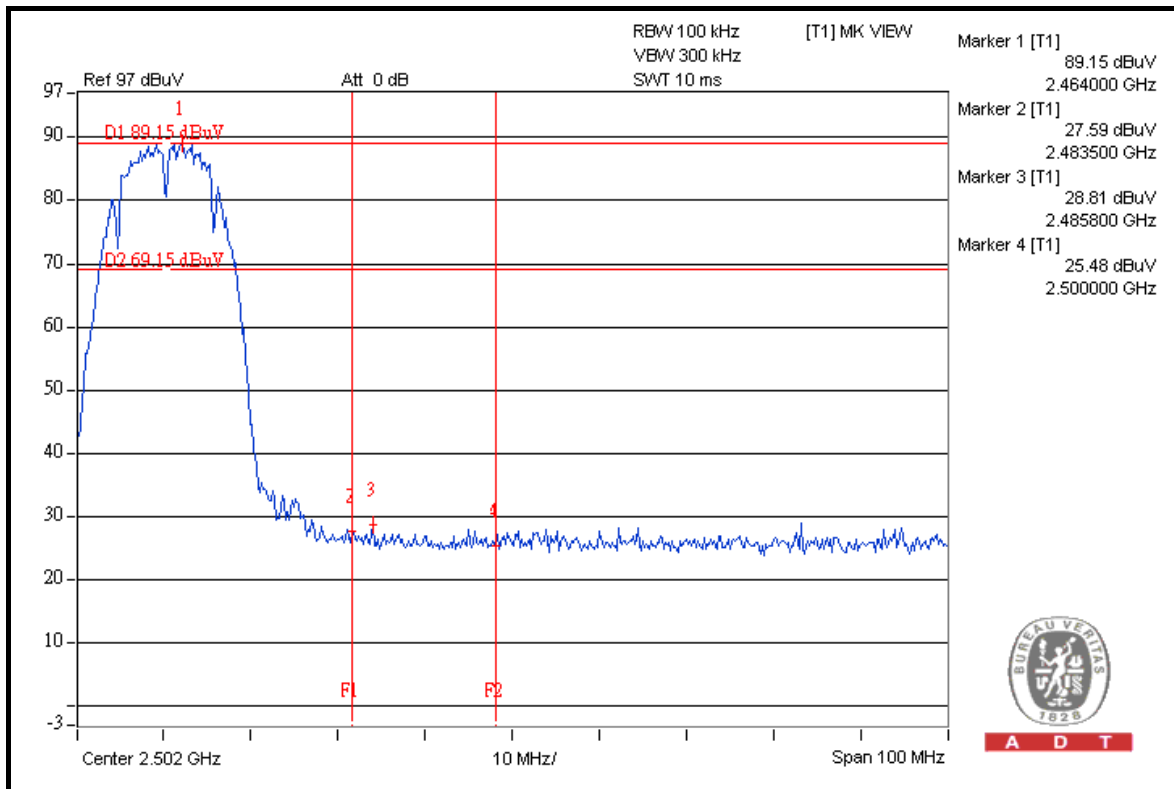
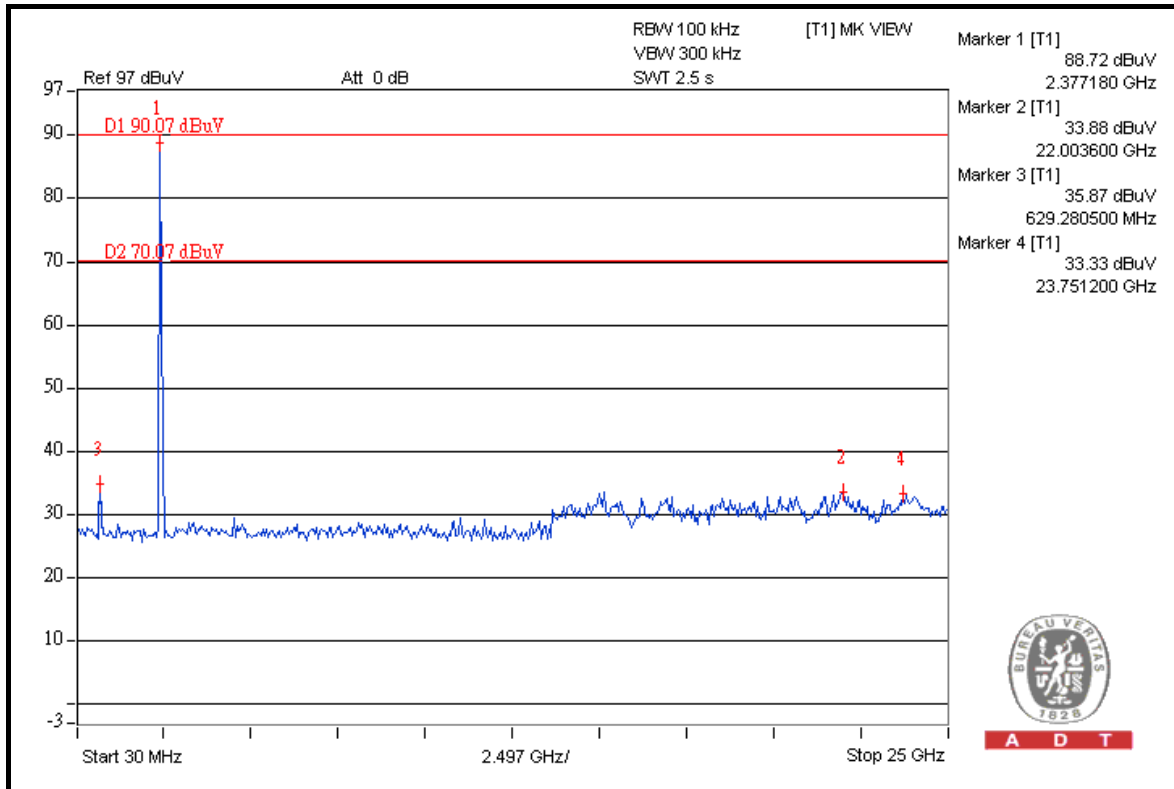



A D T

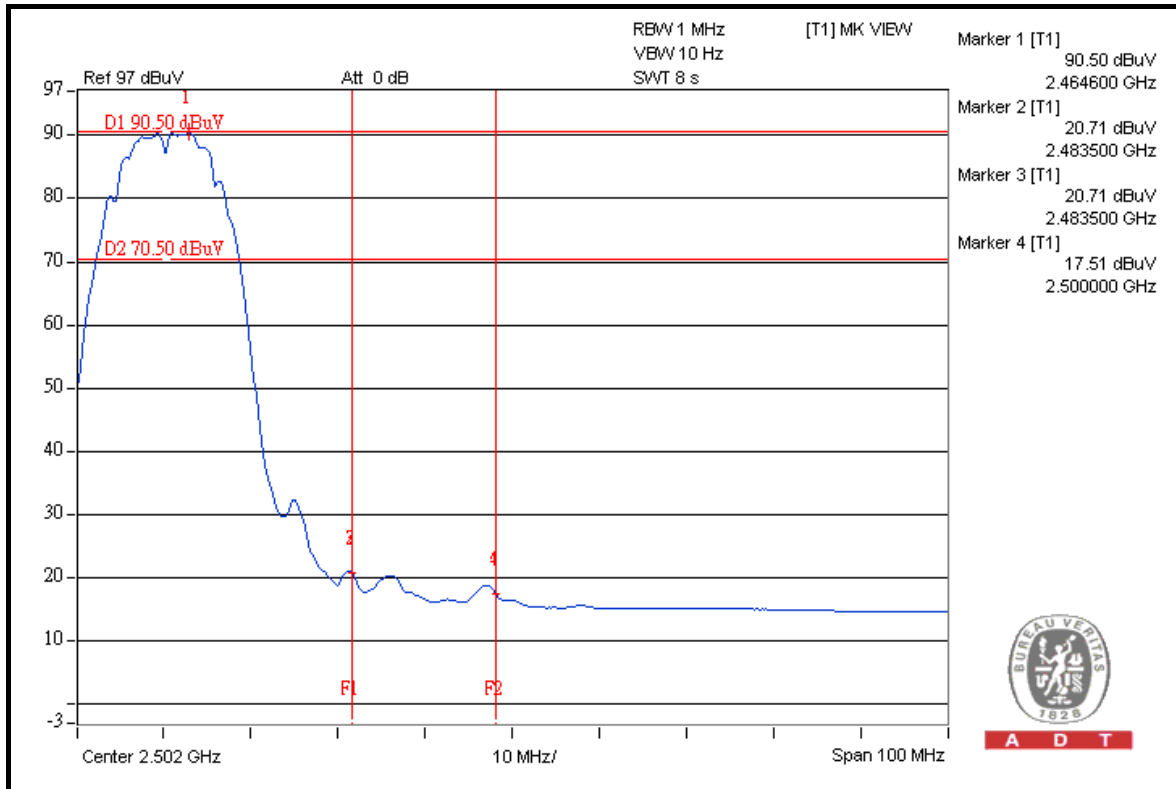

A D T

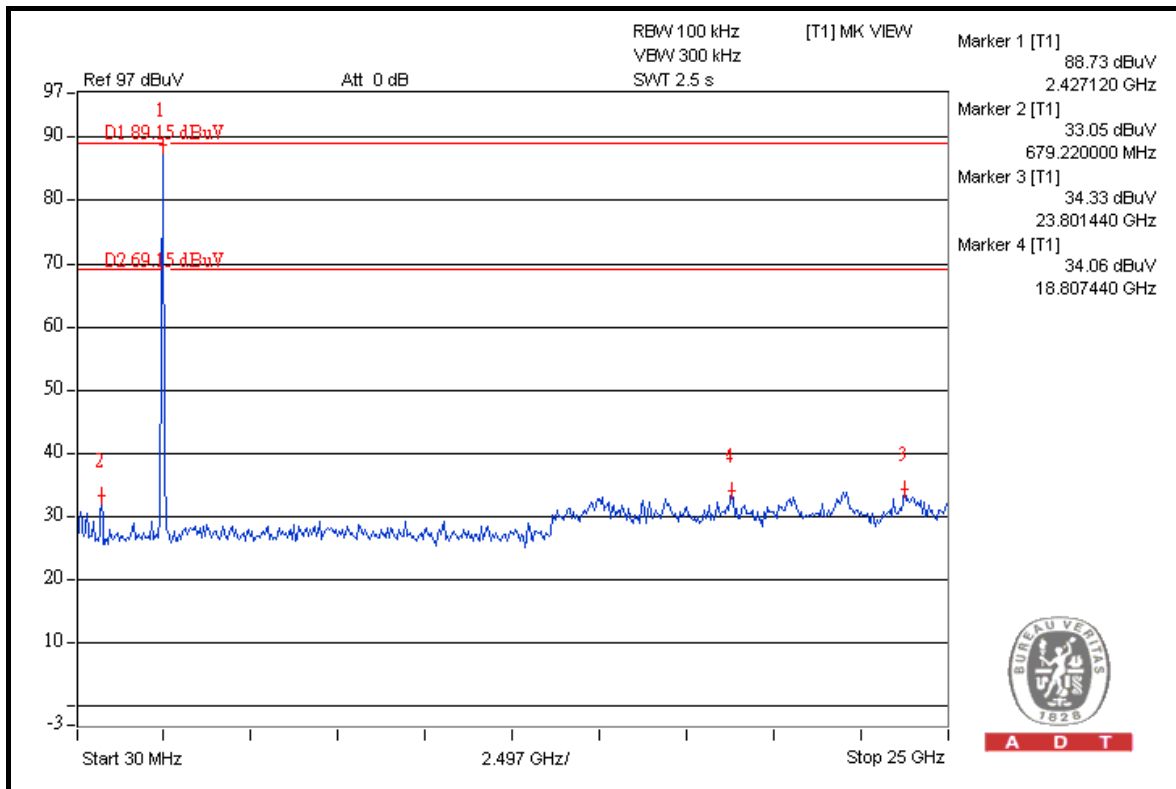

A D T



A D T

802.11g

RESTRICT BAND (2310 ~ 2390 MHz)

FREQUENCY (MHz)	FUNDAMENTAL EMISSION (dBuV/m)	DELTA (dB)	MAXIMUM FIELD STRENGTH IN RESTRICT BAND (dBuV/m)	LIMIT (dBuV/m)
2412.00 (PK)	112.8	48.00	64.80	74.00
2412.00 (AV)	103.6	53.36	50.24	54.00

RESTRICT BAND (2483.5 ~ 2500 MHz)

FREQUENCY (MHz)	FUNDAMENTAL EMISSION (dBuV/m)	DELTA (dB)	MAXIMUM FIELD STRENGTH IN RESTRICT BAND (dBuV/m)	LIMIT (dBuV/m)
2462.00 (PK)	113.7	52.19	61.51	74.00
2462.00 (AV)	104.2	60.25	43.95	54.00

NOTE:

1. Delta = Amplitude between the peak of the fundamental and the peak of the band edge emission. Please check following 3 pages.
2. Maximum field strength in restrict band = Fundamental emission – Delta.



A D T

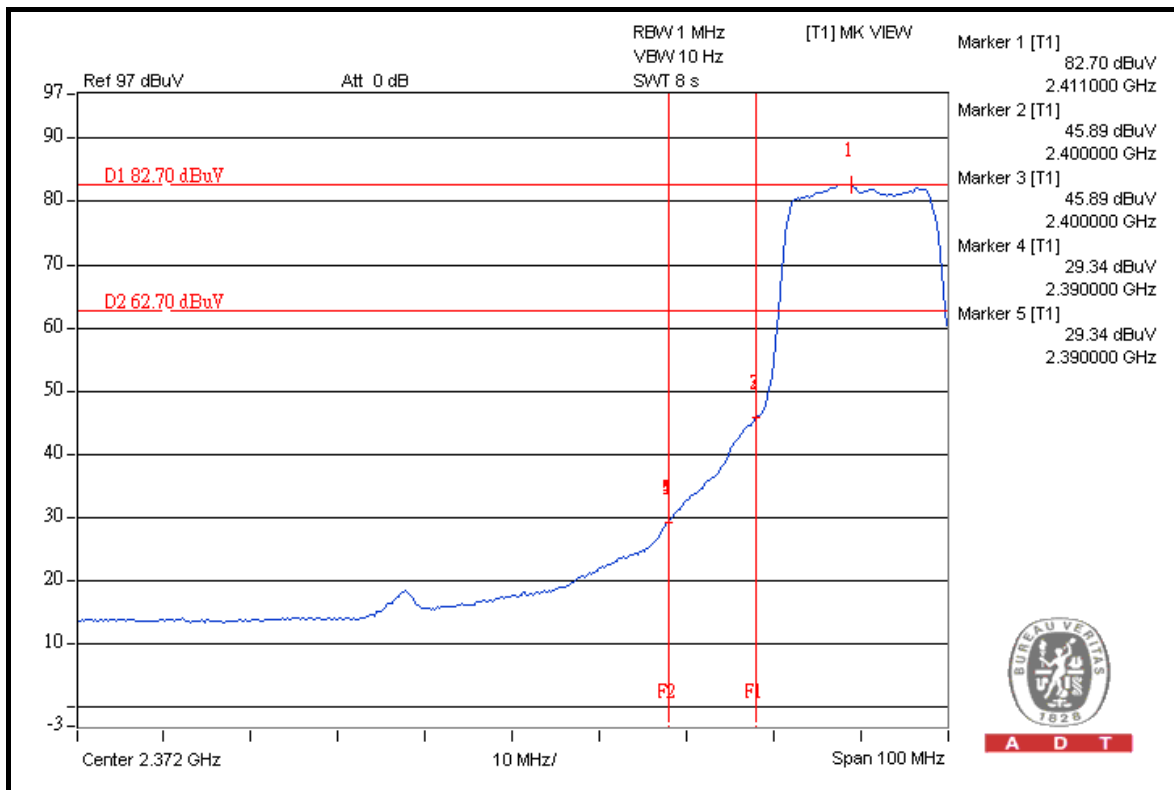
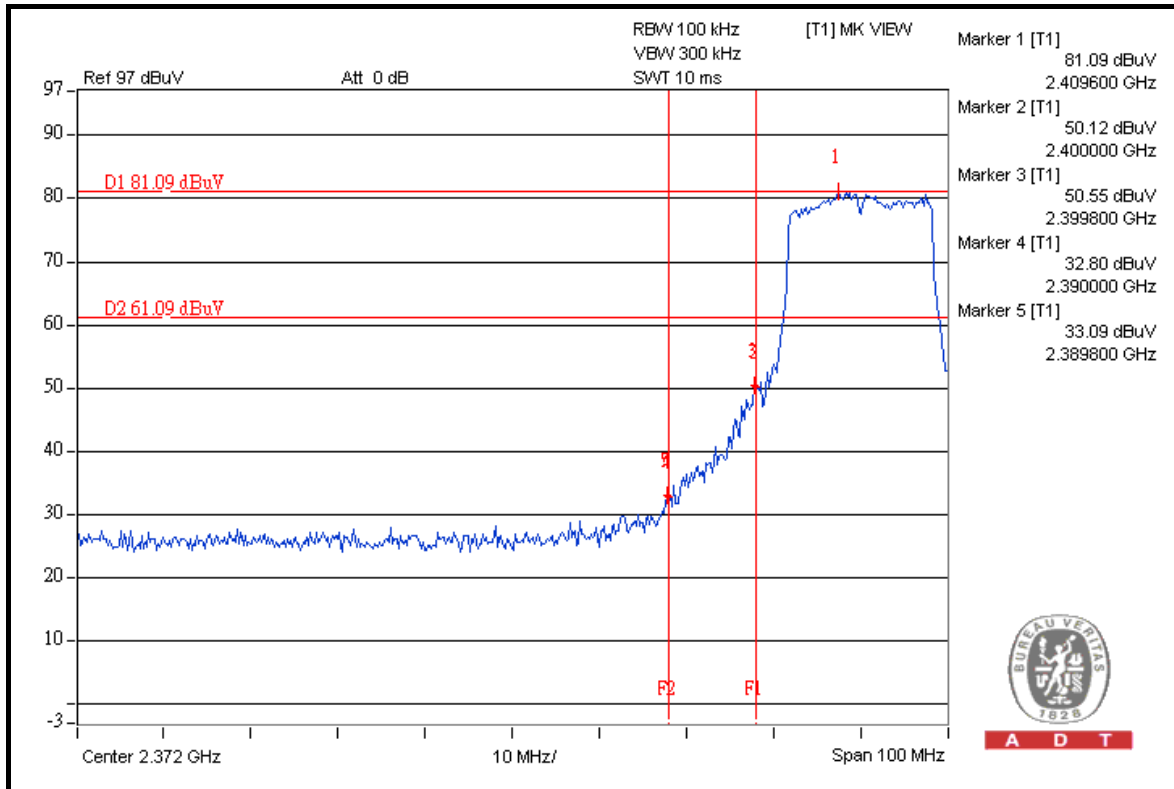



A D T

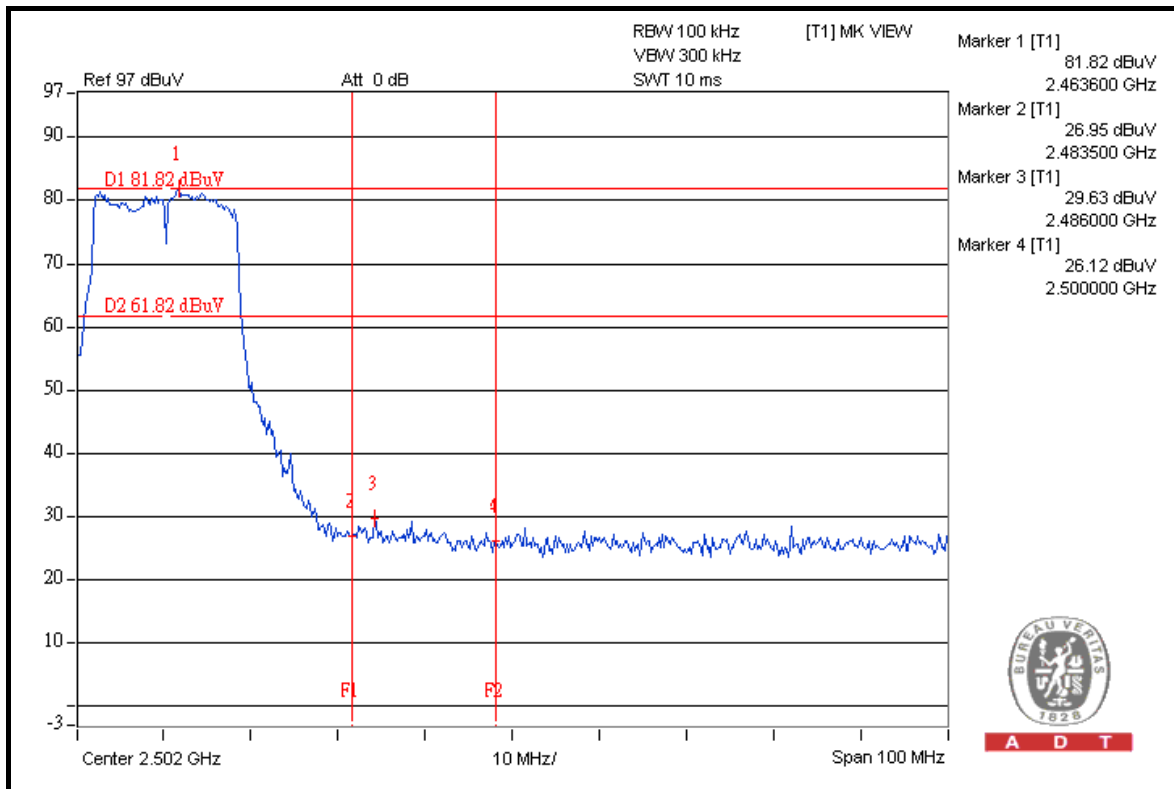
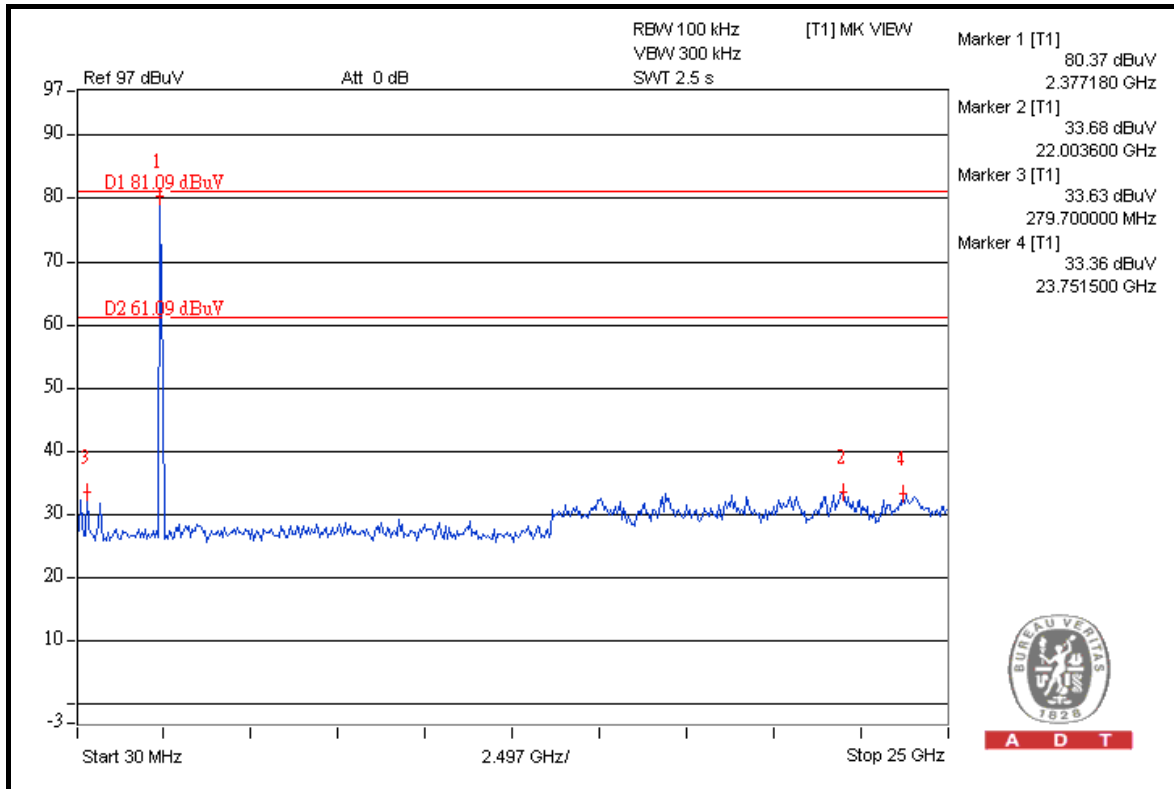



A D T

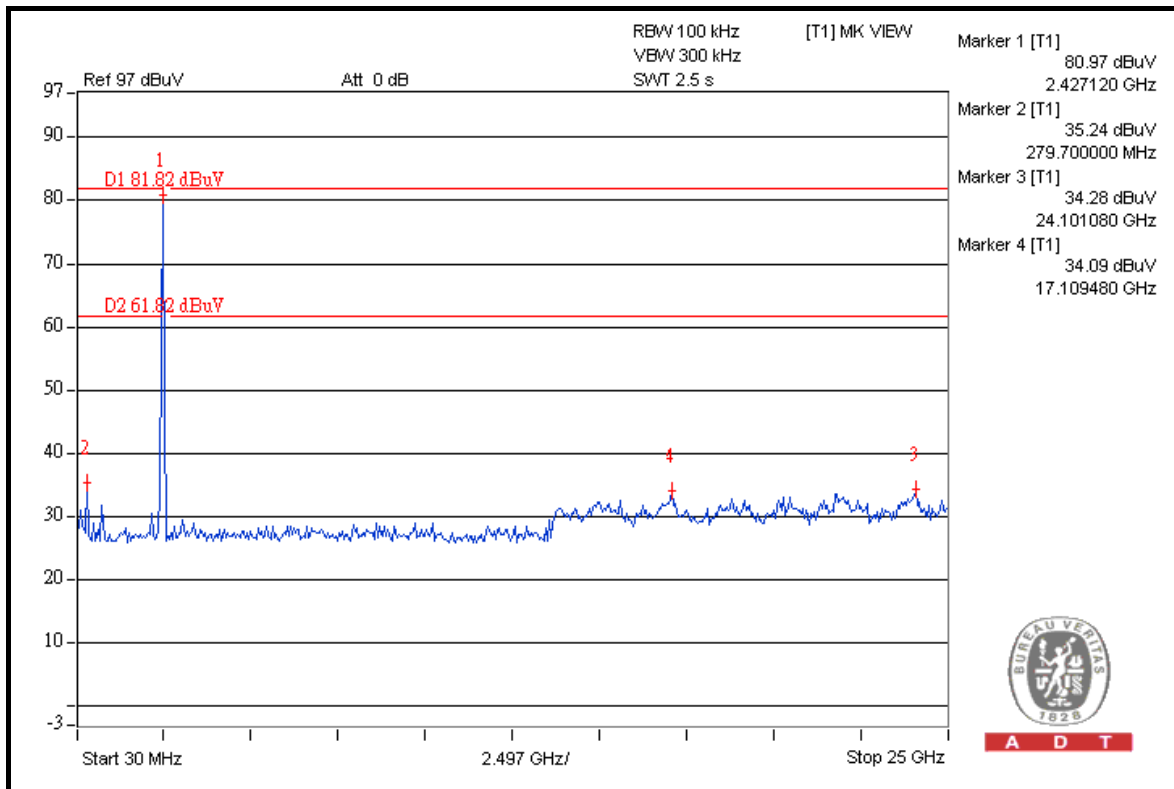
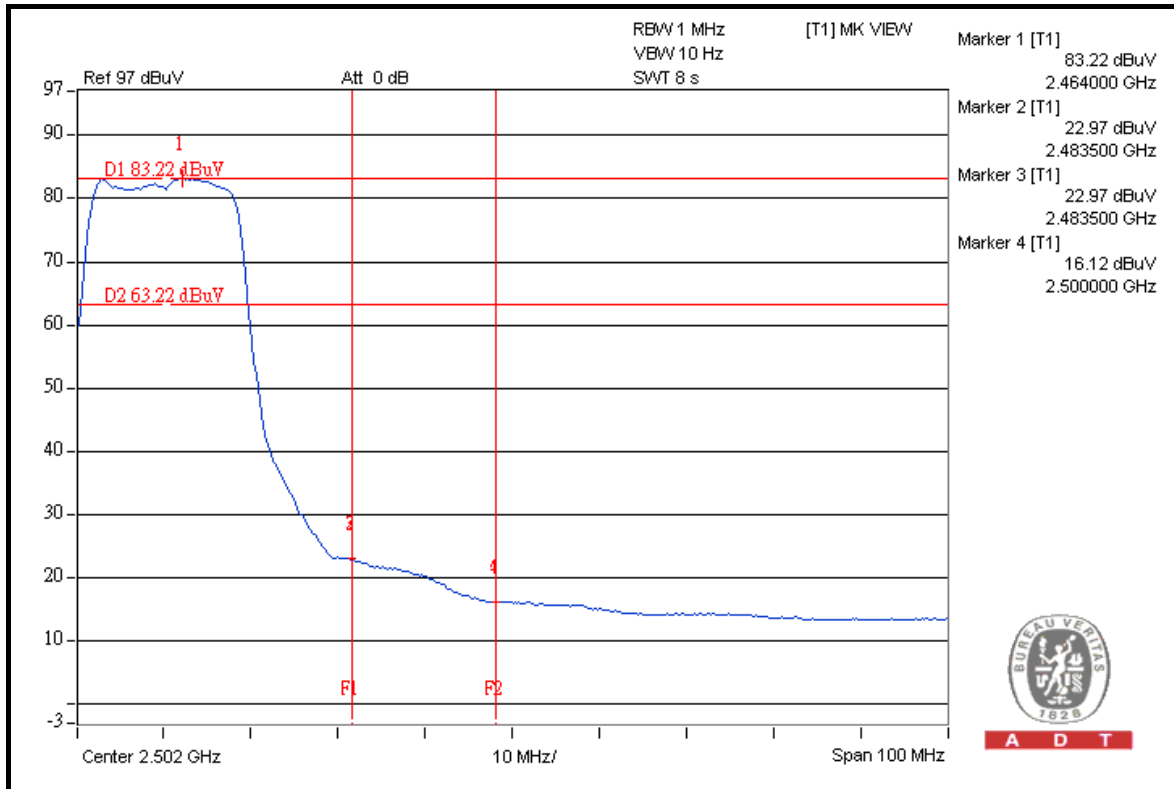



A D T

802.11n (20MHz)

RESTRICT BAND (2310 ~ 2390 MHz)

FREQUENCY (MHz)	FUNDAMENTAL EMISSION (dBuV/m)	DELTA (dB)	MAXIMUM FIELD STRENGTH IN RESTRICT BAND (dBuV/m)	LIMIT (dBuV/m)
2412.00 (PK)	112.4	46.28	66.12	74.00
2412.00 (AV)	103.1	50.25	52.85	54.00

RESTRICT BAND (2483.5 ~ 2500 MHz)

FREQUENCY (MHz)	FUNDAMENTAL EMISSION (dBuV/m)	DELTA (dB)	MAXIMUM FIELD STRENGTH IN RESTRICT BAND (dBuV/m)	LIMIT (dBuV/m)
2462.00 (PK)	113.9	50.56	63.34	74.00
2462.00 (AV)	104.7	55.64	49.06	54.00

NOTE:

1. Delta = Amplitude between the peak of the fundamental and the peak of the band edge emission. Please check following 3 pages.
2. Maximum field strength in restrict band = Fundamental emission – Delta.



A D T

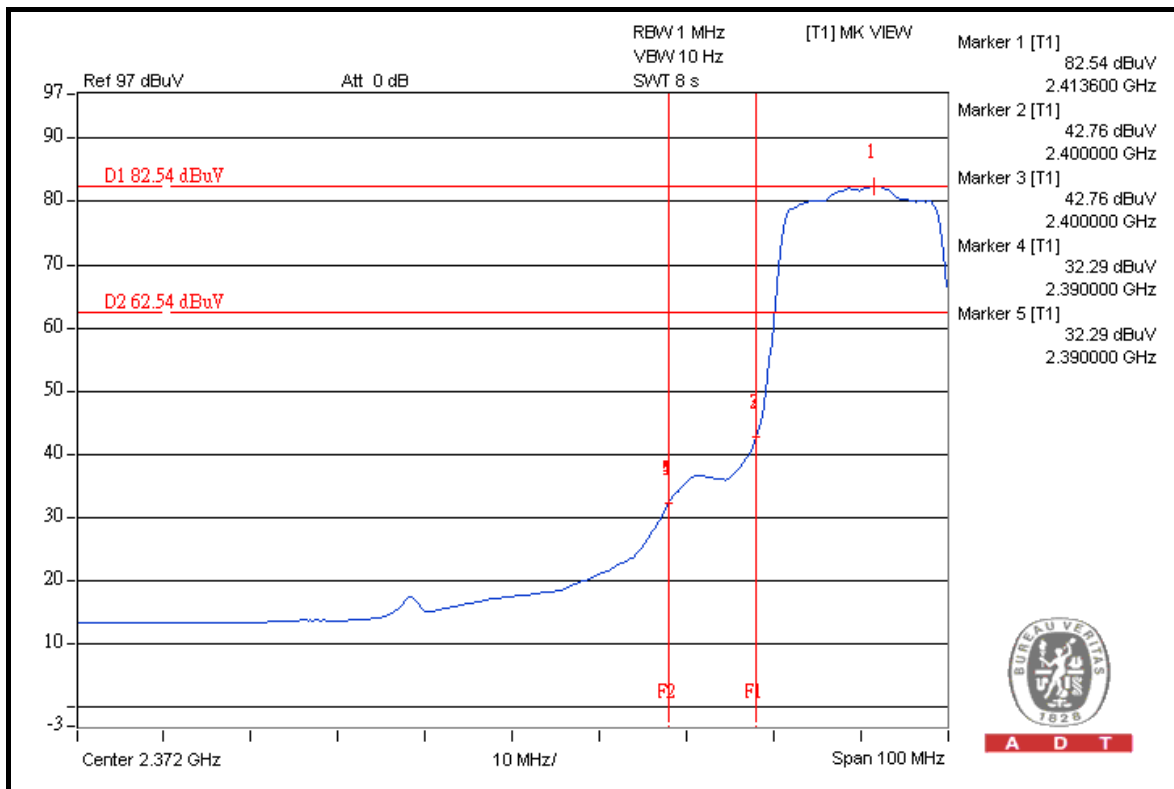
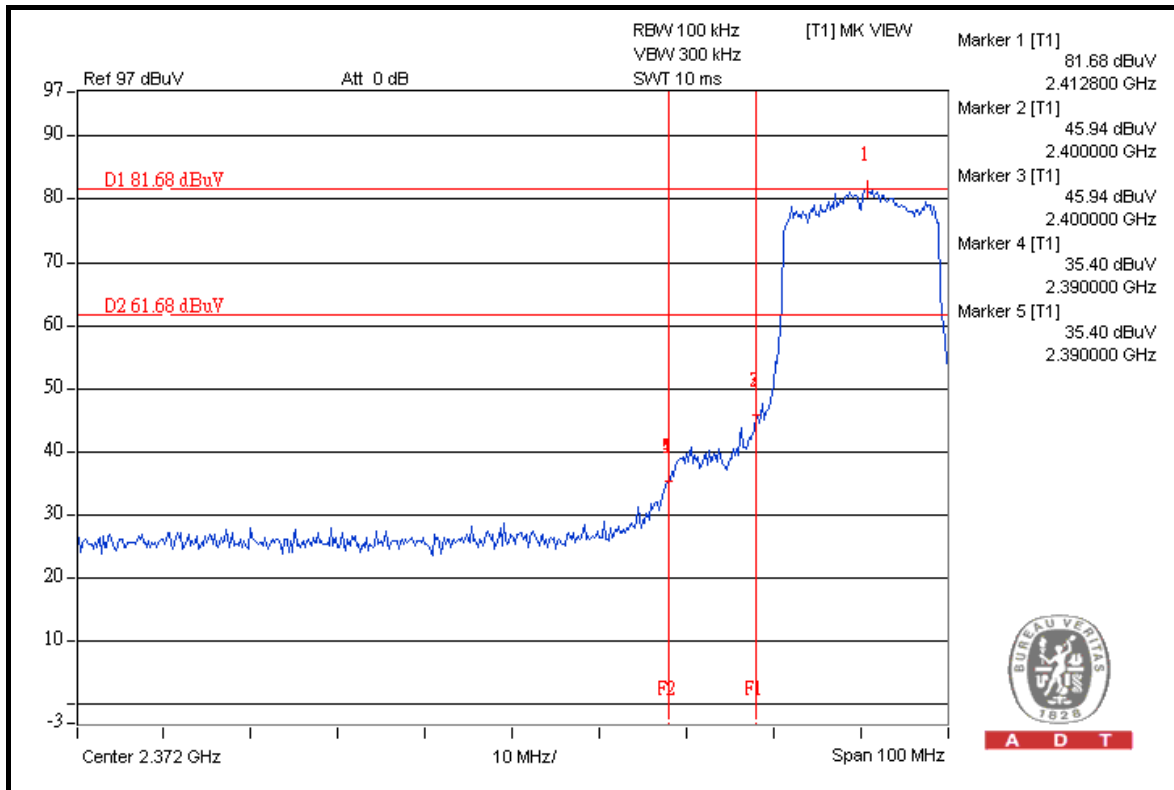



A D T

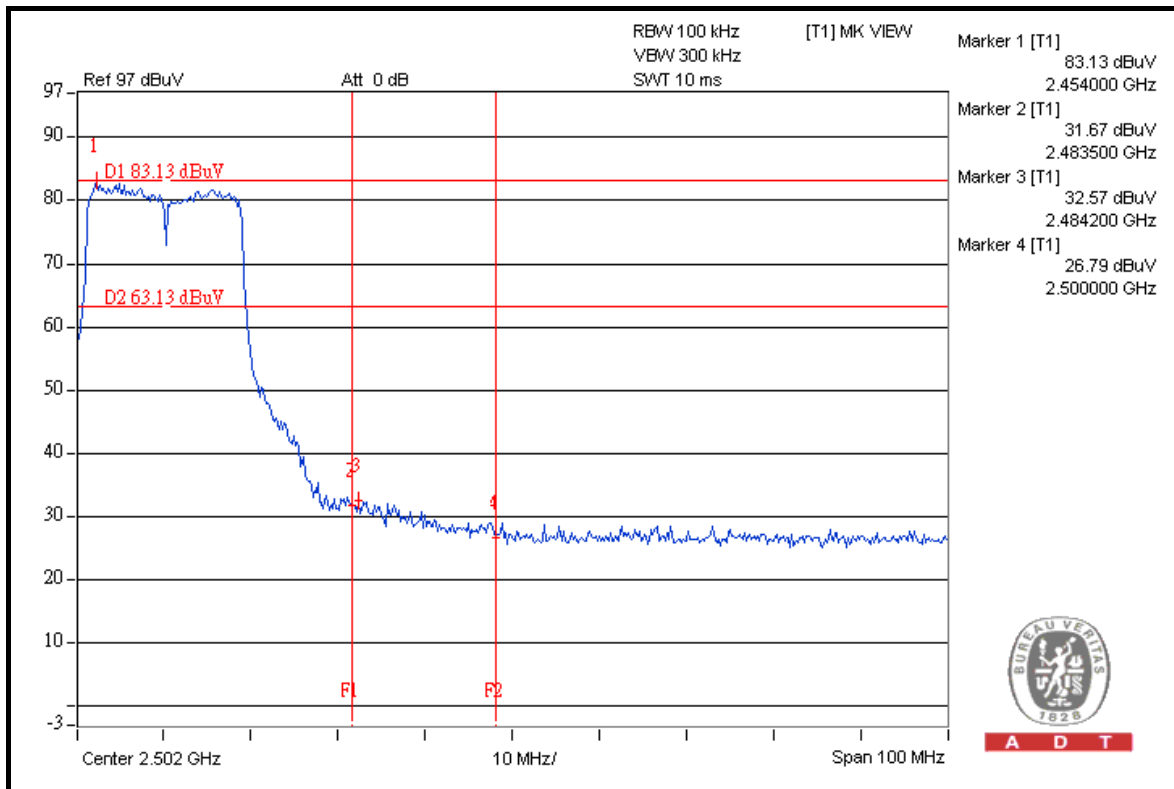
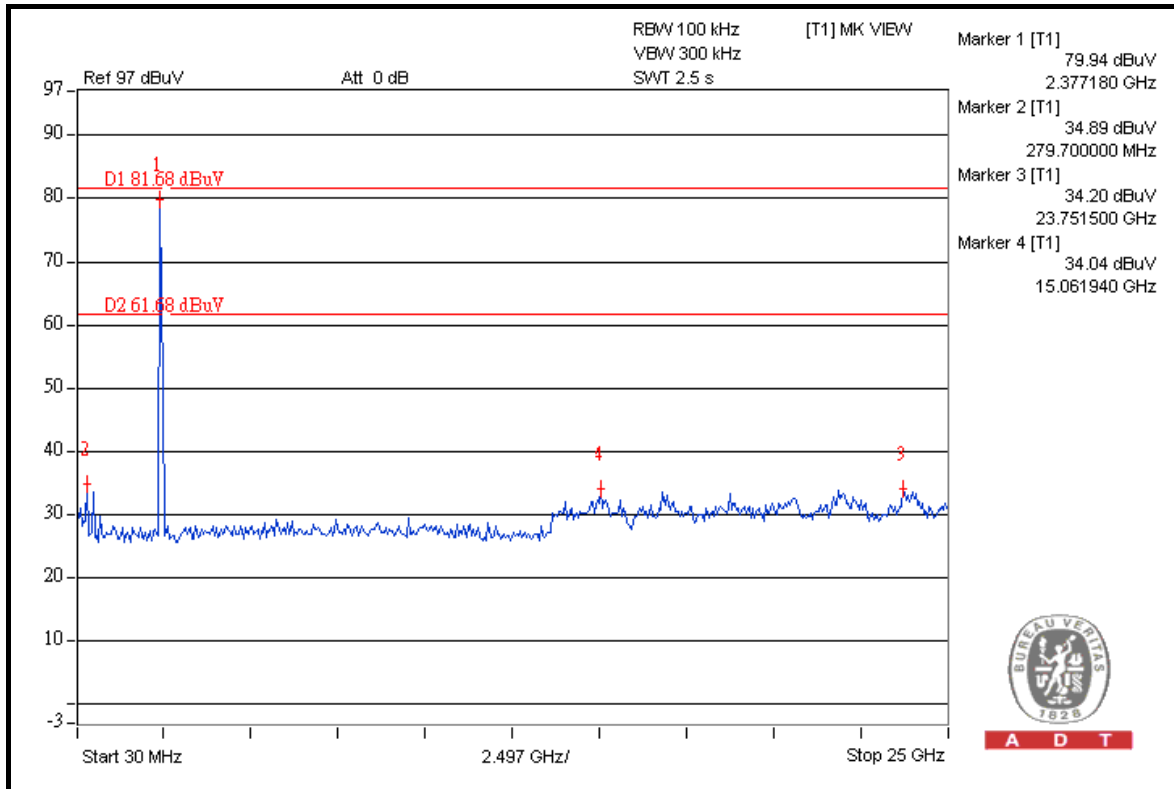



A D T

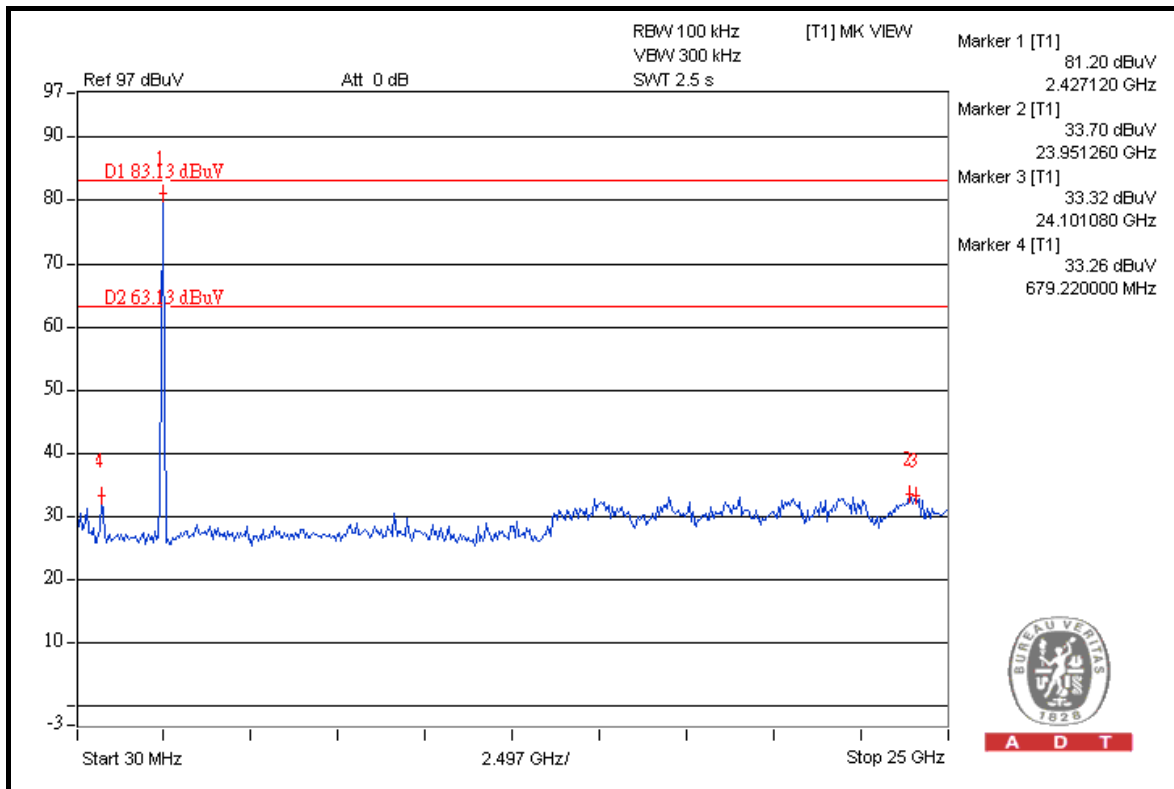
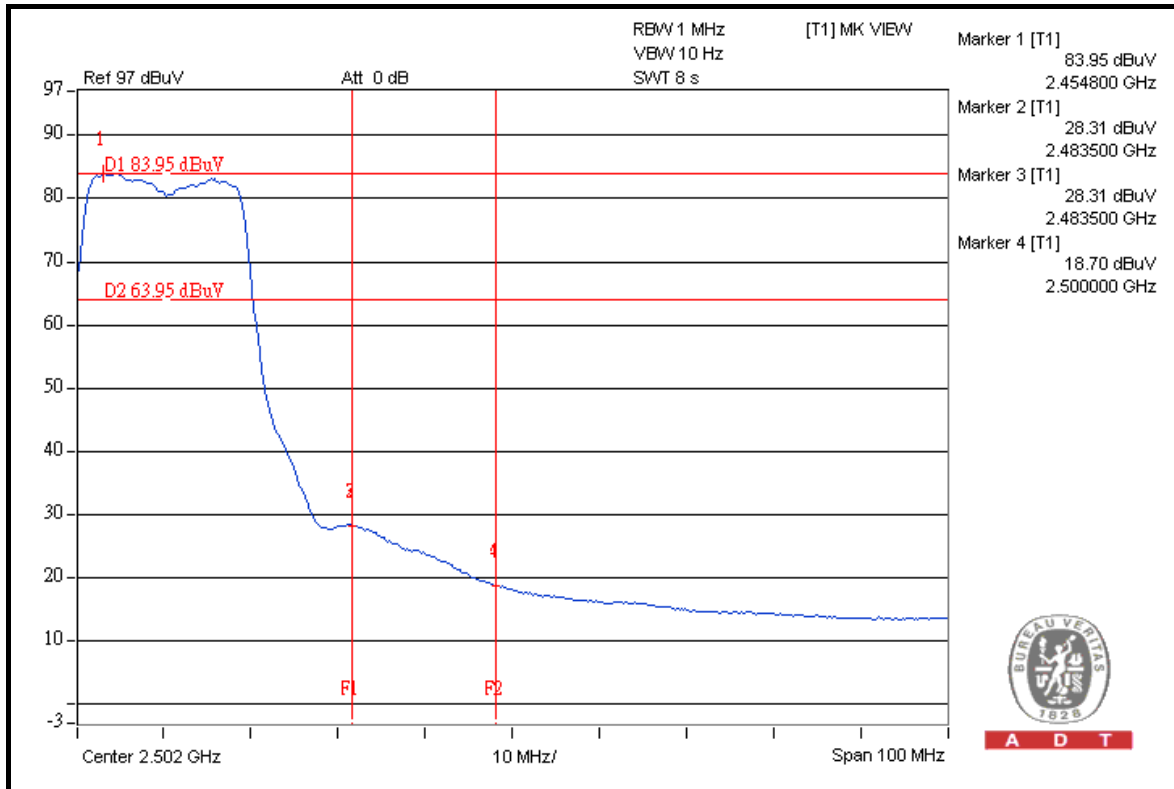



A D T

802.11n (40MHz)

RESTRICT BAND (2310 ~ 2390 MHz)

FREQUENCY (MHz)	FUNDAMENTAL EMISSION (dBuV/m)	DELTA (dB)	MAXIMUM FIELD STRENGTH IN RESTRICT BAND (dBuV/m)	LIMIT (dBuV/m)
2422.00 (PK)	106.8	44.00	62.80	74.00
2422.00 (AV)	97.8	47.31	50.49	54.00

RESTRICT BAND (2483.5 ~ 2500 MHz)

FREQUENCY (MHz)	FUNDAMENTAL EMISSION (dBuV/m)	DELTA (dB)	MAXIMUM FIELD STRENGTH IN RESTRICT BAND (dBuV/m)	LIMIT (dBuV/m)
2452.00 (PK)	111.6	45.14	66.46	74.00
2452.00 (AV)	102.2	51.52	50.68	54.00

NOTE:

1. Delta = Amplitude between the peak of the fundamental and the peak of the band edge emission. Please check following 3 pages.
2. Maximum field strength in restrict band = Fundamental emission – Delta.



A D T

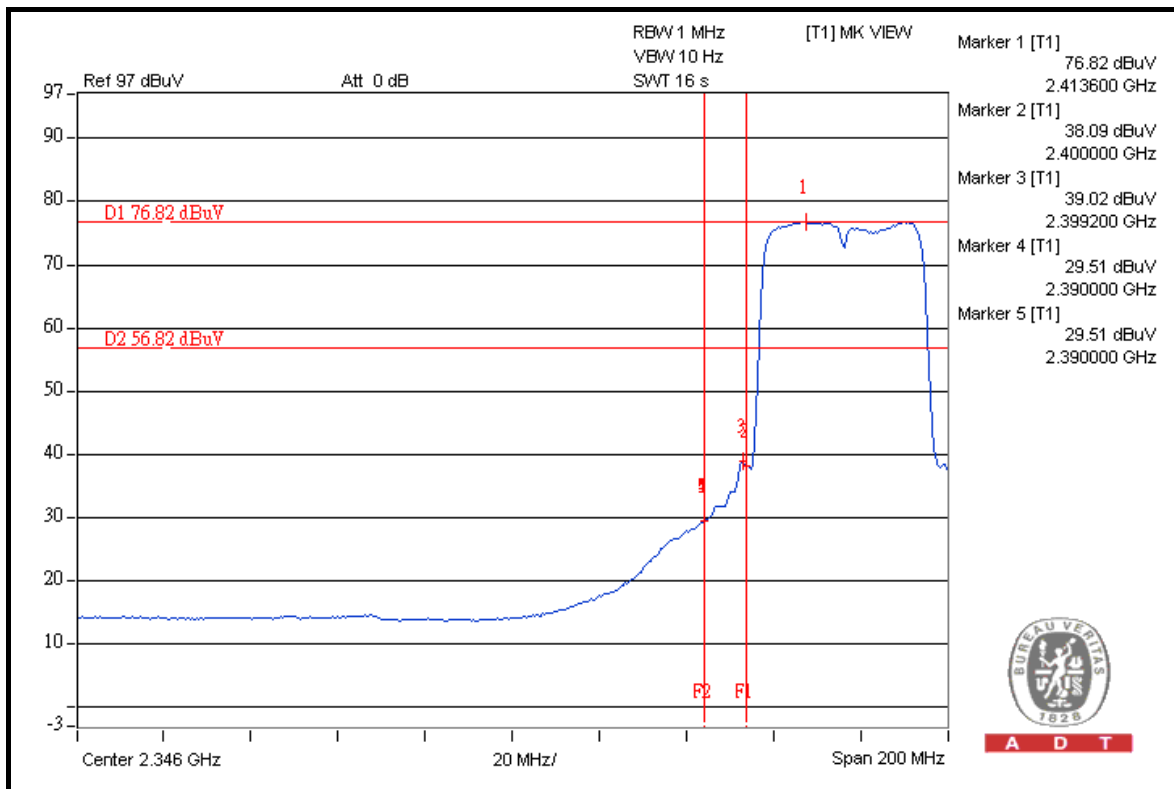
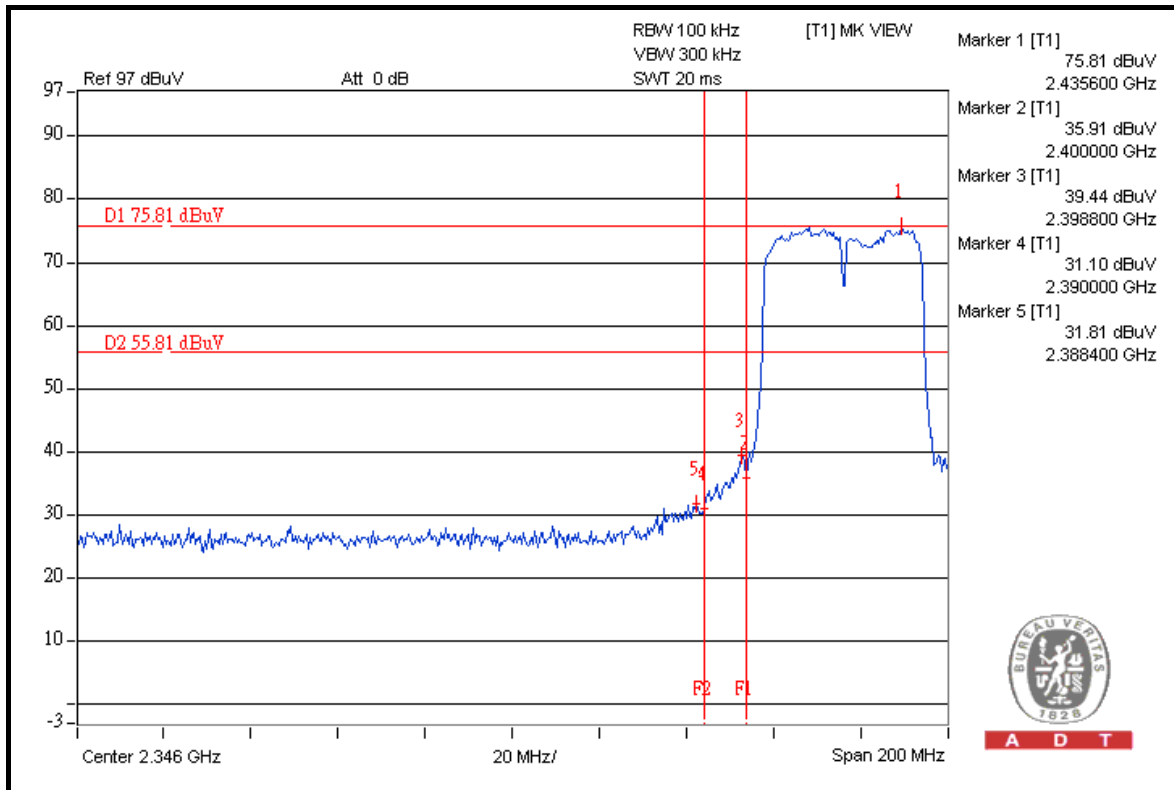



A D T

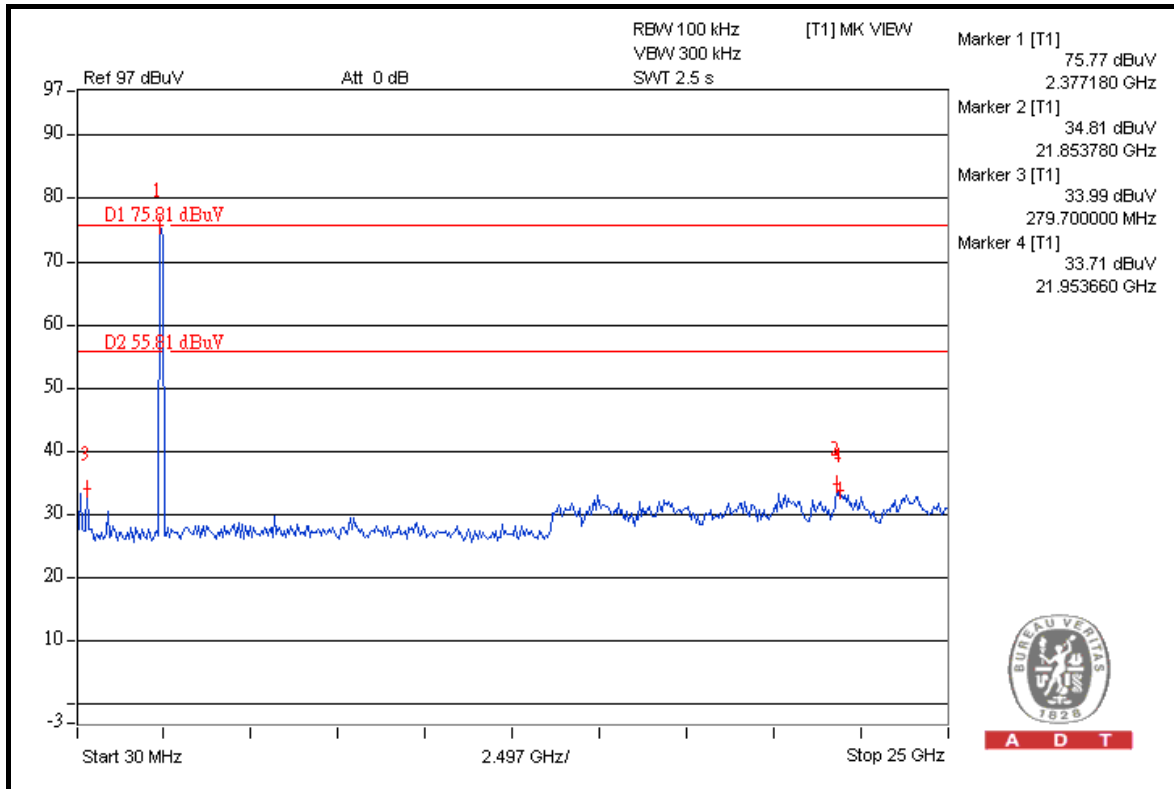

A D T

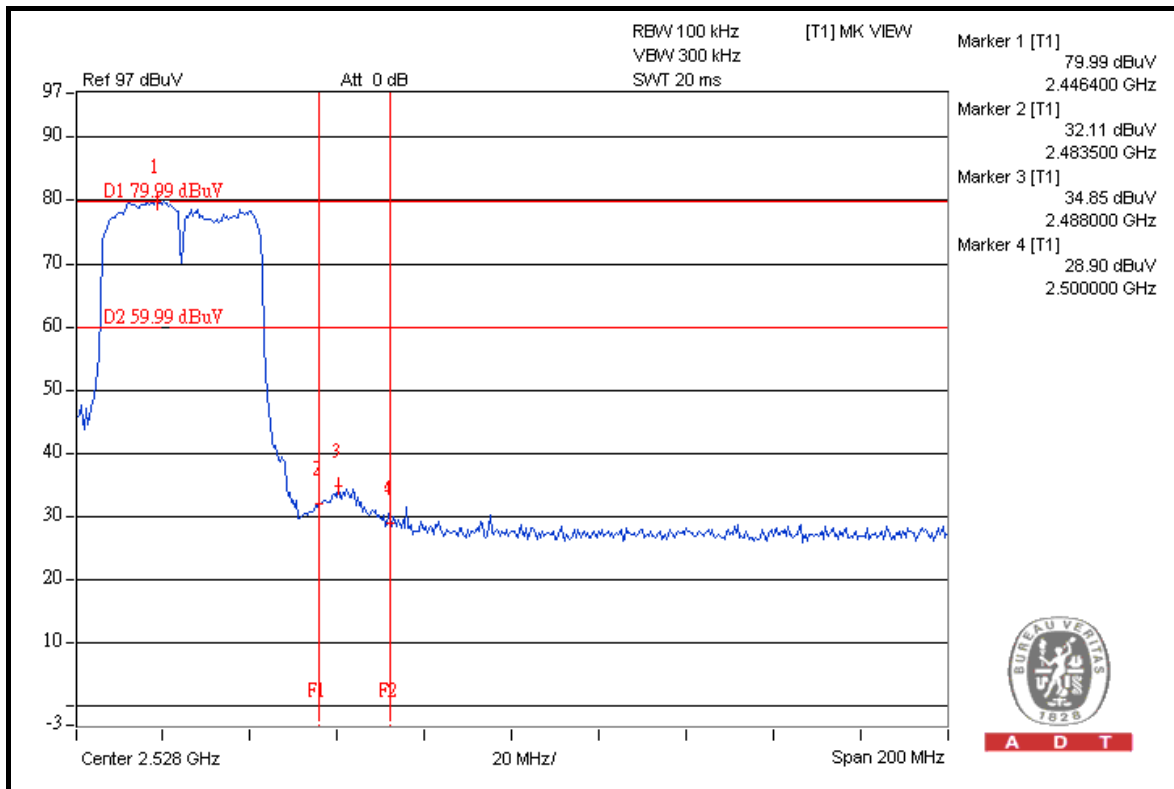

A D T



A D T

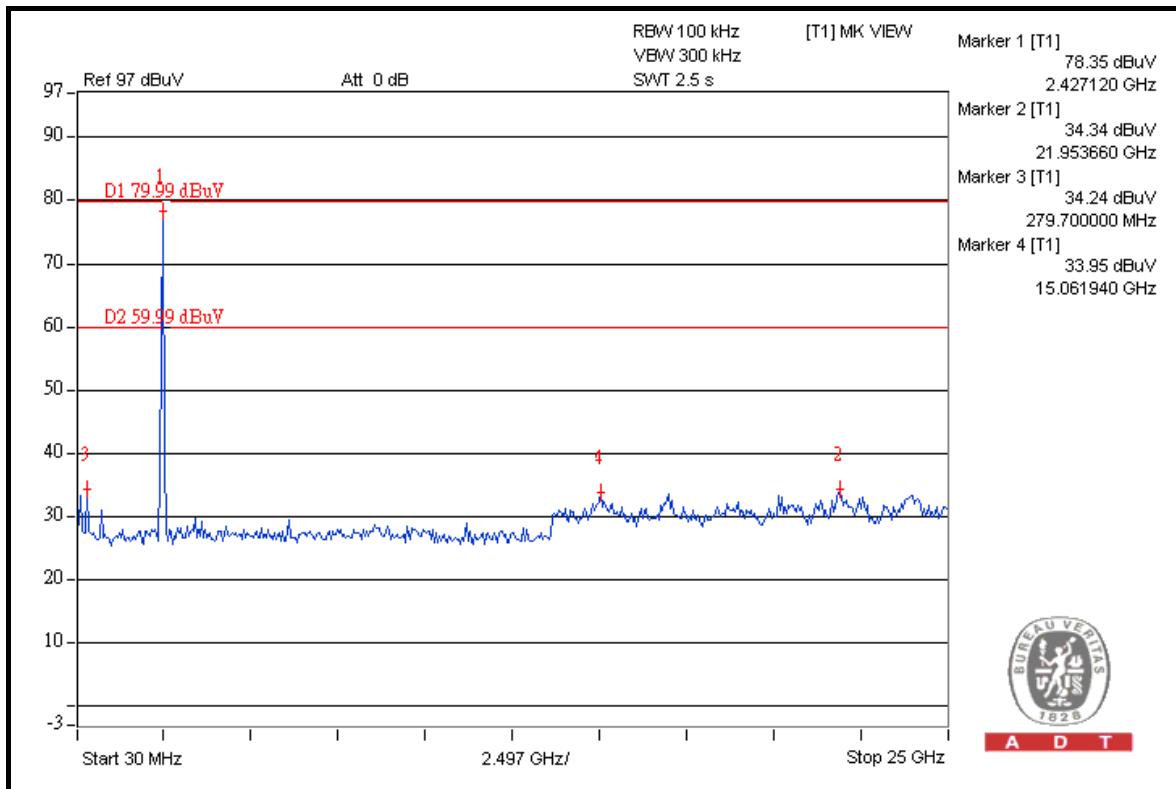
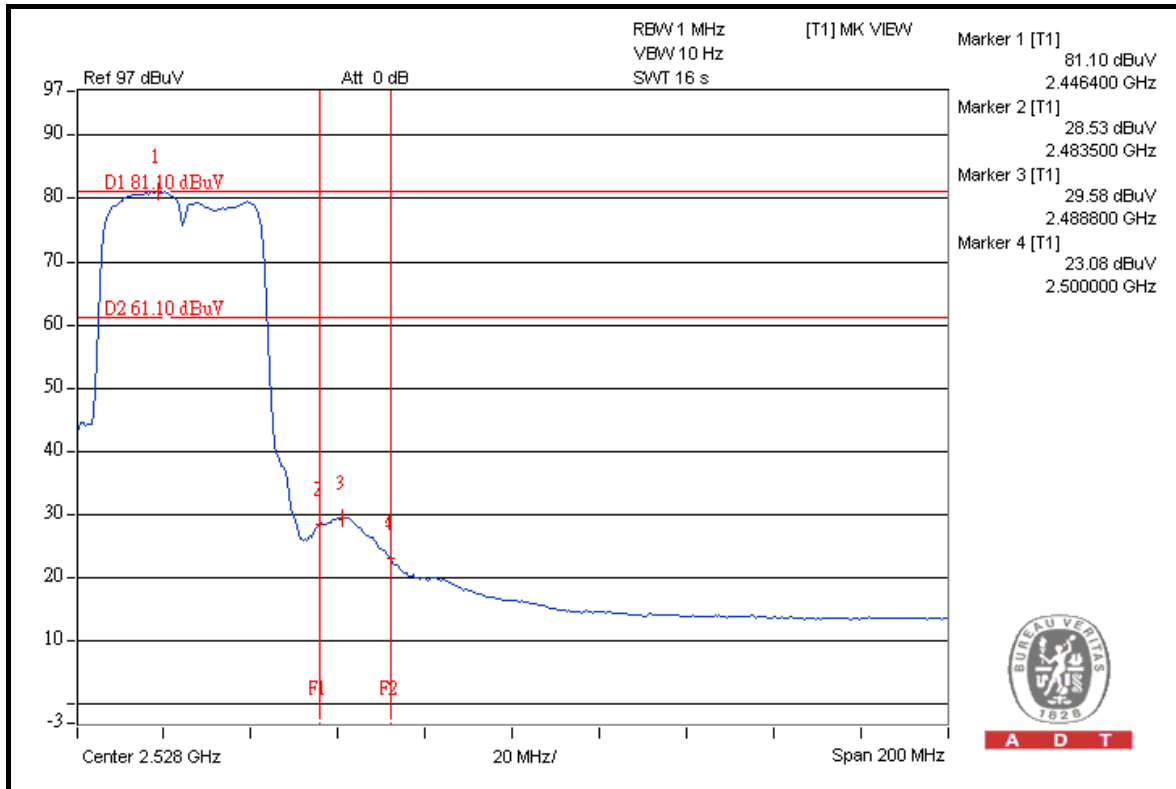



5. TEST TYPES AND RESULTS (FOR 5.0GHz BAND)

5.1 RADIATED EMISSION MEASUREMENT

5.1.1 LIMITS OF RADIATED EMISSION MEASUREMENT

Emissions radiated outside of the specified bands, shall be according to the general radiated limits in 15.209 as following:

FREQUENCIES (MHz)	FIELD STRENGTH (microvolts/meter)	MEASUREMENT DISTANCE (meters)
0.009 ~ 0.490	2400/F(kHz)	300
0.490 ~ 1.705	24000/F(kHz)	30
1.705 ~ 30.0	30	30
30 ~ 88	100	3
88 ~ 216	150	3
216 ~ 960	200	3
Above 960	500	3

NOTE:

1. The lower limit shall apply at the transition frequencies.
2. Emission level (dBuV/m) = 20 log Emission level (uV/m).
3. As shown in 15.35(b), for frequencies above 1000MHz, the field strength limits are based on average detector, however, the peak field strength of any emission shall not exceed the maximum permitted average limits, specified above by more than 20dB under any condition of modulation.



A D T

5.1.2 TEST INSTRUMENTS

DESCRIPTION & MANUFACTURER	MODEL NO.	SERIAL NO.	DATE OF CALIBRATION	DUE DATE OF CALIBRATION
Test Receiver ROHDE & SCHWARZ	ES17	838496/016	Dec. 29, 2009	Dec. 28, 2010
Spectrum Analyzer ROHDE & SCHWARZ	FSP40	100039	Jan. 11, 2010	Jan. 10, 2011
BILOG Antenna SCHWARZBECK	VULB9168	9168-155	Apr. 28, 2010	Apr. 27, 2011
HORN Antenna SCHWARZBECK	BBHA 9120D	9120D-408	Jan. 05, 2010	Jan. 04, 2011
HORN Antenna SCHWARZBECK	BBHA 9170	BBHA9170242	Dec. 25, 2009	Dec. 24, 2010
Preamplifier Agilent	8449B	3008A01961	Nov. 02, 2010	Nov. 01, 2011
Preamplifier Agilent	8447D	2944A10738	Nov. 02, 2010	Nov. 01, 2011
RF signal cable HUBER+SUHNNER	SUCOFLEX 104	274041/4	Aug. 21, 2010	Aug. 20, 2011
RF signal cable HUBER+SUHNNER	SUCOFLEX 104	283397/4	Aug. 21, 2010	Aug. 20, 2011
Software ADT.	ADT_Radiated_ V7.6.15.9.2	NA	NA	NA
Antenna Tower inn-co GmbH	MA 4000	010303	NA	NA
Antenna Tower Controller inn-co GmbH	CO2000	019303	NA	NA
Turn Table ADT.	TT100.	TT93021704	NA	NA
Turn Table Controller ADT.	SC100.	SC93021704	NA	NA
26GHz ~ 40GHz Amplifier	EM26400	07026401	Aug. 25, 2010	Aug. 24, 2011

- NOTE:**
1. The calibration interval of the above test instruments is 12 months and the calibrations are traceable to NML/ROC and NIST/USA.
 2. The test was performed in HwaYa Chamber 4.
 3. The horn antenna and HP preamplifier (model: 8449B) are used only for the measurement of emission frequency above 1GHz if tested.
 4. The FCC Site Registration No. is 988962.
 5. The IC Site Registration No. is IC7450F-4.



5.1.3 TEST PROCEDURES

- a. The EUT was placed on the top of a rotating table 0.8 meters above the ground at a 3 meters semi-anechoic chamber. The table was rotated 360 degrees to determine the position of the highest radiation.
- b. The EUT was set 3 meters away from the interference-receiving antenna, which was mounted on the top of a variable-height antenna tower.
- c. The antenna is a broadband antenna, and its height is varied from one meter to four meters above the ground to determine the maximum value of the field strength. Both horizontal and vertical polarizations of the antenna are set to make the measurement.
- d. For each suspected emission, the EUT was arranged to its worst case and then the antenna was tuned to heights from 1 meter to 4 meters and the rotatable table was turned from 0 degrees to 360 degrees to find the maximum reading.
- e. The test-receiver system was set to Peak Detect Function and Specified Bandwidth with Maximum Hold Mode.
- f. If the emission level of the EUT in peak mode was lower than the limit specified, then testing could be stopped and the peak values of the EUT would be reported. Otherwise the emissions would be re-tested one by one using peak, quasi-peak or average method as specified and then reported in a data sheet.

NOTE:

1. The resolution bandwidth and video bandwidth of test receiver/spectrum analyzer is 120kHz for Quasi-peak detection at frequency below 1GHz.
2. The resolution bandwidth of test receiver/spectrum analyzer is 100kHz and video bandwidth is 300kHz for Peak detection at frequency above 1GHz.
3. The resolution bandwidth of test receiver/spectrum analyzer is 1MHz and the video bandwidth is 1kHz for Average detection (AV) at frequency above 1GHz.
4. All modes of operation were investigated and the worst-case emissions are reported.

5.1.4 DEVIATION FROM TEST STANDARD

No deviation.

5.1.5 TEST SETUP

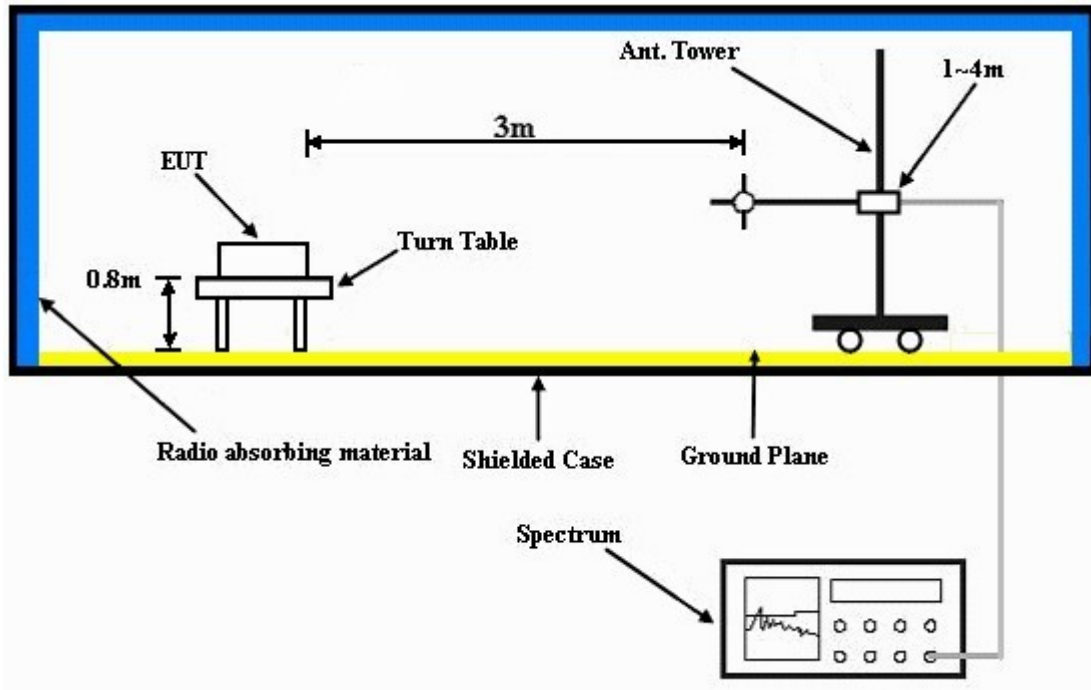

For the actual test configuration, please refer to the attached file (Test Setup Photo).

5.1.6 EUT OPERATING CONDITIONS

Same as 4.1.6.



A D T

5.1.7 TEST RESULTS

802.11a

EUT TEST CONDITION		MEASUREMENT DETAIL	
CHANNEL	Channel 149	FREQUENCY RANGE	1 ~ 40GHz
INPUT POWER	120Vac, 60 Hz	DETECTOR FUNCTION	Peak (PK) Average (AV)
ENVIRONMENTAL CONDITIONS	25deg. C, 68%RH 1006 hPa	TESTED BY	Match Tsui

ANTENNA POLARITY & TEST DISTANCE: HORIZONTAL AT 3 M								
NO.	FREQ. (MHz)	EMISSION LEVEL (dBuV/m)	LIMIT (dBuV/m)	MARGIN (dB)	ANTENNA HEIGHT (m)	TABLE ANGLE (Degree)	RAW VALUE (dBuV)	CORRECTION FACTOR (dB/m)
1	#5725.00	74.9 PK	84.1	-9.2	1.21 H	52	36.90	38.00
2	#5725.00	61.5 AV	75.1	-13.6	1.21 H	52	23.50	38.00
3	*5745.00	104.1 PK			1.42 H	69	66.10	38.00
4	*5745.00	95.1 AV			1.42 H	69	57.10	38.00
5	11490.00	64.2 PK	74.0	-9.8	1.10 H	46	16.20	48.00
6	11490.00	50.7 AV	54.0	-3.3	1.10 H	46	2.70	48.00
ANTENNA POLARITY & TEST DISTANCE: VERTICAL AT 3 M								
NO.	FREQ. (MHz)	EMISSION LEVEL (dBuV/m)	LIMIT (dBuV/m)	MARGIN (dB)	ANTENNA HEIGHT (m)	TABLE ANGLE (Degree)	RAW VALUE (dBuV)	CORRECTION FACTOR (dB/m)
1	#5725.00	85.9 PK	99.5	-13.6	1.10 V	168	47.90	38.00
2	#5725.00	71.9 AV	90.0	-18.1	1.10 V	168	33.90	38.00
3	*5745.00	119.5 PK			1.11 V	171	81.50	38.00
4	*5745.00	110.0 AV			1.11 V	171	72.00	38.00
5	11490.00	61.3 PK	74.0	-12.7	1.00 V	35	13.30	48.00
6	11490.00	47.8 AV	54.0	-6.2	1.00 V	35	-0.20	48.00

- REMARKS:**
1. Emission level (dBuV/m) = Raw Value (dBuV) + Correction Factor (dB/m).
 2. Correction Factor (dB/m) = Antenna Factor (dB/m) + Cable Factor (dB).
 3. The other emission levels were very low against the limit.
 4. Margin value = Emission level – Limit value.
 5. “ * “: Fundamental frequency.
 6. The limit value is defined as per 15.247.
 7. "#":The radiated frequency is out the restricted band.



A D T

EUT TEST CONDITION		MEASUREMENT DETAIL	
CHANNEL	Channel 157	FREQUENCY RANGE	1 ~ 40GHz
INPUT POWER	120Vac, 60 Hz	DETECTOR FUNCTION	Peak (PK) Average (AV)
ENVIRONMENTAL CONDITIONS	25deg. C, 68%RH 1006 hPa	TESTED BY	Match Tsui

ANTENNA POLARITY & TEST DISTANCE: HORIZONTAL AT 3 M								
NO.	FREQ. (MHz)	EMISSION LEVEL (dBuV/m)	LIMIT (dBuV/m)	MARGIN (dB)	ANTENNA HEIGHT (m)	TABLE ANGLE (Degree)	RAW VALUE (dBuV)	CORRECTION FACTOR (dB/m)
1	*5785.00	105.5 PK			1.31 H	69	67.50	38.00
2	*5785.00	96.0 AV			1.31 H	69	58.00	38.00
3	11570.00	63.0 PK	74.0	-11.0	1.07 H	360	15.10	47.90
4	11570.00	51.1 AV	54.0	-2.9	1.07 H	360	3.20	47.90

ANTENNA POLARITY & TEST DISTANCE: VERTICAL AT 3 M								
NO.	FREQ. (MHz)	EMISSION LEVEL (dBuV/m)	LIMIT (dBuV/m)	MARGIN (dB)	ANTENNA HEIGHT (m)	TABLE ANGLE (Degree)	RAW VALUE (dBuV)	CORRECTION FACTOR (dB/m)
1	*5785.00	119.4 PK			1.40 V	173	81.40	38.00
2	*5785.00	110.1 AV			1.40 V	173	72.10	38.00
3	11570.00	60.6 PK	74.0	-13.4	1.00 V	20	12.70	47.90
4	11570.00	46.9 AV	54.0	-7.1	1.00 V	20	-1.00	47.90

- REMARKS:**
1. Emission level (dBuV/m) = Raw Value (dBuV) + Correction Factor (dB/m).
 2. Correction Factor (dB/m) = Antenna Factor (dB/m) + Cable Factor (dB).
 3. The other emission levels were very low against the limit.
 4. Margin value = Emission level – Limit value.
 5. “ * “: Fundamental frequency.
 6. The limit value is defined as per 15.247.



A D T

EUT TEST CONDITION		MEASUREMENT DETAIL	
CHANNEL	Channel 165	FREQUENCY RANGE	1 ~ 40GHz
INPUT POWER	120Vac, 60 Hz	DETECTOR FUNCTION	Peak (PK) Average (AV)
ENVIRONMENTAL CONDITIONS	25deg. C, 68%RH 1006 hPa	TESTED BY	Match Tsui

ANTENNA POLARITY & TEST DISTANCE: HORIZONTAL AT 3 M								
NO.	FREQ. (MHz)	EMISSION LEVEL (dBuV/m)	LIMIT (dBuV/m)	MARGIN (dB)	ANTENNA HEIGHT (m)	TABLE ANGLE (Degree)	RAW VALUE (dBuV)	CORRECTION FACTOR (dB/m)
1	*5825.00	104.6 PK			1.19 H	75	66.50	38.10
2	*5825.00	94.9 AV			1.19 H	75	56.80	38.10
3	#5850.00	68.9 PK	84.6	-15.7	1.37 H	76	30.70	38.20
4	#5850.00	55.9 AV	74.9	-19.0	1.37 H	76	17.70	38.20
5	11650.00	65.7 PK	74.0	-8.3	1.08 H	36	18.00	47.70
6	11650.00	53.0 AV	54.0	-1.0	1.08 H	36	5.30	47.70
ANTENNA POLARITY & TEST DISTANCE: VERTICAL AT 3 M								
NO.	FREQ. (MHz)	EMISSION LEVEL (dBuV/m)	LIMIT (dBuV/m)	MARGIN (dB)	ANTENNA HEIGHT (m)	TABLE ANGLE (Degree)	RAW VALUE (dBuV)	CORRECTION FACTOR (dB/m)
1	*5825.00	119.3 PK			1.10 V	171	81.20	38.10
2	*5825.00	109.6 AV			1.10 V	171	71.50	38.10
3	#5850.00	80.3 PK	99.3	-19.0	1.27 V	159	42.10	38.20
4	#5850.00	63.0 AV	89.6	-26.6	1.27 V	159	24.80	38.20
5	11650.00	61.2 PK	74.0	-12.8	1.00 V	39	13.50	47.70
6	11650.00	47.5 AV	54.0	-6.5	1.00 V	39	-0.20	47.70

- REMARKS:**
1. Emission level (dBuV/m) = Raw Value (dBuV) + Correction Factor (dB/m).
 2. Correction Factor (dB/m) = Antenna Factor (dB/m) + Cable Factor (dB).
 3. The other emission levels were very low against the limit.
 4. Margin value = Emission level – Limit value.
 5. “ * “: Fundamental frequency.
 6. The limit value is defined as per 15.247.
 7. "#":The radiated frequency is out the restricted band.



A D T

802.11n (20MHz)

EUT TEST CONDITION		MEASUREMENT DETAIL	
CHANNEL	Channel 149	FREQUENCY RANGE	1 ~ 40GHz
INPUT POWER	120Vac, 60 Hz	DETECTOR FUNCTION	Peak (PK) Average (AV)
ENVIRONMENTAL CONDITIONS	25deg. C, 68%RH 1006 hPa	TESTED BY	Match Tsui

ANTENNA POLARITY & TEST DISTANCE: HORIZONTAL AT 3 M								
NO.	FREQ. (MHz)	EMISSION LEVEL (dBuV/m)	LIMIT (dBuV/m)	MARGIN (dB)	ANTENNA HEIGHT (m)	TABLE ANGLE (Degree)	RAW VALUE (dBuV)	CORRECTION FACTOR (dB/m)
1	#5725.00	80.8 PK	85.0	-4.2	1.21 H	54	42.80	38.00
2	#5725.00	64.8 AV	75.4	-10.6	1.21 H	54	26.80	38.00
3	*5745.00	105.0 PK			1.48 H	360	67.00	38.00
4	*5745.00	95.4 AV			1.48 H	360	57.40	38.00
5	11490.00	65.6 PK	74.0	-8.4	1.10 H	22	17.60	48.00
6	11490.00	51.1 AV	54.0	-2.9	1.10 H	22	3.10	48.00

ANTENNA POLARITY & TEST DISTANCE: VERTICAL AT 3 M								
NO.	FREQ. (MHz)	EMISSION LEVEL (dBuV/m)	LIMIT (dBuV/m)	MARGIN (dB)	ANTENNA HEIGHT (m)	TABLE ANGLE (Degree)	RAW VALUE (dBuV)	CORRECTION FACTOR (dB/m)
1	#5725.00	93.3 PK	99.7	-6.4	1.06 V	225	55.30	38.00
2	#5725.00	77.3 AV	90.3	-13.0	1.06 V	225	39.30	38.00
3	*5745.00	119.7 PK			1.11 V	174	81.70	38.00
4	*5745.00	110.3 AV			1.11 V	174	72.30	38.00
5	11490.00	60.0 PK	74.0	-14.0	1.10 V	297	12.00	48.00
6	11490.00	47.2 AV	54.0	-6.8	1.10 V	297	-0.80	48.00

- REMARKS:**
1. Emission level (dBuV/m) = Raw Value (dBuV) + Correction Factor (dB/m).
 2. Correction Factor (dB/m) = Antenna Factor (dB/m) + Cable Factor (dB).
 3. The other emission levels were very low against the limit.
 4. Margin value = Emission level – Limit value.
 5. “ * “: Fundamental frequency.
 6. The limit value is defined as per 15.247.
 7. "#":The radiated frequency is out the restricted band.



A D T

EUT TEST CONDITION		MEASUREMENT DETAIL	
CHANNEL	Channel 157	FREQUENCY RANGE	1 ~ 40GHz
INPUT POWER	120Vac, 60 Hz	DETECTOR FUNCTION	Peak (PK) Average (AV)
ENVIRONMENTAL CONDITIONS	25deg. C, 68%RH 1006 hPa	TESTED BY	Match Tsui

ANTENNA POLARITY & TEST DISTANCE: HORIZONTAL AT 3 M								
NO.	FREQ. (MHz)	EMISSION LEVEL (dBuV/m)	LIMIT (dBuV/m)	MARGIN (dB)	ANTENNA HEIGHT (m)	TABLE ANGLE (Degree)	RAW VALUE (dBuV)	CORRECTION FACTOR (dB/m)
1	*5785.00	105.1 PK			1.40 H	330	67.10	38.00
2	*5785.00	95.3 AV			1.40 H	330	57.30	38.00
3	11570.00	66.7 PK	74.0	-7.3	1.07 H	31	18.80	47.90
4	11570.00	51.8 AV	54.0	-2.2	1.07 H	31	3.90	47.90
ANTENNA POLARITY & TEST DISTANCE: VERTICAL AT 3 M								
NO.	FREQ. (MHz)	EMISSION LEVEL (dBuV/m)	LIMIT (dBuV/m)	MARGIN (dB)	ANTENNA HEIGHT (m)	TABLE ANGLE (Degree)	RAW VALUE (dBuV)	CORRECTION FACTOR (dB/m)
1	*5785.00	119.2 PK			1.09 V	188	81.20	38.00
2	*5785.00	110.0 AV			1.09 V	188	72.00	38.00
3	11570.00	61.4 PK	74.0	-12.6	1.03 V	45	13.50	47.90
4	11570.00	47.1 AV	54.0	-6.9	1.03 V	45	-0.80	47.90

- REMARKS:**
1. Emission level (dBuV/m) = Raw Value (dBuV) + Correction Factor (dB/m).
 2. Correction Factor (dB/m) = Antenna Factor (dB/m) + Cable Factor (dB).
 3. The other emission levels were very low against the limit.
 4. Margin value = Emission level – Limit value.
 5. “ * “: Fundamental frequency.
 6. The limit value is defined as per 15.247.



A D T

EUT TEST CONDITION		MEASUREMENT DETAIL	
CHANNEL	Channel 165	FREQUENCY RANGE	1 ~ 40GHz
INPUT POWER	120Vac, 60 Hz	DETECTOR FUNCTION	Peak (PK) Average (AV)
ENVIRONMENTAL CONDITIONS	25deg. C, 68%RH 1006 hPa	TESTED BY	Match Tsui

ANTENNA POLARITY & TEST DISTANCE: HORIZONTAL AT 3 M								
NO.	FREQ. (MHz)	EMISSION LEVEL (dBuV/m)	LIMIT (dBuV/m)	MARGIN (dB)	ANTENNA HEIGHT (m)	TABLE ANGLE (Degree)	RAW VALUE (dBuV)	CORRECTION FACTOR (dB/m)
1	*5825.00	104.1 PK			1.20 H	81	66.00	38.10
2	*5825.00	94.5 AV			1.20 H	81	56.40	38.10
3	#5850.00	73.8 PK	84.1	-10.3	1.10 H	101	35.60	38.20
4	#5850.00	61.1 AV	74.5	-13.4	1.10 H	101	22.90	38.20
5	11650.00	65.9 PK	74.0	-8.1	1.10 H	40	18.20	47.70
6	11650.00	53.0 AV	54.0	-1.0	1.10 H	40	5.30	47.70
ANTENNA POLARITY & TEST DISTANCE: VERTICAL AT 3 M								
NO.	FREQ. (MHz)	EMISSION LEVEL (dBuV/m)	LIMIT (dBuV/m)	MARGIN (dB)	ANTENNA HEIGHT (m)	TABLE ANGLE (Degree)	RAW VALUE (dBuV)	CORRECTION FACTOR (dB/m)
1	*5825.00	118.8 PK			1.11 V	190	80.70	38.10
2	*5825.00	109.7 AV			1.11 V	190	71.60	38.10
3	#5850.00	86.4 PK	98.8	-12.4	1.00 V	189	48.20	38.20
4	#5850.00	69.1 AV	89.7	-20.6	1.00 V	189	30.90	38.20
5	11650.00	62.7 PK	74.0	-11.3	1.00 V	47	15.00	47.70
6	11650.00	48.1 AV	54.0	-5.9	1.00 V	47	0.40	47.70

- REMARKS:**
1. Emission level (dBuV/m) = Raw Value (dBuV) + Correction Factor (dB/m).
 2. Correction Factor (dB/m) = Antenna Factor (dB/m) + Cable Factor (dB).
 3. The other emission levels were very low against the limit.
 4. Margin value = Emission level – Limit value.
 5. “ * “: Fundamental frequency.
 6. The limit value is defined as per 15.247.
 7. “#”:The radiated frequency is out the restricted band.



A D T

802.11n (40MHz)

EUT TEST CONDITION		MEASUREMENT DETAIL	
CHANNEL	Channel 151	FREQUENCY RANGE	1 ~ 40GHz
INPUT POWER	120Vac, 60 Hz	DETECTOR FUNCTION	Peak (PK) Average (AV)
ENVIRONMENTAL CONDITIONS	25deg. C, 68%RH 1006 hPa	TESTED BY	Match Tsui

ANTENNA POLARITY & TEST DISTANCE: HORIZONTAL AT 3 M								
NO.	FREQ. (MHz)	EMISSION LEVEL (dBuV/m)	LIMIT (dBuV/m)	MARGIN (dB)	ANTENNA HEIGHT (m)	TABLE ANGLE (Degree)	RAW VALUE (dBuV)	CORRECTION FACTOR (dB/m)
1	#5725.00	81.5 PK	82.4	-0.9	1.58 H	132	43.50	38.00
2	#5725.00	67.7 AV	72.9	-5.2	1.58 H	132	29.70	38.00
3	*5755.00	102.4 PK			1.47 H	168	64.40	38.00
4	*5755.00	92.9 AV			1.47 H	168	54.90	38.00
5	11510.00	61.6 PK	74.0	-12.4	1.06 H	45	13.60	48.00
6	11510.00	50.0 AV	54.0	-4.0	1.06 H	45	2.00	48.00
ANTENNA POLARITY & TEST DISTANCE: VERTICAL AT 3 M								
NO.	FREQ. (MHz)	EMISSION LEVEL (dBuV/m)	LIMIT (dBuV/m)	MARGIN (dB)	ANTENNA HEIGHT (m)	TABLE ANGLE (Degree)	RAW VALUE (dBuV)	CORRECTION FACTOR (dB/m)
1	#5725.00	93.4 PK	96.7	-3.3	1.45 V	316	55.40	38.00
2	#5725.00	80.3 AV	86.8	-6.5	1.45 V	316	42.30	38.00
3	*5755.00	116.7 PK			1.32 V	313	78.70	38.00
4	*5755.00	106.8 AV			1.32 V	313	68.80	38.00
5	11510.00	58.5 PK	74.0	-15.5	1.16 V	299	10.50	48.00
6	11510.00	46.2 AV	54.0	-7.8	1.16 V	299	-1.80	48.00

- REMARKS:**
1. Emission level (dBuV/m) = Raw Value (dBuV) + Correction Factor (dB/m).
 2. Correction Factor (dB/m) = Antenna Factor (dB/m) + Cable Factor (dB).
 3. The other emission levels were very low against the limit.
 4. Margin value = Emission level – Limit value.
 5. “ * “: Fundamental frequency.
 6. The limit value is defined as per 15.247.
 7. "#":The radiated frequency is out the restricted band.



A D T

EUT TEST CONDITION		MEASUREMENT DETAIL	
CHANNEL	Channel 159	FREQUENCY RANGE	1 ~ 40GHz
INPUT POWER	120Vac, 60 Hz	DETECTOR FUNCTION	Peak (PK) Average (AV)
ENVIRONMENTAL CONDITIONS	25deg. C, 68%RH 1006 hPa	TESTED BY	Match Tsui

ANTENNA POLARITY & TEST DISTANCE: HORIZONTAL AT 3 M								
NO.	FREQ. (MHz)	EMISSION LEVEL (dBuV/m)	LIMIT (dBuV/m)	MARGIN (dB)	ANTENNA HEIGHT (m)	TABLE ANGLE (Degree)	RAW VALUE (dBuV)	CORRECTION FACTOR (dB/m)
1	*5795.00	103.2 PK			1.12 H	85	65.10	38.10
2	*5795.00	93.0 AV			1.12 H	85	54.90	38.10
3	#5850.00	67.5 PK	83.2	-15.7	1.23 H	69	29.30	38.20
4	#5850.00	54.7 AV	73.0	-18.3	1.23 H	69	16.50	38.20
5	11590.00	63.1 PK	74.0	-10.9	1.00 H	24	15.20	47.90
6	11590.00	51.3 AV	54.0	-2.7	1.00 H	24	3.40	47.90
ANTENNA POLARITY & TEST DISTANCE: VERTICAL AT 3 M								
NO.	FREQ. (MHz)	EMISSION LEVEL (dBuV/m)	LIMIT (dBuV/m)	MARGIN (dB)	ANTENNA HEIGHT (m)	TABLE ANGLE (Degree)	RAW VALUE (dBuV)	CORRECTION FACTOR (dB/m)
1	*5795.00	116.5 PK			1.29 V	208	78.40	38.10
2	*5795.00	106.5 AV			1.29 V	208	68.40	38.10
3	#5850.00	72.1 PK	96.5	-24.4	1.01 V	266	33.90	38.20
4	#5850.00	59.3 AV	86.5	-27.2	1.01 V	266	21.10	38.20
5	11590.00	59.4 PK	74.0	-14.6	1.10 V	310	11.50	47.90
6	11590.00	46.8 AV	54.0	-7.2	1.10 V	310	-1.10	47.90

- REMARKS:**
1. Emission level (dBuV/m) = Raw Value (dBuV) + Correction Factor (dB/m).
 2. Correction Factor (dB/m) = Antenna Factor (dB/m) + Cable Factor (dB).
 3. The other emission levels were very low against the limit.
 4. Margin value = Emission level – Limit value.
 5. “ * “: Fundamental frequency.
 6. The limit value is defined as per 15.247.
 7. "#":The radiated frequency is out the restricted band.



A D T

BELOW 1GHz WORST-CASE DATA : 802.11a

EUT TEST CONDITION		MEASUREMENT DETAIL	
CHANNEL	Channel 1	FREQUENCY RANGE	Below 1000MHz
INPUT POWER	120Vac, 60 Hz	DETECTOR FUNCTION	Quasi-Peak
ENVIRONMENTAL CONDITIONS	25deg. C, 65%RH 1010 hPa	TESTED BY	Sun Lin

ANTENNA POLARITY & TEST DISTANCE: HORIZONTAL AT 3 M								
NO.	FREQ. (MHz)	EMISSION LEVEL (dBuV/m)	LIMIT (dBuV/m)	MARGIN (dB)	ANTENNA HEIGHT (m)	TABLE ANGLE (Degree)	RAW VALUE (dBuV)	CORRECTION FACTOR (dB/m)
1	249.60	31.9 QP	46.0	-14.1	1.00 H	295	17.40	14.50
2	333.21	35.6 QP	46.0	-10.4	1.00 H	211	19.50	16.10
3	374.04	37.4 QP	46.0	-8.6	2.25 H	214	19.40	18.00
4	500.42	42.0 QP	46.0	-4.0	2.00 H	31	20.30	21.70
5	624.85	43.8 QP	46.0	-2.2	1.25 H	199	19.20	24.60
6	751.23	35.9 QP	46.0	-10.1	1.00 H	61	8.50	27.40
ANTENNA POLARITY & TEST DISTANCE: VERTICAL AT 3 M								
NO.	FREQ. (MHz)	EMISSION LEVEL (dBuV/m)	LIMIT (dBuV/m)	MARGIN (dB)	ANTENNA HEIGHT (m)	TABLE ANGLE (Degree)	RAW VALUE (dBuV)	CORRECTION FACTOR (dB/m)
1	41.57	36.2 QP	40.0	-3.8	1.50 V	220	21.00	15.20
2	333.21	36.1 QP	46.0	-9.9	1.50 V	64	20.00	16.10
3	500.42	42.0 QP	46.0	-4.0	1.00 V	91	20.30	21.70
4	624.85	38.6 QP	46.0	-7.4	1.50 V	217	14.00	24.60
5	751.23	37.2 QP	46.0	-8.8	2.00 V	175	9.80	27.40
6	840.67	35.1 QP	46.0	-10.9	1.00 V	166	6.10	29.00

- REMARKS:**
1. Emission level (dBuV/m) = Raw Value (dBuV) + Correction Factor (dB/m).
 2. Correction Factor (dB/m) = Antenna Factor (dB/m) + Cable Factor (dB).
 3. The other emission levels were very low against the limit.
 4. Margin value = Emission level – Limit value.



A D T

EUT TEST CONDITION		MEASUREMENT DETAIL	
CHANNEL	Channel 1	FREQUENCY RANGE	Below 1000MHz
INPUT POWER	120Vac, 60 Hz	DETECTOR FUNCTION	Quasi-Peak
ENVIRONMENTAL CONDITIONS	25deg. C, 65%RH 1010 hPa	TESTED BY	Sun Lin

ANTENNA POLARITY & TEST DISTANCE: HORIZONTAL AT 3 M								
NO.	FREQ. (MHz)	EMISSION LEVEL (dBuV/m)	LIMIT (dBuV/m)	MARGIN (dB)	ANTENNA HEIGHT (m)	TABLE ANGLE (Degree)	RAW VALUE (dBuV)	CORRECTION FACTOR (dB/m)
1	53.23	35.7 QP	40.0	-4.3	1.00 H	184	22.20	13.50
2	105.73	32.7 QP	43.5	-10.8	1.25 H	301	20.70	12.00
3	333.21	39.8 QP	46.0	-6.2	1.50 H	58	23.70	16.10
4	374.04	40.1 QP	46.0	-5.9	1.50 H	73	22.10	18.00
5	500.42	41.5 QP	46.0	-4.5	1.25 H	91	19.80	21.70
6	624.85	37.1 QP	46.0	-8.9	1.50 H	211	12.50	24.60

ANTENNA POLARITY & TEST DISTANCE: VERTICAL AT 3 M								
NO.	FREQ. (MHz)	EMISSION LEVEL (dBuV/m)	LIMIT (dBuV/m)	MARGIN (dB)	ANTENNA HEIGHT (m)	TABLE ANGLE (Degree)	RAW VALUE (dBuV)	CORRECTION FACTOR (dB/m)
1	41.57	35.7 QP	40.0	-4.3	1.00 V	10	20.50	15.20
2	333.21	39.4 QP	46.0	-6.6	1.50 V	64	23.30	16.10
3	374.04	40.1 QP	46.0	-5.9	1.50 V	64	22.10	18.00
4	500.42	41.6 QP	46.0	-4.4	1.25 V	88	19.90	21.70
5	624.85	39.1 QP	46.0	-6.9	1.25 V	139	14.50	24.60
6	827.06	40.4 QP	46.0	-5.6	1.50 V	241	11.80	28.60

- REMARKS:**
1. Emission level (dBuV/m) = Raw Value (dBuV) + Correction Factor (dB/m).
 2. Correction Factor (dB/m) = Antenna Factor (dB/m) + Cable Factor (dB).
 3. The other emission levels were very low against the limit.
 4. Margin value = Emission level – Limit value.



5.2 CONDUCTED EMISSION MEASUREMENT

5.2.1 LIMITS OF CONDUCTED EMISSION MEASUREMENT

FREQUENCY OF EMISSION (MHz)	CONDUCTED LIMIT (dBµV)	
	Quasi-peak	Average
0.15 ~ 0.5	66 to 56	56 to 46
0.5 ~ 5	56	46
5 ~ 30	60	50

- NOTE:**
1. The lower limit shall apply at the transition frequencies.
 2. The limit decreases in line with the logarithm of the frequency in the range of 0.15 to 0.50MHz.
 3. All emanations from a class A/B digital device or system, including any network of conductors and apparatus connected thereto, shall not exceed the level of field strengths specified above.

5.2.2 TEST INSTRUMENTS

DESCRIPTION & MANUFACTURER	MODEL NO.	SERIAL NO.	DATE OF CALIBRATION	DUE DATE OF CALIBRATION
Test Receiver ROHDE & SCHWARZ	ESCS30	100291	Nov. 30, 2010	Nov. 29, 2011
RF signal cable Woken	5D-FB	Cable-HYC01-01	Dec. 30, 2009	Dec. 29, 2010
LISN ROHDE & SCHWARZ	ESH3-Z5	100312	Jun. 28, 2010	Jun. 27, 2011
LISN ROHDE & SCHWARZ	ESH3-Z5	835239/001	Feb. 10, 2010	Feb. 09, 2011
V-LISN SCHWARZBECK	NNBL 8226-2	8226-142	Jul. 12, 2010	Jul. 11, 2011
Software ADT	ADT_Cond_ V7.3.7	NA	NA	NA

- NOTE:**
1. The calibration interval of the above test instruments is 12 months and the calibrations are traceable to NML/ROC and NIST/USA.
 2. The test was performed in HwaYa Shielded Room 1.
 3. The VCCI Site Registration No. is C-2040.



A D T

5.2.3 TEST PROCEDURES

- a. The EUT was placed 0.4 meters from the conducting wall of the shielded room with EUT being connected to the power mains through a line impedance stabilization network (LISN). Other support units were connected to the power mains through another LISN. The two LISNs provide 50 ohm/ 50uH of coupling impedance for the measuring instrument.
- b. Both lines of the power mains connected to the EUT were checked for maximum conducted interference.
- c. The frequency range from 150kHz to 30MHz was searched. Emission levels under (Limit - 20dB) was not recorded.

NOTE: All modes of operation were investigated and the worst-case emissions are reported.

5.2.4 DEVIATION FROM TEST STANDARD

No deviation.

5.2.5 TEST SETUP

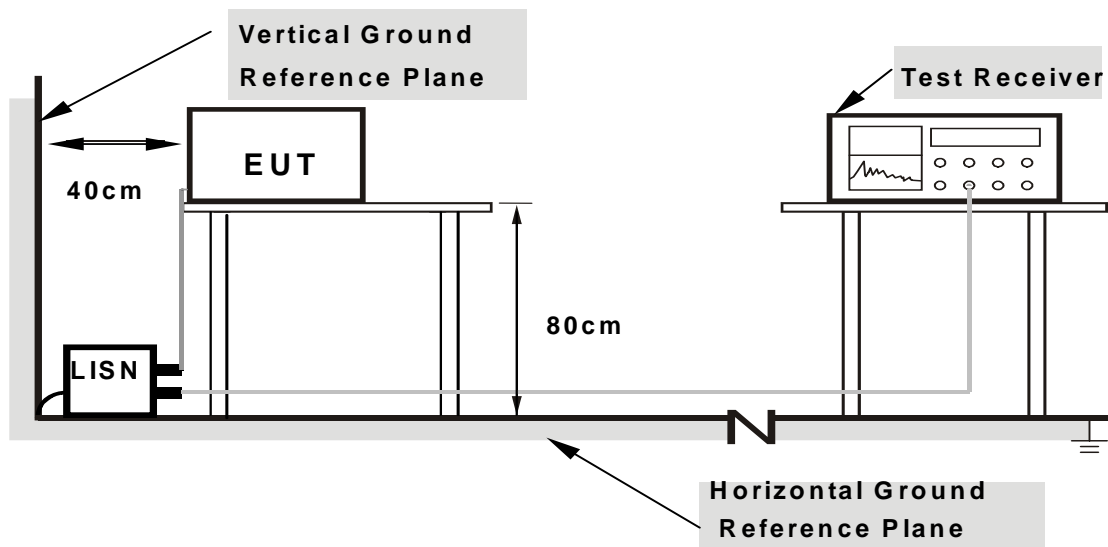

Note: 1. Support units were connected to second LISN.

2. Both of LISNs (AMN) are 80 cm from EUT and at least 80 from other units and other metal planes

For the actual test configuration, please refer to the attached file (Test Setup Photo).

5.2.6 EUT OPERATING CONDITIONS

Same as 4.1.6

5.2.7 TEST RESULTS

CONDUCTED WORST-CASE DATA : 802.11a

PHASE	Line 1	6dB BANDWIDTH	9kHz
TEST MODE	A		

No	Freq. [MHz]	Corr. Factor (dB)	Reading Value		Emission Level		Limit		Margin	
			[dB (uV)]		[dB (uV)]		[dB (uV)]		(dB)	
			Q.P.	AV.	Q.P.	AV.	Q.P.	AV.	Q.P.	AV.
1	0.150	0.12	45.42	-	45.54	-	66.00	56.00	-20.46	-
2	0.193	0.11	53.89	38.90	54.00	39.01	63.91	53.91	-9.91	-14.90
3	0.248	0.11	44.74	-	44.85	-	61.84	51.84	-16.98	-
4	0.439	0.13	30.97	-	31.10	-	57.08	47.08	-25.98	-
5	2.883	0.29	26.05	-	26.34	-	56.00	46.00	-29.66	-
6	13.523	0.93	35.65	-	36.58	-	60.00	50.00	-23.42	-

- REMARKS:**
1. Q.P. and AV. are abbreviations of quasi-peak and average individually.
 2. "-": The Quasi-peak reading value also meets average limit and measurement with the average detector is unnecessary.
 3. The emission levels of other frequencies were very low against the limit.
 4. Margin value = Emission level - Limit value
 5. Correction factor = Insertion loss + Cable loss
 6. Emission Level = Correction Factor + Reading Value.

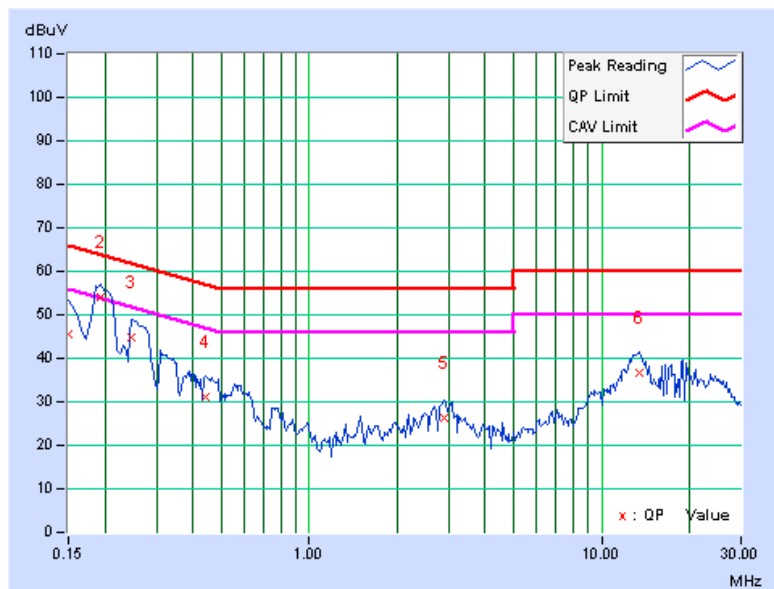

PHASE	Line 2	6dB BANDWIDTH	9kHz
TEST MODE	A		

No	Freq. [MHz]	Corr.	Reading Value		Emission Level		Limit		Margin	
		Factor	[dB (uV)]		[dB (uV)]		[dB (uV)]		(dB)	
		(dB)	Q.P.	AV.	Q.P.	AV.	Q.P.	AV.	Q.P.	AV.
1	0.150	0.10	45.40	-	45.50	-	66.00	56.00	-20.50	-
2	0.189	0.10	54.83	39.00	54.93	39.10	64.08	54.08	-9.15	-14.98
3	0.252	0.11	46.53	-	46.64	-	61.71	51.71	-15.07	-
4	0.482	0.13	37.32	-	37.45	-	56.30	46.30	-18.86	-
5	2.910	0.28	27.50	-	27.78	-	56.00	46.00	-28.22	-
6	13.574	0.82	36.03	-	36.85	-	60.00	50.00	-23.15	-

- REMARKS:**
1. Q.P. and AV. are abbreviations of quasi-peak and average individually.
 2. "-": The Quasi-peak reading value also meets average limit and measurement with the average detector is unnecessary.
 3. The emission levels of other frequencies were very low against the limit.
 4. Margin value = Emission level - Limit value
 5. Correction factor = Insertion loss + Cable loss
 6. Emission Level = Correction Factor + Reading Value.

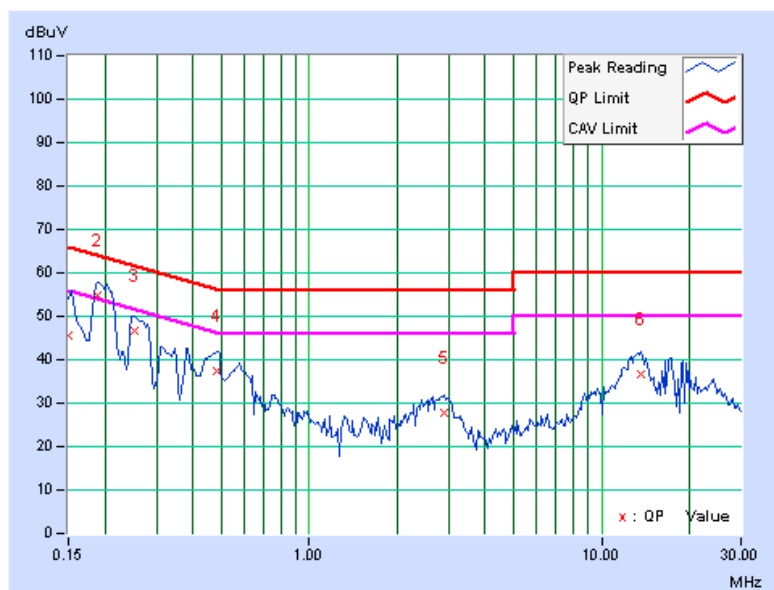



A D T

PHASE	Line 1	6dB BANDWIDTH	9kHz
TEST MODE	B		

No	Freq.	Corr.	Reading Value		Emission Level		Limit		Margin	
		Factor	[dB (uV)]		[dB (uV)]		[dB (uV)]		(dB)	
	[MHz]	(dB)	Q.P.	AV.	Q.P.	AV.	Q.P.	AV.	Q.P.	AV.
1	0.173	0.12	49.90	-	50.02	-	64.79	54.79	-14.78	-
2	0.205	0.11	44.84	-	44.95	-	63.42	53.42	-18.47	-
3	0.244	0.11	39.69	-	39.80	-	61.97	51.97	-22.16	-
4	0.646	0.15	37.34	-	37.49	-	56.00	46.00	-18.51	-
5	3.250	0.31	28.88	-	29.19	-	56.00	46.00	-26.81	-
6	16.996	1.23	30.09	-	31.32	-	60.00	50.00	-28.68	-

- REMARKS:**
1. Q.P. and AV. are abbreviations of quasi-peak and average individually.
 2. "-": The Quasi-peak reading value also meets average limit and measurement with the average detector is unnecessary.
 3. The emission levels of other frequencies were very low against the limit.
 4. Margin value = Emission level - Limit value
 5. Correction factor = Insertion loss + Cable loss
 6. Emission Level = Correction Factor + Reading Value.

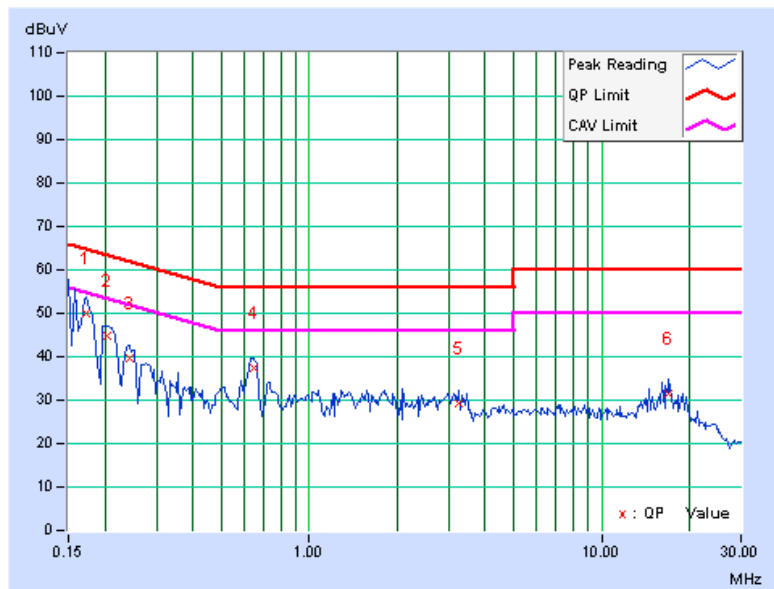

PHASE	Line 2	6dB BANDWIDTH	9kHz
TEST MODE	B		

No	Freq. [MHz]	Corr.	Reading Value		Emission Level		Limit		Margin	
		Factor	[dB (uV)]		[dB (uV)]		[dB (uV)]		(dB)	
		(dB)	Q.P.	AV.	Q.P.	AV.	Q.P.	AV.	Q.P.	AV.
1	0.170	0.10	49.84	-	49.94	-	64.98	54.98	-15.04	-
2	0.201	0.10	43.28	-	43.38	-	63.58	53.58	-20.20	-
3	0.236	0.10	39.51	-	39.61	-	62.24	52.24	-22.62	-
4	0.646	0.14	38.23	-	38.37	-	56.00	46.00	-17.63	-
5	3.566	0.30	29.35	-	29.65	-	56.00	46.00	-26.35	-
6	16.660	1.05	31.45	-	32.50	-	60.00	50.00	-27.50	-

- REMARKS:**
1. Q.P. and AV. are abbreviations of quasi-peak and average individually.
 2. "-": The Quasi-peak reading value also meets average limit and measurement with the average detector is unnecessary.
 3. The emission levels of other frequencies were very low against the limit.
 4. Margin value = Emission level - Limit value
 5. Correction factor = Insertion loss + Cable loss
 6. Emission Level = Correction Factor + Reading Value.

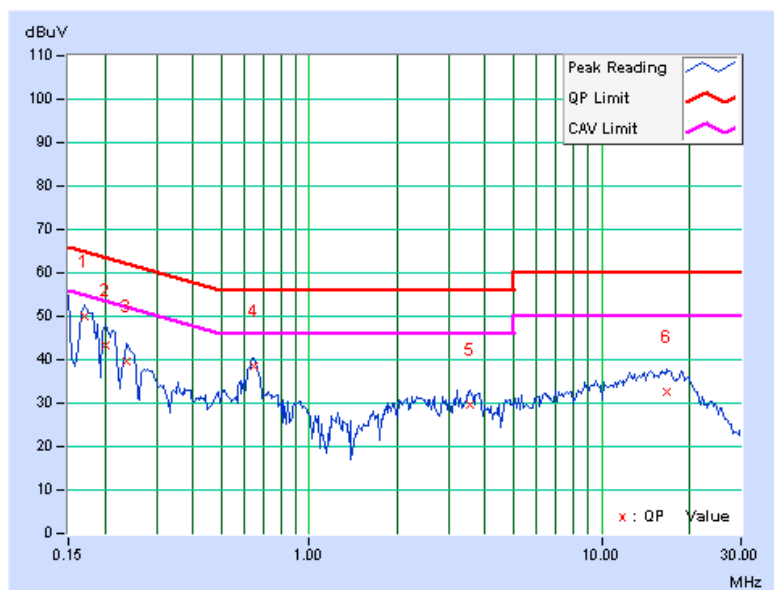



5.3 6dB BANDWIDTH MEASUREMENT

5.3.1 LIMITS OF 6dB BANDWIDTH MEASUREMENT

The minimum of 6dB Bandwidth Measurement is 0.5MHz.

5.3.2 TEST INSTRUMENTS

DESCRIPTION & MANUFACTURER	MODEL NO.	SERIAL NO.	DATE OF CALIBRATION	DUE DATE OF CALIBRATION
R&S SPECTRUM ANALYZER	FSP40	100039	Jan. 11, 2010	Jan. 10, 2011

NOTE: The calibration interval of the above test instruments is 12 months and the calibrations are traceable to NML/ROC and NIST/USA.

5.3.3 TEST PROCEDURE

The transmitter output was connected to the spectrum analyzer through an attenuator. The bandwidth of the fundamental frequency was measured by spectrum analyzer with 100kHz RBW and 300kHz VBW. The 6dB bandwidth is defined as the total spectrum the power of which is higher than peak power minus 6dB.

5.3.4 DEVIATION FROM TEST STANDARD

No deviation.

5.3.5 TEST SETUP

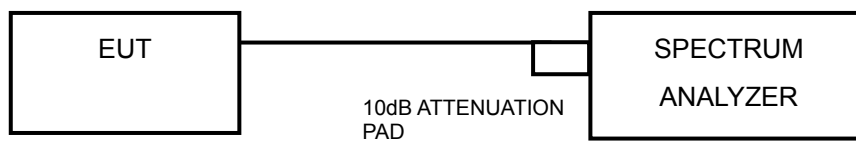

5.3.6 EUT OPERATING CONDITIONS

The software provided by client to enable the EUT under transmission condition continuously at lowest, middle and highest channel frequencies individually.



A D T

5.3.7 TEST RESULTS

802.11a

CHANNEL	CHANNEL FREQUENCY (MHz)	6dB BANDWIDTH (MHz)			MINIMUM LIMIT (MHz)	PASS / FAIL
		CHAIN 0	CHAIN 1	CHAIN 2		
149	5745	16.57	16.57	16.52	0.5	PASS
157	5785	16.60	16.58	16.56	0.5	PASS
165	5825	16.54	16.59	16.59	0.5	PASS

FOR CHAIN 0: CH 157

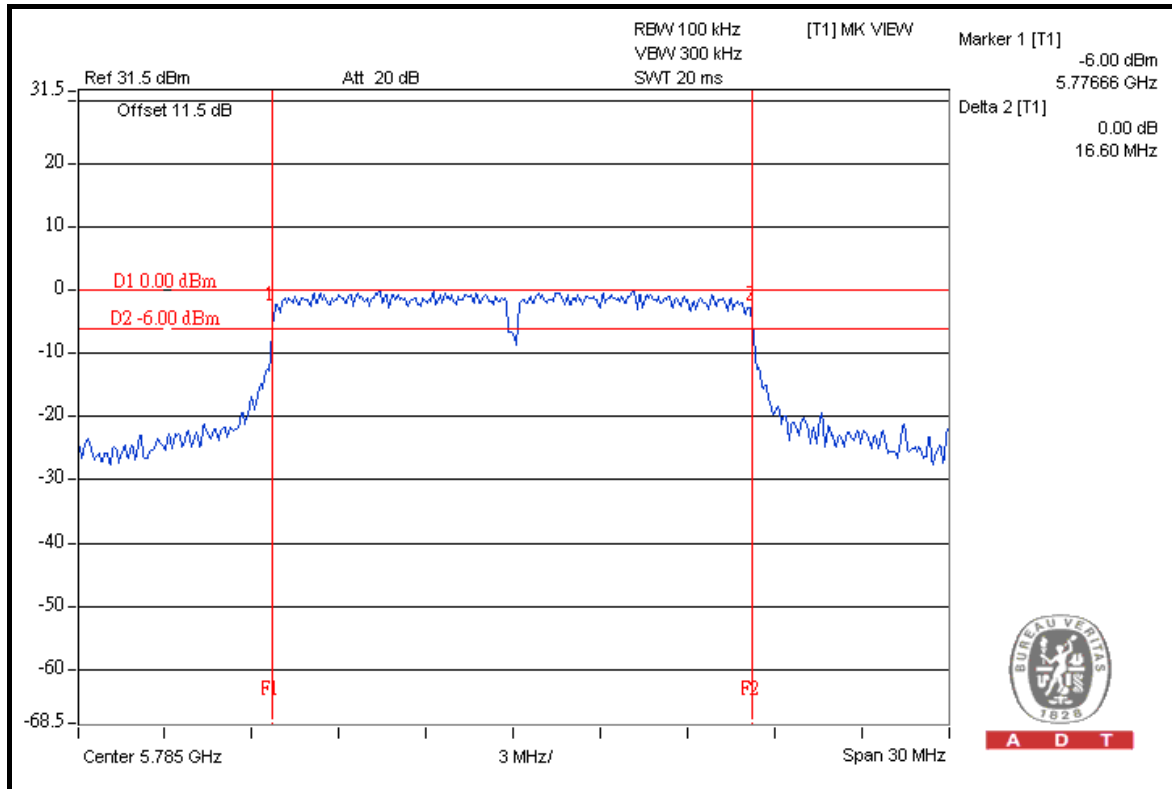



A D T

802.11n (20MHz)

CHANNEL	CHANNEL FREQUENCY (MHz)	6dB BANDWIDTH (MHz)			MINIMUM LIMIT (MHz)	PASS / FAIL
		CHAIN 0	CHAIN 1	CHAIN 2		
149	5745	17.69	17.67	17.68	0.5	PASS
157	5785	17.69	17.68	17.66	0.5	PASS
165	5825	17.67	17.64	17.65	0.5	PASS

FOR CHAIN 0: CH 157

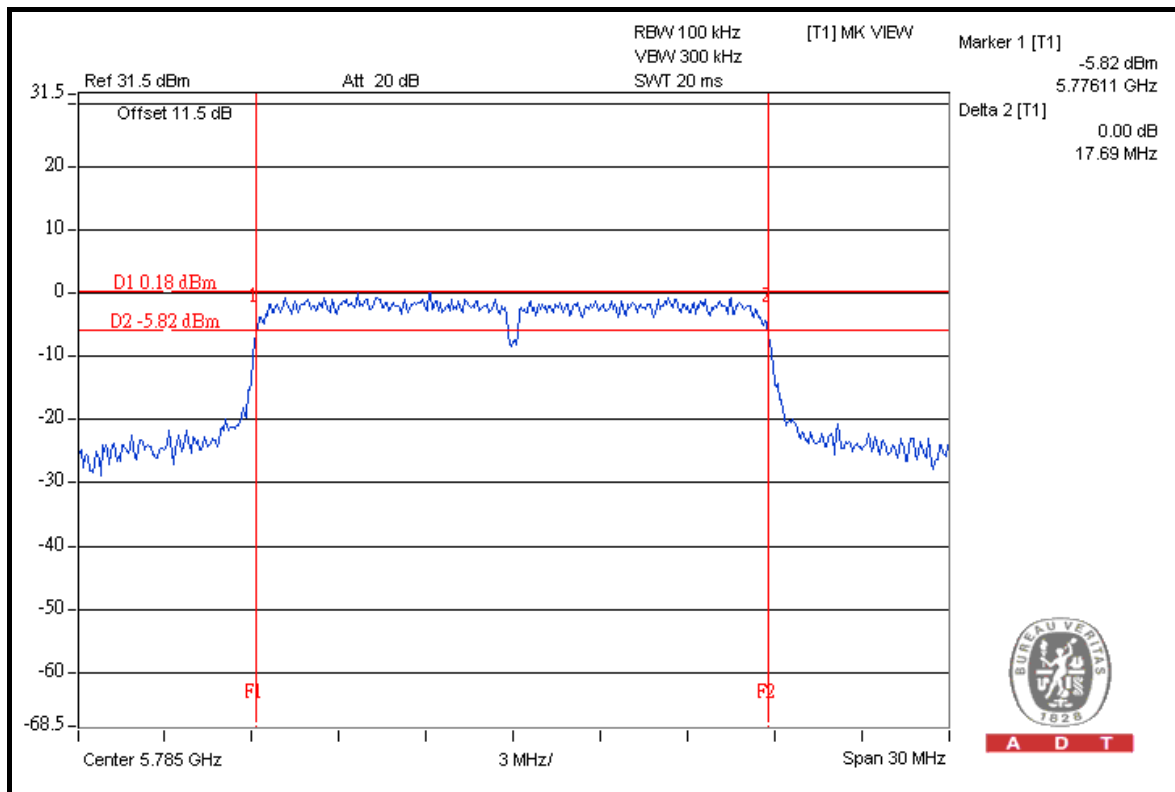



A D T

802.11n (40MHz)

CHANNEL	CHANNEL FREQUENCY (MHz)	6dB BANDWIDTH (MHz)			MINIMUM LIMIT (MHz)	PASS / FAIL
		CHAIN 0	CHAIN 1	CHAIN 2		
151	5755	36.46	36.44	36.44	0.5	PASS
159	5795	36.18	36.37	36.44	0.5	PASS

FOR CHAIN 0: CH 151

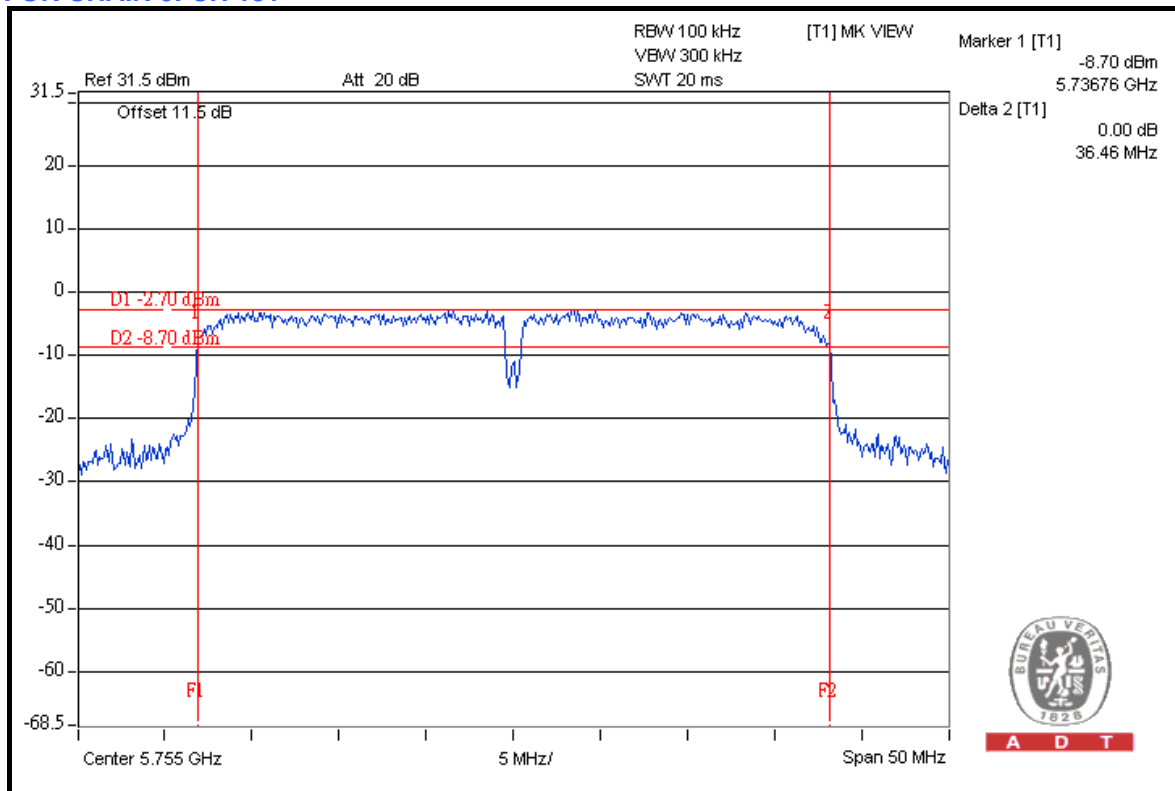

A D T



A D T

5.4 MAXIMUM OUTPUT POWER

5.4.1 LIMITS OF MAXIMUM OUTPUT POWER MEASUREMENT

The Maximum Output Power Measurement is 30dBm.

5.4.2 INSTRUMENTS

DESCRIPTION & MANUFACTURER	MODEL NO.	SERIAL NO.	DATE OF CALIBRATION	DUE DATE OF CALIBRATION
High Speed Peak Power Meter	ML2495A	0842014	Apr. 21, 2010	Apr. 20, 2011
Power Sensor	MA2411B	0738404	Apr. 21, 2010	Apr. 20, 2011

- Note:** 1. The calibration interval of the above test instruments is 12 months and the calibrations are traceable to NML/ROC and NIST/USA.
2. Measurement Bandwidth of ML2495A is 65MHz greater than 6dB bandwidth of emission.

5.4.3 TEST PROCEDURES

A power sensor was used on the output port of the EUT. A power meter was used to read the response of the power sensor. Record the power level.

5.4.4 DEVIATION FROM TEST STANDARD

No deviation.

5.4.5 TEST SETUP

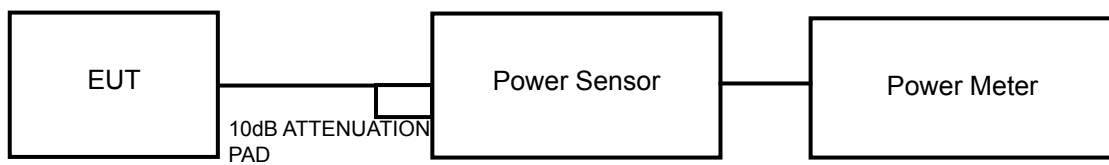

5.4.6 EUT OPERATING CONDITIONS

Same as Item 5.3.6

5.4.7 TEST RESULTS

802.11a

CHAN.	CHAN. FREQ. (MHz)	POWER OUTPUT (dBm)			TOTAL POWER (mW)	TOTAL POWER (dBm)	POWER LIMIT (dBm)	PASS / FAIL
		CHAIN 0	CHAIN 1	CHAIN 2				
149	5745	20.5	20.8	20.3	338.84	25.3	26.2	PASS
157	5785	19.8	20.5	19.9	302.00	24.8	26.2	PASS
165	5825	19.3	20.1	19.4	275.42	24.4	26.2	PASS

Directional gain = $5\text{dBi} + 10\log(3) = 9.8\text{dBi} > 6\text{dBi}$, so the conducted power limit shall be reduced to $30 - (9.8 - 6) = 26.2\text{dBm}$

802.11n (20MHz)

CHAN.	CHAN. FREQ. (MHz)	POWER OUTPUT (dBm)			TOTAL POWER (mW)	TOTAL POWER (dBm)	POWER LIMIT (dBm)	PASS / FAIL
		CHAIN 0	CHAIN 1	CHAIN 2				
149	5745	20.3	21.2	20.5	351.2	25.5	30	PASS
157	5785	19.8	21.2	19.9	325.0	25.1	30	PASS
165	5825	19.2	20.5	19.5	284.5	24.5	30	PASS

802.11n (40MHz)

CHAN.	CHAN. FREQ. (MHz)	POWER OUTPUT (dBm)			TOTAL POWER (mW)	TOTAL POWER (dBm)	POWER LIMIT (dBm)	PASS / FAIL
		CHAIN 0	CHAIN 1	CHAIN 2				
151	5755	20.1	20.7	19.7	313.1	25.0	30	PASS
159	5795	19.5	20.7	19.7	299.9	24.8	30	PASS



A D T

5.5 POWER SPECTRAL DENSITY MEASUREMENT

5.5.1 LIMITS OF POWER SPECTRAL DENSITY MEASUREMENT

The Maximum of Power Spectral Density Measurement is 8dBm.

5.5.2 TEST INSTRUMENTS

DESCRIPTION & MANUFACTURER	MODEL NO.	SERIAL NO.	DATE OF CALIBRATION	DUE DATE OF CALIBRATION
R&S SPECTRUM ANALYZER	FSP40	100039	Jan. 11, 2010	Jan. 10, 2011

NOTE: The calibration interval of the above test instruments is 12 months and the calibrations are traceable to NML/ROC and NIST/USA.

5.5.3 TEST PROCEDURE

The transmitter output was connected to the spectrum analyzer through an attenuator, the bandwidth of the fundamental frequency was measured with the spectrum analyzer using 3kHz RBW and 30kHz VBW, set sweep time = span/3kHz. The power spectral density was measured and recorded.

The sweep time is allowed to be longer than span/3kHz for a full response of the mixer in the spectrum analyzer.

5.5.4 DEVIATION FROM TEST STANDARD

No deviation.

5.5.5 TEST SETUP

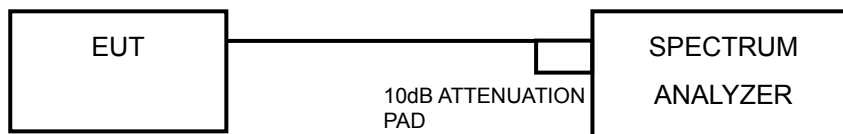

5.5.6 EUT OPERATING CONDITION

Same as Item 5.3.6.



A D T

5.5.7 TEST RESULTS

802.11a

CHAN.	CHAN. FREQ. (MHz)	RF POWER LEVEL IN 3kHz BW (dBm)			TOTAL POWER DENSITY (mW)	TOTAL POWER DENSITY (dBm)	MAX. LIMIT (dBm)	PASS / FAIL
		CHAIN 0	CHAIN 1	CHAIN 2				
149	5745	-13.1	-14.1	-13.8	0.1	-8.9	4.2	PASS
157	5785	-13.9	-14.5	-14.4	0.1	-9.5	4.2	PASS
165	5825	-14.5	-14.9	-14.6	0.1	-9.9	4.2	PASS

Directional gain = $5\text{dBi} + 10\log(3) = 9.8\text{dBi} > 6\text{dBi}$, so the conducted power limit shall be reduced to $8 - (9.8 - 6) = 4.2\text{dBm}$

FOR CHAIN 0: CH 149

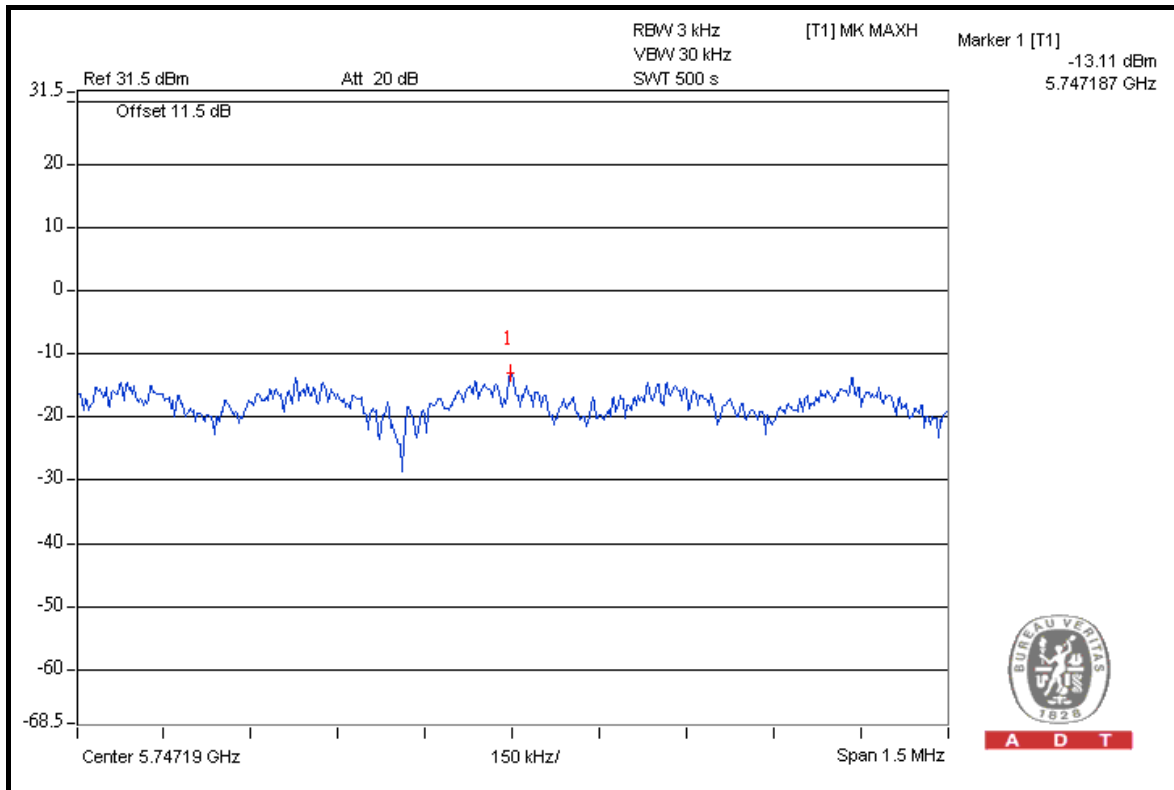

A D T



A D T

802.11n (20MHz)

CHAN.	CHAN. FREQ. (MHz)	RF POWER LEVEL IN 3kHz BW (dBm)			TOTAL POWER DENSITY (mW)	TOTAL POWER DENSITY (dBm)	MAX. LIMIT (dBm)	PASS / FAIL
		CHAIN 0	CHAIN 1	CHAIN 2				
149	5745	-13.5	-15.2	-13.9	0.1	-9.4	8	PASS
157	5785	-13.9	-15.2	-14.7	0.1	-9.8	8	PASS
165	5825	-14.4	-15.8	-14.8	0.1	-10.2	8	PASS

FOR CHAIN 0: CH 149

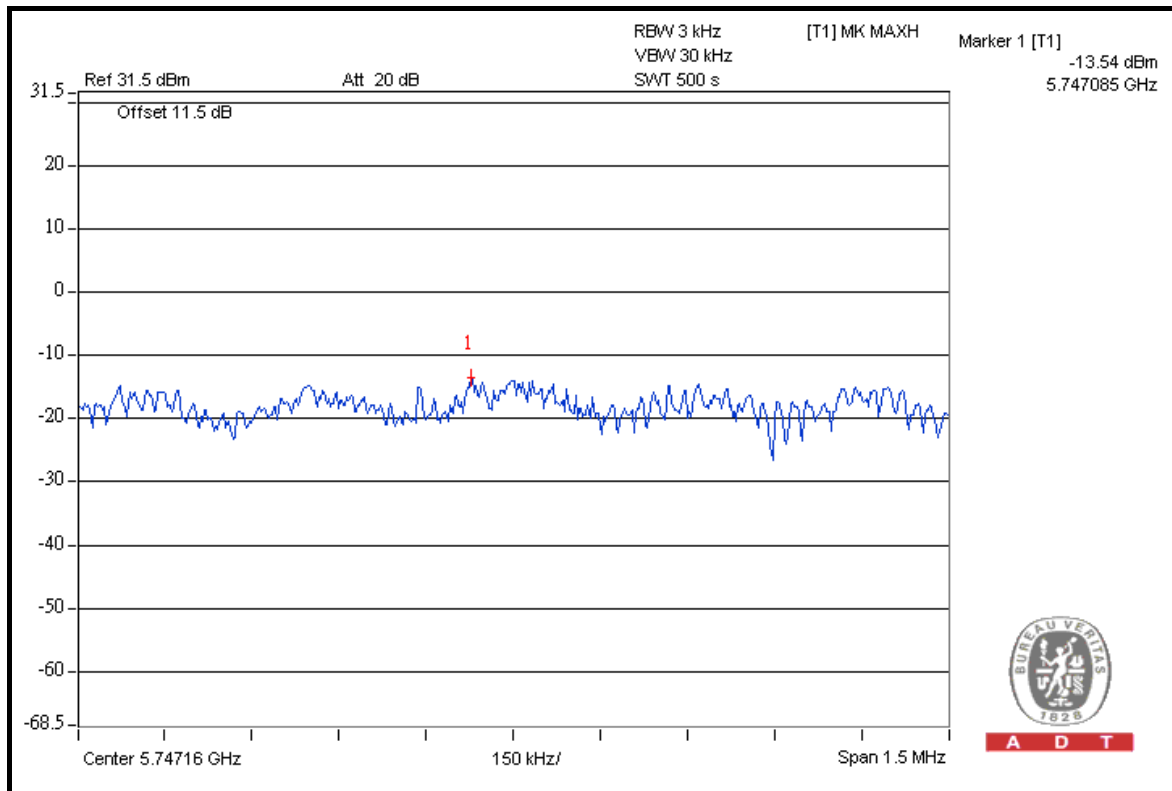



A D T

802.11n (40MHz)

CHAN.	CHAN. FREQ. (MHz)	RF POWER LEVEL IN 3kHz BW (dBm)			TOTAL POWER DENSITY (mW)	TOTAL POWER DENSITY (dBm)	MAX. LIMIT (dBm)	PASS / FAIL
		CHAIN 0	CHAIN 1	CHAIN 2				
151	5755	-16.6	-16.5	-16.5	0.1	-11.8	8	PASS
159	5795	-17.2	-16.6	-16.3	0.1	-11.9	8	PASS

FOR CHAIN 2: CH 159

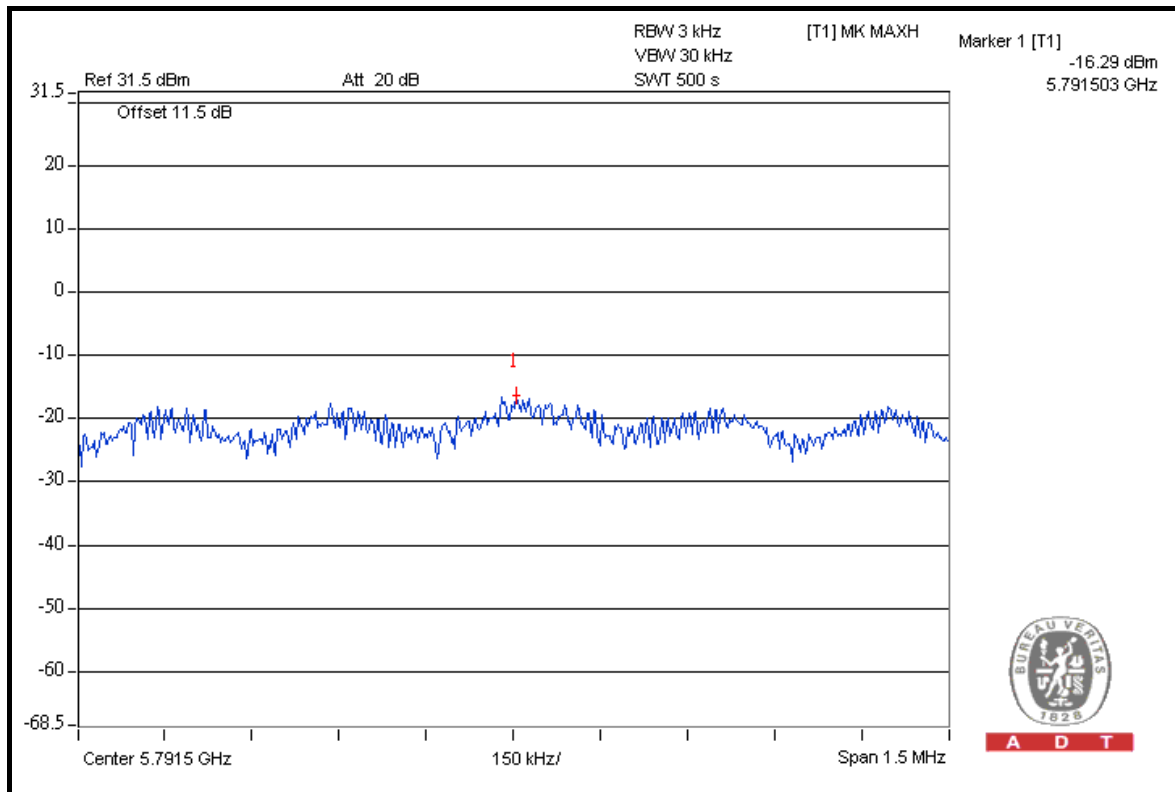



A D T

5.6 BAND EDGES MEASUREMENT

5.6.1 LIMITS OF BAND EDGES MEASUREMENT

Below -20dB of the highest emission level of operating band (in 100kHz Resolution Bandwidth).

5.6.2 TEST INSTRUMENTS

DESCRIPTION & MANUFACTURER	MODEL NO.	SERIAL NO.	DATE OF CALIBRATION	DUE DATE OF CALIBRATION
Test Receiver ROHDE & SCHWARZ	ESI7	838496/016	Dec. 29, 2009	Dec. 28, 2010
Spectrum Analyzer ROHDE & SCHWARZ	FSP40	100039	Jan. 11, 2010	Jan. 10, 2011
BILOG Antenna SCHWARZBECK	VULB9168	9168-155	Apr. 28, 2010	Apr. 27, 2011
HORN Antenna SCHWARZBECK	BBHA 9120D	9120D-408	Jan. 05, 2010	Jan. 04, 2011
HORN Antenna SCHWARZBECK	BBHA 9170	BBHA9170242	Dec. 25, 2009	Dec. 24, 2010
Preamplifier Agilent	8449B	3008A01961	Nov. 02, 2010	Nov. 01, 2011
Preamplifier Agilent	8447D	2944A10738	Nov. 02, 2010	Nov. 01, 2011
RF signal cable HUBER+SUHNNER	SUCOFLEX 104	274041/4	Aug. 21, 2010	Aug. 20, 2011
RF signal cable HUBER+SUHNNER	SUCOFLEX 104	283397/4	Aug. 21, 2010	Aug. 20, 2011
Software ADT.	ADT_Radiated_ V7.6.15.9.2	NA	NA	NA
Antenna Tower inn-co GmbH	MA 4000	010303	NA	NA
Antenna Tower Controller inn-co GmbH	CO2000	019303	NA	NA
Turn Table ADT.	TT100.	TT93021704	NA	NA
Turn Table Controller ADT.	SC100.	SC93021704	NA	NA
26GHz ~ 40GHz Amplifier	EM26400	07026401	Aug. 25, 2010	Aug. 24, 2011

NOTE: The calibration interval of the above test instruments is 12 months and the calibrations are traceable to NML/ROC and NIST/USA.



A D T

5.6.3 TEST PROCEDURE

- a. The EUT was placed on the top of a rotating table 0.8 meters above the ground at a 3 meter semi-anechoic chamber. The table was rotated 360 degrees to determine the position of the highest radiation.
- b. The EUT was set 3 meters away from the interference-receiving antenna, which was mounted on the top of a variable-height antenna tower.
- c. The antenna is a broadband antenna, and its height is varied from one meter to four meters above the ground to determine the maximum value of the field strength. Both horizontal and vertical polarizations of the antenna are set to make the measurement.
- d. For each suspected emission, the EUT was arranged to its worst case and then the antenna was tuned to heights from 1 meter to 4 meters and the rotatable table was turned from 0 degrees to 360 degrees to find the maximum reading.
- e. Set both RBW and VBW of spectrum analyzer to 100kHz and 300kHz with suitable frequency span including 100MHz bandwidth from band edge. The band edges was measured and recorded.

NOTE: The resolution bandwidth of test receiver/spectrum analyzer is 1MHz and the video bandwidth is 1kHz for Average detection (AV) at frequency above 1GHz.



A D T

5.6.4 DEVIATION FROM TEST STANDARD

No deviation.

5.6.5 EUT OPERATING CONDITION

Same as Item 5.3.6.

5.6.6 TEST RESULTS

The spectrum plots are attached on the following pages. D1 line indicates the highest level, D2 line indicates the 20dB offset below D1. It shows compliance with the requirement in part 15.247(d).



A D T

802.11a

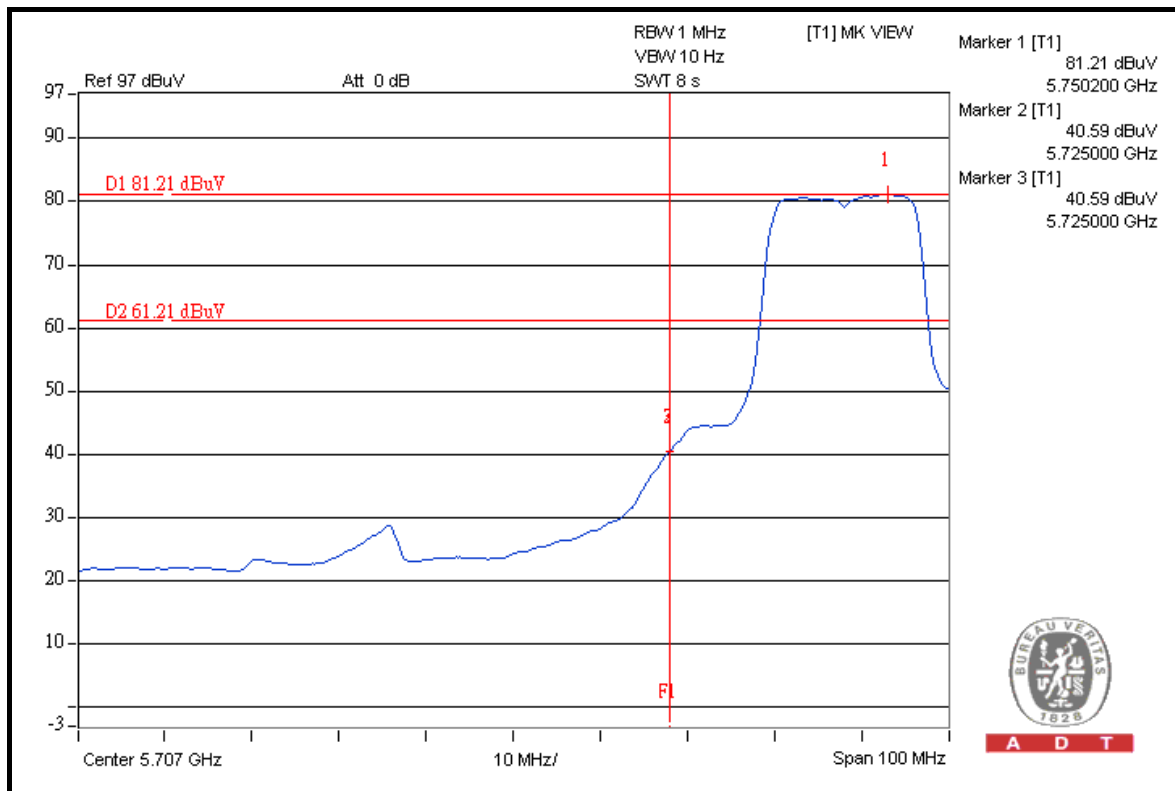
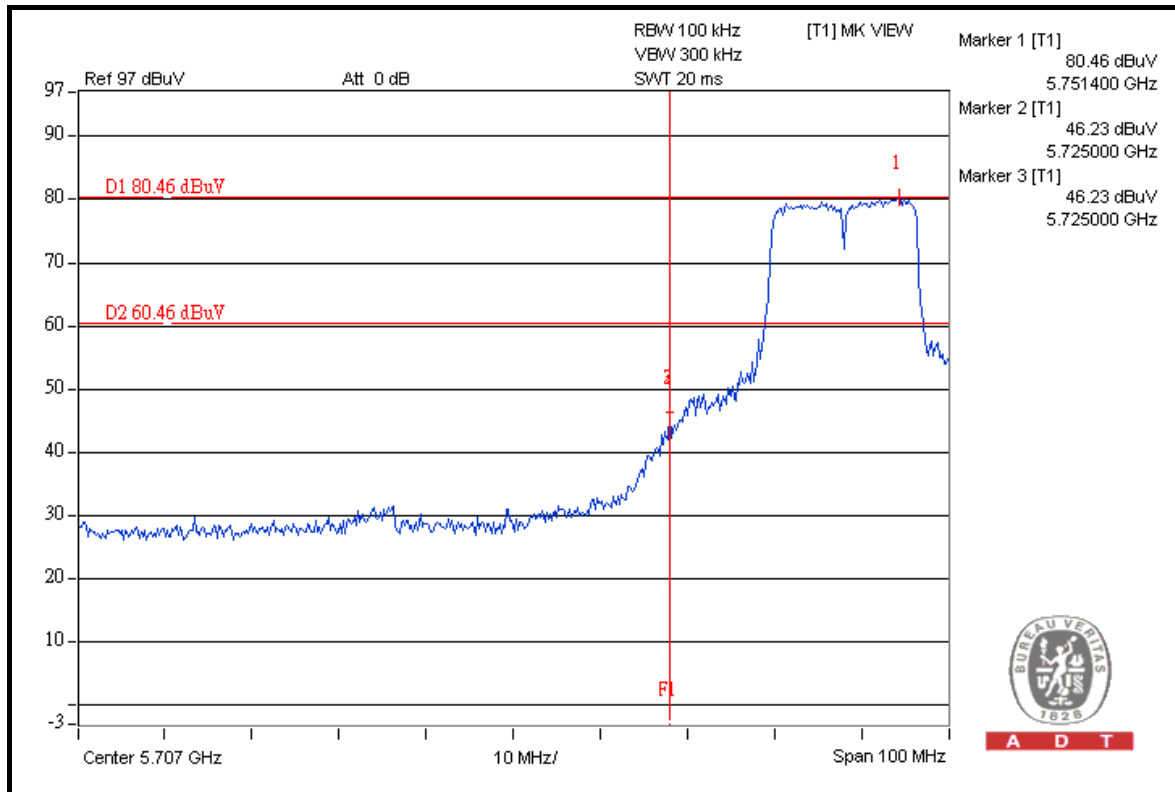



A D T

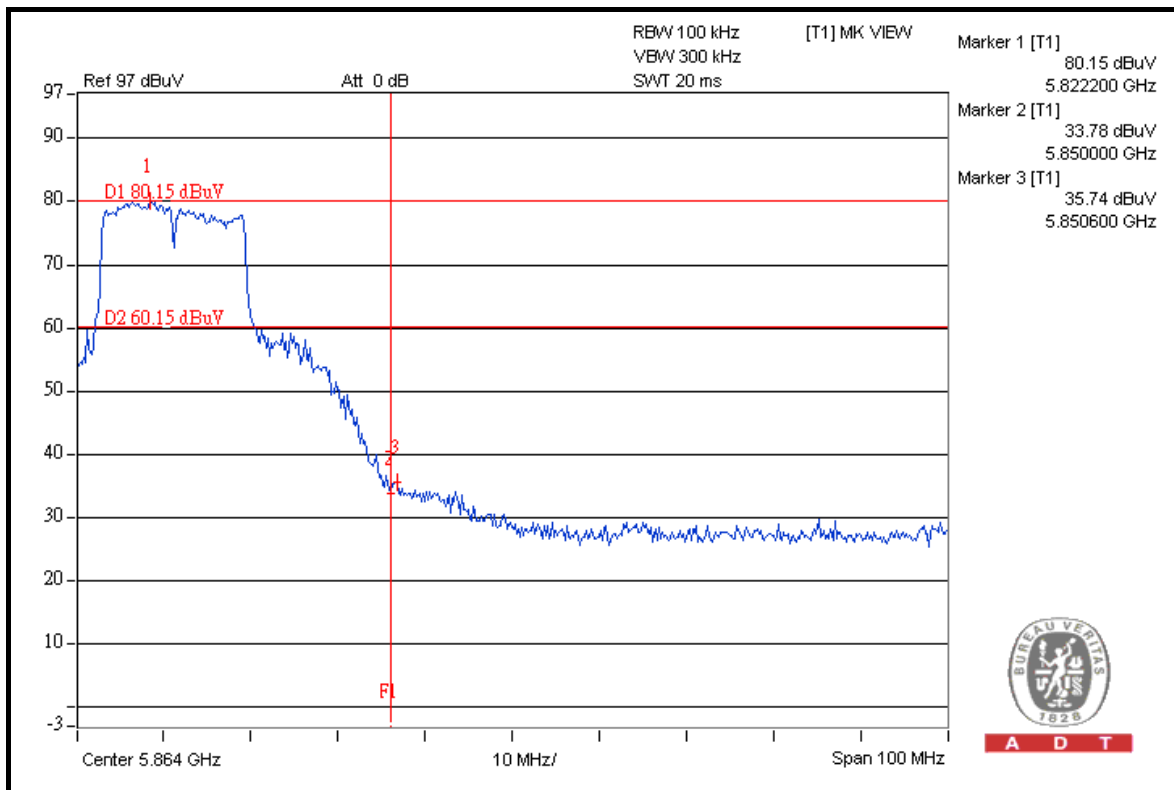
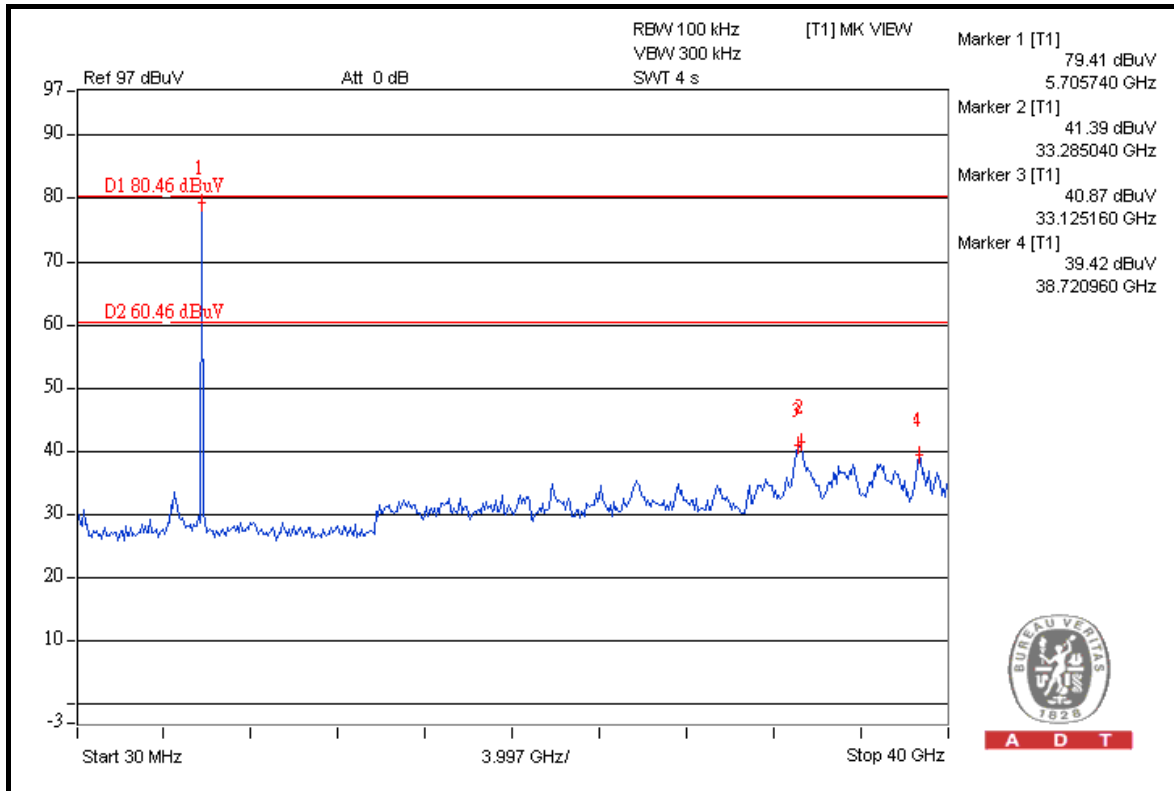



A D T

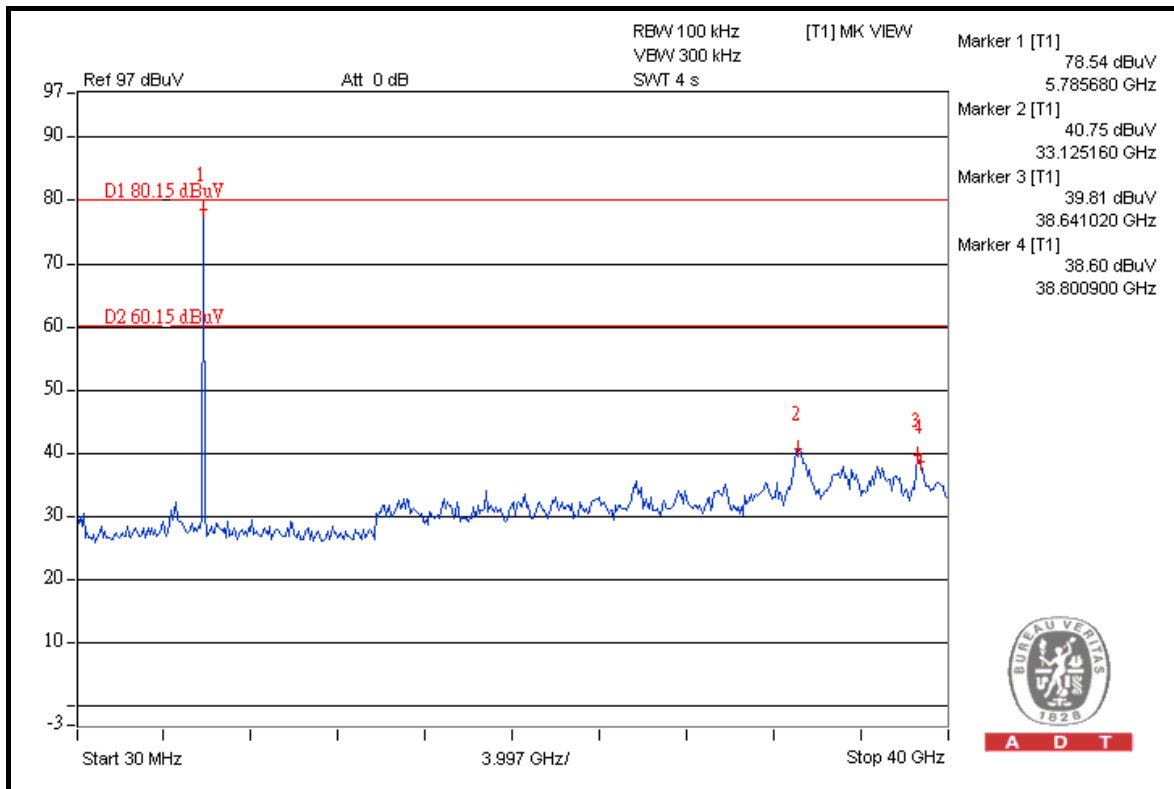
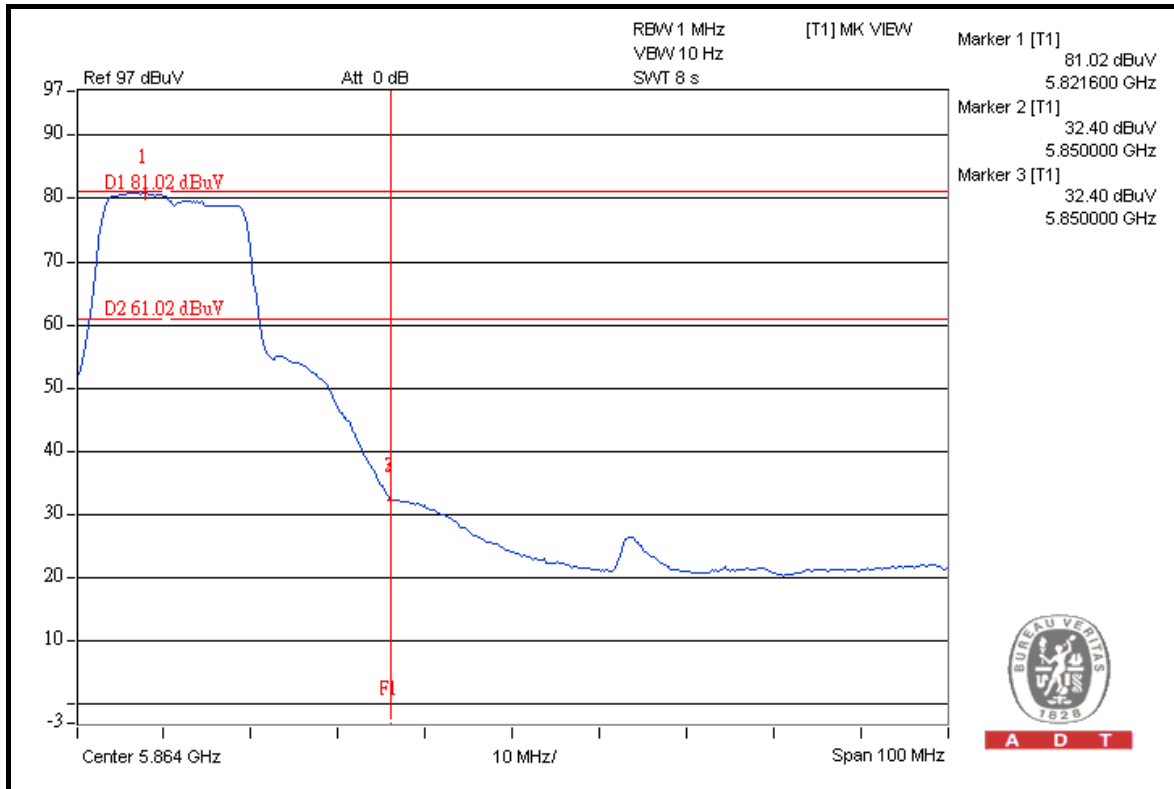



A D T

802.11n (20MHz)

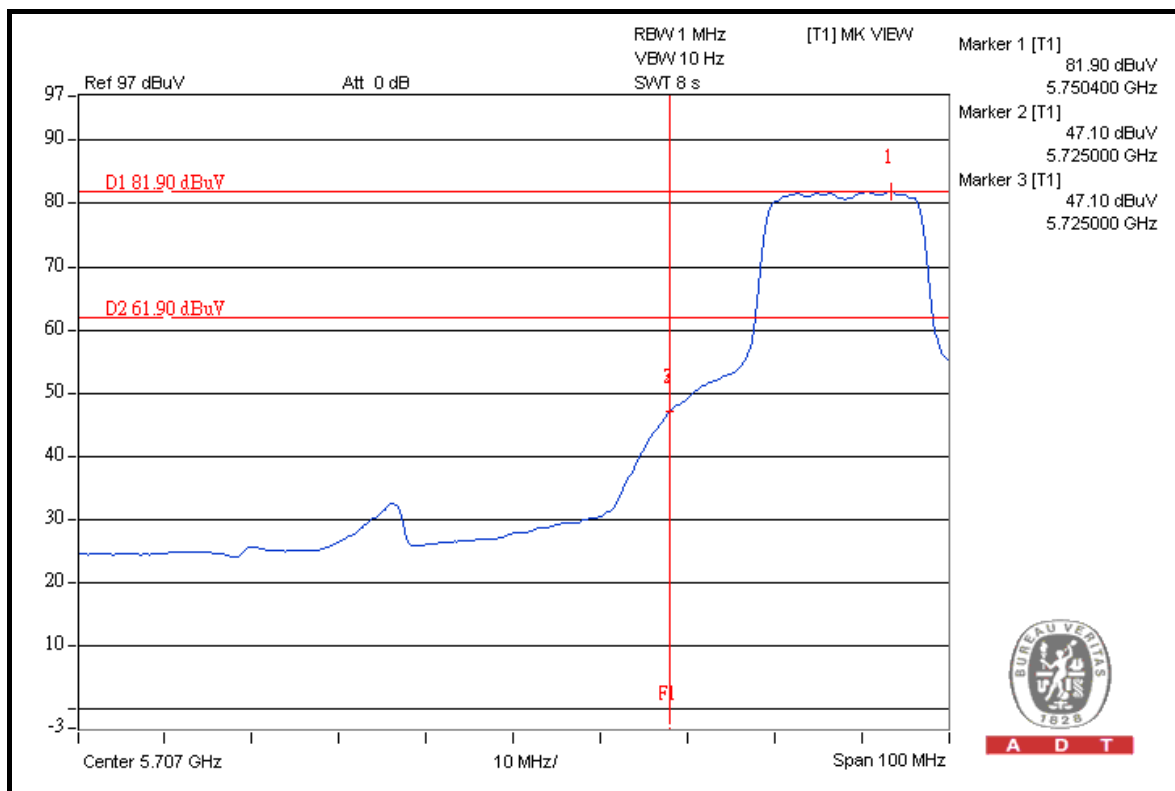
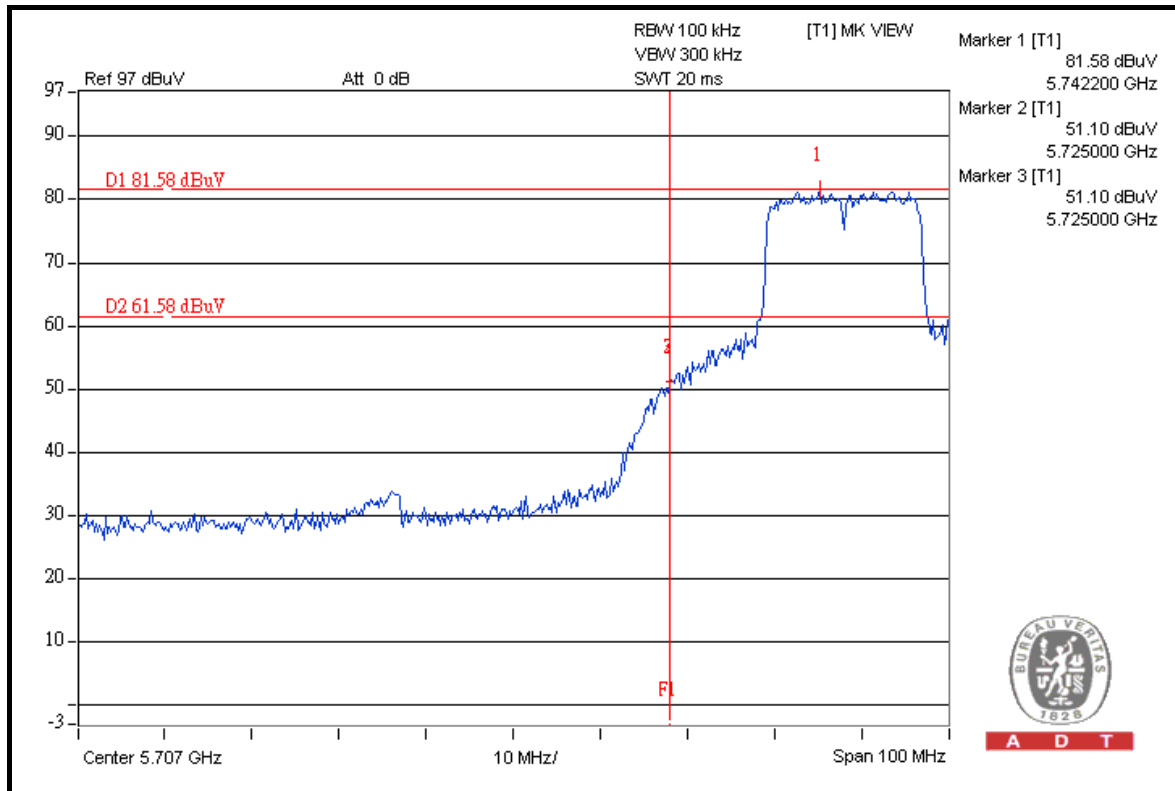



A D T

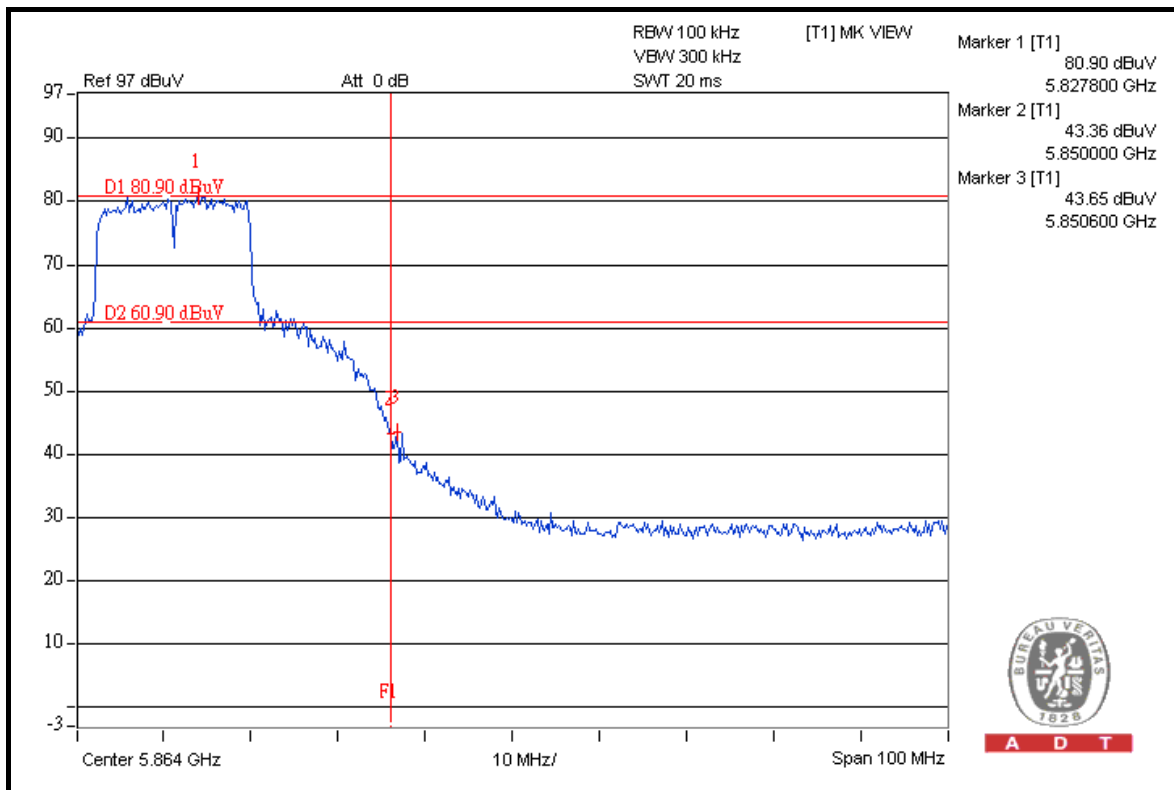
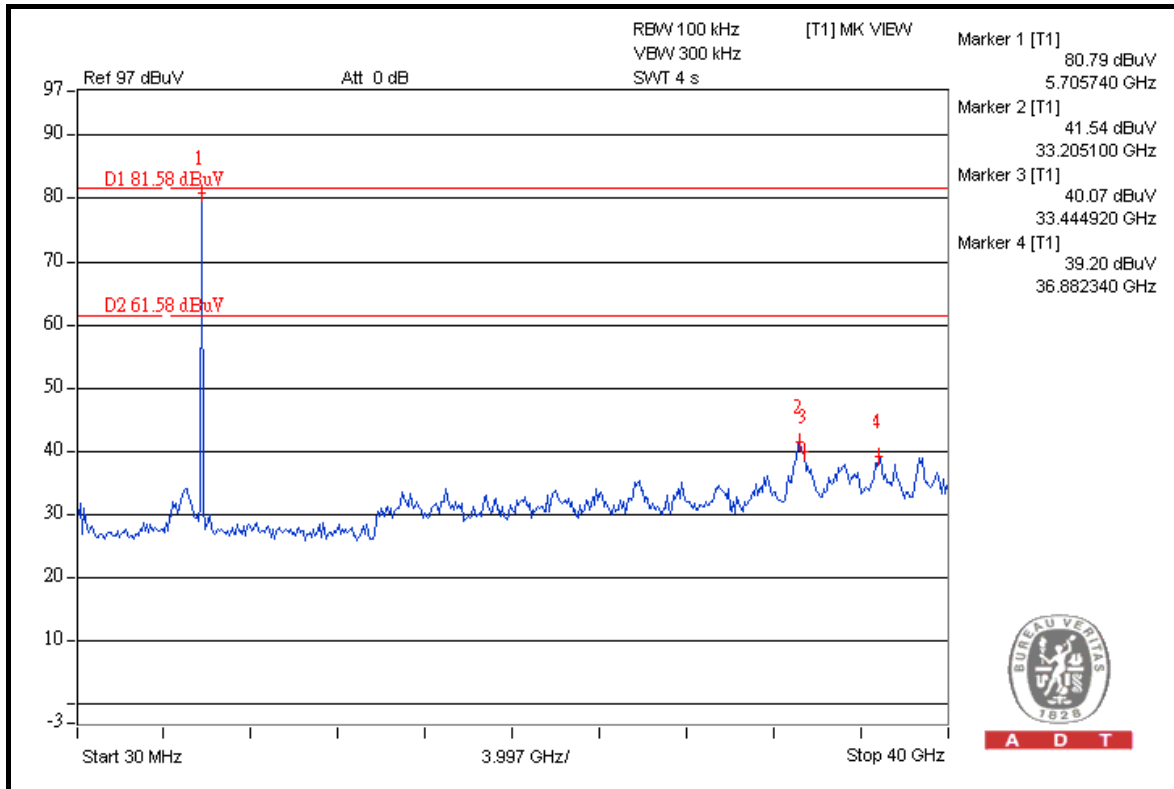



A D T

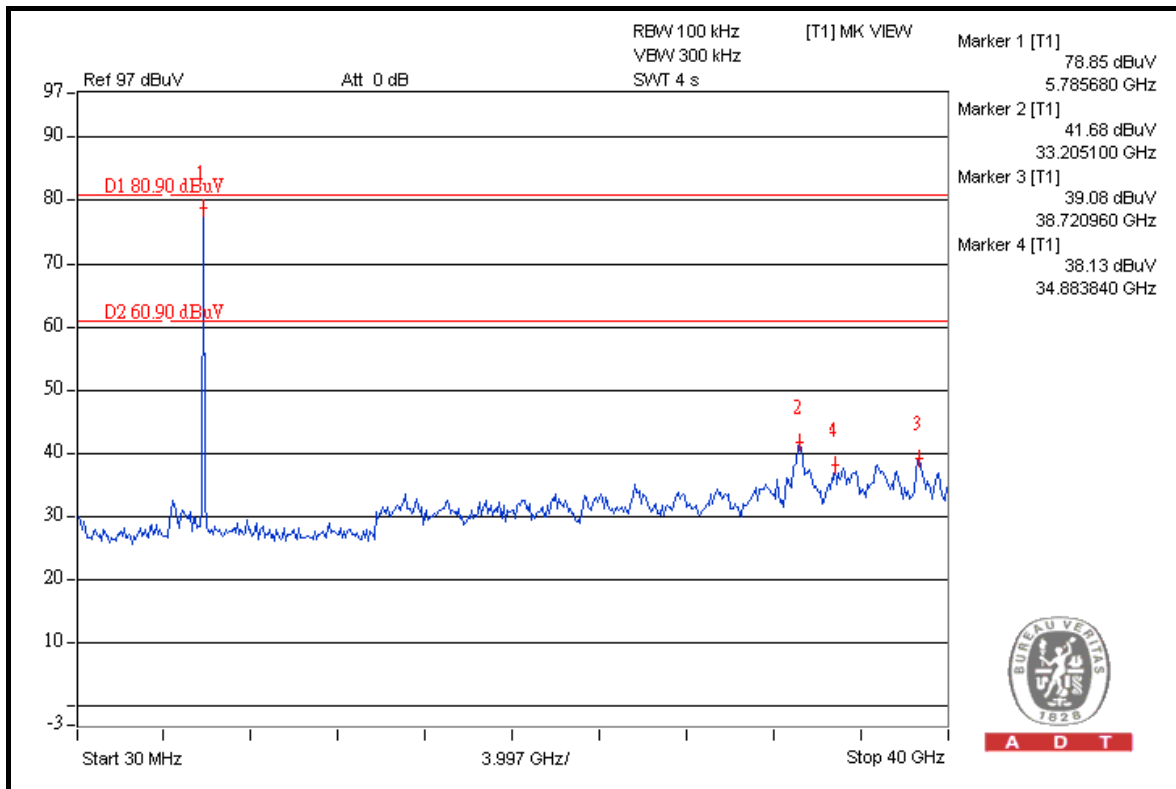
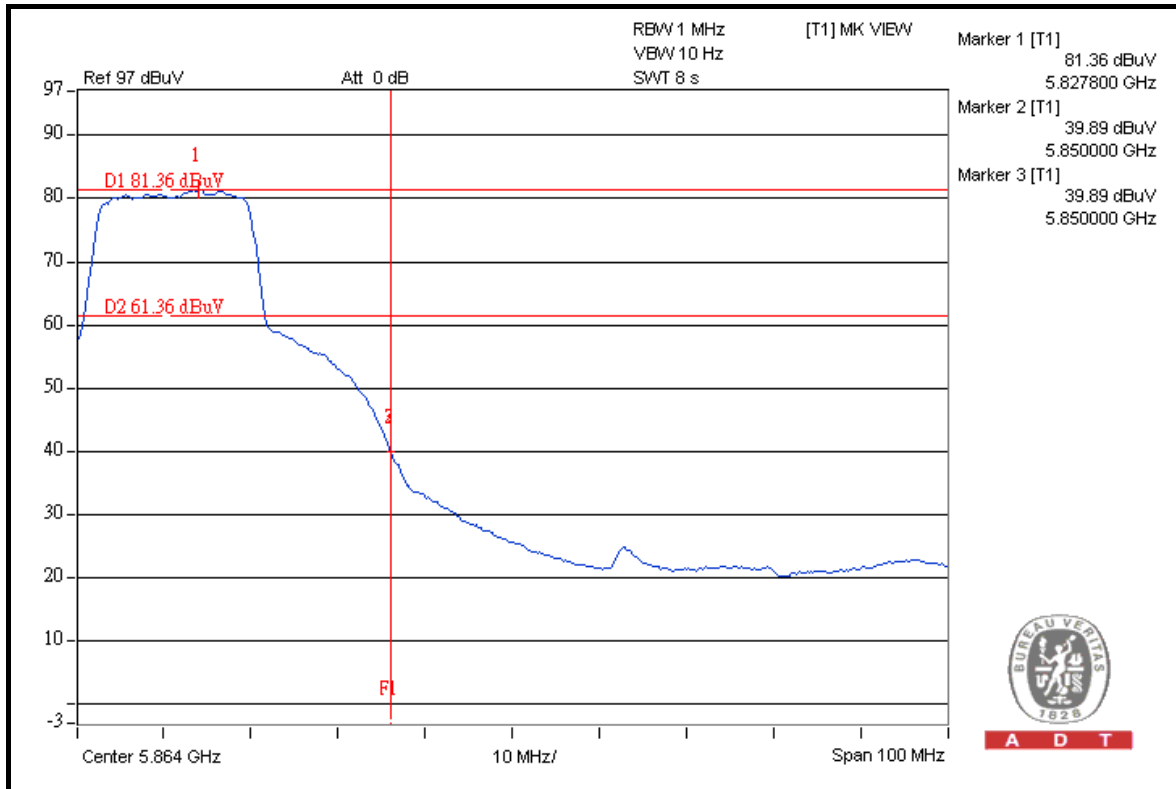



A D T

802.11n (40MHz)

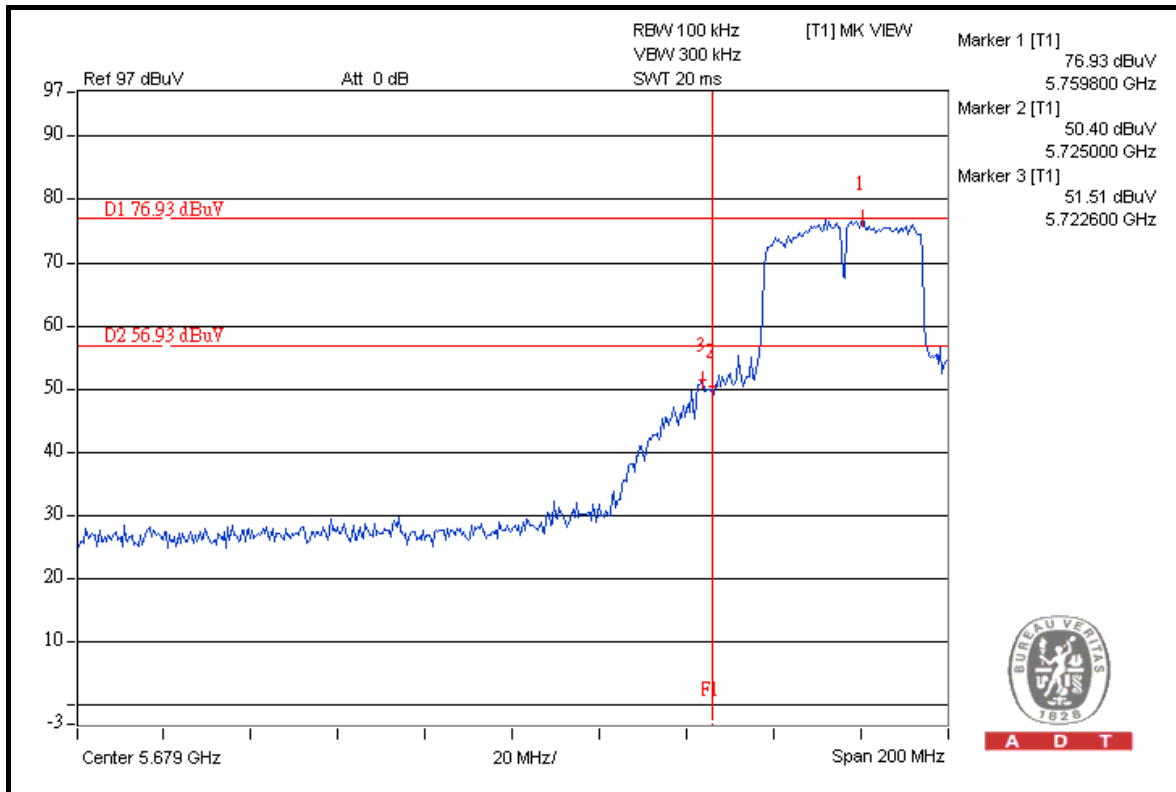

A D T

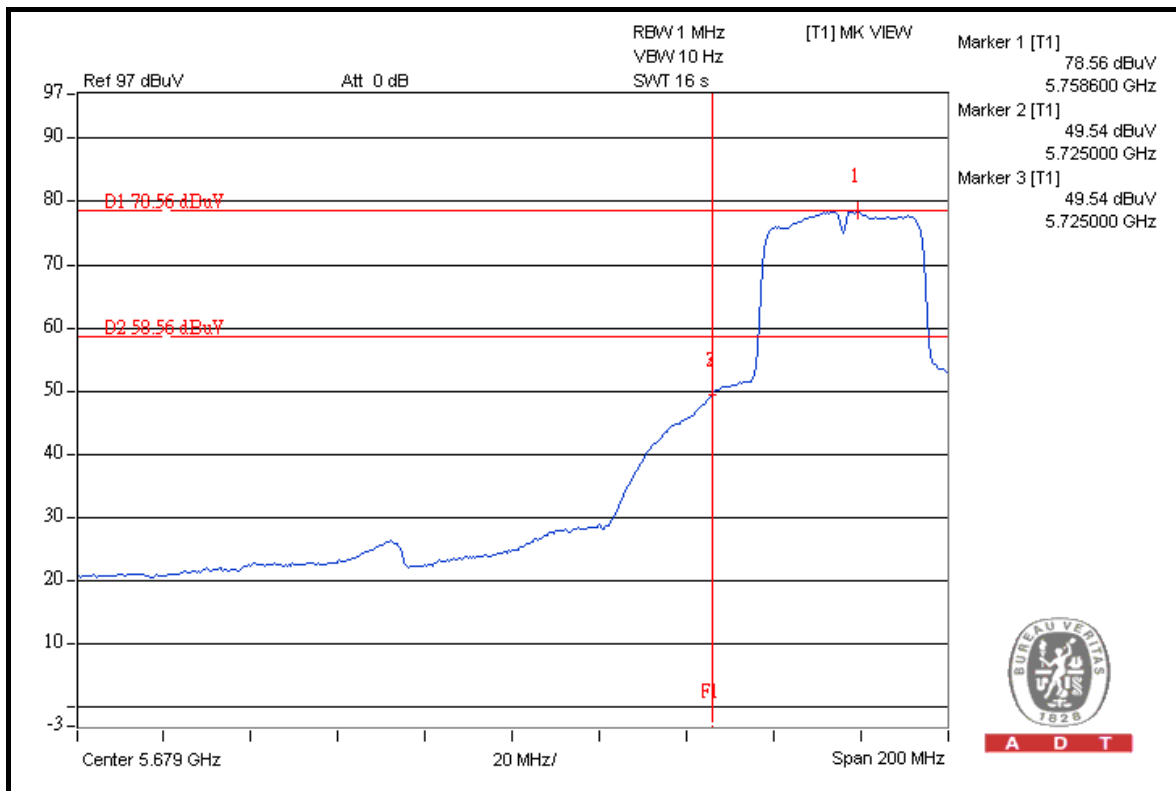

A D T



A D T

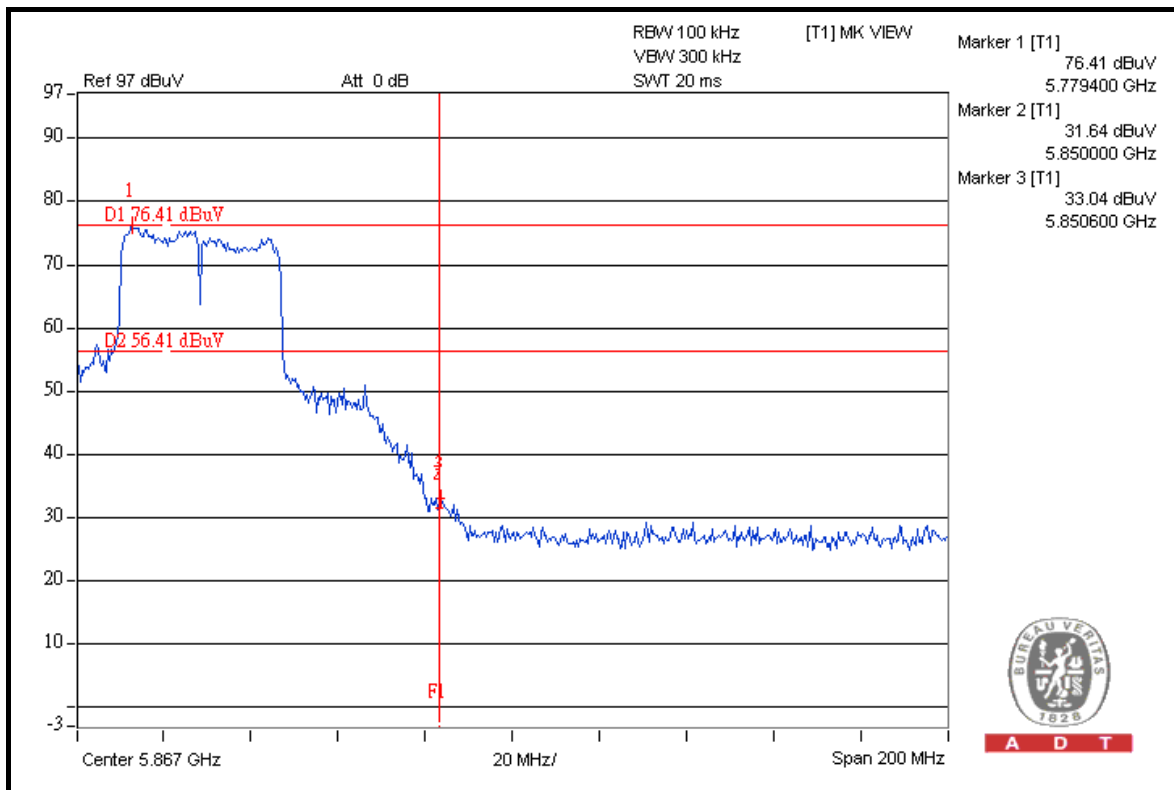
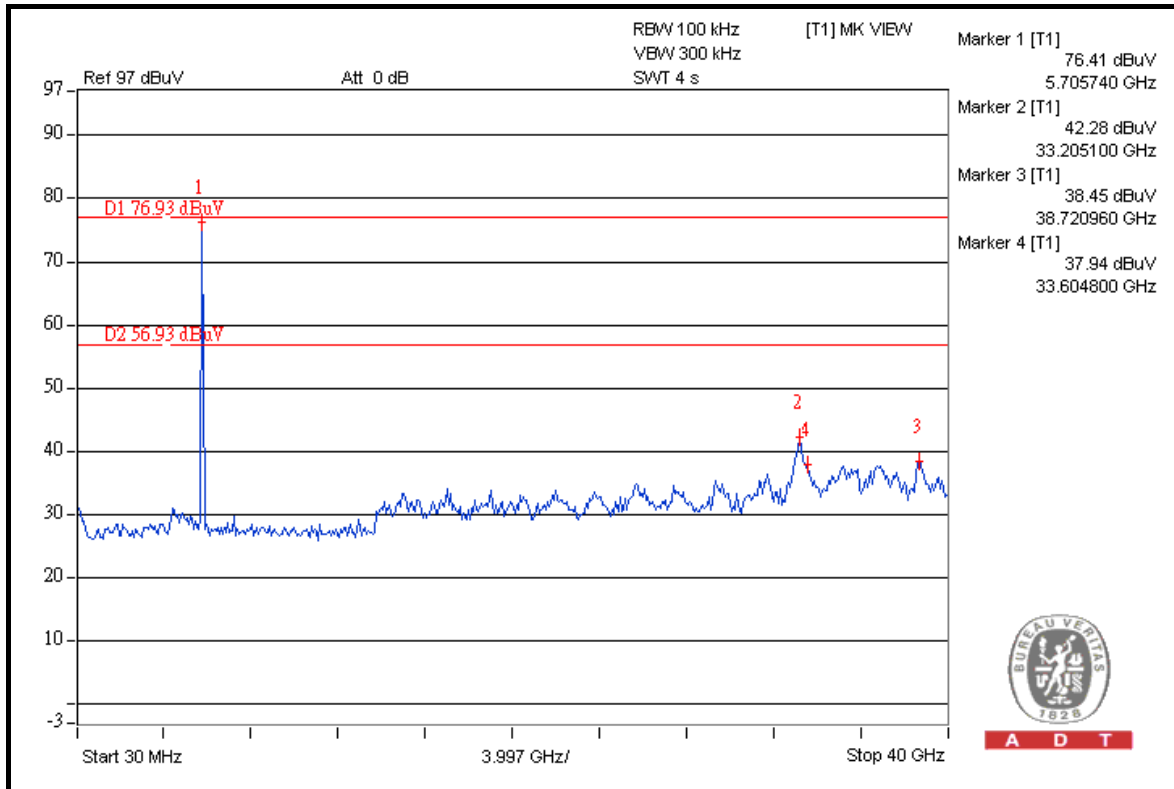



A D T

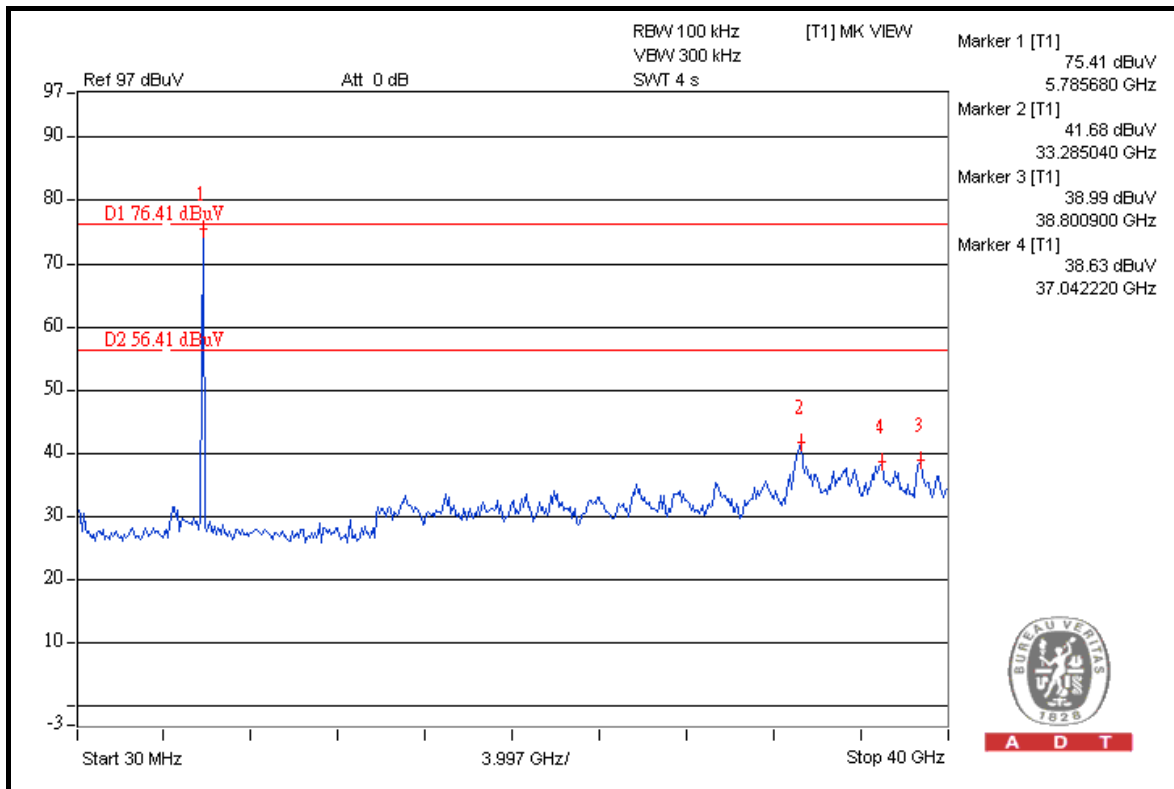
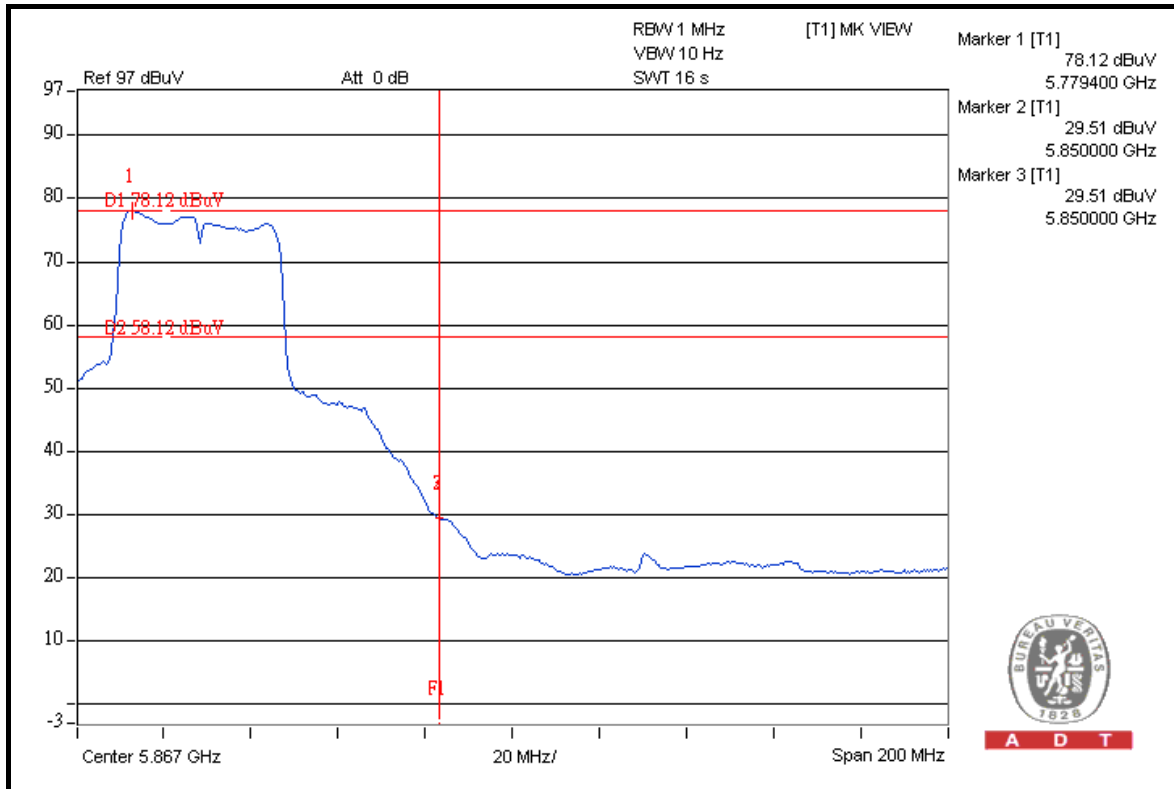



A D T

6. PHOTOGRAPHS OF THE TEST CONFIGURATION

Please refer to the attached file (Test Setup Photo).



A D T

7. INFORMATION ON THE TESTING LABORATORIES

We, Bureau Veritas Consumer Products Services (H.K.) Ltd., Taoyuan Branch, were founded in 1988 to provide our best service in EMC, Radio, Telecom and Safety consultation. Our laboratories are accredited and approved according to ISO/IEC 17025.

Copies of accreditation certificates of our laboratories obtained from approval agencies can be downloaded from our web site:

www.adt.com.tw/index.5/phtml. If you have any comments, please feel free to contact us at the following:

Linko EMC/RF Lab:

Tel: 886-2-26052180

Fax: 886-2-26051924

Hsin Chu EMC/RF Lab:

Tel: 886-3-5935343

Fax: 886-3-5935342

Hwa Ya EMC/RF/Safety Telecom Lab:

Tel: 886-3-3183232

Fax: 886-3-3185050

Web Site: www.adt.com.tw

The address and road map of all our labs can be found in our web site also.



A D T

8. APPENDIX A - MODIFICATIONS RECORDERS FOR ENGINEERING CHANGES TO THE EUT BY THE LAB

No any modifications are made to the EUT by the lab during the test.

---END---