



# FCC TEST REPORT

**REPORT NO.:** RF970103H02A

**MODEL NO.:** MBR1000

**RECEIVED:** Jan. 03, 2008

**TESTED:** Jan. 03 to 11, 2008

**ISSUED:** Jan. 15, 2008

**APPLICANT:** Cradlepoint, Inc

**ADDRESS:** 1199 Shoreline Lane, Suite 301 Boise, ID 83702

**ISSUED BY:** Advance Data Technology Corporation

**TEST LOCATION:** No. 81-1, Lu Liao Keng, 9 Ling, Wu Lung  
Tsuen, Chiung Lin Hsiang, Hsin Chu Hsien,  
Taiwan, R.O.C.

This test report consists of 105 pages in total. It may be duplicated completely for legal use with the approval of the applicant. It should not be reproduced except in full, without the written approval of our laboratory. The client should not use it to claim product endorsement by TAF, A2LA or any government agencies. The test results in the report only apply to the tested sample.



No. 2177-01

## Table of Contents

1.	CERTIFICATION .....	4
2.	SUMMARY OF TEST RESULTS .....	5
2.1	MEASUREMENT UNCERTAINTY .....	6
3.	GENERAL INFORMATION .....	7
3.1	GENERAL DESCRIPTION OF EUT .....	7
3.2	DESCRIPTION OF TEST MODES .....	9
3.2.1	TEST MODE APPLICABILITY AND TESTED CHANNEL DETAIL: .....	10
3.3	GENERAL DESCRIPTION OF APPLIED STANDARDS .....	14
3.4	DESCRIPTION OF SUPPORT UNITS .....	15
3.5	CONFIGURATION OF SYSTEM UNDER TEST .....	16
4.	TEST TYPES AND RESULTS .....	17
4.1	CONDUCTED EMISSION MEASUREMENT .....	17
4.1.1	LIMITS OF CONDUCTED EMISSION MEASUREMENT .....	17
4.1.2	TEST INSTRUMENTS .....	17
4.1.3	TEST PROCEDURES .....	18
4.1.4	DEVIATION FROM TEST STANDARD .....	18
4.1.5	TEST SETUP .....	19
4.1.6	EUT OPERATING CONDITIONS .....	19
4.1.7	TEST RESULTS .....	20
4.2	RADIATED EMISSION MEASUREMENT .....	24
4.2.1	LIMITS OF RADIATED EMISSION MEASUREMENT .....	24
4.2.2	TEST INSTRUMENTS .....	25
4.2.3	TEST PROCEDURES .....	26
4.2.4	DEVIATION FROM TEST STANDARD .....	26
4.2.5	TEST SETUP .....	27
4.2.6	EUT OPERATING CONDITIONS .....	27
4.2.7	TEST RESULTS .....	28
	Above 1GHz Test Data .....	29
4.2.8	TEST RESULTS .....	29
4.3	6dB BANDWIDTH MEASUREMENT .....	57
4.3.1	LIMITS OF 6dB BANDWIDTH MEASUREMENT .....	57
4.3.2	TEST INSTRUMENTS .....	57
4.3.3	TEST PROCEDURE .....	58
4.3.4	DEVIATION FROM TEST STANDARD .....	58
4.3.5	TEST SETUP .....	58
4.3.6	EUT OPERATING CONDITIONS .....	58



4.3.7	TEST RESULTS.....	59
4.4	MAXIMUM PEAK OUTPUT POWER.....	71
4.4.1	LIMITS OF MAXIMUM PEAK OUTPUT POWER MEASUREMENT.....	71
4.4.2	INSTRUMENTS.....	71
4.4.3	TEST PROCEDURES.....	72
4.4.4	DEVIATION FROM TEST STANDARD.....	72
4.4.5	TEST SETUP.....	72
4.4.6	EUT OPERATING CONDITIONS.....	72
4.4.7	TEST RESULTS.....	73
4.5	POWER SPECTRAL DENSITY MEASUREMENT.....	75
4.5.1	LIMITS OF POWER SPECTRAL DENSITY MEASUREMENT.....	75
4.5.2	TEST INSTRUMENTS.....	75
4.5.3	TEST PROCEDURE.....	76
4.5.4	DEVIATION FROM TEST STANDARD.....	76
4.5.5	TEST SETUP.....	76
4.5.6	EUT OPERATING CONDITION.....	76
4.5.7	TEST RESULTS.....	77
4.6	BAND EDGES MEASUREMENT.....	89
4.6.1	LIMITS OF BAND EDGES MEASUREMENT.....	89
4.6.2	TEST INSTRUMENTS.....	89
4.6.3	TEST PROCEDURE.....	89
4.6.4	DEVIATION FROM TEST STANDARD.....	90
4.6.5	EUT OPERATING CONDITION.....	90
4.6.6	TEST RESULTS.....	90
4.7	ANTENNA REQUIREMENT.....	103
4.7.1	STANDARD APPLICABLE.....	103
4.7.2	ANTENNA CONNECTED CONSTRUCTION.....	103
5.	INFORMATION ON THE TESTING LABORATORIES.....	104
6.	APPENDIX A - MODIFICATIONS RECORDERS FOR ENGINEERING CHANGES TO THE EUT BY THE LAB.....	105



# 1. CERTIFICATION

**PRODUCT:** Wireless-B/G/N Mobile Broadband Router  
**BRAND NAME:** Cradlepoint  
**MODEL NO.:** MBR1000  
**TESTED:** Jan. 03 to 11, 2008  
**TEST SAMPLE:** PROTOTYPE  
**APPLICANT:** Cradlepoint, Inc  
**STANDARDS:** FCC Part 15, Subpart C (Section 15.247),  
ANSI C63.4-2003

The above equipment (Model: MBR1000) has been tested by **Advance Data Technology Corporation**, and found compliance with the requirement of the above standards. The test record, data evaluation & Equipment Under Test (EUT) configurations represented herein are true and accurate accounts of the measurements of the sample's EMC characteristics under the conditions specified in this report.

**PREPARED BY :** Sunny Wen , **DATE:** Jan. 15, 2008  
( Sunny Wen, Specialist )

**TECHNICAL ACCEPTANCE :** Hank Chung , **DATE:** Jan. 15, 2008  
Responsible for RF ( Hank Chung, Deputy Manager )

**APPROVED BY :** May Chen , **DATE:** Jan. 15, 2008  
( May Chen, Deputy Manager )

## 2. SUMMARY OF TEST RESULTS

The EUT has been tested according to the following specifications:

<b>APPLIED STANDARD: FCC Part 15, Subpart C (Section 15.247)</b>			
<b>Standard Section</b>	<b>Test Type and Limit</b>	<b>Result</b>	<b>Remark</b>
15.207	AC Power Conducted Emission	PASS	Meet the requirement of limit. Minimum passing margin is -11.43dB at 0.193MHz
15.247(a)(2)	Spectrum Bandwidth of a Direct Sequence Spread Spectrum System Limit: min. 500kHz	PASS	Meet the requirement of limit.
15.247(b)	Maximum Peak Output Power Limit: max. 30dBm	PASS	Meet the requirement of limit.
15.247(d)	Radiated Emissions Limit: Table 15.209	PASS	Meet the requirement of limit. Minimum passing margin is -0.59 dB at 2487.98 MHz
15.247(e)	Power Spectral Density Limit: max. 8dBm	PASS	Meet the requirement of limit.
15.247(d)	Band Edge Measurement Limit: 20dB less than the peak value of fundamental frequency	PASS	Meet the requirement of limit.

## 2.1 MEASUREMENT UNCERTAINTY

Where relevant, the following measurement uncertainty levels have been estimated for tests performed on the EUT as specified in CISPR 16-4:

This uncertainty represents an expanded uncertainty expressed at approximately the 95% confidence level using a coverage factor of  $k=2$ .

Measurement	Value
Conducted emissions	2.44 dB
Radiated emissions (30MHz-1GHz)	3.94 dB
Radiated emissions (1GHz -18GHz)	2.33 dB
Radiated emissions (18GHz -40GHz)	2.55 dB

### 3. GENERAL INFORMATION

#### 3.1 GENERAL DESCRIPTION OF EUT

<b>PRODUCT</b>	Wireless-B/G/N Mobile Broadband Router
<b>MODEL NO.</b>	MBR1000
<b>FCC ID</b>	UXX-MBR1000
<b>POWER SUPPLY</b>	DC 12V from power adapter
<b>MODULATION TYPE</b>	CCK, DQPSK, DBPSK for DSSS 64QAM, 16QAM, QPSK, BPSK for OFDM
<b>MODULATION TECHNOLOGY</b>	DSSS, OFDM
<b>TRANSFER RATE</b>	802.11b: 11 / 5.5 / 2 / 1Mbps 802.11g: 54 / 48 / 36 / 24 / 18 / 12 / 9 / 6Mbps Draft 802.11n (20MHz): 144.444 / 130 / 115.556 / 86.667 / 57.778 / 43.333 / 28.889 / 14.444 / 72.2 / 65 / 57.8 / 43.3 / 28.9 / 21.7 / 14.4 / 7.2Mbps Draft 802.11n (40MHz): 300 / 270 / 240 / 180 / 150 / 135 / 120 / 90 / 60 / 45 / 30 / 15Mbps
<b>FREQUENCY RANGE</b>	802.11b & 802.11g: 2412 ~ 2462MHz
<b>NUMBER OF CHANNEL</b>	11 for 802.11b, 802.11g, draft 802.11n (20MHz) 7 for draft 802.11n (40MHz)
<b>MAXIMUM OUTPUT POWER</b>	802.11b: 83.176mW 802.11g: 107.647mW draft 802.11n (20MHz): 67.995mW draft 802.11n (40MHz): 64.930mW
<b>ANTENNA TYPE</b>	Please see note 1
<b>DATA CABLE</b>	NA
<b>I/O PORT</b>	USB Port x 1, WAN Port x 1, LAN Port x 4, USB port for 1XEV-DO x 1, Express card for 1XEV-DO Port x 1

#### NOTE:

- There are three antennas provided to this EUT, please refer to the following table:

Transmitter Circuit	Antenna Type	Antenna Connector	Gain(dBi)
Chain(0)	Dipole	IPEX	4
Chain(1)	Dipole	IPEX	4
Chain(2)	Dipole	IPEX	4

2. The EUT could be applied with one 3.5G 1XEV-DO Card and following two different models could be chosen; therefore emission tests are added for simultaneously transmit between wireless LAN and 3.5G 1XEV-DO function. The emission tests have been performed at the worst channel of both WLAN and 3.5G 1XEV-DO, and recorded in the report.

Interface	Brand name	Model name	FCC ID
Express card	KYOCERA	KPC680	OVFKWC-KPC680
USB port	C-motech	CDU-680	TARCDU-680

From the above 3.5G 1XEV-DO cards, Model No. : KPC680 was selected for testing. Only one card can transmit on different interface for 1XEV-DO.

3. The EUT incorporates a MIMO function with 802.11b, 802.11g, draft 802.11n. Physically, the EUT provides two completed transmit and three completed receivers.
4. The EUT is 2 \* 3 spatial MIMO without beam forming function. The antenna configurations are two transmitter antennas and three receiver antennas, as there are 3 Dipole antennas. Spatial multiplexing modes for simultaneous transmission using 2 antennas, and for simultaneous receiver using 3 antennas.
5. When the EUT operating in draft 802.11n, the software operation, which is defined by manufacturer, MCS (Modulation and Coding Schemes) from 0 to 15.
6. The EUT complies with draft 802.11n standards and backwards compatible with 802.11b, 802.11g products.
7. The EUT must be supplied with a power adapter and following two different models could be chosen:

Adapter 1	
<b>Brand:</b>	LEI
<b>Model No.:</b>	MU18-2120150-A1
<b>Input power :</b>	AC100-240V, 0.6A, 50/60Hz
<b>Output power :</b>	DC12V, 1.5A Cable:1.5m/unshielded/without core
Adapter 2	
<b>Brand:</b>	ELEMENTECH
<b>Model No.:</b>	Au-79Dmu
<b>Input power :</b>	AC100-240V, 0.5A, 50/60Hz
<b>Output power :</b>	DC12V, 1.5A Cable:1.3m/unshielded/without core

8. The EUT, operates in the 2.4GHz frequency range, lets you connect IEEE 802.11g or IEEE 802.11b and draft 802.11n technique devices to the network.
9. The above EUT information was declared by manufacturer and for more detailed features description, please refer to the manufacturer's specifications or user's manual.



### 3.2 DESCRIPTION OF TEST MODES

Eleven channels are provided for 802.11b, 802.11g, draft 802.11n (20MHz):

CHANNEL	FREQUENCY	CHANNEL	FREQUENCY
1	2412MHz	7	2442MHz
2	2417MHz	8	2447MHz
3	2422MHz	9	2452MHz
4	2427MHz	10	2457MHz
5	2432MHz	11	2462MHz
6	2437MHz		

Seven channels are provided for draft 802.11n (40MHz):

CHANNEL	FREQUENCY	CHANNEL	FREQUENCY
1	2422MHz	5	2442MHz
2	2427MHz	6	2447MHz
3	2432MHz	7	2452MHz
4	2437MHz		

### 3.2.1 TEST MODE APPLICABILITY AND TESTED CHANNEL DETAIL:

EUT CONFIGURE MODE	APPLICABLE TO				DESCRIPTION
	PLC	RE < 1G	RE ≥ 1G	APCM	
-	√	√	√	√	-

Where **PLC**: Power Line Conducted Emission

**RE < 1G**: Radiated Emission below 1GHz

**RE ≥ 1G**: Radiated Emission above 1GHz

**APCM**: Antenna Port Conducted Measurement

### ANTENNA COMBINATION MODE:

COMBINATION MODE	OPERATION MODE	TX CHAIN(0)	TX CHAIN(1)
A	802.11 b	√	
B	802.11 g	√	
C	DRAFT 802.11n(20MHz)	√	
D		√	√
E	DRAFT 802.11n(40MHz)	√	
F		√	√

**Note:**

1. The above information was declared by manufacturer and for more detailed features description, please refer to the manufacturer's specifications or user's manual.
2. From above mode, the different modes were chosen for pretest.
3. Mode A, B, D, F the worst modes, was selected as representative mode for the report.

### **POWER LINE CONDUCTED EMISSION TEST:**

- Pre-Scan has been conducted to determine the worst-case mode from all possible combinations between available modulations, data rates and antenna ports (if EUT with antenna diversity architecture).
- Following channel(s) was (were) selected for the final test as listed below.

MODE	AVAILABLE CHANNEL	TESTED CHANNEL	MODULATION TECHNOLOGY	MODULATION TYPE	DATA RATE (Mbps)	TX COMBINATION
802.11b	1 to 11	6	DSSS	DBPSK	1	B

- For conducted emissions, the EUT was tested as the following test modes:

Test Mode	Description
Mode A	Adapter 1
Mode B	Adapter 2

### **RADIATED EMISSION TEST (BELOW 1 GHz):**

- Pre-Scan has been conducted to determine the worst-case mode from all possible combinations between available modulations, data rates and antenna ports (if EUT with antenna diversity architecture).
- Following channel(s) was (were) selected for the final test as listed below.

MODE	AVAILABLE CHANNEL	TESTED CHANNEL	MODULATION TECHNOLOGY	MODULATION TYPE	DATA RATE (Mbps)	TX COMBINATION
802.11b	1 to 11	1	DSSS	DBPSK	1	A

- For spurious emissions, the EUT was pre-tested in chamber as the following test modes:

Test Mode	Description
Mode A	Adapter 1
Mode B	Adapter 2

The worst adapter was found in Adapter 1. Their test data were recorded in this report individually.

**RADIATED EMISSION TEST (ABOVE 1 GHz):**

- Pre-Scan has been conducted to determine the worst-case mode from all possible combinations between available modulations, data rates and antenna ports (if EUT with antenna diversity architecture).
- Following channel(s) was (were) selected for the final test as listed below.

MODE	AVAILABLE CHANNEL	TESTED CHANNEL	MODULATION TECHNOLOGY	MODULATION TYPE	DATA RATE (Mbps)	TX COMBINATION
802.11b	1 to 11	1, 6, 11	DSSS	DBPSK	1	A
802.11g	1 to 11	1, 6, 11	OFDM	BPSK	6	B
Draft 802.11n (20MHz)	1 to 11	1, 6, 11	OFDM	BPSK	7.2	D
Draft 802.11n (40MHz)	1 to 7	1, 4, 7	OFDM	BPSK	15	F

- For spurious emissions, the EUT was pre-tested in chamber as the following test modes:

Test Mode	Description
Mode A	Adapter 1
Mode B	Adapter 2

The worst adapter was found in Adapter 1. Their test data were recorded in this report individually.

**BANDEDGE MEASUREMENT:**

- Pre-Scan has been conducted to determine the worst-case mode from all possible combinations between available modulations, data rates and antenna ports (if EUT with antenna diversity architecture).
- Following channel(s) was (were) selected for the final test as listed below.

MODE	AVAILABLE CHANNEL	TESTED CHANNEL	MODULATION TECHNOLOGY	MODULATION TYPE	DATA RATE (Mbps)	TX COMBINATION
802.11b	1 to 11	1, 11	DSSS	DBPSK	1	A
802.11g	1 to 11	1, 11	OFDM	BPSK	6	B
Draft 802.11n (20MHz)	1 to 11	1, 11	OFDM	BPSK	7.2	D
Draft 802.11n (40MHz)	1 to 7	1, 7	OFDM	BPSK	15	F

**ANTENNA PORT CONDUCTED MEASUREMENT:**

- Pre-Scan has been conducted to determine the worst-case mode from all possible combinations between available modulations, data rates and antenna ports (if EUT with antenna diversity architecture).
- Following channel(s) was (were) selected for the final test as listed below.

MODE	AVAILABLE CHANNEL	TESTED CHANNEL	MODULATION TECHNOLOGY	MODULATION TYPE	DATA RATE (Mbps)	TX COMBINATION
802.11b	1 to 11	1, 6, 11	DSSS	CCK	11	A
802.11g	1 to 11	1, 6, 11	OFDM	BPSK	6	B
Draft 802.11n (20MHz)	1 to 11	1, 6, 11	OFDM	BPSK	7.2	D
Draft 802.11n (40MHz)	1 to 7	1, 4, 7	OFDM	BPSK	15	F



### **3.3 GENERAL DESCRIPTION OF APPLIED STANDARDS**

The EUT is a Wireless-B/G/N Mobile Broadband Router. According to the specifications of the manufacturer, it must comply with the requirements of the following standards:

**FCC Part 15, Subpart C. (15.247)**

**ANSI C63.4-2003**

All test items have been performed and recorded as per the above standards.

**NOTE:** The EUT is also considered as a kind of computer peripheral, because the connection to computer is necessary for typical use. It has been verified to comply with the requirements of FCC Part 15, Subpart B, Class B (DoC). The test report has been issued separately.



### 3.4 DESCRIPTION OF SUPPORT UNITS

The EUT has been tested as an independent unit together with other necessary accessories or support units. The following support units or accessories were used to form a representative test configuration during the tests.

NO.	PRODUCT	BRAND	MODEL NO.	SERIAL NO.	FCC ID
1	NOTEBOOK COMPUTER	DELL	PP18L	6976685584	DoC
2	NOTEBOOK COMPUTER	DELL	PP05L	CN-04Y212-48643-38E-0145	DoC
3	HUB	AVSYS	110H8	01-20E-000002	DoC

NO.	SIGNAL CABLE DESCRIPTION OF THE ABOVE SUPPORT UNITS
1	NA
2	NA
3	NA

**NOTE:** All power cords of the above support units are non shielded (1.8m).

### 3.5 CONFIGURATION OF SYSTEM UNDER TEST

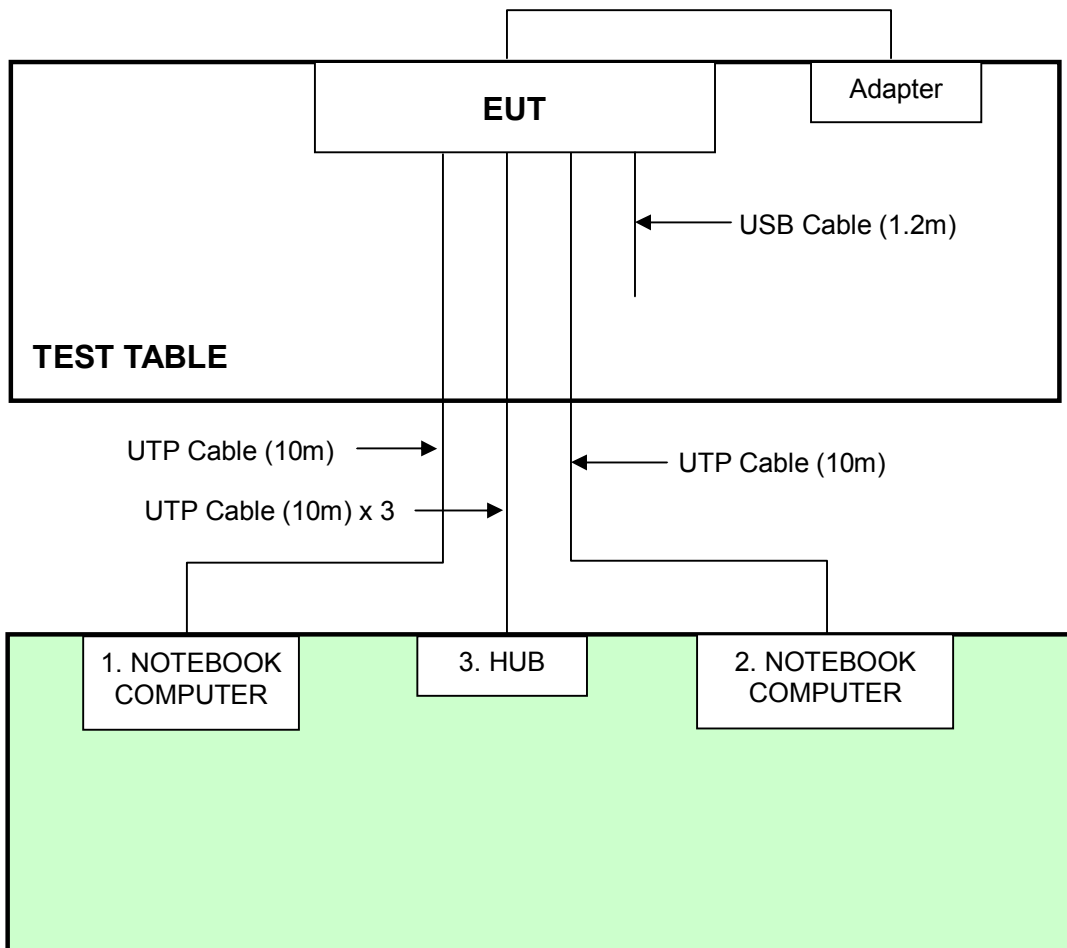



## 4. TEST TYPES AND RESULTS

### 4.1 CONDUCTED EMISSION MEASUREMENT

#### 4.1.1 LIMITS OF CONDUCTED EMISSION MEASUREMENT

FREQUENCY OF EMISSION (MHz)	CONDUCTED LIMIT (dB $\mu$ V)	
	Quasi-peak	Average
0.15-0.5	66 to 56	56 to 46
0.5-5	56	46
5-30	60	50

- NOTE:**
1. The lower limit shall apply at the transition frequencies.
  2. The limit decreases in line with the logarithm of the frequency in the range of 0.15 to 0.50 MHz.
  3. All emanations from a class A/B digital device or system, including any network of conductors and apparatus connected thereto, shall not exceed the level of field strengths specified above.

#### 4.1.2 TEST INSTRUMENTS

DESCRIPTION & MANUFACTURER	MODEL NO.	SERIAL NO.	CALIBRATED UNTIL
Test Receiver	ESCS 30	847124/029	Mar. 28, 2008
Line-Impedance Stabilization Network(for EUT)	ESH3-Z5	848773/004	Nov. 08, 2008
Line-Impedance Stabilization Network(for Peripheral)	ENV-216	100071	Nov. 26, 2008
RF Cable (JETBAO)	RG233/U	Cable_CB_01	Dec. 09, 2008
50 ohms Terminator	50	3	Nov. 15, 2008
Software	ADT_Cond_V7.3.2	NA	NA

- NOTE:**
1. The calibration interval of the above test instruments is 12 months and the calibrations are traceable to NML/ROC and NIST/USA.
  2. The test was performed in ADT Shielded Room No. B.
  3. The VCCI Con B Registration No. is C-2193.

#### 4.1.3 TEST PROCEDURES

- a. The EUT was placed 0.4 meters from the conducting wall of the shielded room with EUT being connected to the power mains through a line impedance stabilization network (LISN). Other support units were connected to the power mains through another LISN. The two LISNs provide 50 ohm/ 50uH of coupling impedance for the measuring instrument.
- b. Both lines of the power mains connected to the EUT were checked for maximum conducted interference.
- c. The frequency range from 150kHz to 30MHz was searched. Emission levels under (Limit - 20dB) were not recorded.

#### 4.1.4 DEVIATION FROM TEST STANDARD

No deviation

#### 4.1.5 TEST SETUP

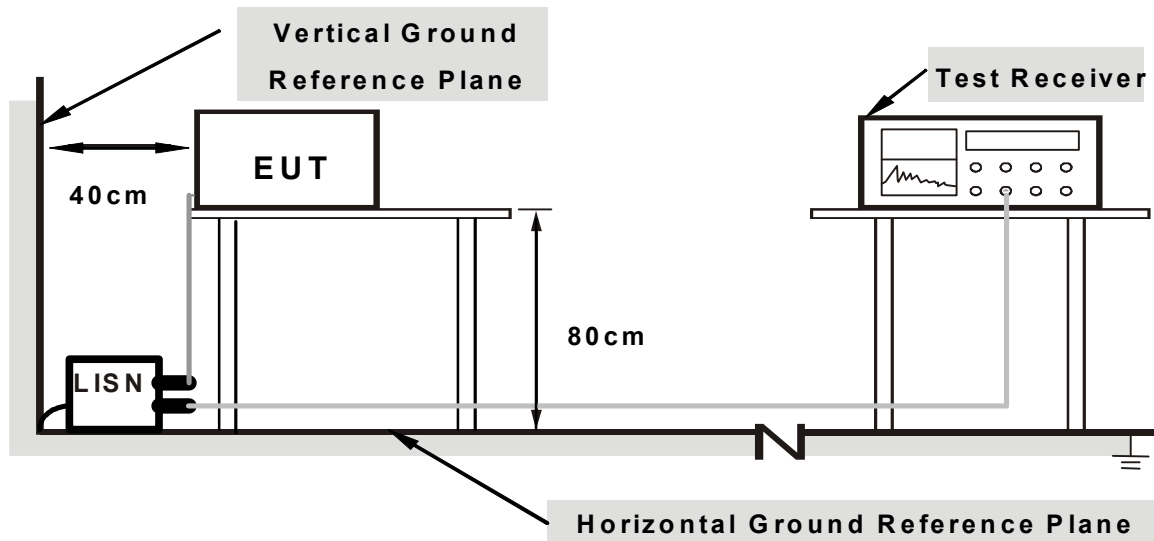

**Note: 1. Support units were connected to second LISN.**

**2. Both of LISNs (AMN) are 80 cm from EUT and at least 80 from other units and other metal planes**

For the actual test configuration, please refer to the related item – Photographs of the Test Configuration.

#### 4.1.6 EUT OPERATING CONDITIONS

1. Placed the EUT on testing table.
2. Prepared other computer systems (support unit 1 ~ 2) to act as communication partners and placed them outside of testing area.
3. The communication partners run test program “Web Control” to enable EUT under transmission/receiving condition continuously via UTP cables and wireless transmission.

#### 4.1.7 TEST RESULTS

#### 802.11b DSSS MODULATION : WITH ADAPTER 1

EUT TEST CONDITION		MEASUREMENT DETAIL	
CHANNEL	Channel 6	PHASE	Line (L)
MODULATION TYPE	DBPSK	6dB BANDWIDTH	9 kHz
TRANSFER RATE	1Mbps	INPUT POWER (SYSTEM)	120Vac, 60 Hz
ENVIRONMENTAL CONDITIONS	26deg. C, 54%RH, 975hPa	TESTED BY	Rex Huang

No	Freq. [MHz]	Corr. Factor (dB)	Reading Value [dB (uV)]		Emission Level [dB (uV)]		Limit [dB (uV)]		Margin (dB)	
			Q.P.	AV.	Q.P.	AV.	Q.P.	AV.	Q.P.	AV.
	1	0.193	0.16	52.32	-	52.48	-	63.91	53.91	-11.43
2	0.455	0.18	44.62	-	44.80	-	56.79	46.79	-11.99	-
3	0.779	0.24	41.12	-	41.36	-	56.00	46.00	-14.64	-
4	1.685	0.36	41.79	-	42.15	-	56.00	46.00	-13.85	-
5	6.215	0.53	45.00	-	45.53	-	60.00	50.00	-14.47	-
6	9.934	0.84	38.43	-	39.27	-	60.00	50.00	-20.73	-

- REMARKS:**
1. Q.P. and AV. are abbreviations of quasi-peak and average individually.
  2. "-": The Quasi-peak reading value also meets average limit and measurement with the average detector is unnecessary.
  3. The emission levels of other frequencies were very low against the limit.
  4. Margin value = Emission level - Limit value
  5. Correction factor = Insertion loss + Cable loss
  6. Emission Level = Correction Factor + Reading Value.

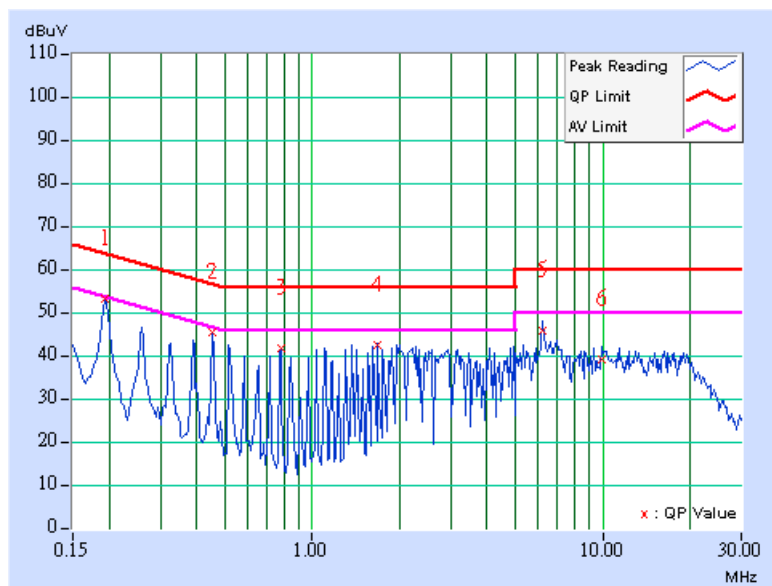

EUT TEST CONDITION		MEASUREMENT DETAIL	
CHANNEL	Channel 6	PHASE	Neutral (N)
MODULATION TYPE	DBPSK	6dB BANDWIDTH	9 kHz
TRANSFER RATE	1Mbps	INPUT POWER (SYSTEM)	120Vac, 60 Hz
ENVIRONMENTAL CONDITIONS	26deg. C, 54%RH, 975hPa	TESTED BY	Rex Huang

No	Freq. [MHz]	Corr. Factor (dB)	Reading Value [dB (uV)]		Emission Level [dB (uV)]		Limit [dB (uV)]		Margin (dB)	
			Q.P.	AV.	Q.P.	AV.	Q.P.	AV.	Q.P.	AV.
	1	0.193	0.08	51.55	-	51.63	-	63.91	53.91	-12.28
2	0.455	0.09	43.82	-	43.91	-	56.79	46.79	-12.88	-
3	2.920	0.30	43.01	-	43.31	-	56.00	46.00	-12.69	-
4	4.148	0.29	41.49	-	41.78	-	56.00	46.00	-14.22	-
5	6.580	0.50	44.44	-	44.94	-	60.00	50.00	-15.06	-
6	11.493	0.88	39.13	-	40.01	-	60.00	50.00	-19.99	-

- REMARKS:**
1. Q.P. and AV. are abbreviations of quasi-peak and average individually.
  2. "-": The Quasi-peak reading value also meets average limit and measurement with the average detector is unnecessary.
  3. The emission levels of other frequencies were very low against the limit.
  4. Margin value = Emission level - Limit value
  5. Correction factor = Insertion loss + Cable loss
  6. Emission Level = Correction Factor + Reading Value.

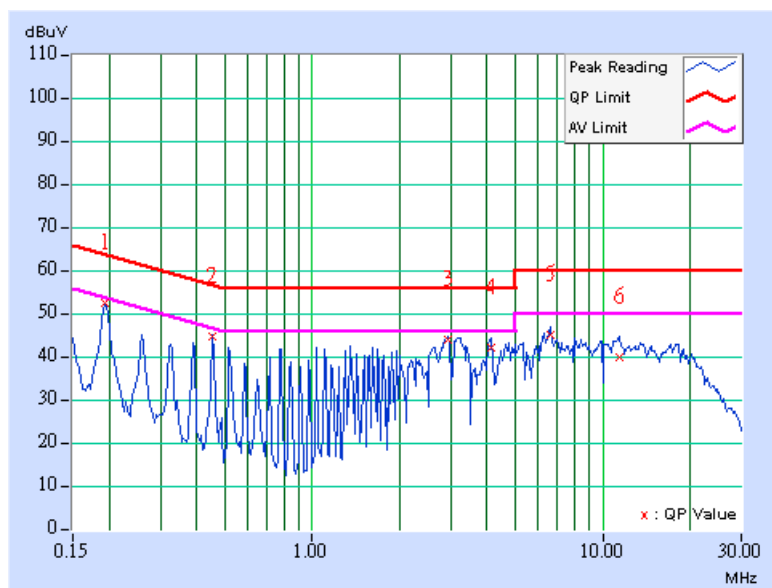

## 802.11b DSSS MODULATION: WITH ADAPTER 2

EUT TEST CONDITION		MEASUREMENT DETAIL	
CHANNEL	Channel 6	PHASE	Line (L)
MODULATION TYPE	DBPSK	6dB BANDWIDTH	9 kHz
TRANSFER RATE	1Mbps	INPUT POWER (SYSTEM)	120Vac, 60 Hz
ENVIRONMENTAL CONDITIONS	26deg. C, 54%RH, 975hPa	TESTED BY	Rex Huang

No	Freq. [MHz]	Corr. Factor (dB)	Reading Value [dB (uV)]		Emission Level [dB (uV)]		Limit [dB (uV)]		Margin (dB)	
			Q.P.	AV.	Q.P.	AV.	Q.P.	AV.	Q.P.	AV.
	1	0.181	0.15	43.87	-	44.02	-	64.43	54.43	-20.40
2	0.244	0.16	43.49	-	43.65	-	61.97	51.97	-18.32	-
3	0.486	0.19	39.16	-	39.35	-	56.24	46.24	-16.89	-
4	2.482	0.39	36.46	-	36.85	-	56.00	46.00	-19.15	-
5	15.973	1.25	31.91	-	33.16	-	60.00	50.00	-26.84	-
6	20.234	1.38	29.76	-	31.14	-	60.00	50.00	-28.86	-

- REMARKS:**
1. Q.P. and AV. are abbreviations of quasi-peak and average individually.
  2. "-": The Quasi-peak reading value also meets average limit and measurement with the average detector is unnecessary.
  3. The emission levels of other frequencies were very low against the limit.
  4. Margin value = Emission level - Limit value
  5. Correction factor = Insertion loss + Cable loss
  6. Emission Level = Correction Factor + Reading Value.

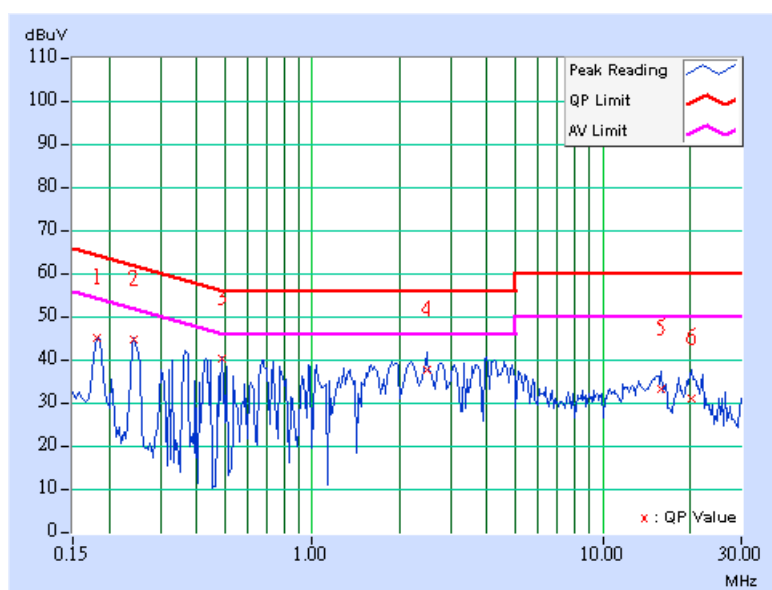

EUT TEST CONDITION		MEASUREMENT DETAIL	
CHANNEL	Channel 6	PHASE	Neutral (N)
MODULATION TYPE	DBPSK	6dB BANDWIDTH	9 kHz
TRANSFER RATE	1Mbps	INPUT POWER (SYSTEM)	120Vac, 60 Hz
ENVIRONMENTAL CONDITIONS	26deg. C, 54%RH, 975hPa	TESTED BY	Rex Huang

No	Freq. [MHz]	Corr. Factor (dB)	Reading Value [dB (uV)]		Emission Level [dB (uV)]		Limit [dB (uV)]		Margin (dB)	
			Q.P.	AV.	Q.P.	AV.	Q.P.	AV.	Q.P.	AV.
	1	0.180	0.08	43.08	-	43.16	-	64.49	54.49	-21.33
2	0.240	0.08	41.84	-	41.92	-	62.10	52.10	-20.18	-
3	1.016	0.19	37.27	-	37.46	-	56.00	46.00	-18.54	-
4	2.437	0.31	33.84	-	34.15	-	56.00	46.00	-21.85	-
5	14.930	1.13	37.95	-	39.08	-	60.00	50.00	-20.92	-
6	20.520	1.29	32.98	-	34.27	-	60.00	50.00	-25.73	-

- REMARKS:**
1. Q.P. and AV. are abbreviations of quasi-peak and average individually.
  2. "-": The Quasi-peak reading value also meets average limit and measurement with the average detector is unnecessary.
  3. The emission levels of other frequencies were very low against the limit.
  4. Margin value = Emission level - Limit value
  5. Correction factor = Insertion loss + Cable loss
  6. Emission Level = Correction Factor + Reading Value.

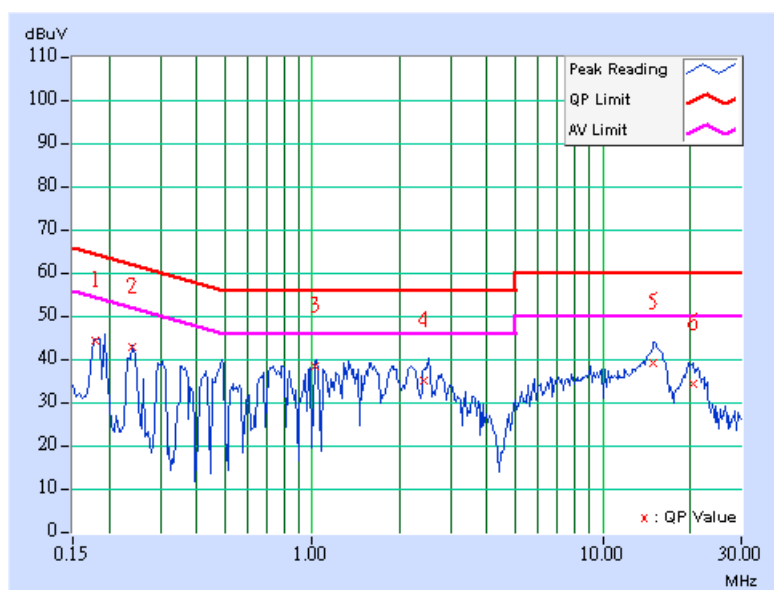

## 4.2 RADIATED EMISSION MEASUREMENT

### 4.2.1 LIMITS OF RADIATED EMISSION MEASUREMENT

Emissions radiated outside of the specified bands, shall be according to the general radiated limits in 15.209 as following:

Frequencies (MHz)	Field strength (microvolts/meter)	Measurement distance (meters)
0.009-0.490	2400/F(kHz)	300
0.490-1.705	24000/F(kHz)	30
1.705-30.0	30	30
30-88	100	3
88-216	150	3
216-960	200	3
Above 960	500	3

**NOTE:**

1. The lower limit shall apply at the transition frequencies.
2. Emission level (dBuV/m) = 20 log Emission level (uV/m).
3. As shown in 15.35(b), for frequencies above 1000MHz, the field strength limits are based on average detector, however, the peak field strength of any emission shall not exceed the maximum permitted average limits, specified above by more than 20dB under any condition of modulation.





#### 4.2.2 TEST INSTRUMENTS

DESCRIPTION & MANUFACTURER	MODEL NO.	SERIAL NO.	CALIBRATED UNTIL
Spectrum Analyzer R&S FSP 40	FSP40	100060	Apr.20,2008
HP Pre_Amplifier	8449B	3008A01922	Oct. 04, 2008
ROHDE & SCHWARZ Test Receiver	ESCS30	100375	Mar. 26, 2008
SCHWARZBECK TRILOG Broadband Antenna	VULB 9168	138	July 26, 2008
Schwarzbeck Horn_Antenna	BBHA9120	D124	Dec.16, 2008
Schwarzbeck Horn_Antenna	BBHA 9170	BBHA9170153	Jan. 25, 2008
R&S Loop Antenna	HFH2-Z2	881058/15	Nov. 29, 2008
RF Switches (ARNITSU)	CS-201	1565157	Aug. 13, 2008
RF CABLE (Chaintek)	SF102	22054-2	Nov. 14. 2008
RF Cable(RICHTEC)	9913-30M N-N Cable	STCCAB-30M-1 GHz	Aug. 13, 2008
Software	ADT_Radiated_V 7.6.15.8	NA	NA
CHANCE MOST Antenna Tower	AT-100	0203	NA
CHANCE MOST Turn Table	TT-100	0203	NA

- Note: 1. The calibration interval of the above test instruments is 12 months and the calibrations are traceable to NML/ROC and NIST/USA.
2. The horn antenna, HP preamplifier (model: 8449B) and Spectrum Analyzer (model: R3271A) are used only for the measurement of emission frequency above 1GHz if tested.
3. The test was performed in ADT Open Site No. C.
4. The FCC Site Registration No. is 656396.
5. The VCCI Site Registration No. is R-1626.
6. The CANADA Site Registration No. is IC 4824A-3.
7. The following table is for the measurement uncertainty, which is calculated as per the document CISPR 16-4. This uncertainty represents an expanded uncertainty expressed at approximately the 95% confidence level using a coverage factor of k=2.

#### 4.2.3 TEST PROCEDURES

- a. The EUT was placed on the top of a rotating table 0.8 meters above the ground at a 3 meter semi- anechoic. The table was rotated 360 degrees to determine the position of the highest radiation.
- b. The EUT was set 3 meters away from the interference-receiving antenna, which was mounted on the top of a variable-height antenna tower.
- c. The antenna is a broadband antenna, and its height is varied from one meter to four meters above the ground to determine the maximum value of the field strength. Both horizontal and vertical polarizations of the antenna are set to make the measurement.
- d. For each suspected emission, the EUT was arranged to its worst case and then the antenna was tuned to heights from 1 meter to 4 meters and the rotatable table was turned from 0 degrees to 360 degrees to find the maximum reading.
- e. The test-receiver system was set to Peak Detect Function and Specified Bandwidth with Maximum Hold Mode.
- f. If the emission level of the EUT in peak mode was 10 dB lower than the limit specified, then testing could be stopped and the peak values of the EUT would be reported. Otherwise the emissions that did not have 10 dB margin would be re-tested one by one using the quasi-peak method or average method as specified and then reported in Data sheet peak mode and QP mode.

**NOTE:**

1. The resolution bandwidth and video bandwidth of test receiver/spectrum analyzer is 120kHz for Peak detection (PK) and Quasi-peak detection (QP) at frequency below 1GHz.
2. The resolution bandwidth of test receiver/spectrum analyzer is 1 MHz and the video bandwidth is 3 MHz for Peak detection (PK) at frequency above 1GHz.
3. The resolution bandwidth of test receiver/spectrum analyzer is 1 MHz and the video bandwidth is 10 Hz for Average detection (AV) at frequency above 1GHz.

#### 4.2.4 DEVIATION FROM TEST STANDARD

No deviation

#### 4.2.5 TEST SETUP

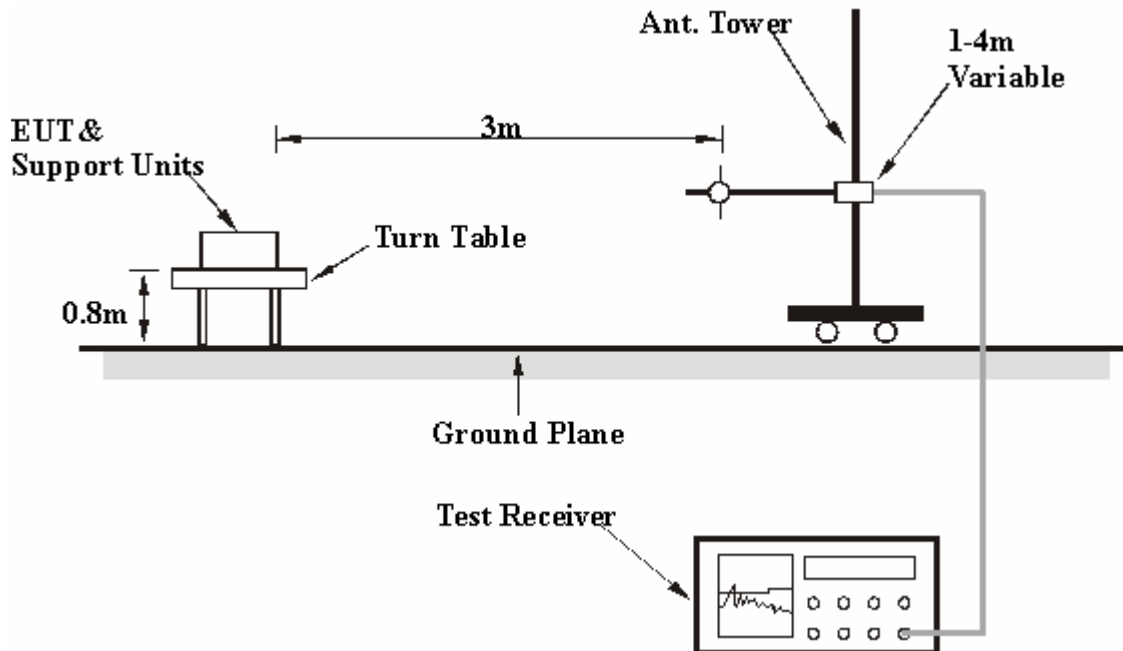

For the actual test configuration, please refer to the related item – Photographs of the Test Configuration.

#### 4.2.6 EUT OPERATING CONDITIONS

1. Placed the EUT on testing table.
2. Prepared other computer systems (support unit 1 ~ 2) to act as communication partners and placed them outside of testing area.
3. The communication partners run test program “Web Control” to enable EUT under transmission/receiving condition continuously via UTP cables and wireless transmission.

## 4.2.7 TEST RESULTS

### BELOW 1GHz WORST-CASE DATA : 802.11b DSSS MODULATION

EUT TEST CONDITION		MEASUREMENT DETAIL	
CHANNEL	Channel 1	FREQUENCY RANGE	Below 1000MHz
INPUT POWER (SYSTEM)	120Vac, 60 Hz	DETECTOR FUNCTION	Quasi-Peak
ENVIRONMENTAL CONDITIONS	18deg. C, 66%RH 975hPa	TESTED BY	Wen Yu

ANTENNA POLARITY & TEST DISTANCE: HORIZONTAL AT 3 M								
NO.	FREQ. (MHz)	EMISSION LEVEL (dBuV/m)	LIMIT (dBuV/m)	MARGIN (dB)	ANTENNA HEIGHT (m)	TABLE ANGLE (Degree)	RAW VALUE (dBuV)	CORRECTION FACTOR (dB/m)
1	200.00	41.42 QP	43.50	-2.08	1.63 H	248	29.39	12.03
2	202.53	40.69 QP	43.50	-2.81	1.22 H	52	28.62	12.07
3	213.50	41.53 QP	43.50	-1.97	1.14 H	23	29.28	12.25
4	225.02	41.55 QP	46.00	-4.45	1.23 H	147	29.12	12.43
5	250.00	43.85 QP	46.00	-2.15	1.42 H	154	31.02	12.83
6	500.00	35.48 QP	46.00	-10.52	1.21 H	185	14.43	21.05
7	750.00	35.48 QP	46.00	-10.52	1.22 H	140	8.22	27.26
8	800.00	33.85 QP	46.00	-12.15	1.25 H	48	5.80	28.05
ANTENNA POLARITY & TEST DISTANCE: VERTICAL AT 3 M								
NO.	FREQ. (MHz)	EMISSION LEVEL (dBuV/m)	LIMIT (dBuV/m)	MARGIN (dB)	ANTENNA HEIGHT (m)	TABLE ANGLE (Degree)	RAW VALUE (dBuV)	CORRECTION FACTOR (dB/m)
1	200.00	41.29 QP	43.50	-2.21	1.23 V	122	29.26	12.03
2	202.56	40.48 QP	43.50	-3.02	1.20 V	33	28.41	12.07
3	213.48	41.56 QP	43.50	-1.94	1.15 V	98	29.31	12.25
4	225.02	40.11 QP	46.00	-5.89	1.00 V	23	27.68	12.43
5	250.00	43.52 QP	46.00	-2.48	1.35 V	335	30.69	12.83
6	500.00	34.25 QP	46.00	-11.75	1.40 V	296	13.20	21.05
7	750.00	32.56 QP	46.00	-13.44	1.30 V	333	5.30	27.26
8	800.00	33.52 QP	46.00	-12.48	1.15 V	42	5.47	28.05

- REMARKS:**
1. Emission level (dBuV/m) = Raw Value (dBuV) + Correction Factor (dB/m).
  2. Correction Factor (dB/m) = Antenna Factor (dB/m) + Cable Factor (dB).
  3. The other emission levels were very low against the limit.
  4. Margin value = Emission level – Limit value.

## Above 1GHz Test Data

### 4.2.8 TEST RESULTS

#### 802.11b DSSS MODULATION

EUT TEST CONDITION		MEASUREMENT DETAIL	
CHANNEL	Channel 1	FREQUENCY RANGE	1 ~ 25GHz
INPUT POWER (SYSTEM)	120Vac, 60 Hz	DETECTOR FUNCTION	Peak (PK) Average (AV)
ENVIRONMENTAL CONDITIONS	20deg. C, 66%RH 975hPa	TESTED BY	Wen Yu

ANTENNA POLARITY & TEST DISTANCE: HORIZONTAL AT 3 M								
NO.	FREQ. (MHz)	EMISSION LEVEL (dBuV/m)	LIMIT (dBuV/m)	MARGIN (dB)	ANTENNA HEIGHT (m)	TABLE ANGLE (Degree)	RAW VALUE (dBuV)	CORRECTION FACTOR (dB/m)
1	2386.32	56.62 PK	74.00	-17.38	1.93 H	176	26.24	30.38
2	2386.32	45.82 AV	54.00	-8.18	1.93 H	176	15.44	30.38
3	*2412.00	99.03 PK			1.92 H	349	68.54	30.49
4	*2412.00	94.05 AV			1.92 H	349	63.56	30.49
5	4824.00	51.35 PK	74.00	-22.65	1.45 H	223	15.66	35.69
6	4824.00	44.75 AV	54.00	-9.25	1.45 H	223	9.06	35.69
7	7236.00	52.66 PK	74.00	-21.34	1.83 H	224	10.42	42.24
8	7236.00	39.72 AV	54.00	-14.28	1.83 H	224	-2.52	42.24

ANTENNA POLARITY & TEST DISTANCE: VERTICAL AT 3 M								
NO.	FREQ. (MHz)	EMISSION LEVEL (dBuV/m)	LIMIT (dBuV/m)	MARGIN (dB)	ANTENNA HEIGHT (m)	TABLE ANGLE (Degree)	RAW VALUE (dBuV)	CORRECTION FACTOR (dB/m)
1	2386.32	60.08 PK	74.00	-13.92	1.00 V	334	29.70	30.38
2	2386.32	52.14 AV	54.00	-1.86	1.00 V	334	21.76	30.38
3	*2412.00	108.36 PK			1.00 V	25	77.87	30.49
4	*2412.00	103.27 AV			1.00 V	25	72.78	30.49
5	4824.00	52.40 PK	74.00	-21.60	1.28 V	102	16.71	35.69
6	4824.00	46.80 AV	54.00	-7.20	1.28 V	102	11.11	35.69
7	7236.00	50.90 PK	74.00	-23.10	1.36 V	270	8.66	42.24
8	7236.00	37.80 AV	54.00	-16.20	1.36 V	270	-4.44	42.24

- REMARKS:**
1. Emission level (dBuV/m) = Raw Value (dBuV) + Correction Factor (dB/m).
  2. Correction Factor (dB/m) = Antenna Factor (dB/m) + Cable Factor (dB).
  3. The other emission levels were very low against the limit.
  4. Margin value = Emission level – Limit value.
  5. “ \* “: Fundamental frequency.

EUT TEST CONDITION		MEASUREMENT DETAIL	
CHANNEL	Channel 6	FREQUENCY RANGE	1 ~ 25GHz
INPUT POWER (SYSTEM)	120Vac, 60 Hz	DETECTOR FUNCTION	Peak (PK) Average (AV)
ENVIRONMENTAL CONDITIONS	20deg. C, 66%RH 975hPa	TESTED BY	Wen Yu

ANTENNA POLARITY & TEST DISTANCE: HORIZONTAL AT 3 M								
NO.	FREQ. (MHz)	EMISSION LEVEL (dBuV/m)	LIMIT (dBuV/m)	MARGIN (dB)	ANTENNA HEIGHT (m)	TABLE ANGLE (Degree)	RAW VALUE (dBuV)	CORRECTION FACTOR (dB/m)
1	*2437.00	99.84 PK			1.94 H	349	69.23	30.61
2	*2437.00	94.59 AV			1.94 H	349	63.98	30.61
3	4874.00	54.90 PK	74.00	-19.10	1.46 H	217	19.10	35.80
4	4874.00	49.91 AV	54.00	-4.09	1.46 H	217	14.11	35.80
5	7311.00	52.89 PK	74.00	-21.11	1.84 H	235	10.37	42.52
6	7311.00	39.23 AV	54.00	-14.77	1.84 H	235	-3.29	42.52
ANTENNA POLARITY & TEST DISTANCE: VERTICAL AT 3 M								
NO.	FREQ. (MHz)	EMISSION LEVEL (dBuV/m)	LIMIT (dBuV/m)	MARGIN (dB)	ANTENNA HEIGHT (m)	TABLE ANGLE (Degree)	RAW VALUE (dBuV)	CORRECTION FACTOR (dB/m)
1	*2437.00	109.60 PK			1.00 V	16	78.99	30.61
2	*2437.00	103.20 AV			1.00 V	16	72.59	30.61
3	4874.00	56.80 PK	74.00	-17.20	1.28 V	290	21.00	35.80
4	4874.00	52.80 AV	54.00	-1.20	1.28 V	290	17.00	35.80
5	7311.00	52.60 PK	74.00	-21.40	1.70 V	294	10.08	42.52
6	7311.00	39.10 AV	54.00	-14.90	1.70 V	294	-3.42	42.52

- REMARKS:**
1. Emission level (dBuV/m) = Raw Value (dBuV) + Correction Factor (dB/m).
  2. Correction Factor (dB/m) = Antenna Factor (dB/m) + Cable Factor (dB).
  3. The other emission levels were very low against the limit.
  4. Margin value = Emission level – Limit value.
  5. “ \* “: Fundamental frequency.

EUT TEST CONDITION		MEASUREMENT DETAIL	
CHANNEL	Channel 11	FREQUENCY RANGE	1 ~ 25GHz
INPUT POWER (SYSTEM)	120Vac, 60 Hz	DETECTOR FUNCTION	Peak (PK) Average (AV)
ENVIRONMENTAL CONDITIONS	20deg. C, 66%RH 975hPa	TESTED BY	Wen Yu

ANTENNA POLARITY & TEST DISTANCE: HORIZONTAL AT 3 M								
NO.	FREQ. (MHz)	EMISSION LEVEL (dBuV/m)	LIMIT (dBuV/m)	MARGIN (dB)	ANTENNA HEIGHT (m)	TABLE ANGLE (Degree)	RAW VALUE (dBuV)	CORRECTION FACTOR (dB/m)
1	*2462.00	97.49 PK			1.88 H	237	66.77	30.72
2	*2462.00	92.28 AV			1.88 H	237	61.56	30.72
3	2487.98	56.21 PK	74.00	-17.79	1.87 H	167	25.37	30.84
4	2487.98	44.90 AV	54.00	-9.10	1.87 H	167	14.06	30.84
5	4924.00	45.80 PK	74.00	-28.20	1.45 H	232	9.90	35.90
6	4924.00	34.51 AV	54.00	-19.49	1.45 H	232	-1.39	35.90
7	7386.00	52.33 PK	74.00	-21.67	1.08 H	235	9.53	42.80
8	7386.00	38.49 AV	54.00	-15.51	1.08 H	235	-4.31	42.80

ANTENNA POLARITY & TEST DISTANCE: VERTICAL AT 3 M								
NO.	FREQ. (MHz)	EMISSION LEVEL (dBuV/m)	LIMIT (dBuV/m)	MARGIN (dB)	ANTENNA HEIGHT (m)	TABLE ANGLE (Degree)	RAW VALUE (dBuV)	CORRECTION FACTOR (dB/m)
1	*2462.00	108.07 PK			1.00 V	32	77.35	30.72
2	*2462.00	103.19 AV			1.00 V	32	72.47	30.72
3	2487.98	61.99 PK	74.00	-12.01	1.00 V	22	31.15	30.84
4	<b>2487.98</b>	<b>53.41 AV</b>	<b>54.00</b>	<b>-0.59</b>	<b>1.00 V</b>	<b>22</b>	<b>22.57</b>	<b>30.84</b>
5	4924.00	50.67 PK	74.00	-23.33	1.38 V	16	14.77	35.90
6	4924.00	44.04 AV	54.00	-9.96	1.38 V	16	8.14	35.90
7	7386.00	52.00 PK	74.00	-22.00	1.40 V	290	9.20	42.80
8	7386.00	38.60 AV	54.00	-15.40	1.40 V	290	-4.20	42.80

- REMARKS:**
1. Emission level (dBuV/m) = Raw Value (dBuV) + Correction Factor (dB/m).
  2. Correction Factor (dB/m) = Antenna Factor (dB/m) + Cable Factor (dB).
  3. The other emission levels were very low against the limit.
  4. Margin value = Emission level – Limit value.
  5. “ \* “: Fundamental frequency.

RESTRICTED BANDEDGE (802.11b MODE, CH1, HORIZONTAL )

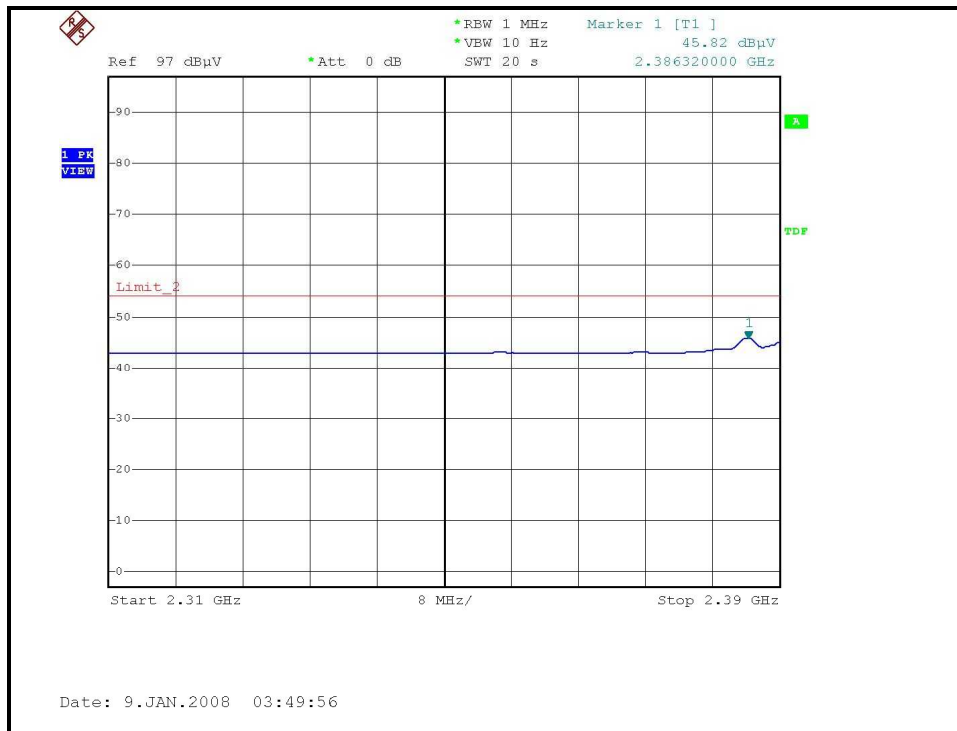
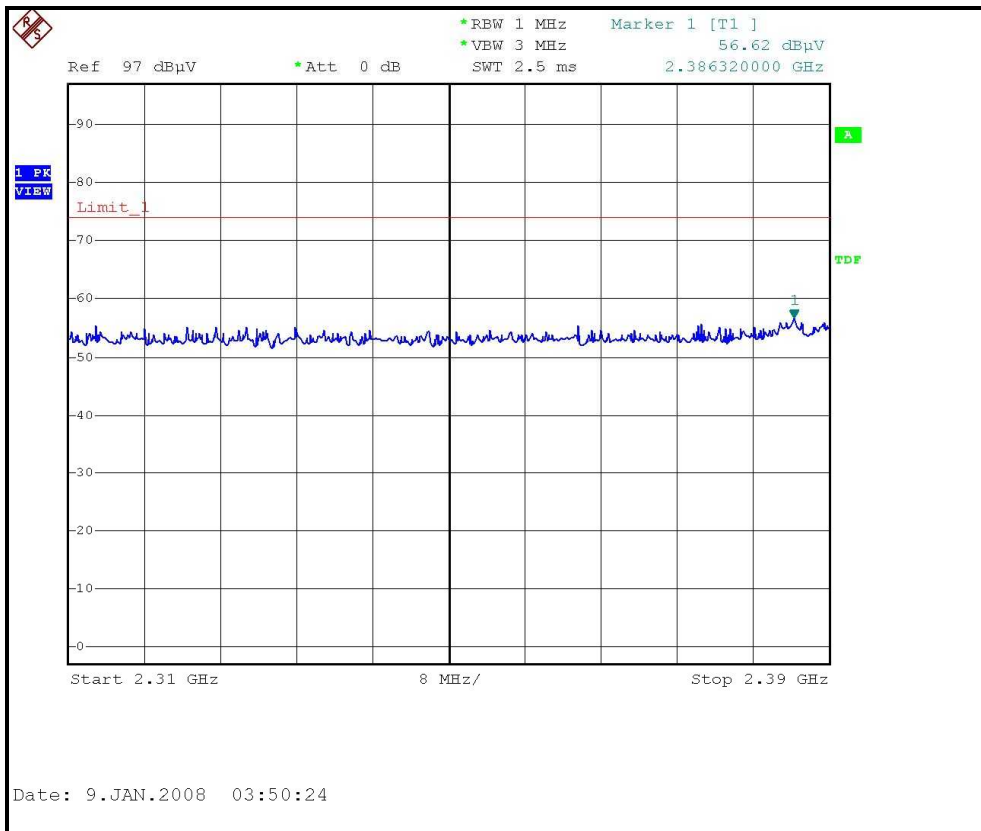



RESTRICTED BANDEDGE (802.11b MODE, CH1, VERTICAL )

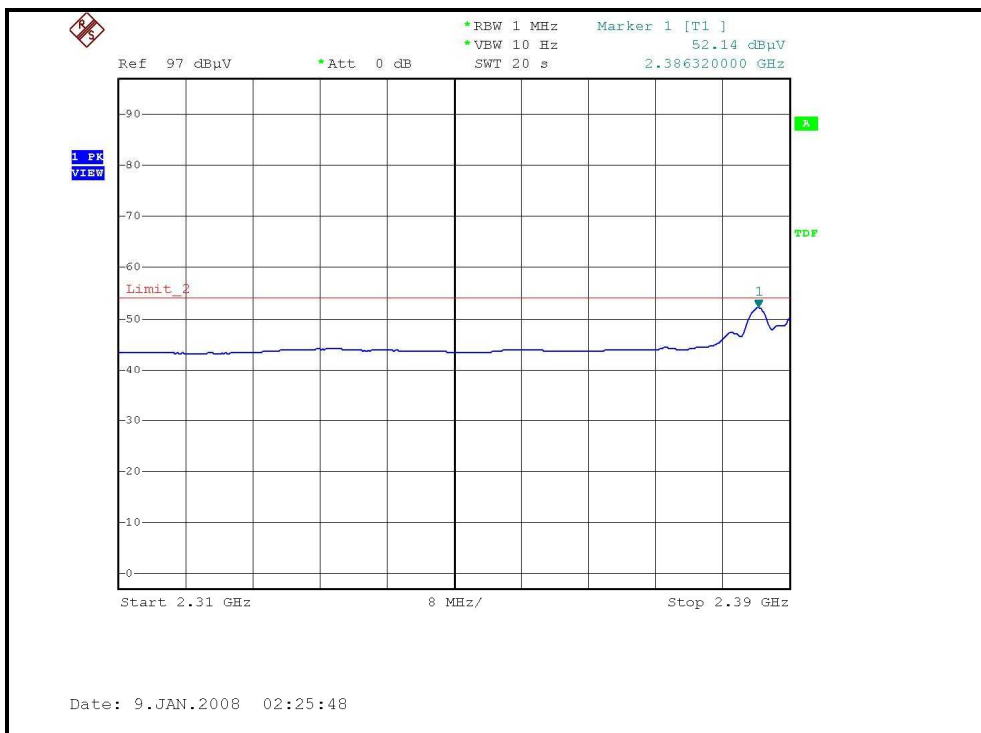
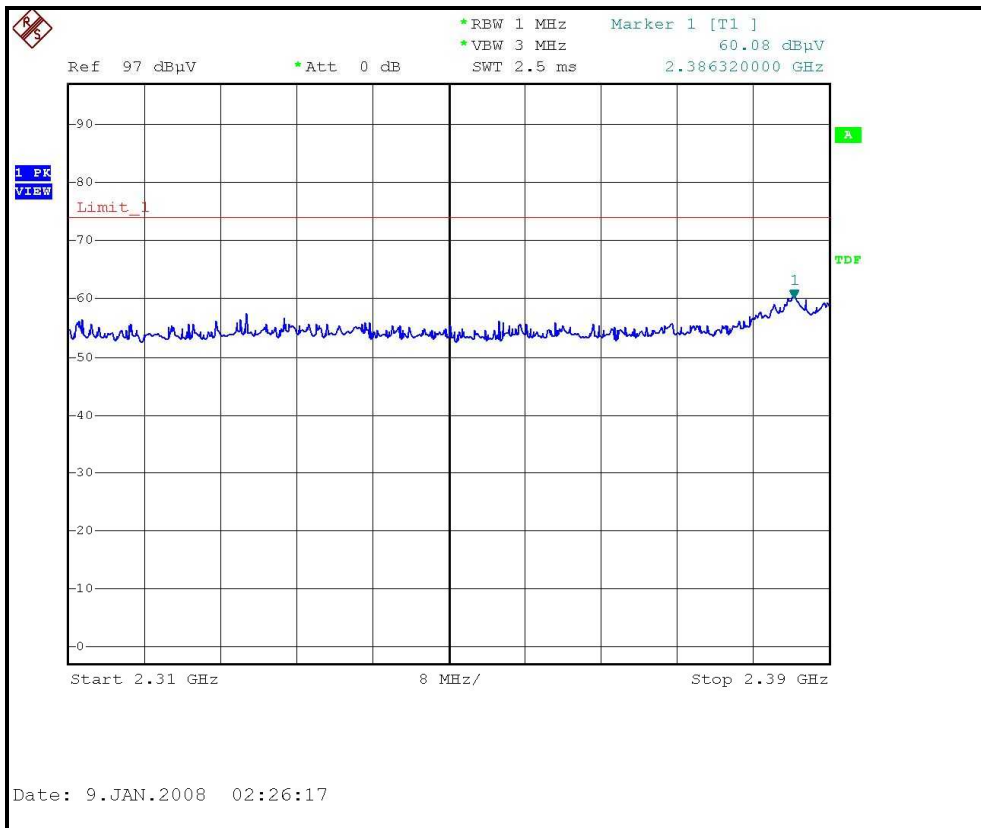



RESTRICTED BANDEDGE (802.11b MODE,CH11, VERTICAL )

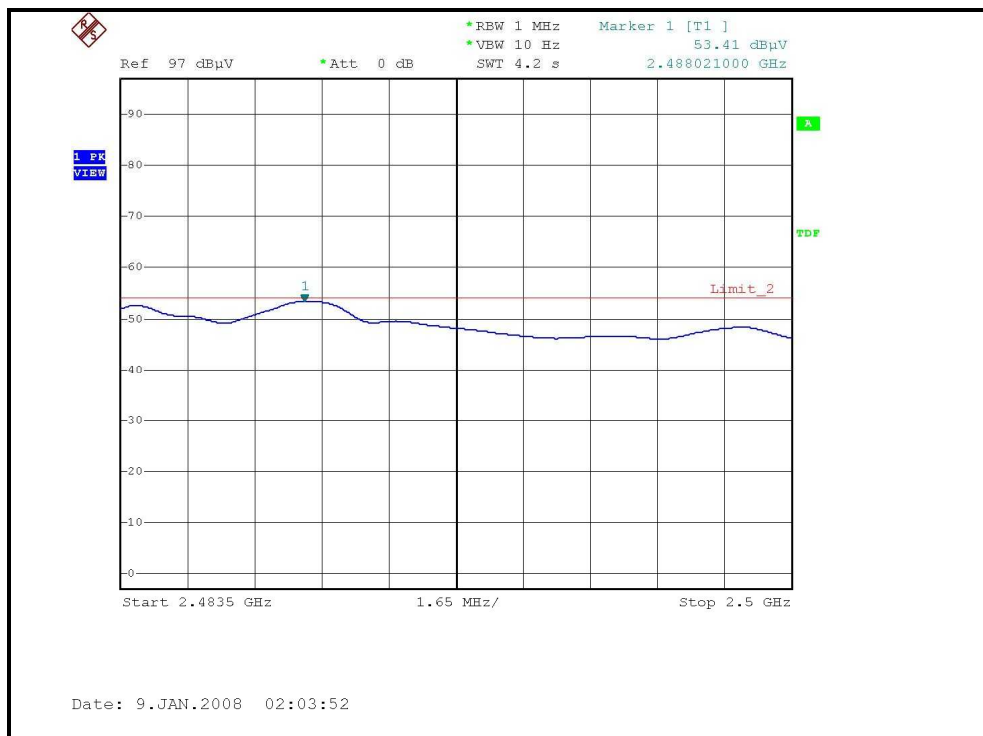
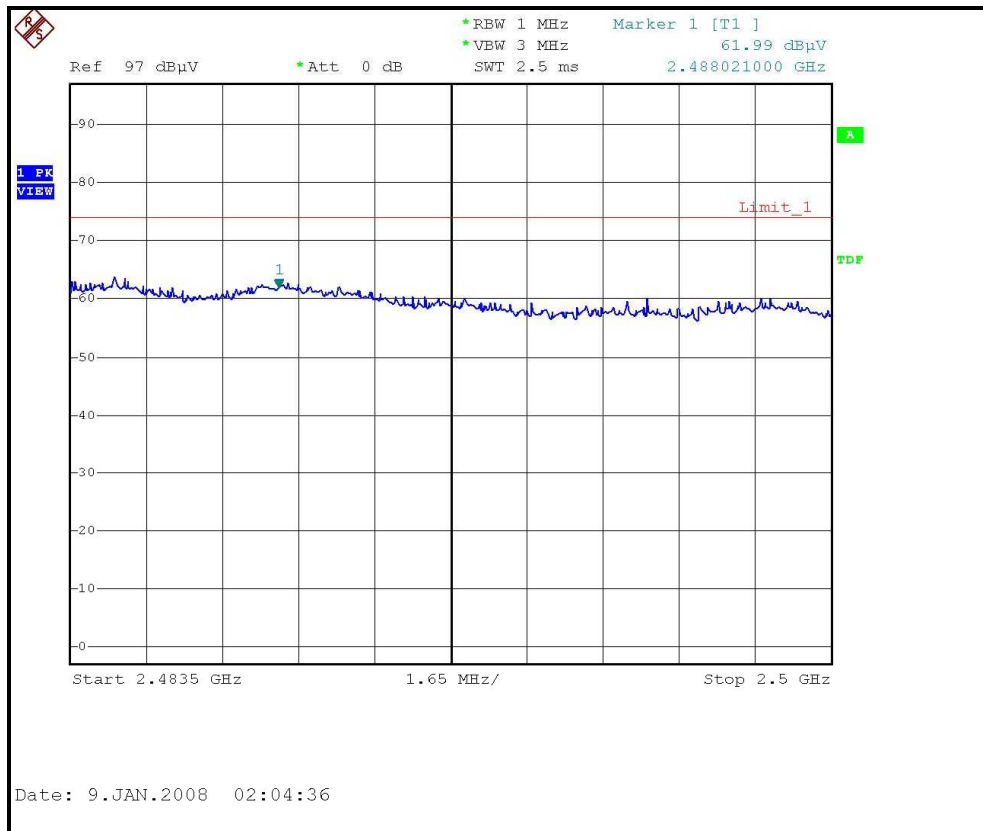

### 802.11g OFDM MODULATION

EUT TEST CONDITION		MEASUREMENT DETAIL	
CHANNEL	Channel 1	FREQUENCY RANGE	1 ~ 25GHz
INPUT POWER (SYSTEM)	120Vac, 60 Hz	DETECTOR FUNCTION	Peak (PK) Average (AV)
ENVIRONMENTAL CONDITIONS	20deg. C, 66%RH 975hPa	TESTED BY	Wen Yu

ANTENNA POLARITY & TEST DISTANCE: HORIZONTAL AT 3 M								
NO.	FREQ. (MHz)	EMISSION LEVEL (dBuV/m)	LIMIT (dBuV/m)	MARGIN (dB)	ANTENNA HEIGHT (m)	TABLE ANGLE (Degree)	RAW VALUE (dBuV)	CORRECTION FACTOR (dB/m)
1	2390.00	60.43 PK	74.00	-13.57	1.94 H	177	30.03	30.40
2	2390.00	46.06 AV	54.00	-7.94	1.94 H	177	15.66	30.40
3	*2412.00	99.70 PK			1.92 H	349	69.21	30.49
4	*2412.00	89.47 AV			1.92 H	349	58.98	30.49
5	4824.00	54.53 PK	74.00	-19.47	1.45 H	222	18.84	35.69
6	4824.00	37.73 AV	54.00	-16.27	1.45 H	222	2.04	35.69
7	7236.00	52.25 PK	74.00	-21.75	1.38 H	275	10.01	42.24
8	7236.00	38.62 AV	54.00	-15.38	1.38 H	275	-3.62	42.24

ANTENNA POLARITY & TEST DISTANCE: VERTICAL AT 3 M								
NO.	FREQ. (MHz)	EMISSION LEVEL (dBuV/m)	LIMIT (dBuV/m)	MARGIN (dB)	ANTENNA HEIGHT (m)	TABLE ANGLE (Degree)	RAW VALUE (dBuV)	CORRECTION FACTOR (dB/m)
1	2390.00	72.31 PK	74.00	-1.69	1.00 V	335	41.91	30.40
2	2390.00	53.08 AV	54.00	-0.92	1.00 V	335	22.68	30.40
3	*2412.00	108.92 PK			1.00 V	338	78.43	30.49
4	*2412.00	98.33 AV			1.00 V	338	67.84	30.49
5	4824.00	62.99 PK	74.00	-11.01	1.59 V	9	27.30	35.69
6	4824.00	44.14 AV	54.00	-9.86	1.59 V	9	8.45	35.69
7	7236.00	52.26 PK	74.00	-21.74	1.53 V	323	10.02	42.24
8	7236.00	38.46 AV	54.00	-15.54	1.53 V	323	-3.78	42.24

- REMARKS:**
1. Emission level (dBuV/m) = Raw Value (dBuV) + Correction Factor (dB/m).
  2. Correction Factor (dB/m) = Antenna Factor (dB/m) + Cable Factor (dB).
  3. The other emission levels were very low against the limit.
  4. Margin value = Emission level – Limit value.
  5. “ \* “: Fundamental frequency.

EUT TEST CONDITION		MEASUREMENT DETAIL	
CHANNEL	Channel 6	FREQUENCY RANGE	1 ~ 25GHz
INPUT POWER (SYSTEM)	120Vac, 60 Hz	DETECTOR FUNCTION	Peak (PK) Average (AV)
ENVIRONMENTAL CONDITIONS	20deg. C, 66%RH 975hPa	TESTED BY	Wen Yu

ANTENNA POLARITY & TEST DISTANCE: HORIZONTAL AT 3 M								
NO.	FREQ. (MHz)	EMISSION LEVEL (dBuV/m)	LIMIT (dBuV/m)	MARGIN (dB)	ANTENNA HEIGHT (m)	TABLE ANGLE (Degree)	RAW VALUE (dBuV)	CORRECTION FACTOR (dB/m)
1	*2437.00	100.38 PK			1.96 H	349	69.77	30.61
2	*2437.00	89.83 AV			1.96 H	349	59.22	30.61
3	4874.00	57.91 PK	74.00	-16.09	1.00 H	226	22.11	35.80
4	4874.00	40.78 AV	54.00	-13.22	1.00 H	226	4.98	35.80
5	7311.00	52.51 PK	74.00	-21.49	1.45 H	266	9.99	42.52
6	7311.00	38.72 AV	54.00	-15.28	1.45 H	266	-3.80	42.52

ANTENNA POLARITY & TEST DISTANCE: VERTICAL AT 3 M								
NO.	FREQ. (MHz)	EMISSION LEVEL (dBuV/m)	LIMIT (dBuV/m)	MARGIN (dB)	ANTENNA HEIGHT (m)	TABLE ANGLE (Degree)	RAW VALUE (dBuV)	CORRECTION FACTOR (dB/m)
1	*2437.00	111.11 PK			1.00 V	26	80.50	30.61
2	*2437.00	100.77 AV			1.00 V	26	70.16	30.61
3	4874.00	66.00 PK	74.00	-8.00	1.28 V	338	30.20	35.80
4	4874.00	47.40 AV	54.00	-6.60	1.28 V	338	11.60	35.80
5	7311.00	51.60 PK	74.00	-22.40	1.40 V	139	9.08	42.52
6	7311.00	38.00 AV	54.00	-16.00	1.40 V	139	-4.52	42.52

- REMARKS:**
1. Emission level (dBuV/m) = Raw Value (dBuV) + Correction Factor (dB/m).
  2. Correction Factor (dB/m) = Antenna Factor (dB/m) + Cable Factor (dB).
  3. The other emission levels were very low against the limit.
  4. Margin value = Emission level – Limit value.
  5. “ \* “: Fundamental frequency.



EUT TEST CONDITION		MEASUREMENT DETAIL	
CHANNEL	Channel 11	FREQUENCY RANGE	1 ~ 25GHz
INPUT POWER (SYSTEM)	120Vac, 60 Hz	DETECTOR FUNCTION	Peak (PK) Average (AV)
ENVIRONMENTAL CONDITIONS	20deg. C, 66%RH 975hPa	TESTED BY	Wen Yu

ANTENNA POLARITY & TEST DISTANCE: HORIZONTAL AT 3 M								
NO.	FREQ. (MHz)	EMISSION LEVEL (dBuV/m)	LIMIT (dBuV/m)	MARGIN (dB)	ANTENNA HEIGHT (m)	TABLE ANGLE (Degree)	RAW VALUE (dBuV)	CORRECTION FACTOR (dB/m)
1	*2462.00	96.70 PK			1.88 H	237	65.98	30.72
2	*2462.00	86.20 AV			1.88 H	237	55.48	30.72
3	2483.50	61.23 PK	74.00	-12.77	1.87 H	165	30.41	30.82
4	2483.50	44.97 AV	54.00	-9.03	1.87 H	165	14.15	30.82
5	4924.00	45.62 PK	74.00	-28.38	1.00 H	33	9.72	35.90
6	4924.00	30.93 AV	54.00	-23.07	1.00 H	33	-4.97	35.90
7	7386.00	52.78 PK	74.00	-21.22	1.44 H	256	9.98	42.80
8	7386.00	39.02 AV	54.00	-14.98	1.44 H	256	-3.78	42.80

ANTENNA POLARITY & TEST DISTANCE: VERTICAL AT 3 M								
NO.	FREQ. (MHz)	EMISSION LEVEL (dBuV/m)	LIMIT (dBuV/m)	MARGIN (dB)	ANTENNA HEIGHT (m)	TABLE ANGLE (Degree)	RAW VALUE (dBuV)	CORRECTION FACTOR (dB/m)
1	*2462.00	108.20 PK			1.00 V	345	77.48	30.72
2	*2462.00	97.98 AV			1.00 V	345	67.26	30.72
3	2483.50	72.56 PK	74.00	-1.44	1.00 V	347	41.74	30.82
4	2483.50	53.03 AV	54.00	-0.97	1.00 V	347	22.21	30.82
5	4924.00	55.88 PK	74.00	-18.12	1.27 V	335	19.98	35.90
6	4924.00	34.21 AV	54.00	-19.79	1.27 V	335	-1.69	35.90
7	7386.00	52.73 PK	74.00	-21.27	1.35 V	316	9.93	42.80
8	7386.00	38.85 AV	54.00	-15.15	1.35 V	316	-3.95	42.80

- REMARKS:**
1. Emission level (dBuV/m) = Raw Value (dBuV) + Correction Factor (dB/m).
  2. Correction Factor (dB/m) = Antenna Factor (dB/m) + Cable Factor (dB).
  3. The other emission levels were very low against the limit.
  4. Margin value = Emission level – Limit value.
  5. “ \* “: Fundamental frequency.







RESTRICTED BANDEDGE (802.11g MODE,CH11, HORIZONTAL )

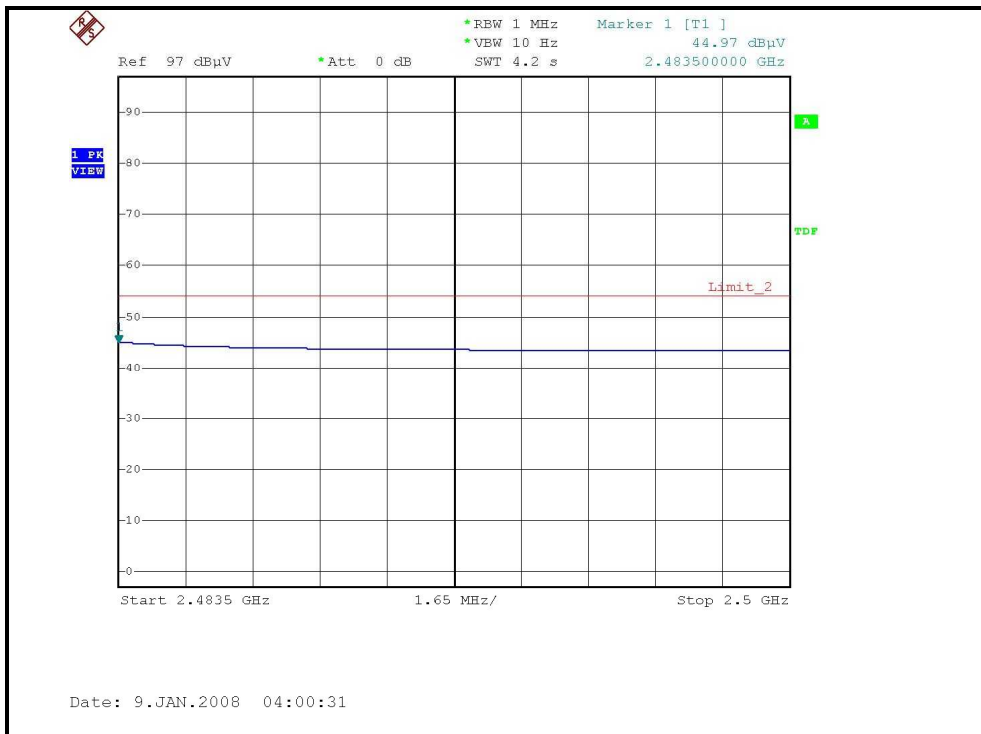
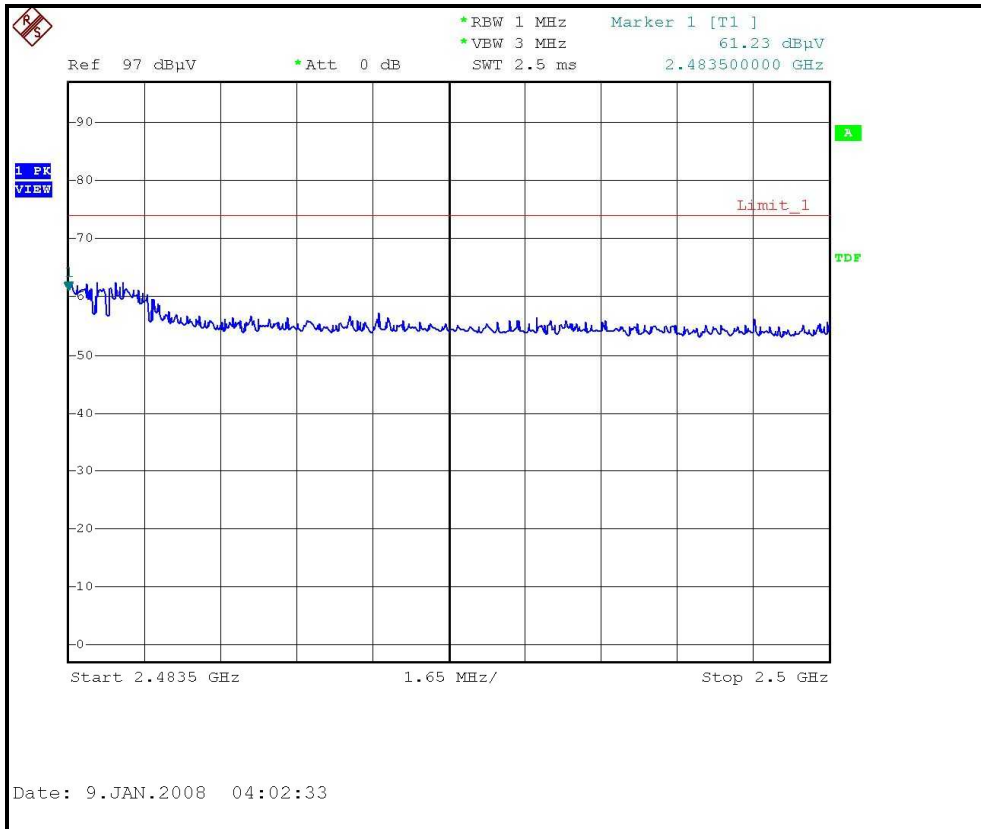

RESTRICTED BANDEDGE (802.11g MODE, CH11, VERTICAL )

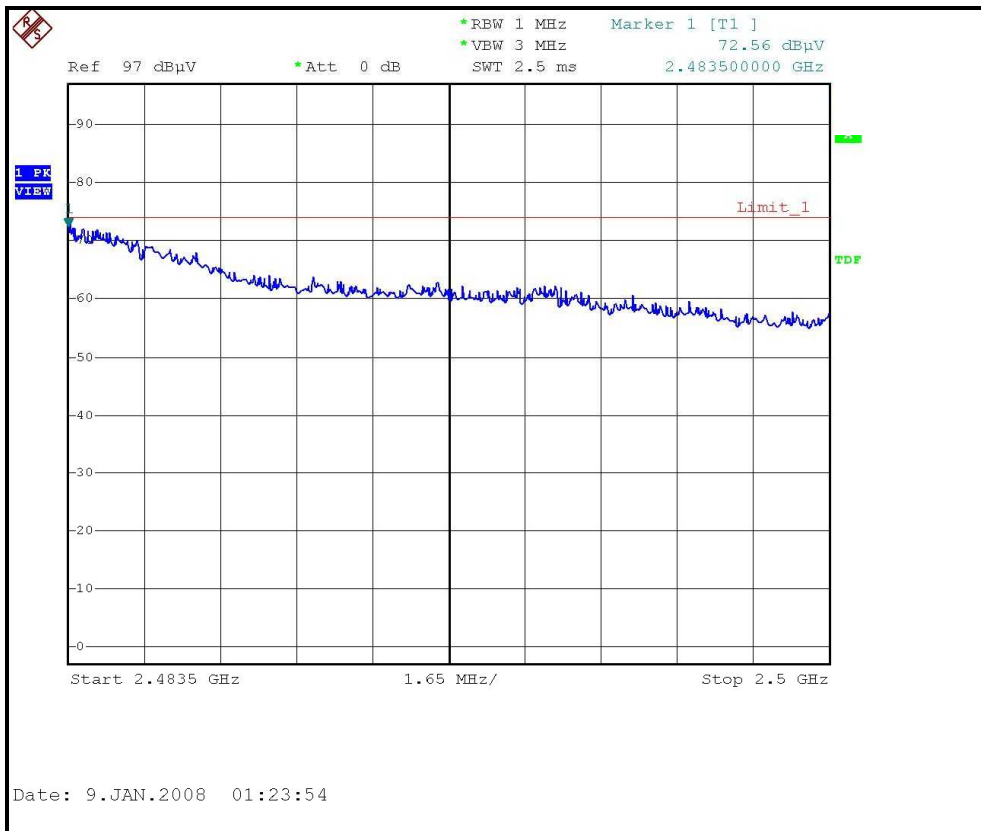



**DRAFT 802.11n (20MHz) OFDM MODULATION**

EUT TEST CONDITION		MEASUREMENT DETAIL	
CHANNEL	Channel 1	FREQUENCY RANGE	1 ~ 25GHz
INPUT POWER (SYSTEM)	120Vac, 60 Hz	DETECTOR FUNCTION	Peak (PK) Average (AV)
ENVIRONMENTAL CONDITIONS	20deg. C, 66%RH 975hPa	TESTED BY	Wen Yu

ANTENNA POLARITY & TEST DISTANCE: HORIZONTAL AT 3 M								
NO.	FREQ. (MHz)	EMISSION LEVEL (dBuV/m)	LIMIT (dBuV/m)	MARGIN (dB)	ANTENNA HEIGHT (m)	TABLE ANGLE (Degree)	RAW VALUE (dBuV)	CORRECTION FACTOR (dB/m)
1	2390.00	60.21 PK	74.00	-13.79	1.73 H	69	29.81	30.40
2	2390.00	44.84 AV	54.00	-9.16	1.73 H	69	14.45	30.40
3	*2412.00	96.29 PK			1.84 H	178	65.80	30.49
4	*2412.00	85.50 AV			1.84 H	178	55.01	30.49
5	4824.00	49.20 PK	74.00	-24.80	1.45 H	243	13.51	35.69
6	4824.00	32.65 AV	54.00	-21.35	1.45 H	243	-3.04	35.69
7	7236.00	52.29 PK	74.00	-21.71	1.43 H	226	10.05	42.24
8	7236.00	38.06 AV	54.00	-15.94	1.43 H	226	-4.18	42.24

ANTENNA POLARITY & TEST DISTANCE: VERTICAL AT 3 M								
NO.	FREQ. (MHz)	EMISSION LEVEL (dBuV/m)	LIMIT (dBuV/m)	MARGIN (dB)	ANTENNA HEIGHT (m)	TABLE ANGLE (Degree)	RAW VALUE (dBuV)	CORRECTION FACTOR (dB/m)
1	2390.00	67.23 PK	74.00	-6.77	1.00 V	18	36.84	30.40
2	2390.00	50.49 AV	54.00	-3.51	1.00 V	18	20.09	30.40
3	*2412.00	107.48 PK			1.00 V	346	76.99	30.49
4	*2412.00	96.23 AV			1.00 V	346	65.74	30.49
5	4824.00	60.63 PK	74.00	-13.37	1.27 V	288	24.94	35.69
6	4824.00	40.23 AV	54.00	-13.77	1.27 V	288	4.54	35.69
7	7236.00	52.11 PK	74.00	-21.89	1.36 V	308	9.87	42.24
8	7236.00	38.20 AV	54.00	-15.80	1.36 V	308	-4.04	42.24

- REMARKS:**
1. Emission level (dBuV/m) = Raw Value (dBuV) + Correction Factor (dB/m).
  2. Correction Factor (dB/m) = Antenna Factor (dB/m) + Cable Factor (dB).
  3. The other emission levels were very low against the limit.
  4. Margin value = Emission level – Limit value.
  5. “ \* “: Fundamental frequency.

EUT TEST CONDITION		MEASUREMENT DETAIL	
CHANNEL	Channel 6	FREQUENCY RANGE	1 ~ 25GHz
INPUT POWER (SYSTEM)	120Vac, 60 Hz	DETECTOR FUNCTION	Peak (PK) Average (AV)
ENVIRONMENTAL CONDITIONS	20deg. C, 66%RH 975hPa	TESTED BY	Wen Yu

ANTENNA POLARITY & TEST DISTANCE: HORIZONTAL AT 3 M								
NO.	FREQ. (MHz)	EMISSION LEVEL (dBuV/m)	LIMIT (dBuV/m)	MARGIN (dB)	ANTENNA HEIGHT (m)	TABLE ANGLE (Degree)	RAW VALUE (dBuV)	CORRECTION FACTOR (dB/m)
1	*2437.00	97.05 PK			1.85 H	160	66.44	30.61
2	*2437.00	86.01 AV			1.85 H	160	55.40	30.61
3	4874.00	49.72 PK	74.00	-24.28	1.45 H	243	13.92	35.80
4	4874.00	32.96 AV	54.00	-21.04	1.46 H	241	-2.84	35.80
5	7311.00	52.38 PK	74.00	-21.62	1.45 H	223	9.86	42.52
6	7311.00	38.11 AV	54.00	-15.89	1.45 H	223	-4.41	42.52
ANTENNA POLARITY & TEST DISTANCE: VERTICAL AT 3 M								
NO.	FREQ. (MHz)	EMISSION LEVEL (dBuV/m)	LIMIT (dBuV/m)	MARGIN (dB)	ANTENNA HEIGHT (m)	TABLE ANGLE (Degree)	RAW VALUE (dBuV)	CORRECTION FACTOR (dB/m)
1	*2437.00	107.57 PK			1.00 V	358	76.96	30.61
2	*2437.00	96.33 AV			1.00 V	358	65.72	30.61
3	4874.00	61.19 PK	74.00	-12.81	1.28 V	286	25.39	35.80
4	4874.00	41.28 AV	54.00	-12.72	1.28 V	286	5.48	35.80
5	7311.00	52.31 PK	74.00	-21.69	1.34 V	311	9.79	42.52
6	7311.00	38.30 AV	54.00	-15.70	1.34 V	311	-4.22	42.52

- REMARKS:**
1. Emission level (dBuV/m) = Raw Value (dBuV) + Correction Factor (dB/m).
  2. Correction Factor (dB/m) = Antenna Factor (dB/m) + Cable Factor (dB).
  3. The other emission levels were very low against the limit.
  4. Margin value = Emission level – Limit value.
  5. “ \* “: Fundamental frequency.

EUT TEST CONDITION		MEASUREMENT DETAIL	
CHANNEL	Channel 11	FREQUENCY RANGE	1 ~ 25GHz
INPUT POWER (SYSTEM)	120Vac, 60 Hz	DETECTOR FUNCTION	Peak (PK) Average (AV)
ENVIRONMENTAL CONDITIONS	20deg. C, 66%RH 975hPa	TESTED BY	Wen Yu

ANTENNA POLARITY & TEST DISTANCE: HORIZONTAL AT 3 M								
NO.	FREQ. (MHz)	EMISSION LEVEL (dBuV/m)	LIMIT (dBuV/m)	MARGIN (dB)	ANTENNA HEIGHT (m)	TABLE ANGLE (Degree)	RAW VALUE (dBuV)	CORRECTION FACTOR (dB/m)
1	*2462.00	95.90 PK			1.88 H	165	65.18	30.72
2	*2462.00	84.63 AV			1.88 H	165	53.91	30.72
3	2483.50	58.10 PK	74.00	-15.90	1.84 H	198	27.28	30.82
4	2483.50	44.66 AV	54.00	-9.34	1.84 H	198	13.84	30.82
5	4924.00	48.37 PK	74.00	-25.63	1.44 H	252	12.47	35.90
6	4924.00	31.65 AV	54.00	-22.35	1.44 H	252	-4.25	35.90
7	7386.00	52.62 PK	74.00	-21.38	1.44 H	232	9.82	42.80
8	7386.00	38.24 AV	54.00	-15.76	1.44 H	232	-4.56	42.80
ANTENNA POLARITY & TEST DISTANCE: VERTICAL AT 3 M								
NO.	FREQ. (MHz)	EMISSION LEVEL (dBuV/m)	LIMIT (dBuV/m)	MARGIN (dB)	ANTENNA HEIGHT (m)	TABLE ANGLE (Degree)	RAW VALUE (dBuV)	CORRECTION FACTOR (dB/m)
1	*2462.00	105.80 PK			1.00 V	20	75.08	30.72
2	*2462.00	95.00 AV			1.00 V	20	64.28	30.72
3	2483.50	68.10 PK	74.00	-5.90	1.00 V	357	37.28	30.82
4	2483.50	51.00 AV	54.00	-3.00	1.00 V	357	20.18	30.82
5	4924.00	53.46 PK	74.00	-20.54	1.28 V	291	17.56	35.90
6	4924.00	34.17 AV	54.00	-19.83	1.28 V	291	-1.73	35.90
7	7386.00	52.15 PK	74.00	-21.85	1.35 V	317	9.35	42.80
8	7386.00	38.66 AV	54.00	-15.34	1.35 V	317	-4.14	42.80

- REMARKS:**
1. Emission level (dBuV/m) = Raw Value (dBuV) + Correction Factor (dB/m).
  2. Correction Factor (dB/m) = Antenna Factor (dB/m) + Cable Factor (dB).
  3. The other emission levels were very low against the limit.
  4. Margin value = Emission level – Limit value.
  5. “ \* “: Fundamental frequency.



RESTRICTED BANDEDGE (DRAFT 802.11n (20MHz) MODE, CH1, VERTICAL )

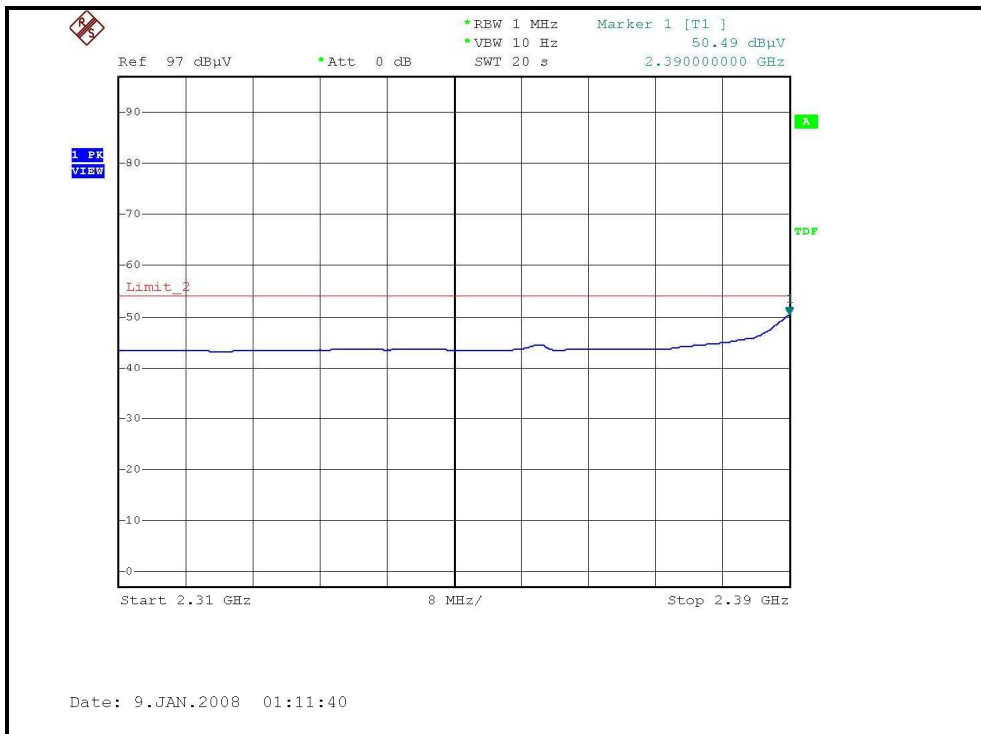
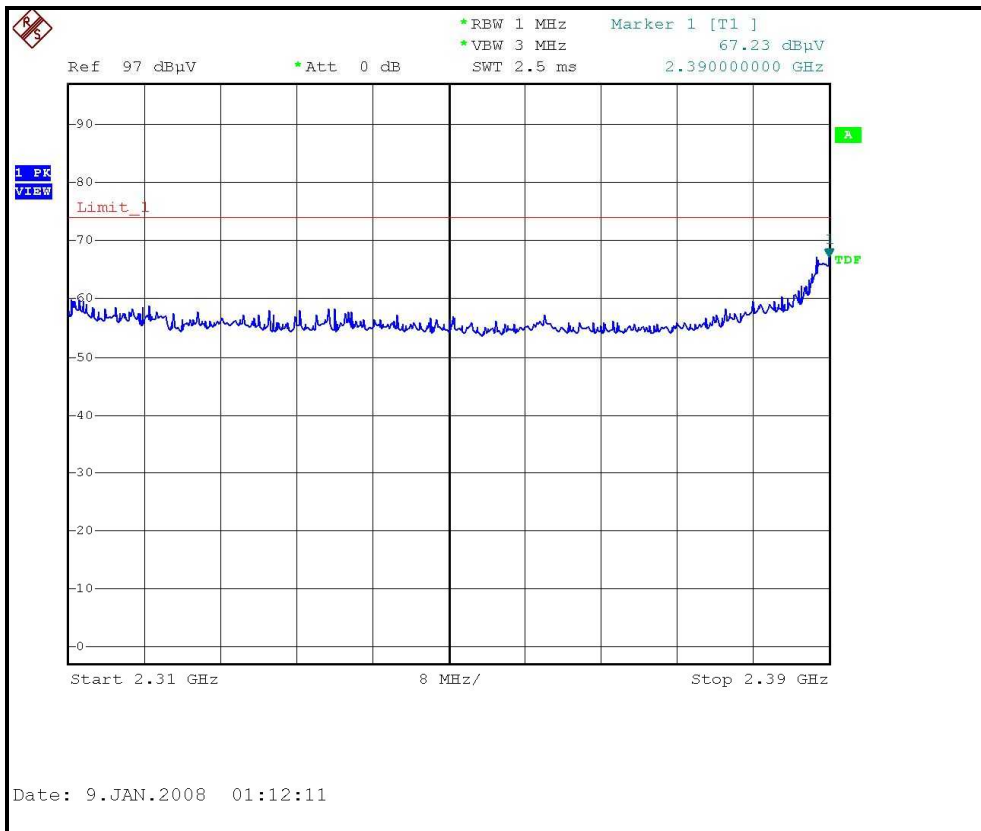

RESTRICTED BANDEDGE (DRAFT 802.11n (20MHz) MODE, CH11, HORIZONTAL )

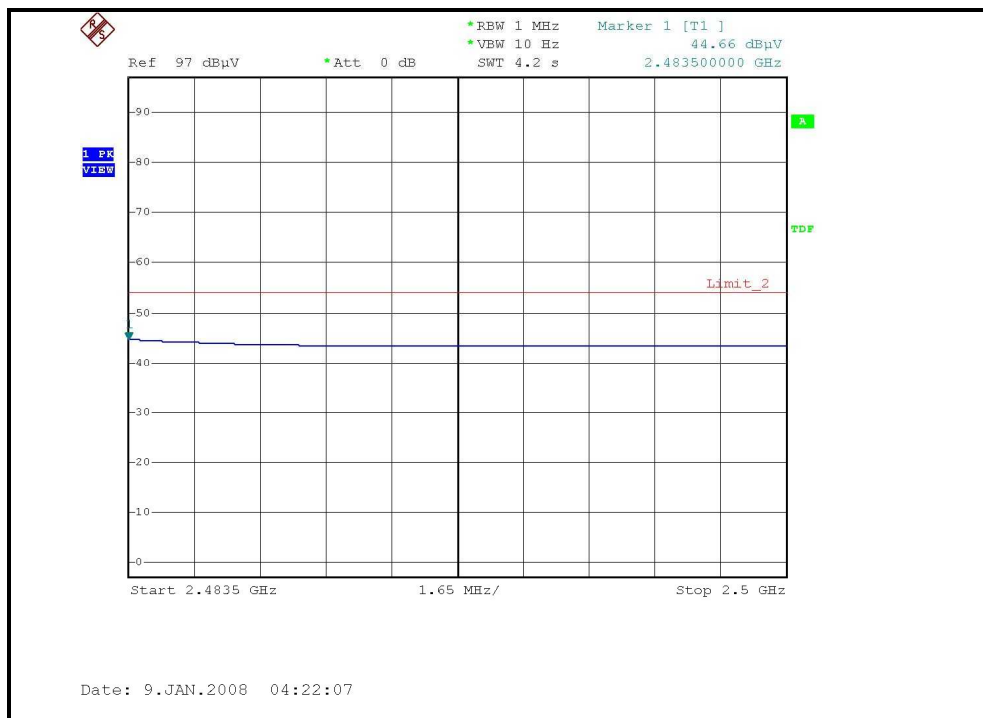
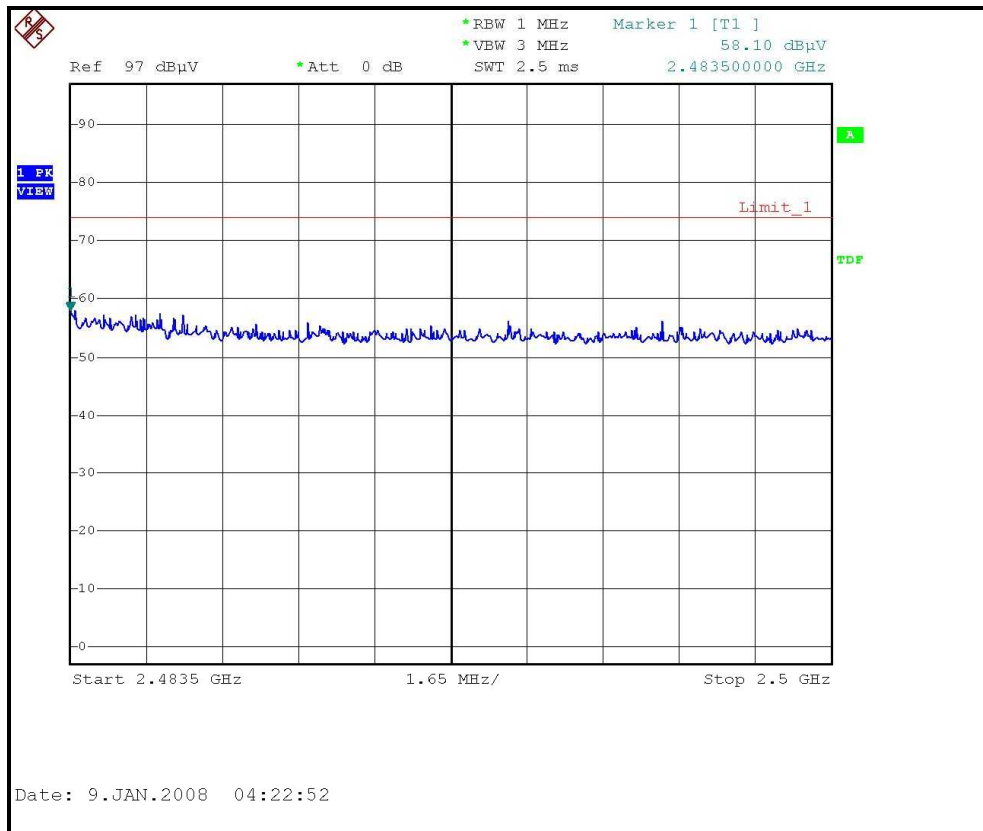



RESTRICTED BANDEDGE (DRAFT 802.11n (20MHz) MODE, CH11, VERTICAL )

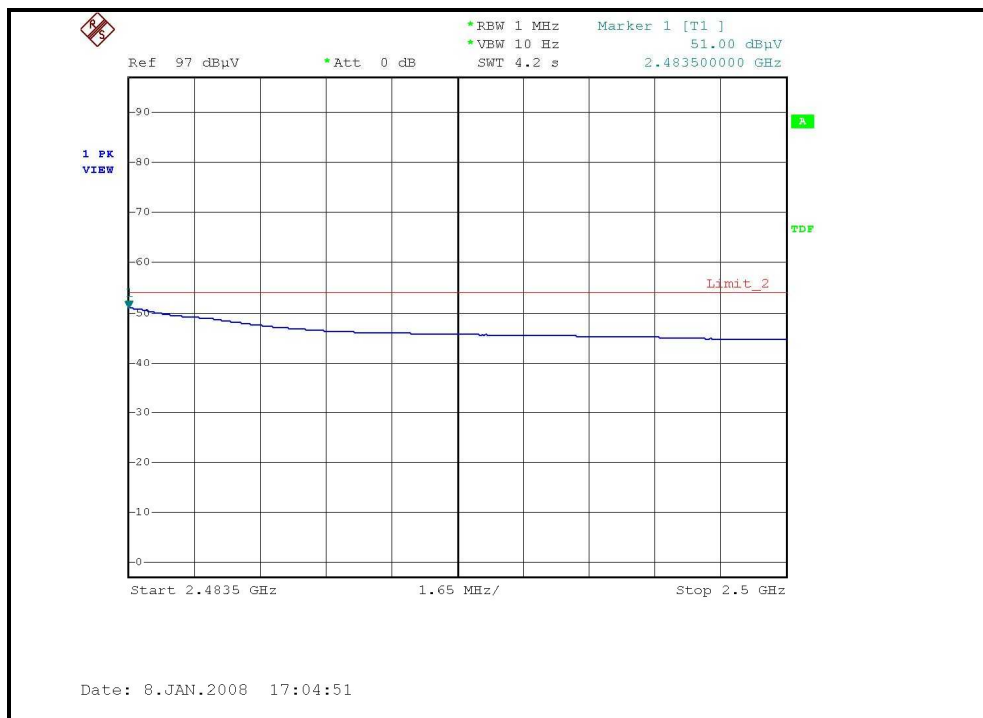
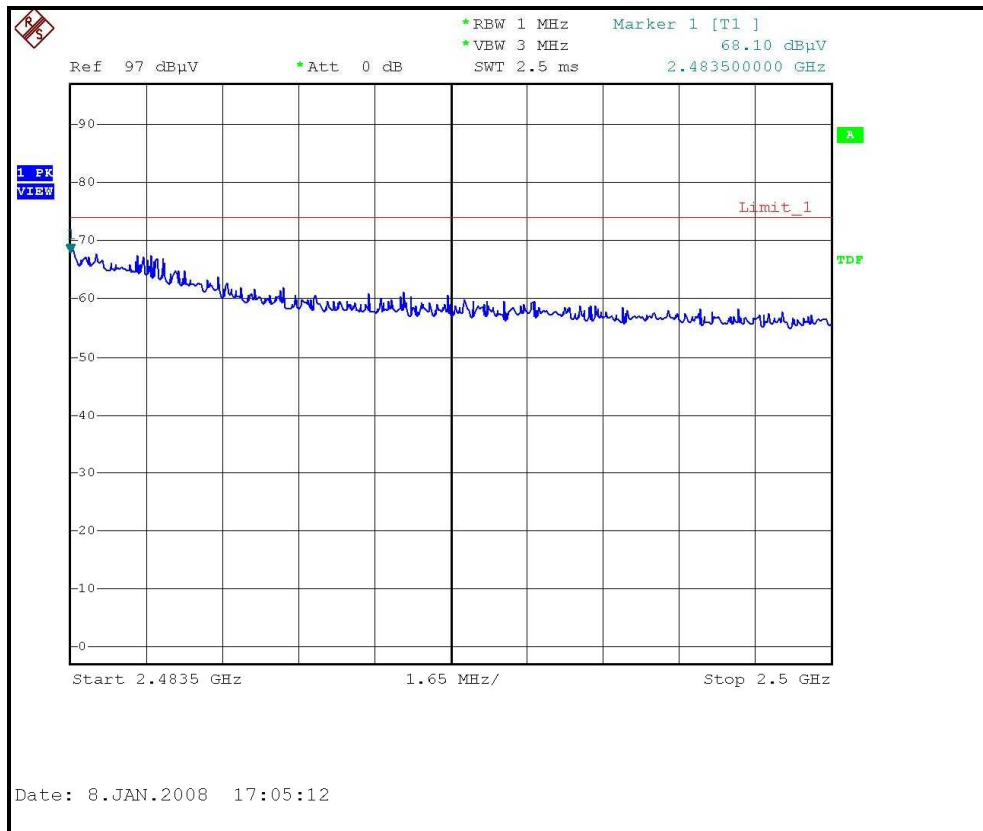



### DRAFT 802.11n (40MHz) OFDM MODULATION

EUT TEST CONDITION		MEASUREMENT DETAIL	
CHANNEL	Channel 1	FREQUENCY RANGE	1 ~ 25GHz
INPUT POWER (SYSTEM)	120Vac, 60 Hz	DETECTOR FUNCTION	Peak (PK) Average (AV)
ENVIRONMENTAL CONDITIONS	20deg. C, 66%RH 975hPa	TESTED BY	Wen Yu

ANTENNA POLARITY & TEST DISTANCE: HORIZONTAL AT 3 M								
NO.	FREQ. (MHz)	EMISSION LEVEL (dBuV/m)	LIMIT (dBuV/m)	MARGIN (dB)	ANTENNA HEIGHT (m)	TABLE ANGLE (Degree)	RAW VALUE (dBuV)	CORRECTION FACTOR (dB/m)
1	2390.00	57.60 PK	74.00	-16.40	1.31 H	20	27.20	30.40
2	2390.00	44.50 AV	54.00	-9.50	1.31 H	20	14.10	30.40
3	*2422.00	92.50 PK			1.24 H	20	61.96	30.54
4	*2422.00	81.30 AV			1.24 H	20	50.76	30.54
5	4844.00	47.33 PK	74.00	-26.67	1.45 H	243	11.59	35.74
6	4844.00	31.63 AV	54.00	-22.37	1.45 H	243	-4.11	35.74
7	7266.00	51.94 PK	74.00	-22.06	1.41 H	208	9.59	42.35
8	7266.00	37.99 AV	54.00	-16.01	1.41 H	208	-4.36	42.35

ANTENNA POLARITY & TEST DISTANCE: VERTICAL AT 3 M								
NO.	FREQ. (MHz)	EMISSION LEVEL (dBuV/m)	LIMIT (dBuV/m)	MARGIN (dB)	ANTENNA HEIGHT (m)	TABLE ANGLE (Degree)	RAW VALUE (dBuV)	CORRECTION FACTOR (dB/m)
1	2390.00	70.56 PK	74.00	-3.44	1.00 V	18	40.16	30.40
2	2390.00	52.54 AV	54.00	-1.46	1.00 V	18	22.14	30.40
3	*2422.00	104.10 PK			1.00 V	21	73.56	30.54
4	*2422.00	93.30 AV			1.00 V	21	62.76	30.54
5	4844.00	57.66 PK	74.00	-16.34	1.26 V	68	21.92	35.74
6	4844.00	37.49 AV	54.00	-16.51	1.26 V	68	1.75	35.74
7	7266.00	51.74 PK	74.00	-22.26	1.30 V	179	9.39	42.35
8	7266.00	38.15 AV	54.00	-15.85	1.30 V	179	-4.20	42.35

- REMARKS:**
1. Emission level (dBuV/m) = Raw Value (dBuV) + Correction Factor (dB/m).
  2. Correction Factor (dB/m) = Antenna Factor (dB/m) + Cable Factor (dB).
  3. The other emission levels were very low against the limit.
  4. Margin value = Emission level – Limit value.
  5. “ \* “: Fundamental frequency.

EUT TEST CONDITION		MEASUREMENT DETAIL	
CHANNEL	Channel 4	FREQUENCY RANGE	1 ~ 25GHz
INPUT POWER (SYSTEM)	120Vac, 60 Hz	DETECTOR FUNCTION	Peak (PK) Average (AV)
ENVIRONMENTAL CONDITIONS	20deg. C, 66%RH 975hPa	TESTED BY	Wen Yu

ANTENNA POLARITY & TEST DISTANCE: HORIZONTAL AT 3 M								
NO.	FREQ. (MHz)	EMISSION LEVEL (dBuV/m)	LIMIT (dBuV/m)	MARGIN (dB)	ANTENNA HEIGHT (m)	TABLE ANGLE (Degree)	RAW VALUE (dBuV)	CORRECTION FACTOR (dB/m)
1	*2437.00	95.10 PK			1.24 H	101	64.49	30.61
2	*2437.00	83.60 AV			1.24 H	101	52.99	30.61
3	4874.00	47.46 PK	74.00	-26.54	1.44 H	246	11.66	35.80
4	4874.00	31.92 AV	54.00	-22.08	1.44 H	246	-3.88	35.80
5	7311.00	52.07 PK	74.00	-21.93	1.40 H	214	9.55	42.52
6	7311.00	38.05 AV	54.00	-15.95	1.40 H	214	-4.47	42.52

ANTENNA POLARITY & TEST DISTANCE: VERTICAL AT 3 M								
NO.	FREQ. (MHz)	EMISSION LEVEL (dBuV/m)	LIMIT (dBuV/m)	MARGIN (dB)	ANTENNA HEIGHT (m)	TABLE ANGLE (Degree)	RAW VALUE (dBuV)	CORRECTION FACTOR (dB/m)
1	*2437.00	104.60 PK			1.00 V	2	73.99	30.61
2	*2437.00	93.40 AV			1.00 V	2	62.79	30.61
3	4874.00	57.75 PK	74.00	-16.25	1.22 V	65	21.95	35.80
4	4874.00	37.62 AV	54.00	-16.38	1.22 V	65	1.82	35.80
5	7311.00	51.83 PK	74.00	-22.17	1.32 V	183	9.31	42.52
6	7311.00	38.24 AV	54.00	-15.76	1.32 V	183	-4.28	42.52

- REMARKS:**
1. Emission level (dBuV/m) = Raw Value (dBuV) + Correction Factor (dB/m).
  2. Correction Factor (dB/m) = Antenna Factor (dB/m) + Cable Factor (dB).
  3. The other emission levels were very low against the limit.
  4. Margin value = Emission level – Limit value.
  5. “ \* “: Fundamental frequency.

EUT TEST CONDITION		MEASUREMENT DETAIL	
CHANNEL	Channel 7	FREQUENCY RANGE	1 ~ 25GHz
INPUT POWER (SYSTEM)	120Vac, 60 Hz	DETECTOR FUNCTION	Peak (PK) Average (AV)
ENVIRONMENTAL CONDITIONS	20deg. C, 66%RH 975hPa	TESTED BY	Wen Yu

ANTENNA POLARITY & TEST DISTANCE: HORIZONTAL AT 3 M								
NO.	FREQ. (MHz)	EMISSION LEVEL (dBuV/m)	LIMIT (dBuV/m)	MARGIN (dB)	ANTENNA HEIGHT (m)	TABLE ANGLE (Degree)	RAW VALUE (dBuV)	CORRECTION FACTOR (dB/m)
1	*2452.00	94.63 PK			1.19 H	153	63.96	30.67
2	*2452.00	82.39 AV			1.19 H	153	51.72	30.67
3	2483.50	58.88 PK	74.00	-15.12	1.18 H	216	28.06	30.82
4	2483.50	45.24 AV	54.00	-8.76	1.18 H	216	14.42	30.82
5	4904.00	44.72 PK	74.00	-29.28	1.45 H	16	8.86	35.86
6	4904.00	31.01 AV	54.00	-22.99	1.45 H	16	-4.85	35.86
7	7356.00	52.95 PK	74.00	-21.05	1.38 H	216	10.27	42.68
8	7356.00	38.50 AV	54.00	-15.50	1.38 H	216	-4.18	42.68

ANTENNA POLARITY & TEST DISTANCE: VERTICAL AT 3 M								
NO.	FREQ. (MHz)	EMISSION LEVEL (dBuV/m)	LIMIT (dBuV/m)	MARGIN (dB)	ANTENNA HEIGHT (m)	TABLE ANGLE (Degree)	RAW VALUE (dBuV)	CORRECTION FACTOR (dB/m)
1	*2452.00	102.94 PK			1.00 V	345	72.27	30.67
2	*2452.00	91.92 AV			1.00 V	345	61.25	30.67
3	2484.12	67.88 PK	74.00	-6.12	1.00 V	345	37.06	30.82
4	2484.12	52.98 AV	54.00	-1.02	1.00 V	345	22.16	30.82
5	4904.00	51.04 PK	74.00	-22.96	1.12 V	17	15.18	35.86
6	4904.00	33.14 AV	54.00	-20.86	1.12 V	17	-2.72	35.86
7	7356.00	52.24 PK	74.00	-21.76	1.35 V	168	9.56	42.68
8	7356.00	38.49 AV	54.00	-15.51	1.35 V	168	-4.19	42.68

- REMARKS:**
1. Emission level (dBuV/m) = Raw Value (dBuV) + Correction Factor (dB/m).
  2. Correction Factor (dB/m) = Antenna Factor (dB/m) + Cable Factor (dB).
  3. The other emission levels were very low against the limit.
  4. Margin value = Emission level – Limit value.
  5. “ \* “: Fundamental frequency.





RESTRICTED BANDEDGE (DRAFT 802.11n (40MHz) MODE,CH7, HORIZONTAL )

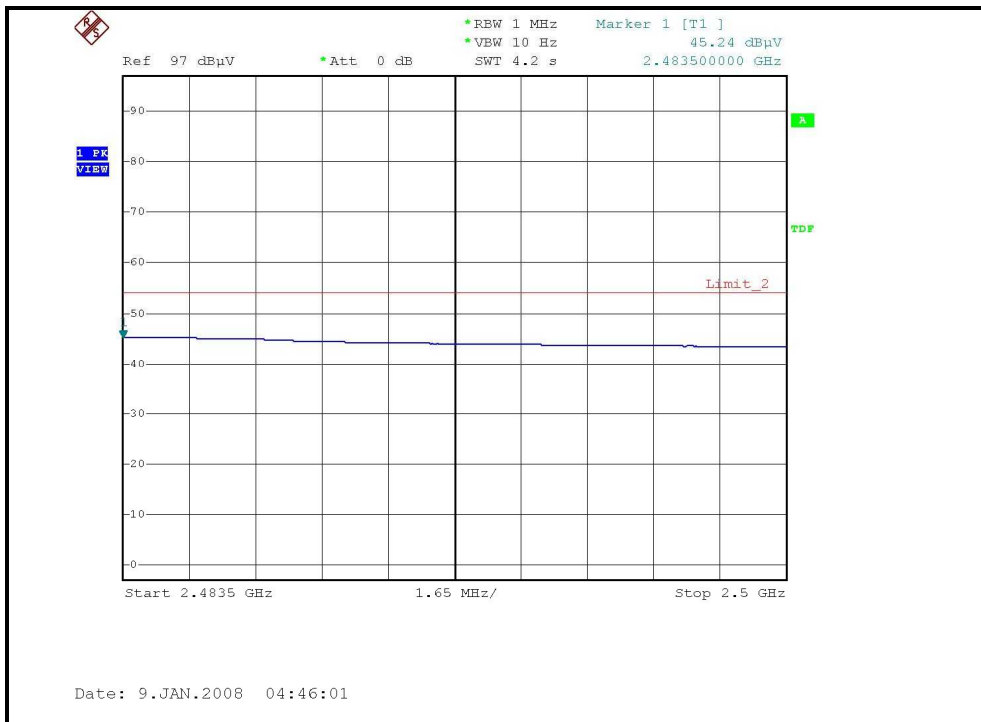
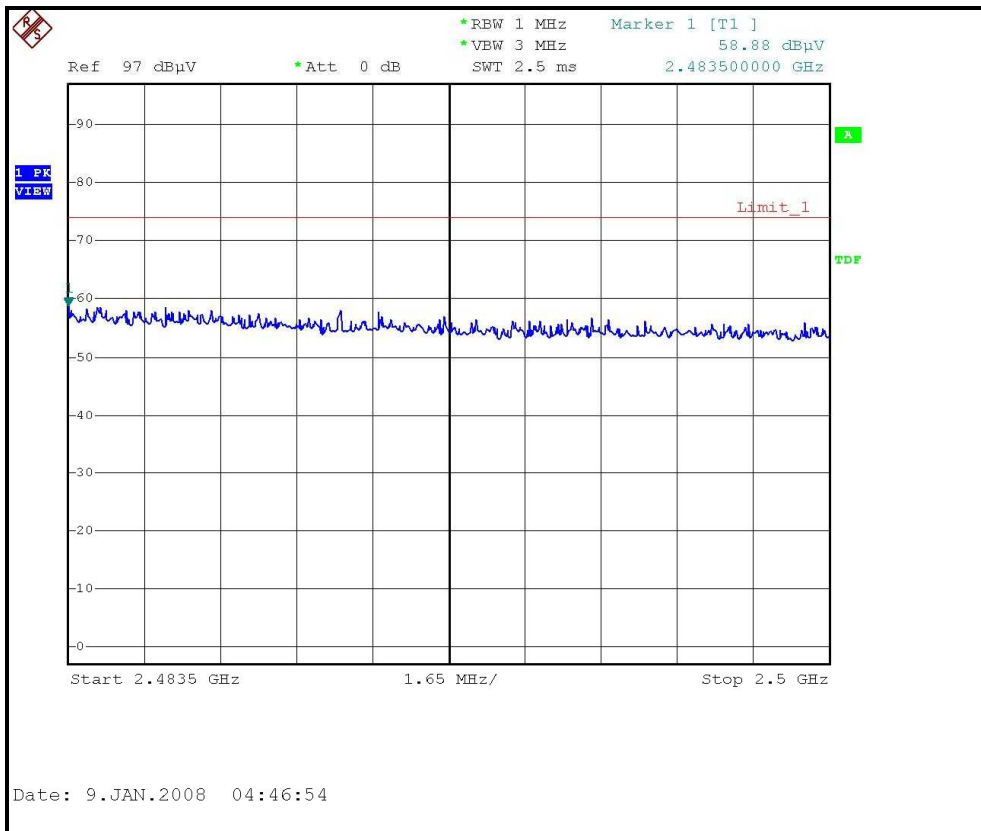







### 4.3 6DB BANDWIDTH MEASUREMENT

#### 4.3.1 LIMITS OF 6dB BANDWIDTH MEASUREMENT

The minimum of 6dB Bandwidth Measurement is 0.5 MHz.

#### 4.3.2 TEST INSTRUMENTS

Description & Manufacturer	Model No.	Serial No.	Calibrated Until
R&S SPECTRUM ANALYZER	FSP40	100037	Dec. 17, 2008

**NOTE:**

- 1.The measurement uncertainty is less than +/- 2.6dB, which is calculated as per the NAMAS document NIS81. This uncertainty represents an expanded uncertainty expressed at approximately the 95% confidence level using a coverage factor of k=2.
- 2.The calibration interval of the above test instruments is 12 months and the calibrations are traceable to NML/ROC and NIST/USA.

### 4.3.3 TEST PROCEDURE

The transmitter output was connected to the spectrum analyzer through an attenuator. The bandwidth of the fundamental frequency was measured by spectrum analyzer with 100kHz RBW and 100kHz VBW. The 6dB bandwidth is defined as the total spectrum the power of which is higher than peak power minus 6dB.

### 4.3.4 DEVIATION FROM TEST STANDARD

No deviation

### 4.3.5 TEST SETUP



### 4.3.6 EUT OPERATING CONDITIONS

The software provided by client to enable the EUT under transmission condition continuously at lowest, middle and highest channel frequencies individually.

### 4.3.7 TEST RESULTS

#### 802.11b DSSS MODULATION:

<b>MODULATION TYPE</b>	CCK	<b>TRANSFER RATE</b>	11Mbps
<b>INPUT POWER (SYSTEM)</b>	120Vac, 60 Hz	<b>ENVIRONMENTAL CONDITIONS</b>	23deg.C, 62%RH, 975hPa
<b>TESTED BY</b>	Phoenix Huang		

CHANNEL	CHANNEL FREQUENCY (MHz)	6dB BANDWIDTH (MHz)	MINIMUM LIMIT (MHz)	PASS / FAIL
1	2412	12.22	0.5	PASS
6	2437	12.18	0.5	PASS
11	2462	12.19	0.5	PASS

CH1

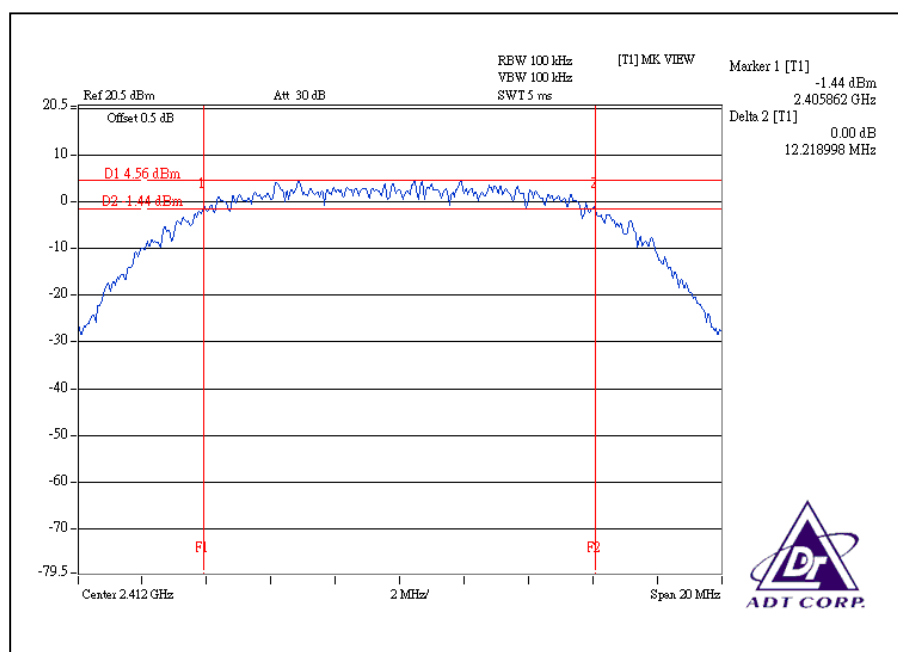

### CH6

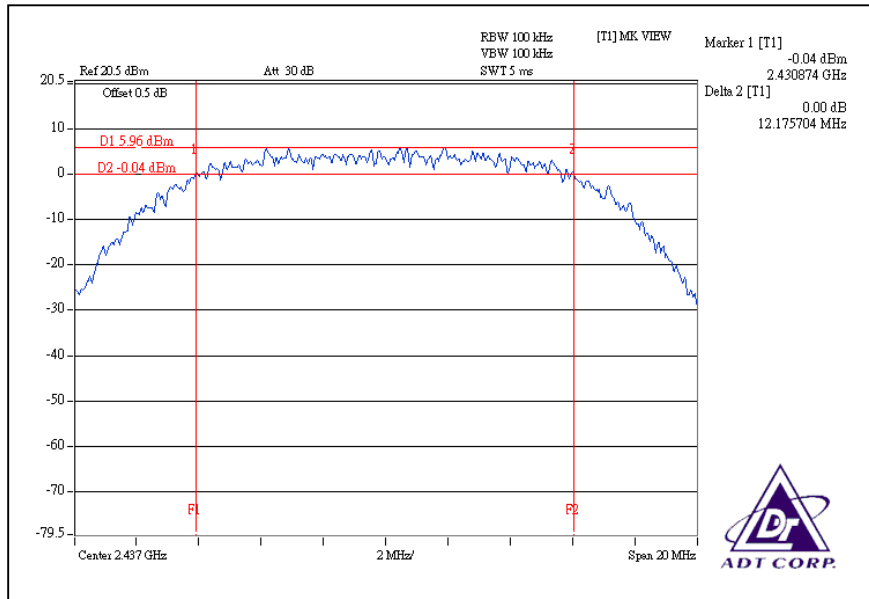

### CH11

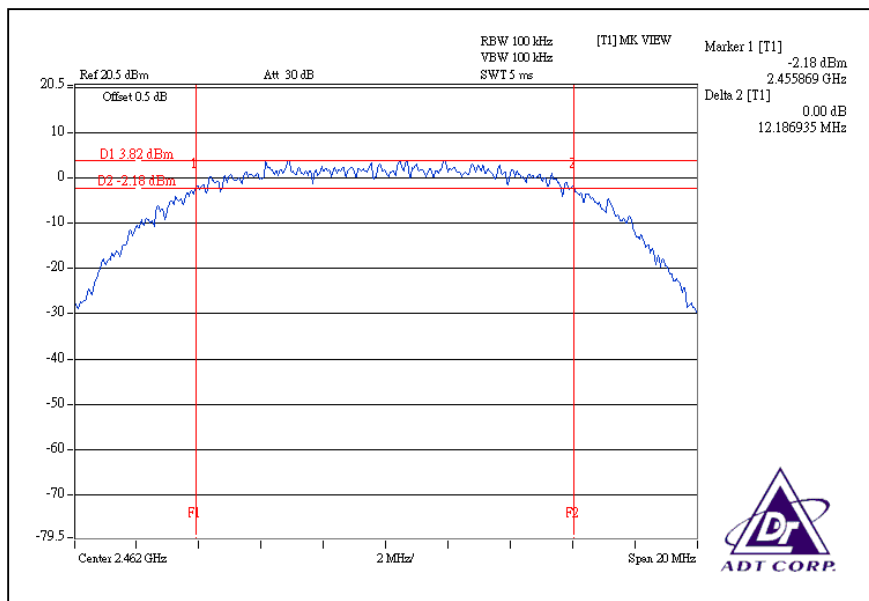

### 802.11g OFDM MODULATION:

<b>MODULATION TYPE</b>	BPSK	<b>TRANSFER RATE</b>	6Mbps
<b>INPUT POWER (SYSTEM)</b>	120Vac, 60 Hz	<b>ENVIRONMENTAL CONDITIONS</b>	26deg.C, 68%RH, 975hPa
<b>TESTED BY</b>	Phoenix Huang		

CHANNEL	CHANNEL FREQUENCY (MHz)	6dB BANDWIDTH (MHz)	MINIMUM LIMIT (MHz)	PASS / FAIL
1	2412	16.61	0.5	PASS
6	2437	16.6	0.5	PASS
11	2462	16.6	0.5	PASS

CH1

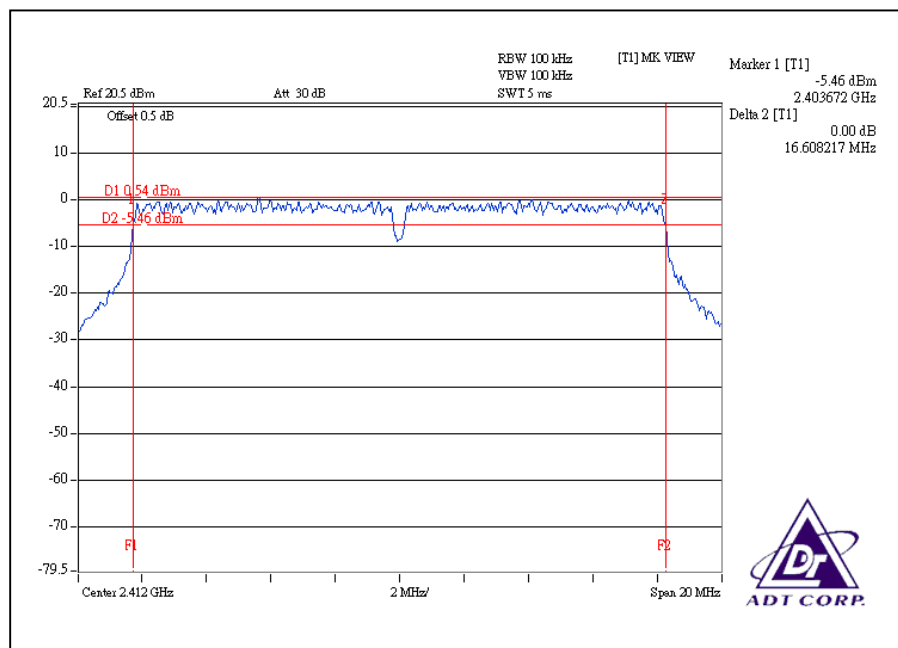

### CH6

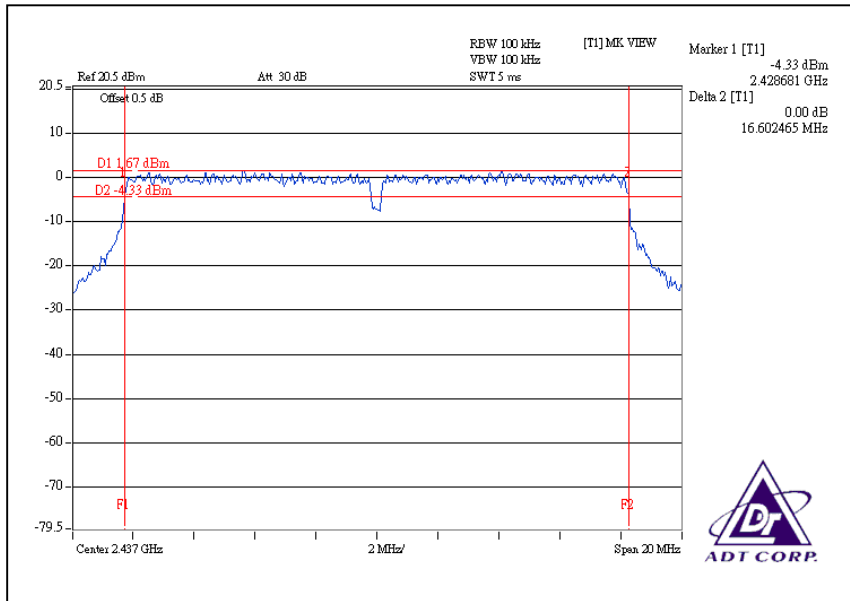

### CH11

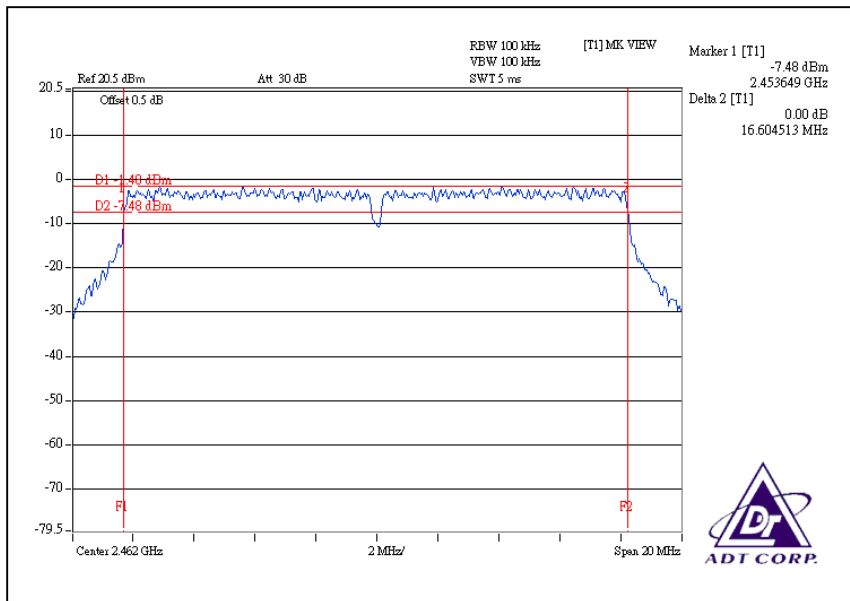

### DRAFT 802.11n (20MHz) OFDM MODULATION:

<b>MODULATION TYPE</b>	BPSK	<b>TRANSFER RATE</b>	7.2Mbps
<b>INPUT POWER (SYSTEM)</b>	120Vac, 60 Hz	<b>ENVIRONMENTAL CONDITIONS</b>	23deg.C, 54%RH, 975hPa
<b>TESTED BY</b>	Phoenix Huang		

CHANNEL	CHANNEL FREQUENCY (MHz)	6dB BANDWIDTH (MHz)		MINIMUM LIMIT (MHz)	PASS / FAIL
		CHAIN(0)	CHAIN(1)		
1	2412	17.76	17.69	0.5	PASS
6	2437	17.78	17.69	0.5	PASS
11	2462	17.77	17.72	0.5	PASS

For Chain(0): CH1

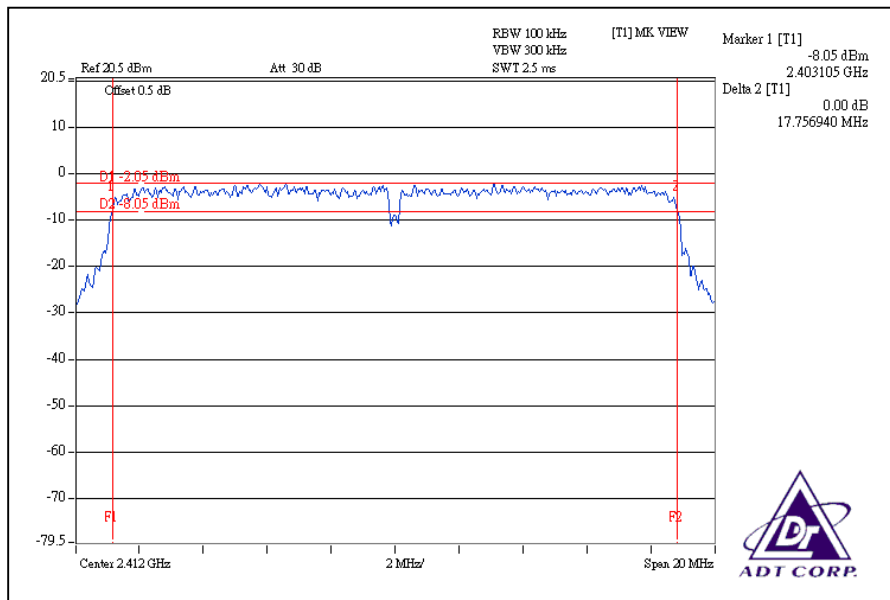

### CH6

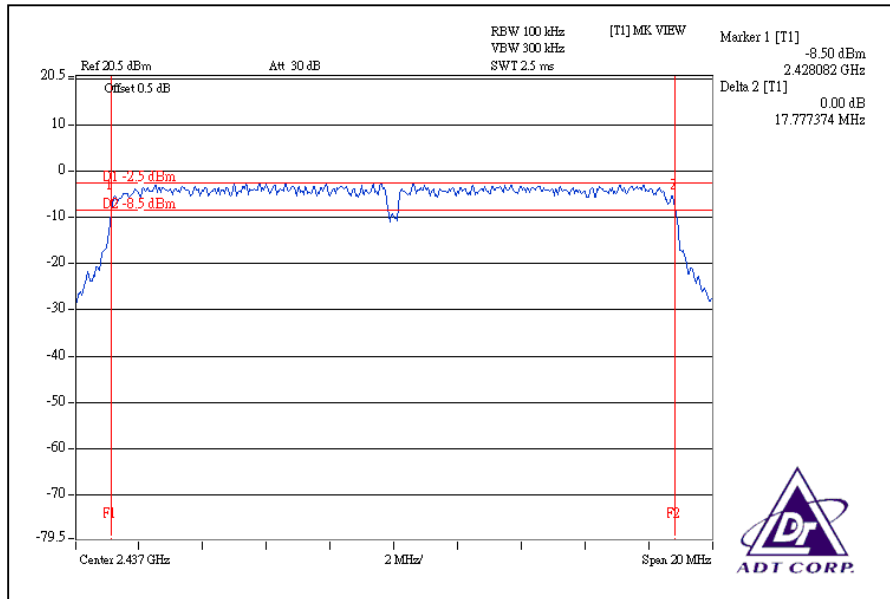

### CH11

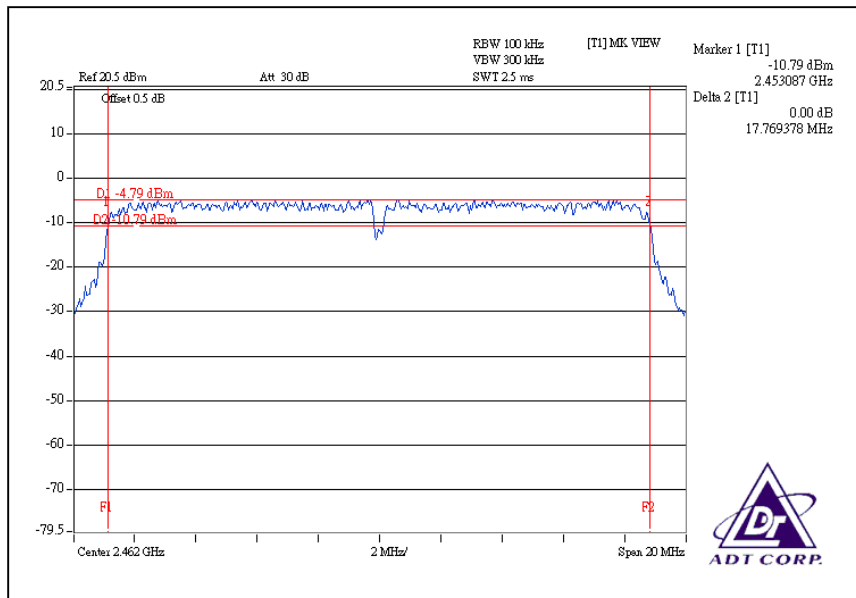



For CHAIN(1): CH1

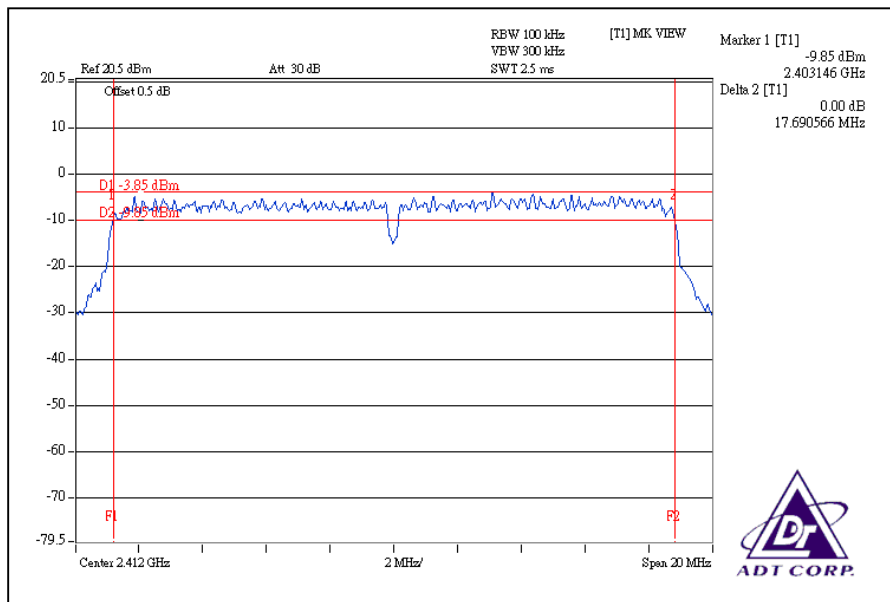

CH6

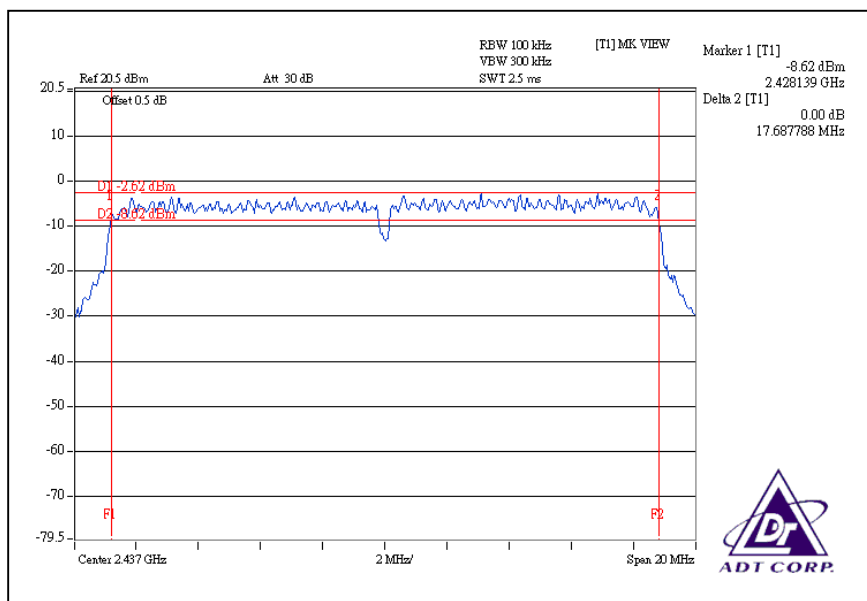

CH11

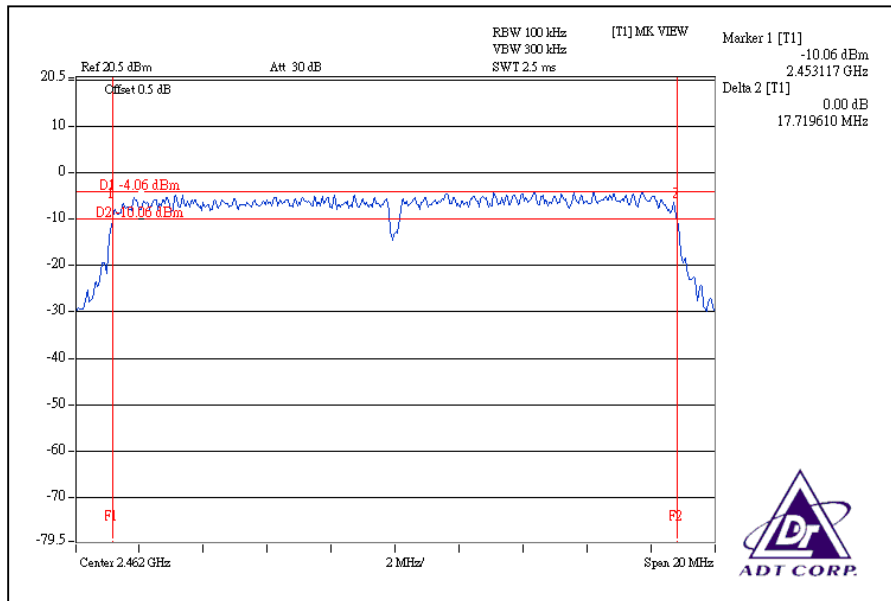

### DRAFT 802.11n (40MHz) OFDM MODULATION:

<b>MODULATION TYPE</b>	BPSK	<b>TRANSFER RATE</b>	15Mbps
<b>INPUT POWER (SYSTEM)</b>	120Vac, 60 Hz	<b>ENVIRONMENTAL CONDITIONS</b>	23deg.C, 54%RH, 975hPa
<b>TESTED BY</b>	Phoenix Huang		

CHANNEL	CHANNEL FREQUENCY (MHz)	6dB BANDWIDTH (MHz)		MINIMUM LIMIT (MHz)	PASS / FAIL
		CHAIN(0)	CHAIN(1)		
1	2422	36.5	35.88	0.5	PASS
4	2437	36.49	35.91	0.5	PASS
7	2452	36.52	35.91	0.5	PASS

For Chain (0): CH1

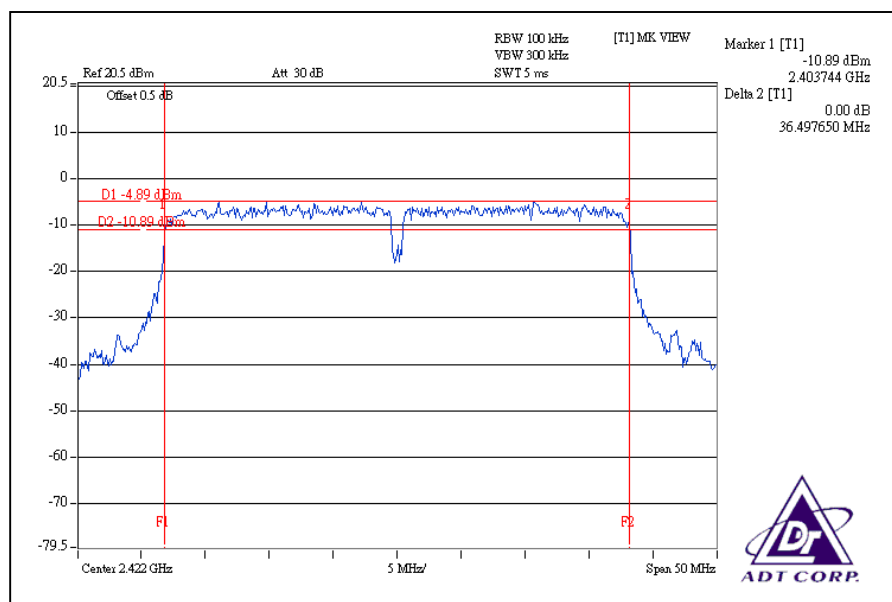

### CH4

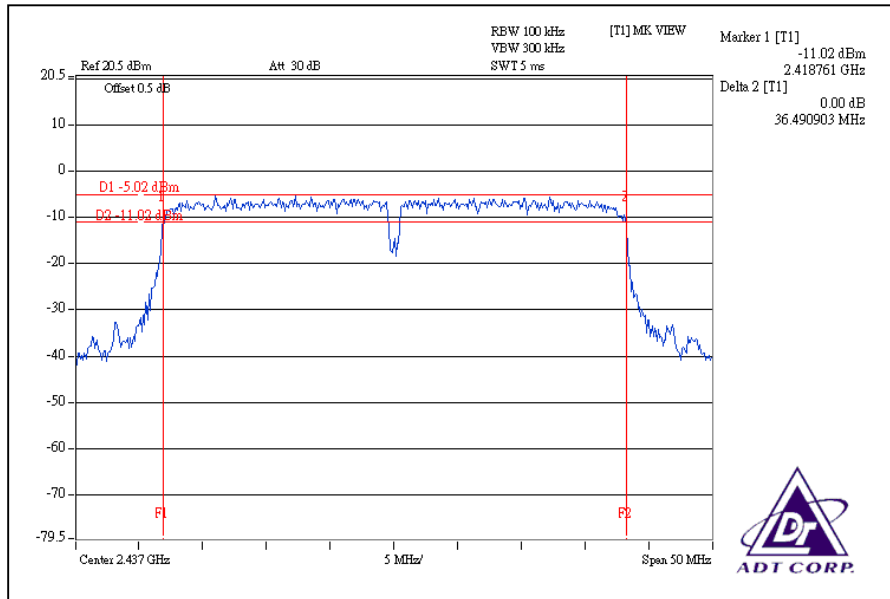

### CH7

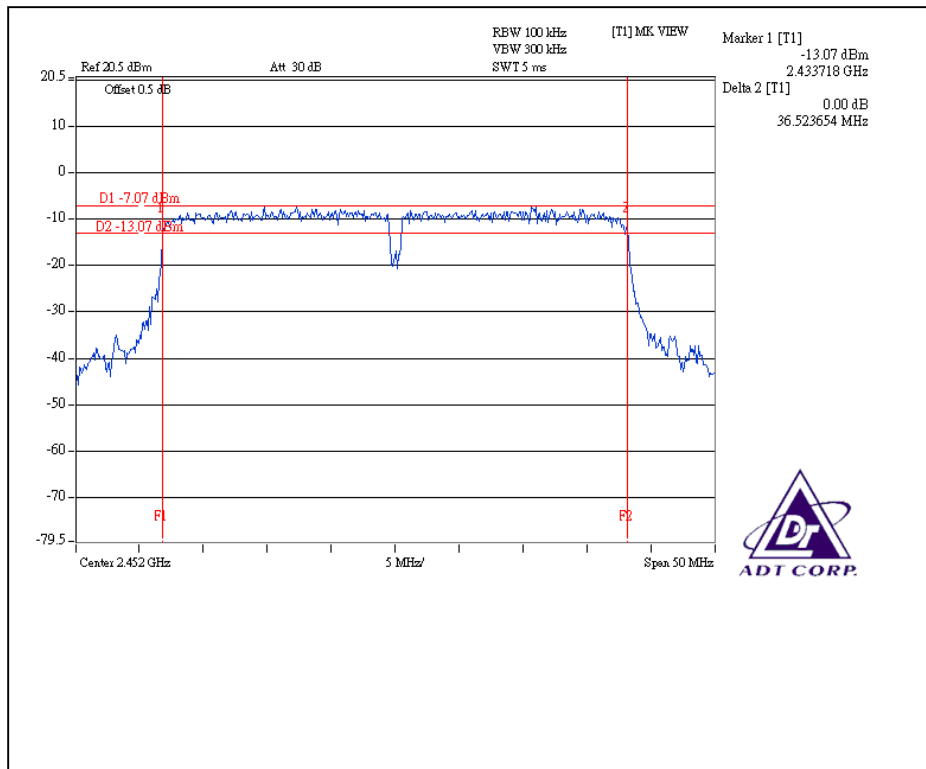

For Chain (1): CH1

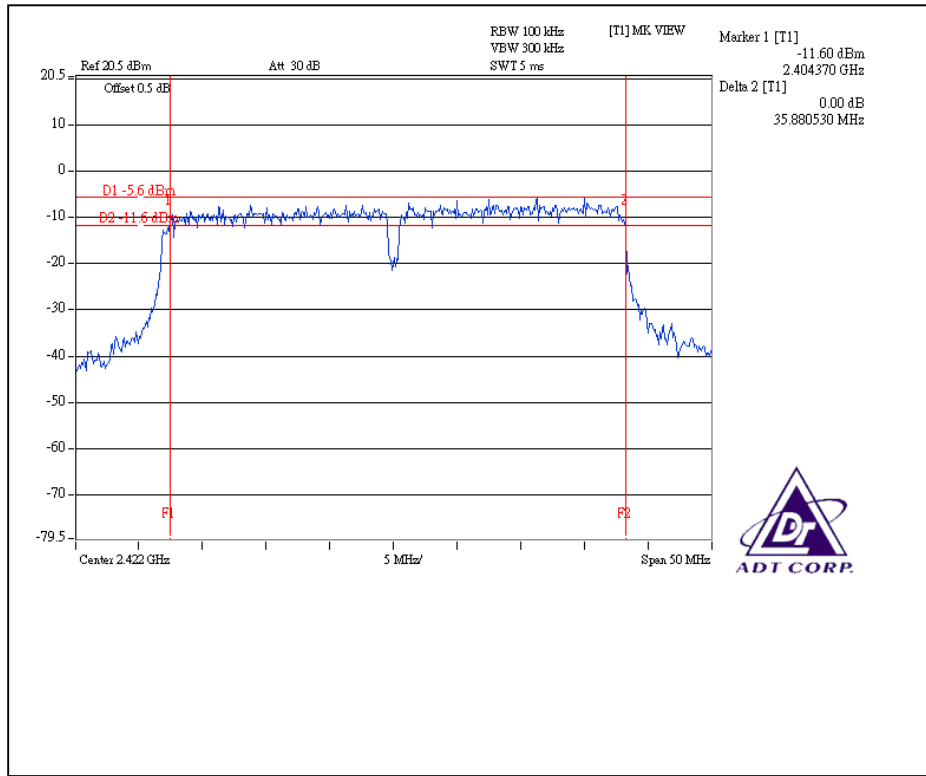

CH4

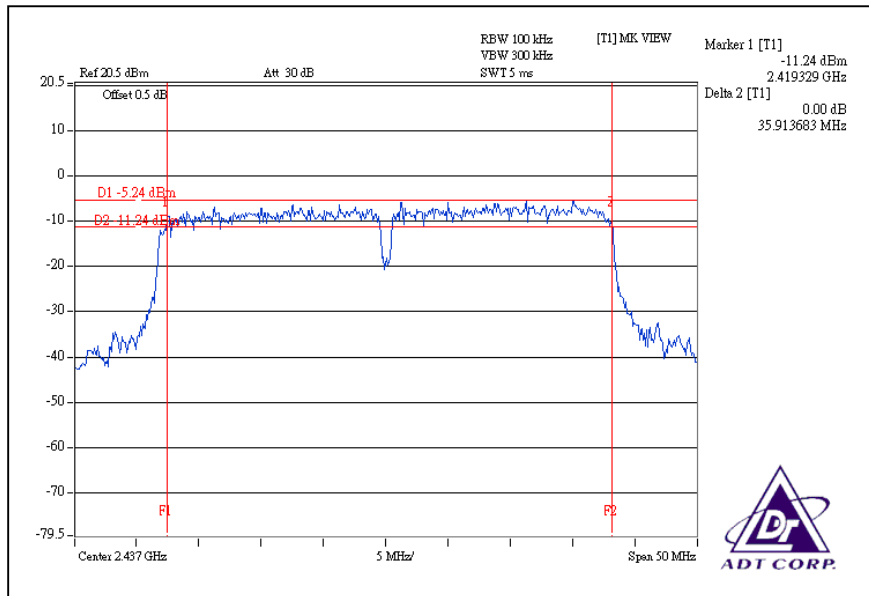

CH7

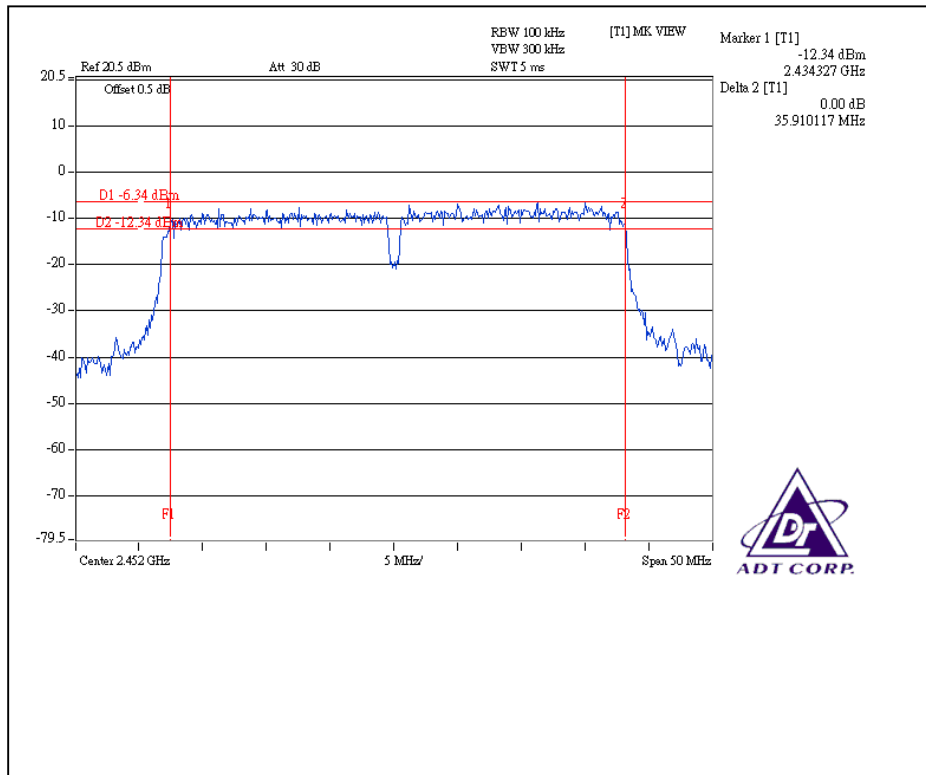

#### 4.4 MAXIMUM PEAK OUTPUT POWER

##### 4.4.1 LIMITS OF MAXIMUM PEAK OUTPUT POWER MEASUREMENT

The Maximum Peak Output Power Measurement is 30dBm.

##### 4.4.2 INSTRUMENTS

Description & Manufacturer	Model No.	Serial No.	Calibrated Until
R&S SPECTRUM ANALYZER	FSP40	100037	Aug. 12, 2008
Agilent SIGNAL GENERATOR	E8257C	MY43320668	Dec. 25, 2008
TEKTRONIX OSCILLOSCOPE	TDS380	B016335	Aug. 15, 2008
NARDA DETECTOR	4503A	FSCM99899	NA

**NOTE:**

The calibration interval of the above test instruments is 12 months and the calibrations are traceable to NML/ROC and NIST/USA.

#### 4.4.3 TEST PROCEDURES

1. A detector was used on the output port of the EUT. An oscilloscope was used to read the response of the detector.
2. Replaced the EUT by the signal generator. The center frequency of the S.G was adjusted to the center frequency of the measured channel.
3. Adjusted the power to have the same reading on oscilloscope. Record the power level.

#### 4.4.4 DEVIATION FROM TEST STANDARD

No deviation

#### 4.4.5 TEST SETUP



#### 4.4.6 EUT OPERATING CONDITIONS

Same as Item 4.3.6



#### 4.4.7 TEST RESULTS

##### 802.11b DSSS MODULATION:

<b>MODULATION TYPE</b>	CCK	<b>TRANSFER RATE</b>	11Mbps
<b>INPUT POWER (SYSTEM)</b>	120Vac, 60 Hz	<b>ENVIRONMENTAL CONDITIONS</b>	23deg.C, 62%RH, 975hPa
<b>TESTED BY</b>	Phoenix Huang		

CHANNEL	CHANNEL FREQUENCY (MHz)	PEAK POWER OUTPUT (mW)	PEAK POWER OUTPUT (dBm)	PEAK POWER LIMIT (dBm)	PASS / FAIL
1	2412	63.096	18.00	30	PASS
6	2437	83.176	19.20	30	PASS
11	2462	53.703	17.30	30	PASS

##### 802.11g OFDM MODULATION:

<b>MODULATION TYPE</b>	BPSK	<b>TRANSFER RATE</b>	6Mbps
<b>INPUT POWER (SYSTEM)</b>	120Vac, 60 Hz	<b>ENVIRONMENTAL CONDITIONS</b>	23deg.C, 62%RH, 975hPa
<b>TESTED BY</b>	Phoenix Huang		

CHANNEL	CHANNEL FREQUENCY (MHz)	PEAK POWER OUTPUT (mW)	PEAK POWER OUTPUT (dBm)	PEAK POWER LIMIT (dBm)	PASS / FAIL
1	2412	80.168	19.04	30	PASS
6	2437	107.647	20.32	30	PASS
11	2462	53.580	17.29	30	PASS

### DRAFT 802.11n (20MHz) OFDM MODULATION:

<b>MODULATION TYPE</b>	BPSK	<b>TRANSFER RATE</b>	7.2Mbps
<b>INPUT POWER (SYSTEM)</b>	120Vac, 60 Hz	<b>ENVIRONMENTAL CONDITIONS</b>	23deg.C, 54%RH, 975hPa
<b>TESTED BY</b>	Phoenix Huang		

CHANNEL	CHANNEL FREQUENCY (MHz)	PEAK POWER OUTPUT (mW)		PEAK POWER OUTPUT (dBm)		TOTAL PEAK POWER (mW)	TOTAL PEAK POWER (dBm)	PEAK POWER LIMIT (dBm)	PASS / FAIL
		CHAIN(0)	CHAIN(1)	CHAIN(0)	CHAIN(1)				
1	2412	40.738	25.119	16.10	14.00	65.857	18.19	30	PASS
6	2437	39.811	28.184	16.00	14.50	67.995	18.32	30	PASS
11	2462	25.704	25.119	14.10	14.00	50.823	17.06	30	PASS

### DRAFT 802.11n (40MHz) OFDM MODULATION:

<b>MODULATION TYPE</b>	BPSK	<b>TRANSFER RATE</b>	15Mbps
<b>INPUT POWER (SYSTEM)</b>	120Vac, 60 Hz	<b>ENVIRONMENTAL CONDITIONS</b>	23deg.C, 54%RH, 975hPa
<b>TESTED BY</b>	Phoenix Huang		

CHANNEL	CHANNEL FREQUENCY (MHz)	PEAK POWER OUTPUT (mW)		PEAK POWER OUTPUT (dBm)		TOTAL PEAK POWER (mW)	TOTAL PEAK POWER (dBm)	PEAK POWER LIMIT (dBm)	PASS / FAIL
		CHAIN(0)	CHAIN(1)	CHAIN(0)	CHAIN(1)				
1	2422	32.734	23.988	15.15	13.80	56.722	17.54	30	PASS
4	2437	39.811	25.119	16.00	14.00	64.930	18.12	30	PASS
7	2452	20.417	16.982	13.10	12.30	37.399	15.73	30	PASS



## 4.5 POWER SPECTRAL DENSITY MEASUREMENT

### 4.5.1 LIMITS OF POWER SPECTRAL DENSITY MEASUREMENT

The Maximum of Power Spectral Density Measurement is 8dBm.

### 4.5.2 TEST INSTRUMENTS

Description & Manufacturer	Model No.	Serial No.	Calibrated Until
R&S SPECTRUM ANALYZER	FSP40	100037	Sep. 06, 2008

**NOTE:**

- 1.The measurement uncertainty is less than +/- 2.6dB, which is calculated as per the NAMAS document NIS81. This uncertainty represents an expanded uncertainty expressed at approximately the 95% confidence level using a coverage factor of k=2.
- 2.The calibration interval of the above test instruments is 12 months and the calibrations are traceable to NML/ROC and NIST/USA.

#### 4.5.3 TEST PROCEDURE

The transmitter output was connected to the spectrum analyzer through an attenuator, the bandwidth of the fundamental frequency was measured with the spectrum analyzer using 3kHz RBW and 30kHz VBW, set sweep time = span/3kHz. The power spectral density was measured and recorded.

The sweep time is allowed to be longer than span/3kHz for a full response of the mixer in the spectrum analyzer.

#### 4.5.4 DEVIATION FROM TEST STANDARD

No deviation

#### 4.5.5 TEST SETUP

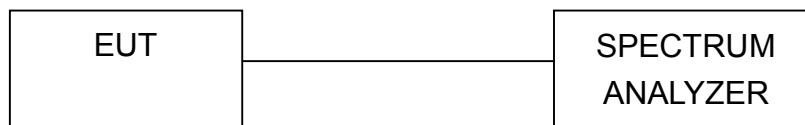

#### 4.5.6 EUT OPERATING CONDITION

Same as Item 4.3.6

## 4.5.7 TEST RESULTS

### 802.11b DSSS MODULATION:

<b>MODULATION TYPE</b>	CCK	<b>TRANSFER RATE</b>	11Mbps
<b>INPUT POWER (SYSTEM)</b>	120Vac, 60 Hz	<b>ENVIRONMENTAL CONDITIONS</b>	23deg.C, 62%RH, 975hPa
<b>TESTED BY</b>	Phoenix Huang		

CHANNEL	CHANNEL FREQUENCY (MHz )	RF POWER LEVEL IN 3kHz BW (dBm)	MAXIMUM LIMIT (dBm)	PASS / FAIL
1	2412	-8.30	8	PASS
6	2437	-6.90	8	PASS
11	2462	-8.95	8	PASS

CH1

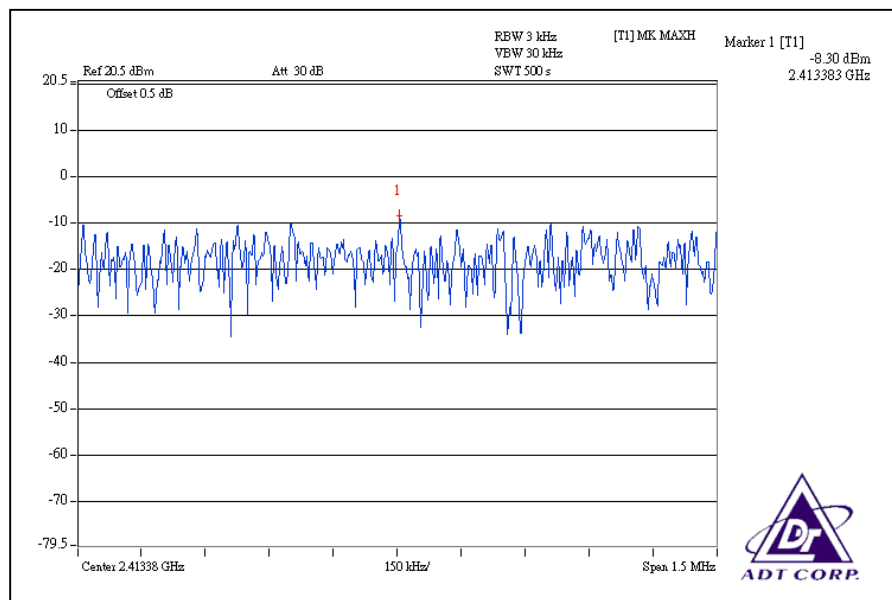

### CH6

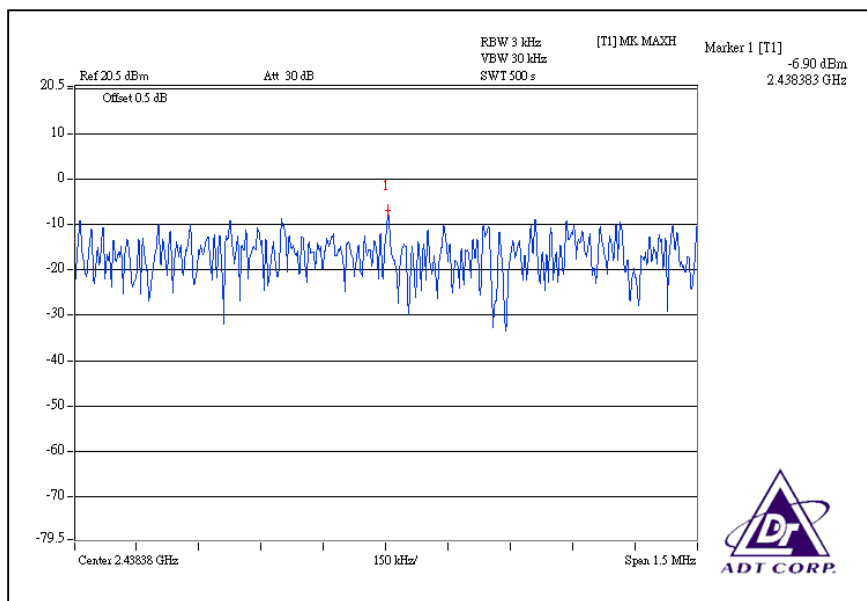

### CH11

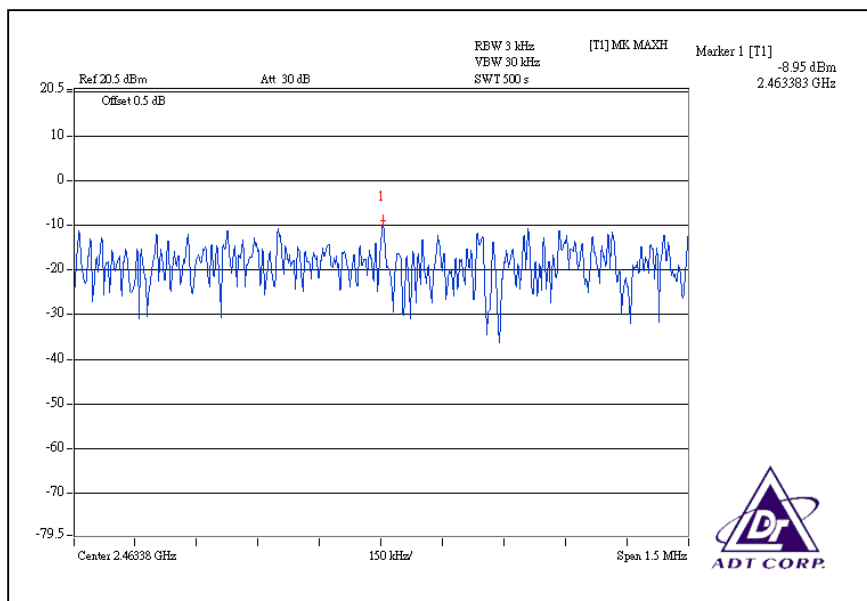

### 802.11g OFDM MODULATION:

<b>MODULATION TYPE</b>	BPSK	<b>TRANSFER RATE</b>	6Mbps
<b>INPUT POWER (SYSTEM)</b>	120Vac, 60 Hz	<b>ENVIRONMENTAL CONDITIONS</b>	23deg.C, 54%RH, 975hPa
<b>TESTED BY</b>	Phoenix Huang		

CHANNEL	CHANNEL FREQUENCY (MHz )	RF POWER LEVEL IN 3kHz BW (dBm)	MAXIMUM LIMIT (dBm)	PASS / FAIL
1	2412	-13.97	8	PASS
6	2437	-12.77	8	PASS
11	2462	-15.16	8	PASS

CH1

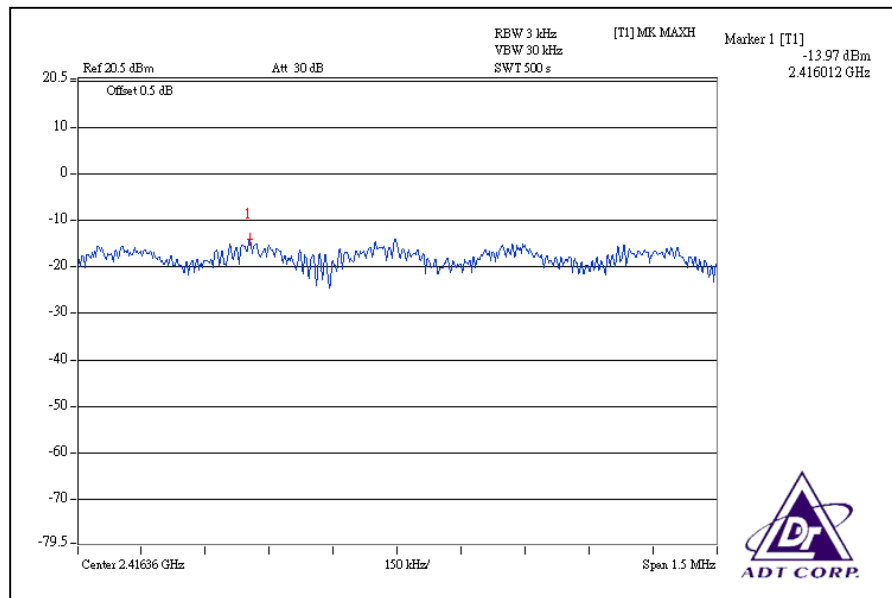

CH6

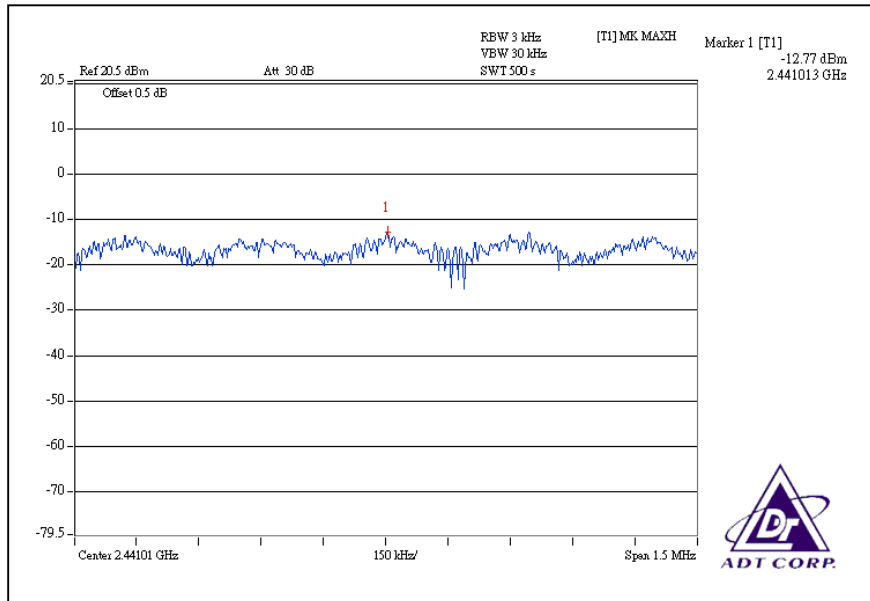

CH11

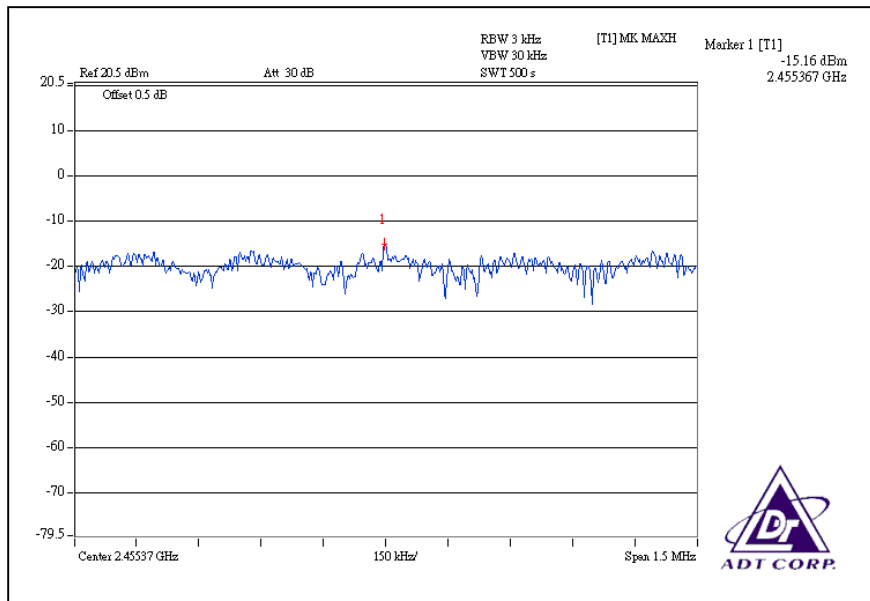



### DRAFT 802.11n (20MHz) OFDM MODULATION:

<b>MODULATION TYPE</b>	BPSK	<b>TRANSFER RATE</b>	7.2Mbps
<b>INPUT POWER (SYSTEM)</b>	120Vac, 60 Hz	<b>ENVIRONMENTAL CONDITIONS</b>	23 deg.C, 54%RH, 975hPa
<b>TESTED BY</b>	Phoenix Huang		

CHANNEL	CHANNEL FREQUENCY (MHz)	RF POWER LEVEL IN 3kHz BW (mW)		RF POWER LEVEL IN 3kHz BW (dBm)		TOTAL POWER DENSITY (mW)	TOTAL POWER DENSITY (dBm)	MAXIMUM LIMIT (dBm)	PASS / FAIL
		CHAIN(0)	CHAIN(1)	CHAIN(0)	CHAIN(1)				
1	2412	0.028	0.011	-15.49	-19.65	0.039	-14.080	8	PASS
6	2437	0.029	0.020	-15.44	-17.01	0.048	-13.144	8	PASS
11	2462	0.016	0.016	-17.94	-17.87	0.032	-14.895	8	PASS

For Chain(0): CH1

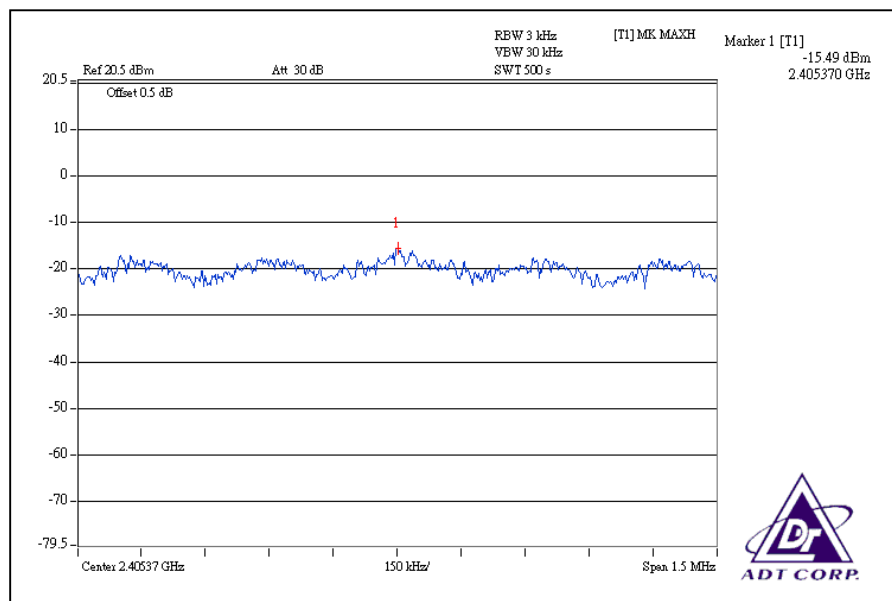

### CH6

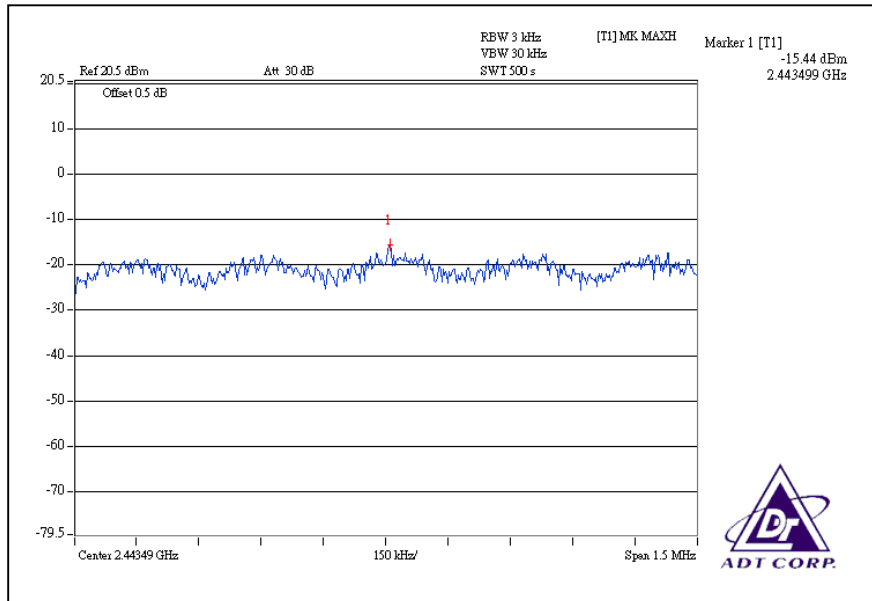

### CH11

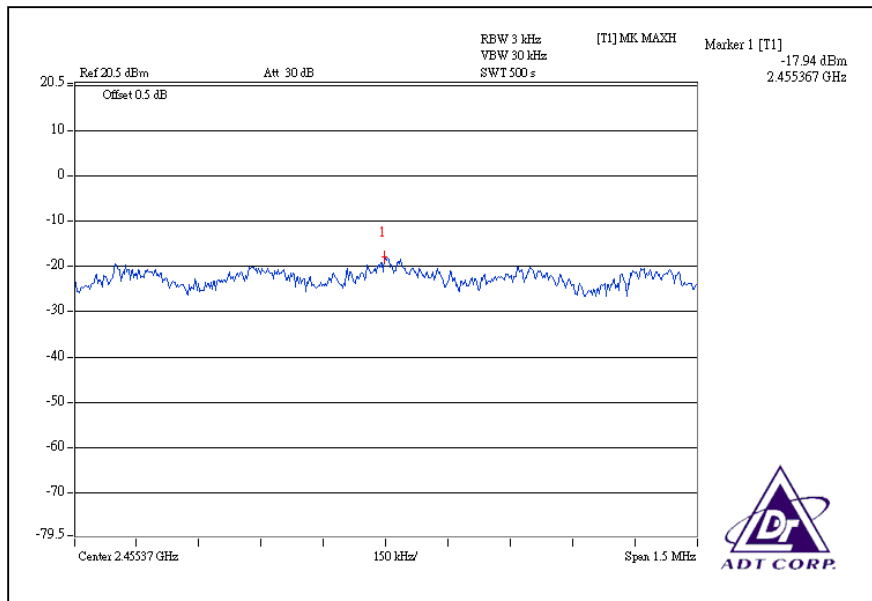

### For Chain (1): CH1

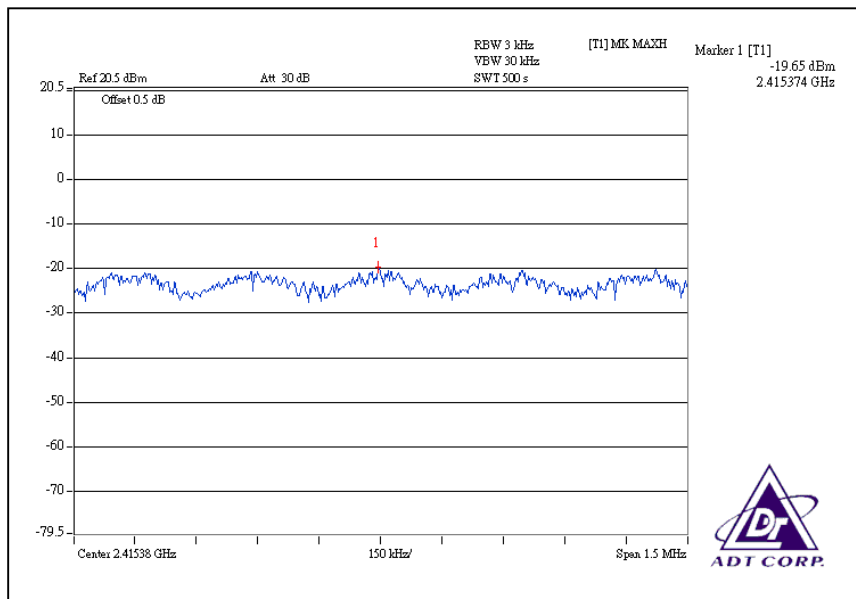

### CH6

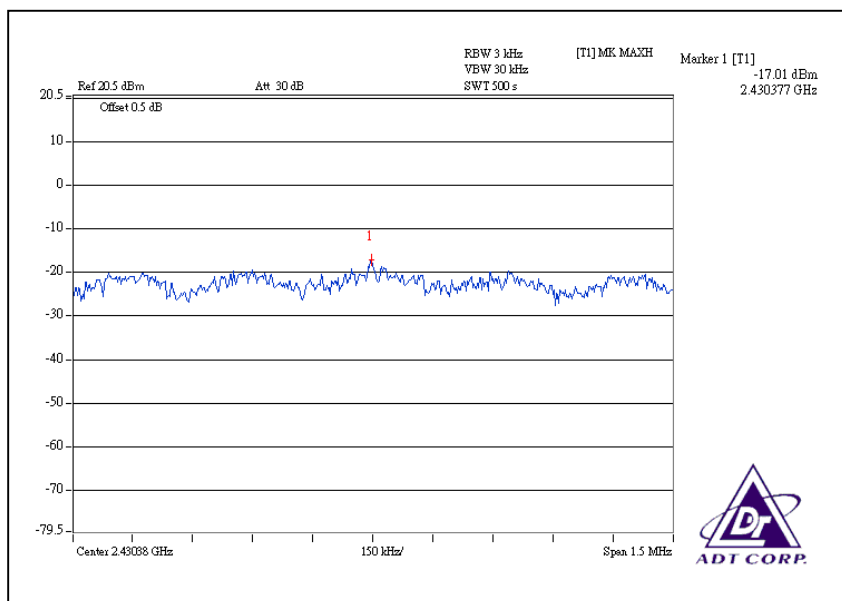

CH11

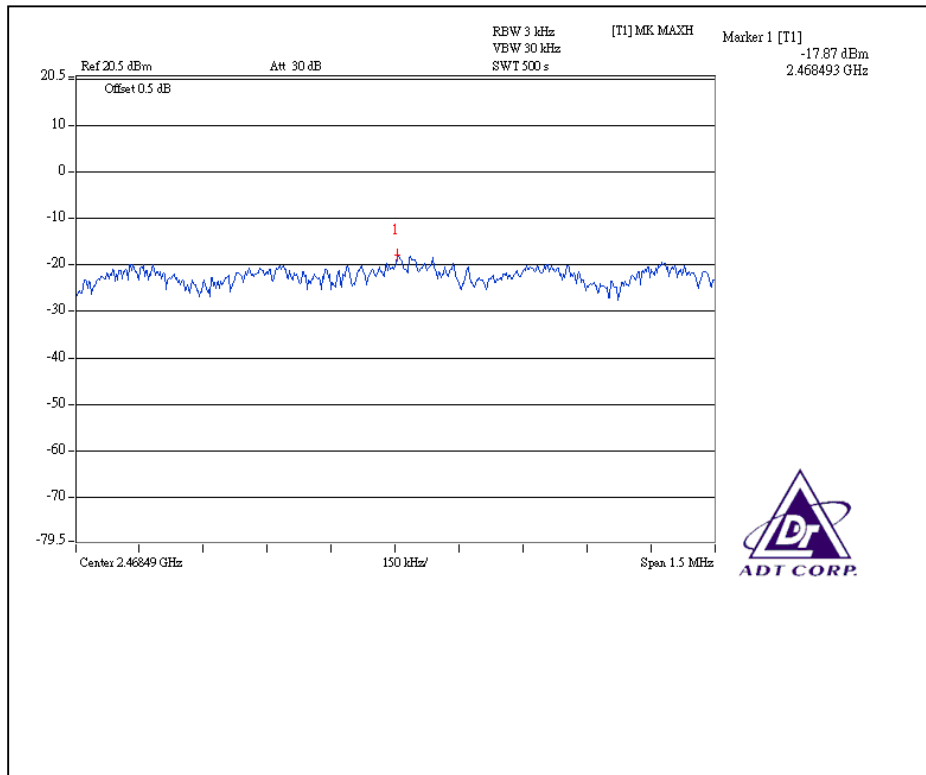

### DRAFT 802.11n (40MHz) OFDM MODULATION:

<b>MODULATION TYPE</b>	BPSK	<b>TRANSFER RATE</b>	15Mbps
<b>INPUT POWER (SYSTEM)</b>	120Vac, 60 Hz	<b>ENVIRONMENTAL CONDITIONS</b>	23deg.C, 54%RH, 975hPa
<b>TESTED BY</b>	Phoenix Huang		

CHANNEL	CHANNEL FREQUENCY (MHz)	RF POWER LEVEL IN 3kHz BW (mW)		RF POWER LEVEL IN 3kHz BW (dBm)		TOTAL POWER DENSITY (mW)	TOTAL POWER DENSITY (dBm)	MAXIMUM LIMIT (dBm)	PASS / FAIL
		CHAIN(0)	CHAIN(1)	CHAIN(0)	CHAIN(1)				
1	2422	0.013	0.010	-18.87	-19.89	0.023	-16.340	8	PASS
4	2437	0.013	0.012	-18.72	-19.26	0.025	-15.971	8	PASS
7	2452	0.011	0.009	-19.58	-20.48	0.020	-16.996	8	PASS

For Chain (0): CH1

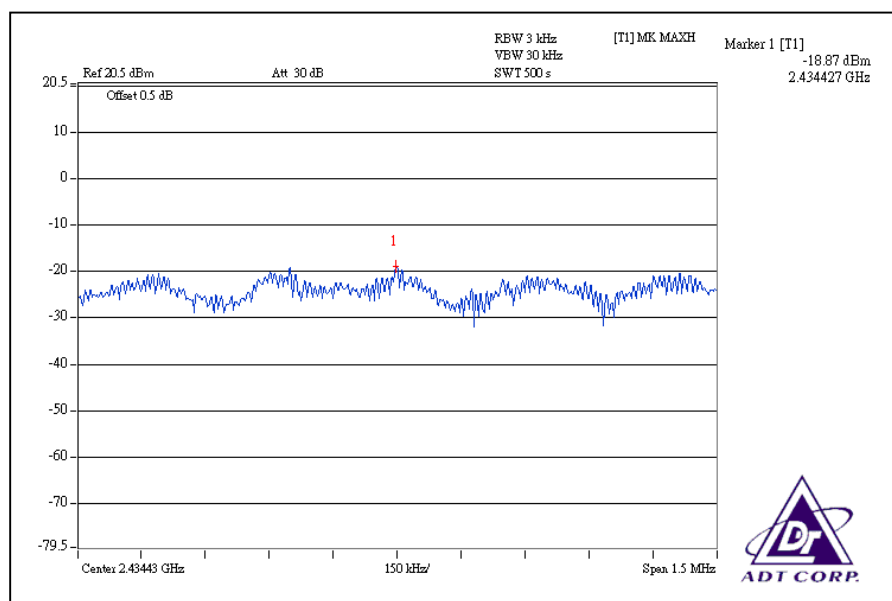



For Chain (1): CH1

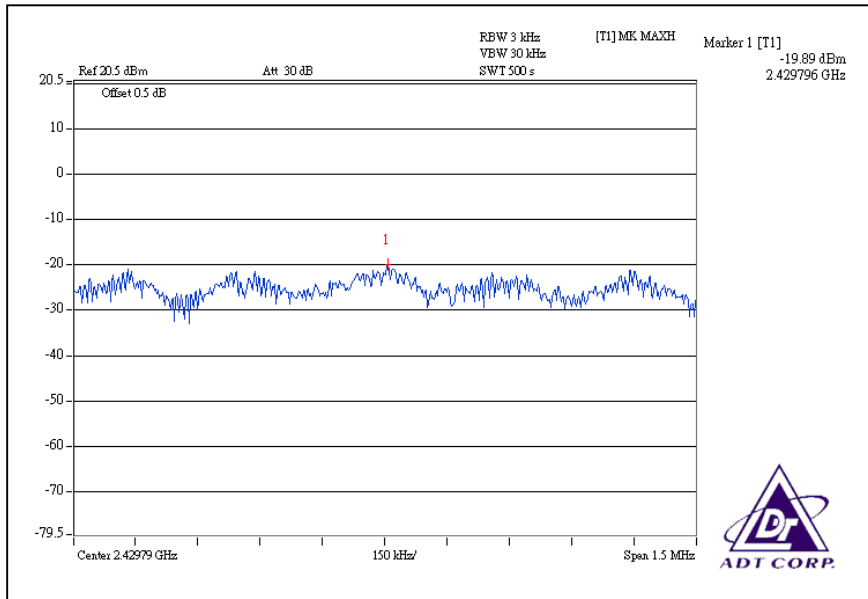

CH4

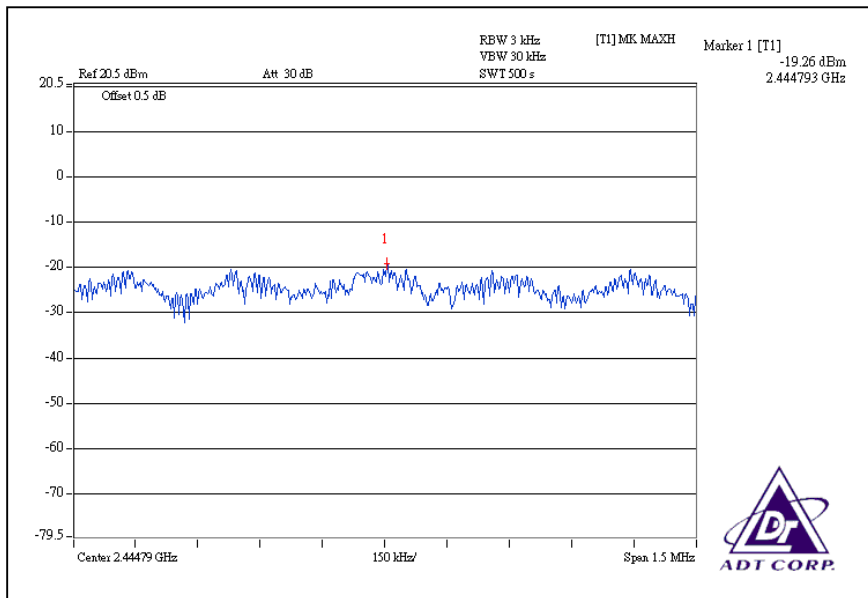

CH7

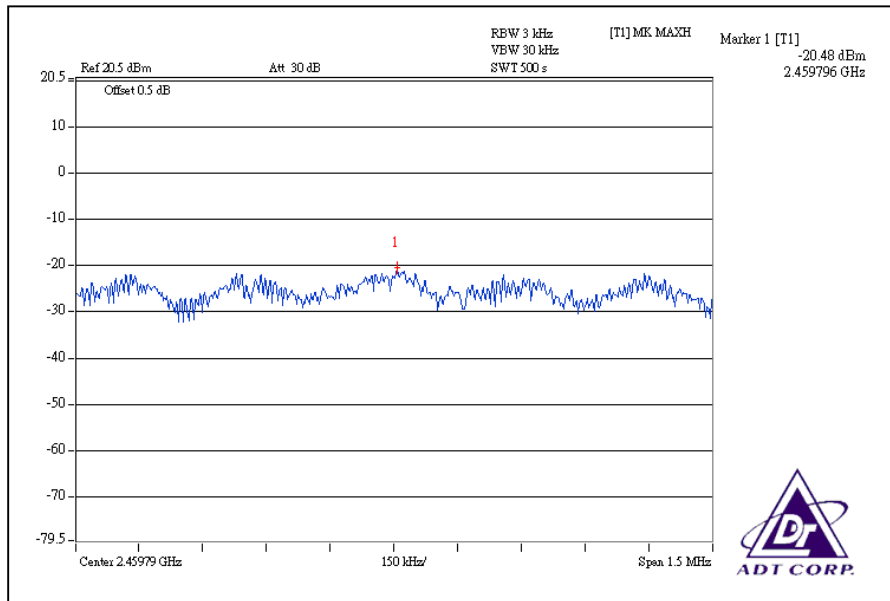



## 4.6 BAND EDGES MEASUREMENT

### 4.6.1 LIMITS OF BAND EDGES MEASUREMENT

Below  $-20\text{dB}$  of the highest emission level of operating band (in 100KHz Resolution Bandwidth).

### 4.6.2 TEST INSTRUMENTS

Description & Manufacturer	Model No.	Serial No.	Calibrated Until
R&S SPECTRUM ANALYZER	FSP40	100037	Sep. 06, 2008

**NOTE:**

- 1.The measurement uncertainty is less than  $\pm 2.6\text{dB}$ , which is calculated as per the NAMAS document NIS81. This uncertainty represents an expanded uncertainty expressed at approximately the 95% confidence level using a coverage factor of  $k=2$ .
- 2.The calibration interval of the above test instruments is 12 months and the calibrations are traceable to NML/ROC and NIST/USA.

### 4.6.3 TEST PROCEDURE

The transmitter output was connected to the spectrum analyzer via a low loss cable. Set both RBW of spectrum analyzer to 100kHz and VBW of spectrum analyzer to 300kHz with suitable frequency span including 100 MHz bandwidth from band edge. The band edges was measured and recorded.

The spectrum plots (RBW = 100kHz & VBW = 300kHz) are attached on the following pages.

#### 4.6.4 DEVIATION FROM TEST STANDARD

No deviation

#### 4.6.5 EUT OPERATING CONDITION

Same as Item 4.3.6

#### 4.6.6 TEST RESULTS

The spectrum plots are attached on the following pages. D1 line indicates the highest level, and D2 line indicates the 20dB offset below D1. It shows compliance with the requirement in part 15.247(d).

## 802.11b DSSS MODULATION: CH1

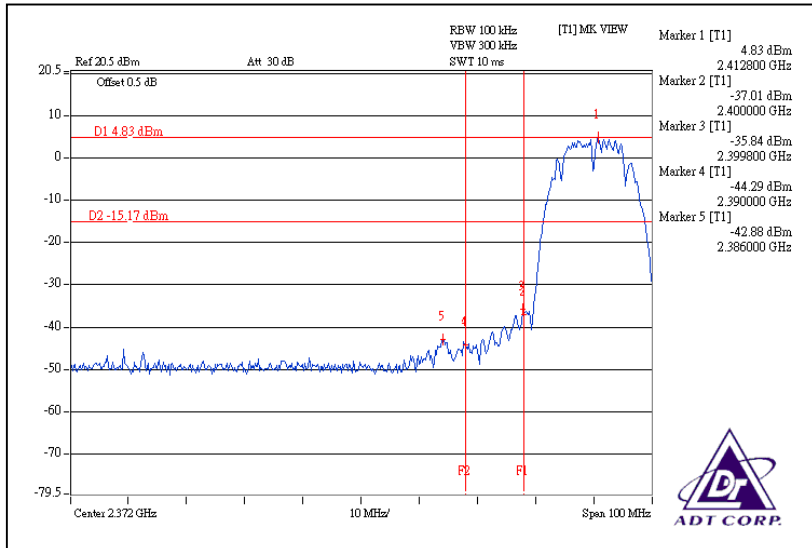

## CH11

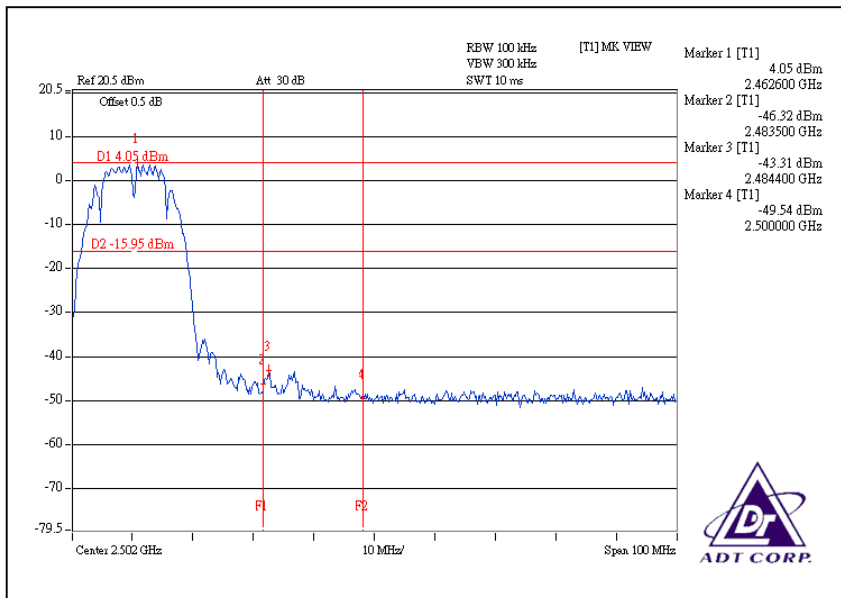

### CH1

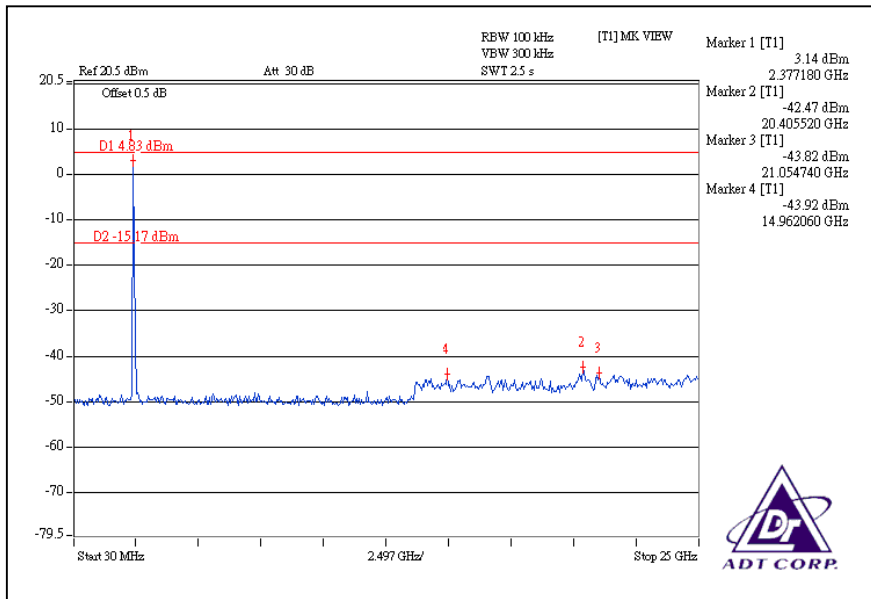

### CH11

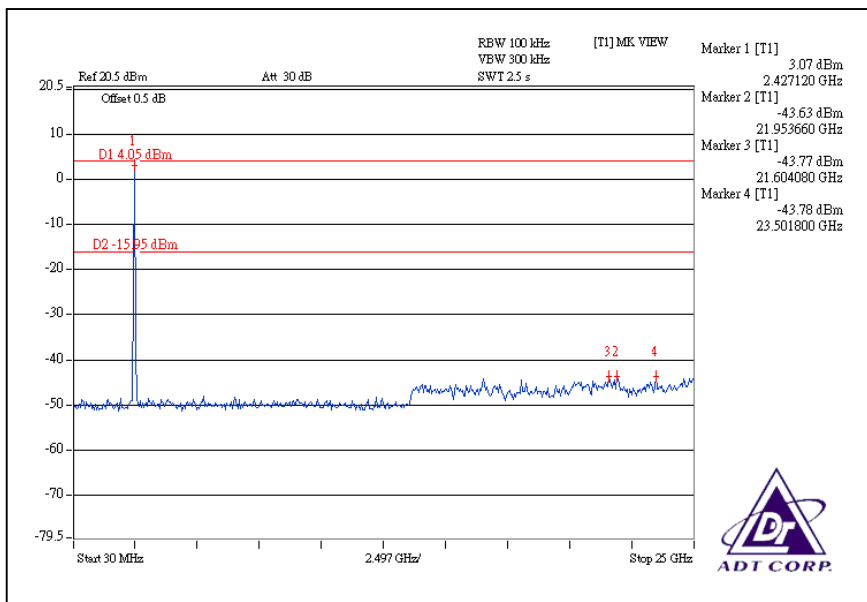

## 802.11g OFDM MODULATION: CH1

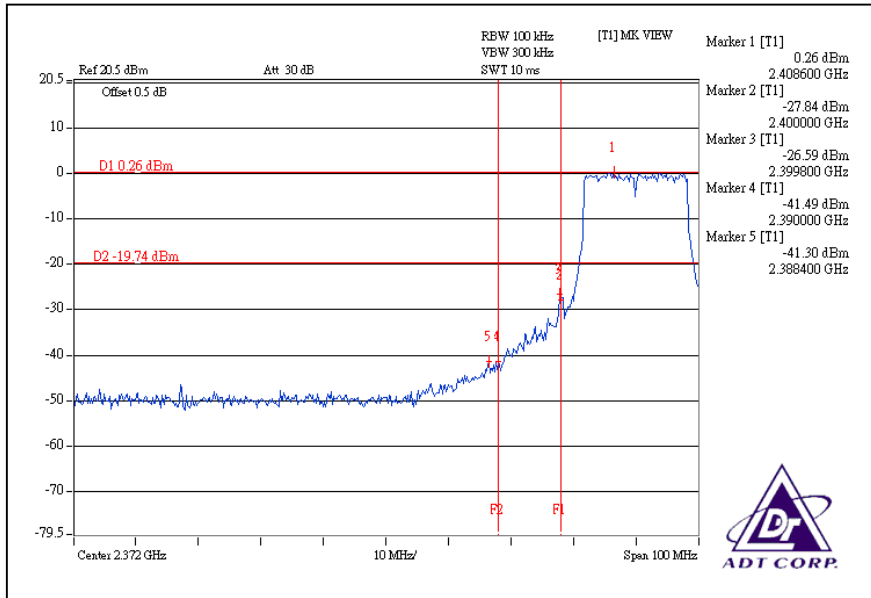

## CH11

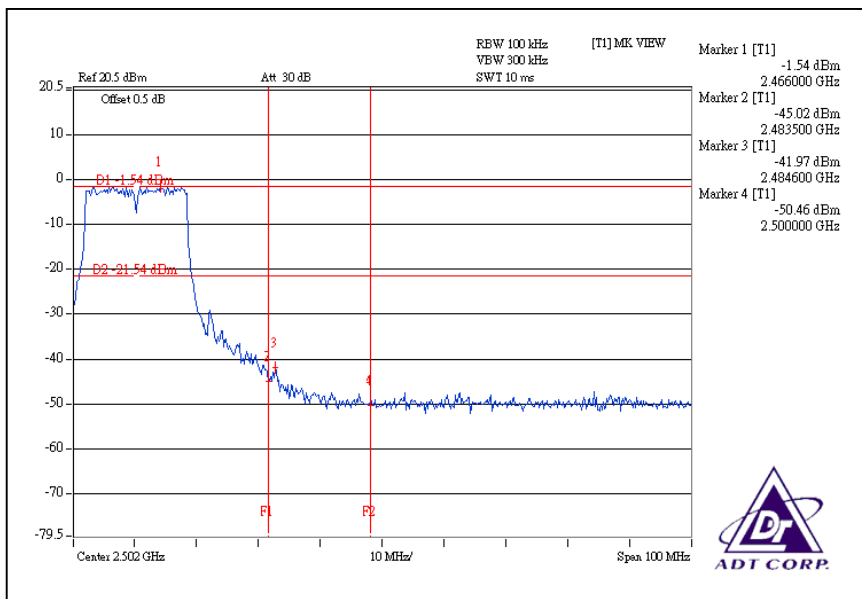

### CH1

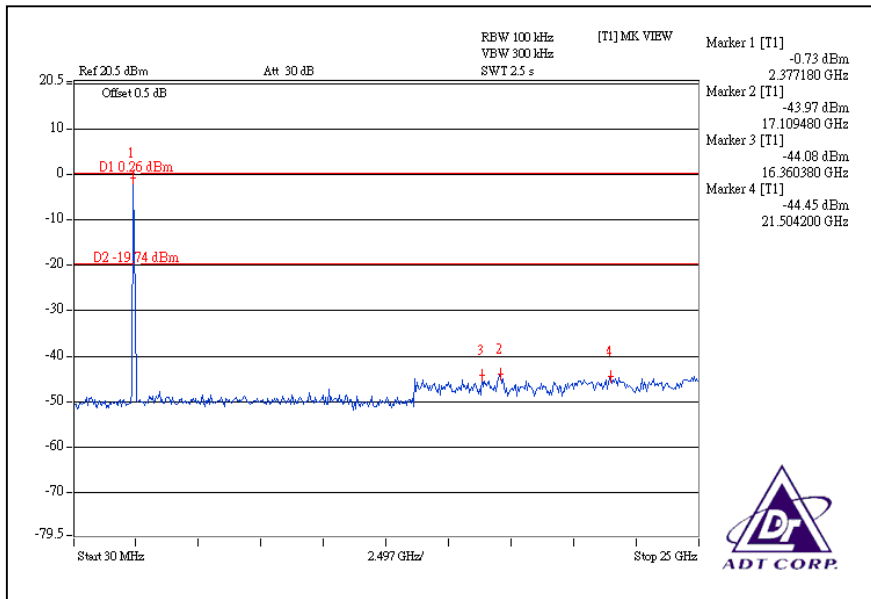

### CH11

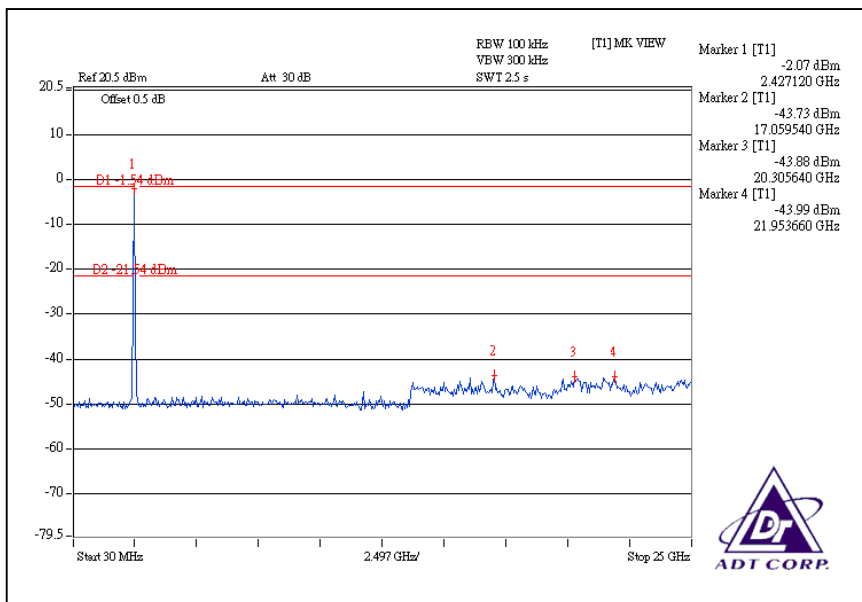

**DRAFT 802.11n (20MHz) OFDM MODULATION:  
For Chain (0):CH1**

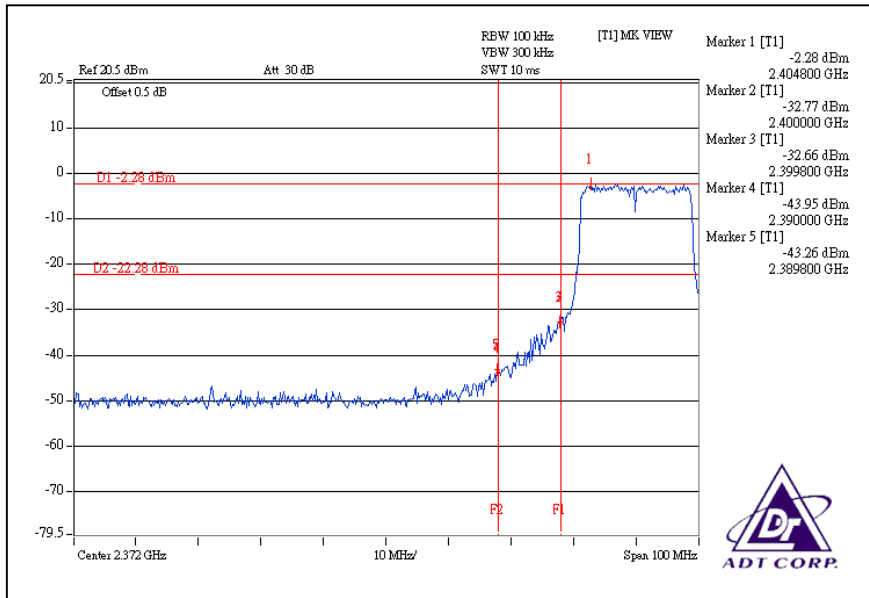

CH11

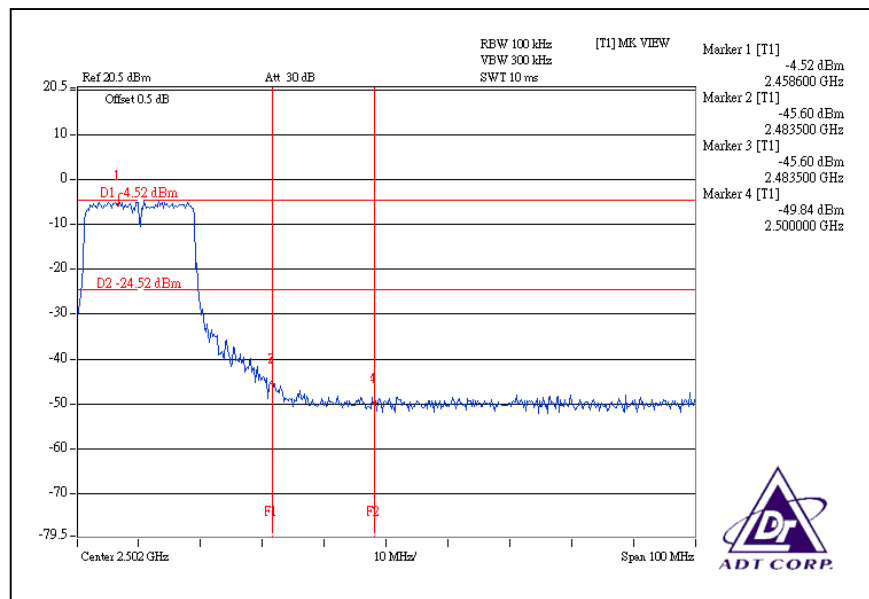

### CH1

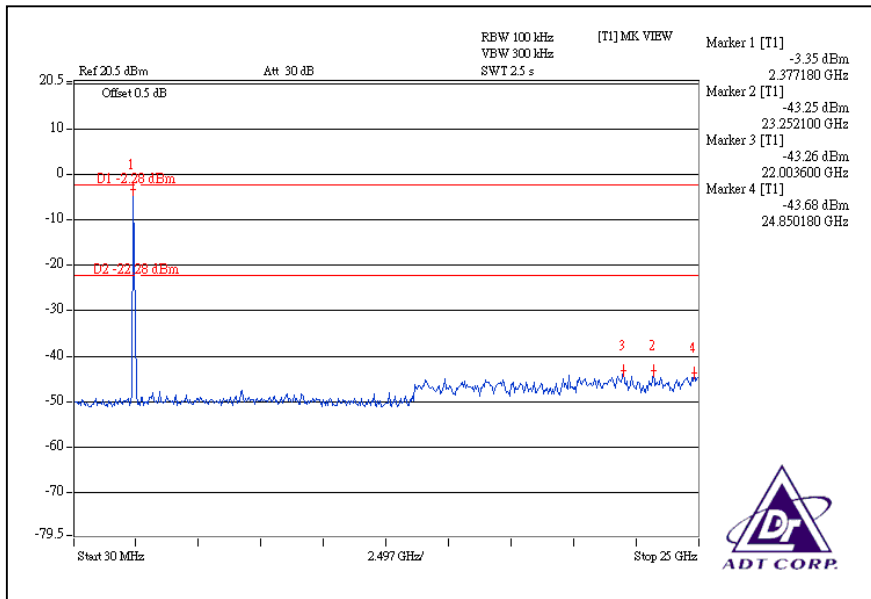

### CH11

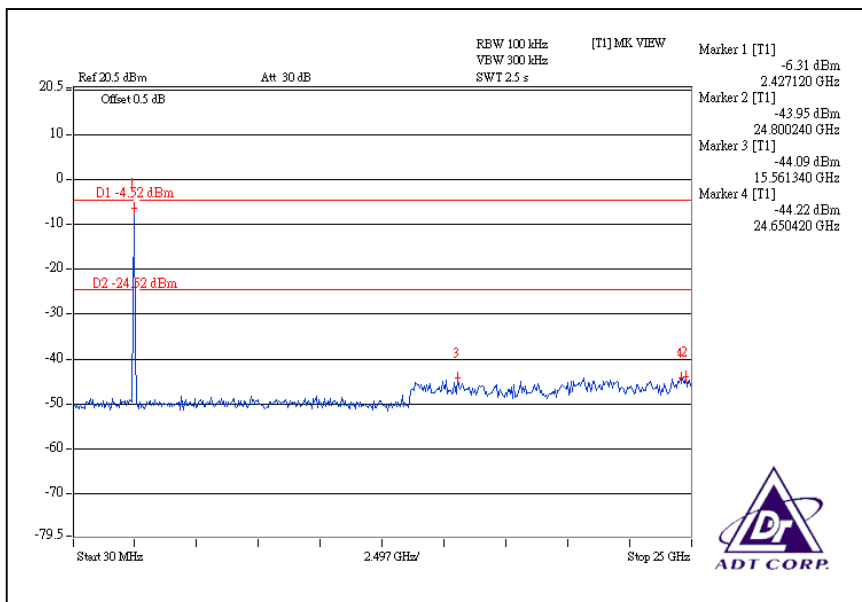



### For Chain (1):CH1

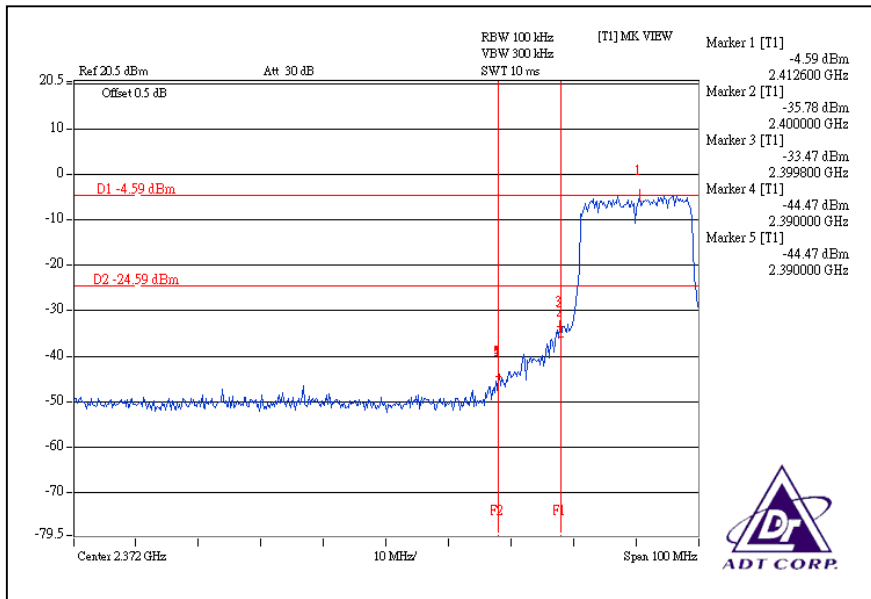

### CH11

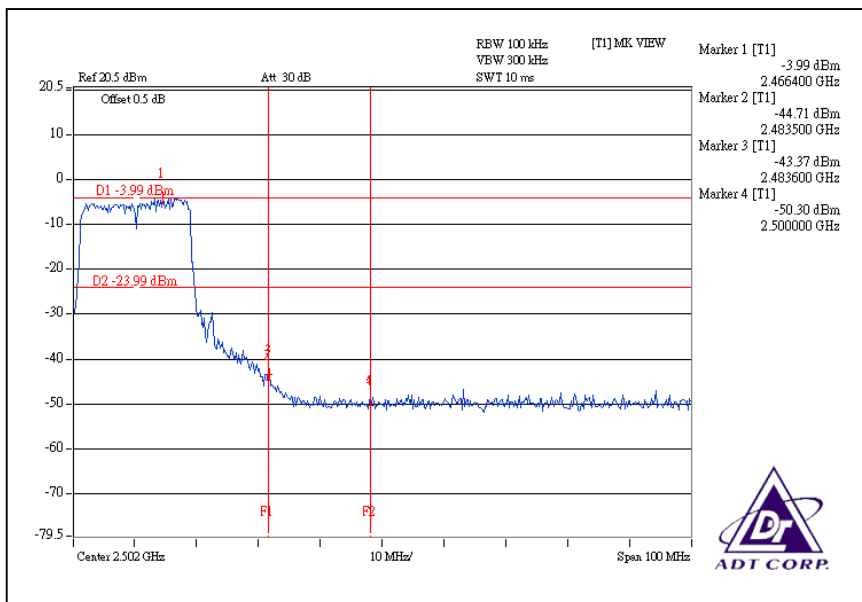

### CH1

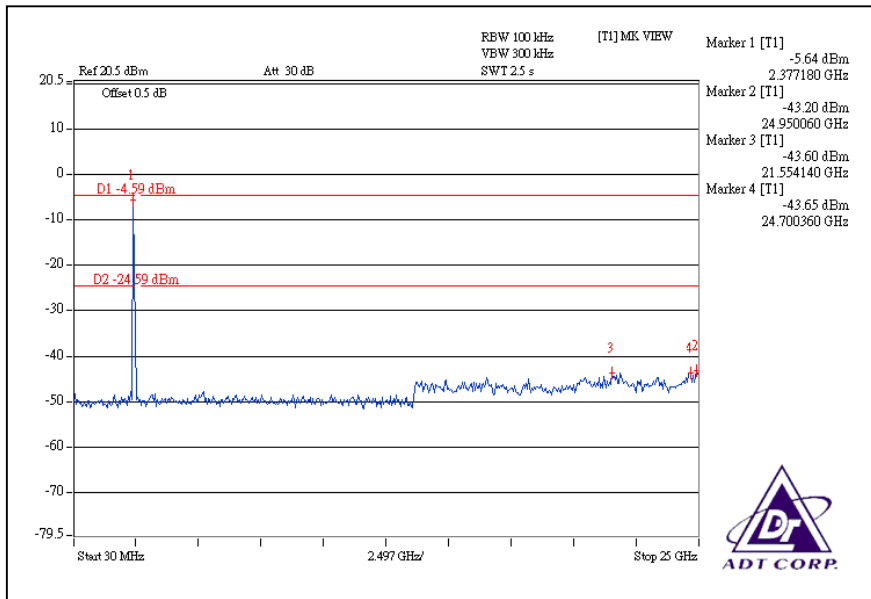

### CH11

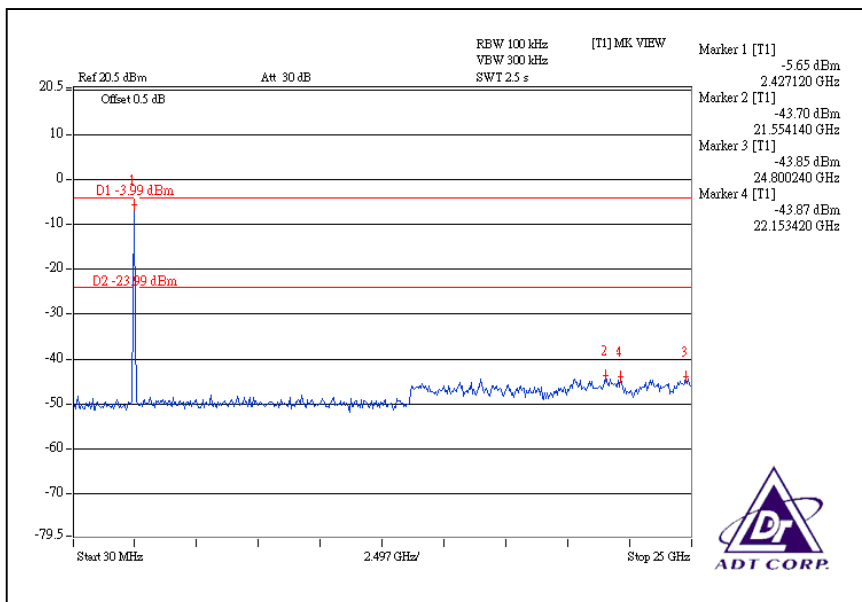

**DRAFT 802.11n (40MHz) OFDM MODULATION:**  
For Chain (0):CH1

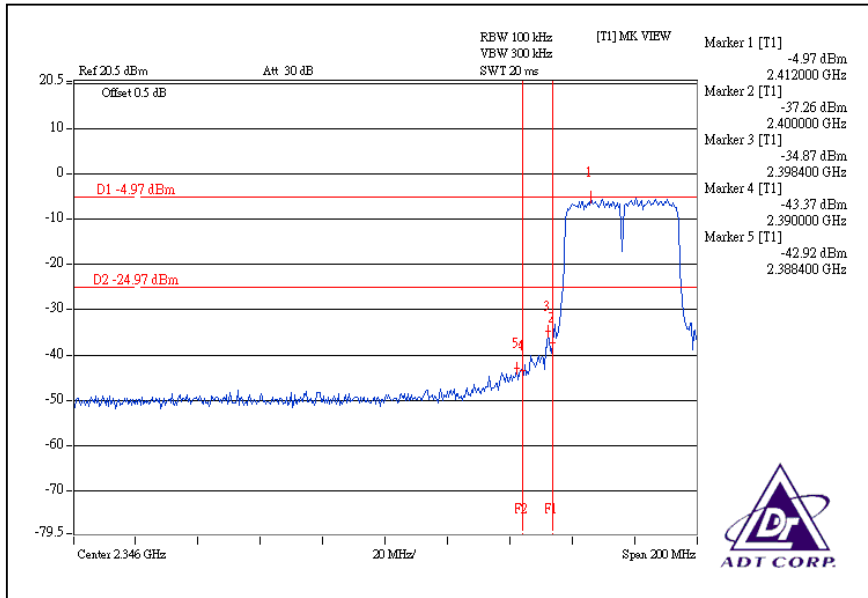

CH7

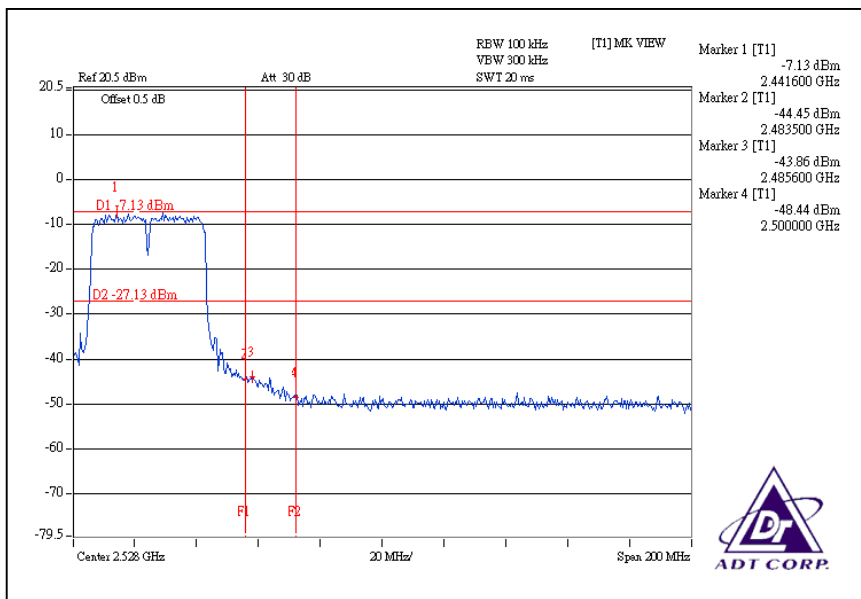

### CH1

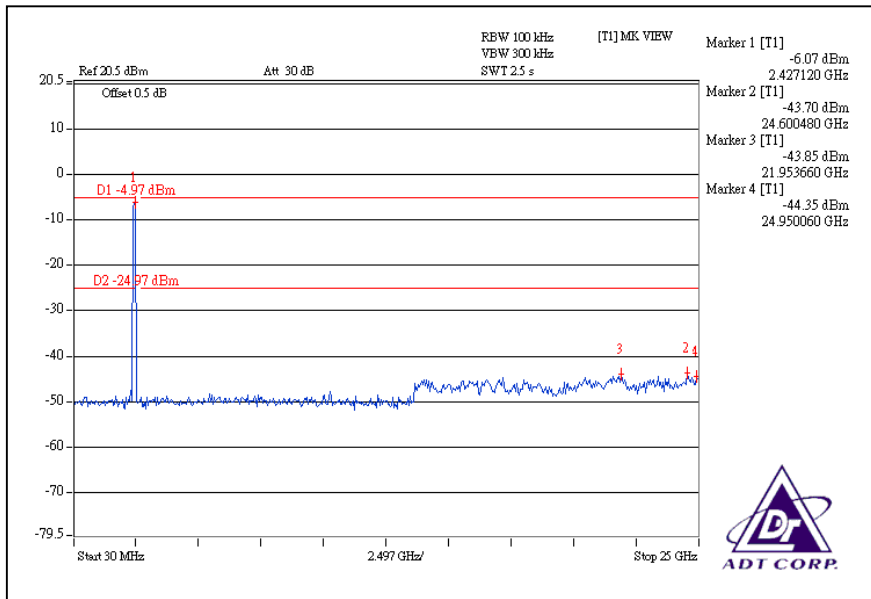

### CH7

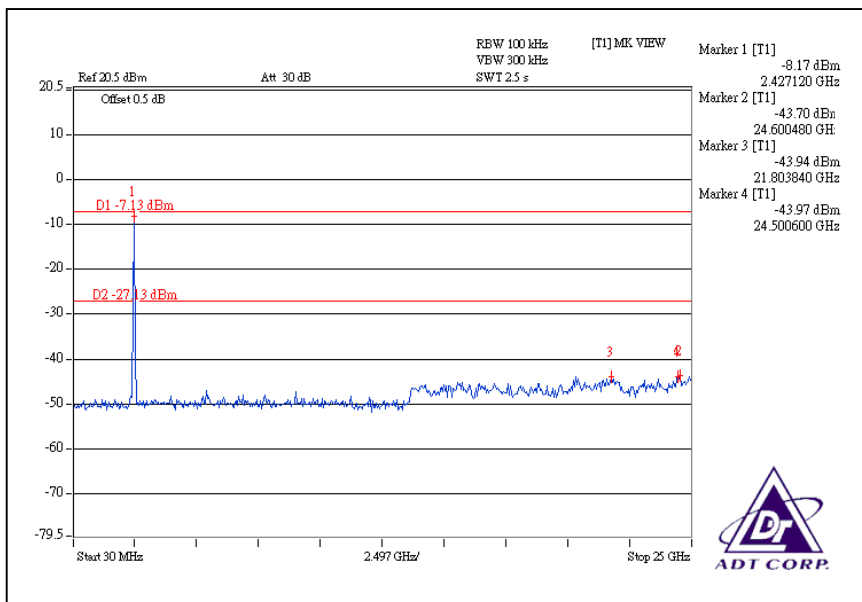

For Chain (1):CH1

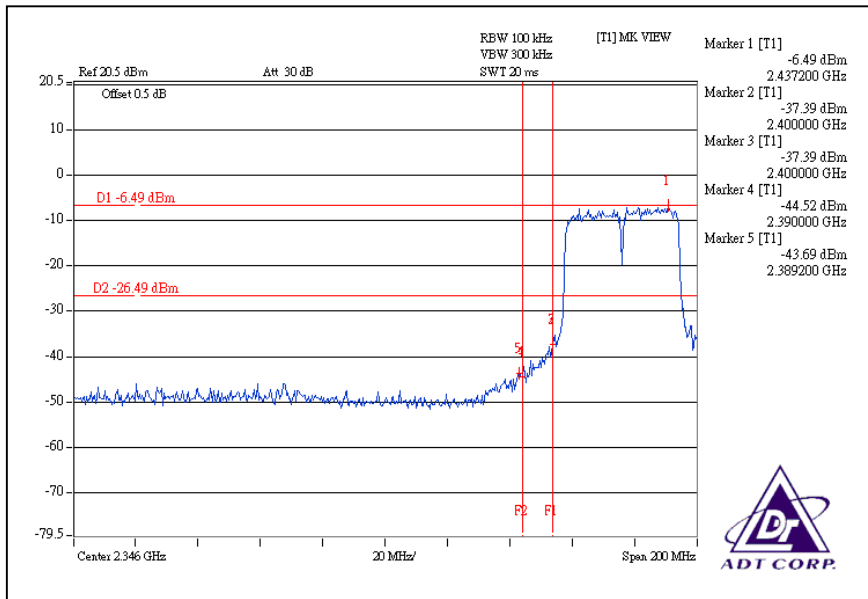

CH7

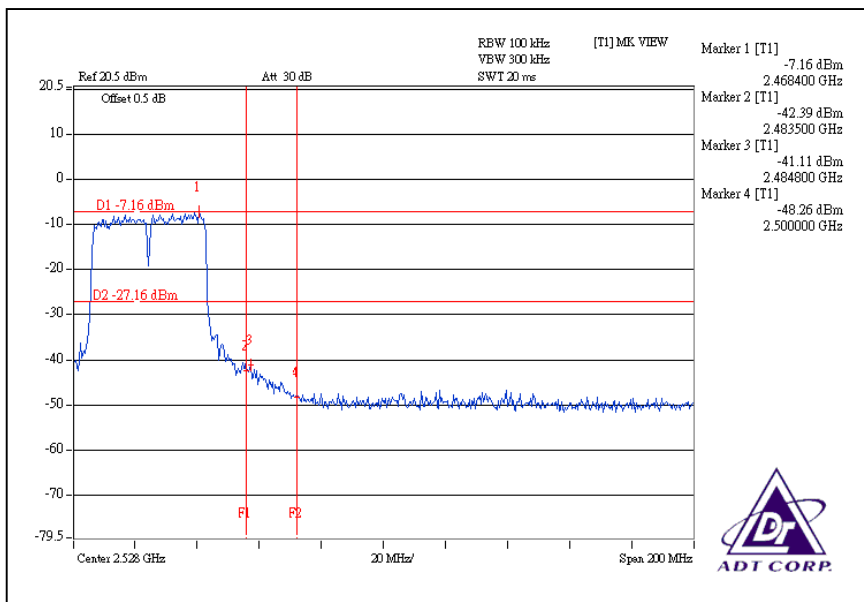

### CH1

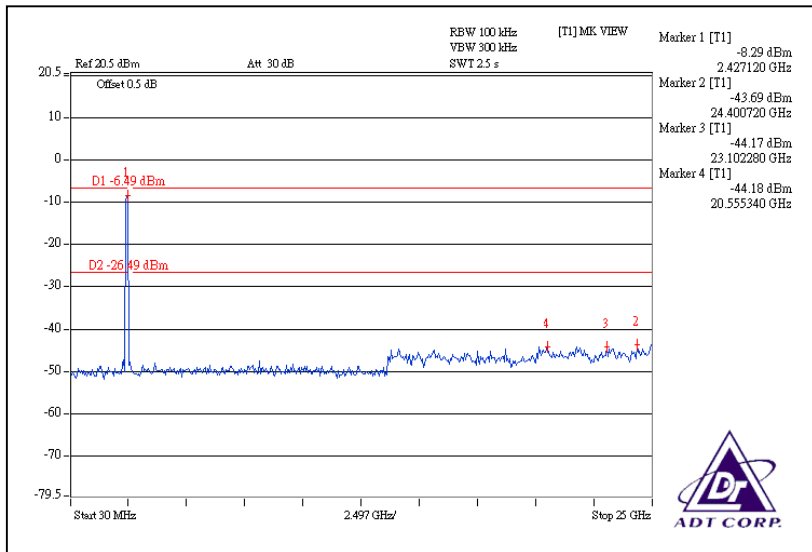

### CH7

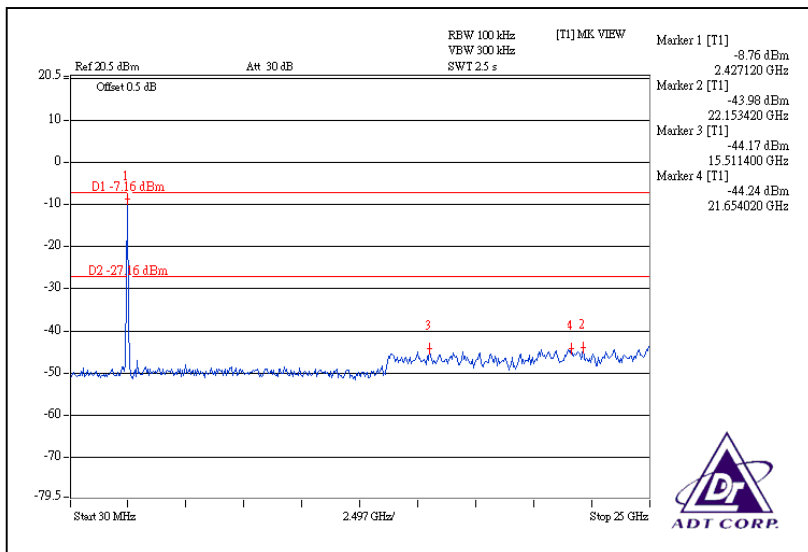

## 4.7 ANTENNA REQUIREMENT

### 4.7.1 STANDARD APPLICABLE

For intentional device, according to FCC 47 CFR Section 15.203, an intentional radiator shall be designed to ensure that no antenna other than that furnished by the responsible party shall be used with the device. And according to FCC 47 CFR Section 15.247 (b), if transmitting antennas of directional gain greater than 6dBi are used, the power shall be reduced by the amount in dB that the directional gain of the antenna exceeds 6dBi.

### 4.7.2 ANTENNA CONNECTED CONSTRUCTION

There are three antennas provided to this EUT, please refer to the following table:

Transmitter Circuit	Antenna Type	Antenna Connector	Gain(dBi)
Chain(0)	Dipole	IPEX	4
Chain(1)	Dipole	IPEX	4
Chain(2)	Dipole	IPEX	4



## 5. INFORMATION ON THE TESTING LABORATORIES

We, ADT Corp., were founded in 1988 to provide our best service in EMC, Radio, Telecom and Safety consultation. Our laboratories are accredited and approved by the following approval agencies according to ISO/IEC 17025.

<b>USA</b>	FCC, UL, A2LA
<b>Germany</b>	TUV Rheinland
<b>Japan</b>	VCCI
<b>Norway</b>	NEMKO
<b>Canada</b>	INDUSTRY CANADA , CSA
<b>R.O.C.</b>	TAF, BSMI, NCC
<b>Netherlands</b>	Telefication
<b>Singapore</b>	GOST-ASIA(MOU)
<b>Russia</b>	CERTIS(MOU)

Copies of accreditation certificates of our laboratories obtained from approval agencies can be downloaded from our web site:

[www.adt.com.tw/index.5/phtml](http://www.adt.com.tw/index.5/phtml). If you have any comments, please feel free to contact us at the following:

**Linko EMC/RF Lab:**  
Tel: 886-2-26052180  
Fax: 886-2-26052943

**Hsin Chu EMC/RF Lab:**  
Tel: 886-3-5935343  
Fax: 886-3-5935342

**Hwa Ya EMC/RF/Safety Telecom Lab:**  
Tel: 886-3-3183232  
Fax: 886-3-3185050

**Web Site:** [www.adt.com.tw](http://www.adt.com.tw)

The address and road map of all our labs can be found in our web site also



## **6. APPENDIX A - MODIFICATIONS RECORDERS FOR ENGINEERING CHANGES TO THE EUT BY THE LAB**

No any modifications are made to the EUT by the lab during the test.