



America

---

**Choose certainty.  
Add value.**

## Report On

Application for Grant of Equipment Authorization of the  
SMK Electronics Corp.  
Hunter Douglas Bluetooth Window Blind Remote Control

FCC Part 15 Subpart C §15.247  
IC RSS-Gen Issue 4 November 2014  
IC RSS-210 Issue 8 December 2010

**Report No. SD712100656A**

**March 2015**





**REPORT ON** Radio Testing of the  
SMK Electronics Corp.  
Bluetooth Window Blind Remote Control

**TEST REPORT NUMBER** SD712100656A

**PREPARED FOR** SMK Electronics Corp.  
1055 Tierra del Rey, Suite H  
Chula Vista, CA 91910

**CONTACT PERSON** Nikolay Shtin  
RF Engineer  
(619) 216-6400  
nshtin@smkusa.com

**PREPARED BY**   
Alex Chang  
**Name**  
Authorized Signatory  
Title: EMC/Wireless Test Engineer

**APPROVED BY**   
Juan Manuel Gonzalez  
**Name**  
Authorized Signatory  
Title: Commercial/Wireless EMC Lab Manager

**DATED** March 10, 2015



**Revision History**

SD712100656A SMK Electronics Corp. Hunter Douglas Bluetooth Window Blind Remote Control					
DATE	OLD REVISION	NEW REVISION	REASON	PAGES AFFECTED	APPROVED BY
03/10/2015	Initial Release				Juan M. Gonzalez



**CONTENTS**

<b>Section</b>		<b>Page No</b>
<b>1</b>	<b>REPORT SUMMARY</b> .....	<b>5</b>
1.1	Introduction .....	6
1.2	Brief Summary of Results.....	7
1.3	Product Information .....	8
1.4	EUT Test Configuration .....	10
1.5	Deviations From The Standard .....	12
1.6	Modification Record .....	12
1.7	Test Methodology.....	12
1.8	Test Facility Location.....	12
1.9	Test Facility Registration.....	12
<b>2</b>	<b>TEST DETAILS</b> .....	<b>14</b>
2.1	Peak Output Power.....	15
2.2	99% Emission Bandwidth .....	17
2.3	Minimum 6 dB RF Bandwidth .....	20
2.4	Out-Of-Band Emissions - Conducted .....	23
2.5	Band-Edge Compliance of RF Conducted Emissions .....	26
2.6	Spurious Radiated Emissions .....	28
2.7	Radiated Band Edge Measurements And Immediate Restricted Bands .....	36
2.8	Power Spectral Density.....	40
<b>3</b>	<b>TEST EQUIPMENT USED</b> .....	<b>43</b>
3.1	Test Equipment Used.....	44
3.2	Measurement Uncertainty .....	45
<b>4</b>	<b>DIAGRAM OF TEST SETUP</b> .....	<b>46</b>
4.1	Test Setup Diagram.....	47
<b>5</b>	<b>ACCREDITATION, DISCLAIMERS AND COPYRIGHT</b> .....	<b>49</b>
5.1	Accreditation, Disclaimers And Copyright .....	50



## **SECTION 1**

### **REPORT SUMMARY**

Radio Testing of the  
SMK Electronics Corp.  
Bluetooth Window Blind Remote Control



## 1.1 INTRODUCTION

The information contained in this report is intended to show verification of the SMK Electronics Corp. Hunter Douglas Bluetooth Window Blind Remote Control to the requirements of FCC Part 15 Subpart C §15.247, IC RSS-Gen Issue 4 November 2014 and IC RSS-210 Issue 8 December 2010.

Objective	To perform Radio Testing to determine the Equipment Under Test's (EUT's) compliance with the Test Specification, for the series of tests carried out.
Manufacturer	SMK Electronics Corp.
Model Number(s)	1010512198
FCC ID Number	UXURC4U3
IC Number	7316A-RC4U3
Serial Number(s)	Conducted antenna port testing sample, serial number not available. This is a PCB board only. Radiated testing sample, serial number not available. Proto type sample provided.
Number of Samples Tested	2
Test Specification/Issue/Date	<ul style="list-style-type: none"><li>• FCC Part 15 Subpart C §15.247 (October 1, 2014).</li><li>• RSS-210 - Licence-exempt Radio Apparatus (All Frequency Bands): Category I Equipment (Issue 8, December 2010).</li><li>• RSS-Gen - General Requirements for Compliance of Radio Apparatus (Issue 4, November 2014).</li><li>• 558074 D01 DTS Meas Guidance v03r02,(June 05, 2014) Guidance for Performing Compliance Measurements on Digital Transmission Systems (DTS) Operating Under §15.247.</li></ul>
Start of Test	February 24, 2015
Finish of Test	February 25, 2015
Name of Engineer(s)	Alex Chang
Related Document(s)	None. Supporting documents for EUT certification are separate exhibits.



## 1.2 BRIEF SUMMARY OF RESULTS

A brief summary of the tests carried out in accordance with FCC Part 15 Subpart C §15.247 with cross-reference to the corresponding IC RSS standard is shown below.

Section	§15.247 Spec Clause	RSS	Test Description	Result	Comments/ Base Standard
2.1	§15.247(b)(3)	RSS-210 A8.4 (4)	Peak Output Power	Compliant	
—	§15.207(a)	RSS-Gen 8.8	Conducted Emissions	N/A *)	
2.2		RSS-Gen 6.6	99% Emission Bandwidth	Compliant	
2.3	§15.247(a)(2)	RSS-210 A8.2(a)	Minimum 6 dB RF Bandwidth	Compliant	
2.4	§15.247(d)	RSS-210 A8.5	Out-of-Band Emissions - Conducted	Compliant	
2.5	§15.247(d)	RSS-210 A8.5	Band-edge Compliance of RF Conducted Emissions	Compliant	
2.6	§15.247(d)	RSS-210 A8.5	Spurious Radiated Emissions	Compliant	
2.7		RSS-Gen 7.1	Receiver Spurious Emissions	Compliant	
2.8	§15.247(d)	RSS-210 A8.5	Radiated Band Edge Measurements	Compliant	
2.9	§15.247(e)	RSS-210 A8.2(b)	Power Spectral Density for Digitally Modulated Device	Compliant	

\*) Not applicable. EUT is a battery operated device.

### 1.3 PRODUCT INFORMATION

#### 1.3.1 Technical Description

The Equipment Under Test (EUT) is a SMK Electronics Corp. Hunter Douglas Bluetooth Window Blind Remote Control as shown in the photograph below. The EUT allows the operator to use of control window blind(s) remotely via Bluetooth technology connection. Bluetooth LE function was verified and evaluated in this test report.

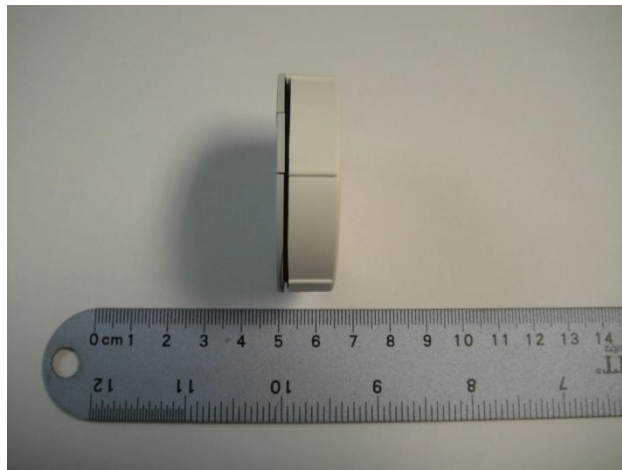
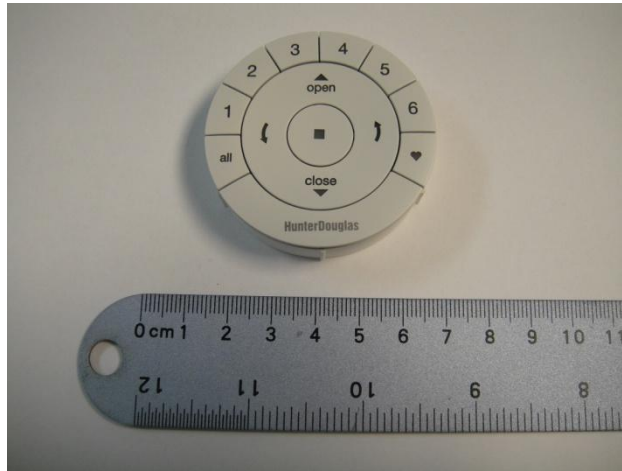

**Equipment Under Test**





**1.3.2 EUT General Description**

EUT Description	Bluetooth Window Blind Remote Control
Model Name	Hunter Douglas
Model Number(s)	1010512198
Rated Voltage	3.0VDC Coin Cell Battery (CR2032) x2 in parallel
Frequency Range	2407 MHz to 2480 MHz in the 2400 MHz to 2483.5 MHz Band
Number of Operating Frequencies	74
Channels Verified	Low Channel 2407MHz Mid Channel 2440MHz High Channel 2480MHz
Antenna Type (used during evaluation)	Integral (Complies with Part 15.203 requirements)

**1.3.3 Antenna Details**

Manufacturer	HunterDouglas
Antenna Type	Monopole PCB Trace
Antenna Gain	-0.6 dBi

**1.3.4 Maximum Conducted Output Power**

Mode	Frequency Range (MHz)	Average Output Power (dBm)	Output Power (mW)
Bluetooth LE	2407-2480	-5.03	0.31

**1.4 EUT TEST CONFIGURATION**

**1.4.1 Test Configuration Description**

Test Configuration	Description
A	Conducted antenna port configuration. EUT was set on continuous transmission @ 100% duty cycle modulated in low, mid and high channels for evaluation via temporary antenna port provided by manufacturer.
B	Radiated emissions test configuration. EUT transmitting through the integral antenna. The EUT was a standalone device and set on continuous transmission @ 100% duty cycle modulated in low, mid or high channel for evaluation.

**1.4.2 EUT Exercise Software**

No special software used during evaluation. A firmware was loaded to the EUT which enable to change channels in Low, Mid and High @ 100% duty cycle (modulated) as well as normal operation and receive modes.

**1.4.3 Support Equipment and I/O cables**

Manufacturer	Equipment/Cable	Description
—	—	—

**1.4.4 Worst Case Configuration**

For radiated measurements X, Y and Z orientations were verified. For Z orientation, the EUT was rotated 90° from Y position. Identical result obtained between Y and Z orientations. Verification performed using Y or Z orientation.

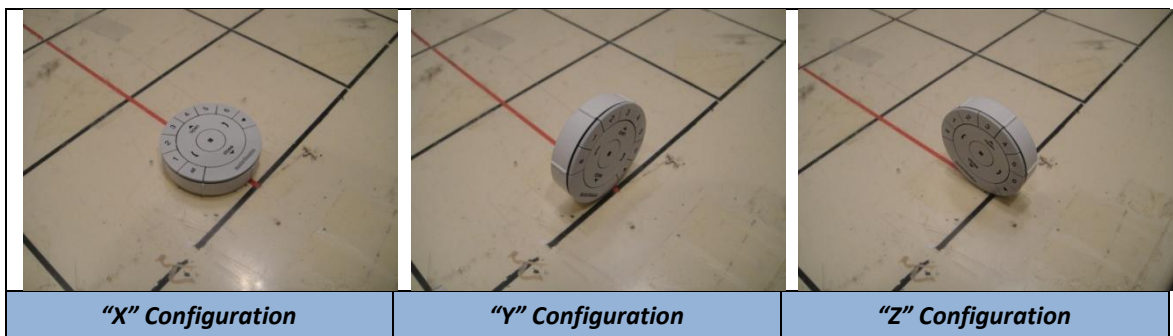

Worst case channel used is Low Channel (Channel 2407 MHz). This is based from Peak Output Power test results under Section 2.1 of this test report.

### 1.4.5 Simplified Test Configuration Diagram

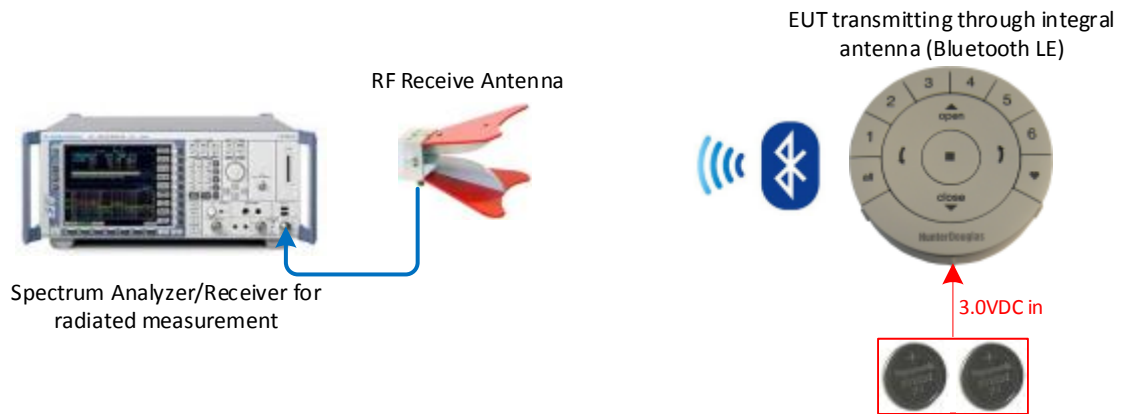

**Not To Scale – Illustration Purpose Only**  
Objects may not represent actual image of original equipment/s or set-up.

### Conducted (Antenna Port) Test Configuration

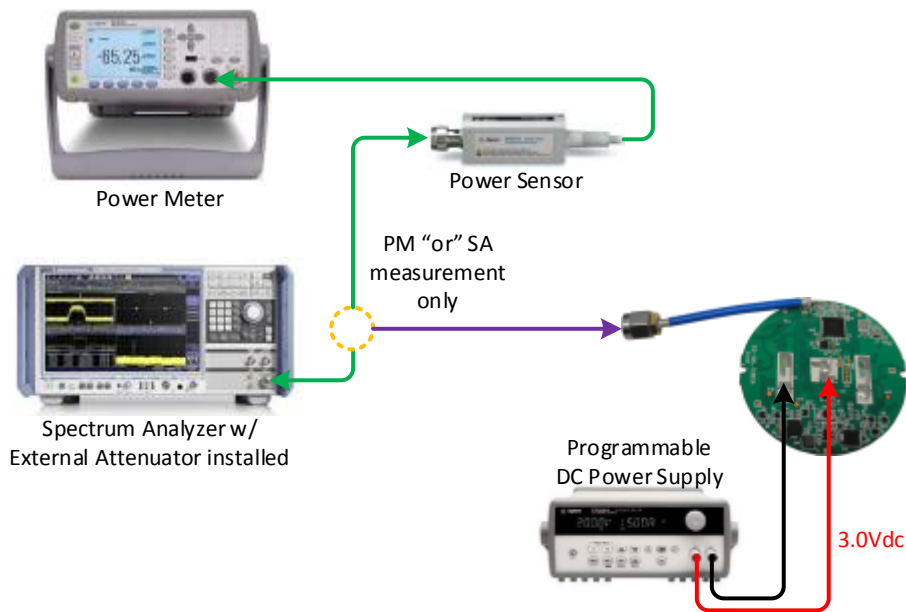

**Not To Scale – Illustration Purpose Only**  
Objects may not represent actual image of original equipment/s or set-up.



**1.5 DEVIATIONS FROM THE STANDARD**

No deviations from the applicable test standards or test plan were made during testing.

**1.6 MODIFICATION RECORD**

Description of Modification	Modification Fitted By	Date Modification Fitted
Serial Number: Conducted antenna port testing sample, serial number not available. PCB board only. Radiated testing sample, serial number not available. Proto type sample provided.		
N/A	—	—

The table above details modifications made to the EUT during the test programme. The modifications incorporated during each test (if relevant) are recorded on the appropriate test pages.

**1.7 TEST METHODOLOGY**

All measurements contained in this report were conducted with ANSI C63.4-2009, American National Standard for Methods of Measurement of Radio-Noise Emissions from Low-Voltage Electrical and Electronic Equipment in the range of 9 kHz to 40 GHz.

For conducted and radiated emissions the equipment under test (EUT) was configured to measure its highest possible emission level. This level was based on the maximized cable configuration from exploratory testing per ANSI C63.4-2009. The test modes were adapted according to the Operating Instructions provided by the manufacturer/client.

**1.8 TEST FACILITY LOCATION**

**1.8.1 TÜV SÜD America Inc. (Mira Mesa)**

10040 Mesa Rim Road, San Diego, CA 92121-2912 (32.901268,-117.177681). Phone: 858 678 1400 FAX: 858-546 0364

**1.8.2 TÜV SÜD America Inc. (Rancho Bernardo)**

Sony Electronics Inc., Building #8 16530 Via Esprillo, San Diego, CA 92127-1708 (33.018644,-117.092409). Phone: 858 942 5542 FAX: 858-546 0364

**1.9 TEST FACILITY REGISTRATION**

**1.9.1 FCC – Registration No.: US1146**

TUV SUD America Inc. (San Diego), is an accredited test facility with the site description report on file and has met all the requirements specified in §2.948 of the FCC rules. The acceptance letter from the FCC is maintained in our files and the Registration is US1146.



**1.9.2 Industry Canada (IC) Registration No.: 3067A**

The 10m Semi-anechoic chamber of TÜV SÜD America Inc. (San Diego) has been registered by Certification and Engineering Bureau of Industry Canada for radio equipment testing with Registration No. 3067A.



## **SECTION 2**

### **TEST DETAILS**

Radio Testing of the  
SMK Electronics Corp.  
Bluetooth Window Blind Remote Control



## **2.1 PEAK OUTPUT POWER**

### **2.1.1 Specification Reference**

Part 15 Subpart C §15.247(b)(3)

### **2.1.2 Standard Applicable**

(3) For systems using digital modulation in the 902–928 MHz, 2400–2483.5 MHz, and 5725–5850 MHz bands: 1 Watt. As an alternative to a peak power measurement, compliance with the one Watt limit can be based on a measurement of the maximum conducted output power. Maximum Conducted Output Power is defined as the total transmit power delivered to all antennas and antenna elements averaged across all symbols in the signaling alphabet when the transmitter is operating at its maximum power control level. Power must be summed across all antennas and antenna elements. The average must not include any time intervals during which the transmitter is off or is transmitting at a reduced power level. If multiple modes of operation are possible (e.g., alternative modulation methods), the maximum conducted output power is the highest total transmit power occurring in any mode.

### **2.1.3 Equipment Under Test and Modification State**

Serial No: PCB board sample / Test Configuration A

### **2.1.4 Date of Test/Initial of test personnel who performed the test**

February 24, 2015 / AC

### **2.1.5 Test Equipment Used**

The major items of test equipment used for the above tests are identified in Section 3.1.

### **2.1.6 Environmental Conditions**

Test performed at TÜV SÜD America Inc. Rancho Bernardo facility

Ambient Temperature	18.0°C
Relative Humidity	30.0%
ATM Pressure	99.5 kPa

### **2.1.7 Additional Observations**

- This is a conducted test (Maximum conducted [average] output power) using direct connection to a power meter.
- Test methodology is per Clause 9.2.3.1 of KDB 558074 D01 (DTS Meas Guidance v03r02, June 05, 2014). All conditions under this Clause were satisfied.
- Both Peak and Average measurements were recorded.

**2.1.8 Test Results**

Bluetooth Low Energy (LE)	Channel (MHz)	Modulation	Measured Average Power (dBm)	Measured Peak Power (dBm)
	2407	GFSK @ 1Mbps	-5.03	-4.89
	2440		-5.06	-4.93
	2480		-5.64	-5.49

**2.1.9 Sample Test Display**

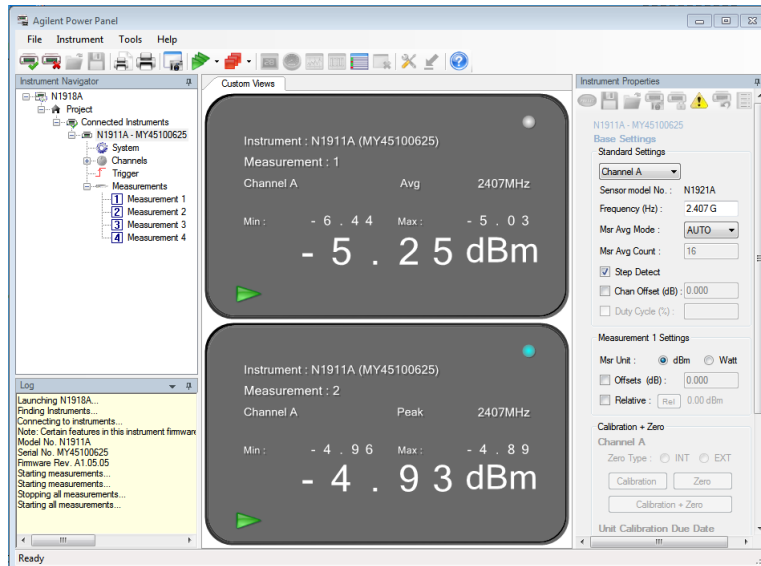

**Bluetooth LE. Low Channel**





## **2.2 99% EMISSION BANDWIDTH**

### **2.2.1 Specification Reference**

RSS-Gen Clause 6.6

### **2.2.2 Standard Applicable**

The emission bandwidth (x dB) is defined as the frequency range between two points, one above and one below the carrier frequency, at which the spectral density of the emission is attenuated x dB below the maximum in-band spectral density of the modulated signal. Spectral density (power per unit bandwidth) is to be measured with a detector of resolution bandwidth in the range of 1% to 5% of the anticipated emission bandwidth, and a video bandwidth at least 3x the resolution bandwidth.

When the occupied bandwidth limit is not stated in the applicable RSS or reference measurement method, the transmitted signal bandwidth shall be reported as the 99% emission bandwidth, as calculated or measured.

- The transmitter shall be operated at its maximum carrier power measured under normal test conditions.
- The span of the analyzer shall be set to capture all products of the modulation process, including the emission skirts.
- The resolution bandwidth (RBW) shall be in the range of 1% to 5% of the occupied bandwidth (OBW) and video bandwidth (VBW) shall be approximately 3x RBW.

Note: Video averaging is not permitted.

A peak, or peak hold, may be used in place of the sampling detector as this may produce a wider bandwidth than the actual bandwidth (worst-case measurement). Use of a peak hold may be necessary to determine the occupied bandwidth if the device is not transmitting continuously.

The trace data points are recovered and are directly summed in linear power level terms. The recovered amplitude data points, beginning at the lowest frequency, are placed in a running sum until 0.5% of the total is reached and that frequency recorded. The process is repeated for the highest frequency data points (starting at the highest frequency, at the right side of the span, and going down in frequency). This frequency is then recorded.

The difference between the two recorded frequencies is the 99% occupied bandwidth.

### **2.2.3 Equipment Under Test and Modification State**

Serial No: PCB board sample / Test Configuration A

### **2.2.4 Date of Test/Initial of test personnel who performed the test**

February 24, 2015 / AC

### **2.2.5 Test Equipment Used**

The major items of test equipment used for the above tests are identified in Section 3.1.



**2.2.6 Environmental Conditions/ Test Location**

Test performed at TÜV SÜD America Inc. Rancho Bernardo facility

Ambient Temperature 18.0°C  
 Relative Humidity 30.0%  
 ATM Pressure 99.5 kPa

**2.2.7 Additional Observations**

- This is a conducted test.
- An offset 21dB was used to compensate for the external attenuator and cable used for Bluetooth LE measurements.
- Span is wide enough to capture the channel transmission.
- RBW is 1% of the span.
- VBW is 3X RBW.
- Sweep is auto.
- Detector is peak.
- The % Power Bandwidth setting in the spectrum analyzer was set to 99% (default).

**2.2.8 Test Results**

Mode	Channel (MHz)	Measured 99% Bandwidth (MHz)
Bluetooth LE	2407	1.754
	2440	1.874
	2480	1.814

**2.2.9 Test Results Plots**

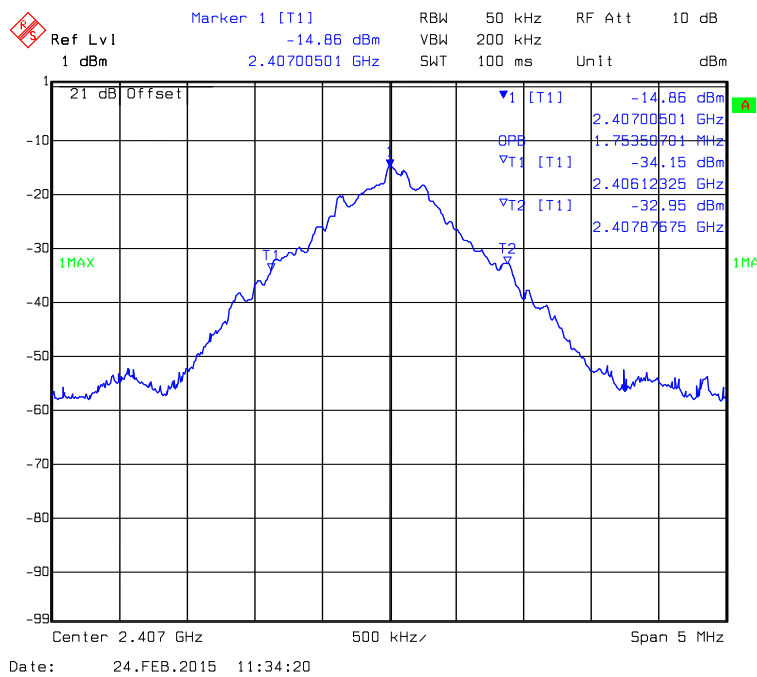

**Bluetooth LE Low Channel**

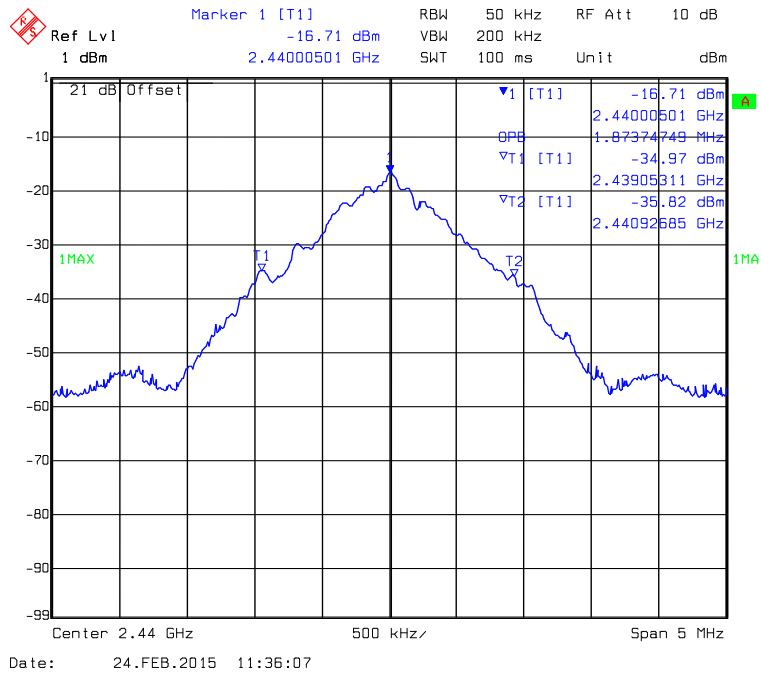

Bluetooth LE Mid Channel

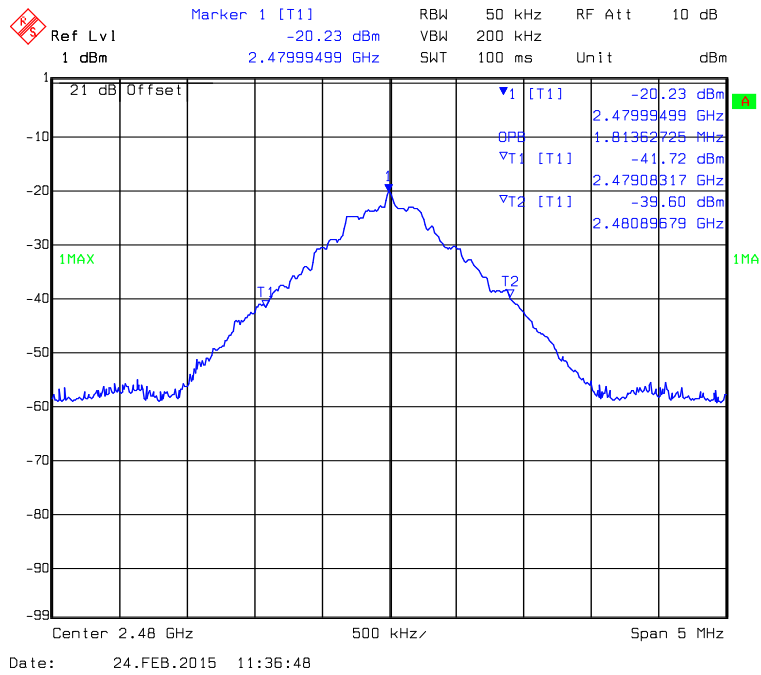

Bluetooth LE High Channel



## **2.3 MINIMUM 6 dB RF BANDWIDTH**

### **2.3.1 Specification Reference**

Part 15 Subpart C §15.247(a)(2)

### **2.3.2 Standard Applicable**

(2) Systems using digital modulation techniques may operate in the 902–928 MHz, 2400–2483.5 MHz, and 5725–5850 MHz bands. The minimum 6 dB bandwidth shall be at least 500 kHz.

### **2.3.3 Equipment Under Test and Modification State**

Serial No: PCB board sample / Test Configuration A

### **2.3.4 Date of Test/Initial of test personnel who performed the test**

February 24, 2015 / AC

### **2.3.5 Test Equipment Used**

The major items of test equipment used for the above tests are identified in Section 3.1.

### **2.3.6 Environmental Conditions/ Test Location**

Test performed at TÜV SÜD America Inc. Rancho Bernardo facility

Ambient Temperature	18.0°C
Relative Humidity	30.0%
ATM Pressure	99.5 kPa

### **2.3.7 Additional Observations**

- This is a conducted test.
- An offset 21dB was used to compensate for the external attenuator and cable used for Bluetooth LE measurements.
- Span is wide enough to capture the channel transmission.
- RBW is set to either 100 kHz (BT LE) or 1% of the span (802.11 b, g and n).
- VBW is  $\geq 3X$  RBW.
- Sweep is auto.
- Detector is peak.
- The “n” dB down marker function of the spectrum analyzer was used for this test.



**2.3.8 Test Results**

Mode	Channel (MHz)	Measured Bandwidth (MHz)	Minimum Bandwidth (MHz)	Compliance
Bluetooth LE	2407	0.892	0.500	Complies
	2440	0.832	0.500	Complies
	2480	0.832	0.500	Complies

**2.3.9 Test Results Plots**

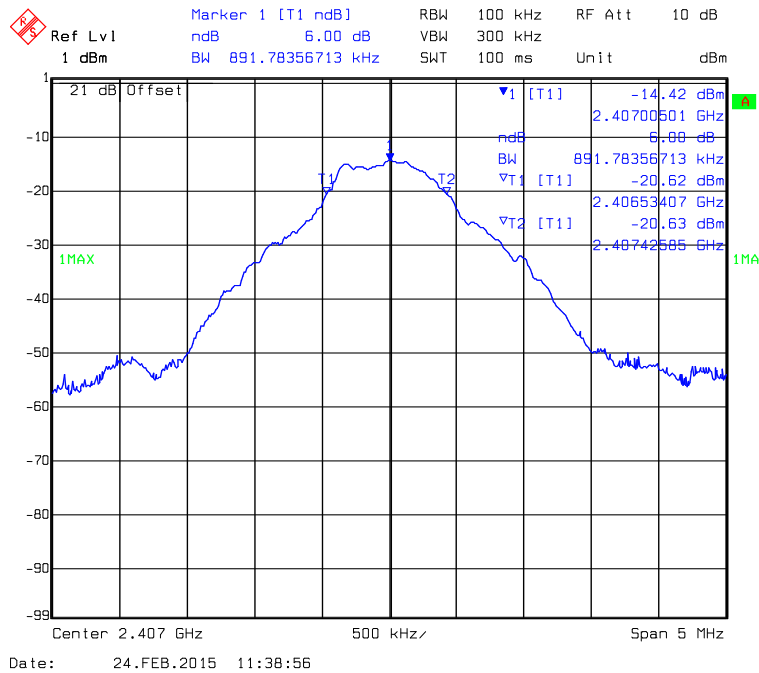

**Bluetooth LE Low Channel**

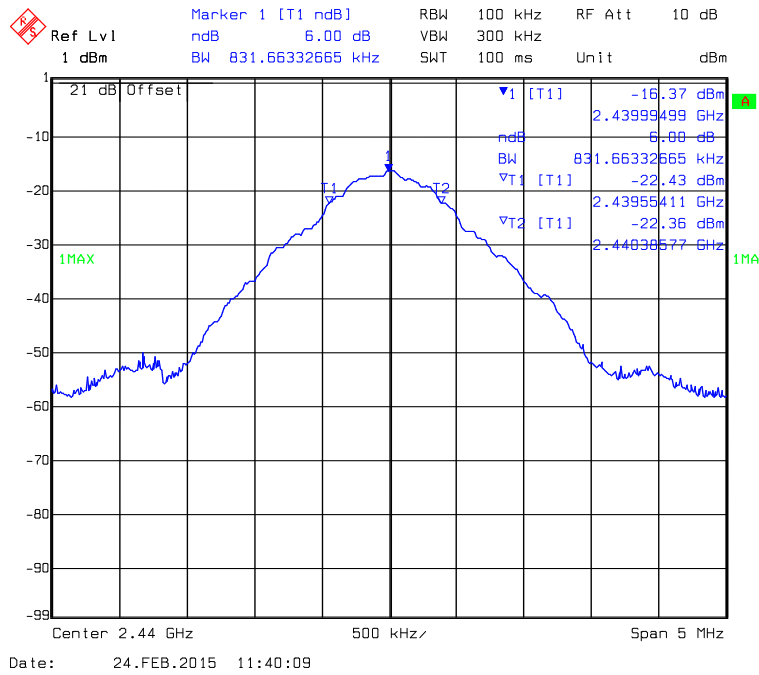

Bluetooth LE Mid Channel

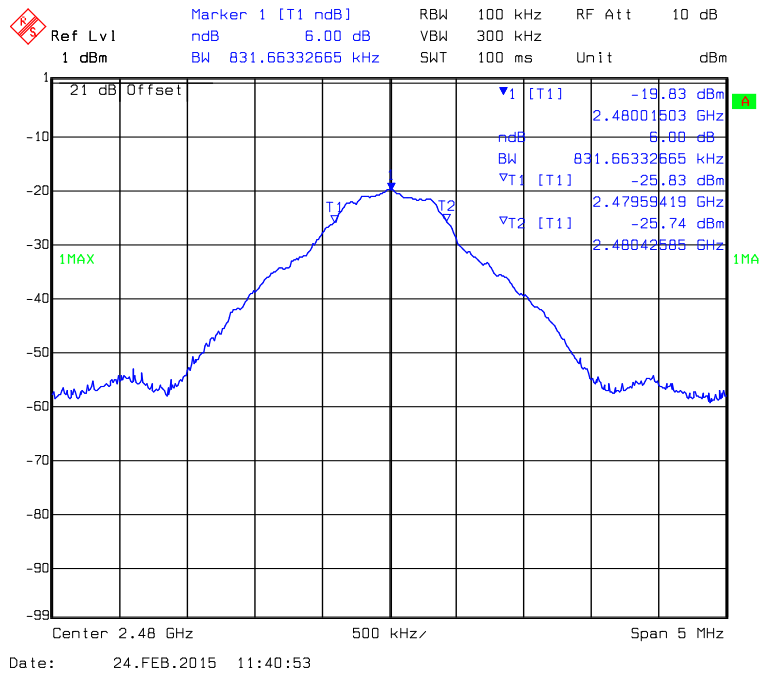

Bluetooth LE High Channel



## **2.4 OUT-OF-BAND EMISSIONS - CONDUCTED**

### **2.4.1 Specification Reference**

Part 15 Subpart C §15.247(d)

### **2.4.2 Standard Applicable**

(d) In any 100 kHz bandwidth outside the frequency band in which the spread spectrum or digitally modulated intentional radiator is operating, the radio frequency power that is produced by the intentional radiator shall be at least 20 dB below that in the 100 kHz bandwidth within the band that contains the highest level of the desired power, based on either an RF conducted or a radiated measurement, provided the transmitter demonstrates compliance with the peak conducted power limits. If the transmitter complies with the conducted power limits based on the use of RMS averaging over a time interval, as permitted under paragraph (b)(3) of this section, the attenuation required under this paragraph shall be 30 dB instead of 20 dB. Attenuation below the general limits specified in §15.209(a) is not required. In addition, radiated emissions which fall in the restricted bands, as defined in §15.205(a), must also comply with the radiated emission limits specified in §15.209(a) (see §15.205(c)).

### **2.4.3 Equipment Under Test and Modification State**

Serial No: PCB board sample / Test Configuration A

### **2.4.4 Date of Test/Initial of test personnel who performed the test**

February 24, 2015 / AC

### **2.4.5 Test Equipment Used**

The major items of test equipment used for the above tests are identified in Section 3.1.

### **2.4.6 Environmental Conditions/ Test Location**

Test performed at TÜV SÜD America Inc. Rancho Bernardo facility

Ambient Temperature	18.0 °C
Relative Humidity	30.0.%
ATM Pressure	99.5 kPa

### **2.4.7 Additional Observations**

- This is a conducted test.
- An offset 1dB was used to compensate for the external cable used for Bluetooth LE measurements.
- RBW is 100kHz.VBW is 3X RBW.
- Sweep is auto. Detector is peak. Trace is max hold.
- Initial scan was performed to determine the highest level of the desired power within the band. Limit (display line) was drawn 30dB below this level.
- Spectrum was searched from 9 kHz up to 26.5GHz.



2.4.8 Test Results Plots

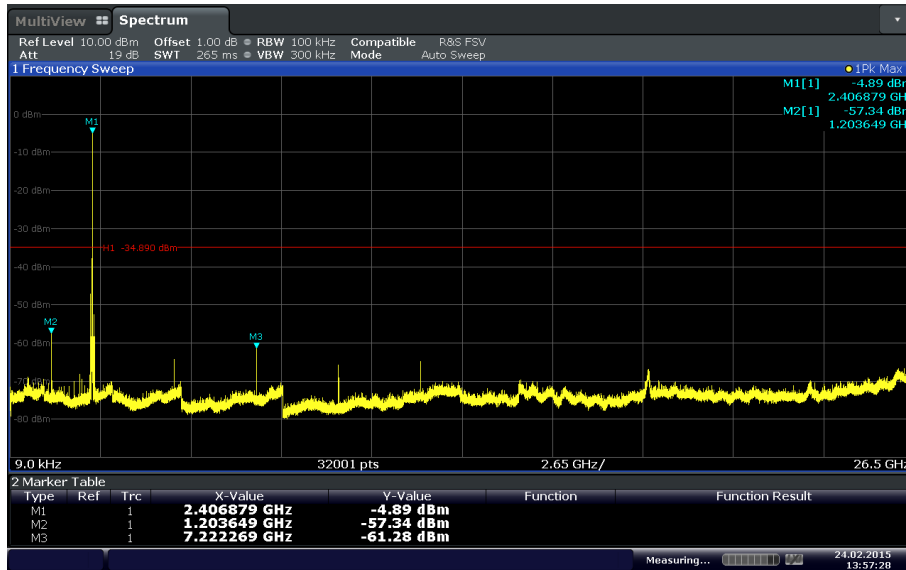

Date: 24\_FEB.2015 13:57:28

Bluetooth LE Low Channel

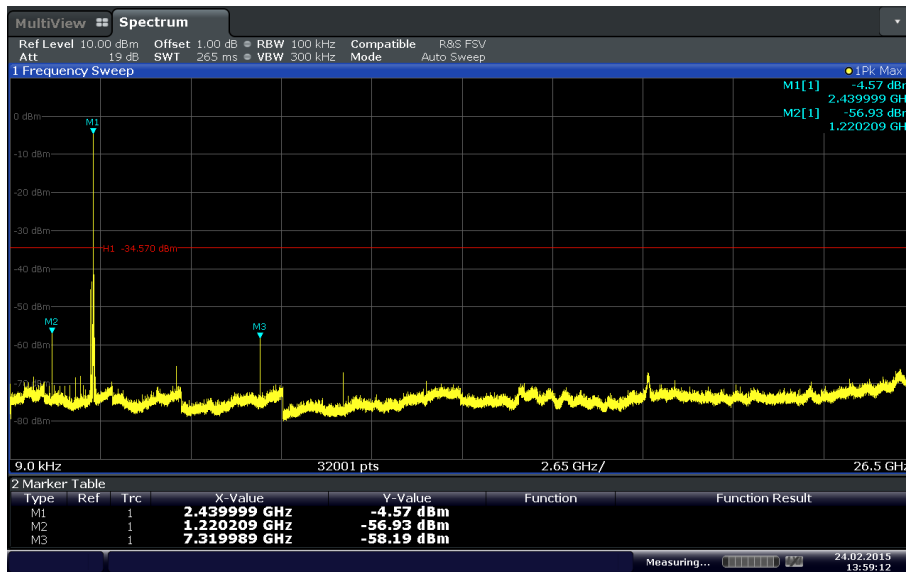

Date: 24\_FEB.2015 13:59:13

Bluetooth LE Mid Channel



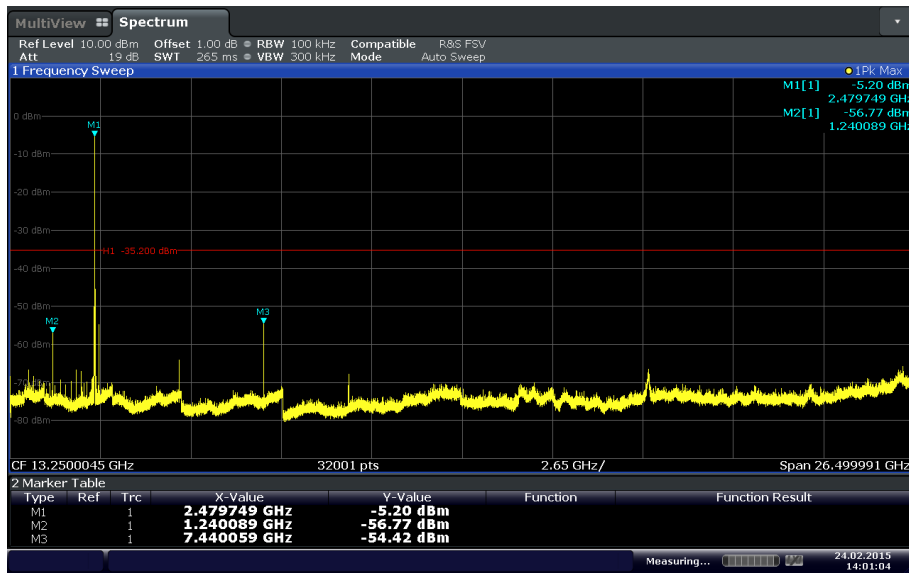

Date: 24.FEB.2015 14:01:04

Bluetooth LE High Channel



## **2.5 BAND-EDGE COMPLIANCE OF RF CONDUCTED EMISSIONS**

### **2.5.1 Specification Reference**

Part 15 Subpart C §15.247(d)

### **2.5.2 Standard Applicable**

See previous test.

### **2.5.3 Equipment Under Test and Modification State**

Serial No: PCB board sample / Test Configuration A

### **2.5.4 Date of Test/Initial of test personnel who performed the test**

February 24, 2015 / AC

### **2.5.5 Test Equipment Used**

The major items of test equipment used for the above tests are identified in Section 3.1.

### **2.5.6 Environmental Conditions/ Test Location**

Test performed at TÜV SÜD America Inc. Rancho Bernardo facility

Ambient Temperature	18.0 °C
Relative Humidity	30.0%
ATM Pressure	99.5 kPa

### **2.5.7 Additional Observations**

- This is a conducted test.
- An offset 1dB was used to compensate for the external cable used for Bluetooth LE measurements.
- RBW is 100kHz.VBW is 3X RBW.
- Sweep is auto. Detector is peak. Trace is max hold.
- Trace was centred on the band-edge frequency.
- Span was set to encompass the band-edge frequency and the peak of the emission.
- Using Marker function, peak of the emission was determined and the delta to the band-edge frequency measured.

### **2.5.8 Test Results**

Complies. See attached plots.

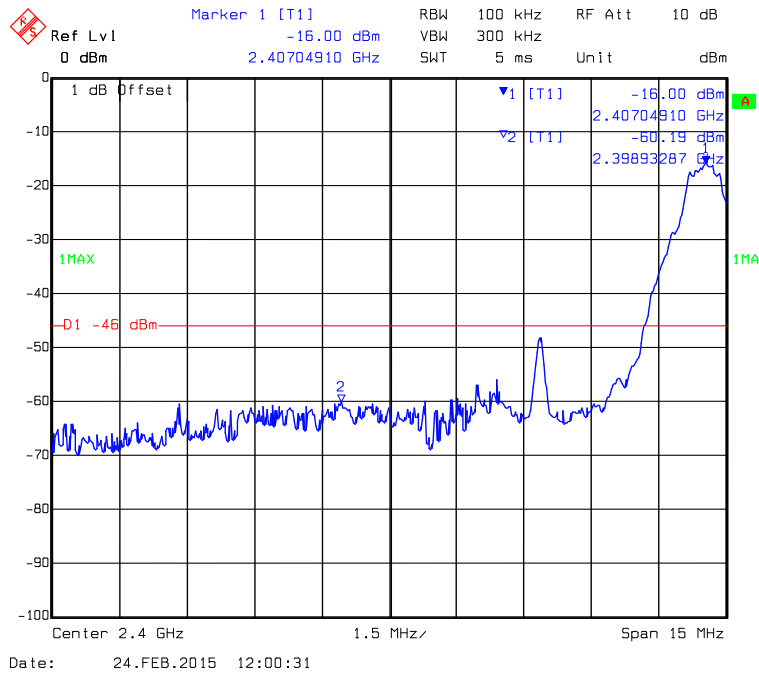

**Bluetooth LE Low Channel (2407 MHz)**

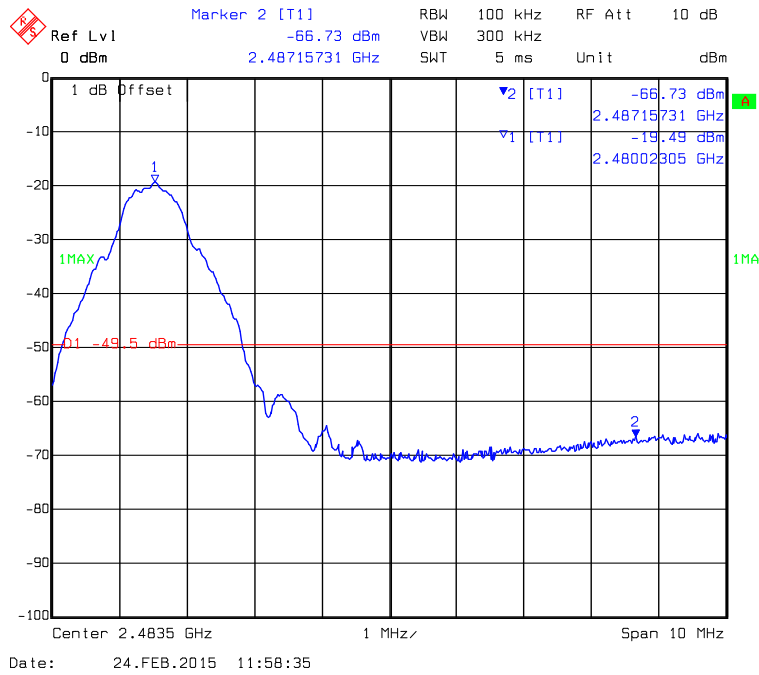

**Bluetooth LE High Channel (2480 MHz)**



## **2.6 SPURIOUS RADIATED EMISSIONS**

### **2.6.1 Specification Reference**

Part 15 Subpart C §15.247(d)

### **2.6.2 Standard Applicable**

(d) In any 100 kHz bandwidth outside the frequency band in which the spread spectrum or digitally modulated intentional radiator is operating, the radio frequency power that is produced by the intentional radiator shall be at least 20 dB below that in the 100 kHz bandwidth within the band that contains the highest level of the desired power, based on either an RF conducted or a radiated measurement, provided the transmitter demonstrates compliance with the peak conducted power limits. If the transmitter complies with the conducted power limits based on the use of RMS averaging over a time interval, as permitted under paragraph (b)(3) of this section, the attenuation required under this paragraph shall be 30 dB instead of 20 dB. Attenuation below the general limits specified in §15.209(a) is not required. In addition, radiated emissions which fall in the restricted bands, as defined in §15.205(a), must also comply with the radiated emission limits specified in §15.209(a) (see §15.205(c)).

### **2.6.3 Equipment Under Test and Modification State**

Serial No: N/A. Proto type simple / Test Configuration B

### **2.6.4 Date of Test/Initial of test personnel who performed the test**

February 25, 2015 / AC

### **2.6.5 Test Equipment Used**

The major items of test equipment used for the above tests are identified in Section 3.1.

### **2.6.6 Environmental Conditions**

Test performed at TÜV SÜD America Inc. Rancho Bernardo facility

Ambient Temperature	20.0°C
Relative Humidity	38.0%
ATM Pressure	99.5 kPa

### **2.6.7 Additional Observations**

- This is a radiated test. The spectrum was searched from 30MHz to the 10<sup>th</sup> harmonic.
- There are no emissions found that do not comply to the restricted bands defined in FCC Part 15 Subpart C, 15.205 or Part 15.247(d).
- Only the considered worst case WLAN configuration (802.11b, Low Channel, 1Mbps) presented for radiated emissions below 1GHz. There are no significant differences in emissions between all modes below 1GHz.
- Only noise floor measurements observed above 18GHz.



- Measurement was done using EMC32 automated software. Reported level is the actual level with all the correction factors factored in. Correction Factor column is for informational purposes only. See Section 2.6.8 for sample computation.

**2.6.8 Sample Computation (Radiated Emission)**

Measuring equipment raw measurement (dB $\mu$ V) @ 30 MHz		24.4
Correction Factor (dB)	Asset# 1066 (cable)	0.3
	Asset# 1172 (cable)	0.3
	Asset# 1016 (preamplifier)	-30.7
	Asset# 1175(cable)	0.3
	Asset# 1002 (antenna)	17.2
<b>Reported QuasiPeak Final Measurement (dB<math>\mu</math>V/m) @ 30MHz</b>		<b>11.8</b>

**2.6.9 Test Results**

See attached plots.



**2.6.10 Test Results Below 1GHz (Receive Mode)**

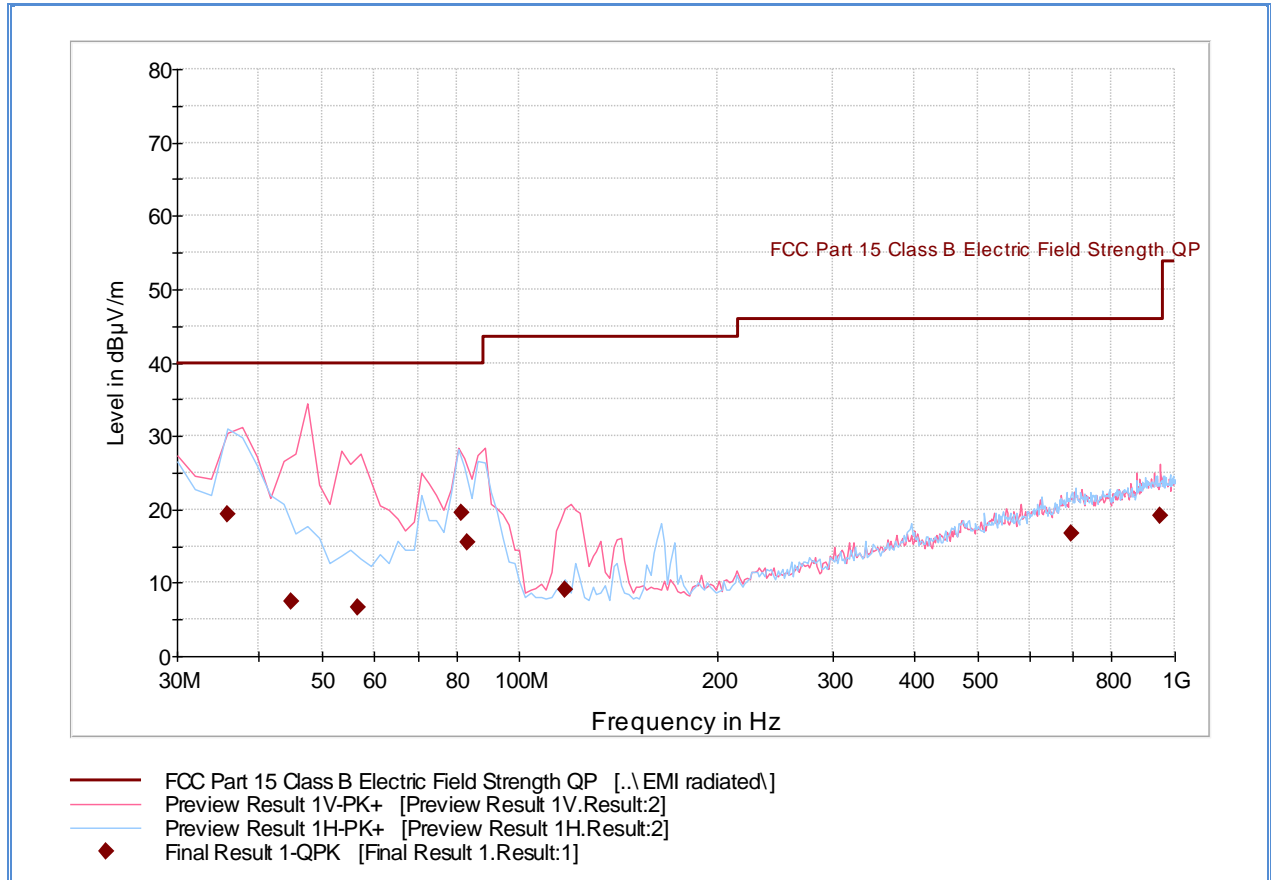

**Quasi Peak Data**

Frequency (MHz)	QuasiPeak (dBµV/m)	Meas. Time (ms)	Bandwidth (kHz)	Height (cm)	Polarization	Azimuth (deg)	Corr. (dB)	Margin (dB)	Limit (dBµV/m)
35.775551	19.4	1000.0	120.000	250.0	V	15.0	-14.0	20.6	40.0
44.854990	7.4	1000.0	120.000	100.0	V	176.0	-18.1	32.6	40.0
56.614429	6.7	1000.0	120.000	109.0	V	129.0	-20.9	33.3	40.0
81.341082	19.6	1000.0	120.000	100.0	V	19.0	-21.6	20.4	40.0
83.292745	15.5	1000.0	120.000	105.0	V	-10.0	-21.4	24.5	40.0
117.338838	9.1	1000.0	120.000	100.0	V	-11.0	-19.7	34.4	43.5
695.353507	16.7	1000.0	120.000	350.0	H	157.0	-1.6	29.3	46.0
948.658918	19.2	1000.0	120.000	297.0	V	113.0	1.5	26.8	46.0



**2.6.11 Test Results Above 1GHz (Receive Mode)**

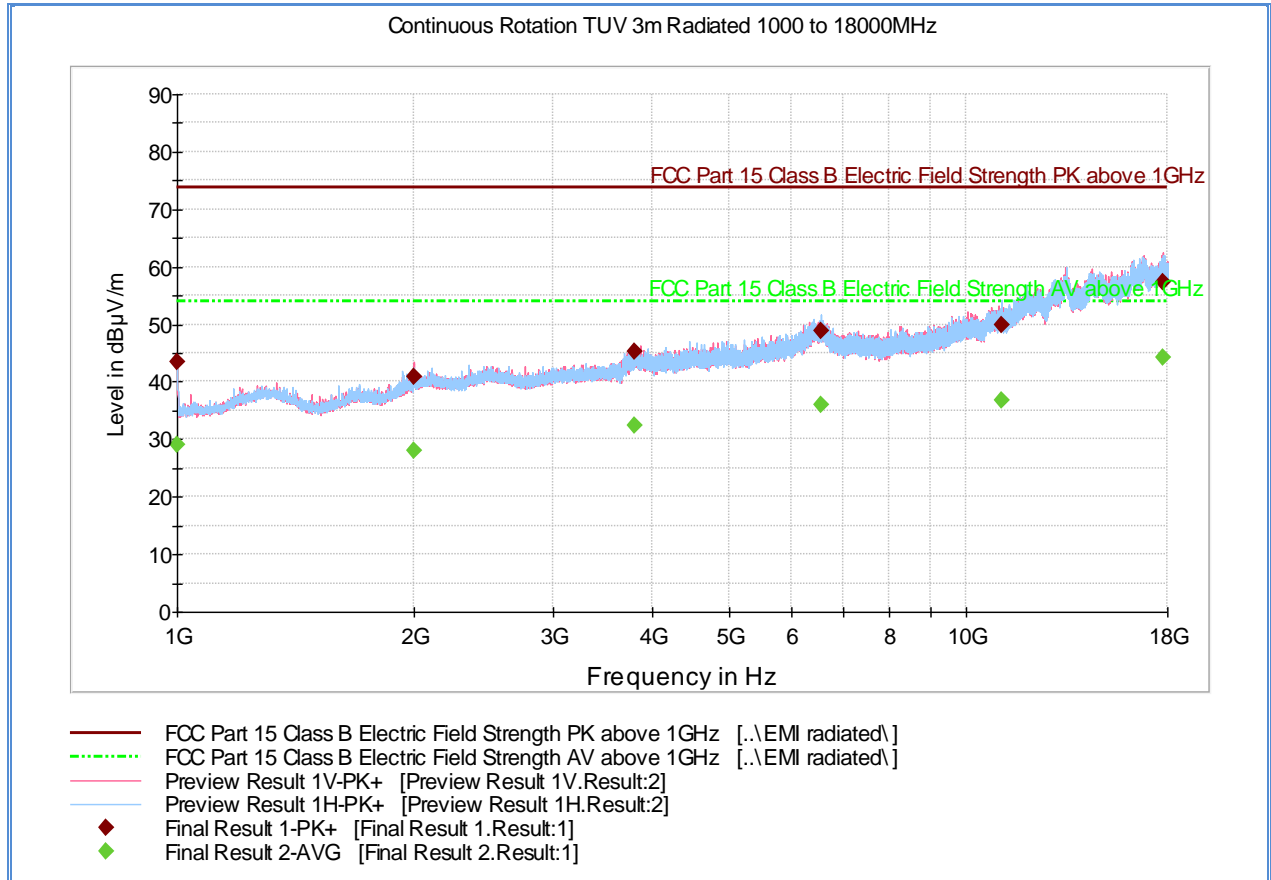

**Peak Data**

Frequency (MHz)	MaxPeak (dBµV/m)	Meas. Time (ms)	Bandwidth (kHz)	Height (cm)	Polarization	Azimuth (deg)	Corr. (dB)	Margin (dB)	Limit (dBµV/m)
1000.500000	43.6	1000.0	1000.000	235.4	V	115.0	-7.4	30.3	73.9
1992.366667	40.8	1000.0	1000.000	205.3	V	51.0	-1.7	33.1	73.9
3806.566667	45.2	1000.0	1000.000	402.0	H	243.0	4.9	28.7	73.9
6553.166667	48.8	1000.0	1000.000	201.3	H	3.0	11.3	25.1	73.9
11082.533333	49.8	1000.0	1000.000	131.7	H	20.0	14.6	24.1	73.9
17755.966666	57.4	1000.0	1000.000	300.6	V	96.0	23.2	16.5	73.9

**Average Data**

Frequency (MHz)	Average (dBµV/m)	Meas. Time (ms)	Bandwidth (kHz)	Height (cm)	Polarization	Azimuth (deg)	Corr. (dB)	Margin (dB)	Limit (dBµV/m)
1000.500000	29.1	1000.0	1000.000	235.4	V	115.0	-7.4	24.8	53.9
1992.366667	28.1	1000.0	1000.000	205.3	V	51.0	-1.7	25.8	53.9
3806.566667	32.4	1000.0	1000.000	402.0	H	243.0	4.9	21.5	53.9
6553.166667	36.0	1000.0	1000.000	201.3	H	3.0	11.3	17.9	53.9
11082.533333	36.6	1000.0	1000.000	131.7	H	20.0	14.6	17.3	53.9
17755.966666	44.2	1000.0	1000.000	300.6	V	96.0	23.2	9.7	53.9

**Test Notes:** No significant emissions observed above 1GHz.

**2.6.12 Test Results Below 1GHz (Bluetooth LE)**

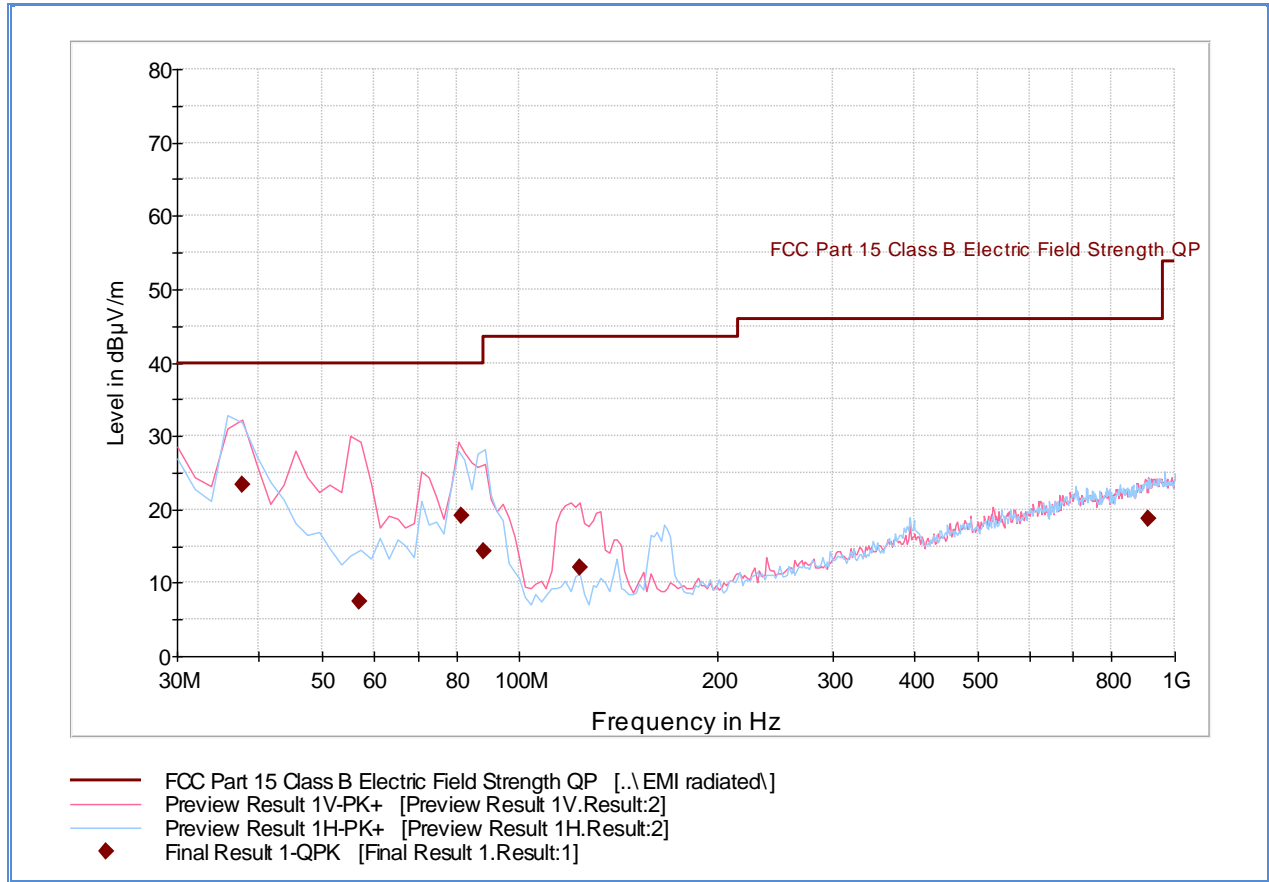

**Quasi Peak Data**

Frequency (MHz)	QuasiPeak (dBµV/m)	Meas. Time (ms)	Bandwidth (kHz)	Height (cm)	Polarization	Azimuth (deg)	Corr. (dB)	Margin (dB)	Limit (dBµV/m)
37.791663	23.4	1000.0	120.000	400.0	H	204.0	-15.1	16.6	40.0
56.870541	7.5	1000.0	120.000	110.0	V	208.0	-21.0	32.5	40.0
81.301082	19.1	1000.0	120.000	110.0	V	-11.0	-21.6	20.9	40.0
88.092745	14.3	1000.0	120.000	200.0	H	9.0	-20.8	29.2	43.5
123.626613	12.2	1000.0	120.000	200.0	V	11.0	-20.3	31.3	43.5
911.525050	18.8	1000.0	120.000	229.0	V	114.0	0.9	27.2	46.0

**Test Notes:** Only worst case channel presented for spurious emissions below 1GHz.





**2.6.13 Test Results Above 1GHz (Bluetooth LE Low Channel)**

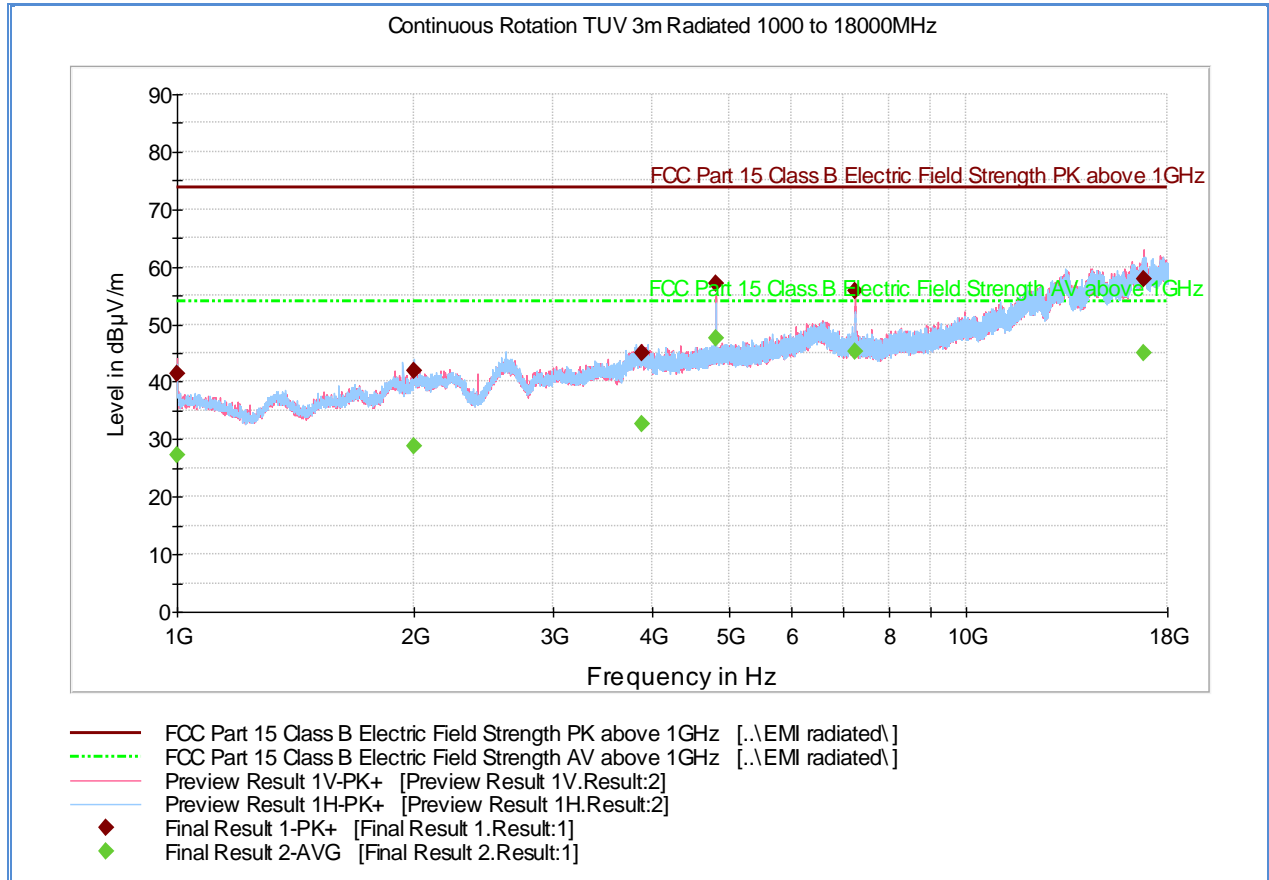

**Peak Data**

Frequency (MHz)	MaxPeak (dBµV/m)	Meas. Time (ms)	Bandwidth (kHz)	Height (cm)	Polarization	Azimuth (deg)	Corr. (dB)	Margin (dB)	Limit (dBµV/m)
1000.400000	41.3	1000.0	1000.000	146.7	V	329.0	-7.4	32.6	73.9
1999.600000	41.8	1000.0	1000.000	354.1	H	171.0	-1.6	32.1	73.9
3887.200000	45.0	1000.0	1000.000	406.7	V	240.0	5.0	28.9	73.9
4813.300000	57.1	1000.0	1000.000	200.5	V	112.0	5.6	16.8	73.9
7219.933333	55.8	1000.0	1000.000	301.2	V	68.0	9.7	18.1	73.9
16791.666667	57.8	1000.0	1000.000	378.1	V	76.0	23.6	16.1	73.9

**Average Data**

Frequency (MHz)	Average (dBµV/m)	Meas. Time (ms)	Bandwidth (kHz)	Height (cm)	Polarization	Azimuth (deg)	Corr. (dB)	Margin (dB)	Limit (dBµV/m)
1000.400000	27.3	1000.0	1000.000	146.7	V	329.0	-7.4	26.6	53.9
1999.600000	28.8	1000.0	1000.000	354.1	H	171.0	-1.6	25.1	53.9
3887.200000	32.5	1000.0	1000.000	406.7	V	240.0	5.0	21.4	53.9
4813.300000	47.6	1000.0	1000.000	200.5	V	112.0	5.6	6.3	53.9
7219.933333	45.3	1000.0	1000.000	301.2	V	68.0	9.7	8.6	53.9
16791.666667	45.0	1000.0	1000.000	378.1	V	76.0	23.6	8.9	53.9

**Test Notes:** Measurement was performed with a 2.4GHz notch filter. No significant emissions observed above 8GHz. Measurements above 8GHz were noise floor figures.

**2.6.14 Test Results Above 1GHz (Bluetooth LE Mid Channel)**

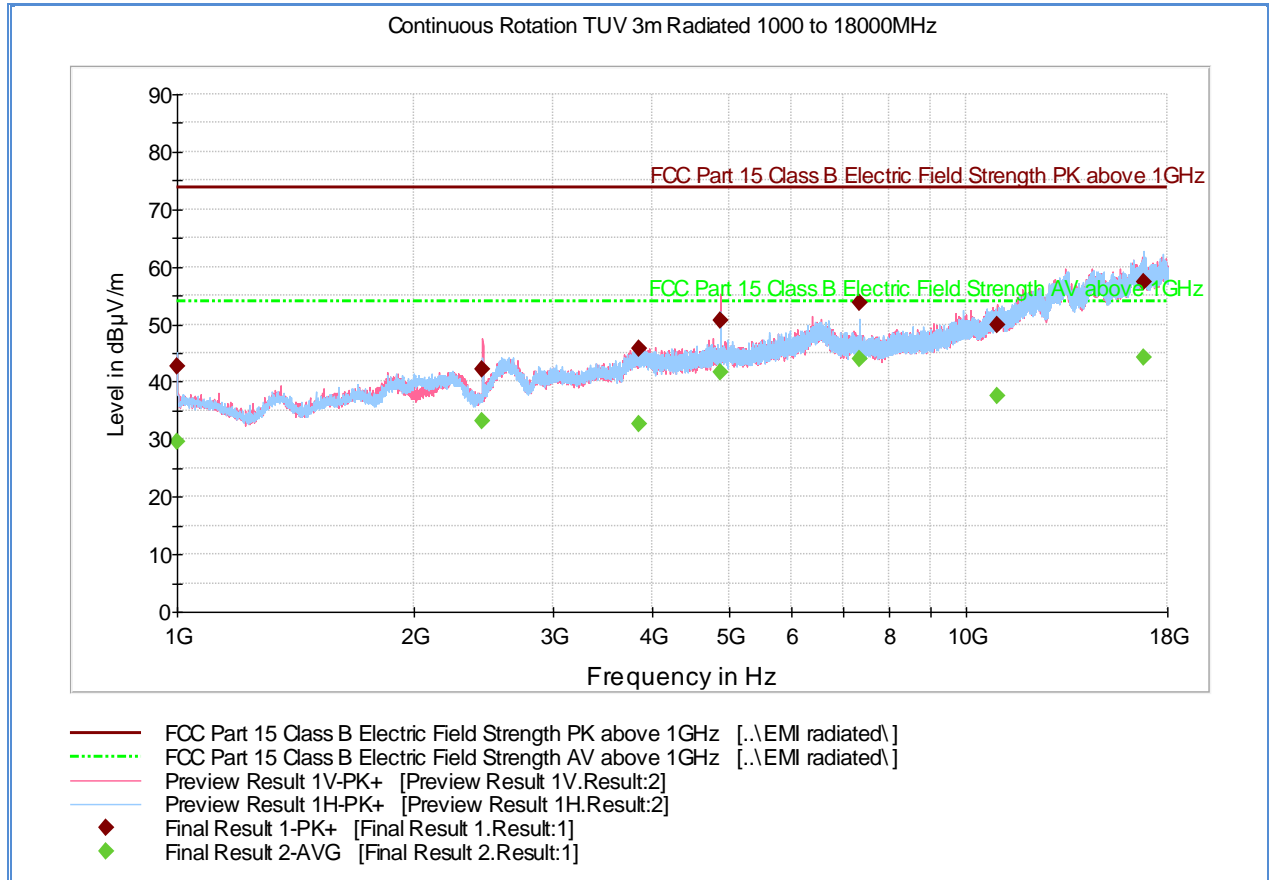

**Peak Data**

Frequency (MHz)	MaxPeak (dBµV/m)	Meas. Time (ms)	Bandwidth (kHz)	Height (cm)	Polarization	Azimuth (deg)	Corr. (dB)	Margin (dB)	Limit (dBµV/m)
1000.000000	42.6	1000.0	1000.000	218.4	H	297.0	-7.4	31.3	73.9
2439.700000	42.2	1000.0	1000.000	294.2	V	105.0	-0.3	31.7	73.9
3850.866667	45.7	1000.0	1000.000	146.7	H	90.0	4.9	28.2	73.9
4879.633333	50.6	1000.0	1000.000	140.7	V	63.0	6.1	23.3	73.9
7320.800000	53.9	1000.0	1000.000	216.4	H	114.0	9.6	20.0	73.9
10967.700000	49.9	1000.0	1000.000	202.3	V	151.0	14.8	24.0	73.9
16833.033333	57.4	1000.0	1000.000	123.7	H	34.0	23.3	16.5	73.9

**Average Data**

Frequency (MHz)	Average (dBµV/m)	Meas. Time (ms)	Bandwidth (kHz)	Height (cm)	Polarization	Azimuth (deg)	Corr. (dB)	Margin (dB)	Limit (dBµV/m)
1000.000000	29.6	1000.0	1000.000	218.4	H	297.0	-7.4	24.3	53.9
2439.700000	33.1	1000.0	1000.000	294.2	V	105.0	-0.3	20.8	53.9
3850.866667	32.6	1000.0	1000.000	146.7	H	90.0	4.9	21.3	53.9
4879.633333	41.6	1000.0	1000.000	140.7	V	63.0	6.1	12.4	53.9
7320.800000	44.0	1000.0	1000.000	216.4	H	114.0	9.6	9.9	53.9
10967.700000	37.5	1000.0	1000.000	202.3	V	151.0	14.8	16.4	53.9
16833.033333	44.3	1000.0	1000.000	123.7	H	34.0	23.3	9.6	53.9

**Test Notes:** Measurement was performed with a 2.4GHz notch filter. No significant emissions observed above 8GHz. Measurements above 8GHz were noise floor figures.



**2.6.15 Test Results Above 1GHz (Bluetooth LE High Channel)**

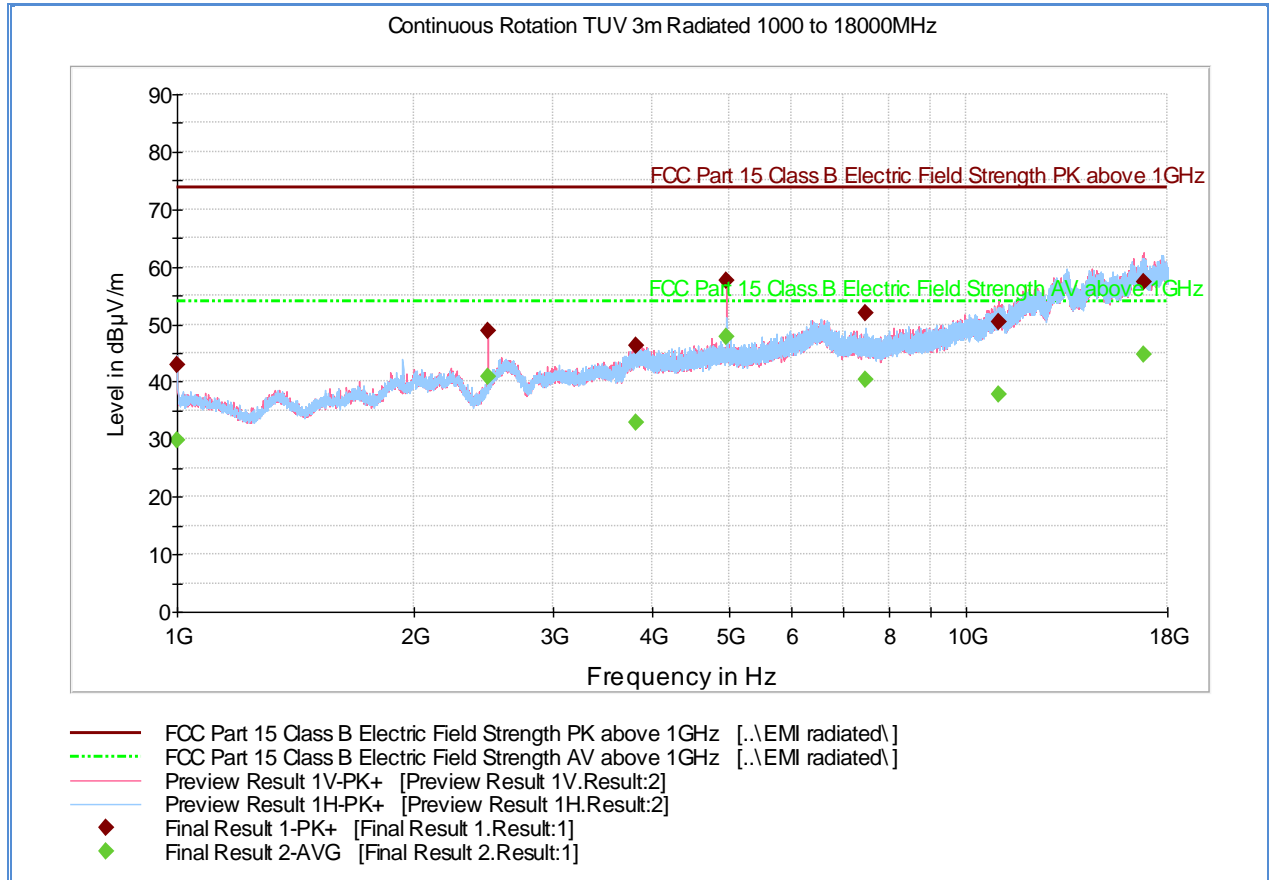

**Peak Data**

Frequency (MHz)	MaxPeak (dBµV/m)	Meas. Time (ms)	Bandwidth (kHz)	Height (cm)	Polarization	Azimuth (deg)	Corr. (dB)	Margin (dB)	Limit (dBµV/m)
1000.000000	42.9	1000.0	1000.000	218.4	H	240.0	-7.4	31.0	73.9
2479.533333	48.9	1000.0	1000.000	115.7	V	42.0	-0.1	25.0	73.9
3821.400000	46.2	1000.0	1000.000	181.6	H	320.0	4.9	27.7	73.9
4959.266667	57.6	1000.0	1000.000	103.7	V	59.0	6.3	16.3	73.9
7440.933333	51.8	1000.0	1000.000	207.5	H	132.0	9.2	22.1	73.9
11001.866667	50.3	1000.0	1000.000	161.6	V	191.0	14.9	23.6	73.9
16814.366667	57.4	1000.0	1000.000	391.1	V	347.0	23.5	16.5	73.9

**Average Data**

Frequency (MHz)	Average (dBµV/m)	Meas. Time (ms)	Bandwidth (kHz)	Height (cm)	Polarization	Azimuth (deg)	Corr. (dB)	Margin (dB)	Limit (dBµV/m)
1000.000000	29.8	1000.0	1000.000	218.4	H	240.0	-7.4	24.1	53.9
2479.533333	40.8	1000.0	1000.000	115.7	V	42.0	-0.1	13.1	53.9
3821.400000	32.8	1000.0	1000.000	181.6	H	320.0	4.9	21.1	53.9
4959.266667	47.9	1000.0	1000.000	103.7	V	59.0	6.3	6.0	53.9
7440.933333	40.3	1000.0	1000.000	207.5	H	132.0	9.2	13.6	53.9
11001.866667	37.8	1000.0	1000.000	161.6	V	191.0	14.9	16.1	53.9
16814.366667	44.8	1000.0	1000.000	391.1	V	347.0	23.5	9.1	53.9

**Test Notes:** Measurement was performed with a 2.4GHz notch filter. No significant emissions observed above 8GHz. Measurements above 8GHz were noise floor figures.



## **2.7 RADIATED BAND EDGE MEASUREMENTS AND IMMEDIATE RESTRICTED BANDS**

### **2.7.1 Specification Reference**

Part 15 Subpart C §15.247(d)

### **2.7.2 Standard Applicable**

(d) In any 100 kHz bandwidth outside the frequency band in which the spread spectrum or digitally modulated intentional radiator is operating, the radio frequency power that is produced by the intentional radiator shall be at least 20 dB below that in the 100 kHz bandwidth within the band that contains the highest level of the desired power, based on either an RF conducted or a radiated measurement, provided the transmitter demonstrates compliance with the peak conducted power limits. If the transmitter complies with the conducted power limits based on the use of RMS averaging over a time interval, as permitted under paragraph (b)(3) of this section, the attenuation required under this paragraph shall be 30 dB instead of 20 dB. Attenuation below the general limits specified in §15.209(a) is not required. In addition, radiated emissions which fall in the restricted bands, as defined in §15.205(a), must also comply with the radiated emission limits specified in §15.209(a) (see §15.205(c)).

### **2.7.3 Equipment Under Test and Modification State**

Serial No: N/A. Proto type simple / Test Configuration B

### **2.7.4 Date of Test/Initial of test personnel who performed the test**

February 25, 2015 / AC

### **2.7.5 Test Equipment Used**

The major items of test equipment used for the above tests are identified in Section 3.1.

### **2.7.6 Environmental Conditions/ Test Location**

Test performed at TÜV SÜD America Inc. Rancho Bernardo facility

Ambient Temperature	20.0 °C
Relative Humidity	38.0%
ATM Pressure	99.5 kPa

### **2.7.7 Additional Observations**

- This is a radiated test. The spectrum was searched from 2310MHz to 2390MHz for lower immediate restricted band and 2483.5MHz to 2500MHz for the upper immediate restricted band.
- There are no emissions found that do not comply with the restricted bands defined in FCC Part 15 Subpart C, 15.205.
- Measurement was done using EMC32 automated software. Reported level is the actual level with all the correction factors factored in. Correction Factor column is for informational purposes only. See Section 2.7.8 for sample computation.



**2.7.8 Sample Computation (Radiated Emission)**

Measuring equipment raw measurement (dB $\mu$ V) @ 2400 MHz		53.9
Correction Factor (dB)	Asset# 1153 (cable)	3.4
	Asset# 8628(pre-amplifier)	-36.5
	Asset#7575 (antenna)	32.7
<b>Reported Max Peak Final Measurement (dB<math>\mu</math>V/m) @ 2400 MHz</b>		<b>53.5</b>

**2.7.9 Test Results**

See attached plots.



**2.7.10 Test Results Restricted Band 2310MHz to 2490MHz (Bluetooth LE Low Channel)**

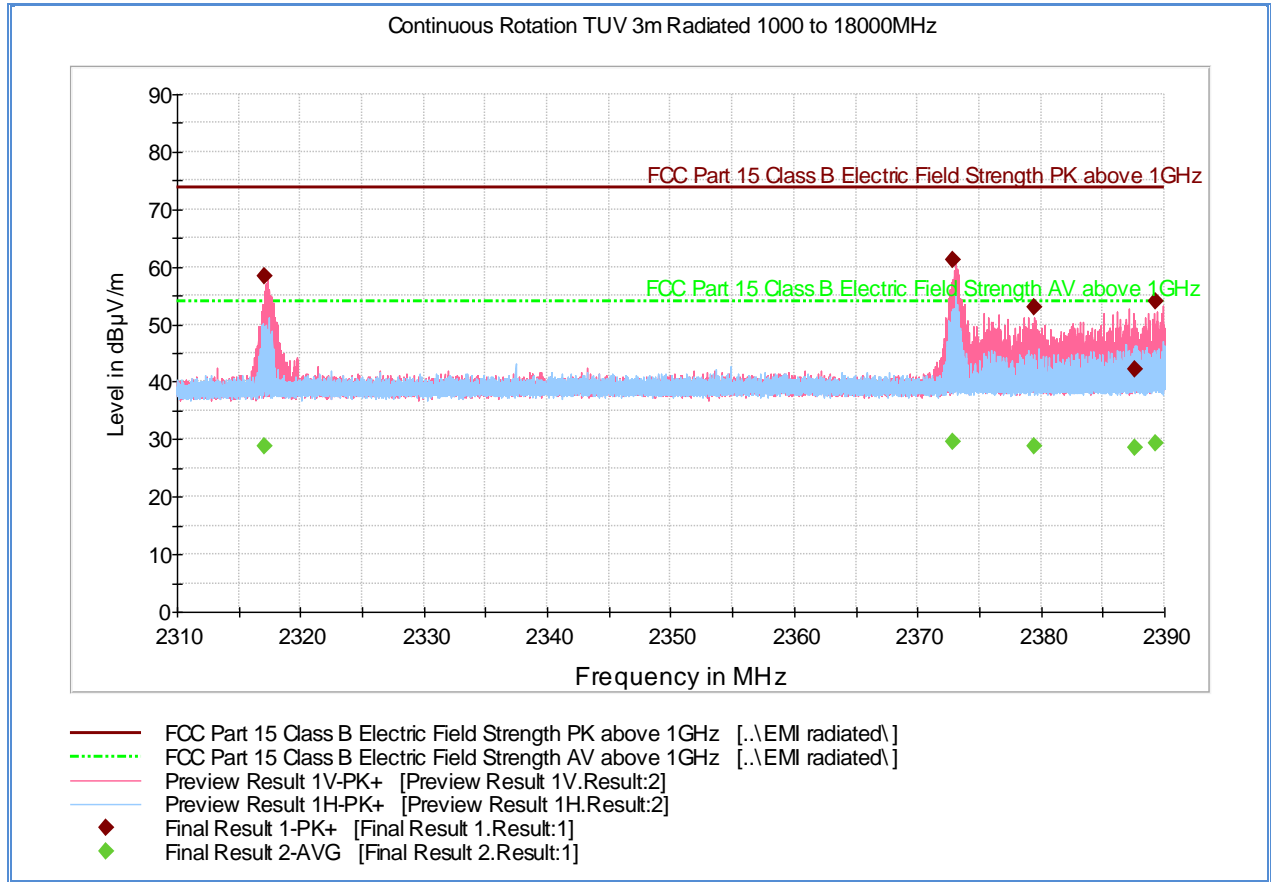

**Peak Data**

Frequency (MHz)	MaxPeak (dBµV/m)	Meas. Time (ms)	Bandwidth (kHz)	Height (cm)	Polarization	Azimuth (deg)	Corr. (dB)	Margin (dB)	Limit (dBµV/m)
2317.120000	58.3	1000.0	1000.000	102.7	V	121.0	-1.0	15.6	73.9
2372.853333	61.1	1000.0	1000.000	101.7	V	71.0	-0.7	12.8	73.9
2379.448000	52.9	1000.0	1000.000	102.7	V	71.0	-0.7	21.0	73.9
2387.578667	42.1	1000.0	1000.000	177.6	V	71.0	-0.7	31.8	73.9
2389.280000	54.0	1000.0	1000.000	103.7	V	72.0	-0.6	19.9	73.9

**Average Data**

Frequency (MHz)	Average (dBµV/m)	Meas. Time (ms)	Bandwidth (kHz)	Height (cm)	Polarization	Azimuth (deg)	Corr. (dB)	Margin (dB)	Limit (dBµV/m)
2317.120000	28.7	1000.0	1000.000	102.7	V	121.0	-1.0	25.2	53.9
2372.853333	29.4	1000.0	1000.000	101.7	V	71.0	-0.7	24.5	53.9
2379.448000	28.9	1000.0	1000.000	102.7	V	71.0	-0.7	25.0	53.9
2387.578667	28.6	1000.0	1000.000	177.6	V	71.0	-0.7	25.3	53.9
2389.280000	29.4	1000.0	1000.000	103.7	V	72.0	-0.6	24.5	53.9

**Test Notes: 2.4GHz notch filter removed for this test.**

**2.7.11 Test Results Restricted Band 2483.5MHz to 2500MHz (Bluetooth LE High Channel)**

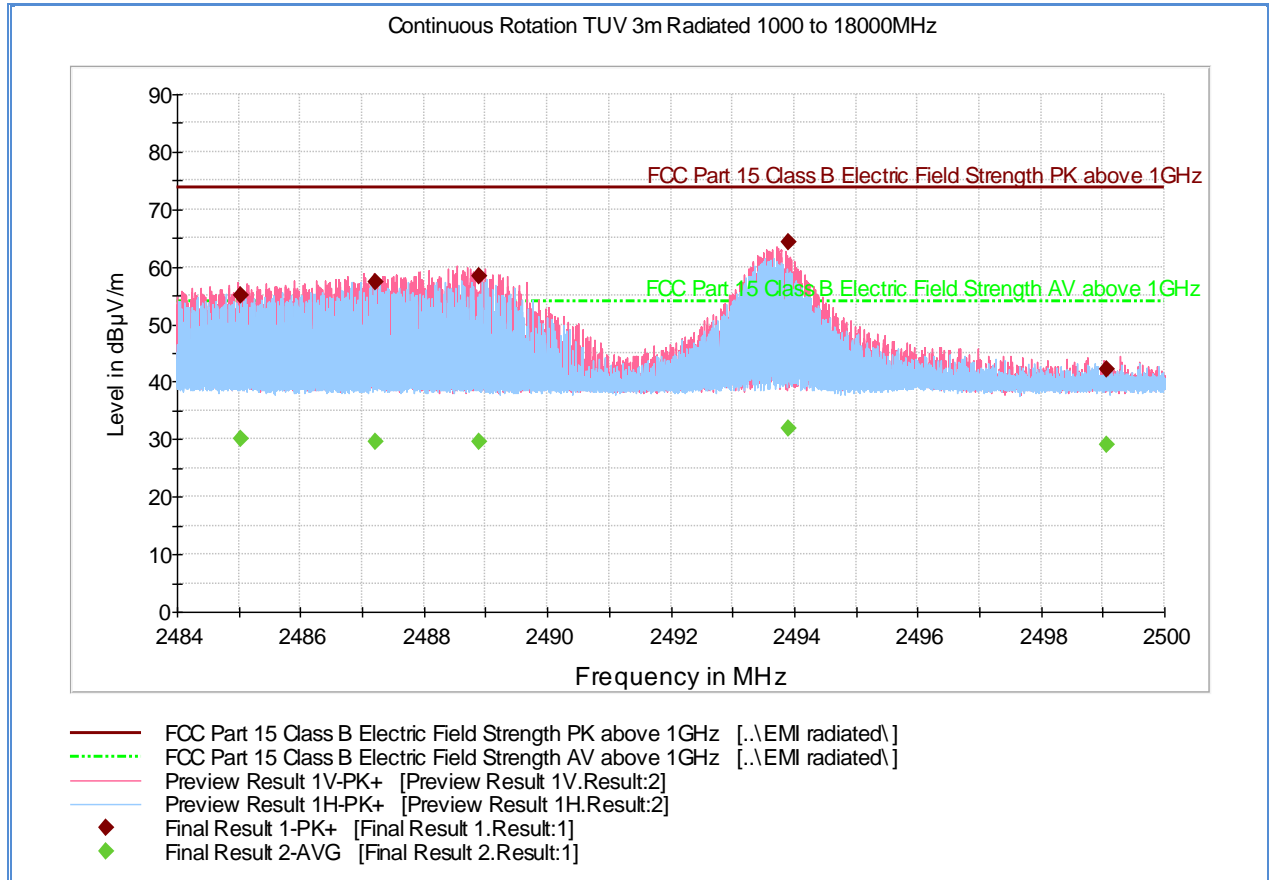

**Peak Data**

Frequency (MHz)	MaxPeak (dBµV/m)	Meas. Time (ms)	Bandwidth (kHz)	Height (cm)	Polarization	Azimuth (deg)	Corr. (dB)	Margin (dB)	Limit (dBµV/m)
2485.030400	55.2	1000.0	1000.000	131.7	V	70.0	-0.1	18.7	73.9
2487.213333	57.4	1000.0	1000.000	131.7	V	70.0	-0.1	16.5	73.9
2488.891733	58.5	1000.0	1000.000	131.7	V	70.0	-0.1	15.4	73.9
2493.909867	64.4	1000.0	1000.000	101.7	V	67.0	-0.1	9.5	73.9
2499.073600	42.2	1000.0	1000.000	147.7	V	294.0	-0.1	31.7	73.9

**Average Data**

Frequency (MHz)	Average (dBµV/m)	Meas. Time (ms)	Bandwidth (kHz)	Height (cm)	Polarization	Azimuth (deg)	Corr. (dB)	Margin (dB)	Limit (dBµV/m)
2485.030400	30.2	1000.0	1000.000	131.7	V	70.0	-0.1	23.7	53.9
2487.213333	29.7	1000.0	1000.000	131.7	V	70.0	-0.1	24.2	53.9
2488.891733	29.5	1000.0	1000.000	131.7	V	70.0	-0.1	24.4	53.9
2493.909867	31.8	1000.0	1000.000	101.7	V	67.0	-0.1	22.1	53.9
2499.073600	29.0	1000.0	1000.000	147.7	V	294.0	-0.1	24.9	53.9

**Test Notes: 2.4GHz notch filter removed for this test.**



## **2.8 POWER SPECTRAL DENSITY**

### **2.8.1 Specification Reference**

Part 15 Subpart C §15.247(e)

### **2.8.2 Standard Applicable**

(e) For digitally modulated systems, the power spectral density conducted from the intentional radiator to the antenna shall not be greater than 8 dBm in any 3 kHz band during any time interval of continuous transmission. This power spectral density shall be determined in accordance with the provisions of paragraph (b) of this section. The same method of determining the conducted output power shall be used to determine the power spectral density.

### **2.8.3 Equipment Under Test and Modification State**

Serial No: PCB board sample / Test Configuration A

### **2.8.4 Date of Test/Initial of test personnel who performed the test**

February 24, 2015 / AC

### **2.8.5 Test Equipment Used**

The major items of test equipment used for the above tests are identified in Section 3.1.

### **2.8.6 Environmental Conditions/ Test Location**

Test performed at TÜV SÜD America Inc. Rancho Bernardo facility

Ambient Temperature	18.0°C
Relative Humidity	30.2%
ATM Pressure	99.5 kPa

### **2.8.7 Additional Observations**

- This is a conducted test.
- Test procedure is per Section 10.3 of KDB 558074 (June 05, 2014).
- An offset 1dB was used to compensate for the external cable used for Bluetooth LE measurements.
- Detector is RMS power averaging.
- Trace averaging mode over 100 traces.
- Sweep time is Auto Couple.
- EUT complies with 100 kHz RBW.





**2.8.8 Test Results Summary**

Mode	Channel (MHz)	Marker Reading using 100 kHz RBW (dBm)	PSD Limit (dBm)	Margin (dB)	Compliance
Bluetooth LE	2407	-19.02	8	27.02	Complies
	2440	-18.23	8	26.23	Complies
	2480	-16.53	8	24.53	Complies

**2.8.9 Test Results Plots**

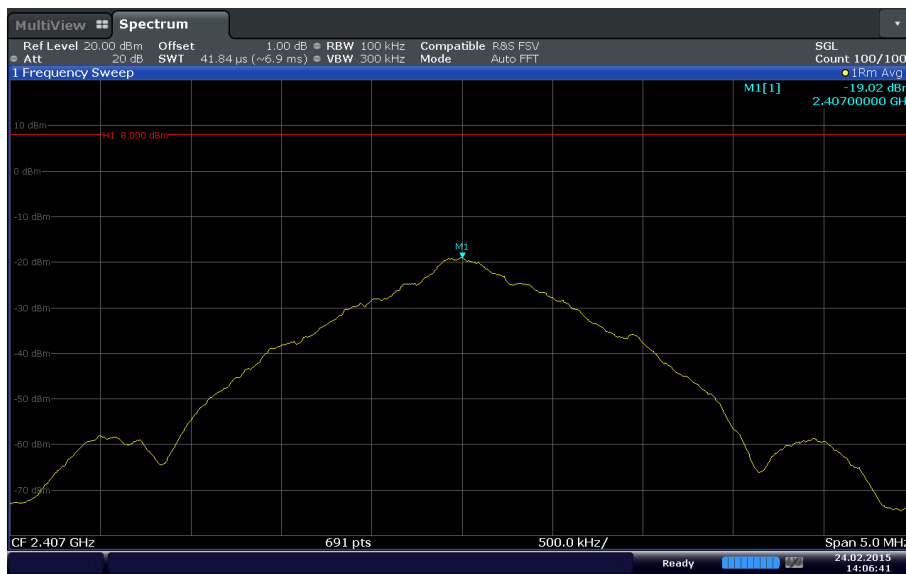

Date: 24.FEB.2015 14:06:40

**Bluetooth LE Low Channel**

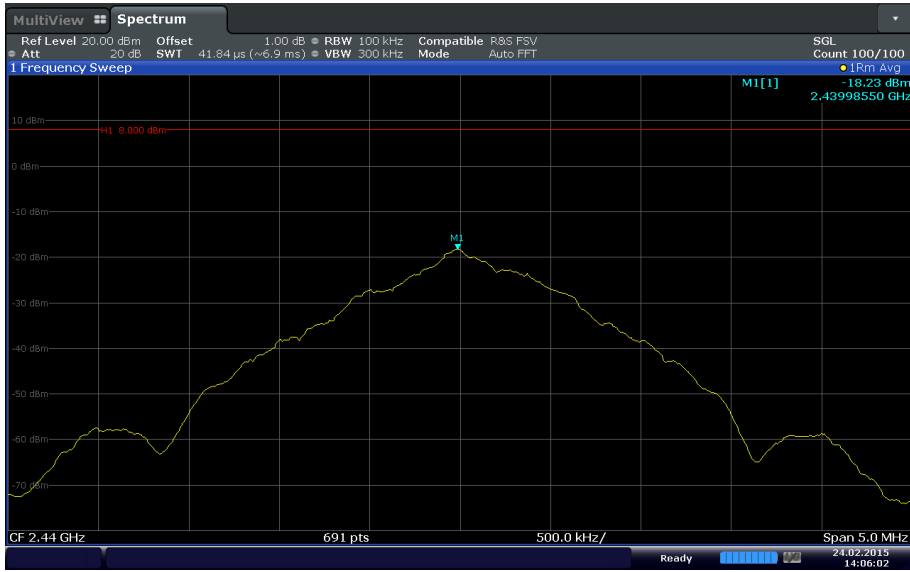

Date: 24.FEB.2015 14:06:03

Bluetooth LE Mid Channel

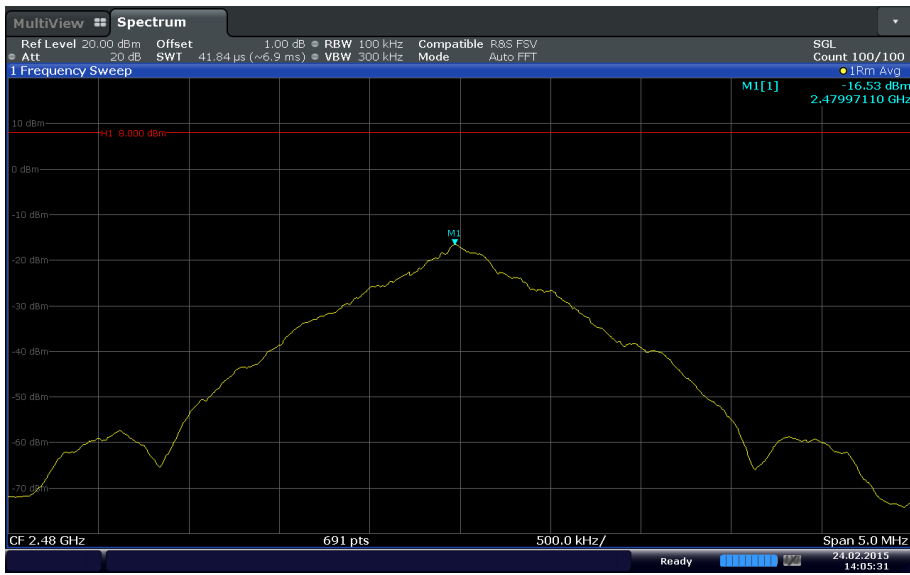

Date: 24.FEB.2015 14:05:31

Bluetooth LE High Channel



### **SECTION 3**

#### **TEST EQUIPMENT USED**



### 3.1 TEST EQUIPMENT USED

List of absolute measuring and other principal items of test equipment.

ID Number (SDGE/SDRB)	Test Equipment	Type	Serial Number	Manufacturer	Cal Date	Cal Due Date
<b>Antenna Conducted Port Setup</b>						
1184	Spectrum Analyzer	FSEM	849718/025	Rhode & Schwarz	06/27/14	06/27/15
7582	Signal/Spectrum Analyzer	FSW26	101614	Rhode & Schwarz	12/22/14	12/22/15
1188	Signal Generator	2024	112282/488	Marconi	10/20/14	10/20/15
8825	20dB Attenuator	46-20-34	BK5773	Weinschel Corp.	Verified by 1188 and 7582	
<b>Radiated Test Setup</b>						
1002	Bilog Antenna	3142C	00058717	ETS-Lindgren	01/30/14	01/30/16
7575	Double-ridged waveguide horn antenna	3117	00155511	EMCO	04/08/14	04/08/15
8628	Pre-amplifier	QLJ 01182835-JO	8986002	QuinStar Technologies Inc.	04/03/14	04/03/15
1040	EMI Test Receiver	ESIB40	100292	Rhode & Schwarz	08/29/14	08/29/15
1049	EMI Test Receiver	ESU	100133	Rhode & Schwarz	03/17/14	03/17/15
6815	2.4GHz Band Notch Filter	BRM50702	008	Micro-Tronics	Verified by 1188 and 7582	
1016	Pre-amplifier	PAM-0202	187	PAM	12/10/14	12/10/15
1150	Horn antenna	3160-09	012054-004	ETS	04/26/13	04/26/15
1151	Pre-amplifier	TS-PR26	100026	Rhode & Schwarz	05/02/13	05/02/15
6669						
7582	Signal/Spectrum Analyzer	FSW26	101614	Rhode & Schwarz	11/19/13	11/19/14
7579						
<b>Miscellaneous</b>						
6792	Multimeter	3478A	2911A70964	Hewlett Packard	08/12/14	08/12/15
1072	DC Power Supply	E3610A	KR51311519	Hewlett Packard	Verified by 6452	
	Test Software	EMC32	V8.53	Rhode & Schwarz	N/A	



### 3.2 MEASUREMENT UNCERTAINTY

For a 95% confidence level, the measurement uncertainties for defined systems are:

#### 3.2.1 Radiated Emission Measurements (Below 1GHz)

Contribution		Probability Distribution Type	Probability Distribution $x_i$	Standard Uncertainty $u(x_i)$	$[u(x_i)]^2$
1	Receiver/Spectrum Analyzer	Rectangular	0.45	0.26	0.07
2	Cables	Rectangular	0.50	0.29	0.08
3	Preamp	Rectangular	0.50	0.29	0.08
4	Antenna	Rectangular	0.75	0.43	0.19
5	Site	Rectangular	3.89	2.25	5.04
6	EUT Setup	Rectangular	1.00	0.58	0.33
Combined Uncertainty ( $u_c$ ):					2.41
Coverage Factor (k):					2
Expanded Uncertainty:					4.82

#### 3.2.2 Radiated Emission Measurements (Above 1GHz)

Contribution		Probability Distribution Type	Probability Distribution $x_i$	Standard Uncertainty $u(x_i)$	$[u(x_i)]^2$
1	Receiver/Spectrum Analyzer	Rectangular	0.57	0.33	0.11
2	Cables	Rectangular	0.70	0.40	0.16
3	Preamp	Rectangular	0.50	0.29	0.08
4	Antenna	Rectangular	0.37	0.21	0.05
5	Site	Rectangular	3.89	2.25	5.04
6	EUT Setup	Rectangular	1.00	0.58	0.33
Combined Uncertainty ( $u_c$ ):					2.40
Coverage Factor (k):					2
Expanded Uncertainty:					4.81

#### 3.2.3 Conducted Antenna Port Measurement

Contribution		Probability Distribution Type	Probability Distribution $x_i$	Standard Uncertainty $u(x_i)$	$[u(x_i)]^2$
1	Receiver/Spectrum Analyzer	Rectangular	0.34	0.20	0.04
2	Cables	Rectangular	1.00	0.58	0.33
3	EUT Setup	Rectangular	0.50	0.29	0.08
Combined Uncertainty ( $u_c$ ):					0.67
Coverage Factor (k):					1.96
Expanded Uncertainty:					1.32



## SECTION 4

### DIAGRAM OF TEST SETUP

#### 4.1 TEST SETUP DIAGRAM

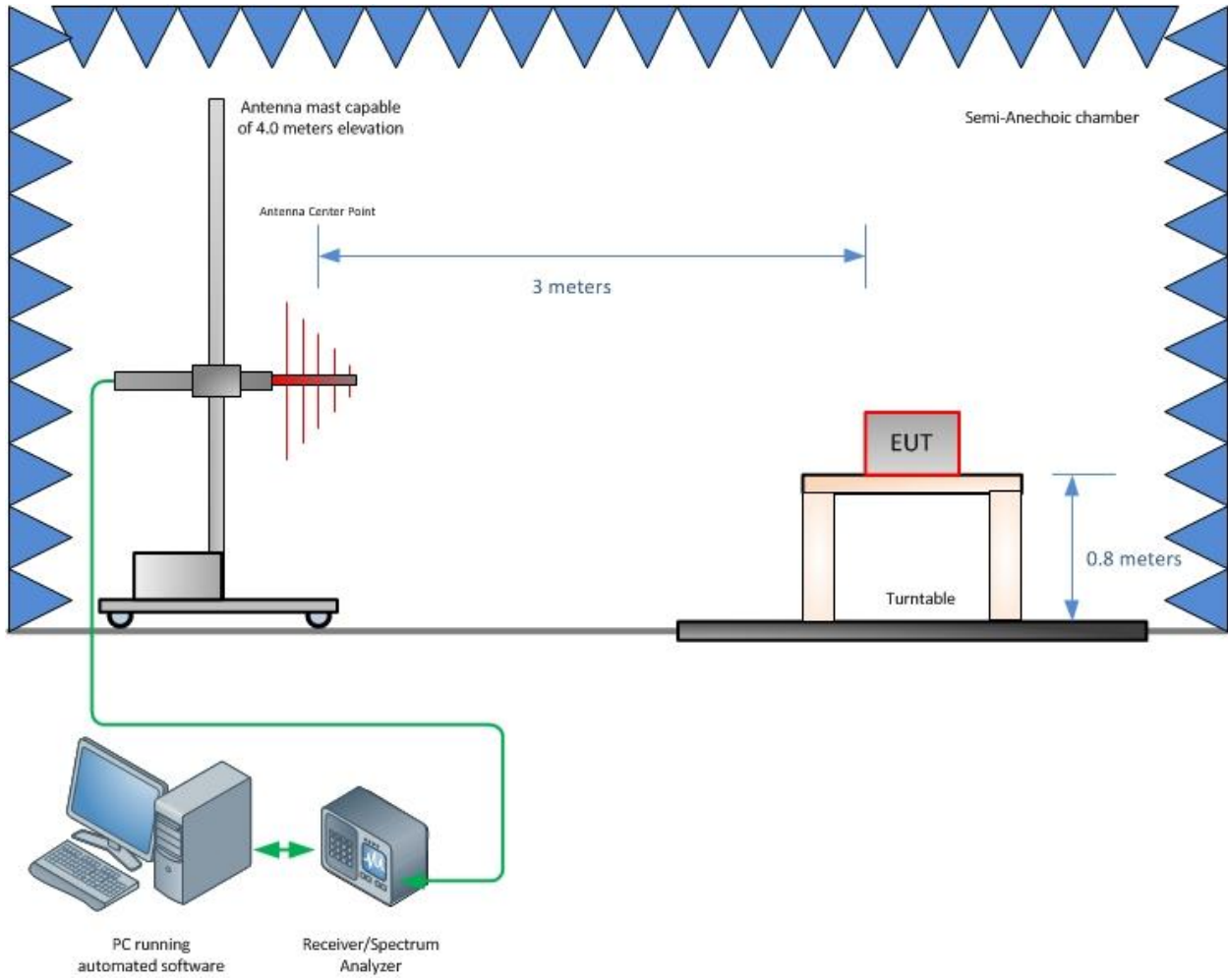

**Radiated Emission Test Setup (Below 1GHz)**

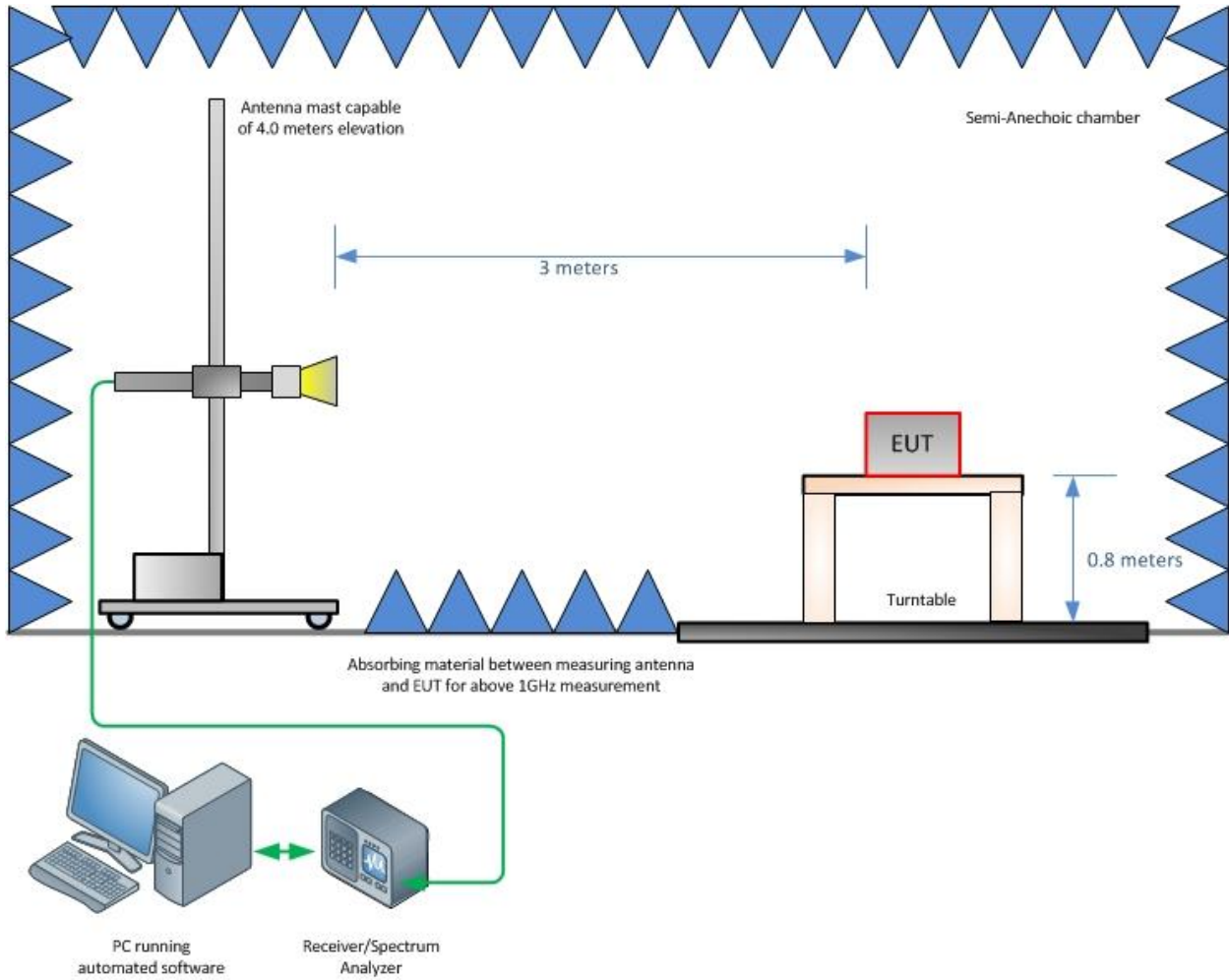

**Radiated Emission Test Setup (Above 1GHz)**





## SECTION 5

### ACCREDITATION, DISCLAIMERS AND COPYRIGHT



## 5.1 ACCREDITATION, DISCLAIMERS AND COPYRIGHT

TÜV SÜD America Inc.'s reports apply only to the specific sample tested under stated test conditions. It is the manufacturer's responsibility to assure the continued compliance of production units of this model. TÜV SÜD America, Inc. shall have no liability for any deductions, inferences or generalizations drawn by the client or others from TÜV SÜD America, Inc.'s issued reports.

This report is the confidential property of the client. As a mutual protection to our clients, the public and TÜV SÜD America, Inc., extracts from the test report shall not be reproduced, except in full without TÜV SÜD America, Inc.'s written approval.

This report must not be used to claim product certification, approval, or endorsement by A2LA, NIST, or any agency of the federal government.

TÜV SÜD America, Inc. and its professional staff hold government and professional organization certifications for AAMI, ACIL, AEA, ANSI, IEEE, A2LA, NIST and VCCI.

