



America

---

**Choose certainty.  
Add value.**

## Report On

Application for Grant of Equipment Authorization of the  
SMK Electronics Corp.  
2.4GHz USB Repeater

FCC Part 15 Subpart C §15.247  
IC RSS-Gen Issue 4 November 2014  
IC RSS-210 Issue 8 December 2010

Report No. SD72101556A-0115 Rev.1

May 2015



**REPORT ON** Radio Testing of the  
SMK Electronics Corp.  
2.4GHz USB Repeater

**TEST REPORT NUMBER** SD72101556A-0115 Rev.1

**PREPARED FOR** SMK Electronics Corp.  
1055 Tierra del Rey, Suite H  
Chula Vista, CA 91910

**CONTACT PERSON** Nikolay Shtin  
RF Engineer  
(619) 216-6400  
nshtin@smkusa.com

**PREPARED BY** Alex Chang  
**Name**  
Authorized Signatory  
Title: EMC/Wireless Test Engineer

**APPROVED BY** Juan Manuel Gonzalez  
**Name**  
Authorized Signatory  
Title: Commercial/Wireless EMC Lab Manager

**DATED** May 13, 2015



**Revision History**

SD72101556A-0115 Rev.1 SMK Electronics Corp. 2.4GHz USB Repeater					
DATE	OLD REVISION	NEW REVISION	REASON	PAGES AFFECTED	APPROVED BY
05/04/2015	Initial Release				Juan M. Gonzalez
05/13/2015		Rev.1	Revised antenna gain	9	Alex Chang



## CONTENTS

Section	Page No
<b>1</b>	<b>REPORT SUMMARY .....5</b>
1.1	Introduction.....6
1.2	Brief Summary of Results..... 7
1.3	Product Information .....8
1.4	EUT Test Configuration ..... 10
1.5	Deviations From The Standard..... 12
1.6	Modification Record ..... 12
1.7	Test Methodology ..... 12
1.8	Test Facility Location ..... 12
1.9	Test Facility Registration..... 12
<b>2</b>	<b>TEST DETAILS..... 14</b>
2.1	Peak Output Power.....15
2.2	99% Emission Bandwidth..... 17
2.3	Minimum 6 dB RF Bandwidth ..... 20
2.4	Out-Of-Band Emissions - Conducted..... 23
2.5	Band-Edge Compliance of RF Conducted Emissions..... 26
2.6	Spurious Radiated Emissions ..... 28
2.7	Radiated Band Edge Measurements and Immediate Restricted Bands ..... 38
2.8	Power Spectral Density..... 42
<b>3</b>	<b>TEST EQUIPMENT USED ..... 45</b>
3.1	Test Equipment Used..... 46
3.2	Measurement Uncertainty ..... 47
<b>4</b>	<b>DIAGRAM OF TEST SETUP ..... 48</b>
4.1	Test Setup Diagram ..... 49
<b>5</b>	<b>ACCREDITATION, DISCLAIMERS AND COPYRIGHT ..... 51</b>
5.1	Accreditation, Disclaimers and Copyright ..... 52



## **SECTION 1**

### **REPORT SUMMARY**

Radio Testing of the  
SMK Electronics Corp.  
2.4GHz USB Repeater



## 1.1 INTRODUCTION

The information contained in this report is intended to show verification of the SMK Electronics Corp. 2.4GHz USB Repeater model 1010512172 to the requirements of FCC Part 15 Subpart C §15.247, IC RSS-Gen Issue 4 November 2014 and IC RSS-210 Issue 8 December 2010.

Objective	To perform Radio Testing to determine the Equipment Under Test's (EUT's) compliance with the Test Specification, for the series of tests carried out.
Manufacturer	SMK Electronics Corp.
Model Number(s)	1010512172
FCC ID Number	UXUPR2
IC Number	7316A-PR2
Serial Number(s)	Conducted antenna port testing sample, serial number not available. This is a PCB board only. Radiated testing sample, serial number not available. Proto type sample provided.
Number of Samples Tested	2
Test Specification/Issue/Date	<ul style="list-style-type: none"><li>• FCC Part 15 Subpart C §15.247 (October 1, 2014).</li><li>• RSS-210 - Licence-exempt Radio Apparatus (All Frequency Bands): Category I Equipment (Issue 8, December 2010).</li><li>• RSS-Gen - General Requirements for Compliance of Radio Apparatus (Issue 4, November 2014).</li><li>• 558074 D01 DTS Meas Guidance v03r02, (June 05, 2014) Guidance for Performing Compliance Measurements on Digital Transmission Systems (DTS) Operating Under §15.247.</li></ul>
Start of Test	April 13, 2015
Finish of Test	April 14, 2015
Name of Engineer(s)	Alex Chang
Related Document(s)	None. Supporting documents for EUT certification are separate exhibits.



## 1.2 BRIEF SUMMARY OF RESULTS

A brief summary of the tests carried out in accordance with FCC Part 15 Subpart C §15.247 with cross-reference to the corresponding IC RSS standard is shown below.

Section	§15.247 Spec Clause	RSS	Test Description	Result	Comments/ Base Standard
2.1	§15.247(b)(3)	RSS-210 A8.4(4)	Peak Output Power	Compliant	
—	§15.207(a)	RSS-Gen 8.8	Conducted Emissions	N/A *)	
2.2		RSS-Gen 6.6	99% Emission Bandwidth	Compliant	
2.3	§15.247(a)(2)	RSS-210 A8.2(a)	Minimum 6 dB RF Bandwidth	Compliant	
2.4	§15.247(d)	RSS-210 A8.5	Out-of-Band Emissions - Conducted	Compliant	
2.5	§15.247(d)	RSS-210 A8.5	Band-edge Compliance of RF Conducted Emissions	Compliant	
2.6	§15.247(d)	RSS-210 A8.5	Spurious Radiated Emissions	Compliant	
2.7		RSS-Gen 7.1	Receiver Spurious Emissions	Compliant	
2.8	§15.247(d)	RSS-210 A8.5	Radiated Band Edge Measurements	Compliant	
2.9	§15.247(e)	RSS-210 A8.2(b)	Power Spectral Density for Digitally Modulated Device	Compliant	

\*) Not applicable. EUT is a USB powered operated device.

### 1.3 PRODUCT INFORMATION

#### 1.3.1 Technical Description

The Equipment Under Test (EUT) is a SMK Electronics Corp. PV Repeater 2.4GHz USB Repeater as shown in the photograph below.



**Equipment Under Test**





**1.3.2 EUT General Description**

EUT Description	2.4GHz USB Repeater
Model Name	PV Repeater
Model Number(s)	1010512172
Rated Voltage	5VDC USB powered
Frequency Range	2407 MHz to 2480 MHz in the 2400 MHz to 2483.5 MHz Band
Test Mode	Embedded 2.4 GHz transceiver utilizing a proprietary RF protocol
Number of Operating Frequencies	74
Channels Verified	Low Channel 2407MHz Mid Channel 2440MHz High Channel 2480MHz
Antenna Type (used during evaluation)	Integral (Complies with Part 15.203 requirements)

**1.3.3 Antenna Details**

Manufacturer	Fractus
Antenna Name	Fractus Compact Reach Xtend™
Antenna Type	Chip Antenna (PCB mounted component)
Part Number	FR05-S1-N-0-102
Antenna Gain (Average)	1.7 dBi
Temperature	-40°C to +85°C
Dimensions (L x W x H)	7.0 mm x 3.0 mm x 2.0 mm

**1.3.4 Maximum Conducted Output Power**

Frequency Range (MHz)	Average Output Power (dBm)	Output Power (mW)
2407-2480	-4.84	0.33

## 1.4 EUT TEST CONFIGURATION

### 1.4.1 Test Configuration Description

Test Configuration	Description
A	Conducted antenna port configuration. EUT was set on continuous transmission @ 100% duty cycle modulated in low, mid and high channels for evaluation via temporary antenna port provided by manufacturer.
B	Radiated emissions test configuration. EUT transmitting through the integral antenna. The EUT was connected to an external supported AC-DC(USB) power adapter and set on continuous transmission @ 100% duty cycle modulated in low, mid or high channel for evaluation.

### 1.4.2 EUT Exercise Software

No special software used during evaluation. A firmware “p3 repeater pb radio test Rev.3” was loaded to the EUT which enable to change channels in Low, Mid and High @ 100% duty cycle (modulated) as well as normal operation and receive modes.

### 1.4.3 Support Equipment and I/O cables

Manufacturer	Equipment/Cable	Description
Seacomp (HDP)	Support AC-DC (USB) Power Adapter	Provided output power 5VDC for USB connection, model: HDP-QB05010U

### 1.4.4 Worst Case Configuration

For radiated measurements X, Y and Z orientations were verified. Verification performed using X orientation as worst case scenario.

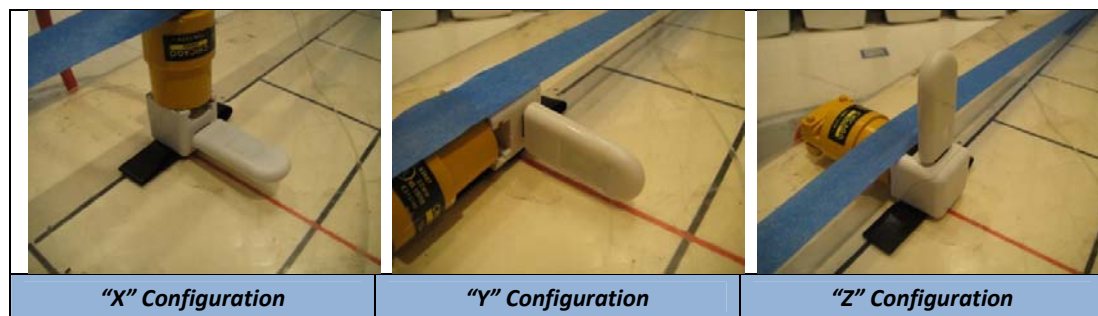

Worst case channel used is Mid Channel (Channel 2440 MHz). This is based from Output Power test results under Section 2.1 of this test report.

### 1.4.5 Simplified Test Configuration Diagram

#### Radiated Emission Test Configuration

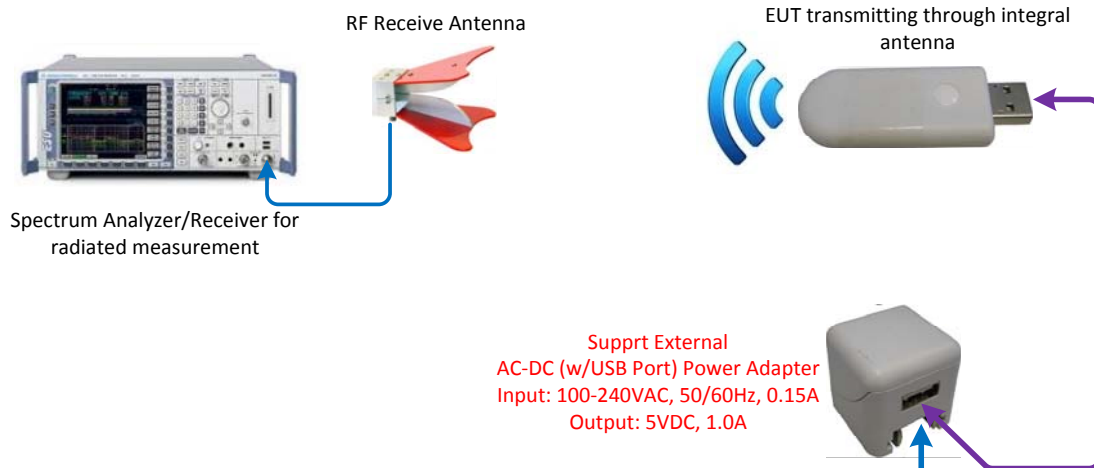

#### Conducted (Antenna Port) Test Configuration



**Not To Scale – Illustration Purpose Only**  
Objects may not represent actual image of original equipment/s or set-up.



**1.5 DEVIATIONS FROM THE STANDARD**

No deviations from the applicable test standards or test plan were made during testing.

**1.6 MODIFICATION RECORD**

Description of Modification	Modification Fitted By	Date Modification Fitted
Serial Number: N/A		
N/A	-	-

The table above details modifications made to the EUT during the test programme. The modifications incorporated during each test (if relevant) are recorded on the appropriate test pages.

**1.7 TEST METHODOLOGY**

All measurements contained in this report were conducted with ANSI C63.4-2009, American National Standard for Methods of Measurement of Radio-Noise Emissions from Low-Voltage Electrical and Electronic Equipment in the range of 9 kHz to 40 GHz.

For conducted and radiated emissions the equipment under test (EUT) was configured to measure its highest possible emission level. This level was based on the maximized cable configuration from exploratory testing per ANSI C63.4-2009. The test modes were adapted according to the Operating Instructions provided by the manufacturer/client.

**1.8 TEST FACILITY LOCATION**

**1.8.1 TÜV SÜD America Inc. (Mira Mesa)**

10040 Mesa Rim Road, San Diego, CA 92121-2912 (32.901268,-117.177681). Phone: 858 678 1400 FAX: 858-546 0364

**1.8.2 TÜV SÜD America Inc. (Rancho Bernardo)**

Sony Electronics Inc., Building #8 16530 Via Esprillo, San Diego, CA 92127-1708 (33.018644,-117.092409). Phone: 858 942 5542 FAX: 858-546 0364

**1.9 TEST FACILITY REGISTRATION**

**1.9.1 FCC – Registration No.: US1146**

TUV SUD America Inc. (San Diego), is an accredited test facility with the site description report on file and has met all the requirements specified in §2.948 of the FCC rules. The acceptance letter from the FCC is maintained in our files and the Registration is US1146.



**1.9.2 Industry Canada (IC) Registration No.: 3067A**

The 10m Semi-anechoic chamber of TÜV SÜD America Inc. (San Diego) has been registered by Certification and Engineering Bureau of Industry Canada for radio equipment testing with Registration No. 3067A.



## **SECTION 2**

### **TEST DETAILS**

Radio Testing of the  
SMK Electronics Corp.  
2.4GHz USB Repeater



## **2.1 PEAK OUTPUT POWER**

### **2.1.1 Specification Reference**

Part 15 Subpart C §15.247(b)(3) and RSS-210 A8.4(4)

### **2.1.2 Standard Applicable**

(3) For systems using digital modulation in the 902–928 MHz, 2400–2483.5 MHz, and 5725–5850 MHz bands: 1 Watt. As an alternative to a peak power measurement, compliance with the one Watt limit can be based on a measurement of the maximum conducted output power. Maximum Conducted Output Power is defined as the total transmit power delivered to all antennas and antenna elements averaged across all symbols in the signaling alphabet when the transmitter is operating at its maximum power control level. Power must be summed across all antennas and antenna elements. The average must not include any time intervals during which the transmitter is off or is transmitting at a reduced power level. If multiple modes of operation are possible (e.g., alternative modulation methods), the maximum conducted output power is the highest total transmit power occurring in any mode.

### **2.1.3 Equipment Under Test and Modification State**

Serial No: PCB board sample / Test Configuration A

### **2.1.4 Date of Test/Initial of test personnel who performed the test**

April 13, 2015 / AC

### **2.1.5 Test Equipment Used**

The major items of test equipment used for the above tests are identified in Section 3.1.

### **2.1.6 Environmental Conditions**

Test performed at TÜV SÜD America Inc. Rancho Bernardo facility

Ambient Temperature	23.0°C
Relative Humidity	43.0%
ATM Pressure	101.4 kPa

### **2.1.7 Additional Observations**

- This is a conducted test (Maximum conducted [average] output power) using direct connection to a spectrum analyzer.
- The “Channel Power ACLR” function of spectrum analyzer was used for this test.
- An offset 21.3dB was used to compensate for the external attenuator and cable used.
- Both Peak and Average measurements were recorded.



**2.1.8 Test Results**

Channel (MHz)	Modulation	Measured Average Power (dBm)	Measured Peak Power (dBm)
2407	GFSK @ 2Mbps	-5.14	-3.67
2440		-4.84	-2.95
2480		-5.22	-3.75

**2.1.9 Sample Test Display**

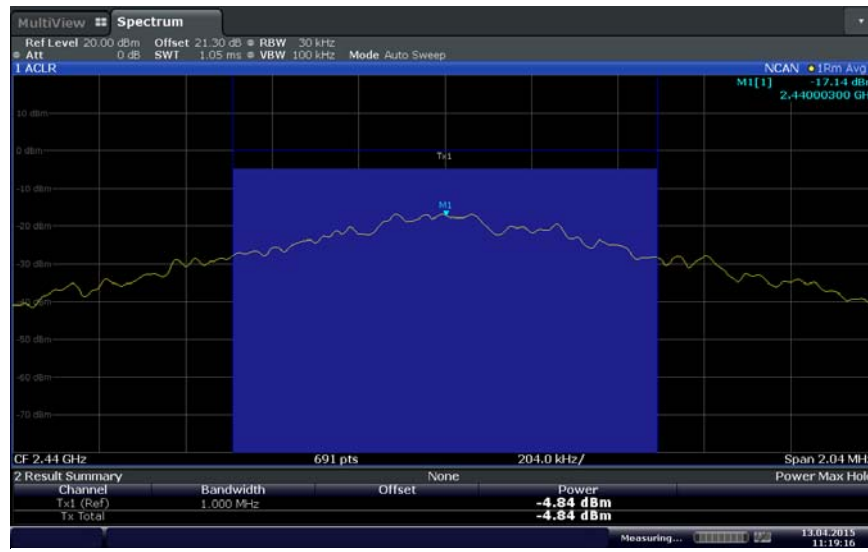

Date: 13 APR 2015 11:19:16

**Mid Channel (2440 MHz)**





## **2.2 99% EMISSION BANDWIDTH**

### **2.2.1 Specification Reference**

RSS-Gen 6.6

### **2.2.2 Standard Applicable**

The emission bandwidth (x dB) is defined as the frequency range between two points, one above and one below the carrier frequency, at which the spectral density of the emission is attenuated x dB below the maximum in-band spectral density of the modulated signal. Spectral density (power per unit bandwidth) is to be measured with a detector of resolution bandwidth in the range of 1% to 5% of the anticipated emission bandwidth, and a video bandwidth at least 3x the resolution bandwidth.

When the occupied bandwidth limit is not stated in the applicable RSS or reference measurement method, the transmitted signal bandwidth shall be reported as the 99% emission bandwidth, as calculated or measured.

- The transmitter shall be operated at its maximum carrier power measured under normal test conditions.
- • The span of the analyzer shall be set to capture all products of the modulation process, including the emission skirts.
- • The resolution bandwidth (RBW) shall be in the range of 1% to 5% of the occupied bandwidth (OBW) and video bandwidth (VBW) shall be approximately 3x RBW.

Note: Video averaging is not permitted.

A peak, or peak hold, may be used in place of the sampling detector as this may produce a wider bandwidth than the actual bandwidth (worst-case measurement). Use of a peak hold may be necessary to determine the occupied bandwidth if the device is not transmitting continuously.

The trace data points are recovered and are directly summed in linear power level terms. The recovered amplitude data points, beginning at the lowest frequency, are placed in a running sum until 0.5% of the total is reached and that frequency recorded. The process is repeated for the highest frequency data points (starting at the highest frequency, at the right side of the span, and going down in frequency). This frequency is then recorded.

The difference between the two recorded frequencies is the 99% occupied bandwidth.

### **2.2.3 Equipment Under Test and Modification State**

Serial No: PCB board sample / Test Configuration A

### **2.2.4 Date of Test/Initial of test personnel who performed the test**

April 13, 2015 / AC

### **2.2.5 Test Equipment Used**

The major items of test equipment used for the above tests are identified in Section 3.1.



**2.2.6 Environmental Conditions/ Test Location**

Test performed at TÜV SÜD America Inc. Rancho Bernardo facility

Ambient Temperature 23.0°C  
 Relative Humidity 43.0%  
 ATM Pressure 101.4 kPa

**2.2.7 Additional Observations**

- This is a conducted test.
- An offset 21.3dB was used to compensate for the external attenuator and cable used.
- Span is wide enough to capture the channel transmission.
- RBW is 1% of the span.
- VBW is 3X RBW.
- Sweep is auto.
- Detector is peak.
- The % Power Bandwidth setting in the spectrum analyzer was set to 99% (default).

**2.2.8 Test Results**

Channel (MHz)	Measured 99% Bandwidth (MHz)
2407	1.818
2440	1.768
2480	1.838

**2.2.9 Test Results Plots**



Date: 13 APR 2015 09:32:59

**Low Channel (2407 MHz)**

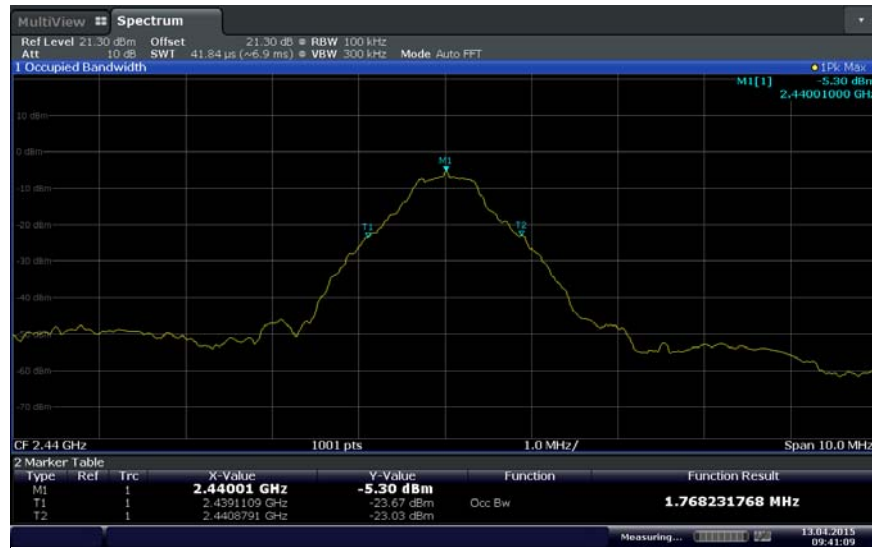

Date: 13 APR 2015 09:41:10

Mid Channel (2440 MHz)

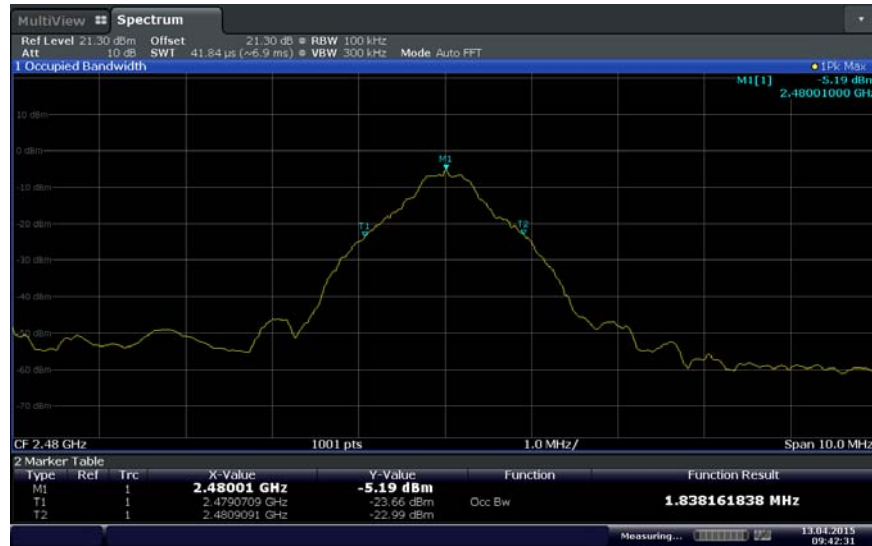

Date: 13 APR 2015 09:42:31

High Channel (2480 MHz)



## **2.3 MINIMUM 6 dB RF BANDWIDTH**

### **2.3.1 Specification Reference**

Part 15 Subpart C §15.247(a)(2) and RSS-210 A8.2(a)

### **2.3.2 Standard Applicable**

(2) Systems using digital modulation techniques may operate in the 902–928 MHz, 2400–2483.5 MHz, and 5725–5850 MHz bands. The minimum 6 dB bandwidth shall be at least 500 kHz.

### **2.3.3 Equipment Under Test and Modification State**

Serial No: PCB board sample / Test Configuration A

### **2.3.4 Date of Test/Initial of test personnel who performed the test**

April 13, 2015 / AC

### **2.3.5 Test Equipment Used**

The major items of test equipment used for the above tests are identified in Section 3.1.

### **2.3.6 Environmental Conditions/ Test Location**

Test performed at TÜV SÜD America Inc. Rancho Bernardo facility

Ambient Temperature	23.0°C
Relative Humidity	43.0%
ATM Pressure	101.4 kPa

### **2.3.7 Additional Observations**

- This is a conducted test.
- An offset 21.3dB was used to compensate for the external attenuator and cable used.
- Span is wide enough to capture the channel transmission.
- RBW is set to either 100 kHz or 1% of the span.
- VBW is  $\geq 3X$  RBW.
- Sweep is auto.
- Detector is peak.
- The “n” dB down marker function of the spectrum analyzer was used for this test.



### 2.3.8 Test Results

Channel (MHz)	Measured Bandwidth (MHz)	Minimum Bandwidth (MHz)	Compliance
2407	0.769	0.500	Complies
2440	0.859	0.500	Complies
2480	0.779	0.500	Complies

### 2.3.9 Test Results Plots

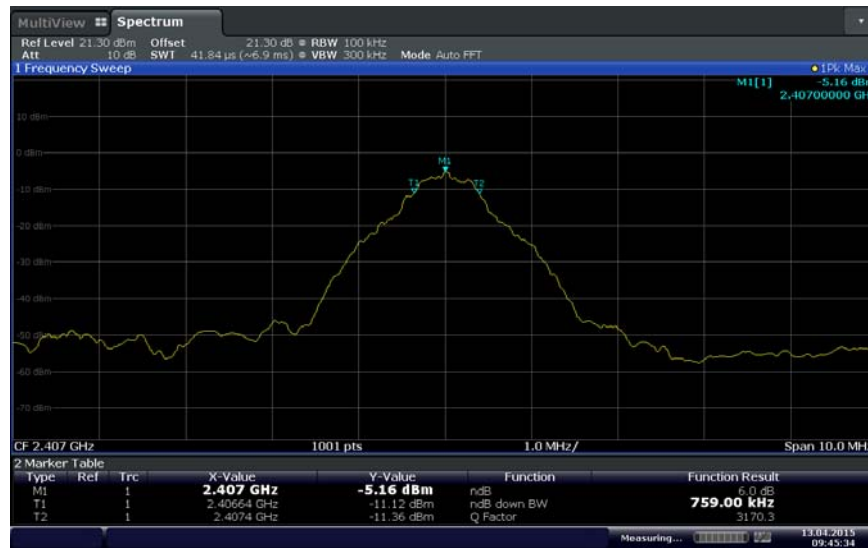

Low Channel (2407 MHz)



Date: 13 APR 2015 09:46:58

Mid Channel (2440 MHz)



Date: 13 APR 2015 09:48:13

High Channel (2480 MHz)



## **2.4 OUT-OF-BAND EMISSIONS - CONDUCTED**

### **2.4.1 Specification Reference**

Part 15 Subpart C §15.247(d) and RSS-210 A8.5

### **2.4.2 Standard Applicable**

(d) In any 100 kHz bandwidth outside the frequency band in which the spread spectrum or digitally modulated intentional radiator is operating, the radio frequency power that is produced by the intentional radiator shall be at least 20 dB below that in the 100 kHz bandwidth within the band that contains the highest level of the desired power, based on either an RF conducted or a radiated measurement, provided the transmitter demonstrates compliance with the peak conducted power limits. If the transmitter complies with the conducted power limits based on the use of RMS averaging over a time interval, as permitted under paragraph (b)(3) of this section, the attenuation required under this paragraph shall be 30 dB instead of 20 dB. Attenuation below the general limits specified in §15.209(a) is not required. In addition, radiated emissions which fall in the restricted bands, as defined in §15.205(a), must also comply with the radiated emission limits specified in §15.209(a) (see §15.205(c)).

### **2.4.3 Equipment Under Test and Modification State**

Serial No: PCB board sample / Test Configuration A

### **2.4.4 Date of Test/Initial of test personnel who performed the test**

April 13, 2015 / AC

### **2.4.5 Test Equipment Used**

The major items of test equipment used for the above tests are identified in Section 3.1.

### **2.4.6 Environmental Conditions/ Test Location**

Test performed at TÜV SÜD America Inc. Rancho Bernardo facility

Ambient Temperature	23.0 °C
Relative Humidity	43.0 %
ATM Pressure	101.4 kPa

### **2.4.7 Additional Observations**

- This is a conducted test.
- An offset 21.3dB was used to compensate for the external cable used.
- RBW is 100kHz.VBW is 3X RBW.
- Sweep is auto. Detector is peak. Trace is max hold.
- Initial scan was performed to determine the highest level of the desired power within the band. Limit (display line) was drawn 30dB below this level.
- Spectrum was searched from 9 kHz up to 26.5GHz.



2.4.8 Test Results Plots

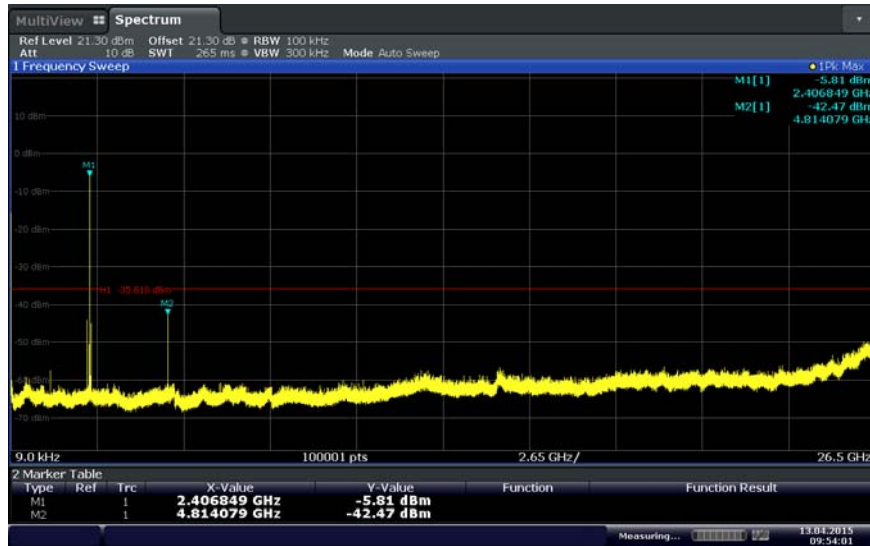

Low Channel (2407 MHz)

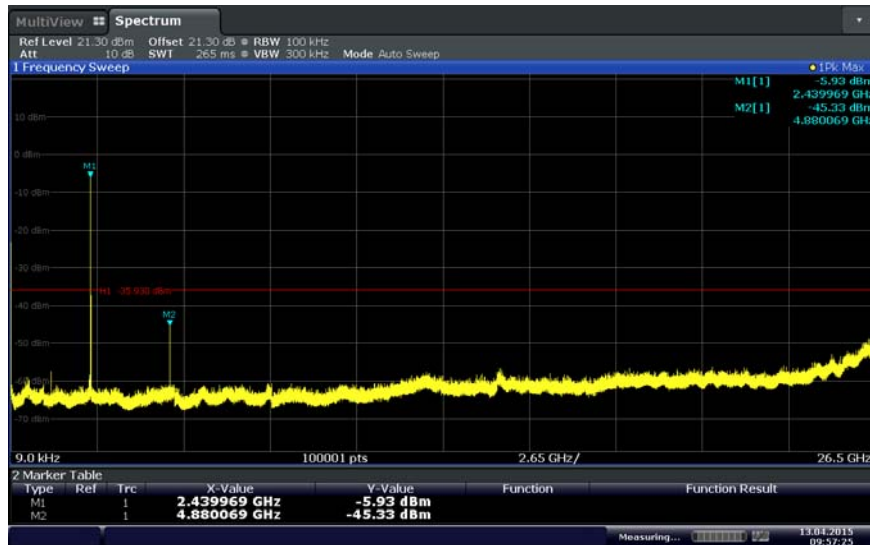

Mid Channel (2440 MHz)



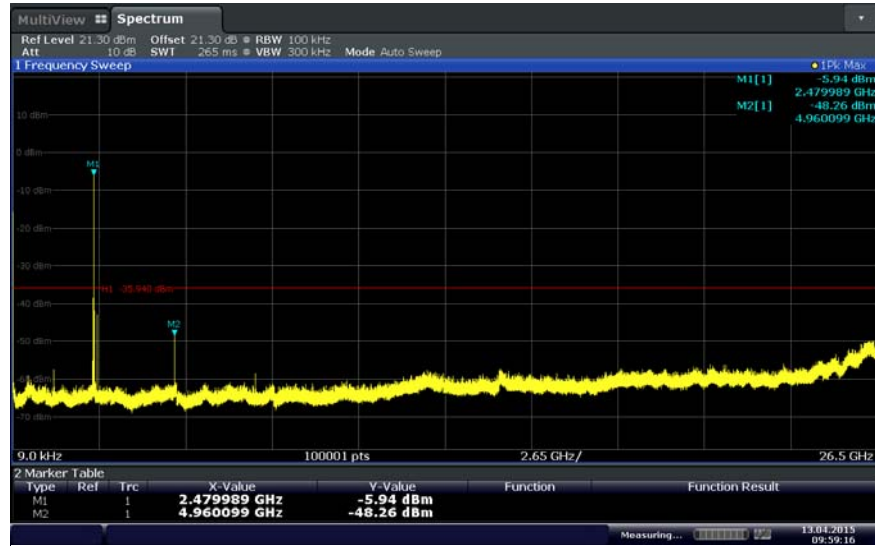

Date: 13 APR 2015 09:59:17

### High Channel (2480 MHz)



## **2.5 BAND-EDGE COMPLIANCE OF RF CONDUCTED EMISSIONS**

### **2.5.1 Specification Reference**

Part 15 Subpart C §15.247(d) and RSS-210 A8.5

### **2.5.2 Standard Applicable**

(d) In any 100 kHz bandwidth outside the frequency band in which the spread spectrum or digitally modulated intentional radiator is operating, the radio frequency power that is produced by the intentional radiator shall be at least 20 dB below that in the 100 kHz bandwidth within the band that contains the highest level of the desired power, based on either an RF conducted or a radiated measurement, provided the transmitter demonstrates compliance with the peak conducted power limits. If the transmitter complies with the conducted power limits based on the use of RMS averaging over a time interval, as permitted under paragraph (b)(3) of this section, the attenuation required under this paragraph shall be 30 dB instead of 20 dB. Attenuation below the general limits specified in §15.209(a) is not required. In addition, radiated emissions which fall in the restricted bands, as defined in §15.205(a), must also comply with the radiated emission limits specified in §15.209(a) (see §15.205(c)).

### **2.5.3 Equipment Under Test and Modification State**

Serial No: PCB board sample / Test Configuration A

### **2.5.4 Date of Test/Initial of test personnel who performed the test**

April 13, 2015 / AC

### **2.5.5 Test Equipment Used**

The major items of test equipment used for the above tests are identified in Section 3.1.

### **2.5.6 Environmental Conditions/ Test Location**

Test performed at TÜV SÜD America Inc. Rancho Bernardo facility

Ambient Temperature	23.0 °C
Relative Humidity	43.0 %
ATM Pressure	101.4 kPa

### **2.5.7 Additional Observations**

- This is a conducted test.
- An offset 21.3dB was used to compensate for the external cable used.
- RBW is 100kHz.VBW is 3X RBW.
- Sweep is auto. Detector is peak. Trace is max hold.
- Trace was centred on the band-edge frequency.
- Span was set to encompass the band-edge frequency and the peak of the emission.
- Using Marker function, peak of the emission was determined and the delta to the band-edge frequency measured.



**2.5.8 Test Results**

Complies. See attached plots.



Date:13 APR.2015 10:03:22

**Low Channel (2407 MHz)**

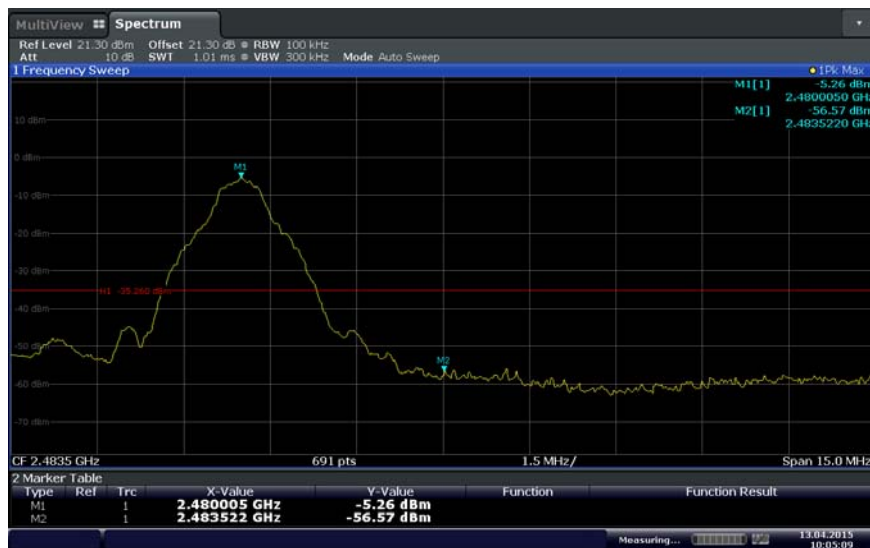

Date:13 APR.2015 10:05:09

**High Channel (2480 MHz)**



## **2.6 SPURIOUS RADIATED EMISSIONS**

### **2.6.1 Specification Reference**

Part 15 Subpart C §15.247(d) and RSS-210 A8.5

### **2.6.2 Standard Applicable**

(d) In any 100 kHz bandwidth outside the frequency band in which the spread spectrum or digitally modulated intentional radiator is operating, the radio frequency power that is produced by the intentional radiator shall be at least 20 dB below that in the 100 kHz bandwidth within the band that contains the highest level of the desired power, based on either an RF conducted or a radiated measurement, provided the transmitter demonstrates compliance with the peak conducted power limits. If the transmitter complies with the conducted power limits based on the use of RMS averaging over a time interval, as permitted under paragraph (b)(3) of this section, the attenuation required under this paragraph shall be 30 dB instead of 20 dB. Attenuation below the general limits specified in §15.209(a) is not required. In addition, radiated emissions which fall in the restricted bands, as defined in §15.205(a), must also comply with the radiated emission limits specified in §15.209(a) (see §15.205(c)).

### **2.6.3 Equipment Under Test and Modification State**

Serial No: Proto type simple / Test Configuration B

### **2.6.4 Date of Test/Initial of test personnel who performed the test**

April 14, 2015 / AC

### **2.6.5 Test Equipment Used**

The major items of test equipment used for the above tests are identified in Section 3.1.

### **2.6.6 Environmental Conditions**

Test performed at TÜV SÜD America Inc. Rancho Bernardo facility

Ambient Temperature	23.7°C
Relative Humidity	45.2%
ATM Pressure	99.9 kPa

### **2.6.7 Additional Observations**

- This is a radiated test. The spectrum was searched from 30MHz to the 10<sup>th</sup> harmonic.
- There are no emissions found that do not comply to the restricted bands defined in FCC Part 15 Subpart C, 15.205 or Part 15.247(d).
- Only the considered worst case configuration Mid channel presented for radiated emissions below 1GHz. There are no significant differences in emissions between all modes below 1GHz.
- Only noise floor measurements observed above 18GHz.



- Measurement was done using EMC32 automated software. Reported level is the actual level with all the correction factors factored in. Correction Factor column is for informational purposes only. See Section 2.6.8 for sample computation.

**2.6.8 Sample Computation (Radiated Emission)**

Measuring equipment raw measurement (dB $\mu$ V) @ 30 MHz		24.4
Correction Factor (dB)	Asset# 1066 (cable)	0.3
	Asset# 1172 (cable)	0.3
	Asset# 1016 (preamplifier)	-30.7
	Asset# 1175(cable)	0.3
	Asset# 1002 (antenna)	17.2
<b>Reported Quasi-Peak Final Measurement (dB<math>\mu</math>V/m) @ 30MHz</b>		<b>11.8</b>

**2.6.9 Test Results**

See attached plots.



**2.6.10 Test Results Below 1GHz**

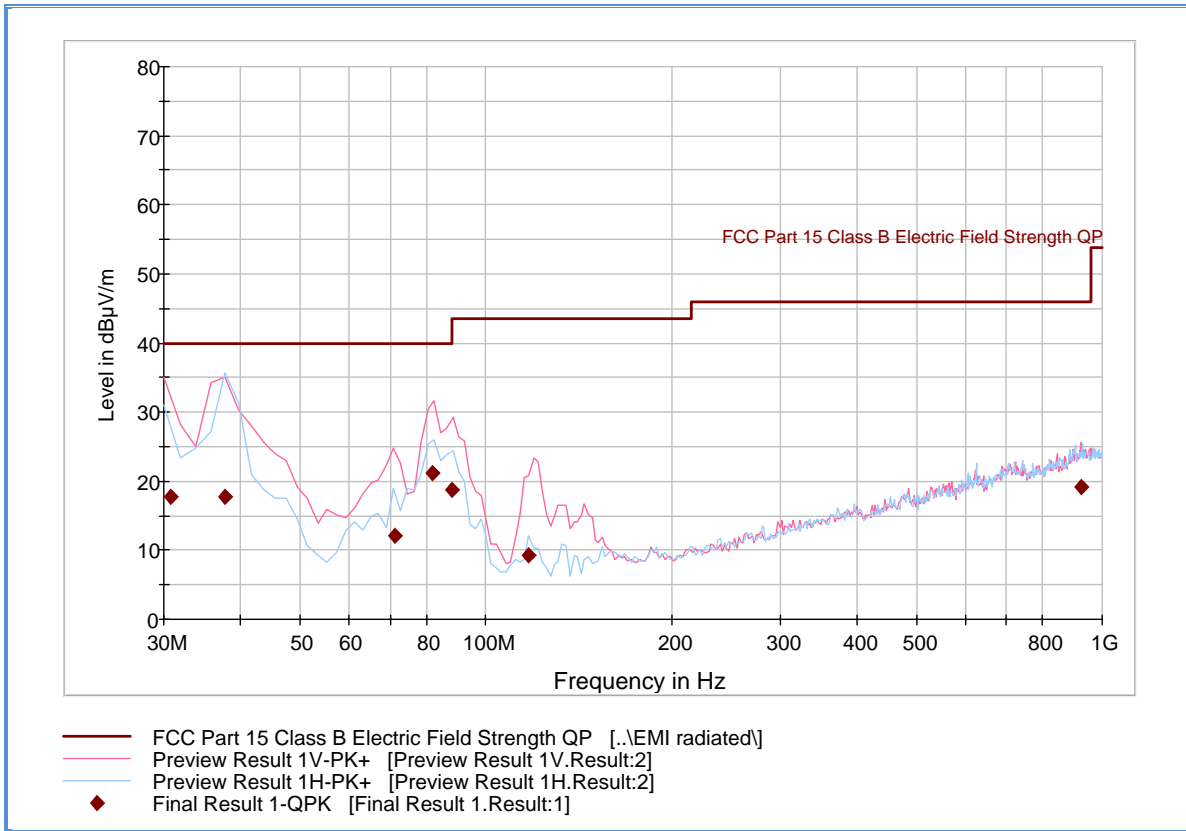

**Quasi Peak Data**

Frequency (MHz)	QuasiPeak (dBµV/m)	Meas. Time (ms)	Bandwidth (kHz)	Height (cm)	Polarization	Azimuth (deg)	Corr. (dB)	Margin (dB)	Limit (dBµV/m)
30.840000	17.8	1000.0	120.000	100.0	V	18.0	-11.9	22.2	40.0
37.735551	17.7	1000.0	120.000	250.0	H	11.0	-15.6	22.3	40.0
71.021643	12.1	1000.0	120.000	200.0	V	342.0	-22.4	27.9	40.0
82.004970	21.1	1000.0	120.000	100.0	V	-11.0	-21.9	18.9	40.0
88.236633	18.7	1000.0	120.000	100.0	V	-10.0	-21.2	24.8	43.5
117.218838	9.2	1000.0	120.000	106.0	V	18.0	-20.2	34.3	43.5
922.908377	19.1	1000.0	120.000	208.0	V	201.0	1.4	26.9	46.0

**Test Notes:** Only worst case channel (Mid channel 2440 MHz) presented for spurious emissions below 1GHz.



**2.6.11 Test Results Above 1GHz (Low Channel – 2407 MHz)**

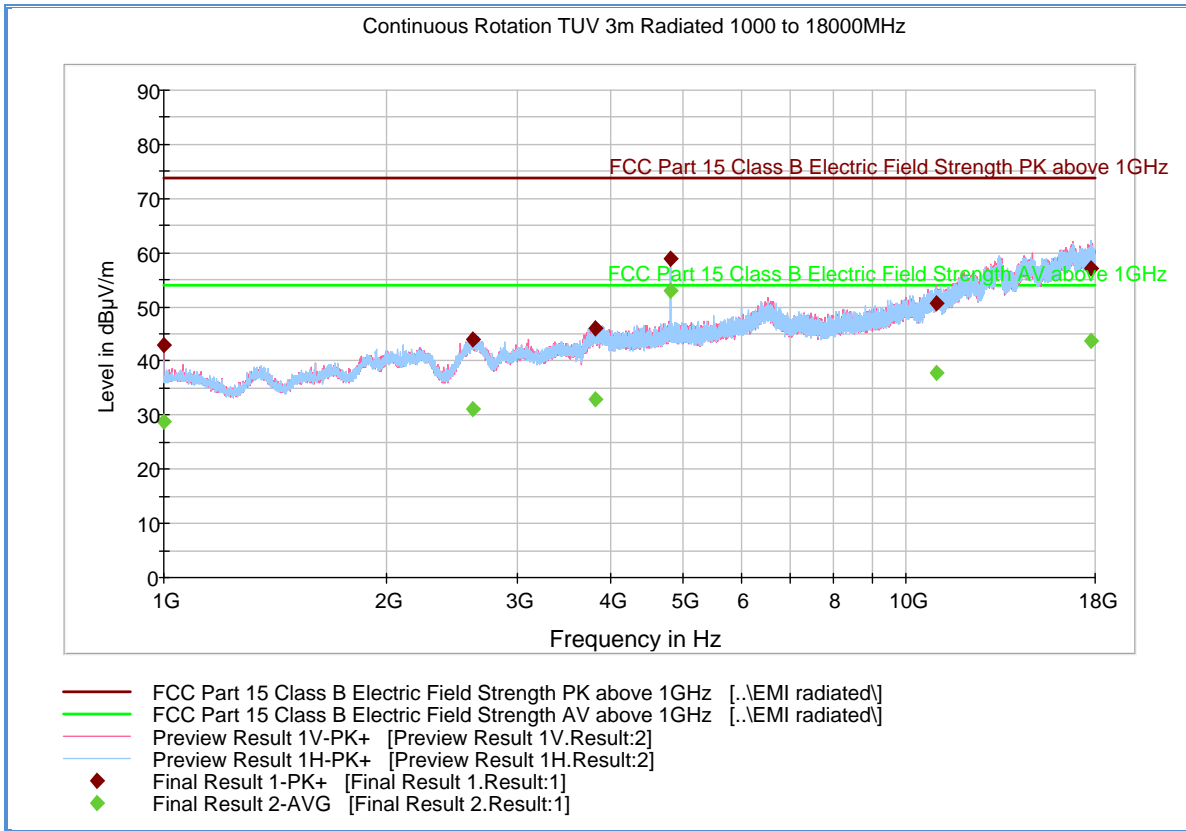

**Peak Data**

Frequency (MHz)	MaxPeak (dBµV/m)	Meas. Time (ms)	Bandwidth (kHz)	Height (cm)	Polarization	Azimuth (deg)	Corr. (dB)	Margin (dB)	Limit (dBµV/m)
1000.000000	42.9	1000.0	1000.000	215.5	V	8.0	-7.4	31.0	73.9
2607.433333	44.0	1000.0	1000.000	103.7	H	144.0	0.0	29.9	73.9
3819.166667	46.1	1000.0	1000.000	178.6	V	20.0	4.9	27.8	73.9
4814.033333	59.0	1000.0	1000.000	103.7	V	181.0	5.6	14.9	73.9
11017.400000	50.6	1000.0	1000.000	322.2	V	92.0	14.8	23.3	73.9
17766.333333	57.1	1000.0	1000.000	202.5	H	35.0	23.2	16.8	73.9

**Average Data**

Frequency (MHz)	Average (dBµV/m)	Meas. Time (ms)	Bandwidth (kHz)	Height (cm)	Polarization	Azimuth (deg)	Corr. (dB)	Margin (dB)	Limit (dBµV/m)
1000.000000	28.8	1000.0	1000.000	215.5	V	8.0	-7.4	25.1	53.9
2607.433333	31.0	1000.0	1000.000	103.7	H	144.0	0.0	22.9	53.9
3819.166667	33.0	1000.0	1000.000	178.6	V	20.0	4.9	20.9	53.9
4814.033333	53.1	1000.0	1000.000	103.7	V	181.0	5.6	0.8	53.9
11017.400000	37.8	1000.0	1000.000	322.2	V	92.0	14.8	16.1	53.9
17766.333333	43.8	1000.0	1000.000	202.5	H	35.0	23.2	10.1	53.9

**Test Notes:** Measurement was performed with a 2.4GHz notch filter. No significant emissions observed above 5GHz. Measurements above 5GHz were noise floor figures.



**2.6.12 Test Results Above 1GHz (Mid Channel – 2440 MHz)**

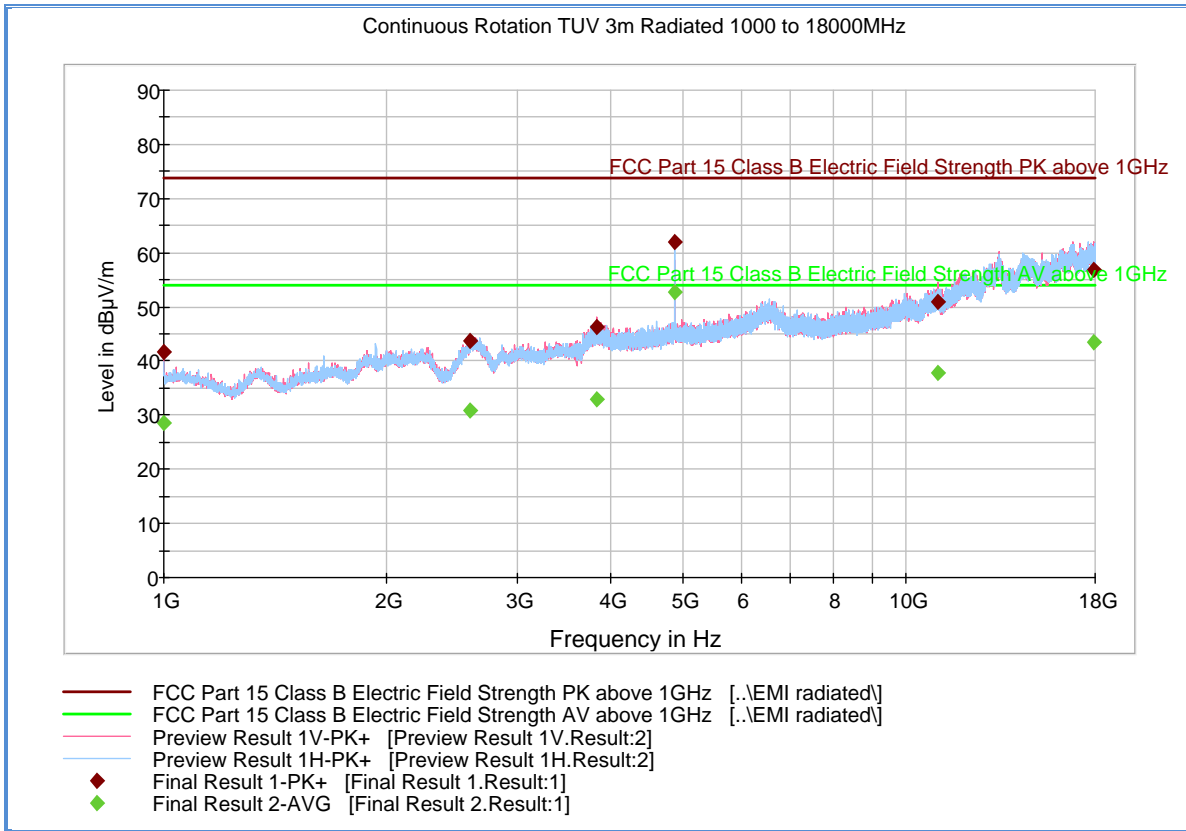

**Peak Data**

Frequency (MHz)	MaxPeak (dBµV/m)	Meas. Time (ms)	Bandwidth (kHz)	Height (cm)	Polarization	Azimuth (deg)	Corr. (dB)	Margin (dB)	Limit (dBµV/m)
1000.000000	41.7	1000.0	1000.000	276.3	V	10.0	-7.4	32.2	73.9
2591.766667	43.8	1000.0	1000.000	355.1	V	119.0	0.0	30.1	73.9
3835.266667	46.2	1000.0	1000.000	169.6	V	127.0	4.9	27.7	73.9
4879.200000	62.1	1000.0	1000.000	356.1	H	70.0	6.1	11.8	73.9
11029.666667	50.9	1000.0	1000.000	99.7	V	49.0	14.8	23.0	73.9
17906.333333	56.8	1000.0	1000.000	247.3	V	324.0	23.0	17.1	73.9

**Average Data**

Frequency (MHz)	Average (dBµV/m)	Meas. Time (ms)	Bandwidth (kHz)	Height (cm)	Polarization	Azimuth (deg)	Corr. (dB)	Margin (dB)	Limit (dBµV/m)
1000.000000	28.6	1000.0	1000.000	276.3	V	10.0	-7.4	25.3	53.9
2591.766667	30.8	1000.0	1000.000	355.1	V	119.0	0.0	23.1	53.9
3835.266667	33.0	1000.0	1000.000	169.6	V	127.0	4.9	20.9	53.9
4879.200000	52.8	1000.0	1000.000	356.1	H	70.0	6.1	1.1	53.9
11029.666667	37.9	1000.0	1000.000	99.7	V	49.0	14.8	16.0	53.9
17906.333333	43.5	1000.0	1000.000	247.3	V	324.0	23.0	10.4	53.9

**Test Notes:** Measurement was performed with a 2.4GHz notch filter. No significant emissions observed above 5GHz. Measurements above 5GHz were noise floor figures.





**2.6.13 Test Results Above 1GHz (High Channel – 2480 MHz)**

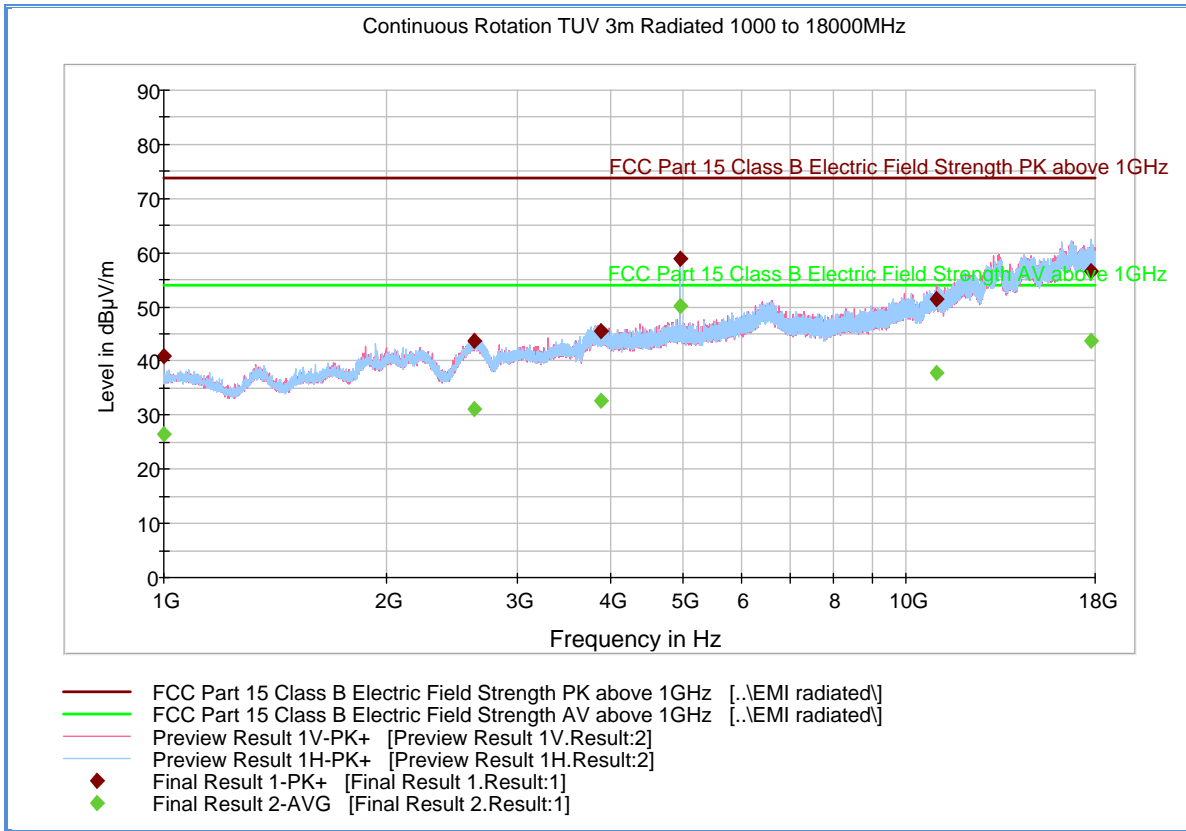

**Peak Data**

Frequency (MHz)	MaxPeak (dBµV/m)	Meas. Time (ms)	Bandwidth (kHz)	Height (cm)	Polarization	Azimuth (deg)	Corr. (dB)	Margin (dB)	Limit (dBµV/m)
1000.400000	40.8	1000.0	1000.000	147.7	V	291.0	-7.4	33.1	73.9
2620.900000	43.7	1000.0	1000.000	202.3	V	41.0	0.0	30.2	73.9
3887.366667	45.4	1000.0	1000.000	378.1	V	66.0	5.0	28.5	73.9
4960.633333	58.8	1000.0	1000.000	345.1	H	62.0	6.3	15.1	73.9
10988.066667	51.4	1000.0	1000.000	344.1	V	244.0	14.9	22.5	73.9
17755.766667	56.5	1000.0	1000.000	116.7	H	27.0	23.2	17.4	73.9

**Average Data**

Frequency (MHz)	Average (dBµV/m)	Meas. Time (ms)	Bandwidth (kHz)	Height (cm)	Polarization	Azimuth (deg)	Corr. (dB)	Margin (dB)	Limit (dBµV/m)
1000.400000	26.5	1000.0	1000.000	147.7	V	291.0	-7.4	27.4	53.9
2620.900000	31.2	1000.0	1000.000	202.3	V	41.0	0.0	22.7	53.9
3887.366667	32.8	1000.0	1000.000	378.1	V	66.0	5.0	21.1	53.9
4960.633333	50.1	1000.0	1000.000	345.1	H	62.0	6.3	3.8	53.9
10988.066667	37.7	1000.0	1000.000	344.1	V	244.0	14.9	16.2	53.9
17755.766667	43.8	1000.0	1000.000	116.7	H	27.0	23.2	10.1	53.9

**Test Notes:** Measurement was performed with a 2.4GHz notch filter. No significant emissions observed above 5GHz. Measurements above 5GHz were noise floor figures.



## 2.7 RECEIVER SPURIOUS EMISSIONS

### 2.7.1 Specification Reference

RSS-Gen 7.1

### 2.7.2 Standard Applicable

Radiated emission measurements shall be performed with the receiver antenna connected to the receiver antenna terminals. The search for spurious emissions shall be from the lowest frequency internally generated or used in the receiver (e.g. local oscillator, intermediate or carrier frequency), or 30 MHz, whichever is higher, to at least 5x the highest tunable or local oscillator frequency, whichever is higher, without exceeding 40 GHz.

Spurious emissions from receivers shall not exceed the radiated limits show in Table below.

**Receiver Radiated Limits**

Frequency (MHz)	Field Strength ( $\mu\text{V}/\text{m}$ at 3 meters)*
30-88	100
88-216	150
216-960	200
Above 960	500

### 2.7.3 Equipment Under Test and Modification State

Serial No: Proto type simple / Test Configuration B

### 2.7.4 Date of Test/Initial of test personnel who performed the test

April 14, 2015 / AC

### 2.7.5 Test Equipment Used

The major items of test equipment used for the above tests are identified in Section 3.1.

### 2.7.6 Environmental Conditions

Test performed at TÜV SÜD America Inc. Rancho Bernardo facility

Ambient Temperature      23.7°C  
Relative Humidity          45.2%  
ATM Pressure                99.9 kPa

### 2.7.7 Additional Observations

- This is a radiated test. The spectrum was searched from 30MHz to the 10<sup>th</sup> harmonic.
- Only noise floor measurements observed above 18GHz.
- Measurement was done using EMC32 automated software. Reported level is the actual level with all the correction factors factored in. Correction Factor column is for informational purposes only. See Section 2.7.8 for sample computation.



**2.7.8 Sample Computation (Radiated Emission)**

Measuring equipment raw measurement (dB $\mu$ V) @ 30 MHz			24.4
Correction Factor (dB)	Asset# 1066 (cable)	0.3	-12.6
	Asset# 1172 (cable)	0.3	
	Asset# 1016 (preamplifier)	-30.7	
	Asset# 1175(cable)	0.3	
	Asset# 1002 (antenna)	17.2	
Reported Quasi-Peak Final Measurement (dB $\mu$ V/m) @ 30MHz			11.8

**2.7.9 Test Results**

See attached plots.



**2.7.10 Test Results Below 1GHz (Receive Mode)**

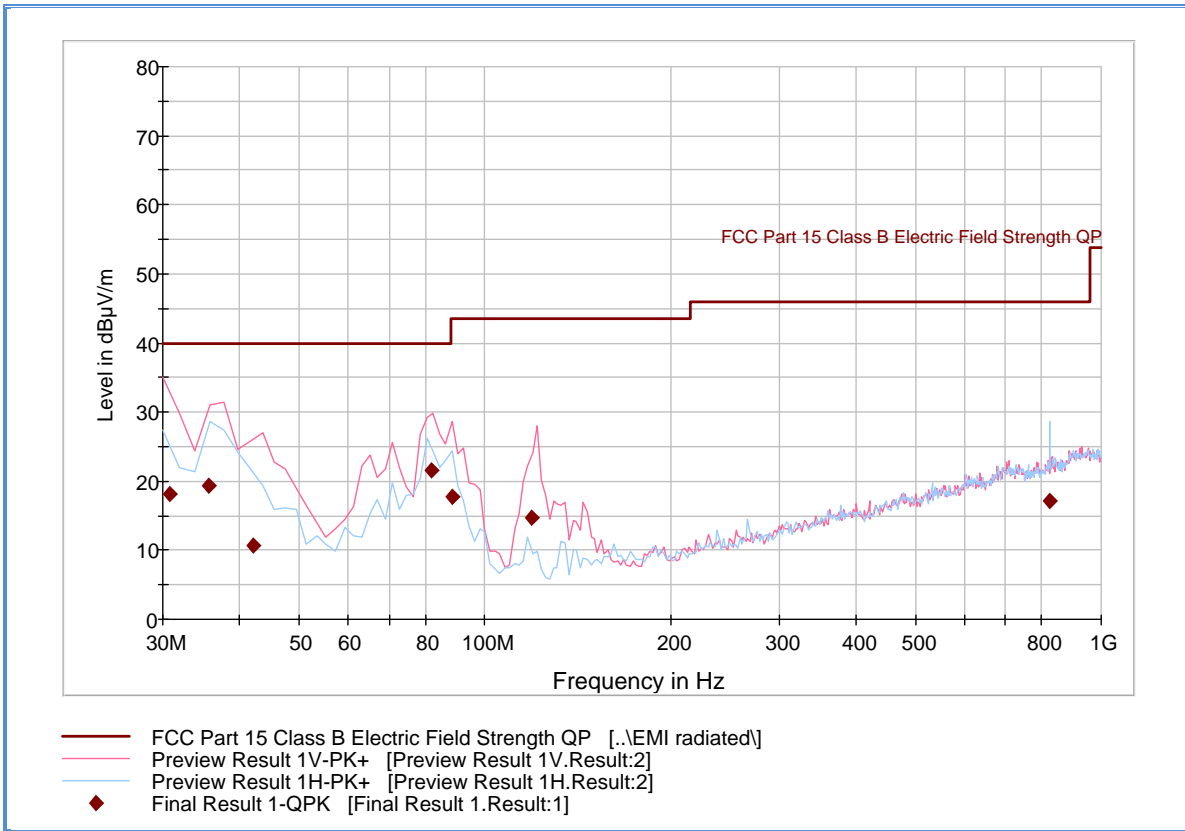

**Quasi Peak Data**

Frequency (MHz)	QuasiPeak (dBµV/m)	Meas. Time (ms)	Bandwidth (kHz)	Height (cm)	Polarization	Azimuth (deg)	Corr. (dB)	Margin (dB)	Limit (dBµV/m)
30.800000	18.1	1000.0	120.000	109.0	V	2.0	-11.9	21.9	40.0
35.695551	19.4	1000.0	120.000	255.0	V	15.0	-14.5	20.6	40.0
42.167214	10.7	1000.0	120.000	105.0	V	314.0	-17.6	29.3	40.0
81.844970	21.6	1000.0	120.000	100.0	V	-11.0	-21.9	18.4	40.0
88.636633	17.8	1000.0	120.000	100.0	V	19.0	-21.1	25.7	43.5
119.242725	14.7	1000.0	120.000	115.0	V	-11.0	-20.3	28.8	43.5
824.730100	17.2	1000.0	120.000	150.0	H	-3.0	-0.7	28.8	46.0



**2.7.11 Test Results Above 1GHz (Receive Mode)**

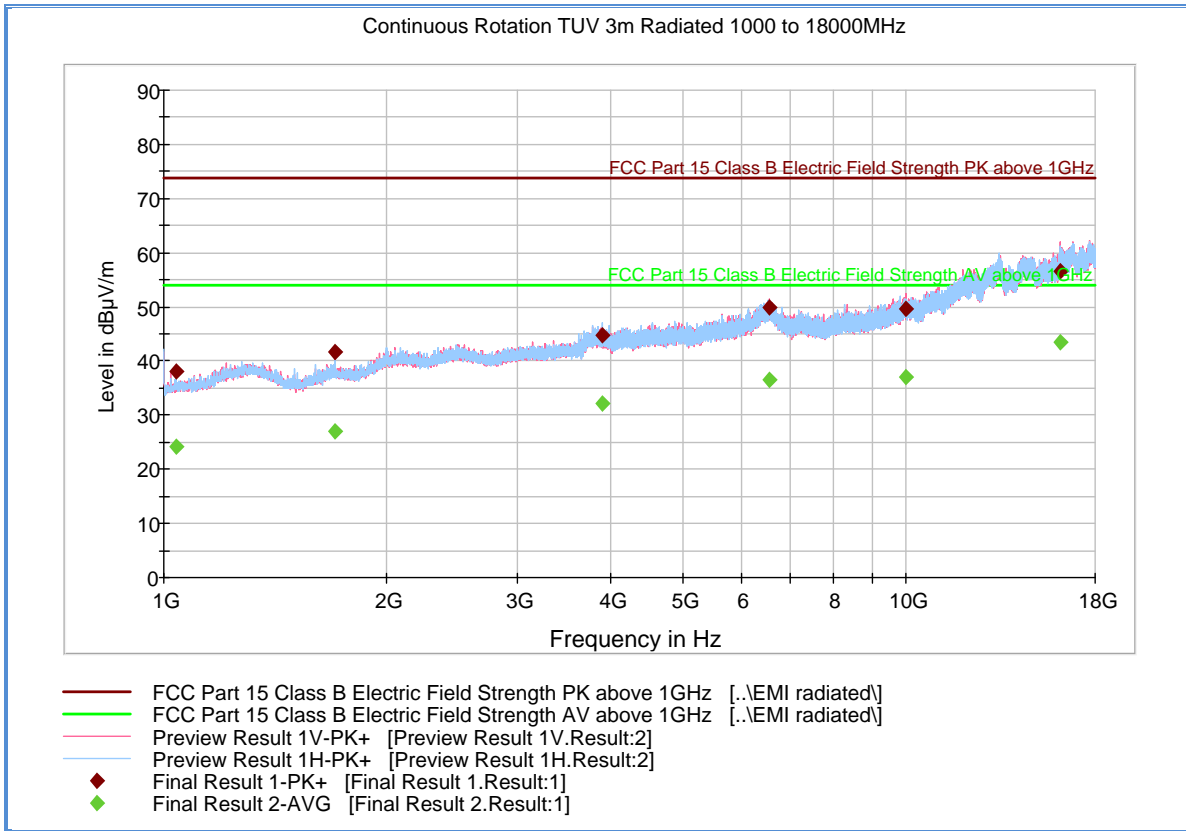

**Peak Data**

Frequency (MHz)	MaxPeak (dBµV/m)	Meas. Time (ms)	Bandwidth (kHz)	Height (cm)	Polarization	Azimuth (deg)	Corr. (dB)	Margin (dB)	Limit (dBµV/m)
1039.633333	38.0	1000.0	1000.000	182.6	H	316.0	-7.3	35.9	73.9
1699.100000	41.6	1000.0	1000.000	181.6	V	109.0	-4.3	32.3	73.9
3906.866667	44.8	1000.0	1000.000	202.5	H	231.0	5.0	29.1	73.9
6553.866667	49.8	1000.0	1000.000	345.1	V	39.0	11.3	24.1	73.9
9992.966667	49.8	1000.0	1000.000	121.7	V	288.0	12.7	24.2	73.9
16171.16666	56.7	1000.0	1000.000	289.2	V	289.0	21.9	17.2	73.9

**Average Data**

Frequency (MHz)	Average (dBµV/m)	Meas. Time (ms)	Bandwidth (kHz)	Height (cm)	Polarization	Azimuth (deg)	Corr. (dB)	Margin (dB)	Limit (dBµV/m)
1039.633333	24.2	1000.0	1000.000	182.6	H	316.0	-7.3	29.7	53.9
1699.100000	26.9	1000.0	1000.000	181.6	V	109.0	-4.3	27.0	53.9
3906.866667	32.1	1000.0	1000.000	202.5	H	231.0	5.0	21.8	53.9
6553.866667	36.5	1000.0	1000.000	345.1	V	39.0	11.3	17.4	53.9
9992.966667	36.9	1000.0	1000.000	121.7	V	288.0	12.7	17.0	53.9
16171.16666	43.3	1000.0	1000.000	289.2	V	289.0	21.9	10.6	53.9

**Test Notes:** No significant emissions observed above 1GHz.



## **2.8 RADIATED BAND EDGE MEASUREMENTS AND IMMEDIATE RESTRICTED BANDS**

### **2.8.1 Specification Reference**

Part 15 Subpart C §15.247(d) and RSS-210 A8.5

### **2.8.2 Standard Applicable**

(d) In any 100 kHz bandwidth outside the frequency band in which the spread spectrum or digitally modulated intentional radiator is operating, the radio frequency power that is produced by the intentional radiator shall be at least 20 dB below that in the 100 kHz bandwidth within the band that contains the highest level of the desired power, based on either an RF conducted or a radiated measurement, provided the transmitter demonstrates compliance with the peak conducted power limits. If the transmitter complies with the conducted power limits based on the use of RMS averaging over a time interval, as permitted under paragraph (b)(3) of this section, the attenuation required under this paragraph shall be 30 dB instead of 20 dB. Attenuation below the general limits specified in §15.209(a) is not required. In addition, radiated emissions which fall in the restricted bands, as defined in §15.205(a), must also comply with the radiated emission limits specified in §15.209(a) (see §15.205(c)).

### **2.8.3 Equipment Under Test and Modification State**

Serial No: Proto type simple / Test Configuration B

### **2.8.4 Date of Test/Initial of test personnel who performed the test**

April 14, 2015 / AC

### **2.8.5 Test Equipment Used**

The major items of test equipment used for the above tests are identified in Section 3.1.

### **2.8.6 Environmental Conditions/ Test Location**

Test performed at TÜV SÜD America Inc. Rancho Bernardo facility

Ambient Temperature	23.7°C
Relative Humidity	45.2%
ATM Pressure	99.9 kPa

### **2.8.7 Additional Observations**

- This is a radiated test. The spectrum was searched from 2310MHz to 2390MHz for lower immediate restricted band and 2483.5MHz to 2500MHz for the upper immediate restricted band.
- There are no emissions found that do not comply with the restricted bands defined in FCC Part 15 Subpart C, 15.205.
- Measurement was done using EMC32 automated software. Reported level is the actual level with all the correction factors factored in. Correction Factor column is for informational purposes only. See Section 2.8.8 for sample computation.



**2.8.8 Sample Computation (Radiated Emission)**

Measuring equipment raw measurement (dB $\mu$ V) @ 2400 MHz			53.9
Correction Factor (dB)	Asset# 1153 (cable)	3.4	-0.4
	Asset# 8628(preamplifier)	-36.5	
	Asset#7575 (antenna)	32.7	
<b>Reported Max Peak Final Measurement (dB<math>\mu</math>V/m) @ 2400 MHz</b>			<b>53.5</b>

**2.8.9 Test Results**

See attached plots.



**2.8.10 Test Results Restricted Band 2310MHz to 2390MHz (Low Channel)**

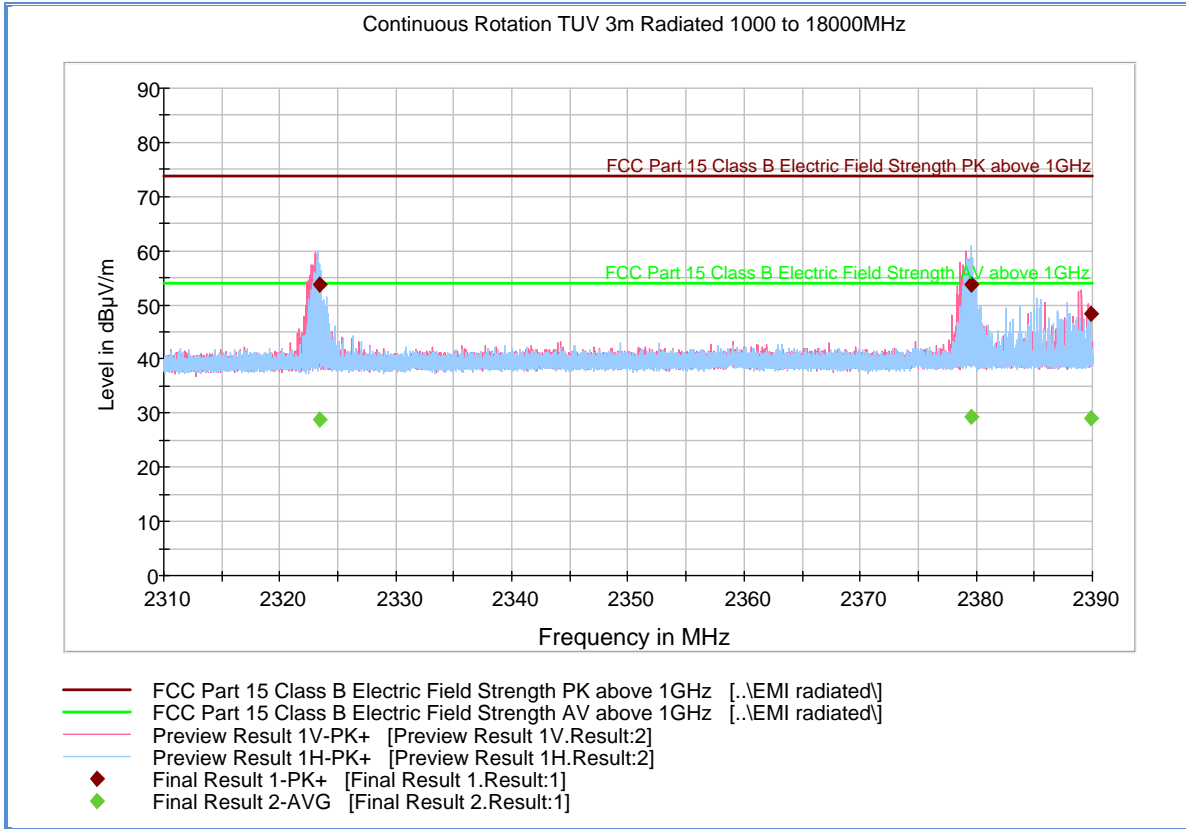

**Peak Data**

Frequency (MHz)	MaxPeak (dBµV/m)	Meas. Time (ms)	Bandwidth (kHz)	Height (cm)	Polarization	Azimuth (deg)	Corr. (dB)	Margin (dB)	Limit (dBµV/m)
2323.458667	53.6	1000.0	1000.000	103.7	V	296.0	-1.0	20.3	73.9
2379.520000	53.8	1000.0	1000.000	114.8	V	146.0	-0.7	20.1	73.9
2389.898667	48.2	1000.0	1000.000	102.8	V	144.0	-0.6	25.7	73.9

**Average Data**

Frequency (MHz)	Average (dBµV/m)	Meas. Time (ms)	Bandwidth (kHz)	Height (cm)	Polarization	Azimuth (deg)	Corr. (dB)	Margin (dB)	Limit (dBµV/m)
2323.458667	28.9	1000.0	1000.000	103.7	V	296.0	-1.0	25.0	53.9
2379.520000	29.3	1000.0	1000.000	114.8	V	146.0	-0.7	24.6	53.9
2389.898667	29.2	1000.0	1000.000	102.8	V	144.0	-0.6	24.7	53.9

**Test Notes: 2.4GHz notch filter removed for this test.**





**2.8.11 Test Results Restricted Band 2483.5MHz to 2500MHz (High Channel)**

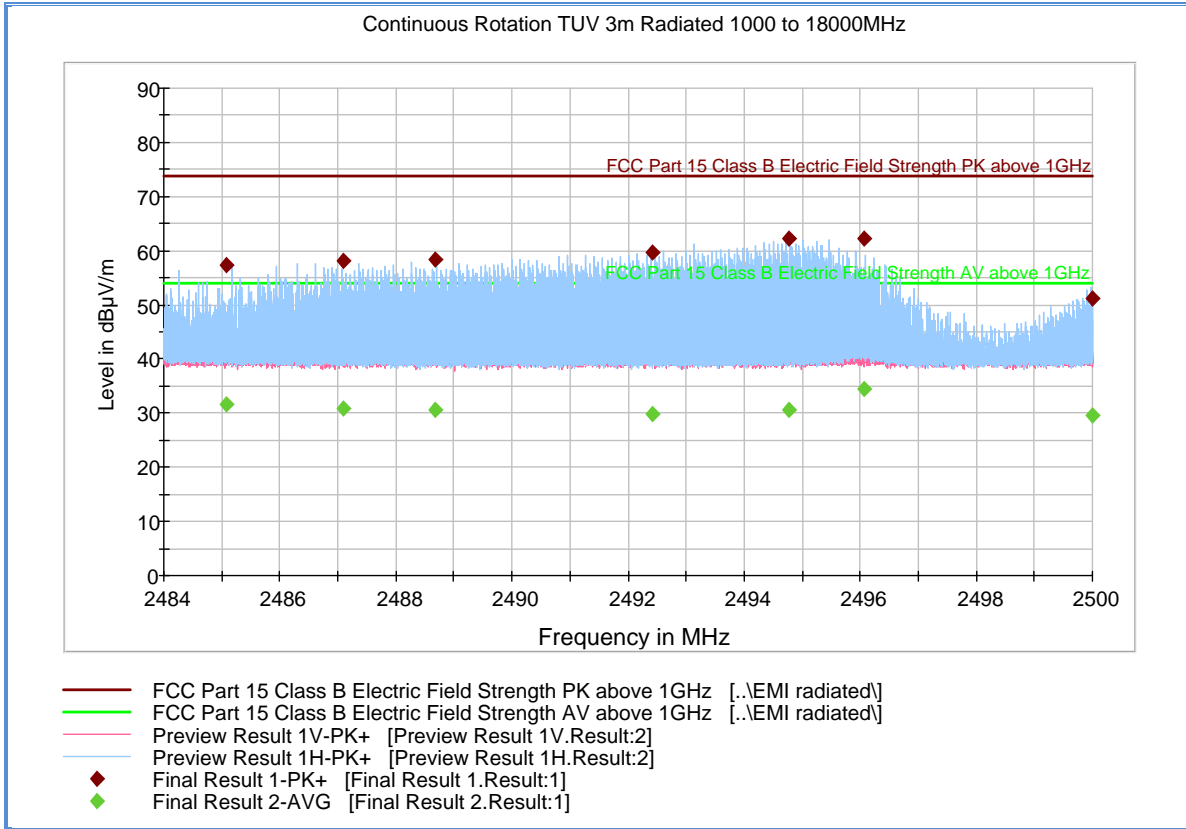

**Peak Data**

Frequency (MHz)	MaxPeak (dBµV/m)	Meas. Time (ms)	Bandwidth (kHz)	Height (cm)	Polarization	Azimuth (deg)	Corr. (dB)	Margin (dB)	Limit (dBµV/m)
2485.072000	57.3	1000.0	1000.000	101.7	H	131.0	-0.1	16.6	73.9
2487.104000	58.2	1000.0	1000.000	102.8	H	132.0	-0.1	15.7	73.9
2488.670400	58.5	1000.0	1000.000	103.7	H	131.0	-0.1	15.4	73.9
2492.409600	59.7	1000.0	1000.000	104.8	H	132.0	-0.1	14.2	73.9
2494.774400	62.3	1000.0	1000.000	102.8	H	131.0	-0.1	11.6	73.9
2496.067733	62.2	1000.0	1000.000	105.7	H	131.0	-0.1	11.7	73.9
2500.000000	51.3	1000.0	1000.000	106.8	H	131.0	-0.1	22.6	73.9

**Average Data**

Frequency (MHz)	Average (dBµV/m)	Meas. Time (ms)	Bandwidth (kHz)	Height (cm)	Polarization	Azimuth (deg)	Corr. (dB)	Margin (dB)	Limit (dBµV/m)
2485.072000	31.7	1000.0	1000.000	101.7	H	131.0	-0.1	22.2	53.9
2487.104000	30.9	1000.0	1000.000	102.8	H	132.0	-0.1	23.0	53.9
2488.670400	30.5	1000.0	1000.000	103.7	H	131.0	-0.1	23.4	53.9
2492.409600	29.9	1000.0	1000.000	104.8	H	132.0	-0.1	24.0	53.9
2494.774400	30.7	1000.0	1000.000	102.8	H	131.0	-0.1	23.2	53.9
2496.067733	34.4	1000.0	1000.000	105.7	H	131.0	-0.1	19.5	53.9
2500.000000	29.6	1000.0	1000.000	106.8	H	131.0	-0.1	24.3	53.9

**Test Notes: 2.4GHz notch filter removed for this test.**



## **2.9 POWER SPECTRAL DENSITY**

### **2.9.1 Specification Reference**

Part 15 Subpart C §15.247(e) and RSS-210 A8.2(b)

### **2.9.2 Standard Applicable**

(e) For digitally modulated systems, the power spectral density conducted from the intentional radiator to the antenna shall not be greater than 8 dBm in any 3 kHz band during any time interval of continuous transmission. This power spectral density shall be determined in accordance with the provisions of paragraph (b) of this section. The same method of determining the conducted output power shall be used to determine the power spectral density.

### **2.9.3 Equipment Under Test and Modification State**

Serial No: PCB board sample / Test Configuration A

### **2.9.4 Date of Test/Initial of test personnel who performed the test**

April 13, 2015 / AC

### **2.9.5 Test Equipment Used**

The major items of test equipment used for the above tests are identified in Section 3.1.

### **2.9.6 Environmental Conditions/ Test Location**

Test performed at TÜV SÜD America Inc. Rancho Bernardo facility

Ambient Temperature	23.0 °C
Relative Humidity	43.0 %
ATM Pressure	101.4 kPa

### **2.9.7 Additional Observations**

- This is a conducted test.
- Test procedure is per Section 10.3 of KDB 558074 (June 05, 2014).
- An offset 21.3dB was used to compensate for the external cable used.
- Detector is RMS power averaging.
- Trace averaging mode over 100 traces.
- Sweep time is Auto Couple.
- EUT complies with 100 kHz RBW.



**2.9.8 Test Results Summary**

Channel (MHz)	Marker Reading using 100 kHz RBW (dBm)	PSD Limit (dBm)	Margin (dB)	Compliance
2407	-16.38	8	24.38	Complies
2440	-16.36	8	24.36	Complies
2480	-16.51	8	24.51	Complies

**2.9.9 Test Results Plots**

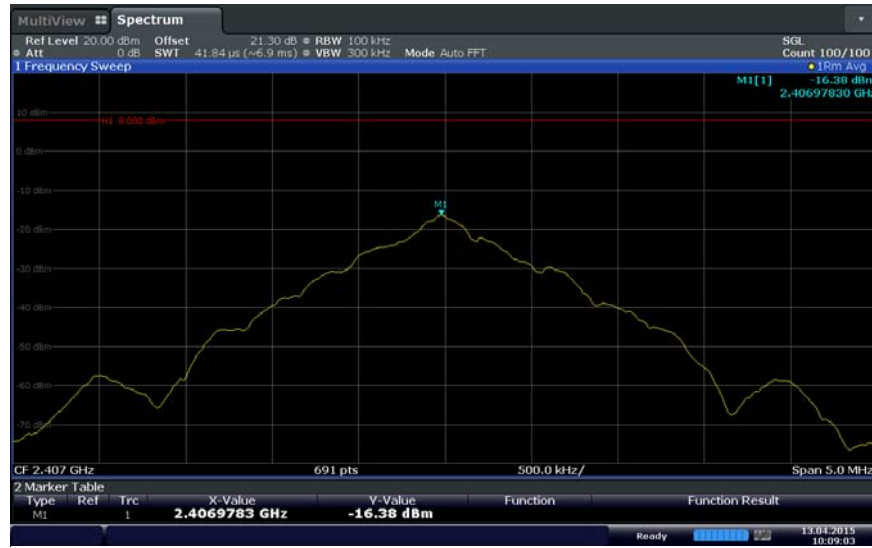

Date: 13 APR 2015 10:09:03

**Low Channel (2407 MHz)**



Date: 13 APR 2015 10:10:19

Mid Channel (2440 MHz)

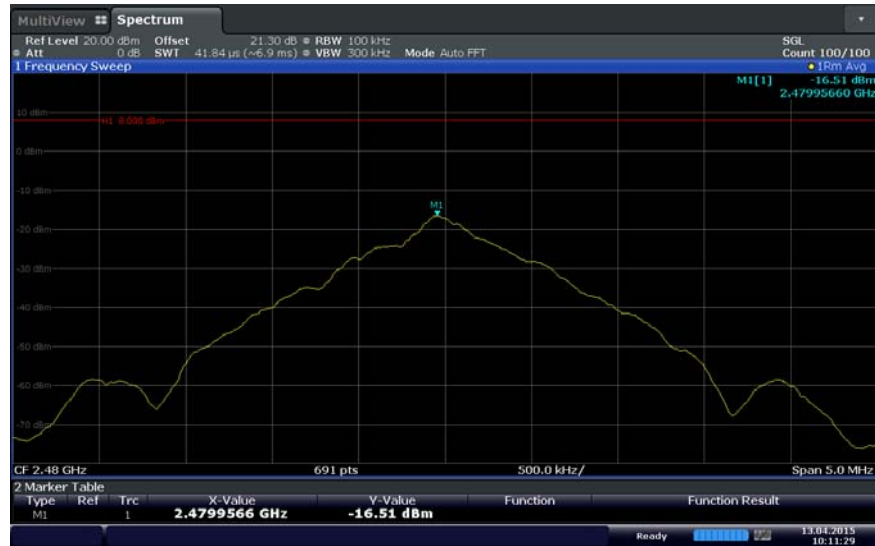

Date: 13 APR 2015 10:11:30

High Channel (2480 MHz)



### **SECTION 3**

#### **TEST EQUIPMENT USED**



### 3.1 TEST EQUIPMENT USED

List of absolute measuring and other principal items of test equipment.

ID Number (SDGE/SDRB)	Test Equipment	Type	Serial Number	Manufacturer	Cal Date	Cal Due Date
<b>Antenna Conducted Port Setup</b>						
7611	Signal/Spectrum Analyzer	FSW26	102017	Rhode & Schwarz	03/25/15	03/25/16
1188	Signal Generator	2024	112282/488	Marconi	10/20/14	10/20/15
8825	20dB Attenuator	46-20-34	BK5773	Weinschel Corp.	Verified by 1188 and 7611	
<b>Radiated Test Setup</b>						
1002	Bilog Antenna	3142C	00058717	ETS-Lindgren	01/30/14	01/30/16
1051	Double-ridged waveguide horn antenna	3115	9408-4329	EMCO	02/28/14	02/28/16
8628	Pre-amplifier	QLJ 01182835-JO	8986002	QuinStar Technologies Inc.	03/20/15	03/20/16
1040	EMI Test Receiver	ESIB40	100292	Rhode & Schwarz	08/29/14	08/29/15
1049	EMI Test Receiver	ESU	100133	Rhode & Schwarz	03/11/15	03/11/16
8816	2.4GHz Band Notch Filter	BRM50702	133	Micro-Tronics	Verified by 1049	
1016	Pre-amplifier	PAM-0202	187	PAM	12/10/14	12/10/15
<b>Miscellaneous</b>						
	Test Software	EMC32	V8.53	Rhode & Schwarz	N/A	



### 3.2 MEASUREMENT UNCERTAINTY

For a 95% confidence level, the measurement uncertainties for defined systems are:

#### 3.2.1 Radiated Emission Measurements (Below 1GHz)

Contribution		Probability Distribution Type	Probability Distribution $x_i$	Standard Uncertainty $u(x_i)$	$[u(x_i)]^2$
1	Receiver/Spectrum Analyzer	Rectangular	0.45	0.26	0.07
2	Cables	Rectangular	0.50	0.29	0.08
3	Preamp	Rectangular	0.50	0.29	0.08
4	Antenna	Rectangular	0.75	0.43	0.19
5	Site	Rectangular	3.89	2.25	5.04
6	EUT Setup	Rectangular	1.00	0.58	0.33
Combined Uncertainty ( $u_c$ ):					2.41
Coverage Factor (k):					2
Expanded Uncertainty:					4.82

#### 3.2.2 Radiated Emission Measurements (Above 1GHz)

Contribution		Probability Distribution Type	Probability Distribution $x_i$	Standard Uncertainty $u(x_i)$	$[u(x_i)]^2$
1	Receiver/Spectrum Analyzer	Rectangular	0.57	0.33	0.11
2	Cables	Rectangular	0.70	0.40	0.16
3	Preamp	Rectangular	0.50	0.29	0.08
4	Antenna	Rectangular	0.37	0.21	0.05
5	Site	Rectangular	3.89	2.25	5.04
6	EUT Setup	Rectangular	1.00	0.58	0.33
Combined Uncertainty ( $u_c$ ):					2.40
Coverage Factor (k):					2
Expanded Uncertainty:					4.81

#### 3.2.3 Conducted Antenna Port Measurement

Contribution		Probability Distribution Type	Probability Distribution $x_i$	Standard Uncertainty $u(x_i)$	$[u(x_i)]^2$
1	Receiver/Spectrum Analyzer	Rectangular	0.34	0.20	0.04
2	Cables	Rectangular	1.00	0.58	0.33
3	EUT Setup	Rectangular	0.50	0.29	0.08
Combined Uncertainty ( $u_c$ ):					0.67
Coverage Factor (k):					1.96
Expanded Uncertainty:					1.32



## SECTION 4

### DIAGRAM OF TEST SETUP



#### 4.1 TEST SETUP DIAGRAM

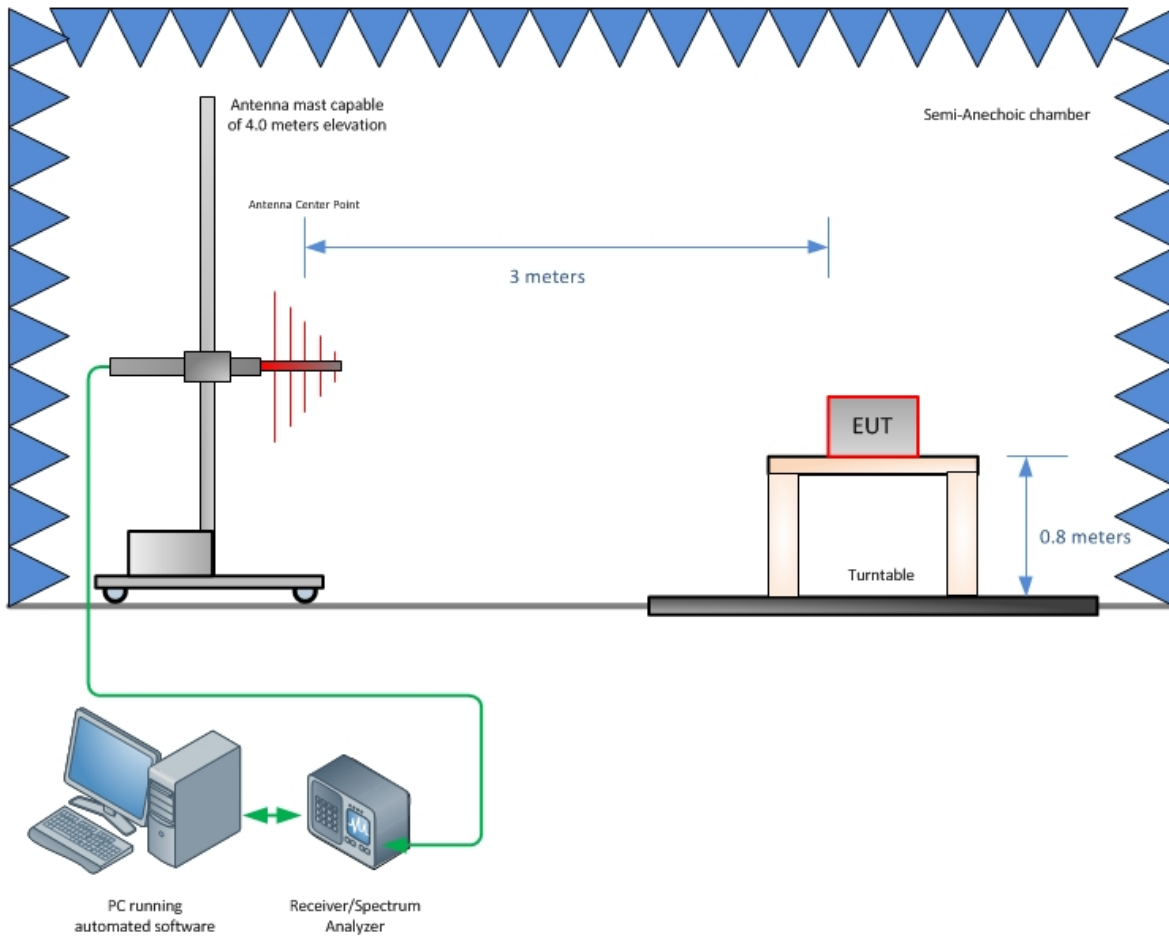

**Radiated Emission Test Setup (Below 1GHz)**

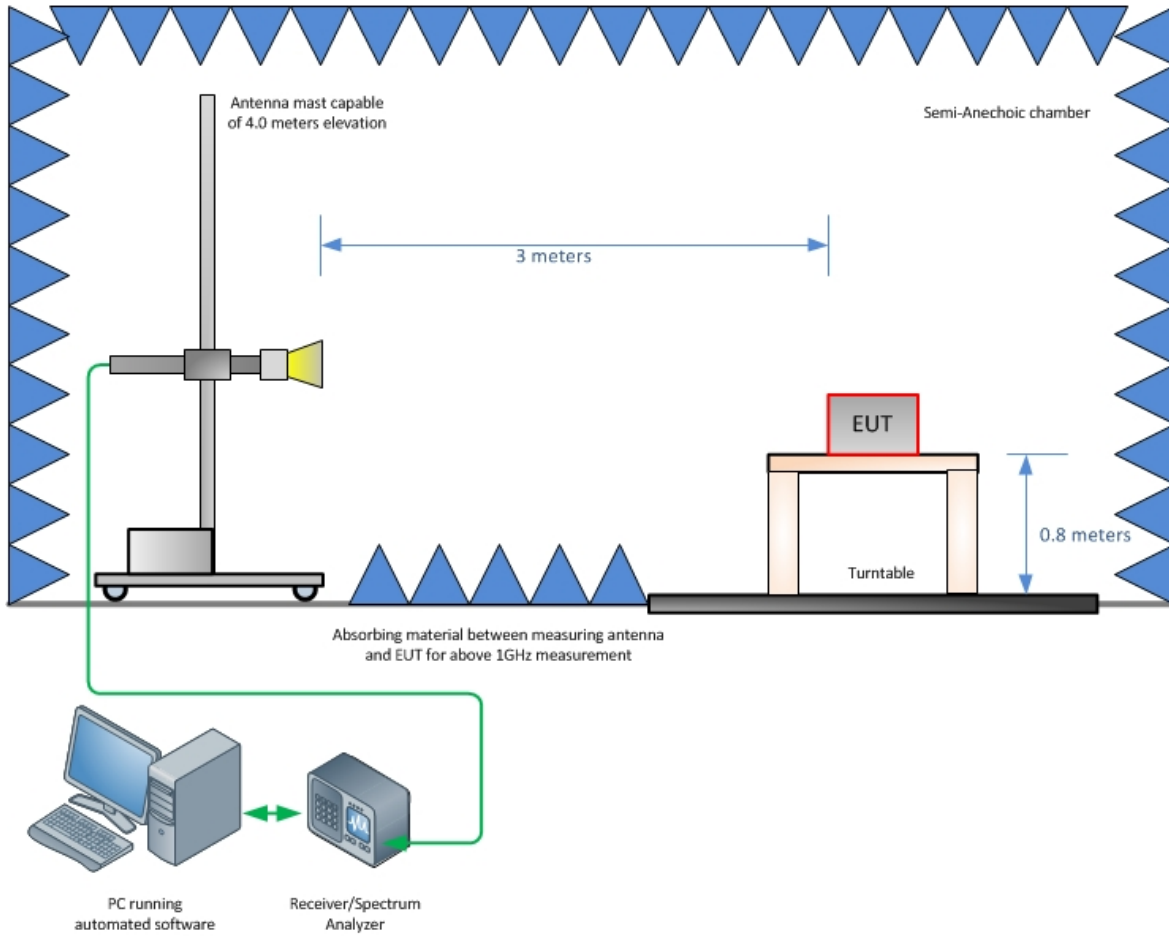

**Radiated Emission Test Setup (Above 1GHz)**



## SECTION 5

### ACCREDITATION, DISCLAIMERS AND COPYRIGHT



## 5.1 ACCREDITATION, DISCLAIMERS AND COPYRIGHT

TÜV SÜD America Inc.'s reports apply only to the specific sample tested under stated test conditions. It is the manufacturer's responsibility to assure the continued compliance of production units of this model. TÜV SÜD America, Inc. shall have no liability for any deductions, inferences or generalizations drawn by the client or others from TÜV SÜD America, Inc.'s issued reports.

This report is the confidential property of the client. As a mutual protection to our clients, the public and TÜV SÜD America, Inc., extracts from the test report shall not be reproduced, except in full without TÜV SÜD America, Inc.'s written approval.

This report must not be used to claim product certification, approval, or endorsement by A2LA, NIST, or any agency of the federal government.

TÜV SÜD America, Inc. and its professional staff hold government and professional organization certifications for AAMI, ACIL, AEA, ANSI, IEEE, A2LA, NIST and VCCI.



A2LA Cert. No. 2955.13

