

# User Manual Version 1.0

---



# ITR-3800



## TABLE OF CONTENTS

01. <a href="#">Safety Instructions</a>	5
02. <a href="#">Sensor Description</a>	6
2.1 <a href="#">Traffic Applications with the ITR-3800</a>	7
2.1.1 <a href="#">Object List</a>	7
2.1.2 <a href="#">Event Message</a>	8
03. <a href="#">Mechanical Drawing</a>	9
04. <a href="#">Accessories</a>	10
06. <a href="#">Product Specification</a>	12
07. <a href="#">Installation and Mounting</a>	14
7.1 <a href="#">Mounting</a>	14
7.2 <a href="#">Mounting Bracket</a>	14
7.3 <a href="#">Installation</a>	15
08. <a href="#">Connectors</a>	16
8.1 <a href="#">Power Supply Connector</a>	16
8.2 <a href="#">PoE   Ethernet Connector</a>	16
09. <a href="#">Connection</a>	17
9.1 <a href="#">External Power Supply   24 - 48V DC</a>	17
9.2 <a href="#">PoE   Power over Ethernet</a>	18
10. <a href="#">Network Configuration</a>	19
10.1 <a href="#">DHCP configuration with dynamic IP address</a>	19
10.2 <a href="#">Static IP address</a>	19
10.3 <a href="#">Network Hostname</a>	20
10.4 <a href="#">UDP Settings</a>	21
10.5 <a href="#">TCP / IP Settings</a>	21
11. <a href="#">Communication</a>	22
11.1 <a href="#">Read/Write Configuration</a>	23
11.2 <a href="#">Object List</a>	23
11.3 <a href="#">Event Messages</a>	24
11.3.1 <a href="#">Zone Type Motion</a>	24
11.3.2 <a href="#">Zone Type Presence</a>	25

12. <a href="#">Configuration using Traffic Manager</a>	26
12.1 <a href="#">Installation of Traffic Manager</a>	26
12.2 <a href="#">Overview of Traffic Manager</a>	27
12.3 <a href="#">Connect to Camera Stream</a>	27
12.4 <a href="#">Connect to ITR-3800</a>	28
12.5 <a href="#">Configuration Wizard</a>	28
12.5.1 <a href="#">Background</a>	29
12.5.2 <a href="#">Reference Length</a>	30
12.5.3 <a href="#">Sensor Position</a>	31
12.5.4 <a href="#">Lineals</a>	32
12.5.5 <a href="#">Event Zones</a>	33
16.5.6 <a href="#">ETA - Estimated time of arrival</a>	34
12.5.7 <a href="#">Ignore Zones</a>	35
12.5.8 <a href="#">Text Label</a>	36
12.6 <a href="#">Save Configuration</a>	37
12.7 <a href="#">View Settings</a>	38
12.8 <a href="#">Record / Playback</a>	39
12.9 <a href="#">Firmware update</a>	40
12.10 <a href="#">Restore Network Settings</a>	40
12.11 <a href="#">Object List Traffic Manager</a>	41
13. <a href="#">Traffic Application Implementations</a>	42
13.1 <a href="#">Queue Length</a>	43
13.2 <a href="#">Stop Bar Detection</a>	44
13.3 <a href="#">Advance Detection</a>	45
13.4 <a href="#">Wrong Way Detection</a>	46
13.5 <a href="#">Traffic Counting</a>	47
13.6 <a href="#">Pedestrian/Bike Counting with Sidewalk Zones</a>	48
13.7 <a href="#">Working Example—An overview</a>	49
13.8 <a href="#">Working Example—In 10 easy steps to our own configuration</a>	50
13.9 <a href="#">Working Example—Application Stop Bar Detection</a>	55
13.10 <a href="#">Working Example—Application Traffic Counting</a>	56
13.11 <a href="#">Working Example—Application Queue Length</a>	58

14. <a href="#">Approvals</a>	59
15. <a href="#">Disposal</a>	59
16. <a href="#">Appendix</a>	60
17. <a href="#">Contact</a>	63
18. <a href="#">Known Issues</a>	63

## CO-APPLICABLE DOCUMENTS

REFERENCE	DOCUMENT
[1]	ITR-3800 User Manual - Mounting Bracket
[2]	ITR-3800 Quick Start Guide
[3]	ITR-3800_RadarAPI_readMe
[5]	ITR-3800 Data Sheet

## REVISION HISTORY

VERSION	DATE	COMMENT
1.0	2022-12-02	Initial Release

## 1. SAFETY INSTRUCTIONS

- Only skilled and instructed persons shall install and connect the devices.
- Proper experience in working with mains voltage, electrical and electronic devices is required.
- Do not connect the devices directly to mains voltage, instead use the voltage given in the manual
- Do not wire any connections while power is applied to the device.
- Ground the devices carefully to prevent electrical shock.
- All connectors are pin-coded and fit in only one position.
- Mount the devices carefully to prevent them from shifting or dropping.
- The case must not be opened as this will void the warranty and cause incorrect calibration of the sensor.
- The radome must not be painted, covered or glued over, as this will impair its function and cause incorrect calibration of the sensor.
- Ensure adequate ventilation during operation.
- The vent must not be covered.
- All connected plugs must be screwed mechanically stable in order to comply with protection class IP67.
- Unused connections should be covered with a sealing cap.
- Use a shielding for the sensor if needed to protect against environmental conditions (snow, rain, dust)
- Only use fully functional equipment (ladders, aerial work platform, ...) when working above ground.
- Staff shall be capable of working at heights.
- Use caution when installing the devices on or around active roadways. Pay attention to moving traffic.
- The devices must be mounted to a stiff and solid support.
- Vibration, oscillation or any kind of movement will reduce the sensor performance.
- Make sure that your installation methods are in accordance with local safety policy and procedures and company practices. The protective conductor connection must not be used for other purposes. It must have a permanent electrical continuity and mechanical strength.

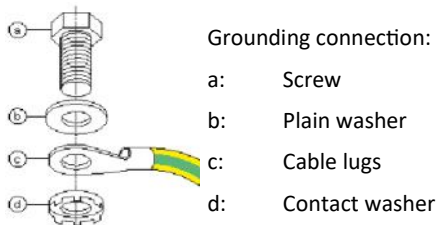

## 2. SENSOR DESCRIPTION

The ITR-3800 is a 24GHz 4D/UHD radar sensor designed and developed for multiple-lane, multiple-target tracking, intersection management and traffic monitoring applications.

The newest member of InnoSenT's radar fleet is designed for long-range and wide horizontal view to cover up to two slip roads to an intersection with multiple lanes.

### Measurements

The sensor uses, with its Doppler based radial motion detection principle, innovative signal processing for optimal target detection. The measurements contain range, radial speed, azimuth and elevation angle, received signal strength and more parameters of the observed targets. This ensures a fast and efficient field of view coverage for excellent detection of moving targets, as well as stationary objects. Thanks to its high definition resolution the ITR-3800 is capable of separating up to 512 detections on up to 8 lanes, enabling many different traffic monitoring applications in scenarios with many objects present.

### Tracking

After measuring the parameters of the detections, the ITR-3800 uses modern multiple-target tracking algorithms to generate an object list in every update cycle of 50ms. This object list, consisting of up to 128 tracks, provides a variety of track parameters, such as position, velocity, direction, Object ID and many more.

### Applications

With its quick and easy configuration, the ITR-3800 can be used for a variety of different applications. Thanks to our exclusive introduction of two brand new event zone types, challenging scenarios like Traffic Counting, Stop bar Detection, queue length measurements, and many more, can be solved comfortably.

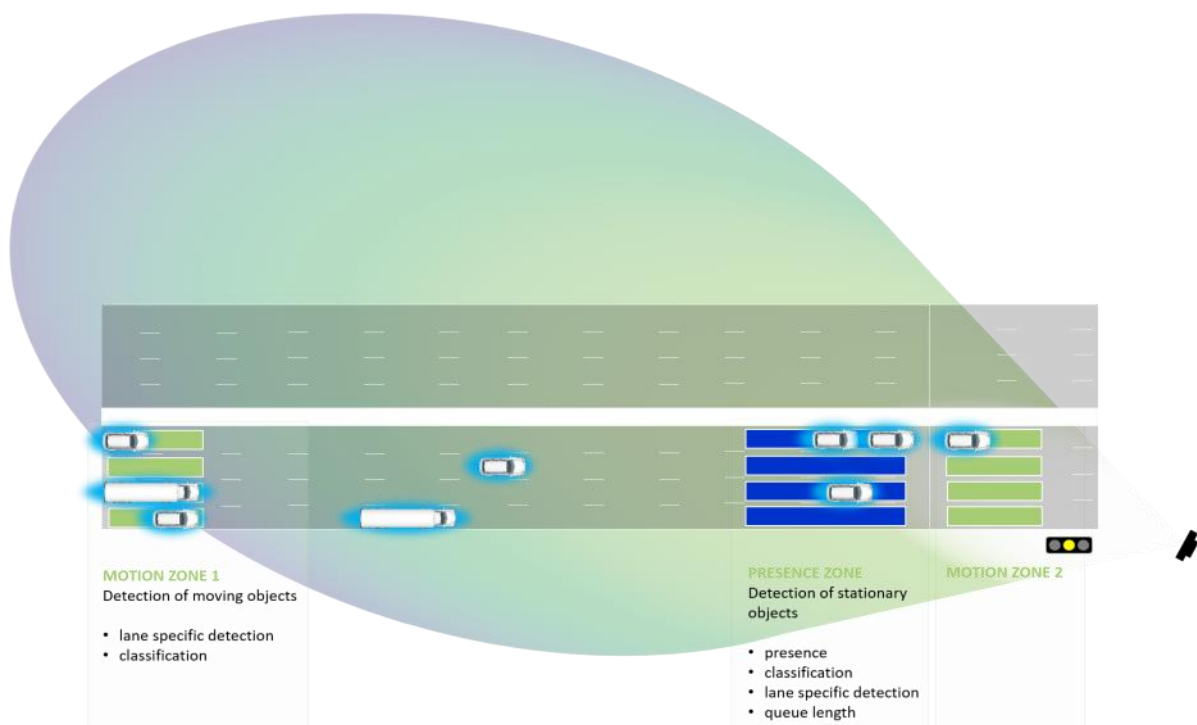

## 2.1 Traffic Applications with the ITR-3800

The main feature of the ITR-3800 are its two user friendly outputs:

- Object list: supplies the user with all object parameters, which are sent via Ethernet. This allows the user to implement his own desired applications.
- Event Messages: event based UDP or TCP/IP messages, which are sent via Ethernet or RS-485. These messages enable quick and easy deployment for traffic applications.

These two outputs provide the user with all the necessary information needed to successfully monitor his applications. The two outputs are described in the following.

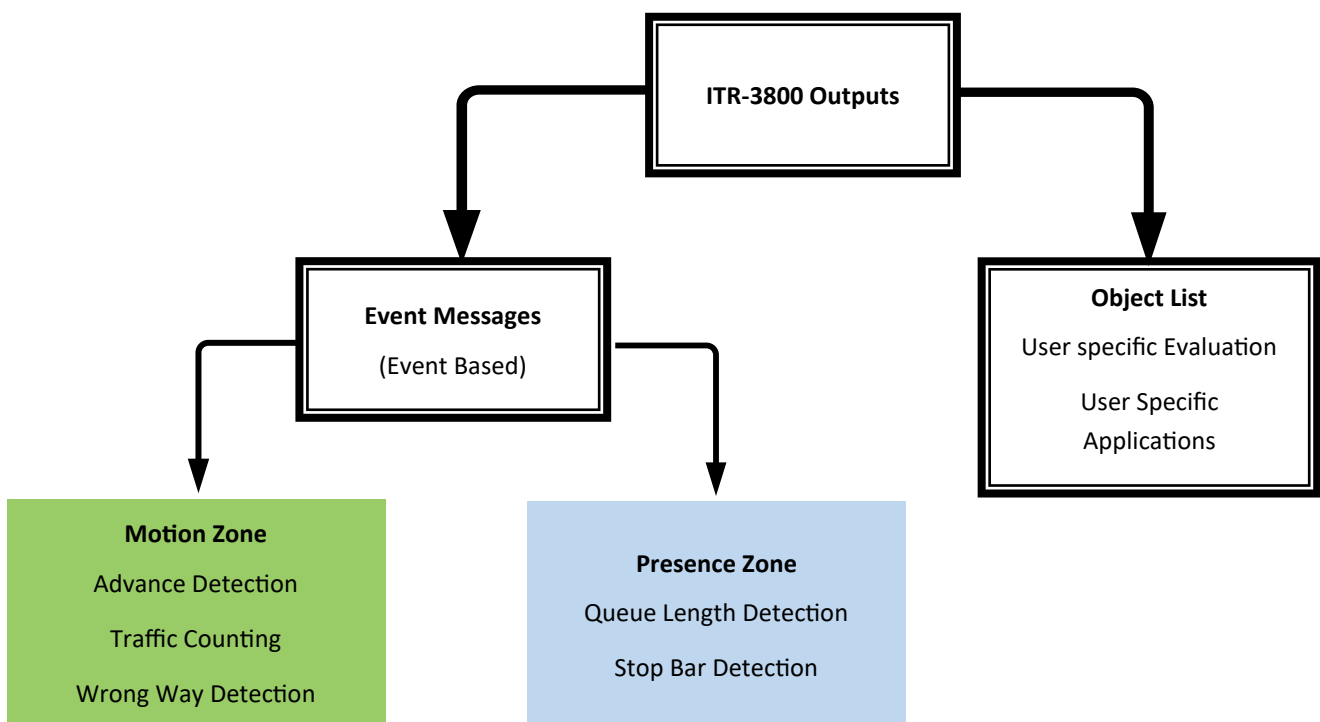

### 2.1.1 Object List

Object lists have to be requested by the Radar API. The update cycle of the object list is 50ms and a new request must be sent in order to retrieve the latest object list. The content of each object list, with the parameters of every track, is described in [11.2].

The use of object lists allows users to perform their own evaluations and implementations of specific applications.

### 2.1.2 Event Message

The ITR-3800 sends the user UDP or TCP/IP event messages for two different types of Event Zones, which enable realization of many different traffic applications:

- Motion Zone: for detection of moving objects
- Presence Zone: for detection of stationary objects

Both Presence and Motion Zones can be used separately as well as in combination for detection within zones of interest. The two Event Zone types can be easily configured via InnoSenT's Traffic Manager or ITR-3800 Radar API.

Thanks to these event messages the user gets a comfortable overview of complex situations. On how to set and configure event zones and what zone is most ideal for which application, please refer to sections [12.6.5] and [13].

Depending on the Event Zone type a corresponding event message will be sent with the following information.

	MOTION ZONE	PRESENCE ZONE
<b>Message Information</b>	Time stamp	Time stamp
	Zone type	Zone type
	Zone number	Zone number
	Speed	Queue
	Class	Number of stationary objects
	Direction	System state
	System state	Output Number
	Output Number	Phase Number
	Phase Number	Number of pedestrians/bikes
	ObjectID	Number of cars
	Estimated time of arrival	Number of small trucks
	Number of big trucks	
<b>Update</b>	Each time an object enters the Event Zone	Each time there is a change in Queue Length or number of static objects in the Event Zone



### 3. MECHANICAL DRAWING

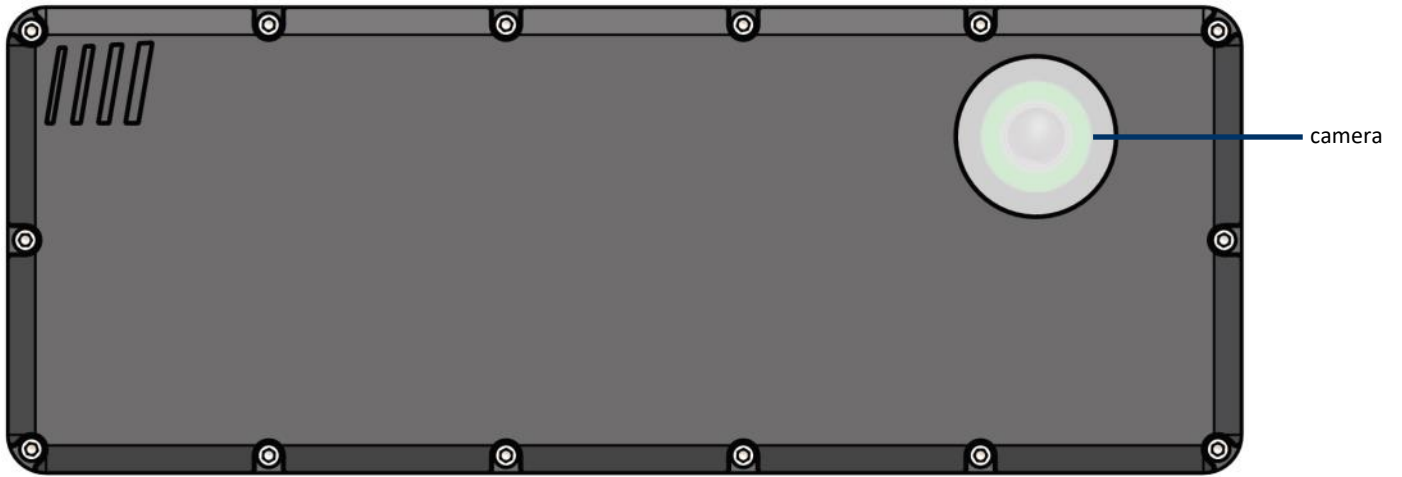

front

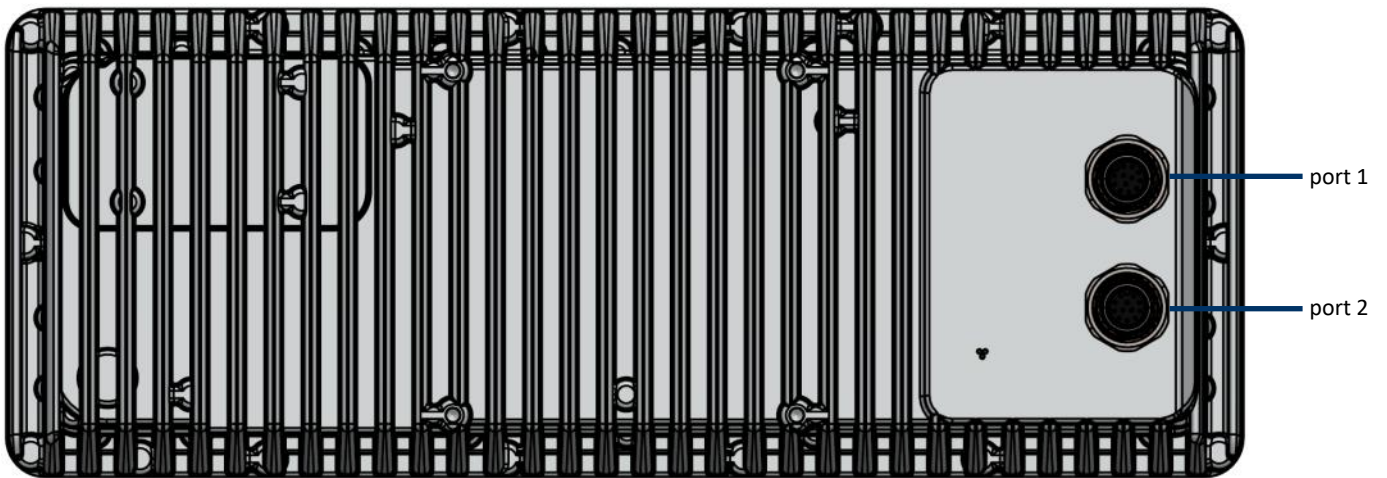



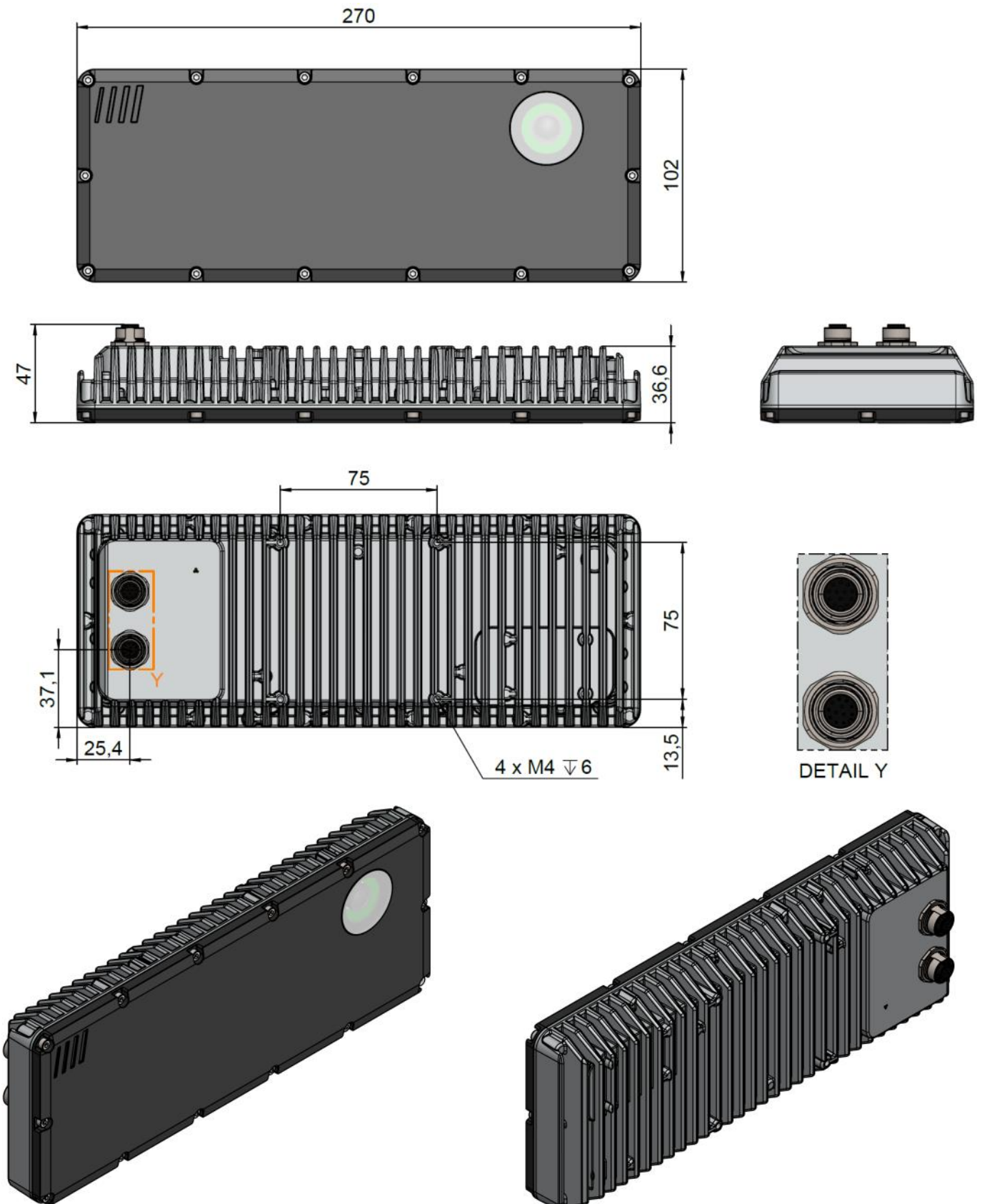

back

**Note:** All dimensions in mm

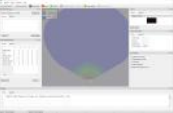

## 5. ACCESSORIES

ACCESSORY	ORDER NUMBER	PICTURE	DESCRIPTION
Power Supply Cable	29.00000284		Connection with power supply Connection with RS485 interface
Ethernet Cable	29.00000283		Connection with PoE or Ethernet
Mounting Bracket	80.00000417		attaches the ITR-3800 to a mast, post or pole [1]
PoE Injector	29.00000297		Digitus PoE Ultra Injector, 60W, see vendor data sheet
Software Package	download at <a href="#">InnoSenT download portal</a> .		<p>Software Package:</p> <ul style="list-style-type: none"> <li>-Traffic Manager</li> <li>- Radar API</li> <li>- Network Browser</li> <li>- Firmware Update</li> </ul> <p>Traffic Manager is used for configuring the ITR-3800 and displays the radar data on screen.</p>

## 6. PRODUCT SPECIFICATION

PARAMETER	TYPICAL VALUE <sup>1</sup>	UNIT
<b>Regulatory</b>		
Operating Frequency	24.05 .. 24.25	GHz
Bandwidth	200	MHz
Output Power (EIRP)	< 20dBm PK // < 108dBμV/m AVG	
<b>Range</b>		
Min. Detection Range	5   16.4	m   ft
Max. Detection // Classification: Pedestrian <sup>2</sup>	130   427 // 83   272	m   ft
Max. Detection // Classification: Bike <sup>2</sup>	130   427 // 83   272	m   ft
Max. Detection // Classification: Car <sup>2</sup>	300   984 // 183   600	m   ft
Max. Detection // Classification: Truck <sup>2</sup>	300   984 // 183   600	m   ft
Range Accuracy	0.47   1.5	m   ft
<b>Speed</b>		
Radial Speed Resolution	0.46   0.29	km/h   mph
Speed Range	-233 .. +233   -144.8 .. -144.8	km/h   mph
Speed Accuracy	0.23   0.14	km/h   mph
<b>Angle</b>		
Field of View: Azimuth	110	°
Field of View: Elevation	30	°
Separation: Azimuth	5	°
Angular Accuracy: Azimuth	0.5	°
<b>Operational</b>		
Mode 1: High Performance Mode	50 .. 75	ms
Mode 2: Prediction Mode	56	ms
Mode 3: Camera Mode	64	ms
Processing Latency	1	cycle
Initialization Time: DHCP // Static IP	<52 // <49	s
Interfaces	Ethernet 1Gbit/s   RS485 full duplex   PoE	
Connectors	M12 industrial	
<b>Power supply</b>		
Operating Voltage: DC	24 .. 48   ±5%	V
Supply Current <sup>3</sup>	0.76	A
Power Consumption <sup>3</sup>	18.3	W

<sup>1</sup> typical specifications are for general understanding and may vary

<sup>2</sup> the classification parameter is defined as the max. distance up to which an object can be classified

<sup>3</sup> the typical value is given for 24V at 25°C

PARAMETER	TYPICAL VALUE <sup>1</sup>	UNIT
<b>Camera</b>		
Quality: Live Video	Full HD (1920 x 1080p)	
Quality: Still Image	Full HD (1920 x 1080p)	
Field of View: Diagonal	143	°
Field of View: Azimuth	121	°
Field of View: Elevation	73	°
Field of View: Range	5 .. 80   16.4 .. 262.5	m   ft
Video Codec	H.264	
Frame Rate	30	Hz
<b>Environment</b>		
Operating Temperature Radar	-40 .. +80	°C
Storage Temperature	-40 .. +85	°C
Operating Temperature Camera <sup>4</sup>	-30 .. +70	°C
Protection Class <sup>5,6</sup>	IP67	
<b>Mechanical</b>		
Dimensions (with connectors): H/W/D	102 x 270 x 37 (47)   4 x 10.6 x 1.5 (1.8)	mm   in
Weight	<1   <2.2	kg   lb

<sup>4</sup> the camera performance might be reduced by extreme temperatures

<sup>5</sup> tested in independent laboratory

<sup>6</sup> only IP67, if cables and/or gaskets are plugged into connectors

## 7. INSTALLATION & MOUNTING

Easy installation—one of the smart features of the ITR-3800. The Traffic Manager Software enables a quick configuration of all necessary parameters (see Section '[Configuration using Traffic Manager](#)' for further information.)

### 7.1 Mounting

Mounting is realized with VESA MIS-D 75 standard. Required are 4x 6mm long M4 screws.

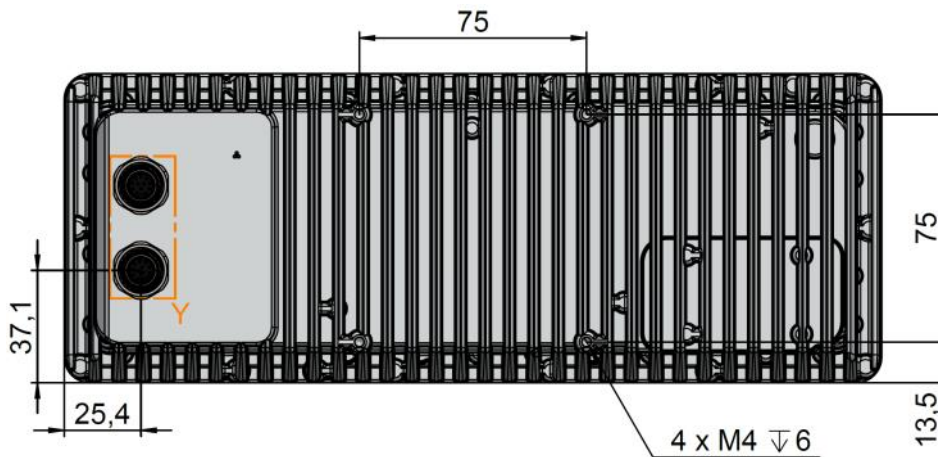

### 7.2 Mounting Bracket

A mounting bracket for easy assembly on a pole (round shape) is available from InnoSenT. Information about the mounting bracket is provided in Document [1].

Please address your InnoSenT sales contact for further information.



### 7.3 Installation

This sketch shows a typical left side installation. The ITR-3800 can also be configured to gantry or right side installation. Take care that the area of interest from the road fits into the FOV of the device. The ITR-3800 is designed to track the oncoming traffic. Installations outside the recommended specification tend to result in performance drops. Occlusions need to be considered. It must be understood that neither the detection probability may be 100%, nor the false alarm rate 0%.

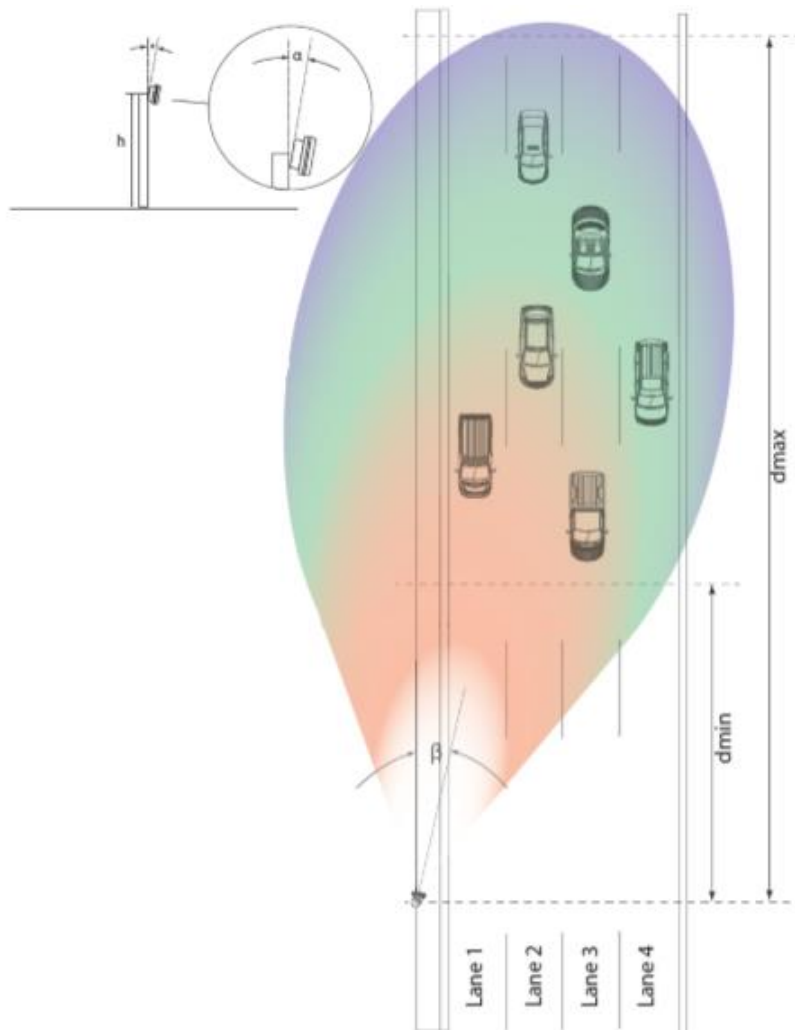

INSTALLATION PARAMETER	MINIMUM	TYPICAL <sup>1</sup>	MAXIMUM	UNIT
Height	4   13	6   19	8   26	m   ft
Elevation Angle <sup>4</sup>	-10	-7	0	°
Angle to Lane <sup>5</sup>	-60	6	60	°
Motion Zone	30   98		200   656	m   ft
Presence Zone	20   65		80   262	m   ft

<sup>4</sup> Referenced to road gradient angle. The above range pertains to a horizontal road, i.e. elevation has to be adjusted to the individual scene.

<sup>5</sup> Driving direction of the traffic can be within ±60° to radar sensor boresight. take care that the road is well located within the radar beam within 110° FOV. For further information, please refer to Section [16].

## 8. CONNECTORS

### 8.1 Power Supply and RS485 Connector

Type: Phoenix Contact SACC-CI-M12FS-12CON-SH TOR 32 (1457704)

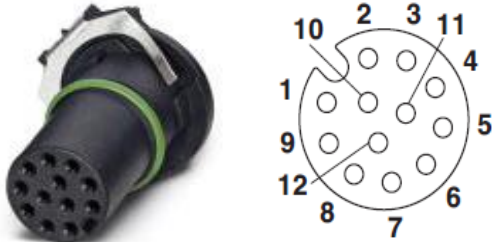

PIN	DESCRIPTION
1	GND
2	GND
3	RS485_FD.A
4	RS485_FD.B
5	RS485_FD.Z
6	RS485_FD.Y
7	VCC
8	VCC
9	Do not connect
10	Do not connect
11	Do not connect
12	Do not connect

### 8.2 PoE | Ethernet Connector

Type: Phoenix Contact SACC-CI-M12FS-8CON-L-180-10 (1402457)

PoE is implemented, according to IEEE 802.3bt standard, see [9.2].

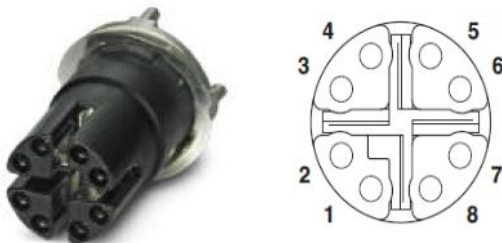

PoE IEEE 802.3bt		
PIN	DATA	PoE
1	A+	IN1
2	A-	
3	B+	IN1
4	B-	
5	D+	IN2
6	D-	
7	C-	IN2
8	C+	



## 9. CONNECTION

Power supply cable and Ethernet cable are available from InnoSenT. Please contact your InnoSenT sales person for further information.

**WARNING:** Connect the module only as stated below. Do not interchange these options. Connections other than illustrated below may result in unexpected behaviour!

### 9.1 External Power Supply | 24 - 48V DC

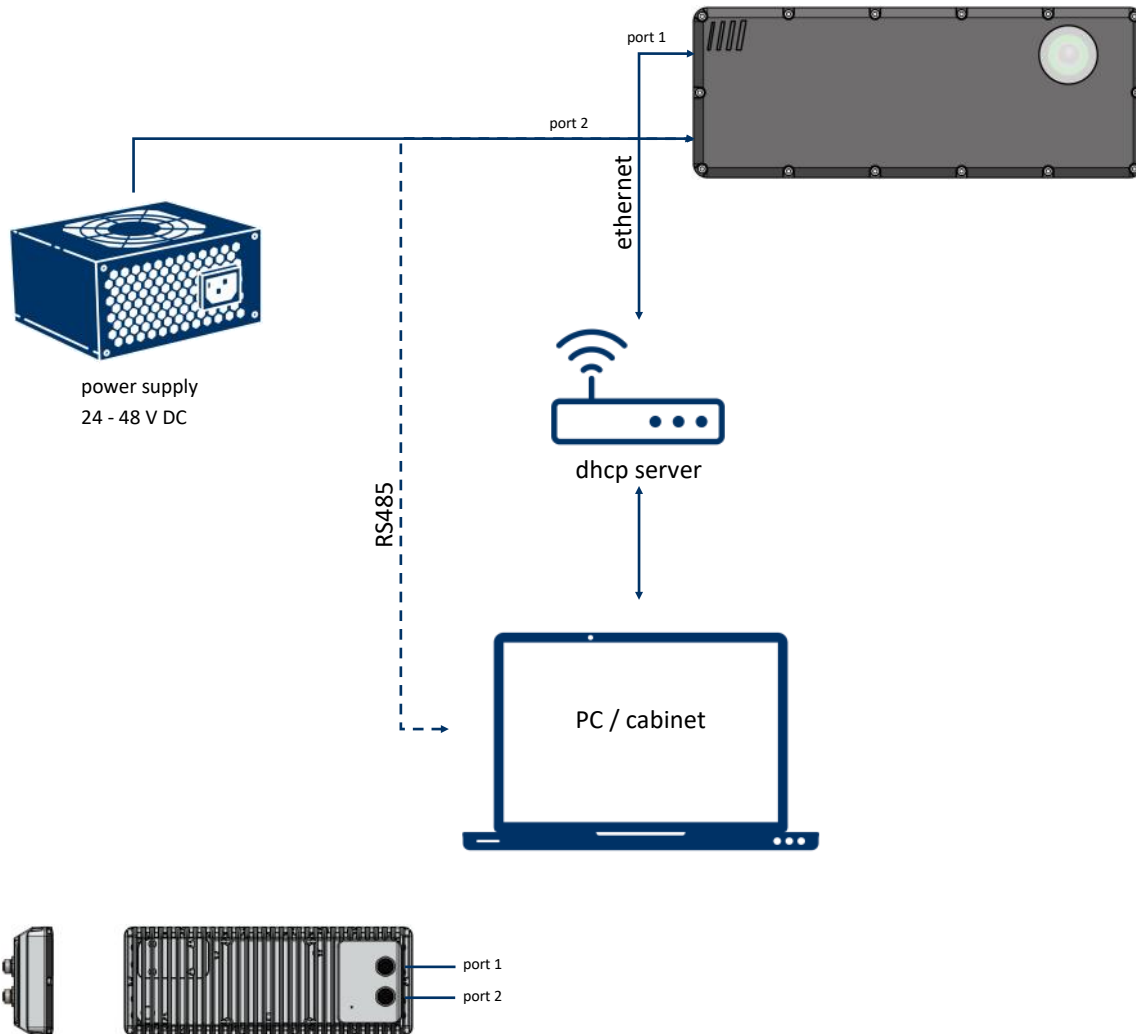

## 9.2 PoE | Power over Ethernet

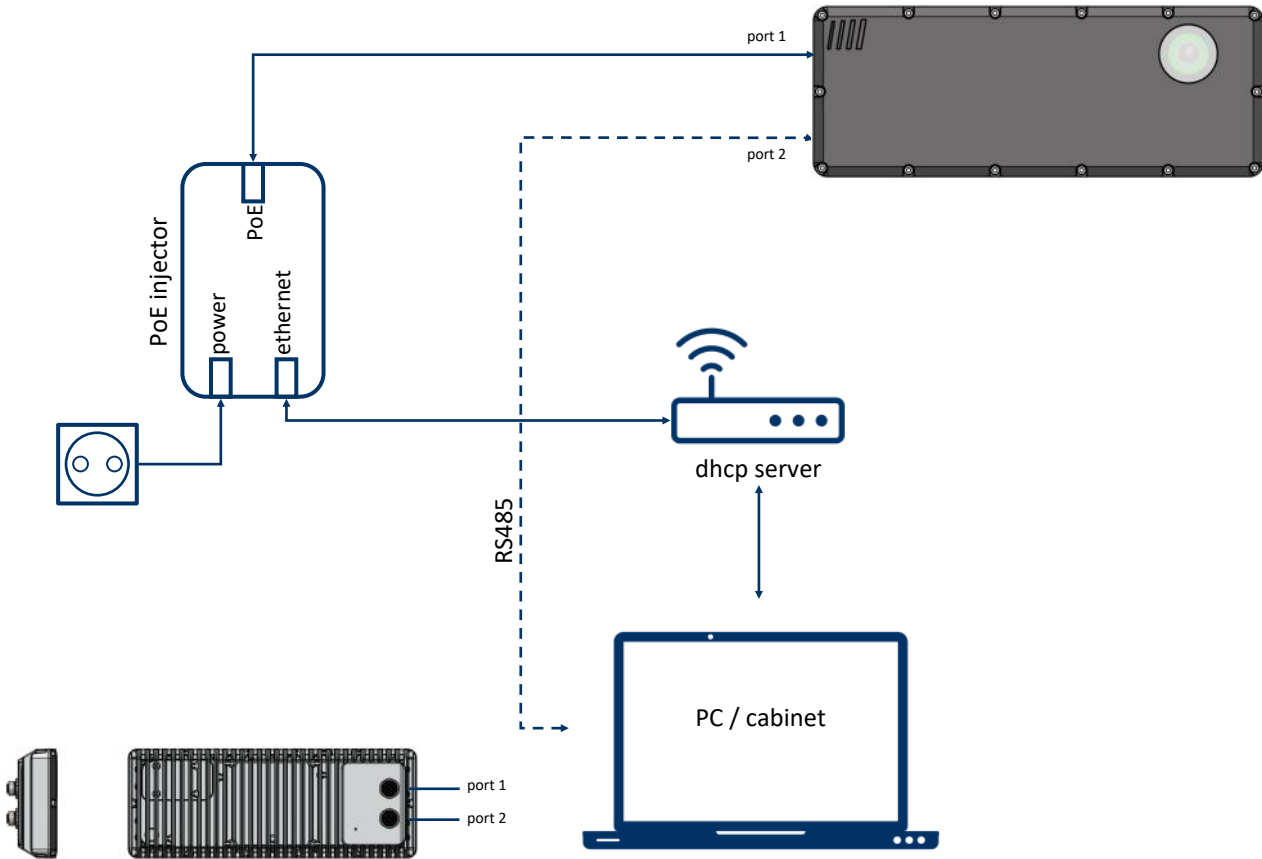

PARAMETER	TYPICAL VALUE <sup>1</sup>	UNIT
Applied PoE Standard	IEEE 802.3bt Type 3 „4PPoE“	
Power available at powered device (PD)	51	W
Maximum power delivered by power sourcing equipment (PSE)	60	W
Voltage range (at PSE)	50.0—57.0	V
Voltage range (at PD)	42.5—57.0	V
Maximum current I <sub>max</sub>	600 mA per pair	mA
Maximum cable resistance per pairset	12.5	Ω
Power management	Six power class levels (1-6) negotiated by signature or 0.1 W steps negotiated by LLDP	
Derating of maximum cable ambient operating temperature	10 °C with more than half of bundled cables pairs at I <sub>max</sub>	
Supported cabling	Category 5	
Supported modes	Mode A, mode B, 4-pair mode	

## 10. NETWORK CONFIGURATION

Per factory setting, DHCP is configured. Network configuration may be changed when connection has been established.

**Note:** The ports used by the ITR-3800 can be secured by windows firewall or other firewalls. Check the settings of the firewall if you have connection problems.

### 10.1 DHCP configuration with dynamic IP address

A DHCP server must be available in the environment network. Before powering up, the ethernet connection shall be established via cable. It takes typically 30 seconds until the system is operational.

There is no cyclical request for DHCP server available. If connecting a DHCP server after boot up, please restart the system.

When using more than one ITR-3800 in a network the different devices can be determined by their unique hostname which is printed on the device label. This hostname consists of the string "ITR3800-XXXXXXXXXX", where X refers to the MAC address.

**Troubleshooting:** If you cannot find the device, please check the assigned IP Address in the DHCP server.

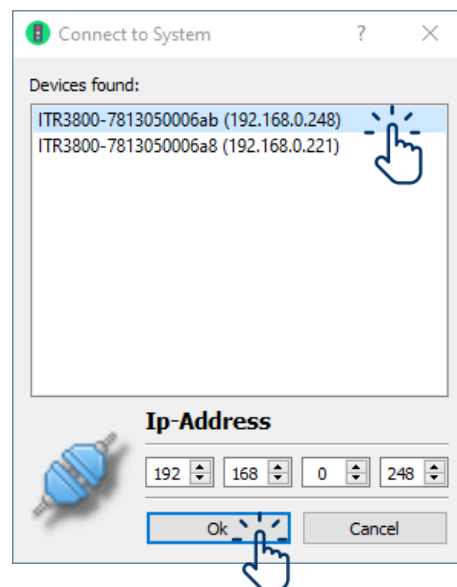
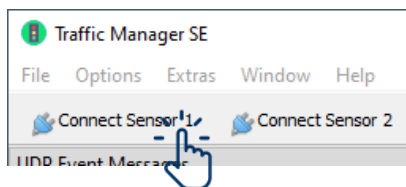

### 10.2 Static IP address

To configure static IP address, go to network settings for the connected system and change, according to your network configuration.

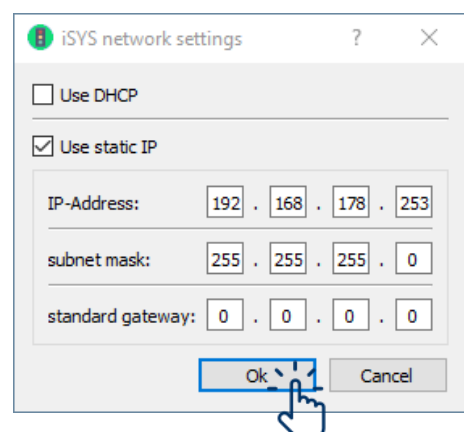
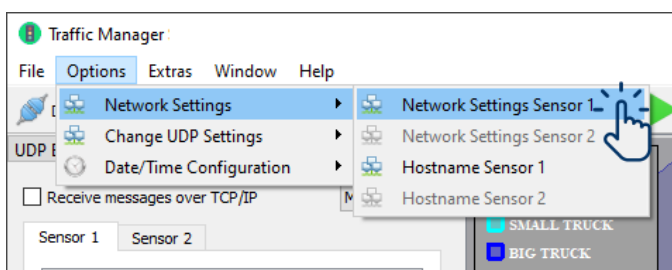

### 10.3 Network Hostname

Each device's hostname is unique. It's printed on the device label on its backside. This hostname consists of the string "ITR3800-XXXXXXXXXX", where X refers to the MAC address without hyphens.

If preferred, you are able to change the hostname. Please observe the following rules:

- Maximum length: 255 characters (recommendation is a short and descriptive name)
- Valid characters: a-z, A-Z, 0-9, \_ and - (related to RFC 952)
- Hostname cannot begin with a number or \_ and -

After changing the hostname, a system reboot is needed for the change to take effect.

**Note:** It can take a while until the new hostname is recognized by the router or DNS service.

**Troubleshooting:** If your new hostname is not pingable, you can try to rebuild your DNS cache. Example for Windows: Type "ipconfig /flushdns" in your command line window (cmd.exe).

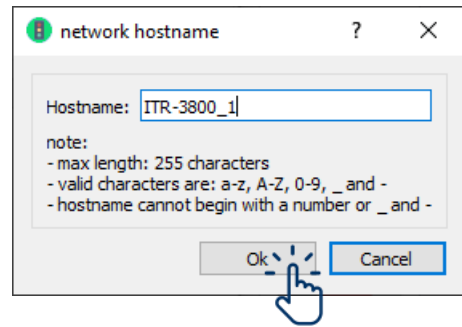
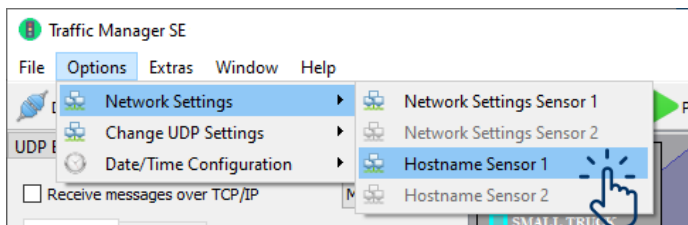

### 10.4 UDP Settings

The UDP settings can be changed between three options. Also, the UDP port 62200 can be changed to a customized port.

**Note:** Do not to use reserved ports, such as 80, 21, ...

**Option 1:** *Send UDP Message to Broadcast* (default setting) sends all event messages to the broadcast address. Every PC in the same network will receive the messages.

**Option 2:** *Send UDP Message to Multicast* sends all event messages to the multicast address. Every PC in the same network joining the multicast group will receive the messages.

**Option 3:** *Send UDP Message to IP address* sends all event messages to a specific IP address. Only the specific IP will receive UDP messages.

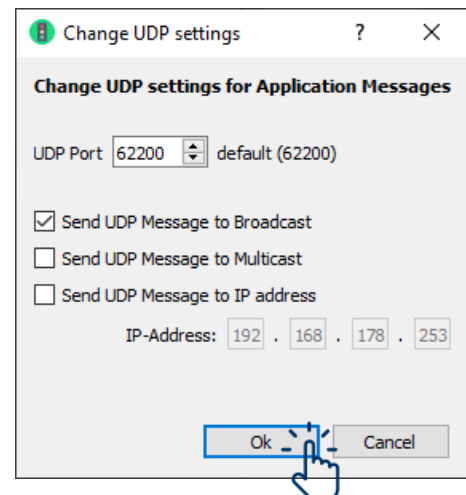
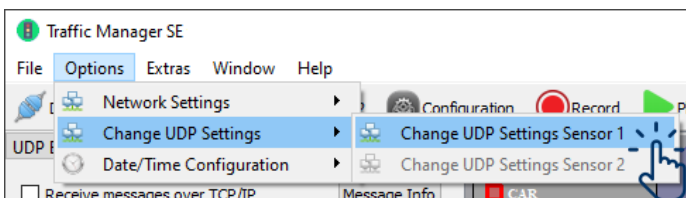

### 10.5 TCP /IP Settings

Event messages also can be received via TCP/IP with up to 5 clients. Port 62150 has to be used.

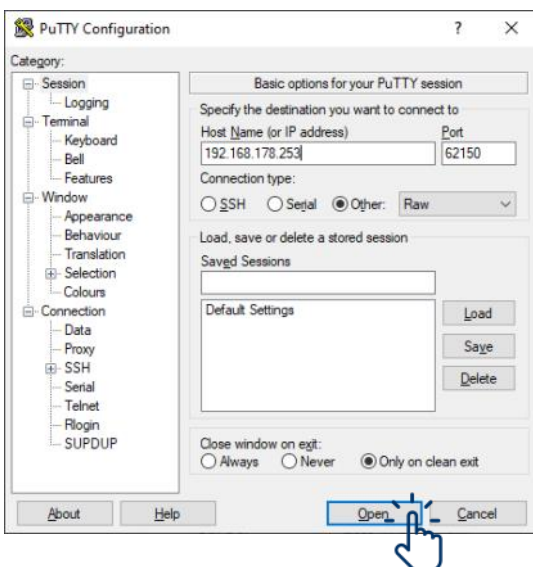

## 11. COMMUNICATION

The ITR-3800 communicates over TCP/IP, UDP and RS-485.

**Note:** To build your own application, there is an example project available in the software package. It includes configuring a system and requesting object lists.

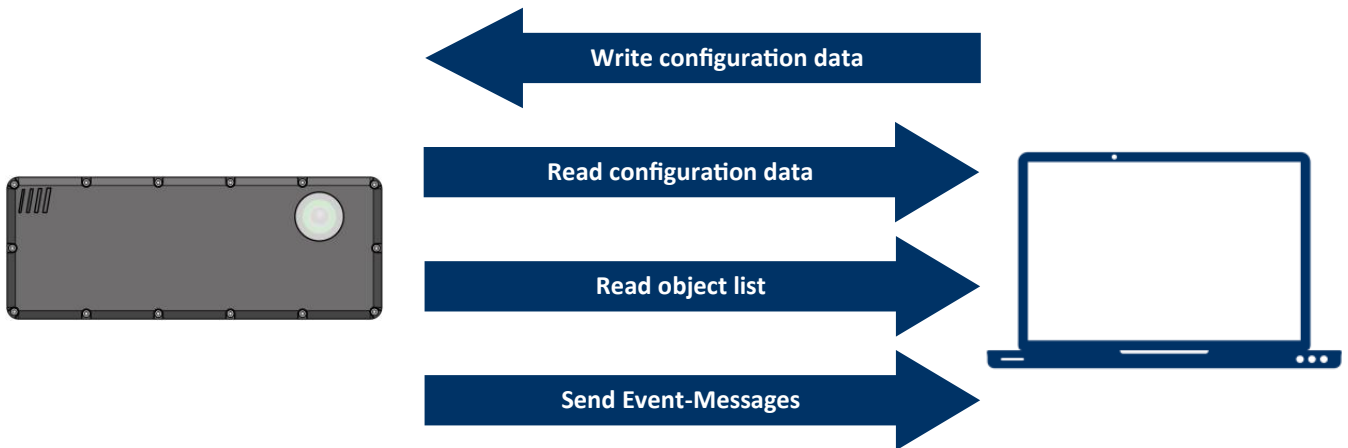

	ETHERNET (TCP/IP or UDP)	RS-485
<b>Transmitted Information</b>	<ul style="list-style-type: none"> <li>- Event Messages</li> <li>- Read and write configuration data</li> <li>- Object list (by request)</li> <li>- Camera Live Stream</li> <li>- Camera Still Image</li> </ul>	<ul style="list-style-type: none"> <li>- Event Messages</li> </ul>
<b>Settings</b>	<p>General used TCP/IP Ports: 60000—62200 (both directions)</p> <p>Used TCP/IP-Ports for event messages: 62150</p> <p>Used UDP-Ports for event messages: 62200 (default, changeable by user)</p>	<p>Baudrate: 115200 8N1</p>

## 11.1 Read/Write Configuration

For a proper signal processing, the configuration must be set carefully:

- Sensor position and height
- Event Zones and Ignore Zones

It is recommended to configure the system with InnoSenT's Traffic Manager software. This way configuration data can easily be written to the system. The configuration is explained in section [\[12\]](#) and a working example is provided in section [\[13.6\]](#).

The configuration data can also be manually set by using ITR-3800 Radar API. This library includes all functions for communication with InnoSenT systems.

## 11.2 Object List

Object lists are sent when requested by Radar API. InnoSenT's Traffic Manager software provides an easy way of displaying the received object lists. For further information on track parameters and how they are defined and calculated, please refer to Section [\[16\]](#).

PARAMETER	DESCRIPTION
Object ID	unique ID the tracker assigns to a track
Age Count	number of frames the track is alive after being released
Static Count	If an object gets static the static counter will be loaded with the maximum number of frames a track is allowed to be static before being deleted. Decrements every frame a track is static. tracks can only become static in Presence Zones.
Track Quality	The quality of the track. Depends on different attributes of the assigned target. track needs at least 50.0% quality to be released and visible. The quality is equitable with the reliability of the track.
Object Type Class	Assigned class of the track. Note: Objects of the class 'Others' will be displayed in the Traffic Manager as 'Cars'. 02 = others, 10 = non-motorized, 30 = car, 60 = small truck, 70 = big truck
Event Zone Index	Index of the Event zone the track is currently occupying. If the track is in no zone, the Index is negative. (-2 if track is outside of zone or -1 if zone is inactive). Active zones start with index zero.
Distance x [m]	distance the track has to the sensor in X direction (cartesian coordinates)
Distance y [m]	distance the track has to the sensor in Y direction (cartesian coordinates)
Velocity x [m/s]	velocity the track has in X direction (cartesian coordinates)
Velocity y [m/s]	velocity the track has in Y direction (cartesian coordinates)
Velocity in Direction [m/s]	velocity the track has in its direction
Direction x	direction the track has in X direction (cartesian coordinates), normalized to one
Direction y	direction the track has in Y direction (cartesian coordinates), normalized to one
Distance to front [m]	distance the Centroid of track has to front of track
Distance to back [m]	distance the Centroid of track has to back of track
Length of object [m]	length of object
Width of object [m]	width of object

### 11.3 Event Messages

Event messages are generated when an object enters a motion zone or an object gets static in a presence zone. Look up the corresponding section for information on how to set event zones.

Event messages are sent via Ethernet (UDP packets) and via RS-485.

The UDP messages are sent 'multicast' to all hosts in the subnet. Therefore, the host PC needs to open the specified port (see sec. Network Configuration) and listen to the message. The messages are specific ASCII strings dependent on the type and function of the event.

**Note:** You can also connect via TCP/IP on port 62150 to receive the event messages (max. 5 Clients).

#### 11.3.1 Zone Type Motion

This message will be sent each time an object enters an Event Zone of the type Motion Zone and one or more conditions are true.

Message information:

- Message Identifier (MZ)
- Time stamp (Timestamp: yyyy.MM.dd\_hh.mm.ss.ms)
- Zone Number
- Speed [kmh/mph] (Speed: 4 digit >> 2 digit + 2 digit behind decimal point), measured in km/h or mph
- Class (Class: 2 digit >> 02 = others, 10 = pedestrian/bike, 30 = car, 60 = small truck, 70 = big truck)
- Direction (0=Not assigned; 1=approaching; 2=receding)
- Custom configurable output number (0-255)
- Custom configurable phase number (0-255)
- ObjectID
- Estimated time of arrival (in seconds), if ETA point is set. Otherwise the value is 0.

**Example message:**

MZ;2017.07.28\_14.18.15.101;01;15.25;30;1;0;1;2;999;4.63\n

The diagram illustrates the structure of the example message string: MZ;2017.07.28\_14.18.15.101;01;15.25;30;1;0;1;2;999;4.63\n. Green arrows point from each field to its corresponding value:

- Message Identifier: **MZ (Motion Zone)**
- Time stamp: **2017.07.28\_14.18.15.101**
- Zone Number: **01**
- Speed: **15.25** [km/h or mph]
- Class: **30** = car
- Direction: **1**=approaching
- System State: **0**=no error
- Output Number: **1**
- Phase Number: **2**
- ObjectID: **999**
- Estimated time of arrival: **4.63** seconds



### 11.3.2 Zone Type Presence

This message will be sent each time there is a change of static object is in the Event Zone of the type Presence Zone and one or more conditions are true.

**Message information:**

- Message Identifier (PZ)
- Time stamp (Timestamp: yyyy.MM.dd\_hh.mm.ss.ms)
- Zone Number
- Queue length [m or feet] (3 digit), measured in meter or feet
- Number of static objects (2 digit)
- System State (0=no error; 1=error)
- Custom configurable Output Number (0-255)
- Custom configurable Phase Number (0-255)
- Number of pedestrians/bikes
- Number of cars
- Number of small trucks
- Number of big trucks

**Example message:**

PZ;2017.07.28\_14.18.15.101;01;015;02;0;1;2;0;2;0;0\n

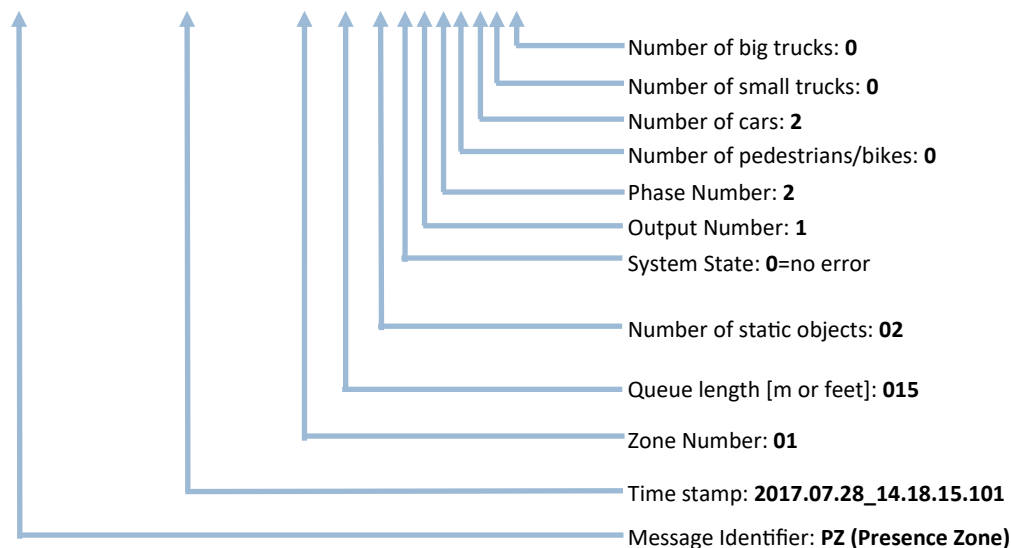

## 12. CONFIGURATION USING TRAFFIC MANAGER SE

The Traffic Manager is the primary software solution to configure the ITR-3800 for use in the field.

### 12.1 Installation of Traffic Manager SE

The Traffic Manager SE can only be installed on a Windows PC. The setup files can be found in the device's software package. Please ask your InnoSenT contact for information on how to receive the software package.

Open the Traffic Manager SE setup executable in the software package and install by following the instructions on the screen.

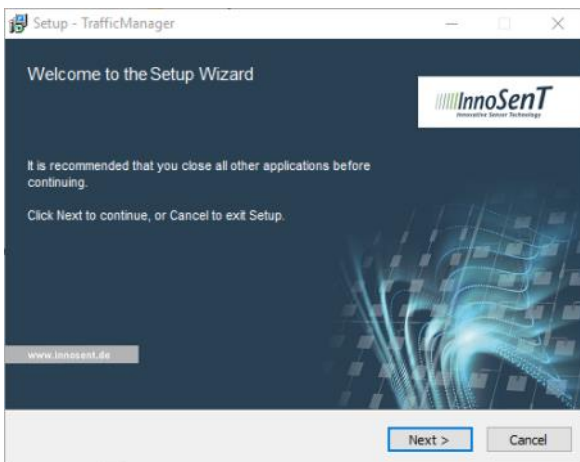

### 12.2 Overview of Traffic Manager SE

InnoSent’s Traffic Manager SE is a software solution to configure your ITR-3800 when installed in the field and visualize the data output from the system (i.e. object list and UDP event messages). The most important features are highlighted below.

The screenshot shows the Traffic Manager SE interface with several callout boxes highlighting key features:

- Configuration wizard**: A callout pointing to the 'Configuration' tab in the top menu.
- Record & Playback object list with video stream**: A callout pointing to the 'Record' and 'Playback' buttons in the top menu.
- Read configuration from system**: A callout pointing to the 'Read Configuration from System' button in the top menu.
- Create & Remove Heatmap**: A callout pointing to the 'Create Heatmap' and 'Remove Heatmap' buttons in the top menu.
- Connect to one or two ITR-3800 sensors**: A callout pointing to the 'Connect Sensor 1' and 'Connect Sensor 2' buttons in the top menu.
- Display of UDP Event Messages**: A callout pointing to the 'UDP Event Messages' window.
- Event Message Results: - counting - classification**: A callout pointing to the 'Event Message Results' table.
- Object list from up to two sensors**: A callout pointing to the 'Objectlist' table at the bottom.
- Display video stream from internal or external cameras**: A callout pointing to the 'Camera' window.
- Display sensor information**: A callout pointing to the 'Sensor Information' window.
- Change view settings**: A callout pointing to the 'View Settings' window.
- Display background image, event zones and tracked objects**: A callout pointing to the main radar visualization area.

### 12.3 Connect to Camera Stream

Connect to video stream of internal camera of ITR-3800 or external camera via RTSP stream.

In ‘Record Mode’ the video stream from the camera is stored together with the radar data on the hard disk. Therefore, it is possible to evaluate data offline.

**Note:** It is recommended to use the internal camera of ITR-3800, to avoid obscurities between orientation of sensor and external camera.

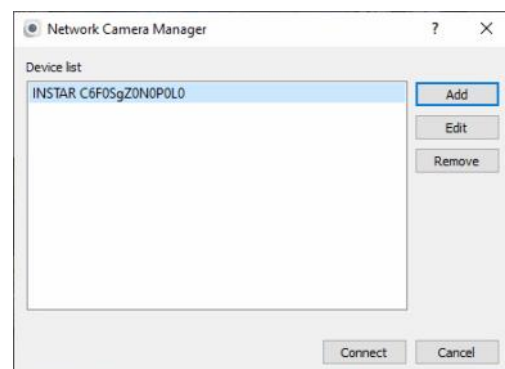
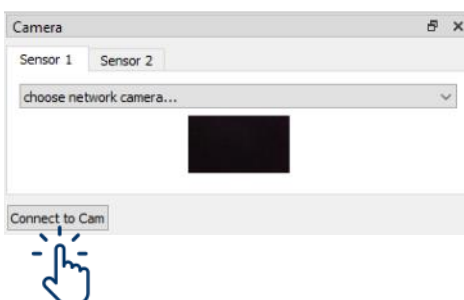

### 12.4 Connect to ITR-3800

If the Traffic Manager is not already connected to the system, establish a connection by clicking on the 'Connect' button. For further information, recall section [10].

### 12.5 Configuration Wizard

The ITR-3800 can be easily configured using the Traffic Manager. Open the configuration wizard by clicking on the 'Configuration' button. Here you will be guided through all steps necessary to configure the ITR-3800 for your application. Below, the welcome screen and the overview of the configuration process are shown. With 'Next' you can navigate through the different configuration menus.

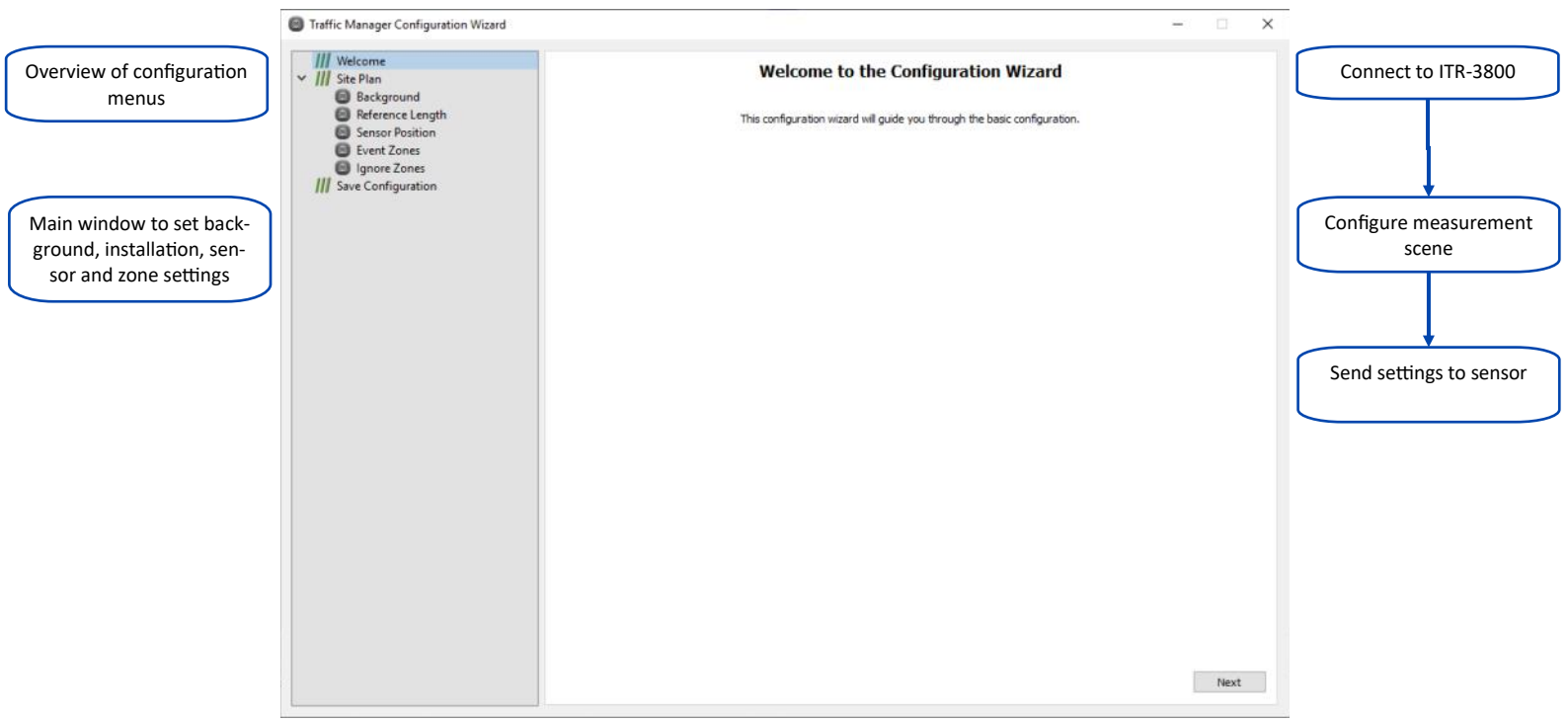

### 12.5.1 Background

In the Background Menu an image of the scenery can be loaded. This is the basis for positioning your sensor and defining the event zones for your application.

Option 1: Load a .jpg file or .png file from your hard drive.

Option 2: Open Google Maps with the built-in map viewer and capture the image for scenery configuration. The image is then automatically loaded into the scenery.

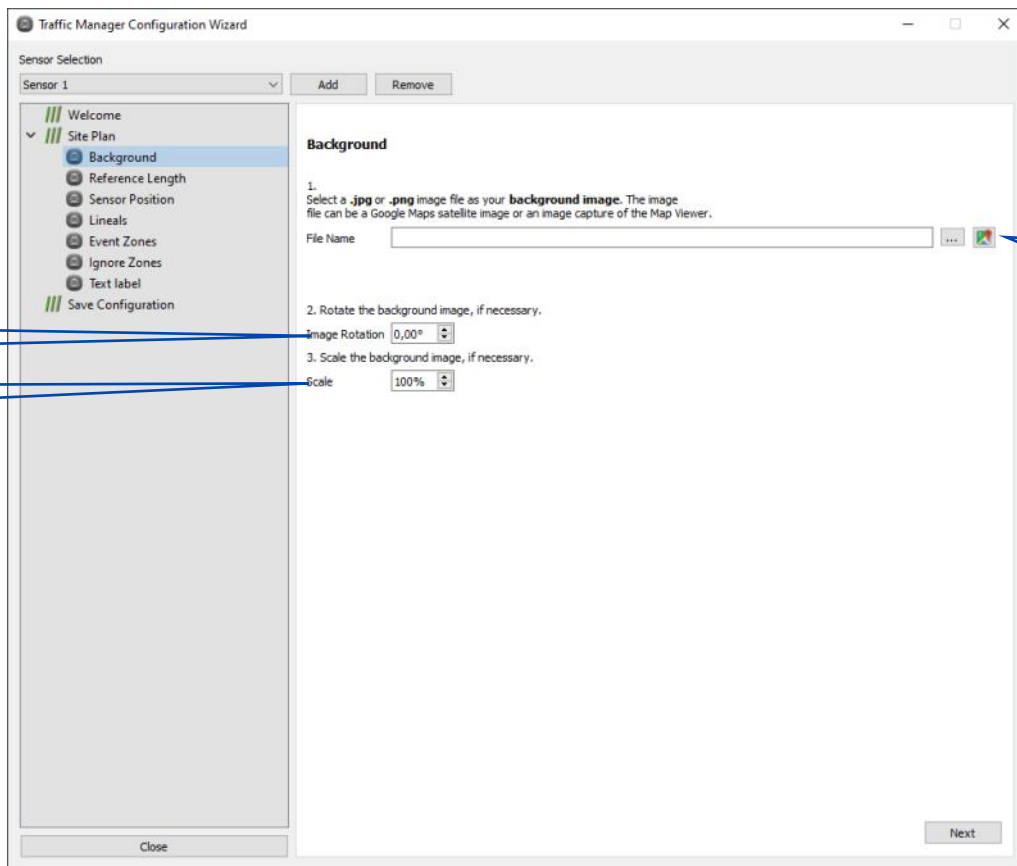
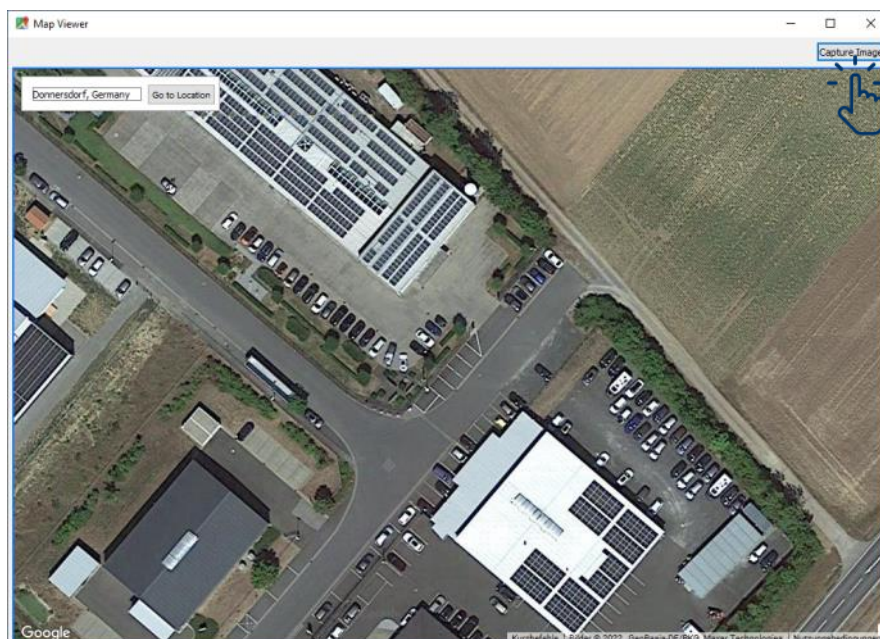

Image rotation

Image scaling

Built-in map viewer



Capture image for configuration

### 12.5.2 Reference Length

The Traffic Manager needs a reference length in the background image. If the length is not set correctly, measured objects and radar coverage do not match to the image. As a consequence the set event zones will not work as expected. You can either measure the distance between two points by yourself or use Google Maps built-in functionality.

Place the ends of the displayed red line where you measured the distance in the image and type in the appropriate length of the line.

**Note:** If you have imported the image via the built-in map viewer, the reference length is set automatically.

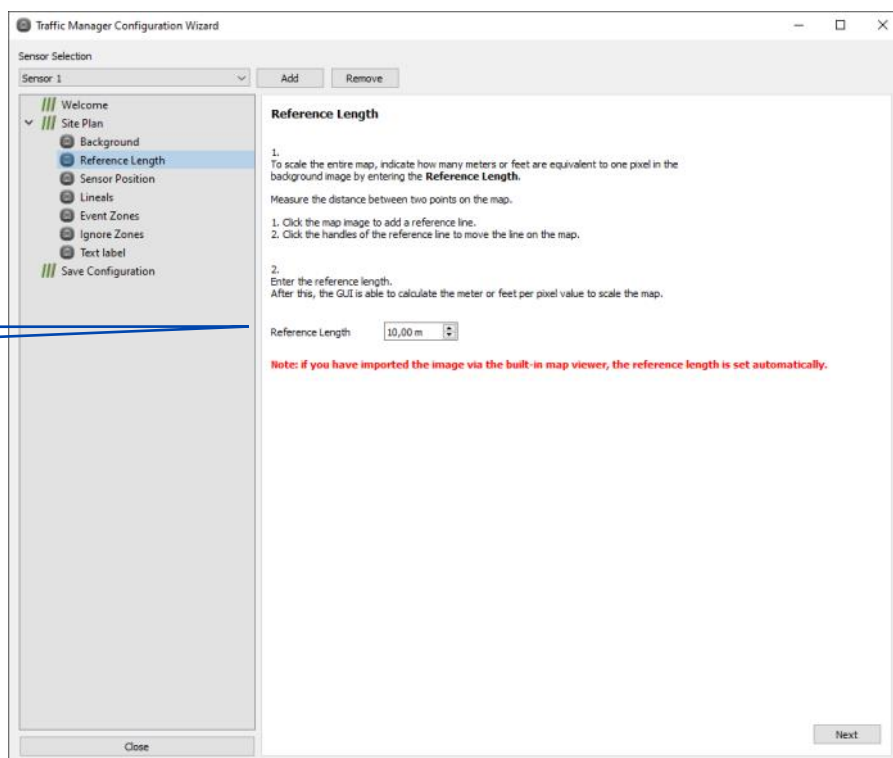
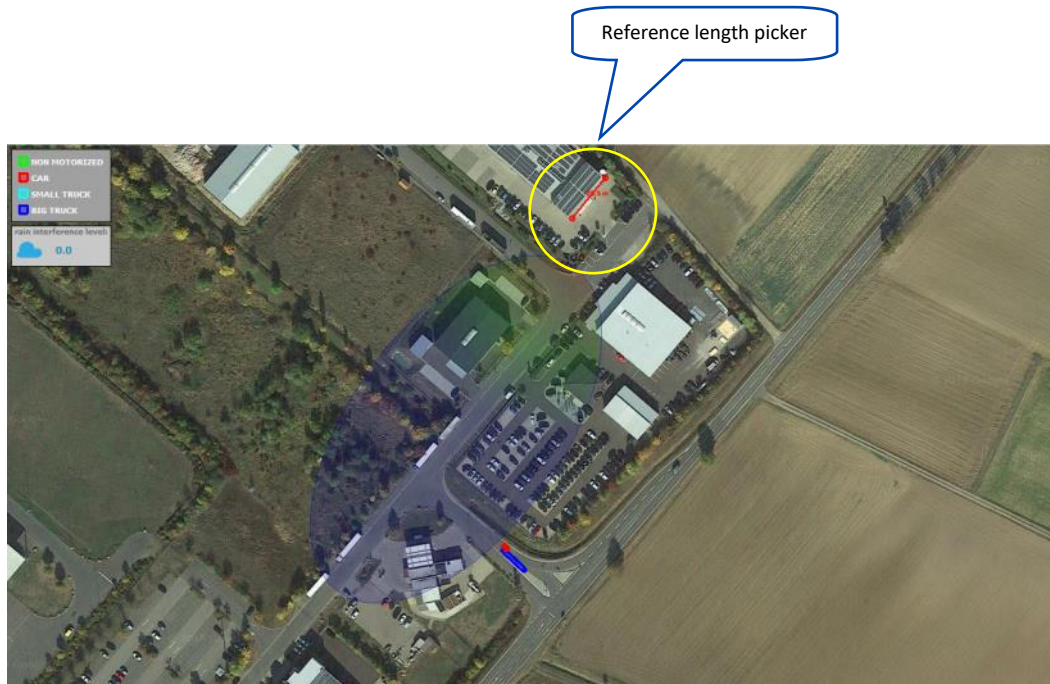

### 12.5.3 Sensor Position

Use Up/Down and Left/Right Buttons to place the sensor's virtual position (red point) in the background image to the exact location where the ITR-3800 is installed. Then, set the installation height. The elevation angle will be read from the sensor and corrected by the road gradient angle.

**Hint:** First set a rough step size and then a fine one.

**Note:** If you use more than one sensor, each sensor has to be set on a different frequency channel.

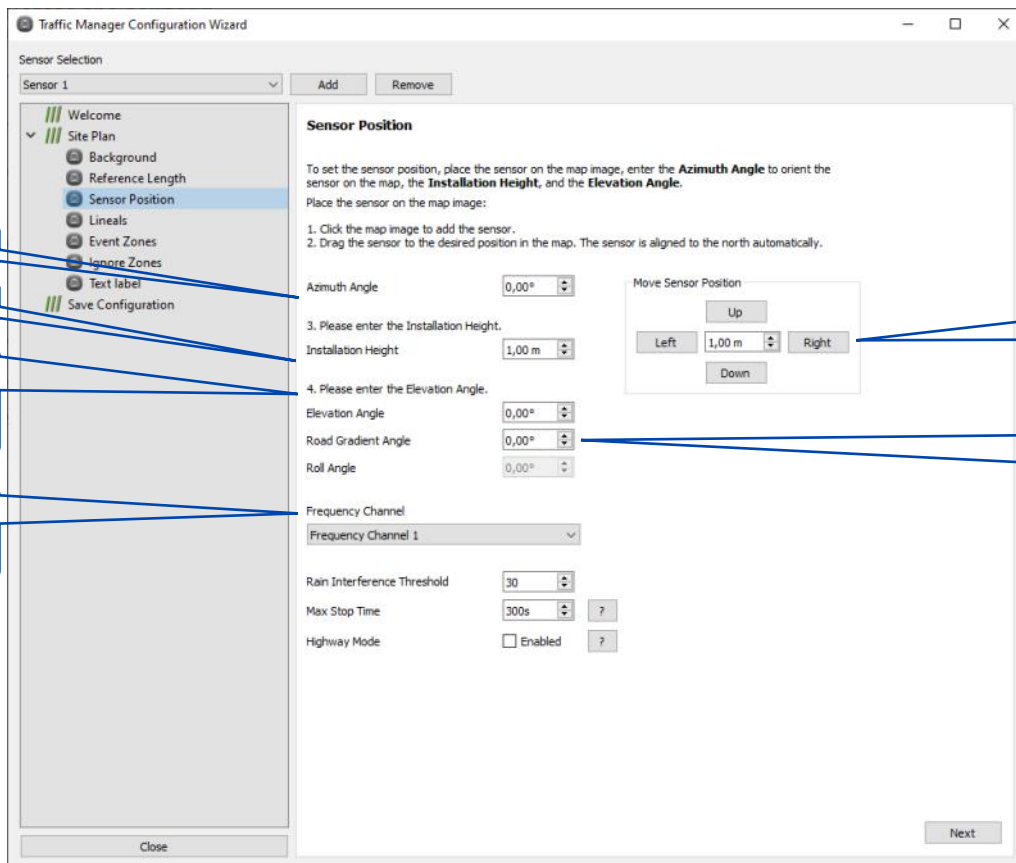

You can use the "Create Heatmap" function to display the object trajectories in the background image (green lines). Check whether the displayed objects match the real objects movement. Adjust the parameters sensor position, azimuth angle (to rotate the sensor beam) and reference length until they match each other.

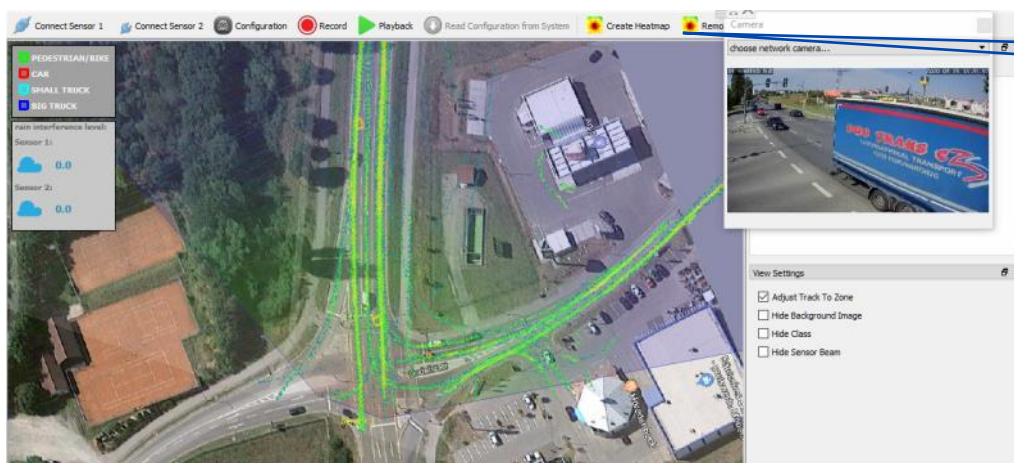

### 12.5.4 Lineals

Lineals can be used to visualize distances in the configuration.

**Note:** Lineals don't have any effect on event messages, zones or tracking.

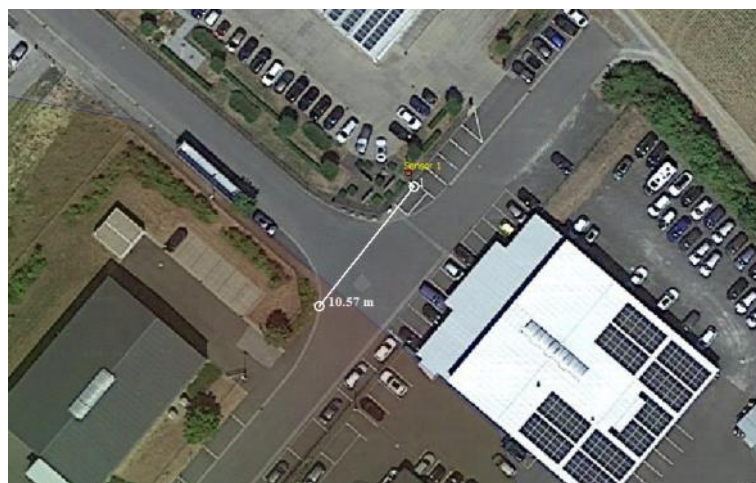
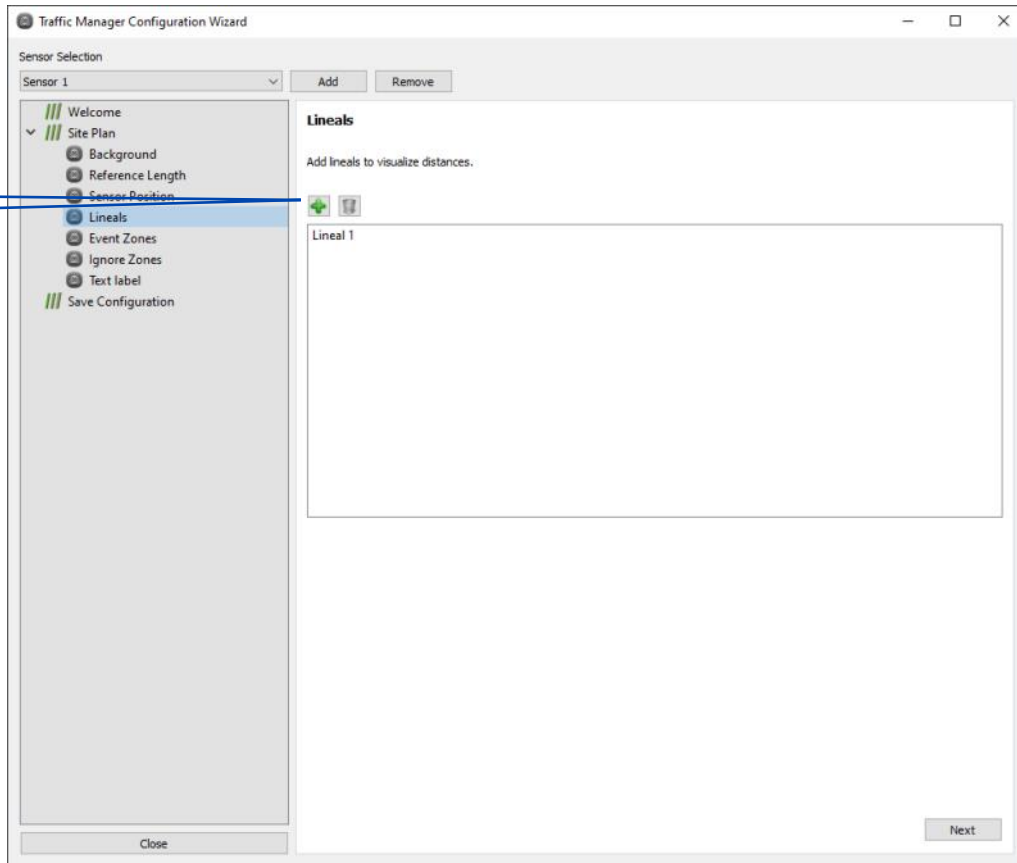



### 12.5.5 Event Zones

Event zones are defined to generate event messages when an object is located within this zone. Further, you can add conditions. This will help you to only get messages for the condition you want (speed, class, direction...).

Event zones can be added in the event zone menu. Afterwards, the desired zone type can be selected. Place the event zone in the background image. The shape of the event zone can be adjusted by adding some points.

There are three types of zones:

- **Motion Zone:** A message will be sent each time an object enters an event zone and for every true condition defined for this zone.
- **Presence Zone:** A message will be sent each time at least one static object is in the event zone. Only in presence zones objects will become static. This zone is optimized for calculating a queue length.
- **Sidewalk Zone:** This zone is for classification (pedestrian/bike) only and will not generate event messages. Use this zone type to define your sidewalks for pedestrian/bike classification.

**Hint:** Left mouse double click on the lines of the event zone to add more points (max. 10) or remove points with right mouse click.

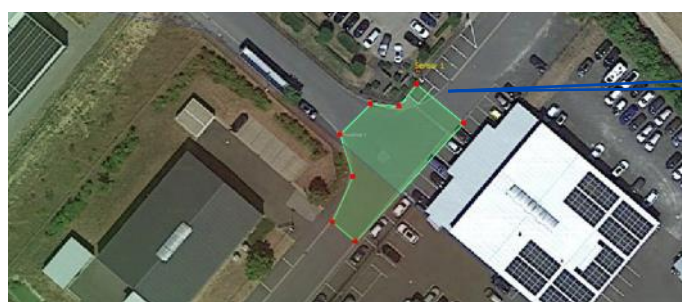
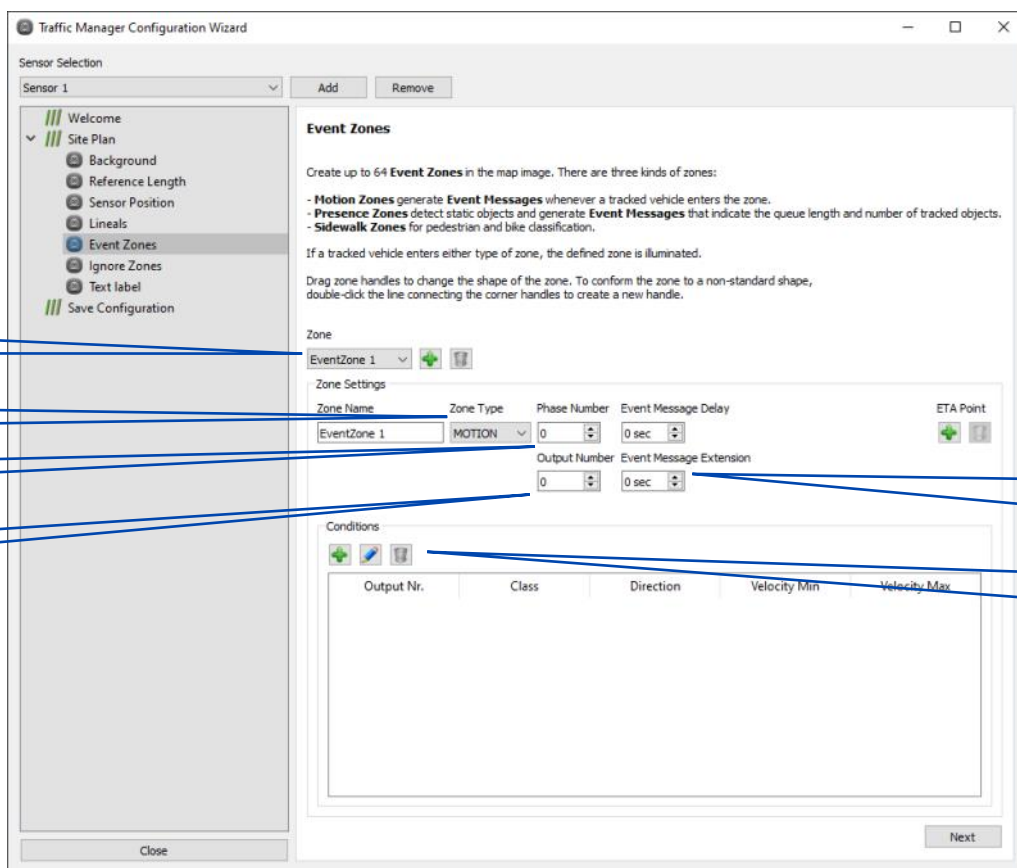

<sup>6</sup> output in event message; not used internally

### 12.5.6 ETA - Estimated time of arrival

To enable the ETA calculation, please add the ETA point for a motion zone.

If a object enters the zone, the distance between the object and the ETA point will be calculated. With the help of the object speed, the arrival time can now be calculated in seconds. You will receive the output via the event message.

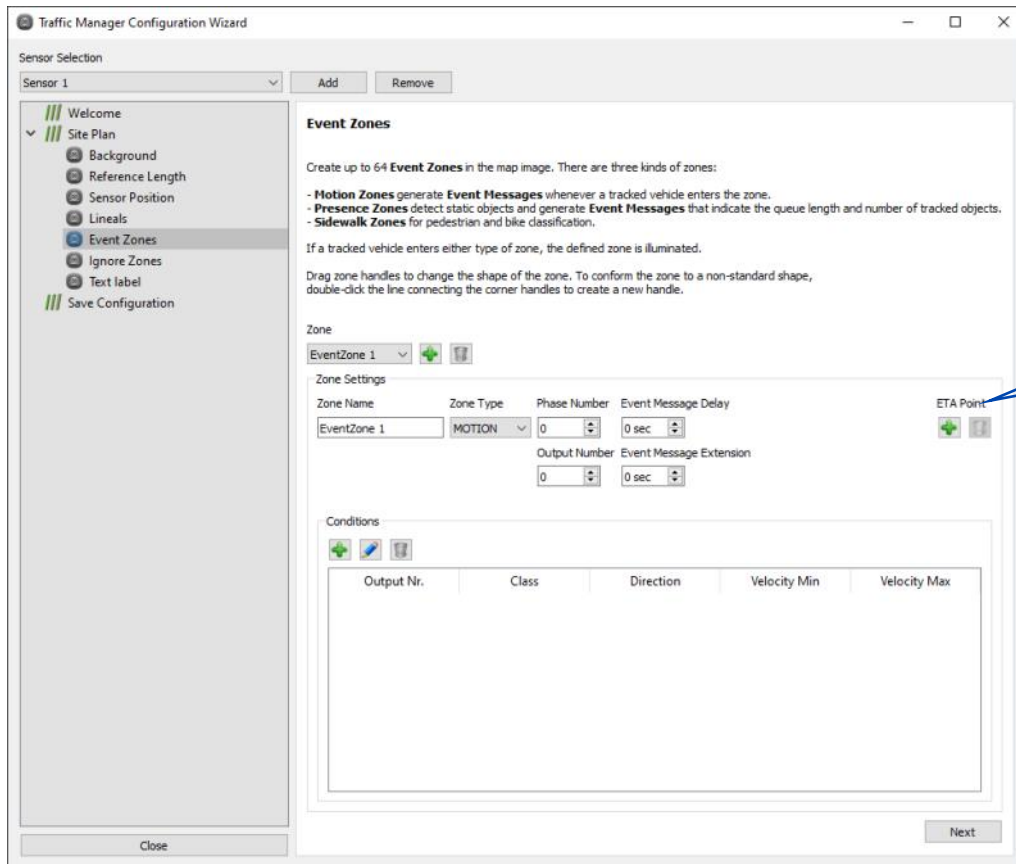

### 12.5.7 Ignore Zones

You can define regions where objects shall not initialize new tracks.

Place an ignore zone in the background image. The shape of the ignore zone can be adjusted adding some points. Left mouse double click on the lines of the ignore zone to add more points (max. 10) or remove points with right mouse click.

**Note:** Already existing tracks can move through an ignore zone without being harmed.

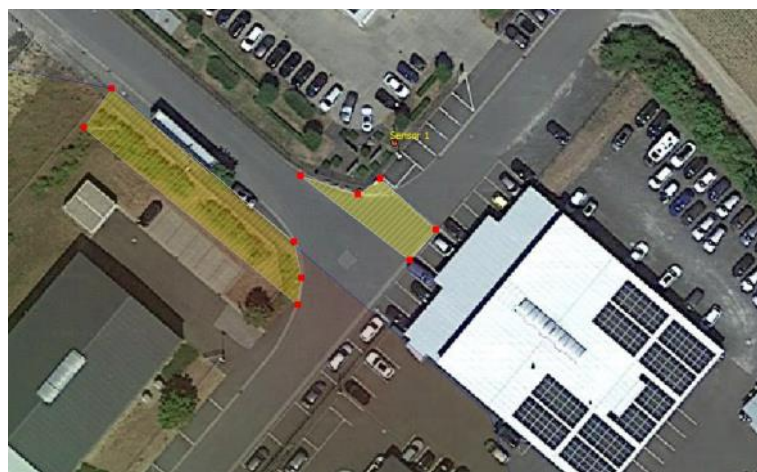
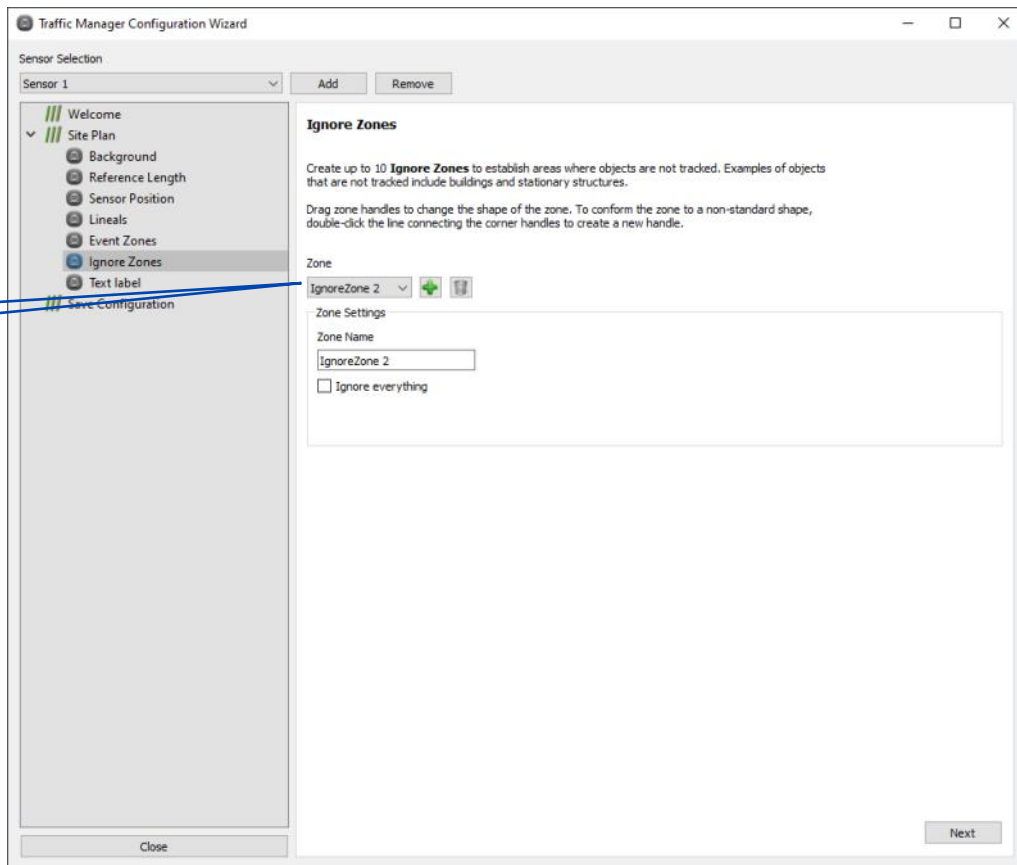

### 12.5.8 Text label

A text label can be used as a marking in the plot.

Its position is adjustable by dragging the red dot in the plot next to the text label. They have standard rich text options and can be rotated.

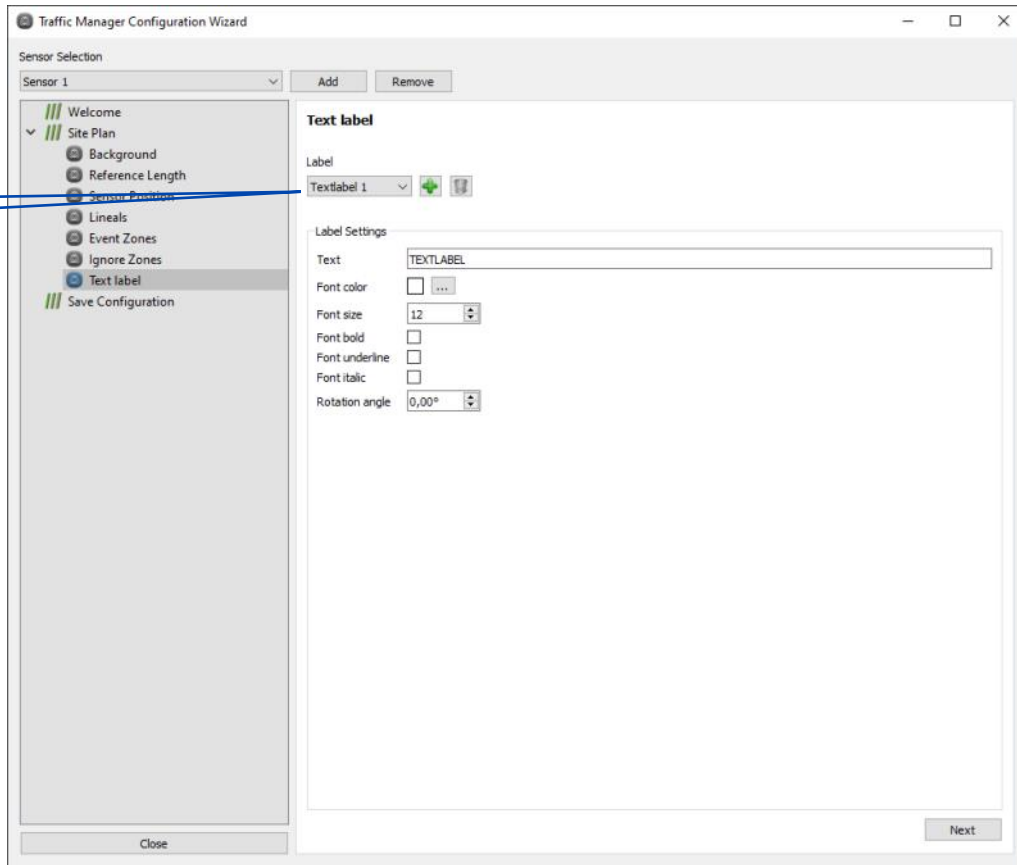

### 12.6 Save Configuration

In this menu, the parameters defined in the Configuration Wizard are sent to the sensor and measurement mode is started. After the configuration is sent to the sensor, tracks from objects are displayed in the background image.

**Hint:** To change the current configuration in the future it is recommended to save the settings to a file on your PC. This can be done in the file menu of the Traffic Manager SE.

The file stored is an .iprj File. For an offline evaluation of recorded data, this .iprj file needs to be loaded first. Thus, make sure to have an up-to-date .iprj file available for playback.

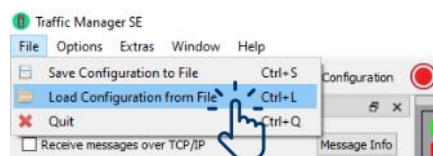
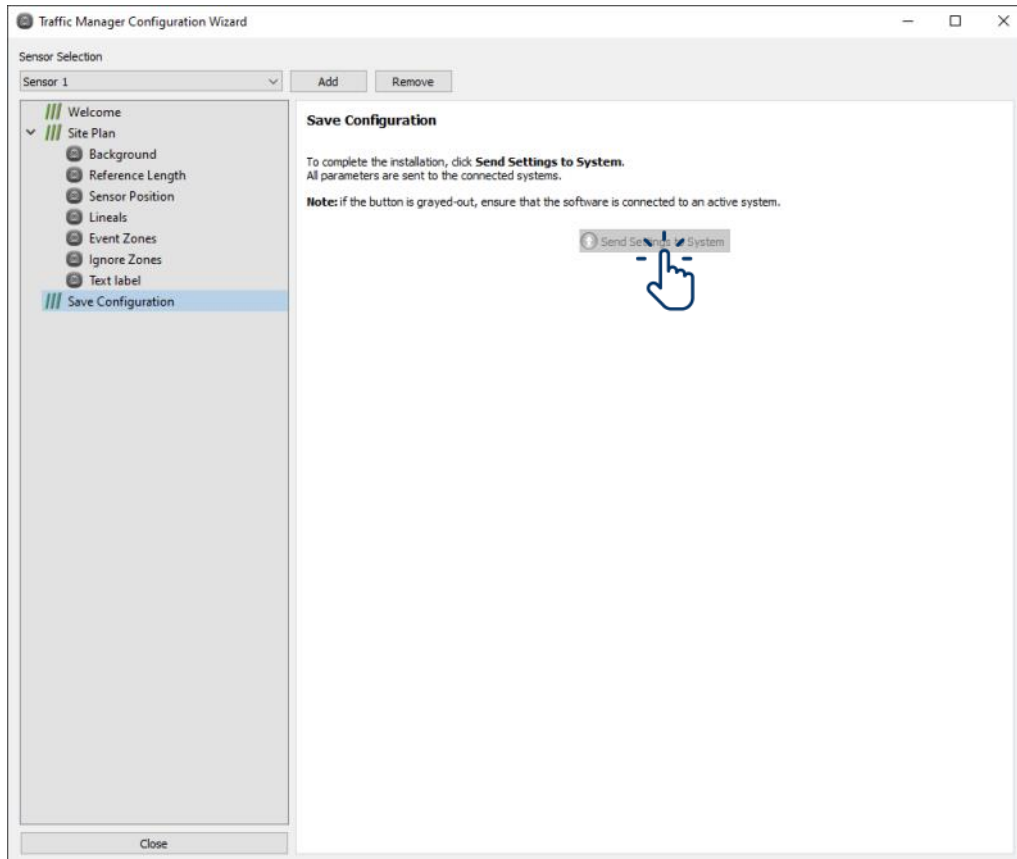

## 12.7 View Settings

The View Settings window comprises checkboxes for enabling or disabling various options which control the objects and tracks displayed in the background image.

In detail:

- **Adjust Track to Zone**  
Adjusts a track to the middle of a presence zone
- **Hide Background Image**  
If enabled: The background image is not shown.
- **Hide Class**  
If enabled: Hides the class of the track. Every track is displayed as class 30 = car.
- **Hide Sensor Beam**  
If enabled: The sensor beam is not shown.

### 12.8 Record / Playback

The Traffic Manager SE is capable of recording target lists and a video stream. Click the 'Record' button to start recording and click it again to save recorded target lists and video stream to a file. While recording is active, the ongoing tracks, objects and video stream can not be observed.

To play back recorded data, click the 'Playback' button and select the appropriate data file.

Attention: After loading recorded data from a file, matching configuration settings must be sent (please see sec. [Save Configuration](#)).

Tracking will be disturbed when rewinding playback.

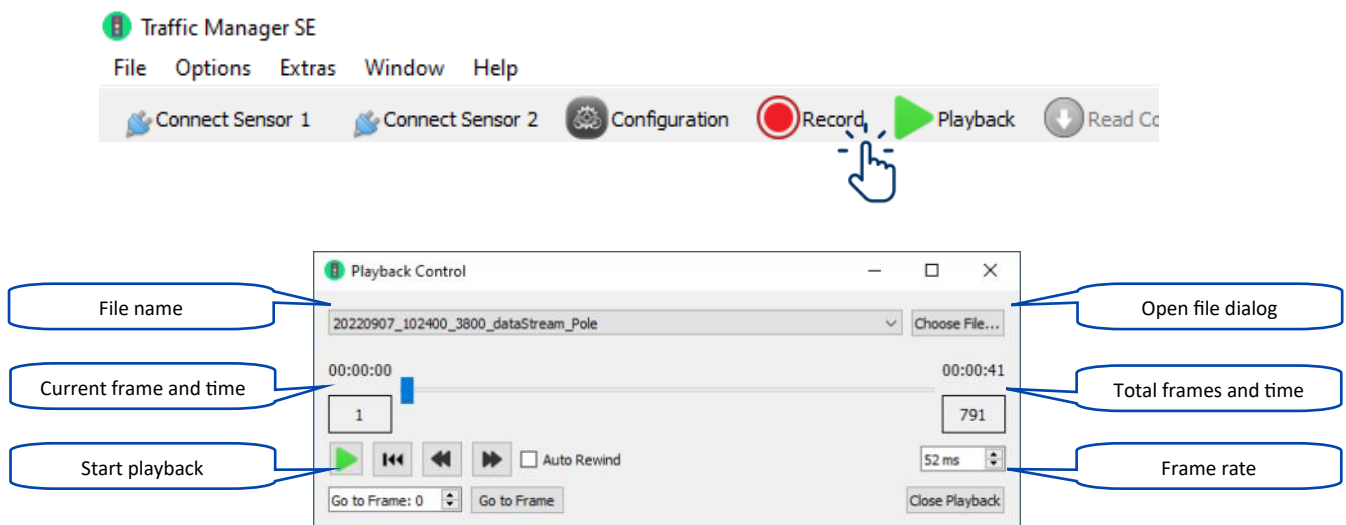

### Playback on System

The ITR-3800 provides you to upload a recorded playback file to the system (max. size 3GB).

After uploading, you are able to activate the playback. Your playback file will be played in a loop on the system.

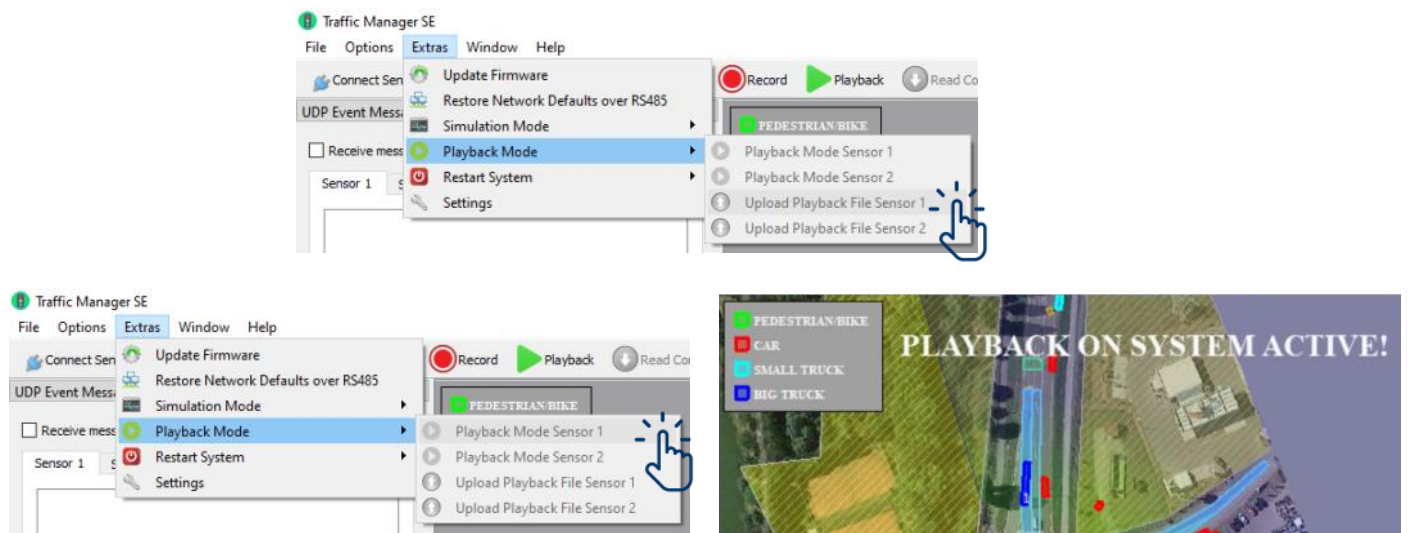

### 12.9 Update Firmware

Select a firmware update file, set the sensor's IP address and click the OK button to start the firmware update.

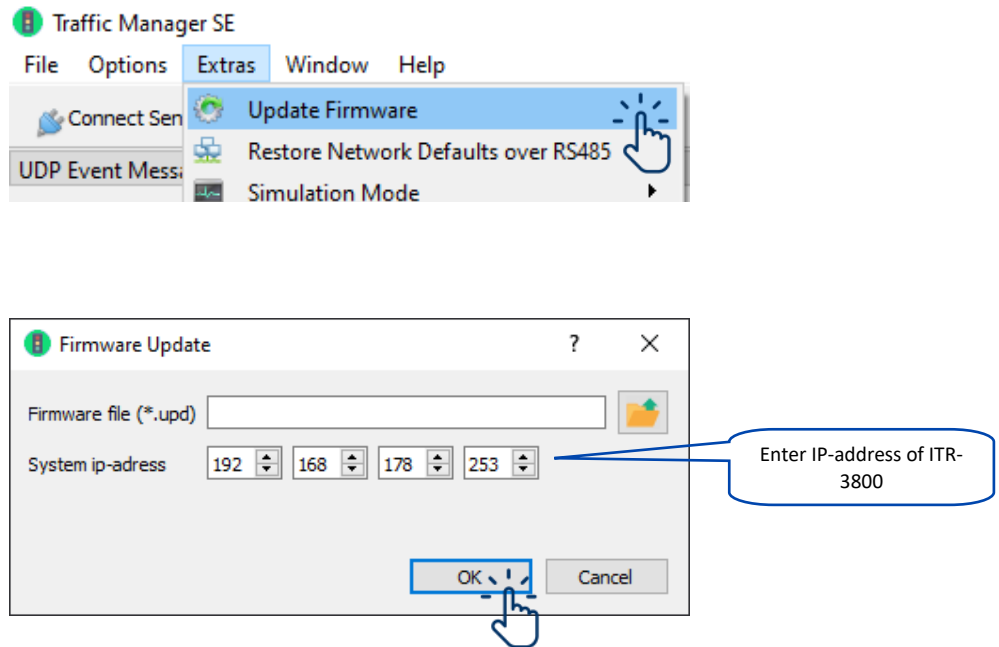

### 12.10 Restore Network Settings

With the 'Restore Network Defaults over RS485' you can reset your network to the default configuration.

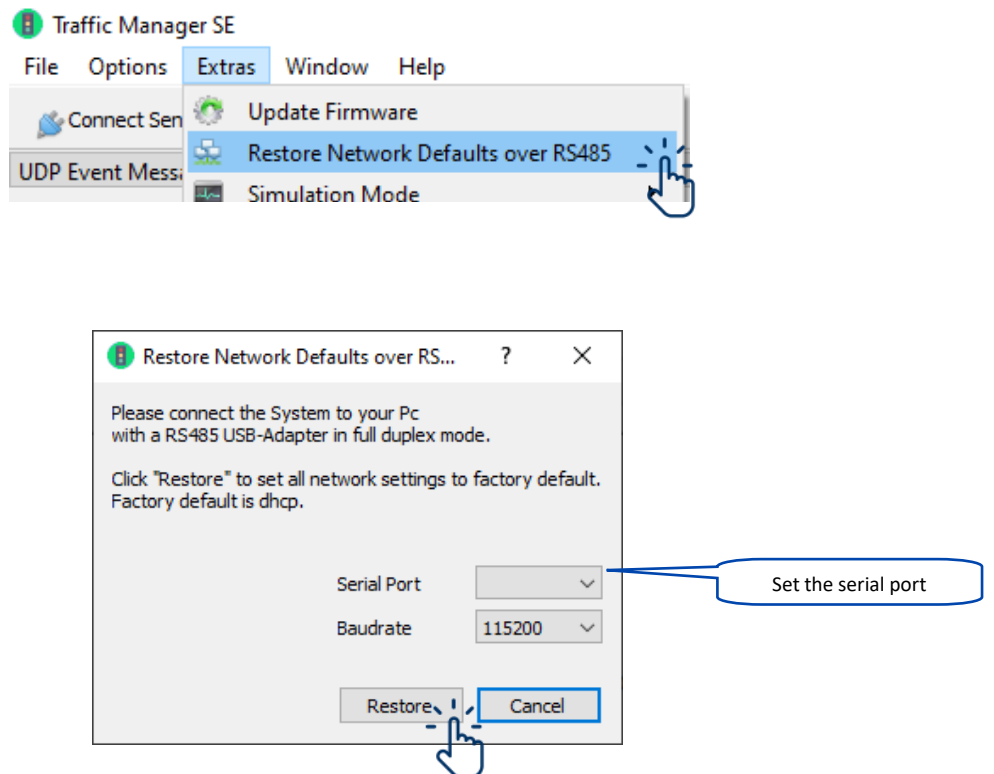



### 12.11 Object List in Traffic Manager

The Traffic Manager also provides an object list, but it does not contain as much information as the object list provided by the Radar API.

**Note:** Green tracks are receding, red tracks are approaching and black tracks are static.

Objectlist							
Sensor 1    Sensor 2							
	Object ID	Quality	Distance X (m)	Distance y (m)	Object Type	Velocity in Direction (km/h)	Zone
1	31414	58,4371	-5,92253	38,6496	30	0	2
2	31442	84,2461	38,497	46,131	30	31,5149	3
3	31440	52,9384	24,5629	31,6283	30	6,33817	4
4	31417	23,5478	19,4958	28,8874	30	0	4
5	31415	27,0422	-4,1404	33,7672	30	0	2
6	31430	44,1608	-11,2363	53,2295	30	0	2
7	31446	78,8675	-18,6232	85,1621	30	41,5463	

### 13. TRAFFIC APPLICATION IMPLEMENTATIONS

The three different event zone types in combination with one or more conditions allow the user a quick and comfortable configuration of complex traffic situations.

By exploiting these three event zone types many different applications are possible to implement. An overview of typical traffic applications is given below.

APPLIED EVENT ZONE	TRAFFIC APPLICATION	OBTAINABLE INFORMATION FROM ITR-3800	PRACTICAL USAGE
<b>Presence Zone</b>	Queue Length	<ul style="list-style-type: none"> <li>- Queue length of stationary objects in zone of interest</li> <li>- Number of stationary objects in zone of interest</li> </ul>	Traffic light management: <ul style="list-style-type: none"> <li>- Dynamic control of green light duration</li> <li>- Green light signal priorities</li> </ul> ⇒ <b>Optimize traffic flow</b>
	Stop Bar Detection	<ul style="list-style-type: none"> <li>- True presence of stationary objects in zone of interest in front of Stop Bar</li> </ul>	Traffic light management: <ul style="list-style-type: none"> <li>- Trigger for calling green light</li> </ul> ⇒ <b>Optimize traffic flow</b>
<b>Motion Zone</b>	Advance Detection	<ul style="list-style-type: none"> <li>- Speed of moving objects entering zone of interest</li> </ul> ⇒ Estimated Time of Arrival (ETA) to Stop Bar can be calculated	Traffic light management: <ul style="list-style-type: none"> <li>- Dynamic control of yellow light duration at dilemma zones</li> </ul> ⇒ <b>Minimize risk of collision at dilemma zones</b>
	Wrong Way Detection	<ul style="list-style-type: none"> <li>- Moving direction and speed of objects entering zone of interest</li> </ul>	Wrong Way Detection: <ul style="list-style-type: none"> <li>- Trigger alert by detection of moving objects in wrong way</li> </ul> ⇒ <b>Identify and minimize risk due to wrong way driving</b>
	Traffic Counting	<ul style="list-style-type: none"> <li>- Number, type and speed of moving objects entering zone of interest</li> </ul>	Traffic statistics: <ul style="list-style-type: none"> <li>- Counting and classifying objects on highway or arterial roads</li> </ul> ⇒ <b>Calculate traffic flows, traffic average speed</b>

On the following pages an example configuration is shown for each different Traffic Application.

**Note:** Two or more different applications can be easily solved by using a combination of different zone types. The zones are even allowed to overlap, for a full and easy coverage of all applications.

A combination of up to 4 sensors can be deployed to cover all approaches of an intersection. The deployed sensors can be set to operate at different frequency channels to avoid mutual interferences.

### 13.1 Queue Length

The ITR-3800 is capable of measuring queue length and number of stationary objects in the zones of interest at intersections for controlling traffic lights e.g. dynamic green light duration and optimizing traffic flow.

The application is realized by using ITR-3800 Presence Zones. The fast and easy configuration of zones is shown in section [12.6.5]. After having the presence zones set and sent to the system, the ITR-3800 will send the user UDP event messages every time the presence zones are triggered. The messages are displayed in the UDP Event Messages Window (top left) and the corresponding queue length will be shown in the Event Message Results Window (middle left).

**Note:** It is important to make sure that each defined Presence Zone should only cover one single lane. For measuring queue lengths on multiple lanes multiple Presence Zones must be used. Queue Length works correctly only with oncoming traffic.

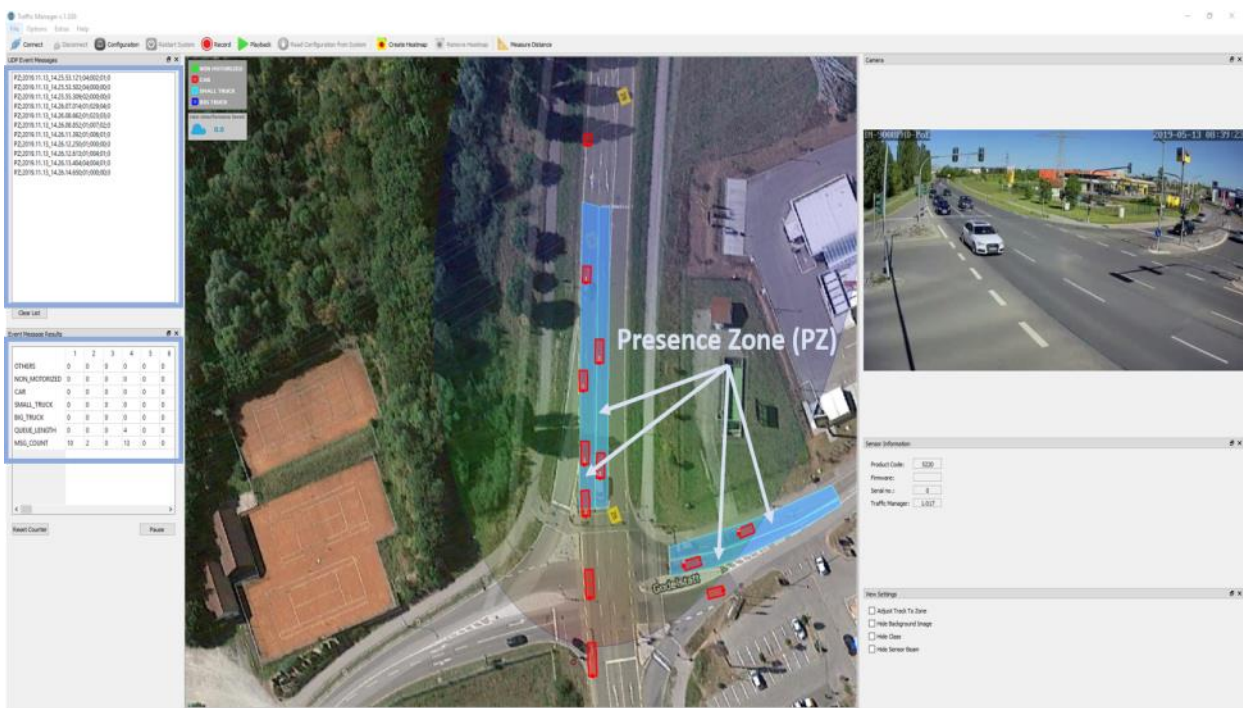

INSTALLATION PARAMETER	MINIMUM	TYPICAL <sup>1</sup>	MAXIMUM	UNIT
Traffic Direction		approaching		
Height	4   13	6   19	8   26	m   ft
Elevation Angle	-10	-7	0	°
Angle to Lane	-60	6	60	°
Queue Length	20   65		80   262	m   ft

### 13.2 Stop Bar Detection

The ITR-3800 is capable of detecting the presence of stationary objects in call zones in front of stop bars. True presence of stationary objects can be tracked even if they are shadowed by cross traffics. The information can be used for controlling traffic lights e.g. to trigger a call for green light signal.

The application is realized by using ITR-3800 Presence Zones. The fast and easy configuration of zones is shown in section [12.6.5]. After having the presence zones set and sent to the system, the ITR-3800 will send the user UDP event messages every time the presence zones are triggered. The messages are displayed in the UDP Event Messages Window (top left) and the corresponding queue length will be shown in the Event Message Results Window (middle left).

Note: It is important to make sure that each defined Presence Zone should only cover one single lane. For measuring queue lengths on multiple lanes multiple Presence Zones must be used. For Stop Bar Detection, the presence zone should be at least as big as a vehicle, but not bigger than two. Minimizing the presence zone to a trigger line, as well as enhancing it to a queue length presence zone, will lead to a poor performance. Stop Bar Detection and its true presence detection feature works correctly only with oncoming traffic.



INSTALLATION PARAMETER	MINIMUM	TYPICAL <sup>1</sup>	MAXIMUM	UNIT
Traffic Direction		approaching		
Height	4   13	6   19	8   26	m   ft
Elevation Angle	-10	-7	0	°
Angle to Lane	-60	6	60	°
Stop Bar Detection	20   65		40   131	m   ft

### 13.3 Advance Detection

The ITR-3800 is capable of measuring the speed of moving objects entering a defined zone located at a distance away from the stop bar. This information can be used to calculate the Estimated Time of Arrival (ETA) of moving objects at the stop bar. The ETA then can be used for controlling traffic lights e.g. dynamical yellow light duration to minimize risk of collision at dilemma zones.

The application is realized by using ITR-3800 Motion Zones. The fast and easy configuration of zones is shown in section [12.6.5]. After having the motion zones set and sent to the system, the ITR-3800 will send the user UDP event messages every time the motion zones are triggered. The messages are displayed in the UDP Event Messages Window (top left) and the corresponding trigger count will be shown in the Event Message Results Window (middle left).

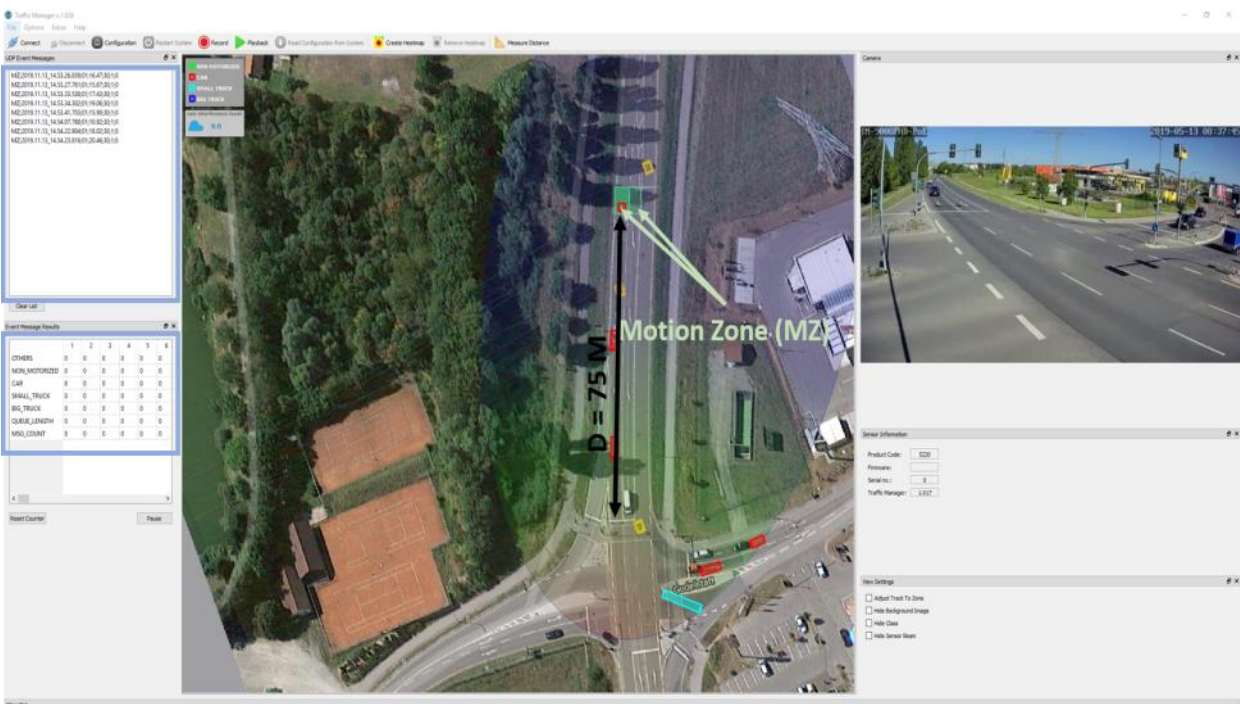

INSTALLATION PARAMETER	MINIMUM	TYPICAL <sup>1</sup>	MAXIMUM	UNIT
Traffic Direction		approaching		
Height	4   13	6   19	8   26	m   ft
Elevation Angle	-10	-7	0	°
Angle to Lane	-60	6	60	°
Advance Detection	30   98		200   656	m   ft

### 13.4 Wrong Way Detection

The ITR-3800 is capable of capturing the moving direction of objects entering a defined zone. This information can be used to detect wrong way drivers and minimize the risk of incidents e.g. on highway or arterial roads.

The application is realized by using ITR-3800 Motion Zones. The fast and easy configuration of zones is shown in section [12.6.5]. After having the motion zones set and sent to the system, the ITR-3800 will send the user UDP event messages every time the motion zones are triggered. The messages are displayed in the UDP Event Messages Window (top left) and the corresponding trigger count will be shown in the Event Message Results Window (middle left).



INSTALLATION PARAMETER	MINIMUM	TYPICAL <sup>1</sup>	MAXIMUM	UNIT
Traffic Direction		approaching		
Height	4   13	6   19	8   26	m   ft
Elevation Angle	-10	-7	0	°
Angle to Lane	-60	6	60	°
Wrong Way Detection	30   98		200   656	m   ft

### 13.5 Traffic Counting

The ITR-3800 is capable of counting and classifying moving objects entering a defined zone. This information can be used for traffic statistics e.g. monitoring traffic flows, average speed on arterial roads.

The application is realized by using ITR-3800 Motion Zones. The fast and easy configuration of zones is shown in section [12.6.5]. After having the motion zones set and sent to the system, the ITR-3800 will send the user UDP event messages every time the motion zones are triggered. The messages are displayed in the UDP Event Messages Window (top left) and the corresponding trigger count will be shown in the Event Message Results Window (middle left).

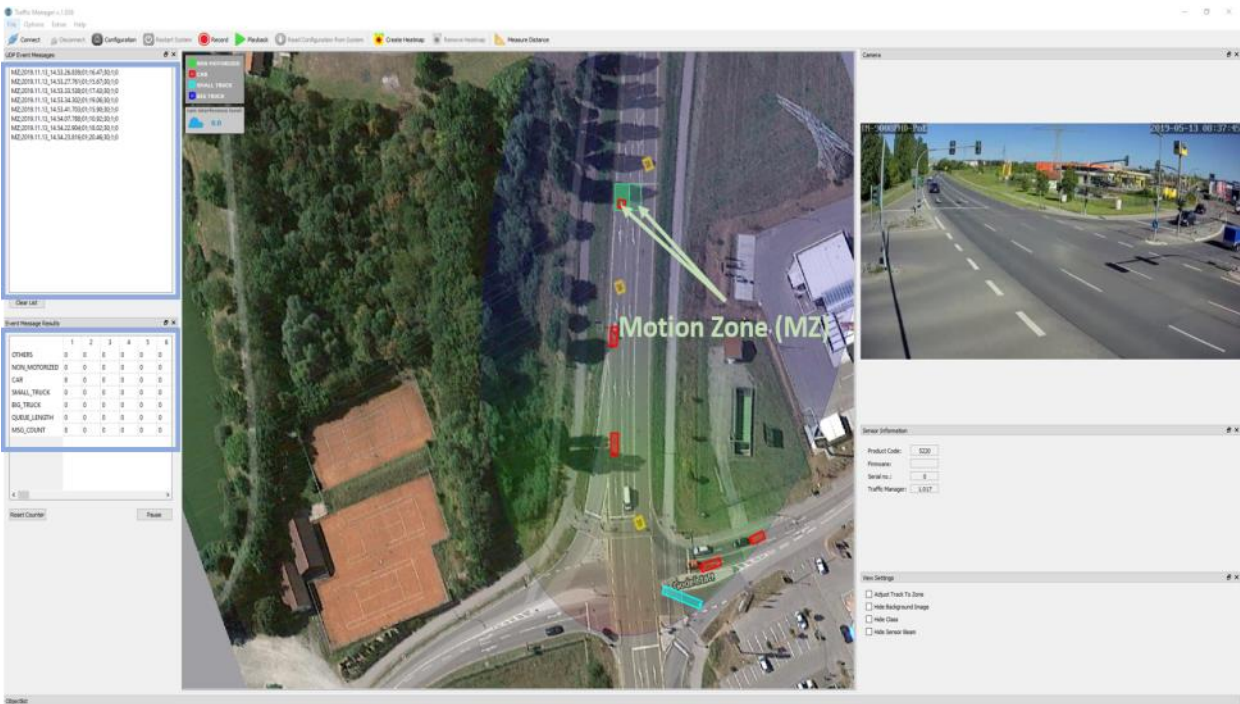

INSTALLATION PARAMETER	MINIMUM	TYPICAL <sup>1</sup>	MAXIMUM	UNIT
Traffic Direction		approaching		
Height	4   13	6   19	8   26	m   ft
Elevation Angle	-10	-7	0	°
Angle to Lane	-60	6	60	°
Traffic Counting	30   98		200   656	m   ft

### 13.6 Pedestrian/Bike Counting with Sidewalk Zones

If you easily want to classify Pedestrians and Bikes, just define your sidewalks with “sidewalk zones” (purple zones). Every Track which is created in this zone, will be classified as Pedestrian/Bike. If a track is moving inside a sidewalk zone for a couple of time, it will also be classified as Pedestrian/Bike. Sidewalk Zones enables you an easy classification option. In combination with a motion zone (condition Pedestrian only), you can easily count Pedestrians/Bikes in your intersection area.





### 13.7 Working Example — An overview

The ITR-3800 can be configured in two separate ways. You can either configure it online while you are connected to the sensor, or you can configure it offline for data evaluation.

ONLINE CONFIGURATION AND ITS PERKS	OFFLINE CONFIGURATION AND ITS PERKS
<ul style="list-style-type: none"> <li>• Write configuration to sensor</li> <li>• Read configuration from sensor</li> <li>• Online visual performance evaluation</li> <li>• Record and save scenarios</li> </ul>	<ul style="list-style-type: none"> <li>• Configure and adjust comfortable project files in the office</li> <li>• Load and replay recordings for in-depth evaluation</li> </ul>

Several working examples will be introduced on the following pages:

- [Easy configuration in 10 steps](#) - no project file included.
- [Application Stop Bar Detection](#) - project file "User Manual ITR-3800 Projectfile Stop Bar Working Example.iprj" included.
- [Application Traffic Counting](#) - project file "User Manual ITR-3800 Projectfile Counting Working Example.iprj" included.
- [Application Queue Length](#) - project file "User Manual ITR-3800 Projectfile Queue Length Working Example.iprj" included.

### 13.8 Working Example — In 10 easy steps to our own configuration

As a working example we want to measure the queue length from two oncoming streets in our hometown Hassfurt, Bavaria, where our ITR-3800 has been installed. In just 10 easy steps we can configure our ITR-3800 offline by using InnoSenT's Traffic Manager. This example shows you how to configure your own projectfile. Working examples for different applications are given in the following sections.

Step 1: After installation, we open the Configuration Wizard by clicking on the "Configuration" Button

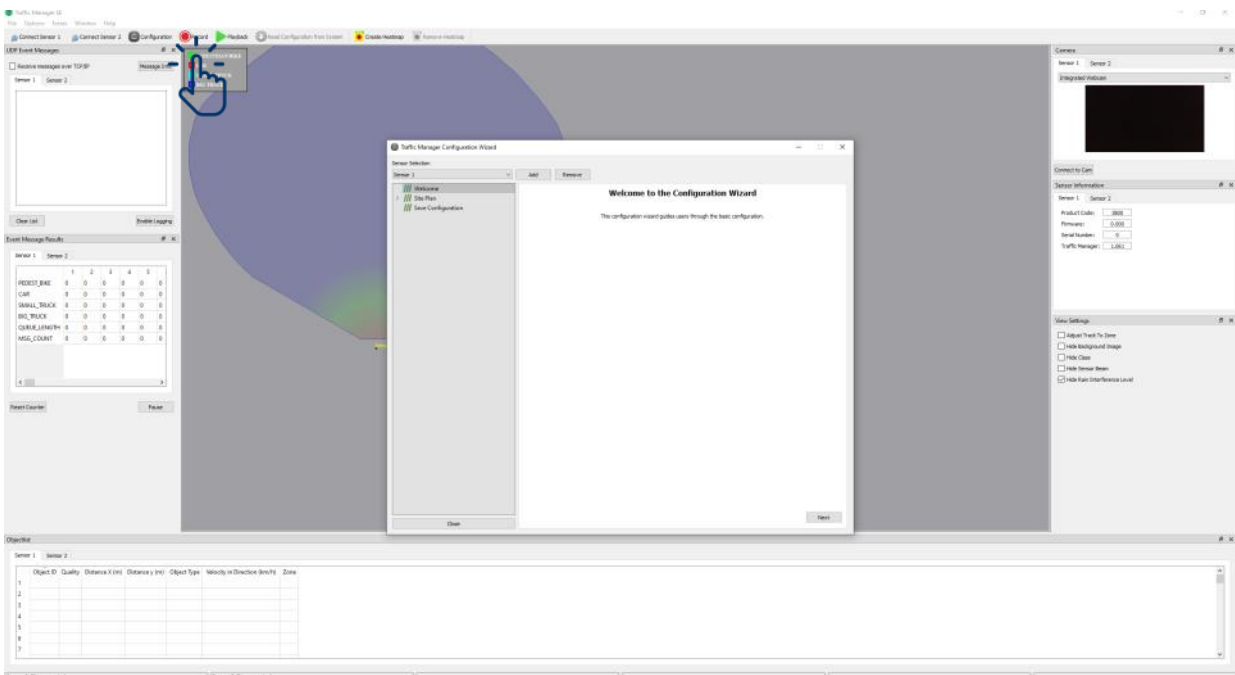

Step 2: We need our background image from our intersection in Hassfurt. Therefore, we need to go to Site Plan -> Background -> Open Map to capture an Image

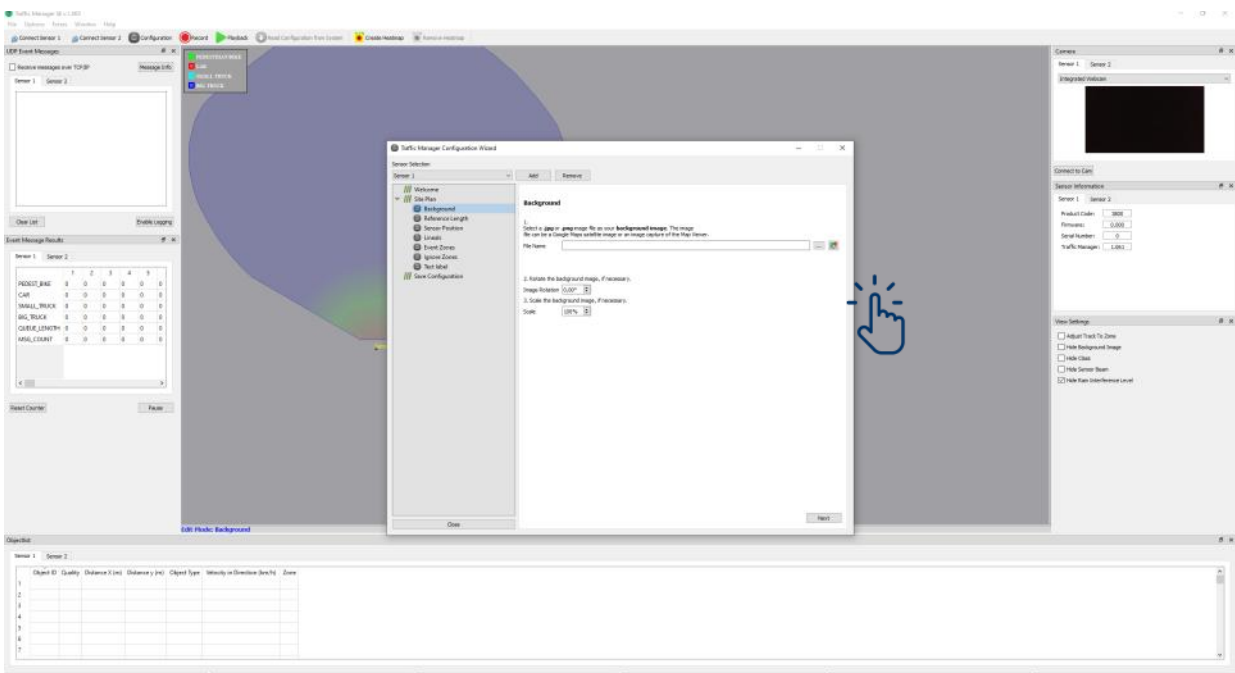

### 13.8 Working Example — In 10 easy steps to our own configuration

Step 3: We want the Google Maps Image where our ITR-3800 is located. We maneuver to our location easily by using the built in Mapviewer. After having adjusted the image we save it by clicking the 'Capture Image' button in the top right corner.



Step 4: After capturing the image, we need the [reference length](#) in order for the event zones to work correctly. The easiest way to do this is by opening Google Maps separately in your browser and use its measurement function.

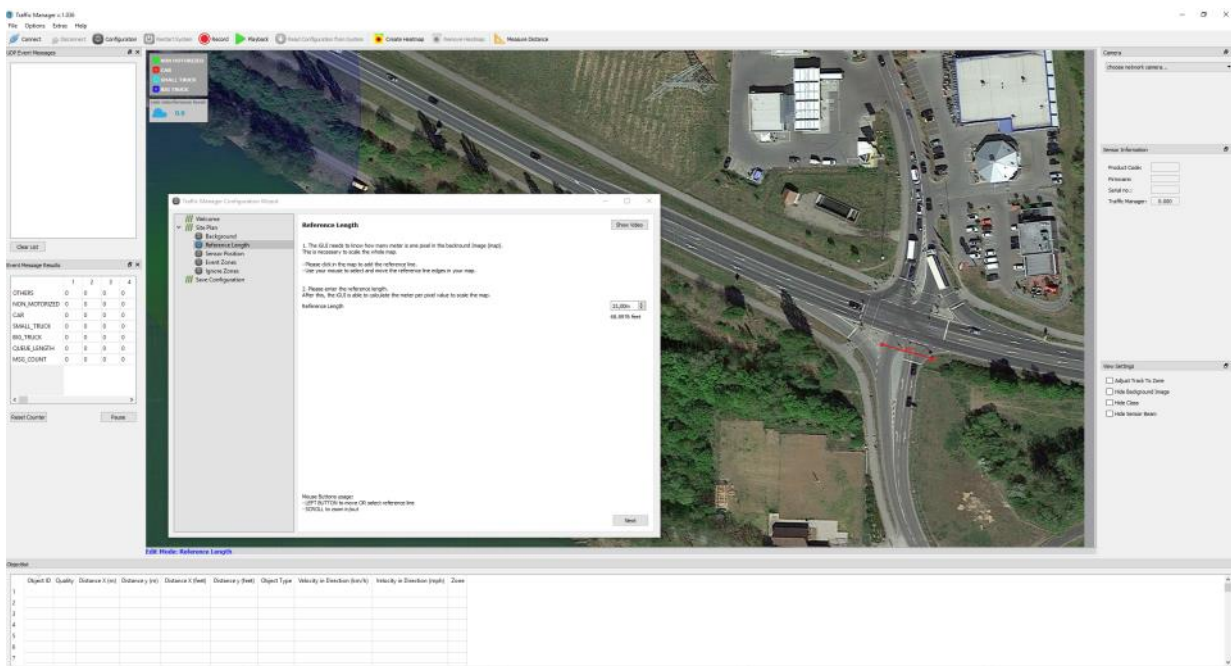

### 13.8 Working Example — In 10 easy steps to our own configuration

Step 5: After having set the correct reference length, we need to move our sensor to the precise position it's installed. Afterwards, we have to adjust the sensor beam and installation height, in order for the tracks to be displayed correctly.

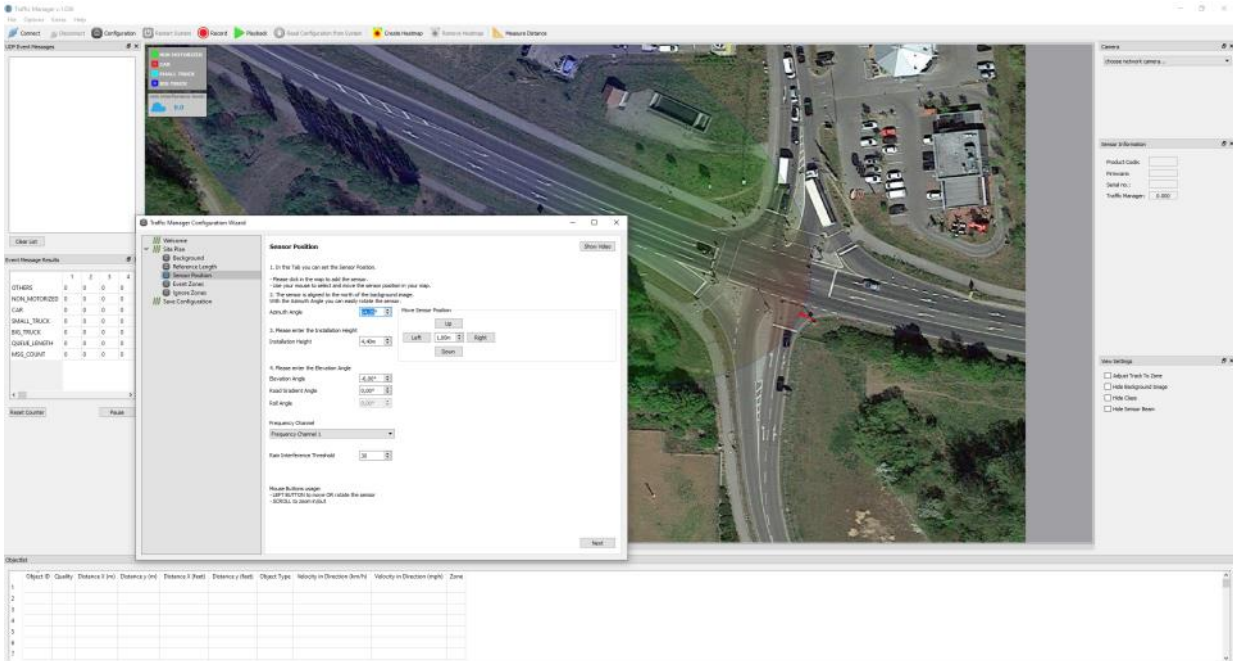

Step 6: As we want to measure the queue length on two separate lanes, we have to use presence zones. Therefore, we add the first Presence Zone in the Event Zone set up.

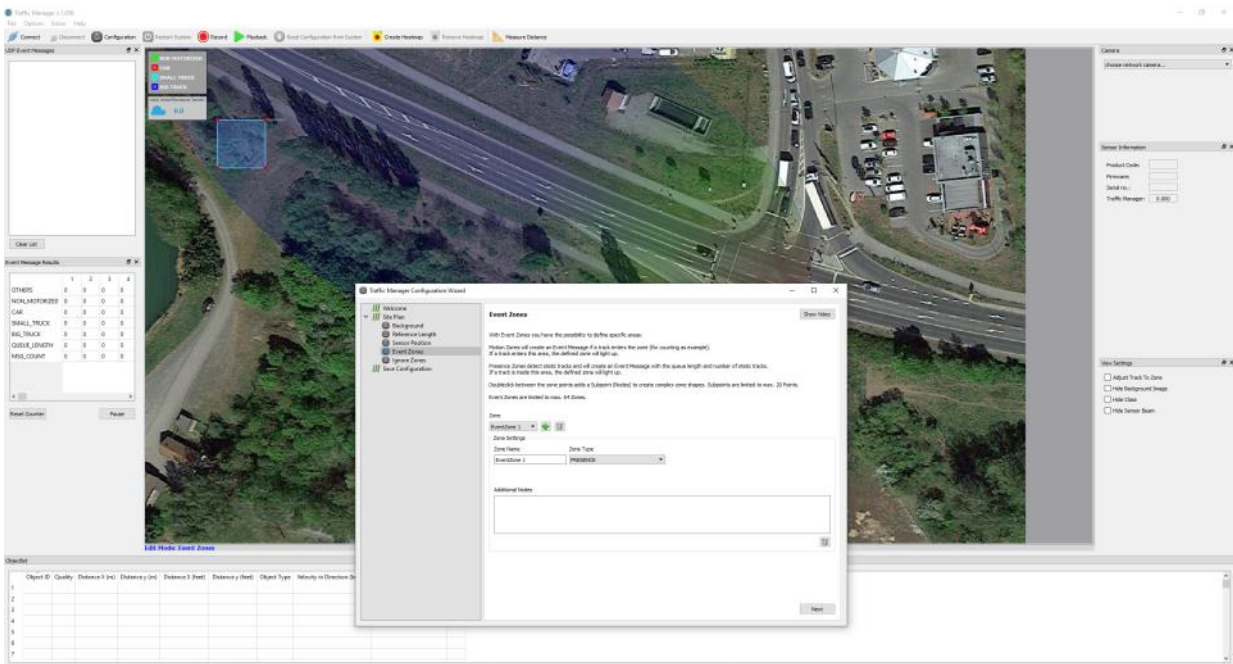

### 13.8 Working Example — In 10 easy steps to our own configuration

Step 7: The presented presence zone does not have the required shape yet. Hence, we have to adjust the presence zone to the desired maximum queue length. This is quickly done by dragging the zones' nodes into the correct shape.

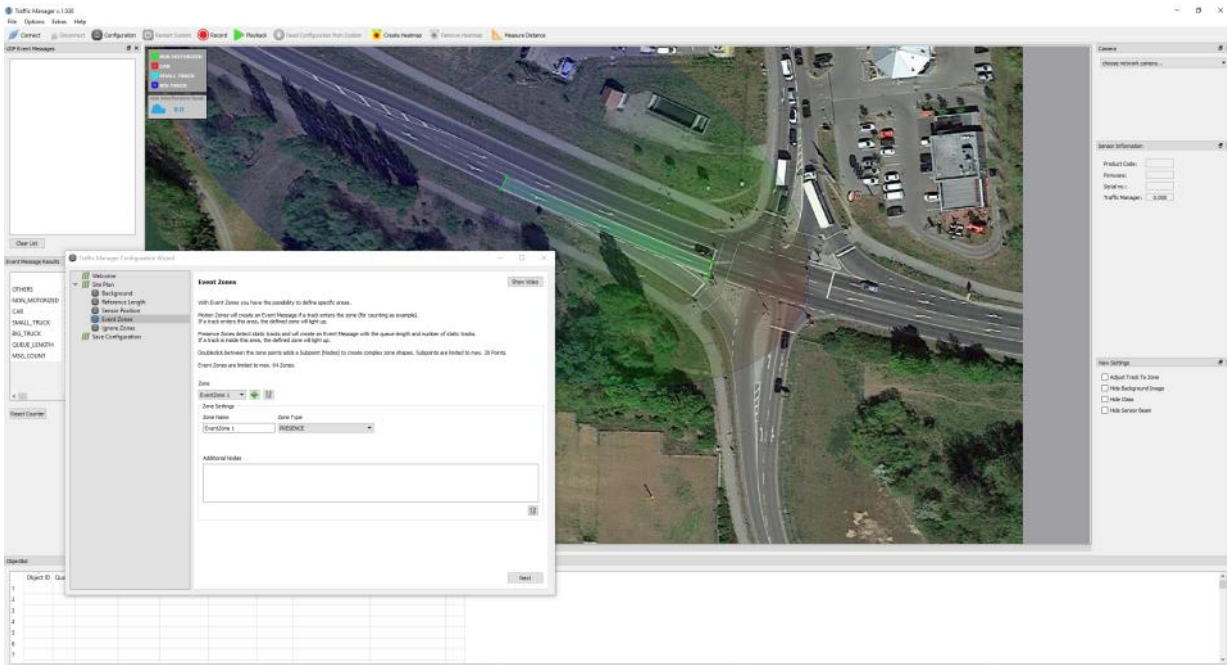

Step 8: As we want to measure queue length on two separate lanes, we need to add another presence zone. We notice that we have got a curve in our lane, so we need bring the zone into the appropriate shape. This is easily done by adding more nodes to our zone by just double clicking on the corresponding lines.

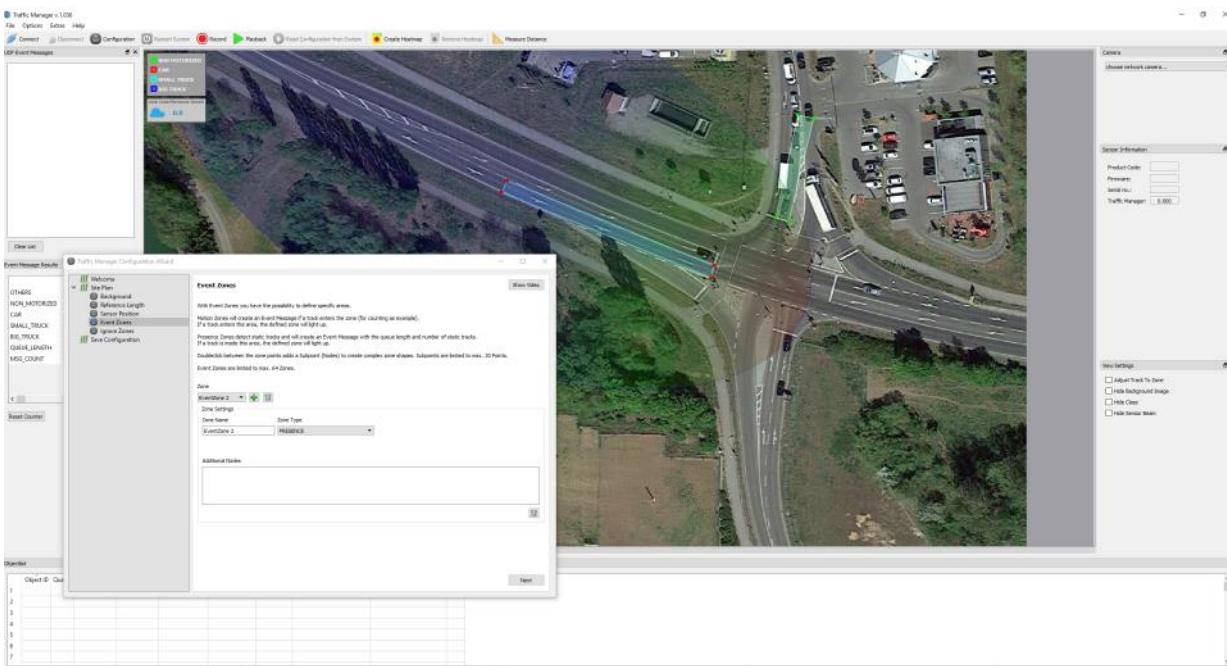

### 13.8 Working Example — In 10 easy steps to our own configuration

Step 9: After having added three more nodes to the zone, we adjusted the presence zone to the desired shape.

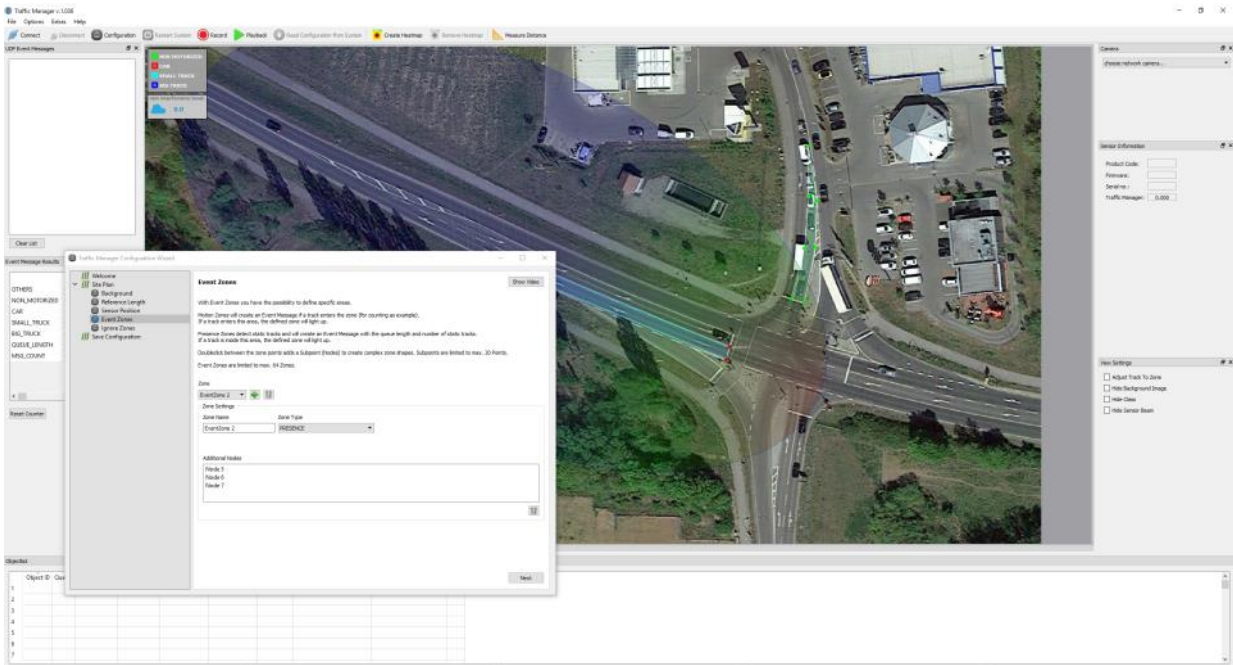

Step 10: After having set all our presence zones, we can save this configuration file. Afterwards, when having established a connection to the sensor, the saved configuration can be sent to the ITR-3800 and we are ready to measure the queue lengths in Hassfurt, Bavaria.

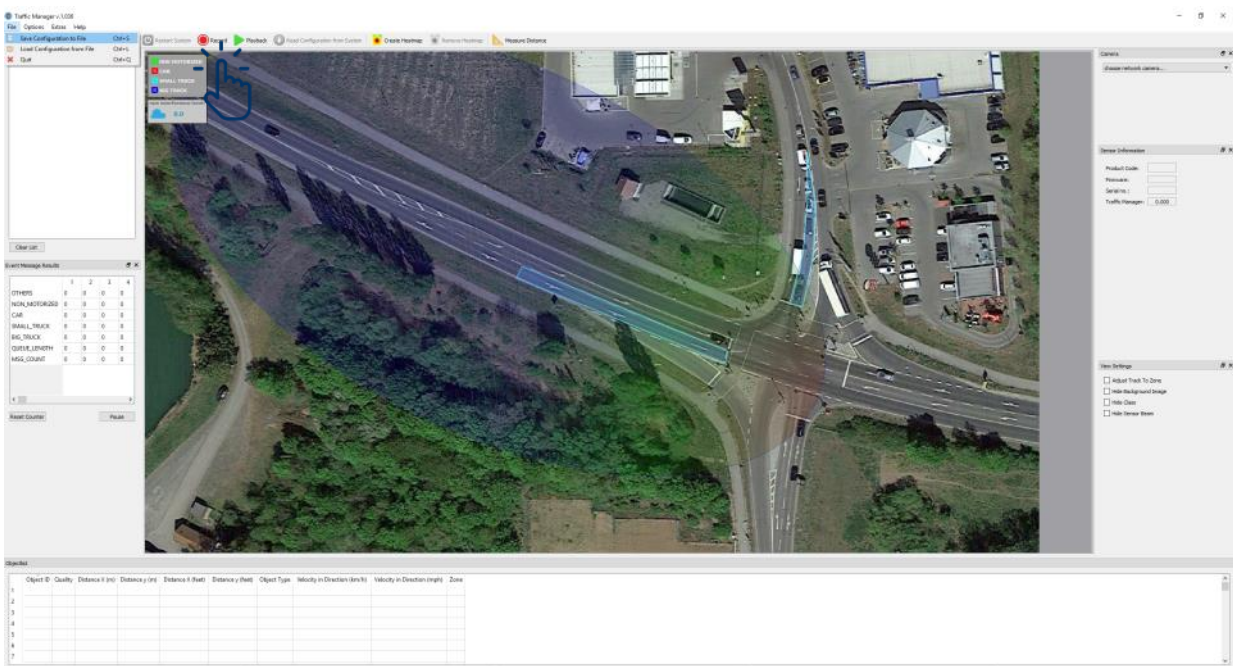

### 13.9 Working Example — Application Stop Bar Detection

Step 1: In the next example, we want to have a Stop Bar Detection for traffic lights. We will have to set Presence Zones for our Stop Bar Detection. Remember, the zones must have the right size for Stop Bar Detection.

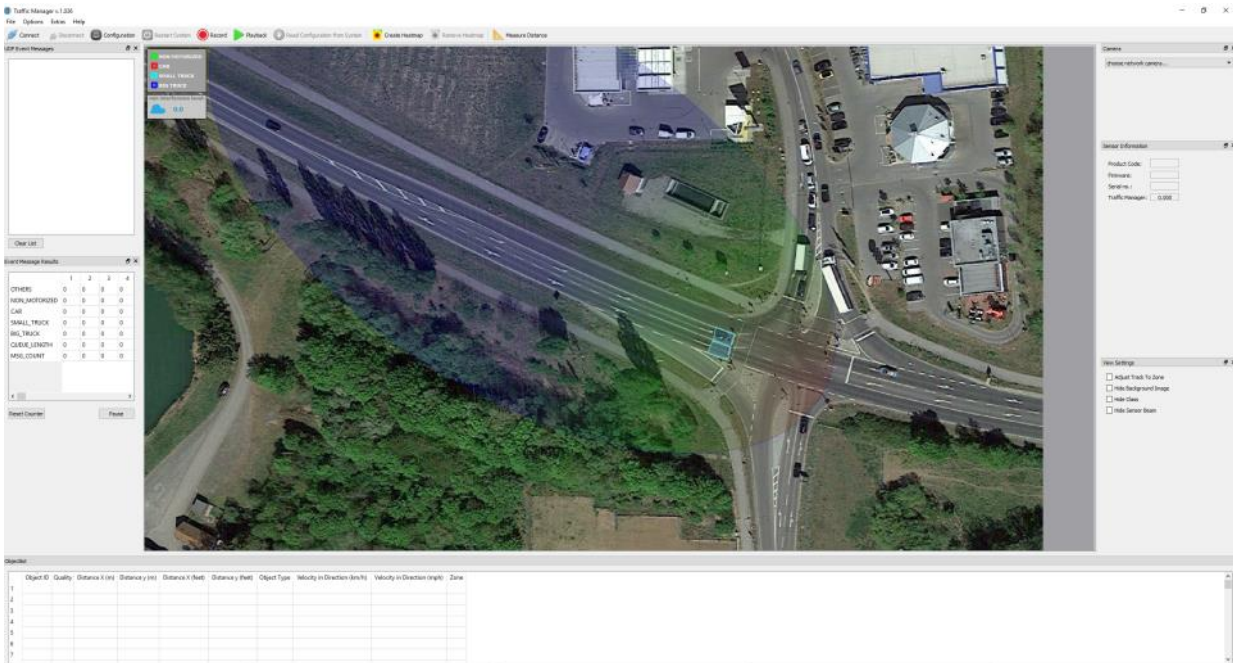

Step 2: As we can see, the ITR-3800 detects and tracks the two objects in front of our traffic light. If a track becomes stops in front of the traffic light and becomes static, the ITR-3800 generates an UDP event message (highlighted yellow in the picture). Now we could trigger our traffic light and therefore optimize traffic flow.



### 13.10 Working Example — Application Traffic Counting

Step 1: In our traffic counting application, we want to count the approaching and receding traffic separately on each lane. Therefore, we need three motion zones.

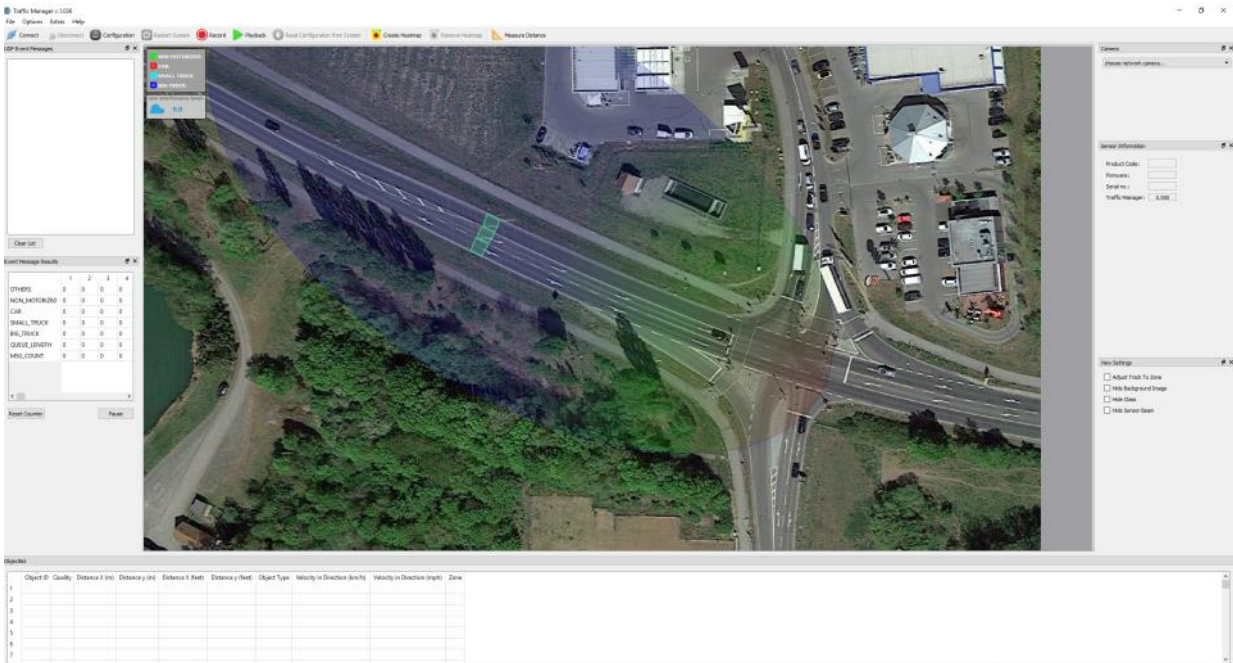

Step 2: As the traffic approaches, we get each time an UDP event message an object passes through a motion zone.

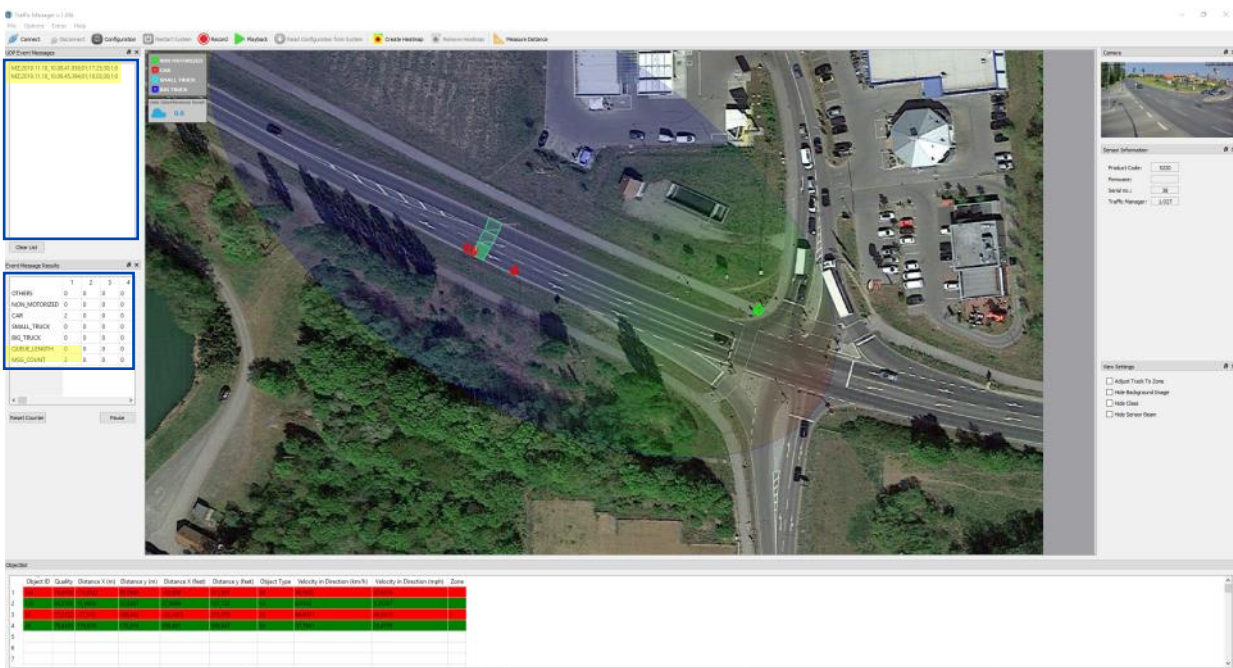



### 13.10 Working Example — Application Traffic Counting

Step 3: The motion zones are capable of detecting at what speed the traffic is approaching or receding. Check out the UDP event messages in getting the speed and direction of the tracked object. Now we could calculate traffic flows and average traffic speed. We can even detect wrong way drivers.

The screenshot displays a traffic monitoring application. The central part of the interface shows an aerial view of a road intersection with a radar scan overlaid, indicating detected vehicles. On the left, there are panels for 'UDP Messages' and 'Motion Zones'. On the right, there are panels for 'Camera' and 'Sensor Information'. At the bottom, a data table lists detected objects with their properties.

Object ID	Quality	Distance X (m)	Distance Y (m)	Distance X (feet)	Distance Y (feet)	Object Type	Velocity in Direction (km/h)	Velocity in Direction (mph)	Zone
1	100	100	100	328	328	Car	100	62	Zone 1
2	100	100	100	328	328	Car	100	62	Zone 1
3	100	100	100	328	328	Car	100	62	Zone 1
4	100	100	100	328	328	Car	100	62	Zone 1
5	100	100	100	328	328	Car	100	62	Zone 1
6	100	100	100	328	328	Car	100	62	Zone 1
7	100	100	100	328	328	Car	100	62	Zone 1
8	100	100	100	328	328	Car	100	62	Zone 1
9	100	100	100	328	328	Car	100	62	Zone 1
10	100	100	100	328	328	Car	100	62	Zone 1

### 13.11 Working Example — Application Queue Length

Step 1: This time we want to measure the queue length on the two approaching lanes right in front of the sensor. Therefore, we have to set two presence zones with an appropriate length.

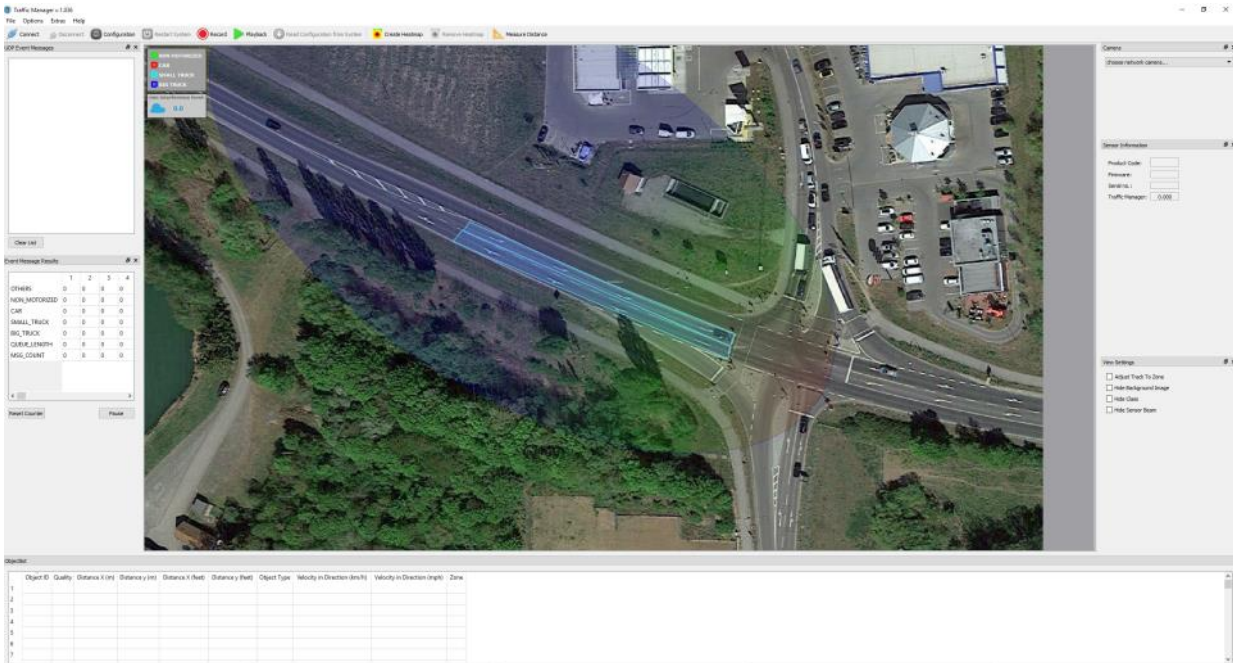

Step 2: Tracks can now become static in the presence zones. As we can see, the respective queue lengths are several meter long. Thanks to the UDP messages, we now know how many tracks are present in the queue length and how long it is. Each time there is a change in queue length the ITR-3800 generates an UDP event message. Now we could trigger our traffic light and therefore optimize traffic flow.

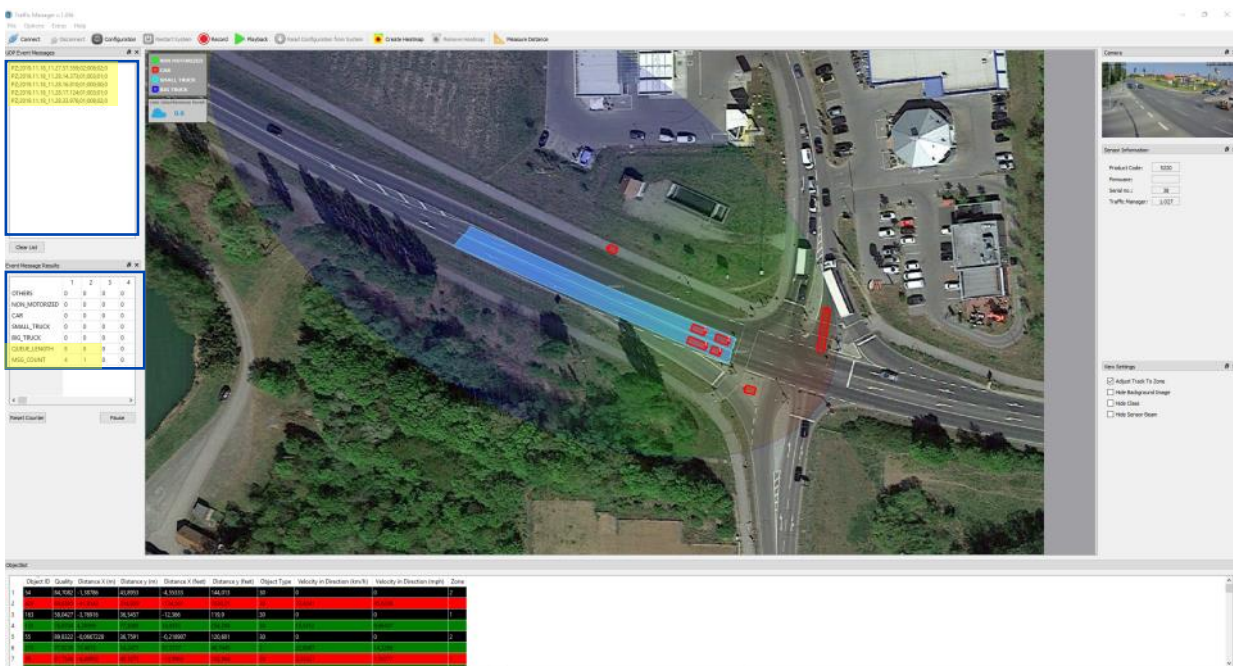

## 14. APPROVALS

The information that will be given below is only a rough overview. For details please contact the local approval agencies.

### FREQUENCY BANDS IN US (FCC 15.249)

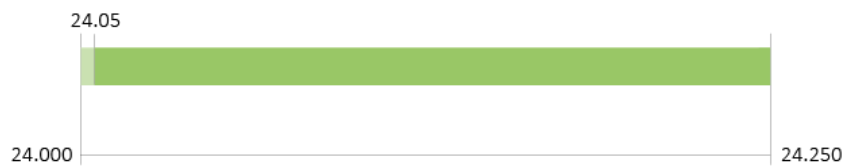

## 15. DISPOSAL

The device is to be disposed of according to the European Community Directive 2012/19/EU on waste electrical and electronic equipment.

Devices must not be disposed of with consumer waste.

For environmentally compatible recycling and disposal of the device, please contact a certified waste management company or send the device back to InnoSenT.

## 16. APPENDIX

### Distance X and Distance Y

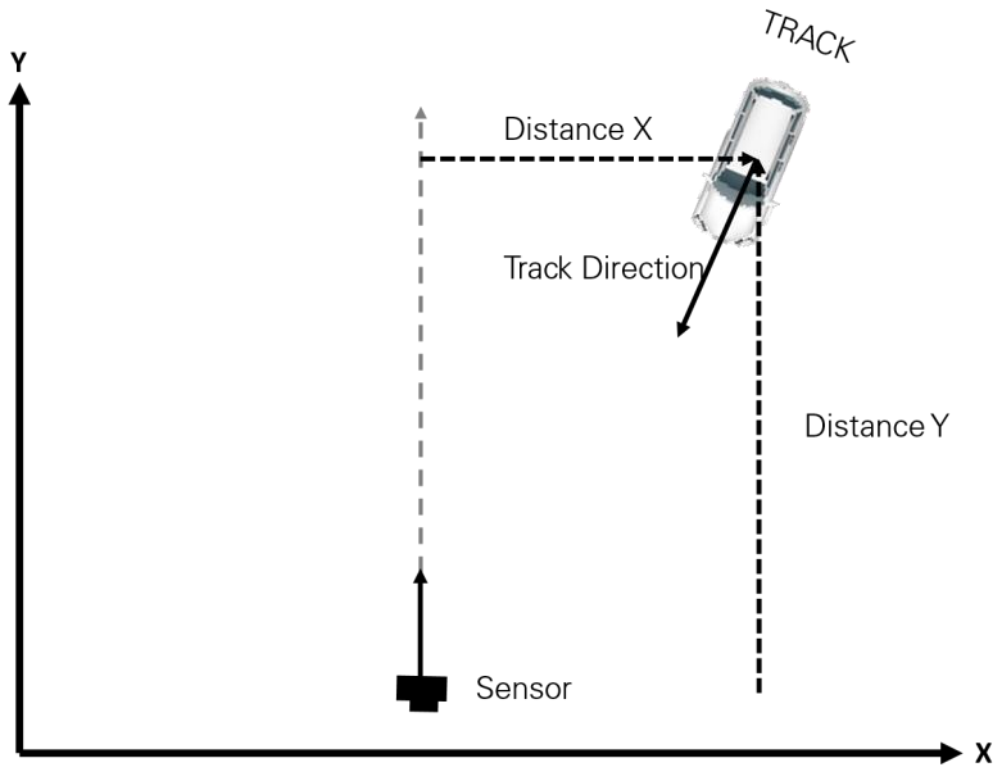

### Velocity and Direction

$$\text{Direction } X = \frac{\text{Velocity } X}{\sqrt{(\text{Velocity } X)^2 + (\text{Velocity } Y)^2}}$$

$$\text{Direction } Y = \frac{\text{Velocity } Y}{\sqrt{(\text{Velocity } X)^2 + (\text{Velocity } Y)^2}}$$

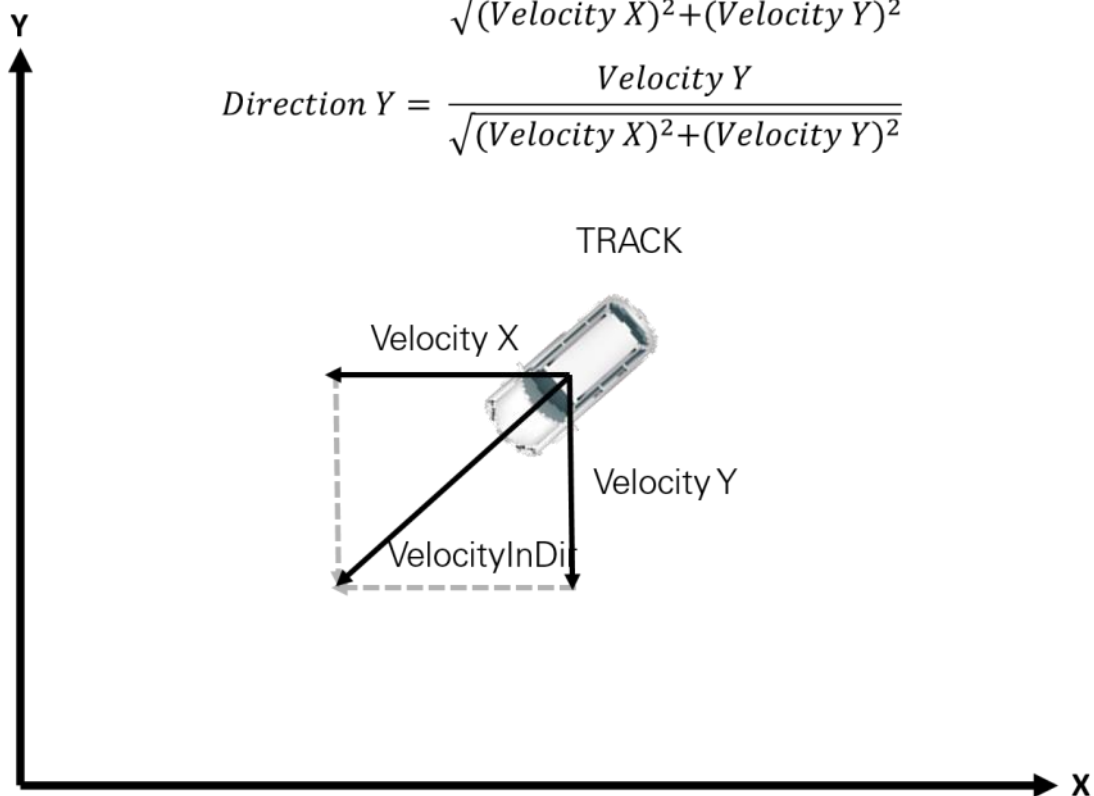

### Track Width and Length

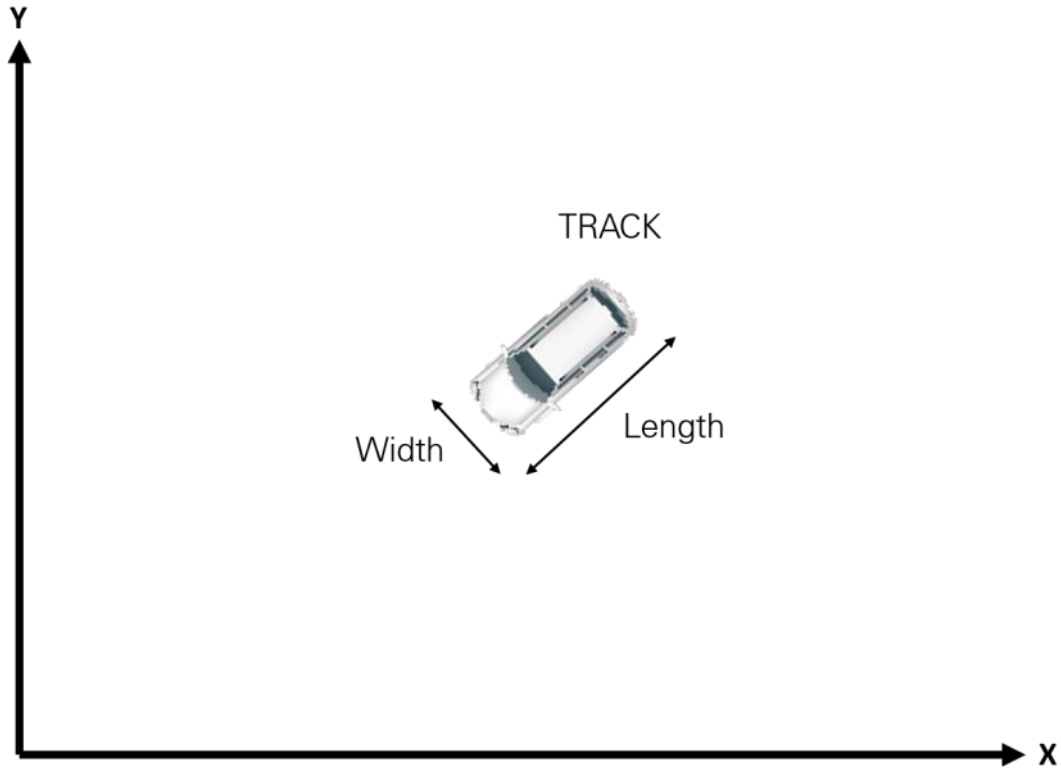

### Distance to Front and Distance to Back

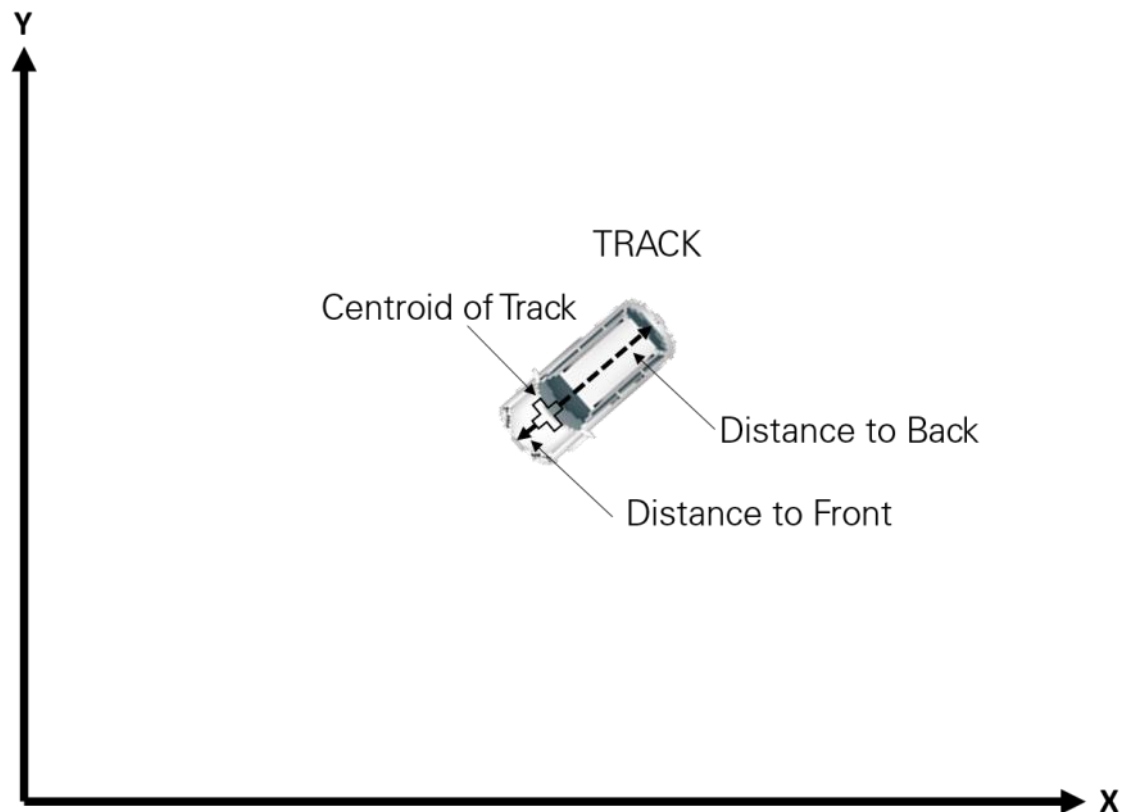

### Track Assignability

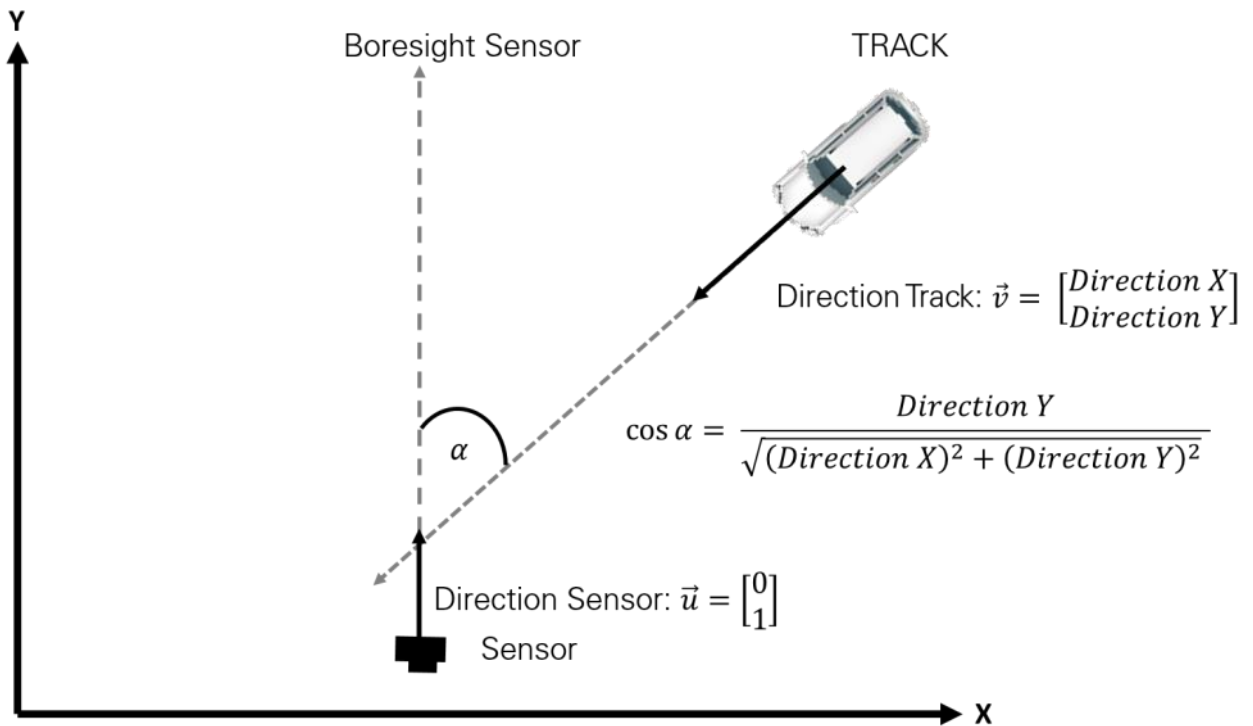

### Assignable Tracks

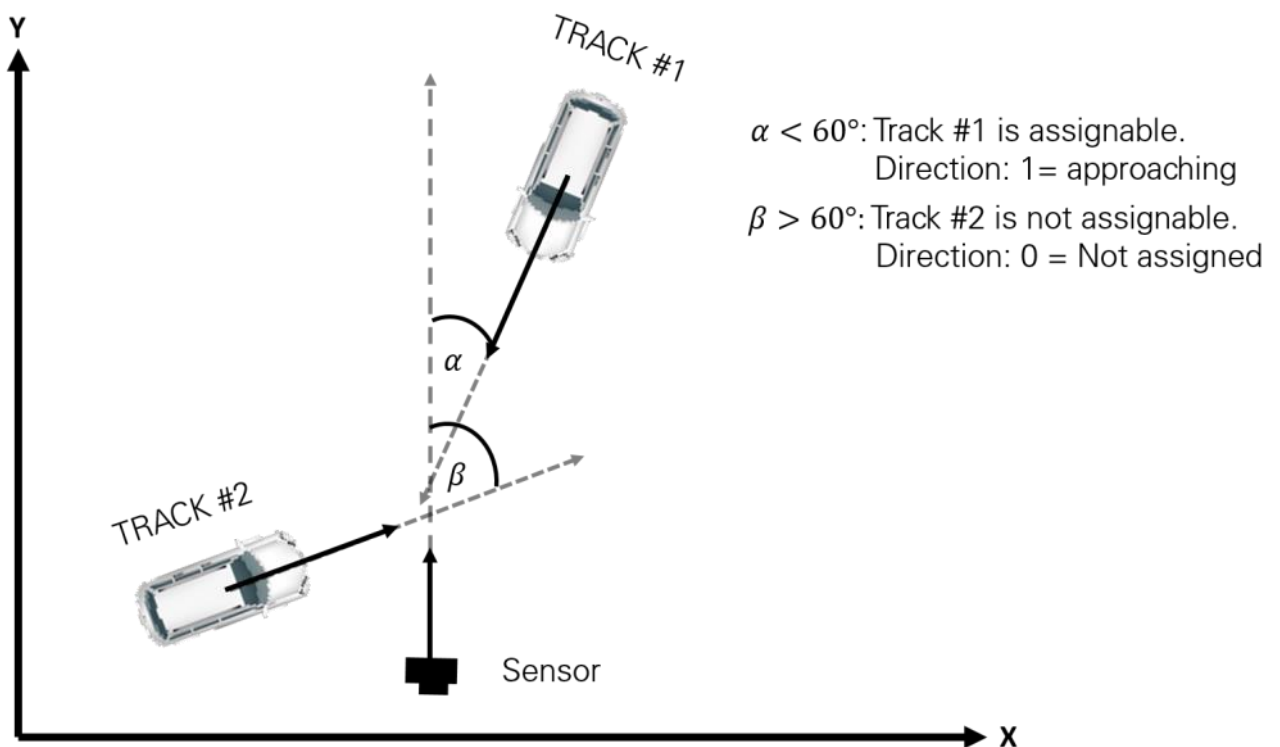

## 17. CONTACT

Customer satisfaction is our most important goal here at InnoSenT. We therefore offer direct support for our customers.

Please send your questions, feedback and recommendations concerning ITR-3800 to the e-mail:

[sales@innosent.de](mailto:sales@innosent.de)

## 18. KNOWN ISSUES

ISSUE	DESCRIPTION	EFFECT
Power Up	Pre-series modules might happen to power up improperly. If so, a full power cycle is necessary.	System parts don't power up properly. No effect on radar function when running.



InnoSenT GmbH  
Am Roedertor 30  
97499 Donnersdorf  
Germany

**Phone:** +49-9528-9518-0  
**E-Mail:** [sales@innosent.de](mailto:sales@innosent.de)  
**Web:** [www.innosent.de](http://www.innosent.de)