

TEST REPORT

Test report no.: 1-5034_22-01-02

BNetzA-CAB-02/21-102

Testing laboratory

CTC advanced GmbH

Untertuerkheimer Strasse 6 – 10

66117 Saarbruecken / Germany

Phone: + 49 681 5 98 - 0

Fax: + 49 681 5 98 - 9075

Internet: <https://www.ctcadvanced.com>

e-mail: mail@ctcadvanced.com

Accredited Testing Laboratory:

The testing laboratory (area of testing) is accredited according to DIN EN ISO/IEC 17025 (2018-03) by the Deutsche Akkreditierungsstelle GmbH (DAkKS)

The accreditation is valid for the scope of testing procedures as stated in the accreditation certificate starting with the registration number: D-PL-12076-01.

Applicant

InnoSenT GmbH

Am Rödertor 30

97499 Donnersdorf / GERMANY

Phone: +49 9528 9518-0

Contact: Cyrus Nabavinegad

e-mail: Cyrus.Nabavinegad@innosent.de

Manufacturer

InnoSenT GmbH

Am Rödertor 30

97499 Donnersdorf / GERMANY

Test standard/s

FCC - Title 47 CFR Part 15 FCC - Title 47 of the Code of Federal Regulations; Chapter I; Part 15 - Radio frequency devices

For further applied test standards please refer to section 3 of this test report.

Test Item

Kind of test item: **Stationary Traffic Monitoring**
Model name: **ITR-3800**
FCC ID: **UXS-ITR-3800**
Frequency: 24.00 GHz – 24.25 GHz
Antenna: Integrated patch antenna
Power supply: 24 V – 48 V DC (0.76 A)
Temperature range: -40°C to +80°C

This test report is electronically signed and valid without handwritten signature. For verification of the electronic signatures, the public keys can be requested at the testing laboratory.

Test report authorized:

Thomas Vogler
Lab Manager
Radio Communications & EMC

Test performed:

Meheza Walla
Lab Manager
Radio Communications & EMC

1 Table of contents

1	Table of contents.....	2
2	General information.....	3
2.1	Notes and disclaimer	3
2.2	Application details	3
2.3	Test laboratories sub-contracted	3
3	Test standard/s, references and accreditations	4
4	Reporting statements of conformity – decision rule	5
5	Test environment.....	6
6	Test item	6
6.1	General description	6
6.2	Additional information	6
7	Description of the test setup.....	7
7.1	Shielded semi anechoic chamber	8
7.1	Shielded fully anechoic chamber.....	10
7.2	Radiated measurements > 18 GHz	12
7.3	Radiated measurements > 50/85 GHz	12
7.4	AC power-line conducted emissions	14
8	Sequence of testing.....	15
8.1	Sequence of testing radiated spurious 9 kHz to 30 MHz	15
8.2	Sequence of testing radiated spurious 30 MHz to 1 GHz.....	16
8.3	Sequence of testing radiated spurious 1 GHz to 18 GHz.....	17
8.4	Sequence of testing radiated spurious above 18 GHz.....	18
8.5	Sequence of testing radiated spurious above 50/85 GHz with external mixers.....	19
9	Measurement uncertainty	20
10	Far field consideration for measurements above 18 GHz	20
11	Summary of measurement results	21
12	Measurement results	22
12.1	Field strength of fundamental emission.....	22
12.2	Occupied bandwidth (99% bandwidth)	25
12.3	Field strength of emissions (radiated spurious).....	26
12.4	Conducted emissions < 30 MHz.....	43
12.5	Frequency Stability.....	46
13	Glossary	53
14	Document history	54
15	Accreditation Certificate – D-PL-12076-01-05	54

2 General information

2.1 Notes and disclaimer

The test results of this test report relate exclusively to the test item specified in this test report. CTC advanced GmbH does not assume responsibility for any conclusions and generalizations drawn from the test results with regard to other specimens or samples of the type of the equipment represented by the test item.

The test report may only be reproduced or published in full. Reproduction or publication of extracts from the report requires the prior written approval of CTC advanced GmbH.

The testing service provided by CTC advanced GmbH has been rendered under the current "General Terms and Conditions for CTC advanced GmbH".

CTC advanced GmbH will not be liable for any loss or damage resulting from false, inaccurate, inappropriate or incomplete product information provided by the customer.

Under no circumstances does the CTC advanced GmbH test report include any endorsement or warranty regarding the functionality, quality or performance of any other product or service provided.

Under no circumstances does the CTC advanced GmbH test report include or imply any product or service warranties from CTC advanced GmbH, including, without limitation, any implied warranties of merchantability, fitness for purpose, or non-infringement, all of which are expressly disclaimed by CTC advanced GmbH.

All rights and remedies regarding vendor's products and services for which CTC advanced GmbH has prepared this test report shall be provided by the party offering such products or services and not by CTC advanced GmbH. In no case this test report can be considered as a Letter of Approval.

This test report is electronically signed and valid without handwritten signature. For verification of the electronic signatures, the public keys can be requested at the testing laboratory.

2.2 Application details

Date of receipt of order:	2022-11-03
Date of receipt of test item:	2022-12-01
Start of test:*	2022-12-12
End of test:*	2022-12-23
Person(s) present during the test:	-/-

*Date of each measurement, if not shown in the plot, can be requested. Dates are stored in the measurement software.



2.3 Test laboratories sub-contracted

None

3 Test standard/s, references and accreditations

Test standard	Date	Description
FCC - Title 47 CFR Part 15		FCC - Title 47 of the Code of Federal Regulations; Chapter I; Part 15 - Radio frequency devices

Guidance	Version	Description
ANSI C63.4-2014	-/-	American National Standard for Methods of Measurement of Radio-Noise Emissions from Low-Voltage Electrical and Electronic Equipment in the Range of 9 kHz to 40 GHz
ANSI C63.10-2013	-/-	American National Standard of Procedures for Compliance Testing of Unlicensed Wireless Devices
ANSI C63.26-2015	-/-	American National Standard for Compliance Testing of Transmitters Used in Licensed Radio Services

Accreditation	Description	
D-PL-12076-01-05	Telecommunication FCC requirements https://www.dakks.de/as/ast/d/D-PL-12076-01-05e.pdf	  Deutsche Akkreditierungsstelle D-PL-12076-01-05

FCC designation number: DE0002

4 Reporting statements of conformity – decision rule

Only the measured values related to their corresponding limits will be used to decide whether the equipment under test meets the requirements of the test standards listed in chapter 3.

The measurement uncertainty is mentioned in this test report, see chapter 9, but is not taken into account - neither to the limits nor to the measurement results. Measurement results with a smaller margin to the corresponding limits than the measurement uncertainty have a potential risk of more than 5% that the decision might be wrong."

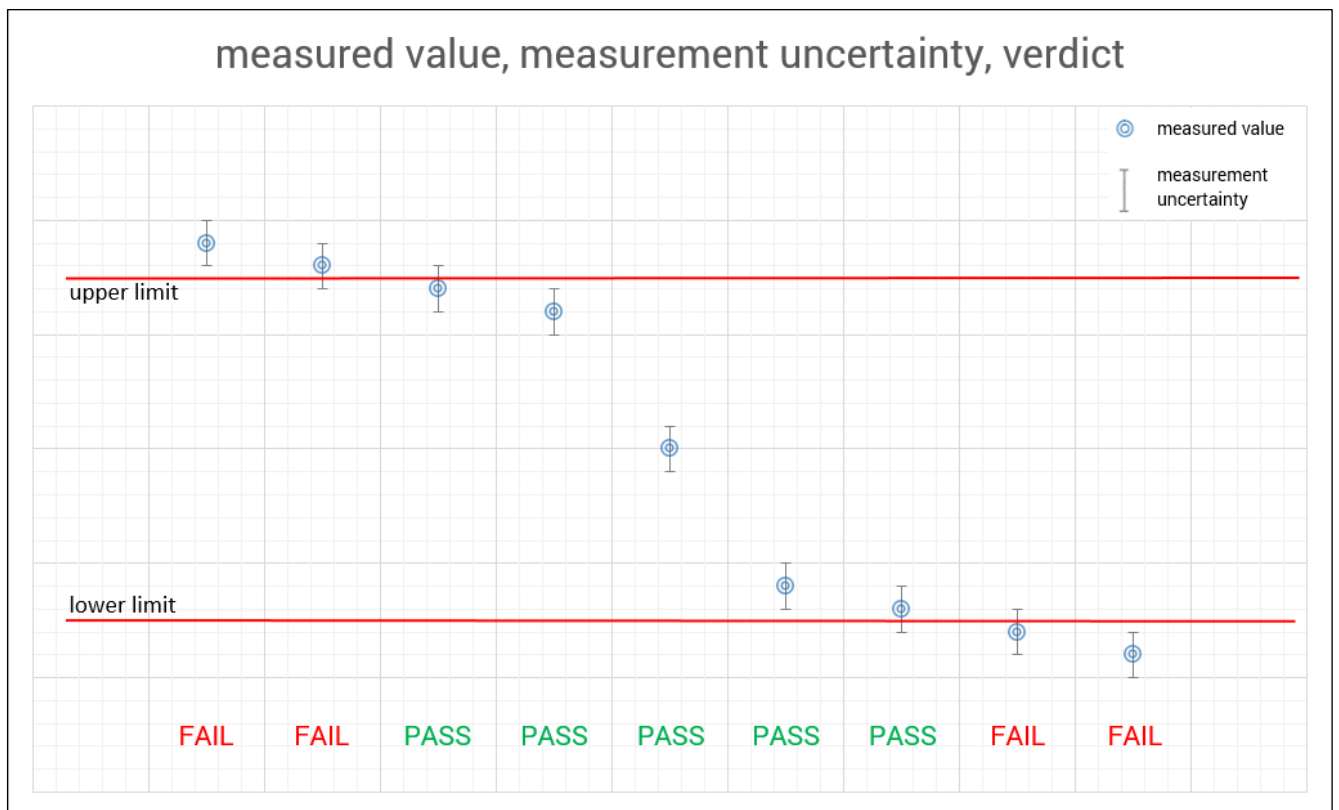

7 Description of the test setup

Typically, the calibrations of the test apparatus are commissioned to and performed by an accredited calibration laboratory. The calibration intervals are determined in accordance with the DIN EN ISO/IEC 17025. In addition to the external calibrations, the laboratory executes comparison measurements with other calibrated test systems or effective verifications. Weekly chamber inspections and range calibrations are performed. Where possible, RF generating and signaling equipment as well as measuring receivers and analyzers are connected to an external high-precision 10 MHz reference (GPS-based or rubidium frequency standard).

In order to simplify the identification of the equipment used at some special tests, some items of test equipment and ancillaries can be provided with an identifier or number in the equipment list below (Lab/Item).

Agenda: Kind of Calibration

k	calibration / calibrated		EK	limited calibration
ne	not required (k, ev, izw, zw not required)		zw	cyclical maintenance (external cyclical maintenance)
ev	periodic self verification		izw	internal cyclical maintenance
Ve	long-term stability recognized		g	blocked for accredited testing
v!k!	Attention: extended calibration interval			
NK!	Attention: not calibrated		*)	next calibration ordered / currently in progress

7.1 Shielded semi anechoic chamber

The radiated measurements are performed in vertical and horizontal plane in the frequency range from 30 MHz to 1 GHz in semi-anechoic chambers. The EUT is positioned on a non-conductive support with a height of 0.80 m above a conductive ground plane that covers the whole chamber. The receiving antennas are conform to specifications ANSI C63. These antennas can be moved over the height range between 1.0 m and 4.0 m in order to search for maximum field strength emitted from EUT. The measurement distances between EUT and receiving antennas are indicated in the test setups for the various frequency ranges. For each measurement, the EUT is rotated in all three axes until the maximum field strength is received. The wanted and unwanted emissions are received by spectrum analyzers where the detector modes and resolution bandwidths over various frequency ranges are set according to requirement ANSI C63.

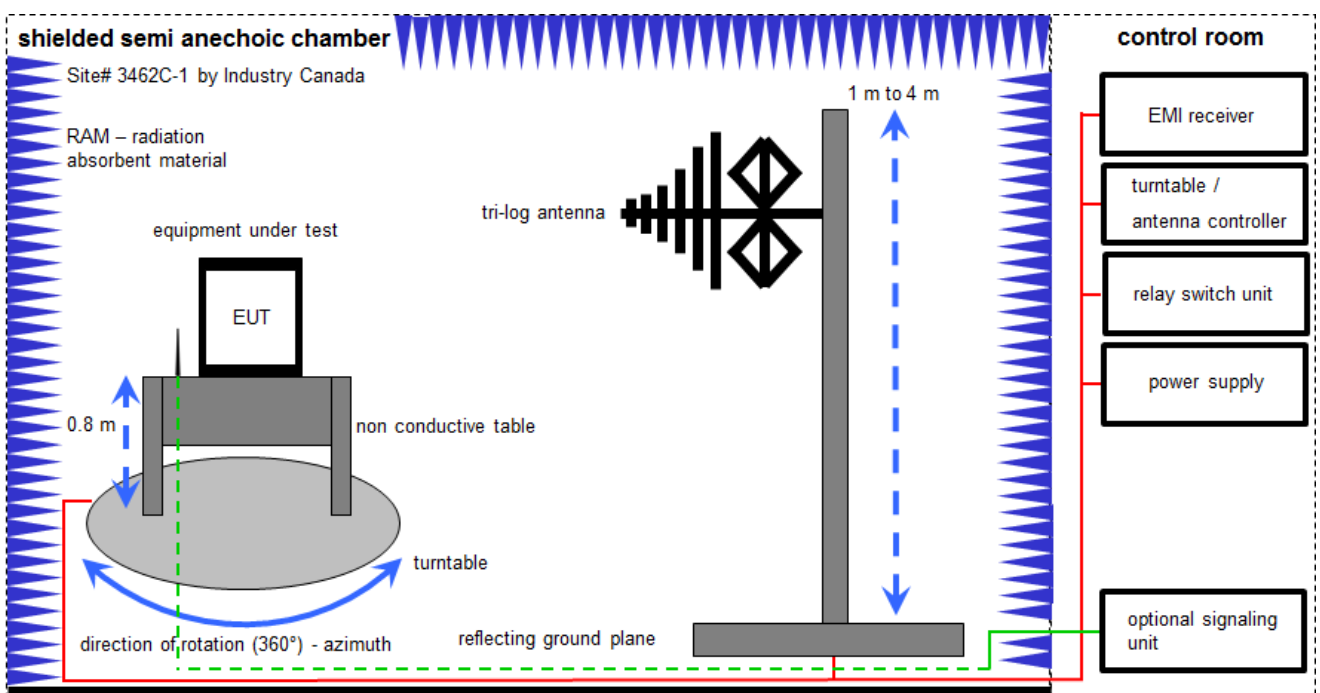

Measurement distance: tri-log antenna 10 meter

$$FS = UR + CL + AF$$

(FS-field strength; UR-voltage at the receiver; CL-loss of the cable; AF-antenna factor)

Example calculation:

$$FS [dB\mu V/m] = 12.35 [dB\mu V/m] + 1.90 [dB] + 16.80 [dB/m] = 31.05 [dB\mu V/m] (35.69 \mu V/m)$$

Equipment table:

No.	Lab / Item	Equipment	Type	Manufacturer	Serial No.	INV. No.	Kind of Calibration	Last Calibration	Next Calibration
1	n. a.	Switch-Unit	3488A	HP	2719A14505	30000368	ev	-/-	-/-
2	n. a.	DC power supply, 60Vdc, 50A, 1200 W	6032A	HP	2920A04466	300000580	ne	-/-	-/-
3	n. a.	Meßkabine 1	HF-Absorberhalle	MWB AG 300023		300000551	ne	-/-	-/-
4	n. a.	EMI Test Receiver	ESCI 3	R&S	101240	300004427	k	14.12.2022	31.12.2023
5	n. a.	Antenna Tower	Model 2175	ETS-Lindgren	64762	300003745	izw	-/-	-/-
6	n. a.	Positioning Controller	Model 2090	ETS-Lindgren	64672	300003746	izw	-/-	-/-
7	n. a.	Turntable Interface-Box	Model 105637	ETS-Lindgren	44583	300003747	izw	-/-	-/-
8	n. a.	TRILOG Broadband Test-Antenna 30 MHz - 3 GHz	VULB9163	Schwarzbeck Mess - Elektronik	318	300003696	vKI!	30.09.2019	29.09.2023
9	n. a.	Switch-Unit	3488A	HP	2719A14505	30000368	ev	-/-	-/-
10	n. a.	EMI Test Receiver	ESR3	Rohde & Schwarz	102587	300005771	k	20.05.2022	31.05.2023

7.1 Shielded fully anechoic chamber

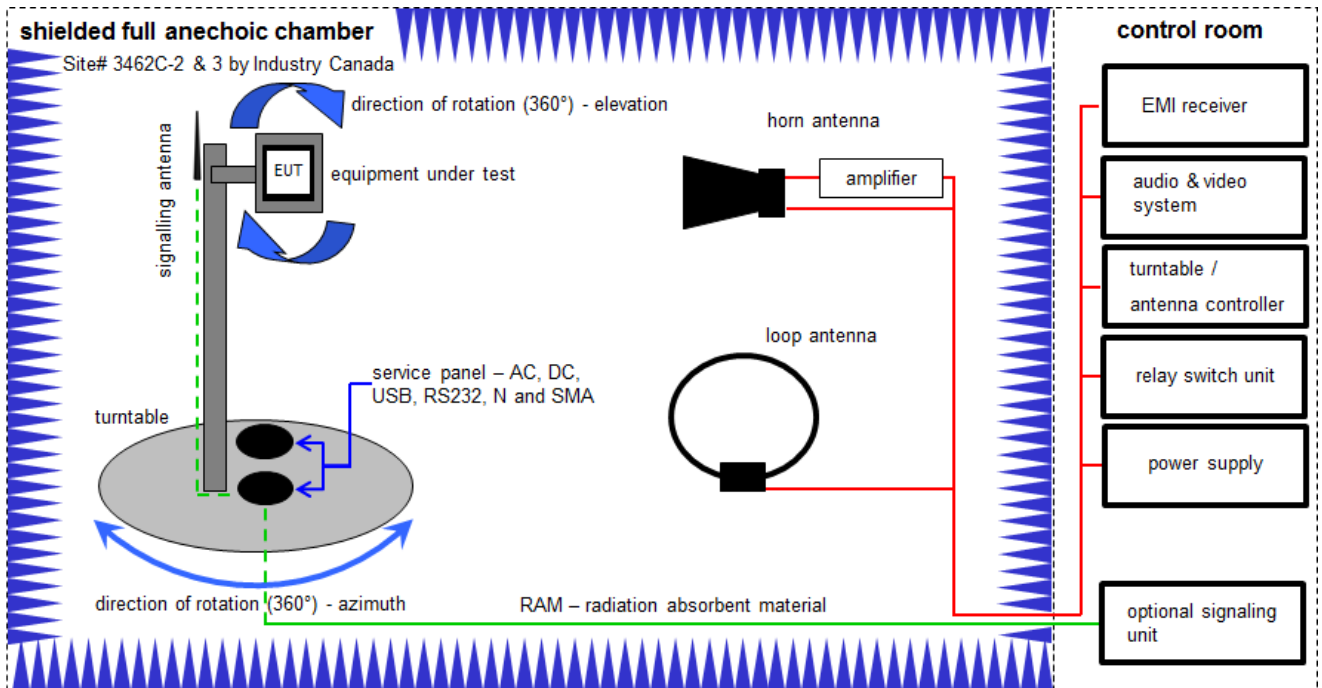

Measurement distance: horn antenna 3 meter; loop antenna 3 meter / 1 meter

$$FS = UR + CA + AF$$

(FS-field strength; UR-voltage at the receiver; CA-loss of the signal path; AF-antenna factor)

Example calculation:

$$FS \text{ [dB}\mu\text{V/m]} = 40.0 \text{ [dB}\mu\text{V/m]} + (-35.8) \text{ [dB]} + 32.9 \text{ [dB/m]} = 37.1 \text{ [dB}\mu\text{V/m]} \text{ (71.61 } \mu\text{V/m)}$$

Equipment table:

No.	Lab / Item	Equipment	Type	Manufacturer	Serial No.	INV. No.	Kind of Calibration	Last Calibration	Next Calibration
1	n. a.	DC power supply, 60Vdc, 50A, 1200 W	6032A	HP	2818A03450	300001040	vKI!	09.12.2020	08.12.2023
2	n. a.	Active Loop Antenna 9 kHz to 30 MHz	6502	EMCO	2210	300001015	vKI!	01.07.2021	31.07.2023
3	n. a.	Anechoic chamber	FAC 3/5m	MWB / TDK	87400/02	300000996	ev	-/-	-/-
4	n. a.	TRILOG Broadband Test-Antenna 30 MHz - 3 GHz	VULB9163	Schwarzbeck Mess - Elektronik	318	300003696	vKI!	30.09.2021	29.09.2023
5	n. a.	Double-Ridged Waveguide Horn Antenna 1-18.0GHz	3115	EMCO	9709-5289	300000213	vKI!	26.07.2022	25.07.2024
6	n. a.	Switch / Control Unit	3488A	HP	*	300000199	ne	-/-	-/-
7	n. a.	Variable isolating transformer	MPL IEC625 Bus Variable isolating transformer	Erfi	91350	300001155	ne	-/-	-/-
8	n. a.	EMI Test Receiver 20Hz- 26,5GHz	ESU26	R&S	100037	300003555	k	07.12.2022	31.12.2023
9	n. a.	Highpass Filter	WHKX7.0/18G-8SS	Wainwright	19	300003790	ne	-/-	-/-
10	n. a.	Broadband Amplifier 0.5-18 GHz	CBLU5184540	CERNEX	22049	300004481	ev	-/-	-/-
11	n. a.	Broadband Amplifier 5-13 GHz	CBLU5135235	CERNEX	22010	300004491	ev	-/-	-/-
12	n. a.	4U RF Switch Platform	L4491A	Agilent Technologies	MY50000037	300004509	ne	-/-	-/-
13	n. a.	NEXIO EMV-Software	BAT EMC V3.16.0.49	EMCO		300004682	ne	-/-	-/-
14	n. a.	PC	ExOne	F+W		300004703	ne	-/-	-/-
15	n. a.	RF-Amplifier	AMF-6F06001800-30-10P-R	NARDA-MITEQ Inc	2011572	300005241	ev	-/-	-/-

7.2 Radiated measurements > 18 GHz

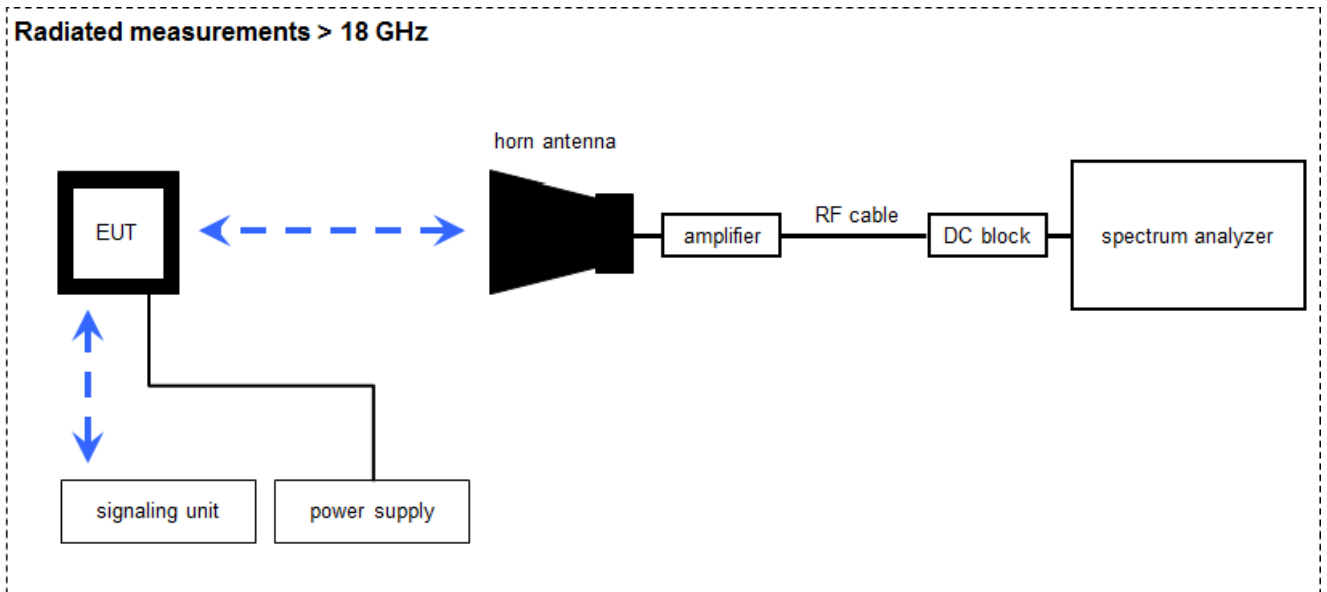

7.3 Radiated measurements > 50/85 GHz

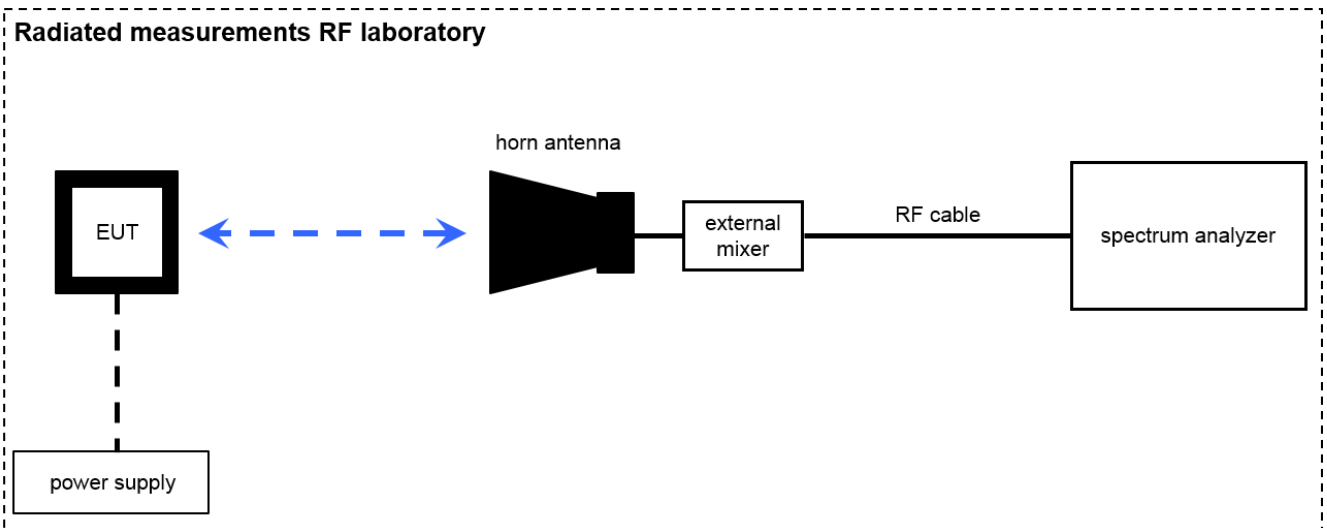

$$OP = AV + D - G$$

(OP-rad. output power; AV-analyzer value; D-free field attenuation of measurement distance; G-antenna gain)

Example calculation:

$$OP \text{ [dBm]} = -54.0 \text{ [dBm]} + 64.0 \text{ [dB]} - 20.0 \text{ [dBi]} = -10 \text{ [dBm]} \text{ (100 } \mu\text{W)}$$

Note: conversion loss of mixer is already included in analyzer value.

Equipment table:

No.	Lab / Item	Equipment	Type	Manufacturer	Serial No.	INV. No.	Kind of Calibration	Last Calibration	Next Calibration
1	n.a.	Horn Antenna 18,0-40,0 GHz	LHAF180	Microw.Devel	39180-103-021	300001747	vKI!	17.01.2022	31.01.2024
2	n. a.	Std. Gain Horn Antenna 18.0-26.5 GHz	638	Narda		300000486	vKI!	17.01.2022	31.01.2024
3	n. a.	Std. Gain Horn Antenna 26.5-40.0 GHz	V637	Narda	82-16	300000510	vKI!	17.01.2022	31.01.2024
4	n.a.	Std. Gain Horn Antenna 39.3-59.7 GHz	2424-20	Flann	75	300001979	ne	-/-	-/-
5	n. a.	Std. Gain Horn Antenna 49.9-75.8 GHz	2524-20	Flann	*	300001983	ne	-/-	-/-
6	n. a.	Std. Gain Horn Antenna 73.8-112 GHz	2724-20	Flann	*	300001988	ne	-/-	-/-
7	n. a.	Broadband LNA 18-50 GHz	CBL18503070PN	CERNEX	25240	300004948	ev	09.03.2022	08.03.2024
8	n. a.	Spectrum Analyzer 2 Hz - 85 GHz	FSW85	R&S	101333	300005568	k	11.07.2022	31.07.2023
9	n.a.	Power Supply	E3632A	Agilent Technologies	MY40001320	400000396	ev	-/-	-/-
10	n. a.	Temperature Test Chamber	VT4002	Heraeus Voetsch	521/83761	300002326	ev	12.05.2022	31.05.2024
11	n. a.	Harmonic Mixer 3-Port, 50-75 GHz	FS-Z75	Rohde & Schwarz	101578	300005788	k	07.07.2022	31.07.2023
12	n. a.	Harmonic Mixer 3-Port, 75-110 GHz	FS-Z110	R&S	101411	300004959	k	07.07.2022	31.07.2023

7.4 AC power-line conducted emissions

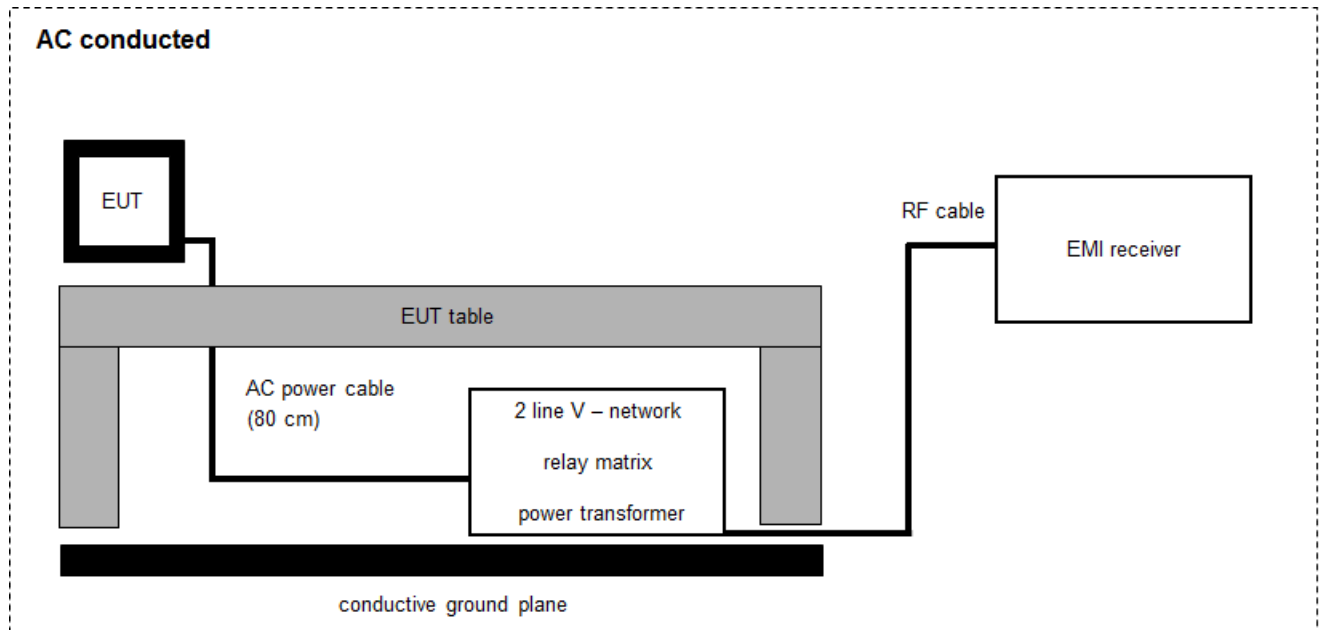

$$FS = UR + CF + VC$$

(FS-field strength; UR-voltage at the receiver; CR-loss of the cable and filter; VC-correction factor of the ISN)

Example calculation:

$$FS [dB\mu V/m] = 37.62 [dB\mu V/m] + 9.90 [dB] + 0.23 [dB] = 47.75 [dB\mu V/m] (244.06 \mu V/m)$$

Equipment table:

No.	Lab / Item	Equipment	Type	Manufacturer	Serial No.	INV. No.	Kind of Calibration	Last Calibration	Next Calibration
1	-/-	Two-line V-Network (LISN) 9 kHz to 30 MHz	ESH3-Z5	R&S	892475/017	300002209	vKI!	14.12.2021	31.12.2023
2	-/-	RF-Filter-section	85420E	HP	3427A00162	300002214	NK!	-/-	-/-
3	-/-	EMI Test Receiver	ESCI 3	R&S	101240	300004427	k	14.12.2022	31.12.2023
4	-/-	Hochpass 150 kHz	EZ-25	R&S	100010	300003798	ev	-/-	-/-

8 Sequence of testing

8.1 Sequence of testing radiated spurious 9 kHz to 30 MHz

Setup

- The equipment is set up to simulate normal operation mode as described in the user manual or defined by the manufacturer.
- If the EUT is a tabletop system, it is placed on a table with 0.8 m height.
- If the EUT is a floor standing device, it is placed directly on the turn table.
- Auxiliary equipment and cables are positioned to simulate normal operation conditions as described in ANSI C 63.4.
- The AC power port of the EUT (if available) is connected to a power outlet below the turntable.
- Measurement distance is 3 m (see ANSI C 63.4) – see test details.
- EUT is set into operation.

Premeasurement*

- The turntable rotates from 0° to 315° using 45° steps.
- The antenna height is 1 m.
- At each turntable position the analyzer sweeps with positive-peak detector to find the maximum of all emissions.

Final measurement

- Identified emissions during the pre-measurement are maximized by the software by rotating the turntable from 0° to 360°.
- Loop antenna is rotated about its vertical axis for maximum response at each azimuth about the EUT. (For certain applications, the loop antenna plane may also need to be positioned horizontally at the specified distance from the EUT)
- The final measurement is done in the position (turntable and elevation) causing the highest emissions with quasi-peak (as described in ANSI C 63.4).
- Final levels, frequency, measuring time, bandwidth, turntable position, correction factor, margin to the limit and limit will be recorded. A plot with the graph of the premeasurement and the limit is stored.

*Note: The sequence will be repeated three times with different EUT orientations.

8.2 Sequence of testing radiated spurious 30 MHz to 1 GHz

Setup

- The equipment is set up to simulate normal operation mode as described in the user manual or defined by the manufacturer.
- If the EUT is a tabletop system, a table with 0.8 m height is used, which is placed on the ground plane.
- If the EUT is a floor standing device, it is placed on the ground plane with insulation between both.
- Auxiliary equipment and cables are positioned to simulate normal operation conditions as described in ANSI C 63.4.
- The AC power port of the EUT (if available) is connected to a power outlet below the turntable.
- Measurement distance is 10 m or 3 m (see ANSI C 63.4) – see test details.
- EUT is set into operation.

Premeasurement

- The turntable rotates from 0° to 315° using 45° steps.
- The antenna is polarized vertical and horizontal.
- The antenna height changes from 1 m to 3 m.
- At each turntable position, antenna polarization and height the analyzer sweeps three times in peak to find the maximum of all emissions.

Final measurement

- The final measurement is performed for at least six highest peaks according to the requirements of the ANSI C63.4.
- Based on antenna and turntable positions at which the peak values are measured the software maximize the peaks by changing turntable position $\pm 45^\circ$ and antenna height between 1 and 4 m.
- The final measurement is done with quasi-peak detector (as described in ANSI C 63.4).
- Final levels, frequency, measuring time, bandwidth, antenna height, antenna polarization, turntable angle, correction factor, margin to the limit and limit are recorded. A plot with the graph of the premeasurement with marked maximum final results and the limit is stored.

8.3 Sequence of testing radiated spurious 1 GHz to 18 GHz

Setup

- The equipment is set up to simulate normal operation mode as described in the user manual or defined by the manufacturer.
- If the EUT is a tabletop system, a 2-axis positioner with 1.5 m height is used.
- If the EUT is a floor standing device, it is placed directly on the turn table.
- Auxiliary equipment and cables are positioned to simulate normal operation conditions as described in ANSI C 63.4.
- The AC power port of the EUT (if available) is connected to a power outlet below the turntable.
- Measurement distance is 3 m (see ANSI C 63.4) – see test details.
- EUT is set into operation.

Premeasurement

- The turntable rotates from 0° to 315° using 45° steps.
- The antenna is polarized vertical and horizontal.
- The antenna height is 1.5 m.
- At each turntable position and antenna polarization the analyzer sweeps with positive peak detector to find the maximum of all emissions.

Final measurement

- The final measurement is performed for at least six highest peaks according to the requirements of the ANSI C63.4.
- Based on antenna and turntable positions at which the peak values are measured the software maximizes the peaks by rotating the turntable from 0° to 360°. This measurement is repeated for different EUT-table positions (0° to 150° in 30°-steps) and for both antenna polarizations.
- The final measurement is done in the position (turntable, EUT-table and antenna polarization) causing the highest emissions with Peak and RMS detector (as described in ANSI C 63.4).
- Final levels, frequency, measuring time, bandwidth, turntable position, EUT-table position, antenna polarization, correction factor, margin to the limit and limit are recorded. A plot with the graph of the premeasurement with marked maximum final results and the limit is stored.

8.4 Sequence of testing radiated spurious above 18 GHz

Setup

- The equipment is set up to simulate normal operation mode as described in the user manual or defined by the manufacturer.
- Auxiliary equipment and cables are positioned to simulate normal operation conditions as described in ANSI C 63.4.
- The AC power port of the EUT (if available) is connected to a power outlet.
- The measurement distance is as appropriate (e.g. 0.5 m).
- The EUT is set into operation.

Premeasurement

- The test antenna is handheld and moved carefully over the EUT to cover the EUT's whole sphere and different polarizations of the antenna.

Final measurement

- The final measurement is performed at the position and antenna orientation causing the highest emissions with Peak and RMS detector (as described in ANSI C 63.4).
- Final levels, frequency, measuring time, bandwidth, correction factor, margin to the limit and limit are recorded. A plot with the graph of the premeasurement and the limit is stored.

8.5 Sequence of testing radiated spurious above 50/85 GHz with external mixers

Setup

- The equipment is set up to simulate normal operation mode as described in the user manual or defined by the manufacturer.
- Auxiliary equipment and cables are positioned to simulate normal operation conditions as described in ANSI C 63.4.
- The AC power port of the EUT (if available) is connected to a power outlet.
- The measurement distance is as appropriate for far field (e.g. 0.25 m).
- The EUT is set into operation.

Premeasurement

- The test antenna with external mixer is handheld and moved carefully over the EUT to cover the EUT's whole sphere and different polarizations of the antenna.
- Caution is taken to reduce the possible overloading of the external mixer.

Final measurement

- The final measurement is performed at the position and antenna orientation causing the highest emissions with Peak and RMS detector (as described in ANSI C 63.4).
- As external mixers may generate false images care is taken to ensure that any emission measured by the spectrum analyzer does indeed originate in the EUT. Signal identification feature of spectrum analyzer is used to eliminate false mixer images (i.e., it is not the fundamental emission or a harmonic falling precisely at the measured frequency).
- Final levels, frequency, measuring time, bandwidth, correction factor, margin to the limit and limit are recorded. A plot with the graph of the premeasurement and the limit is stored.

9 Measurement uncertainty

Test case	Uncertainty
Equivalent isotropically radiated power (e.i.r.p.)	Conducted value ± 1 dB Radiated value ± 3 dB
Permitted range of operating frequencies	± 100 kHz
Conducted unwanted emissions in the spurious domain (up to 40 GHz)	± 1 dB
Radiated unwanted emissions in the spurious domain (up to 40 GHz)	± 3 dB
Conducted unwanted emissions in the spurious domain (40 to 50 GHz)	± 4 dB
Radiated unwanted emissions in the spurious domain (40 to 50 GHz)	± 4 dB
Conducted unwanted emissions in the spurious domain (50 to 300 GHz)	± 5 dB
Radiated unwanted emissions in the spurious domain (50 to 300 GHz)	± 5 dB
DC and low frequency voltages	± 3 %
Temperature	± 1 °C
Humidity	± 3 %

10 Far field consideration for measurements above 18 GHz

Far field distance calculation:

$$D_{ff} = 2 \times D^2 / \lambda$$

with

D_{ff} Far field distance
 D Antenna dimension
 λ wavelength

Spurious emission measurements:

Antenna frequency range in GHz	Highest measured frequency in GHz	D in cm	λ in cm	D_{ff} in cm
18-26	26	3.4	1.15	20.04
26-40	40	2.2	0.75	12.91
40-50	50	2.77	0.60	25.58
50-75	75	1.85	0.40	17.11
75-110	110	1.24	0.27	11.28

11 Summary of measurement results

<input checked="" type="checkbox"/>	No deviations from the technical specifications were ascertained
<input type="checkbox"/>	There were deviations from the technical specifications ascertained
<input type="checkbox"/>	This test report is only a partial test report. The content and verdict of the performed test cases are listed below.

TC Identifier	Description	Verdict	Date	Remark
RF-Testing	47 CFR Part 15	Passed	2023-02-02	-/-

Test specification clause	Test case	Temperature conditions	Power source voltages	C	NC	NA	NP	Results (max.)
§15.249(a)	Field strength of emissions (wanted signal)	Nominal	Nominal	<input checked="" type="checkbox"/>	<input type="checkbox"/>	<input type="checkbox"/>	<input type="checkbox"/>	101.3 dBµV (PEAK) 64.2 dBµV (AVG)
§2.1049	Occupied bandwidth (99% bandwidth)	Nominal	Nominal	<input checked="" type="checkbox"/>	<input type="checkbox"/>	<input type="checkbox"/>	<input type="checkbox"/>	171.4 MHz
§15.209(a) §15.249(d)	Field strength of emissions (radiated spurious)	Nominal	Nominal	<input checked="" type="checkbox"/>	<input type="checkbox"/>	<input type="checkbox"/>	<input type="checkbox"/>	complies
§15.207(a)	Conducted emissions < 30 MHz	Nominal	Nominal	<input checked="" type="checkbox"/>	<input type="checkbox"/>	<input type="checkbox"/>	<input type="checkbox"/>	complies
§15.215(c)	Frequency Stability	Nominal Extreme	Nominal Extreme	<input checked="" type="checkbox"/>	<input type="checkbox"/>	<input type="checkbox"/>	<input type="checkbox"/>	complies

Note: C = Compliant; NC = Not compliant; NA = Not applicable; NP = Not performed

12 Measurement results

12.1 Field strength of fundamental emission

Description:

Measurement of the maximum radiated field strength of the wanted signal.

Measurement:

Measurement parameter	
Detector:	Pos-Peak / Average
Sweep time:	See plots
Resolution bandwidth:	1 MHz
Video bandwidth:	3 MHz
Span:	See plots
Trace-Mode:	Max Hold

This test was performed on a shorter test distance. A correction factor of $20 \cdot \log(x \text{ m}/3 \text{ m})$ is already considered in the plots.

Limits:

FCC		
CFR Part 15.249(a)		
Field strength of emissions		
The field strength of emissions from intentional radiators operated within these frequency bands shall comply with the following:		
Frequency	Field Strength	Measurement distance
24.0 GHz – 24.25 GHz	108 dB μ V/m (Average) 128 dB μ V/m (PEAK)	3 m

§15.249 (e) As shown in § 15.35(b), for frequencies above 1000 MHz, the field strength limits in paragraphs (a) and (b) of this section are based on average limits. However, the peak field strength of any emission shall not exceed the maximum permitted average limits specified above by more than 20 dB under any condition of modulation.

§15.31 (c) Except as otherwise indicated in §15.256, for swept frequency equipment, measurements shall be made with the frequency sweep stopped at those frequencies chosen for the measurements to be reported.

Measurement results:

Test condition T_{nom} / V_{nom}	Maximum field strength (Peak) (dB μ V/m @3m)	Maximum field strength (Average) (dB μ V/m @3m)
Normal Mode	101.3	64.2
Stopped Mode Low Ch.	103.9	103.7
Stopped Mode Middle Ch.	103.7	103.3
Stopped Mode High Ch.	103.9	103.1

Plot No. 1: Normal Mode, Field Strength, T_{nom} / V_{nom}

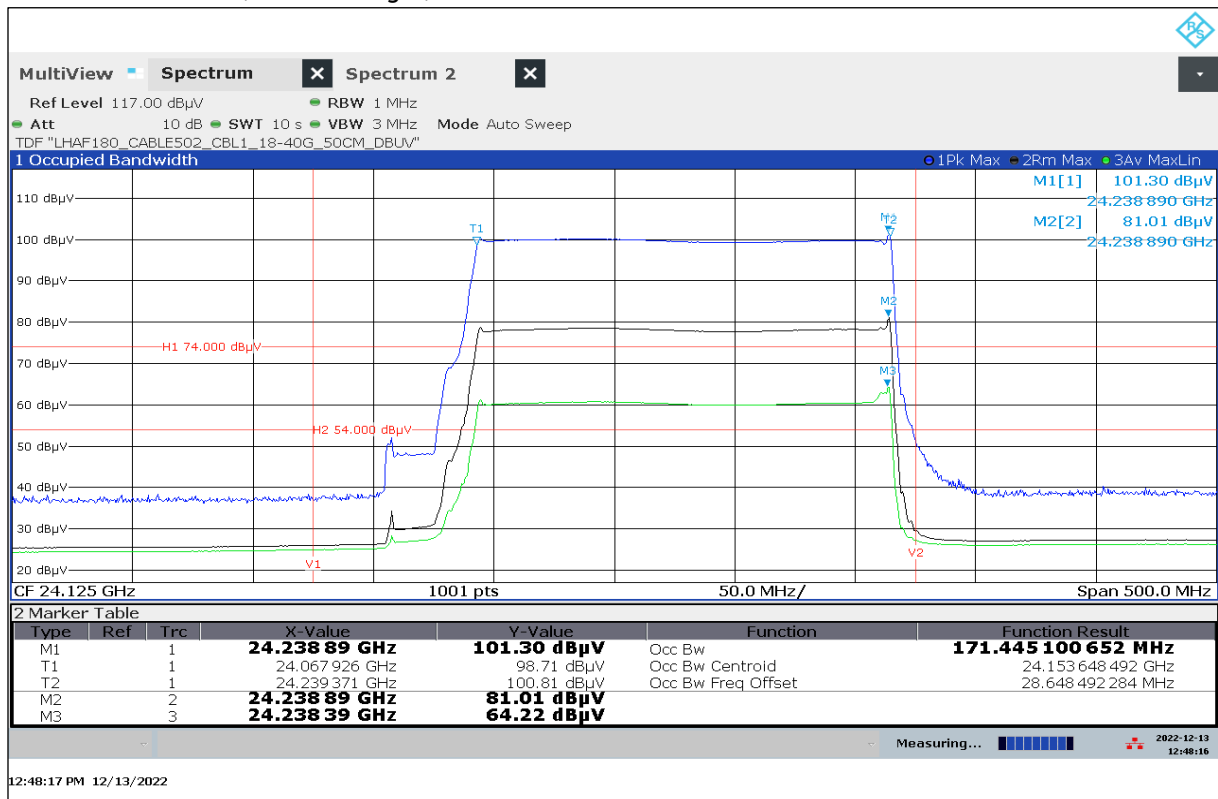

Plot No. 2: Stopped Mode Low-Middle-High Channel, Field Strength @ Peak Detector, T_{nom} / V_{nom}

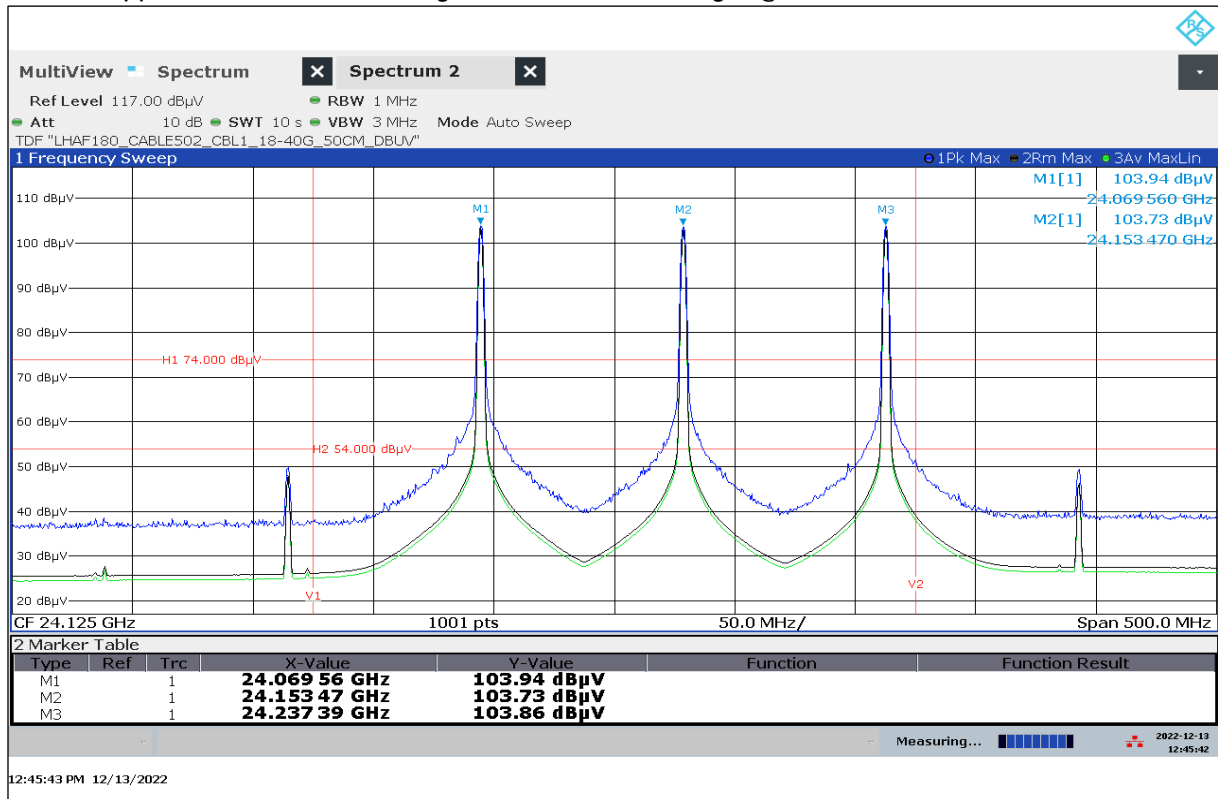

Plot No. 3: Stopped Mode Low-Middle-High Channel, Field strength @ Average Detector, T_{nom} / V_{nom}

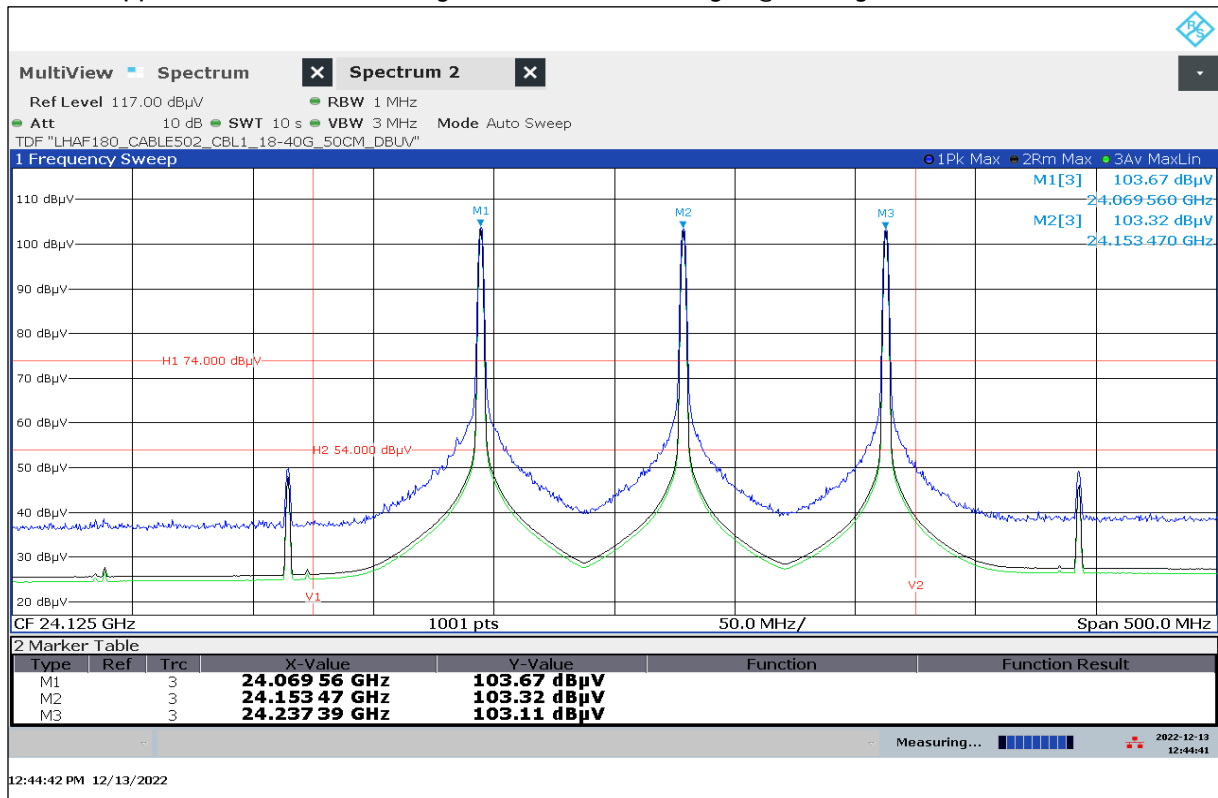

12.2 Occupied bandwidth (99% bandwidth)

Description:

Measurement of the 99% bandwidth of the wanted signal.

Measurement:

Parameter	
Detector:	Pos-Peak
Sweep time:	See plots
Resolution bandwidth:	1 MHz
Video bandwidth:	3 MHz
Span:	See plots
Trace-Mode:	Max Hold

Limits:

FCC	IC	
CFR Part 15.249(a)	RSS-210, B.10	
The field strength of emissions from intentional radiators operated within the specified frequency band shall comply with the following		
Frequency range	f_L	f_H
250 MHz	> 24.0 GHz	< 24.25 GHz

Measurement results:

Test condition T_{nom} / V_{nom}	f_L [GHz]	f_H [GHz]	Occupied bandwidth [MHz]
Normal Mode	24.067 926	24.239 371	171.4

12.3 Field strength of emissions (radiated spurious)

Description:

Measurement of the radiated spurious emissions in transmit mode.

Measurement:

Parameter	
Detector:	Quasi-Peak / Pos-Peak / Average
Sweep time:	Auto
Resolution bandwidth:	100 kHz / 1 MHz
Video bandwidth:	300 kHz / 3 MHz
Trace-Mode:	Max Hold

Limits:

FCC		
CFR Part 15.209(a) / CFR Part 15.249(d)		
Emissions radiated outside of the specified frequency bands, except for harmonics, shall be attenuated by at least 50 dB below the level of the fundamental or to the general radiated emission limits in § 15.209, whichever is the lesser attenuation.		
Frequency (MHz)	Field Strength ($\mu\text{V}/\text{m}$)	Measurement distance (m)
0.009 – 0.490	$2400/F(\text{kHz})$	300
0.490 – 1.705	$24000/F(\text{kHz})$	30
1.705 – 30.0	30	30
30 – 88	100	3
88 – 216	150	3
216 – 960	200	3
Above 960	500	3

§15.249 (e) As shown in § 15.35(b), for frequencies above 1000 MHz, the field strength limits in paragraphs (a) and (b) of this section are based on average limits. However, the peak field strength of any emission shall not exceed the maximum permitted average limits specified above by more than 20 dB under any condition of modulation.

§15.31 (c) Except as otherwise indicated in §15.256, for swept frequency equipment, measurements shall be made with the frequency sweep stopped at those frequencies chosen for the measurements to be reported.

Measurement results:

Frequency in [GHz]	Detector	Bandwidth [MHz]	Level [dB μ V]	Distance [m]	Limit [dB μ V]	Margin [dB]
Normal Mode 24.25 GHz	Peak	1	52.07	1	74	21.93
	AVG	1	26.94	1	54	27.06
Stopped Mode Low Ch. 48.1 GHz	Peak	1	52.24	1	74	21.76
	AVG	1	48.11	1	54	5.89
Stopped Mode Middle Ch.48.3 GHz	Peak	1	51.49	1	74	22.51
	AVG	1	47.14	1	54	6.86
Stopped Mode High Ch.48.5 GHz	Peak	1	49.33	1	74	24.67
	AVG	1	44.13	1	54	9.87

Plot No. 4: 9 kHz to 30 MHz, Normal Mode, horizontal/vertical polarization

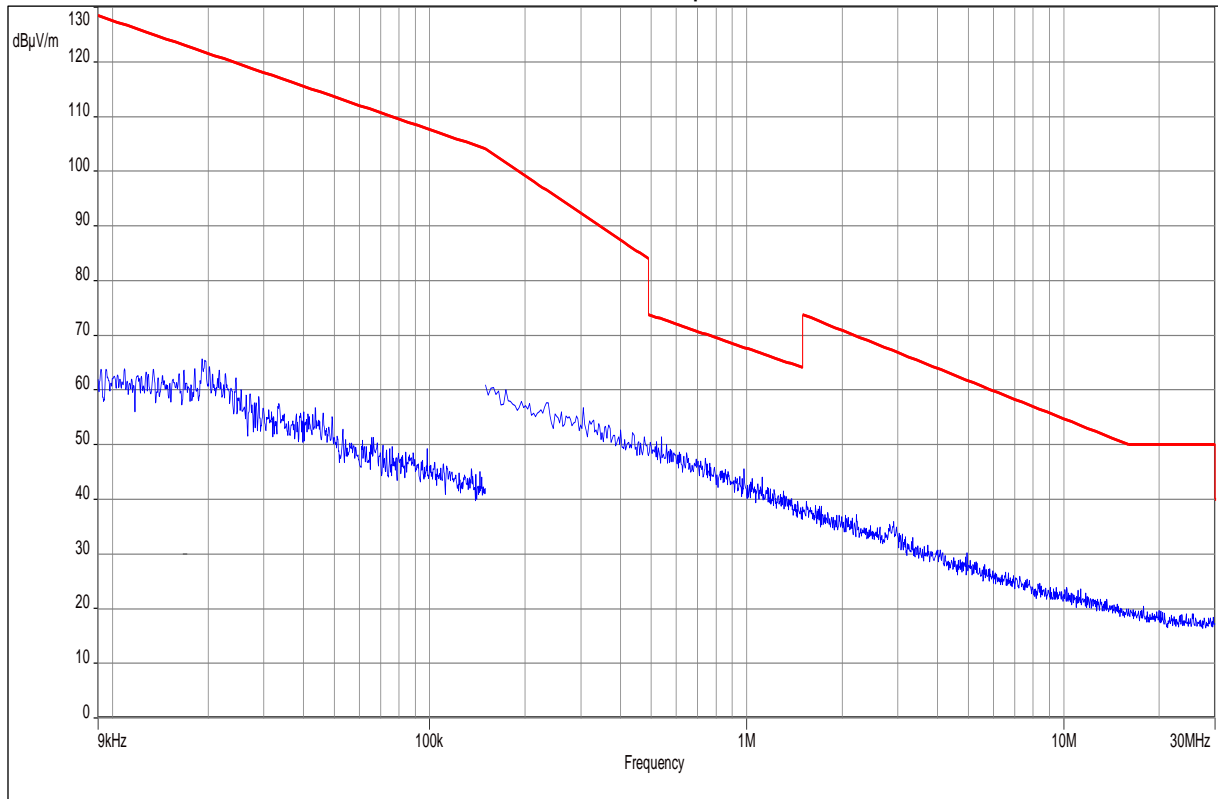

Plot No. 5: 9 kHz to 30 MHz, Stopped Mode Low-Middle-High Channel, horizontal/vertical polarization

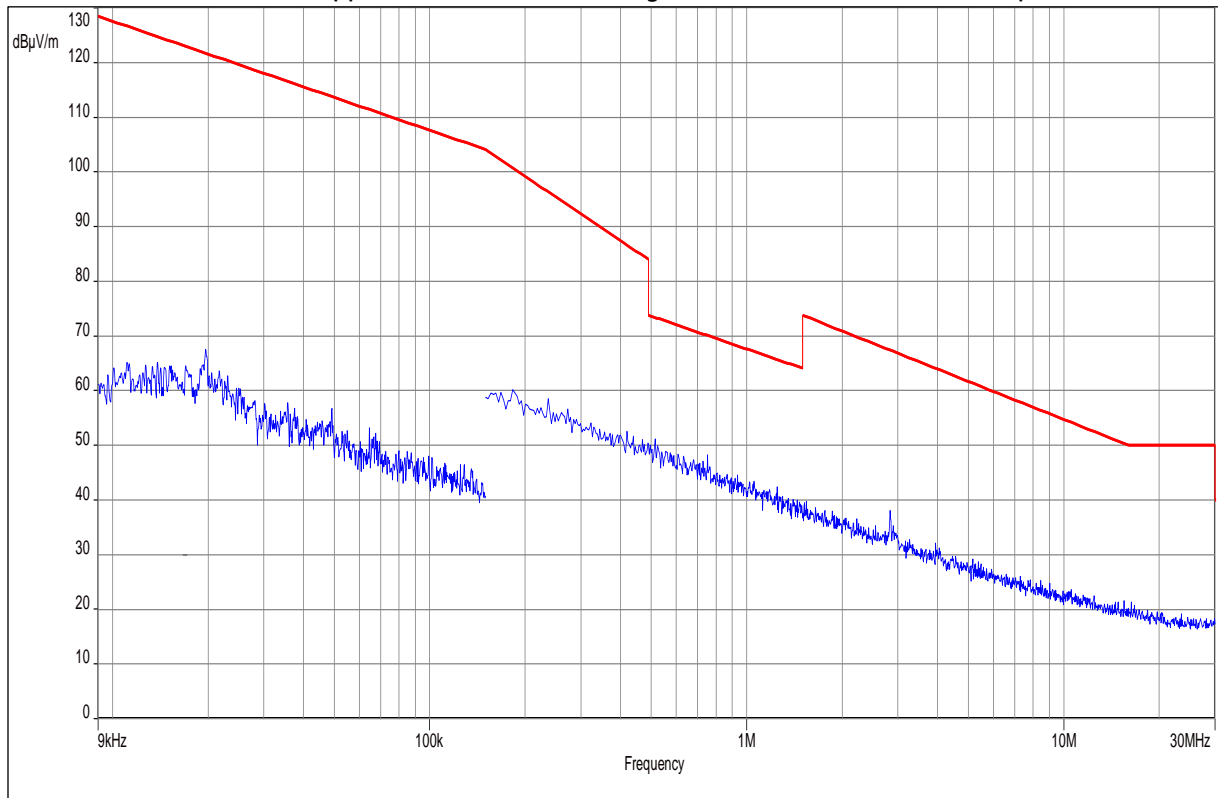

Plot No. 6: 30 MHz to 1 GHz, Normal Mode, horizontal/vertical polarization

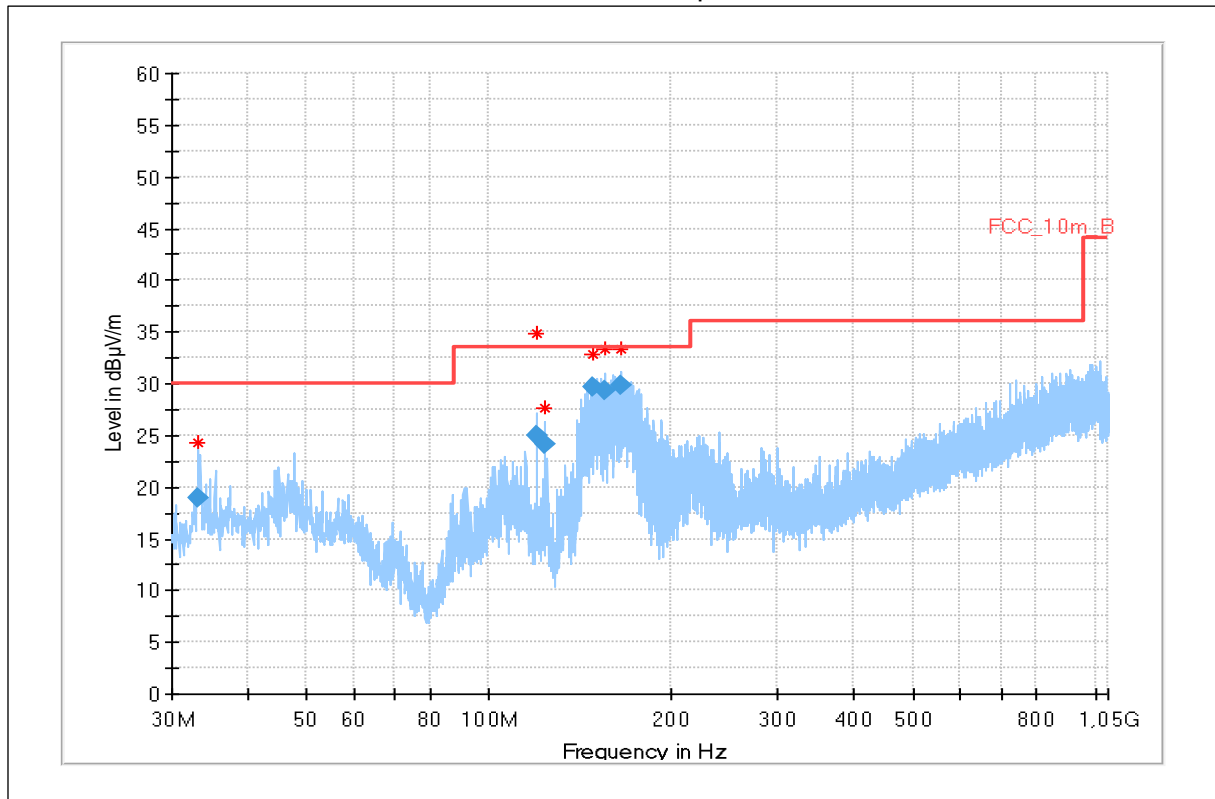

Frequency (MHz)	QuasiPeak (dBµV/m)	Limit (dBµV/m)	Margin (dB)	Meas. Time (ms)	Bandwidth (kHz)	Height (cm)	Pol	Azimuth (deg)	Corr. (dB/m)
33.173	18.98	30.0	11.0	1000	120.0	116.0	V	144	14
120.030	24.93	33.5	8.6	1000	120.0	195.0	V	307	11
123.516	24.19	33.5	9.3	1000	120.0	156.0	V	293	10
148.930	29.61	33.5	3.9	1000	120.0	104.0	V	57	10
155.085	29.32	33.5	4.2	1000	120.0	114.0	V	-16	10
164.812	29.78	33.5	3.7	1000	120.0	102.0	V	-3	11

Plot No. 7: 30 MHz to 1 GHz, Stopped Mode Low Channel, horizontal/vertical polarization

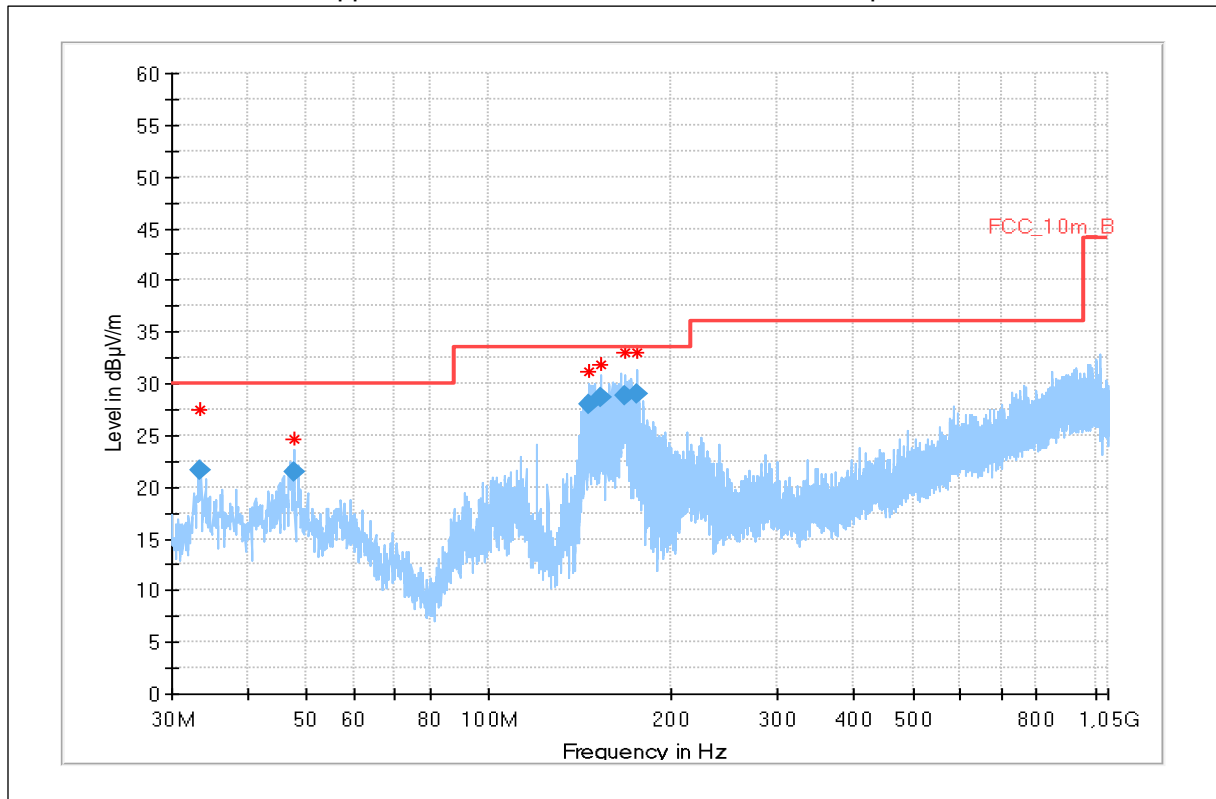

Frequency (MHz)	QuasiPeak (dBµV/m)	Limit (dBµV/m)	Margin (dB)	Meas. Time (ms)	Bandwidth (kHz)	Height (cm)	Pol	Azimuth (deg)	Corr. (dB/m)
33.455	21.59	30.0	8.4	1000	120.0	121.0	V	121	14
47.802	21.42	30.0	8.6	1000	120.0	163.0	V	104	16
145.643	28.03	33.5	5.5	1000	120.0	98.0	V	-10	10
153.263	28.71	33.5	4.8	1000	120.0	113.0	V	-7	10
168.012	28.89	33.5	4.6	1000	120.0	98.0	V	-34	11
174.954	28.94	33.5	4.6	1000	120.0	102.0	V	-12	11

Plot No. 8: 30 MHz to 1 GHz, Stopped Mode Middle Channel, horizontal/vertical polarization

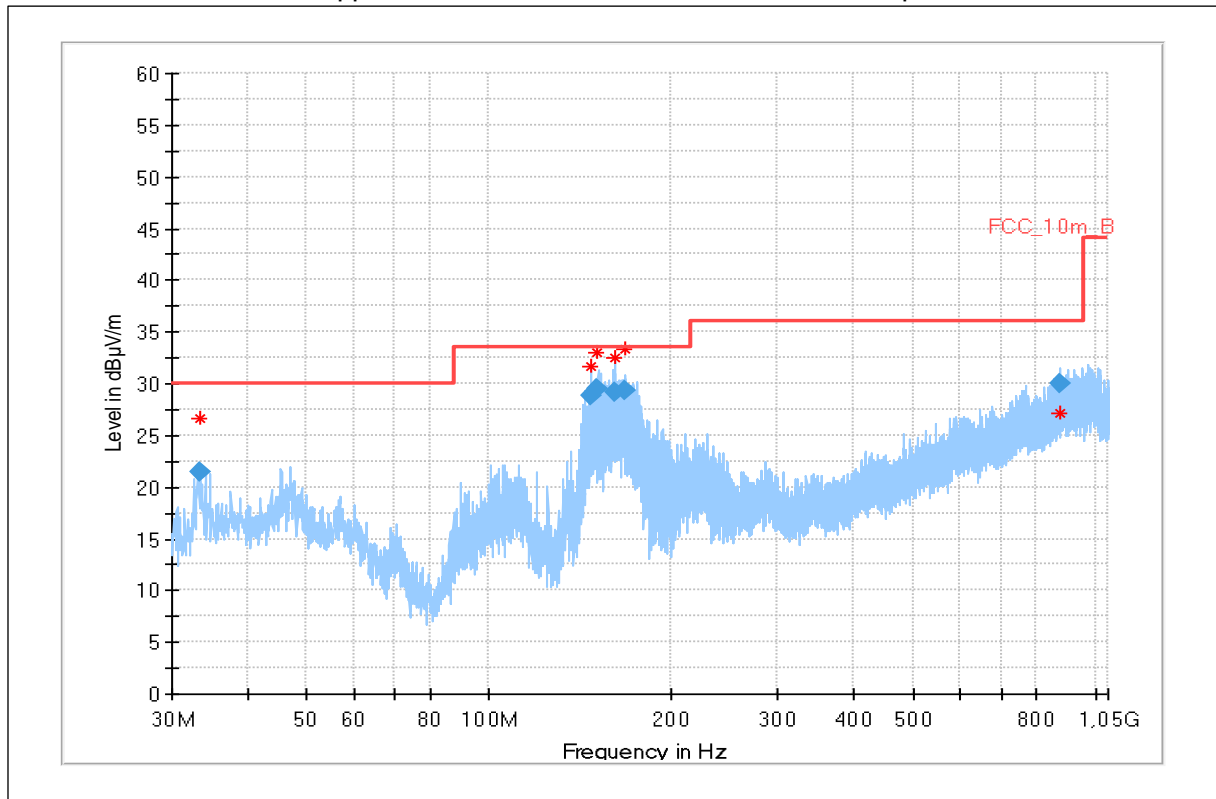

Frequency (MHz)	QuasiPeak (dBµV/m)	Limit (dBµV/m)	Margin (dB)	Meas. Time (ms)	Bandwidth (kHz)	Height (cm)	Pol	Azimuth (deg)	Corr. (dB/m)
33.428	21.53	30.0	8.5	1000	120.0	106.0	V	127	14
147.144	28.79	33.5	4.7	1000	120.0	102.0	V	25	10
151.220	29.46	33.5	4.0	1000	120.0	104.0	V	16	10
161.540	29.24	33.5	4.3	1000	120.0	136.0	V	-24	10
167.446	29.25	33.5	4.3	1000	120.0	98.0	V	-9	11
873.967	30.08	36.0	5.9	1000	120.0	105.0	H	251	25

Plot No. 9: 30 MHz to 1 GHz, Stopped Mode High Channel, horizontal/vertical polarization

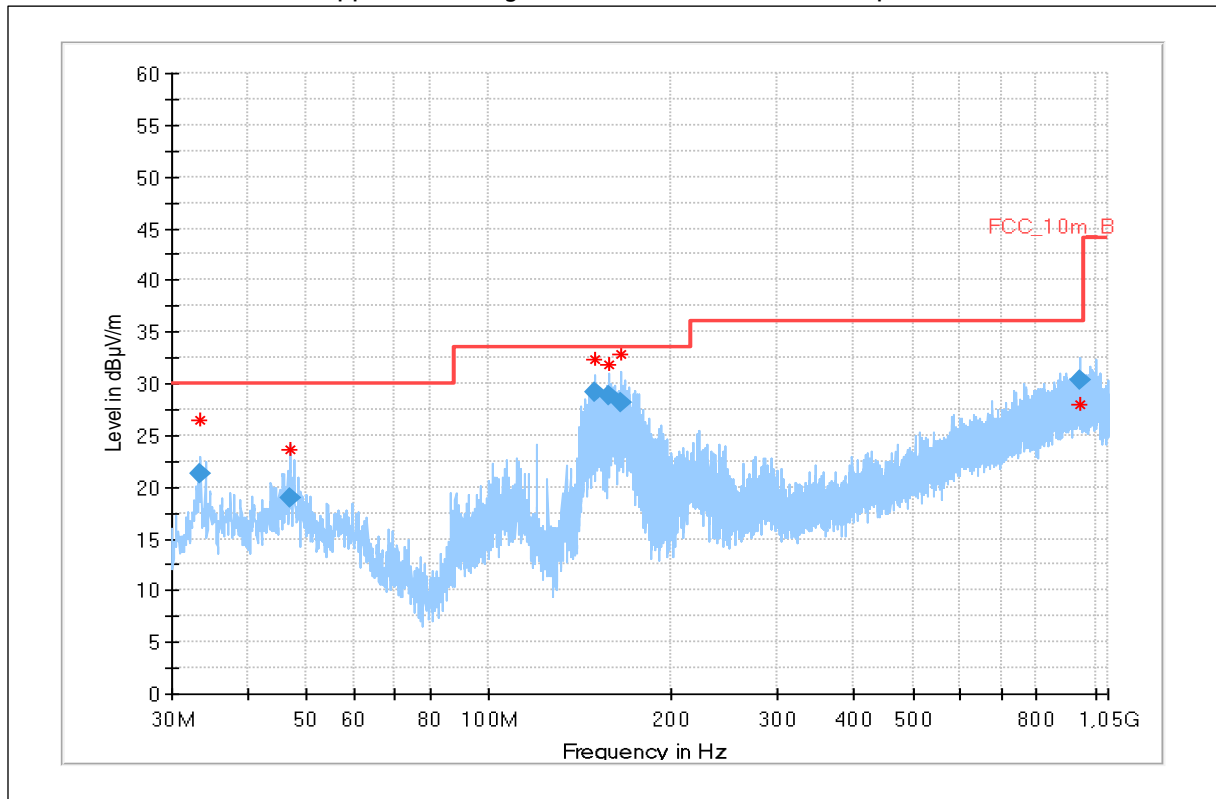

Frequency (MHz)	QuasiPeak (dBµV/m)	Limit (dBµV/m)	Margin (dB)	Meas. Time (ms)	Bandwidth (kHz)	Height (cm)	Pol	Azimuth (deg)	Corr. (dB/m)
33.449	21.28	30.0	8.7	1000	120.0	121.0	V	14	14
47.147	18.90	30.0	11.1	1000	120.0	104.0	V	12	16
149.090	29.10	33.5	4.4	1000	120.0	102.0	V	18	10
158.014	28.81	33.5	4.7	1000	120.0	104.0	V	5	10
164.484	28.24	33.5	5.3	1000	120.0	101.0	V	-13	11
946.304	30.35	36.0	5.7	1000	120.0	195.0	V	92	25

Plot No. 10: 1 GHz to 18 GHz, Normal Mode, horizontal/vertical polarization

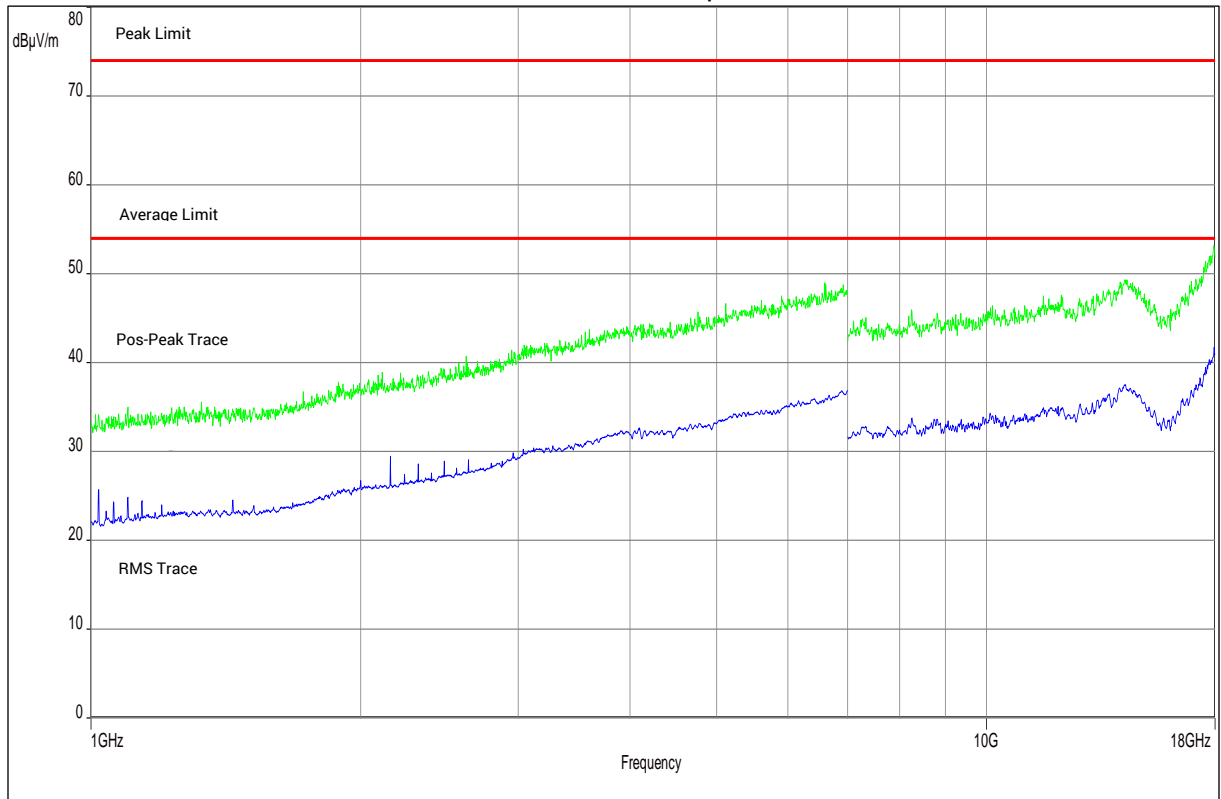

Plot No. 11: 1 GHz to 18 GHz, Stopped Mode Low Channel, horizontal/vertical polarization

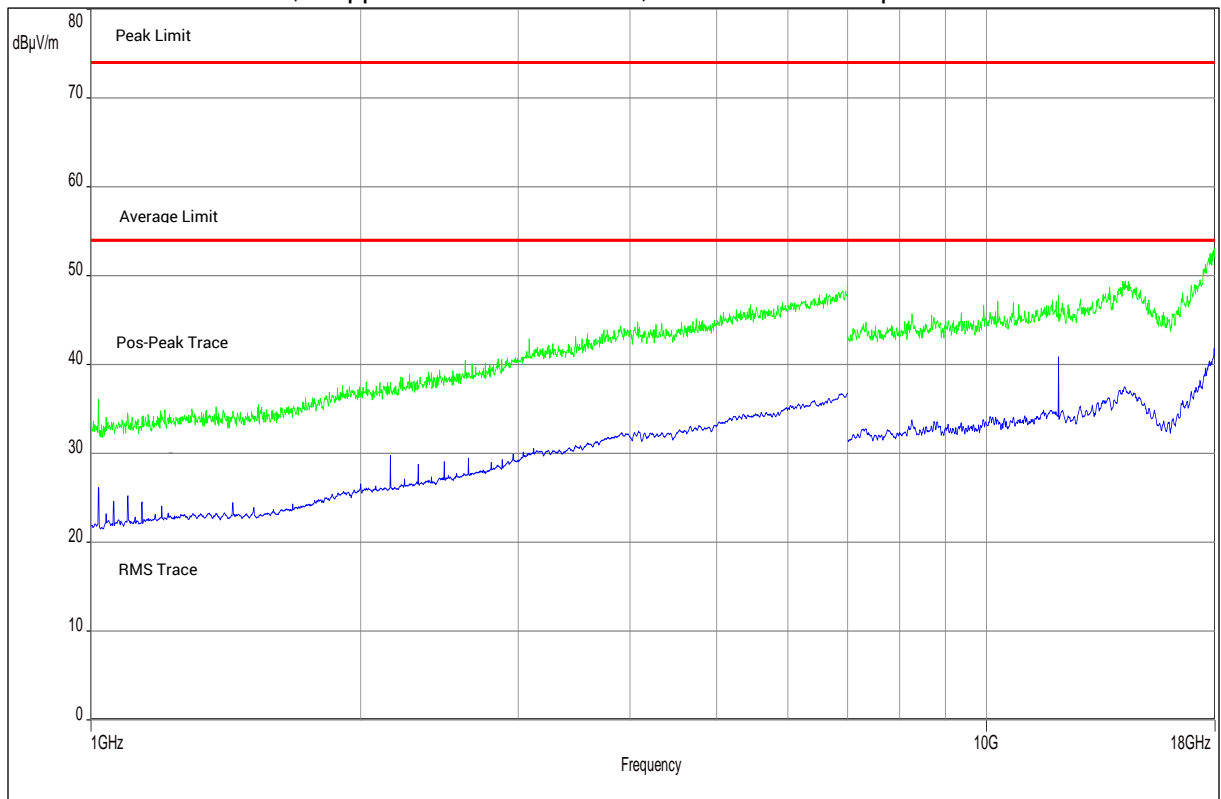

Plot No. 12: 1 GHz to 18 GHz, Stopped Mode Middle Channel, horizontal/vertical polarization

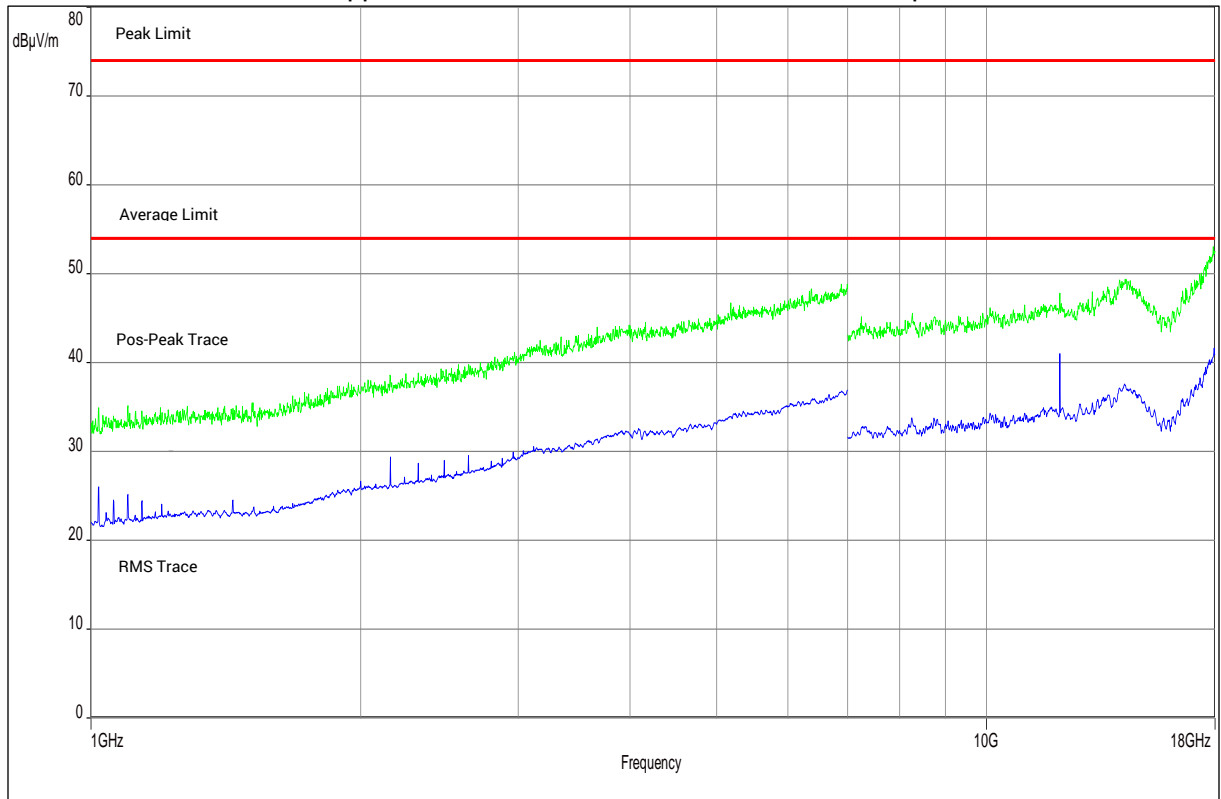

Plot No. 13: 1 GHz to 18 GHz, Stopped Mode High Channel, horizontal/vertical polarization

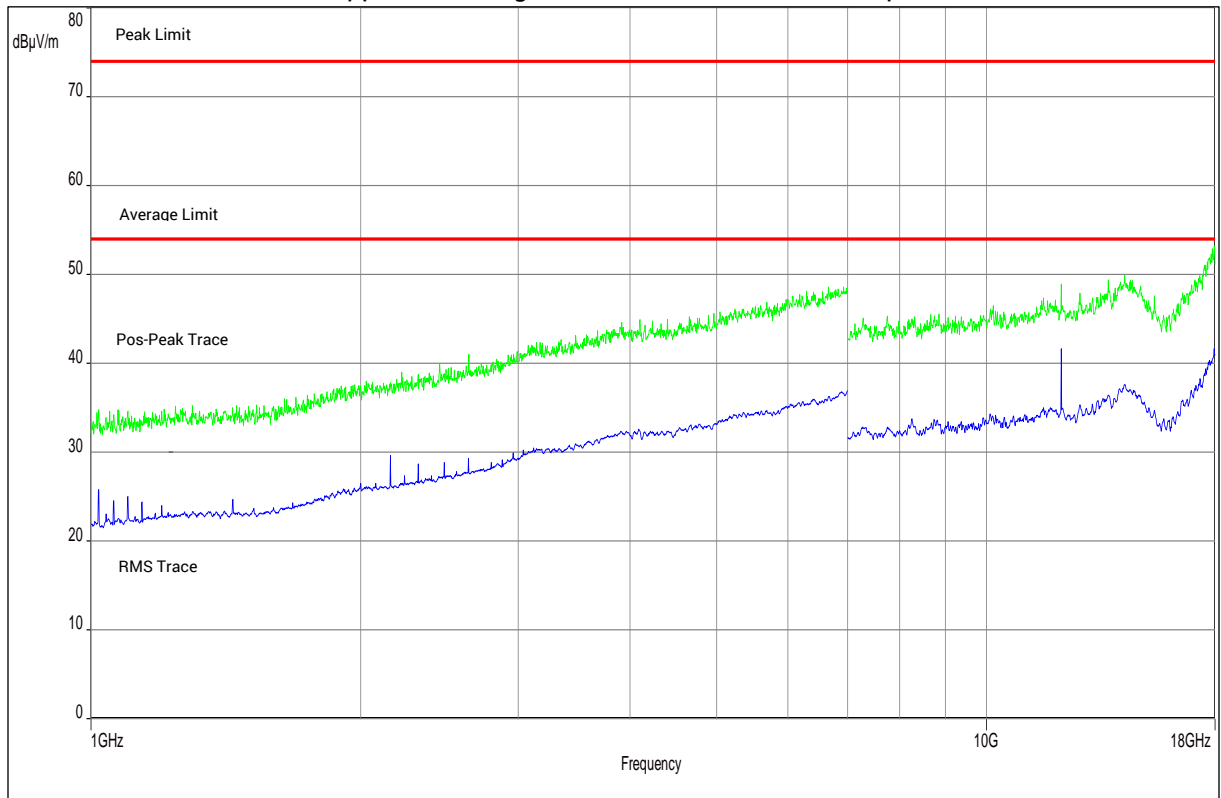

Plot No. 14: 18 GHz to 40 GHz, Normal Mode, horizontal/vertical polarization

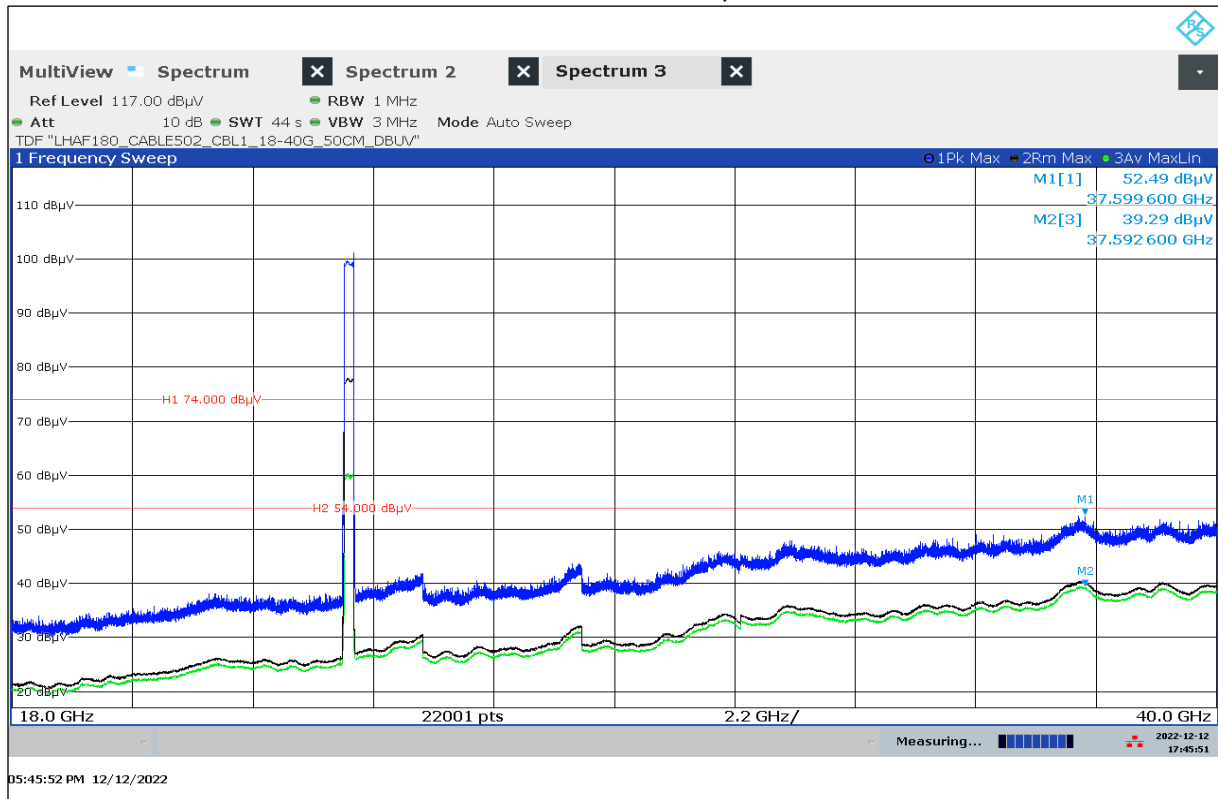

Plot No. 15: Band Edge Low, Normal Mode, horizontal/vertical polarization

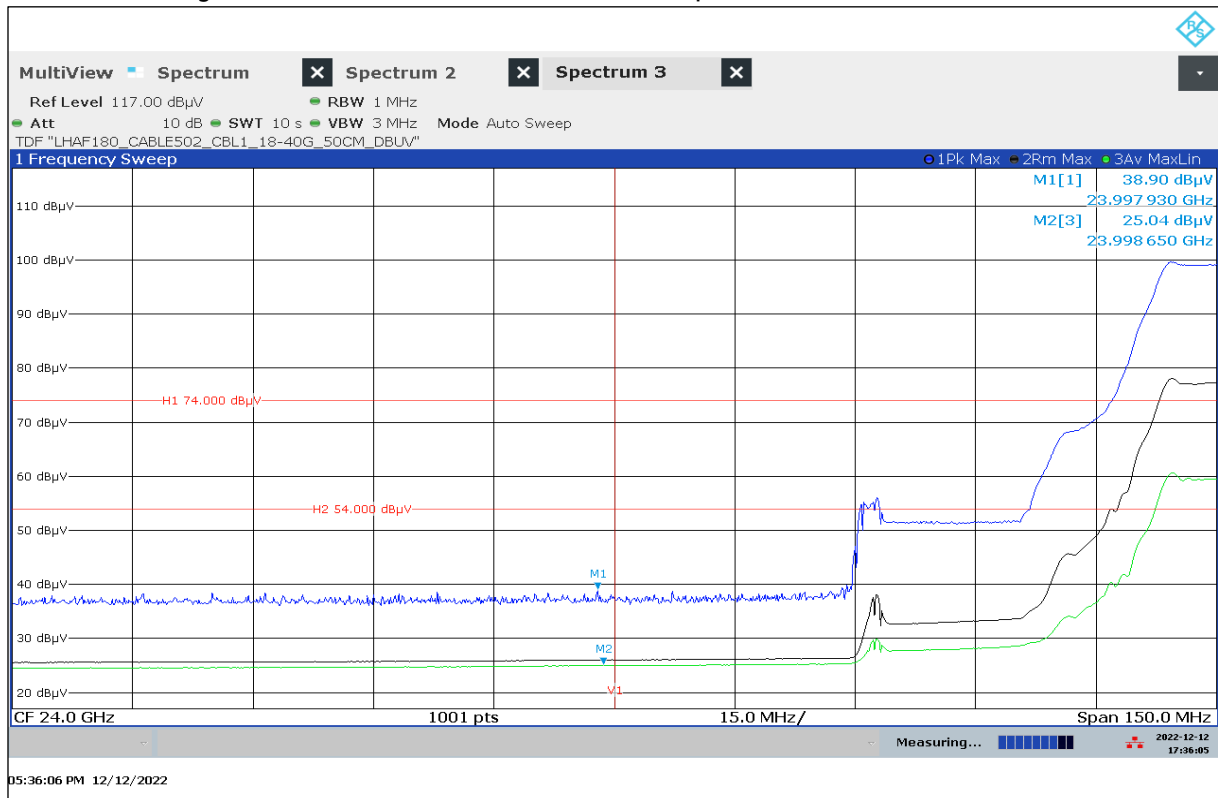

Plot No. 16: Band Edge High, Normal Mode, horizontal/vertical polarization

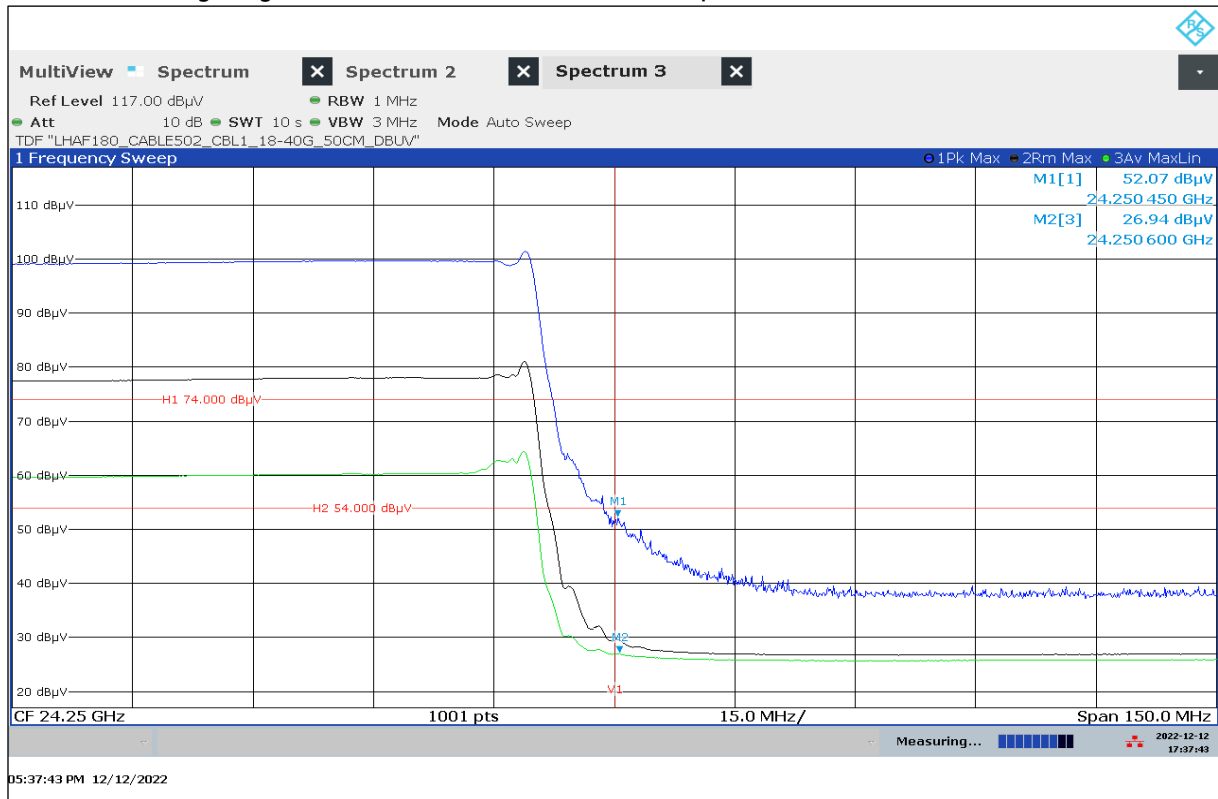

Plot No. 17: 18 GHz to 40 GHz, Stopped Mode Low-Middle-High Channel, horizontal/vertical polarization

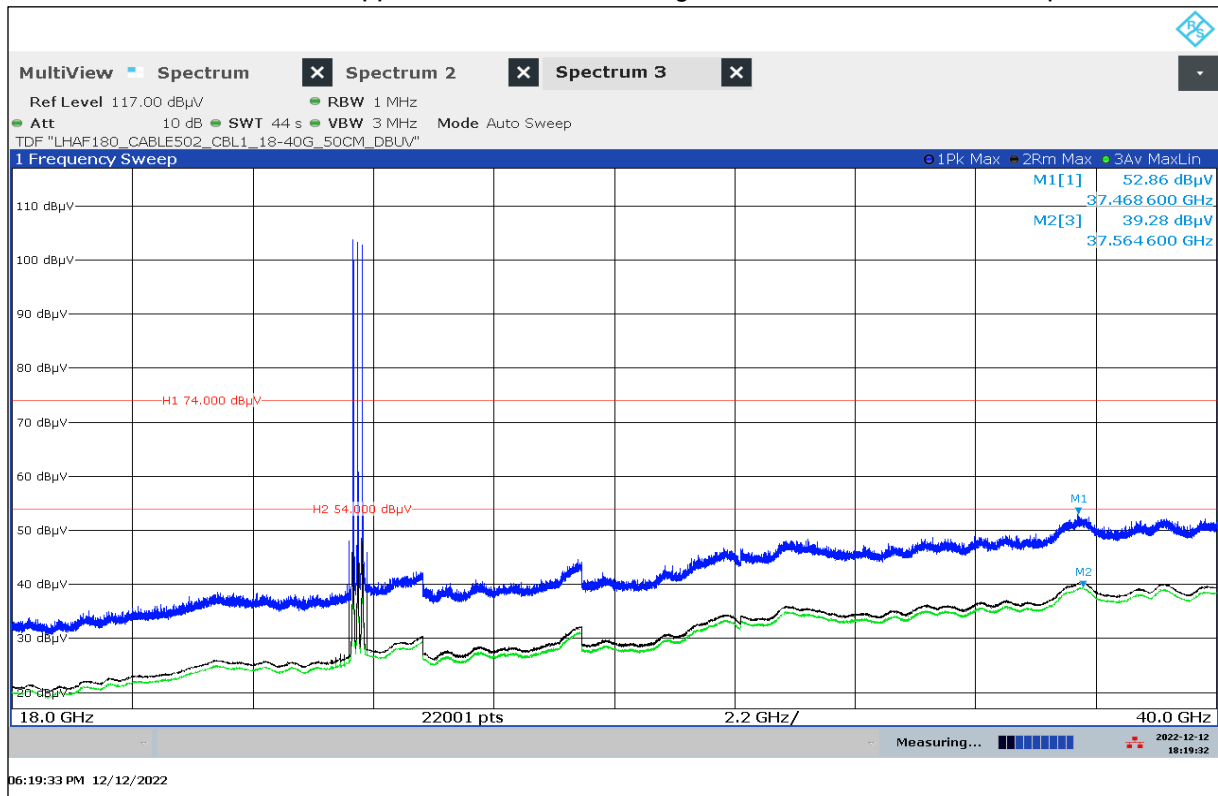

Plot No. 18: Band Edge Low, Stopped Mode Low Channel, horizontal/vertical polarization

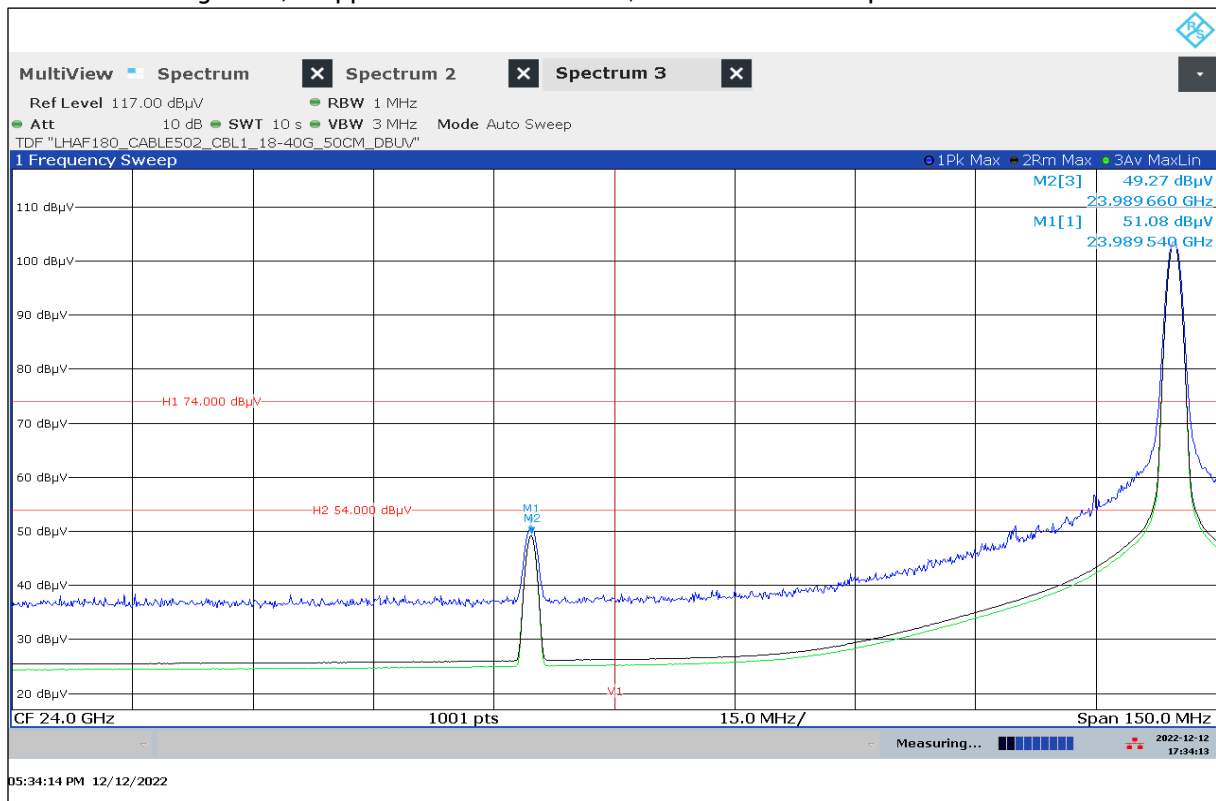

Plot No. 19: Band Edge High, Stopped Mode High Channel, horizontal/vertical polarization

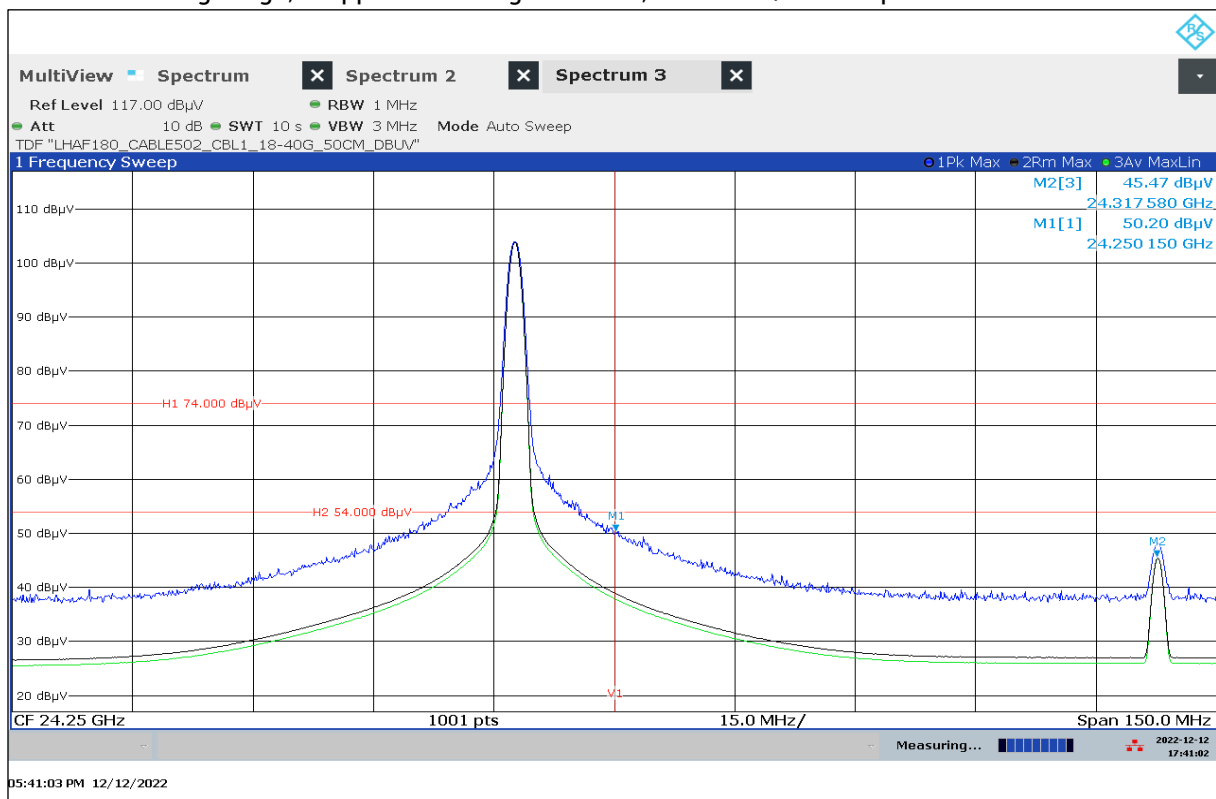

Plot No. 20: 40 GHz to 50 GHz, Normal Mode, horizontal/vertical polarization

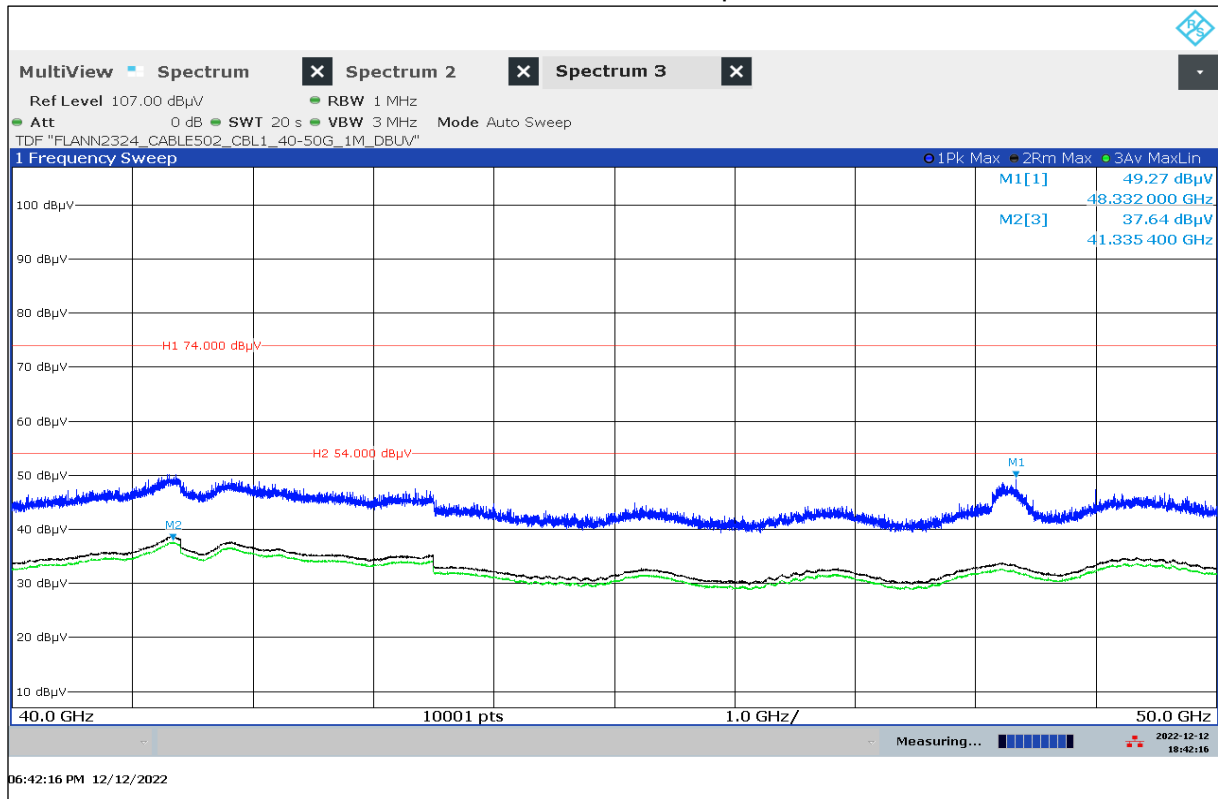

Plot No. 21: 48 GHz, Normal Mode, horizontal/vertical polarization

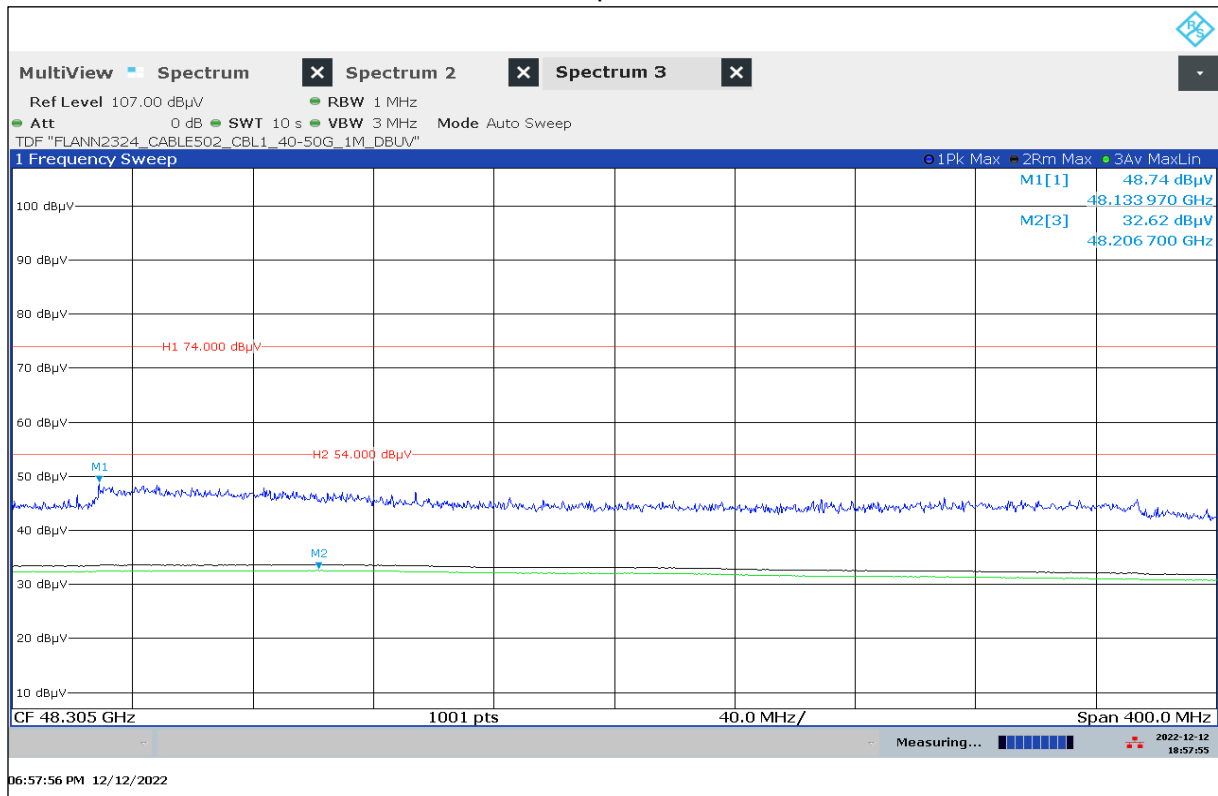

Plot No. 22: 40 GHz to 50 GHz, Stopped Mode Low-Middle-High Channel, horizontal/vertical polarization

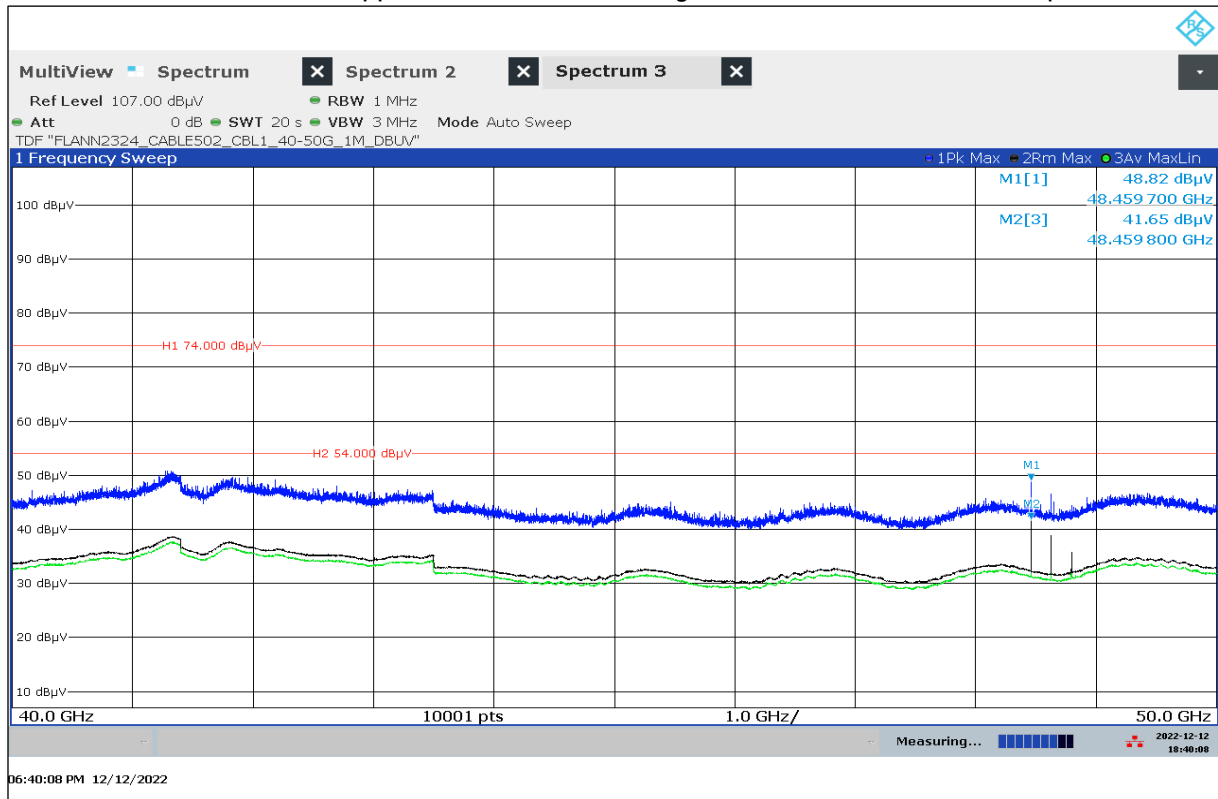

Plot No. 23: 48 GHz, Stopped Mode Low-Middle-High Channel @ Peak detector, horizontal/vertical polarization

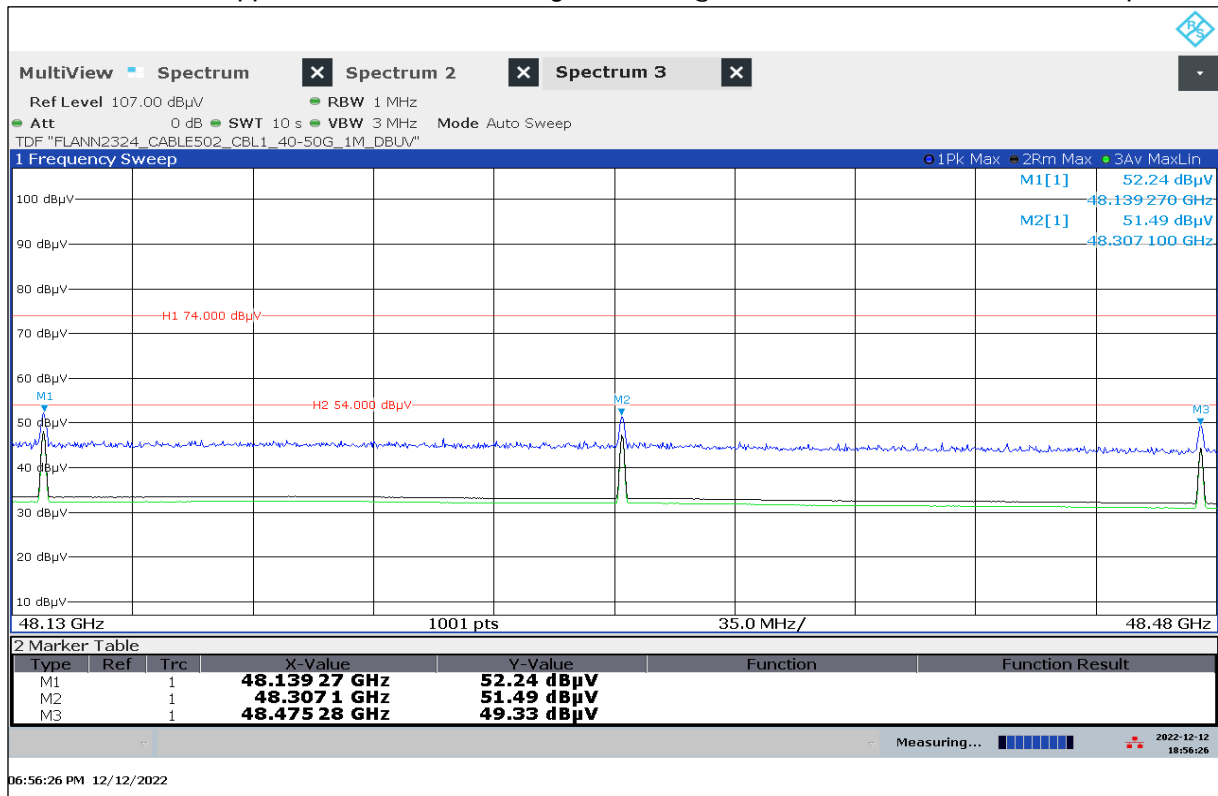

Plot No. 24: 48 GHz, Stopped Mode Low-Middle-High Channel @ AVG detector, horizontal/vertical polarization



Plot No. 25: 50 GHz to 75 GHz, Normal Mode, horizontal/vertical polarization

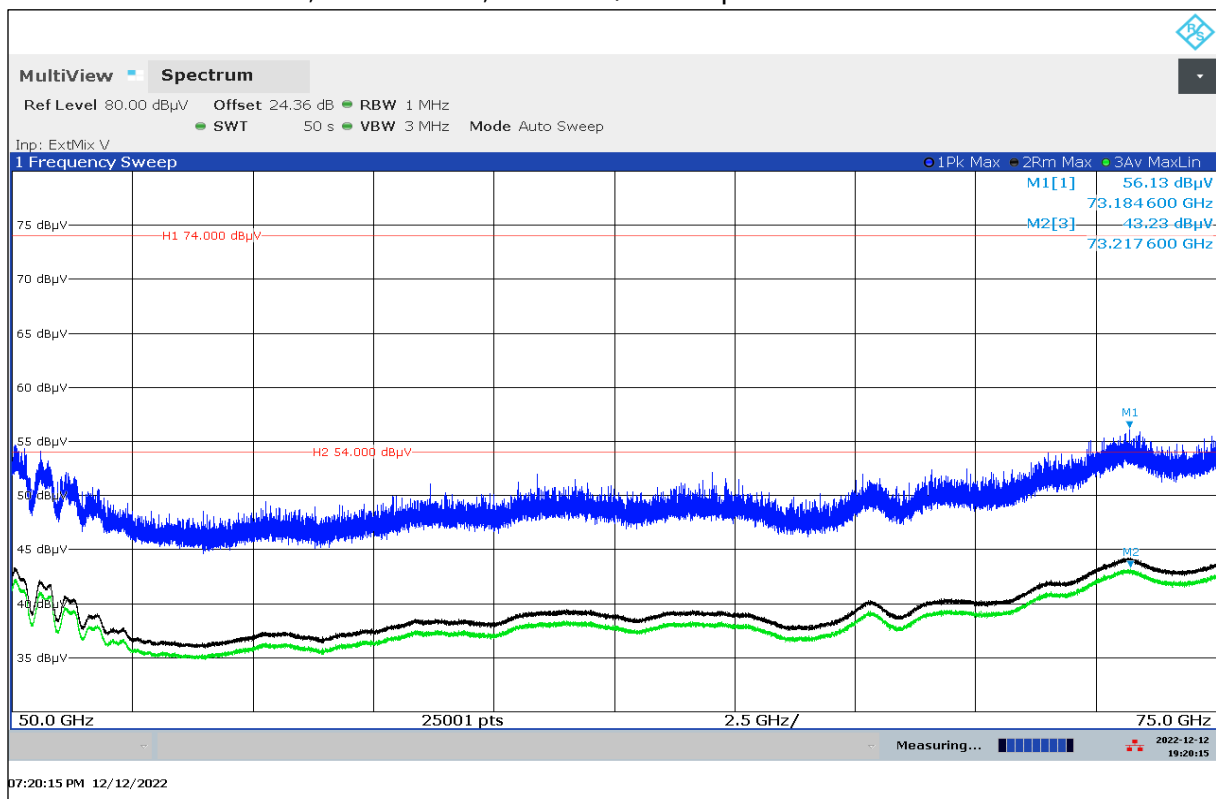

Plot No. 26: 50 GHz to 75 GHz, Stopped Mode Low-Middle-High Channel, horizontal/vertical polarization

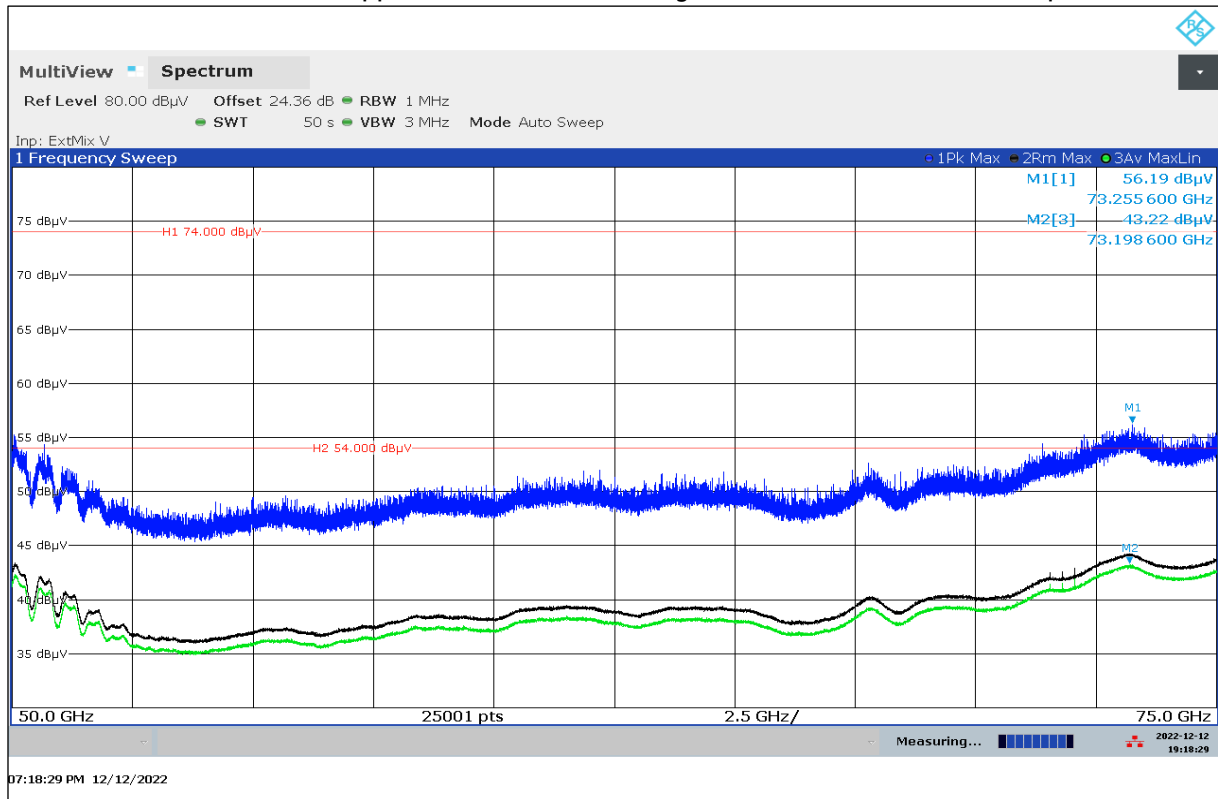

Plot No. 27: 75 GHz to 110 GHz, Normal Mode, horizontal/vertical polarization

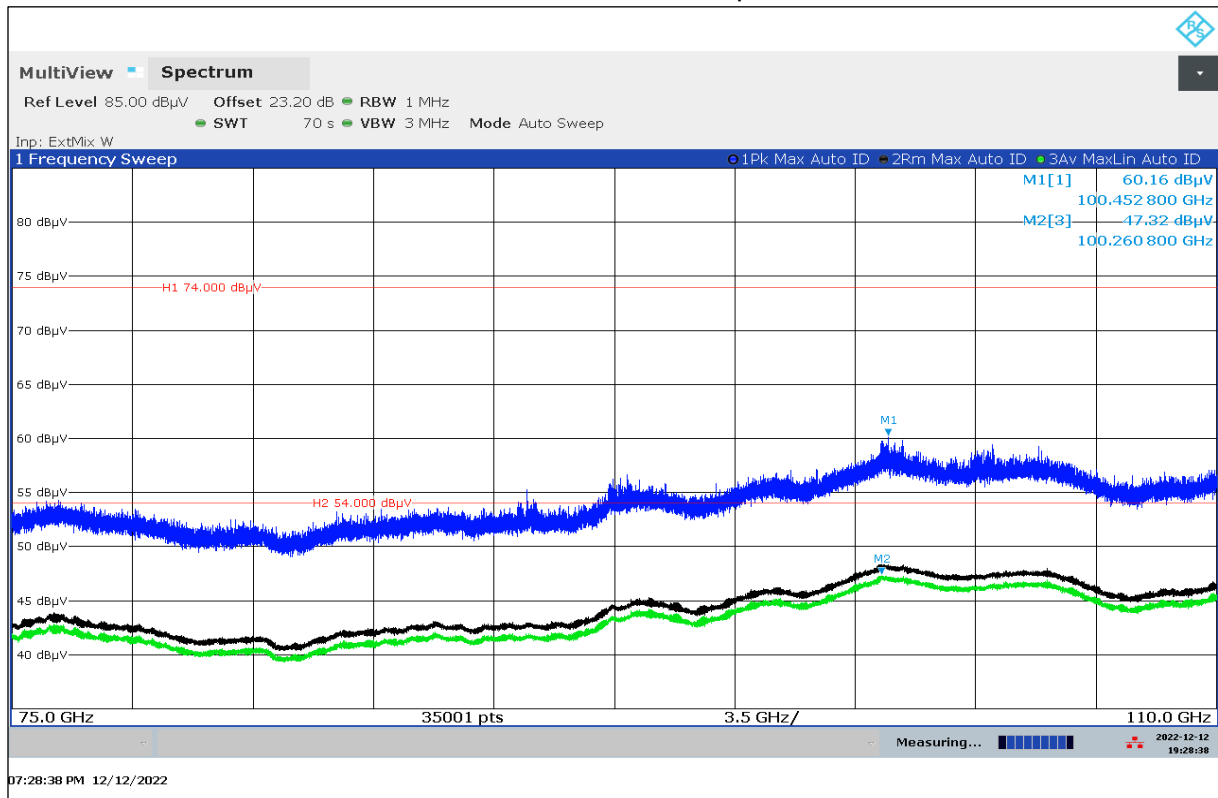

Plot No. 28: 75 GHz to 110 GHz, Stopped Mode Low-Middle-High Channel, horizontal/vertical polarization

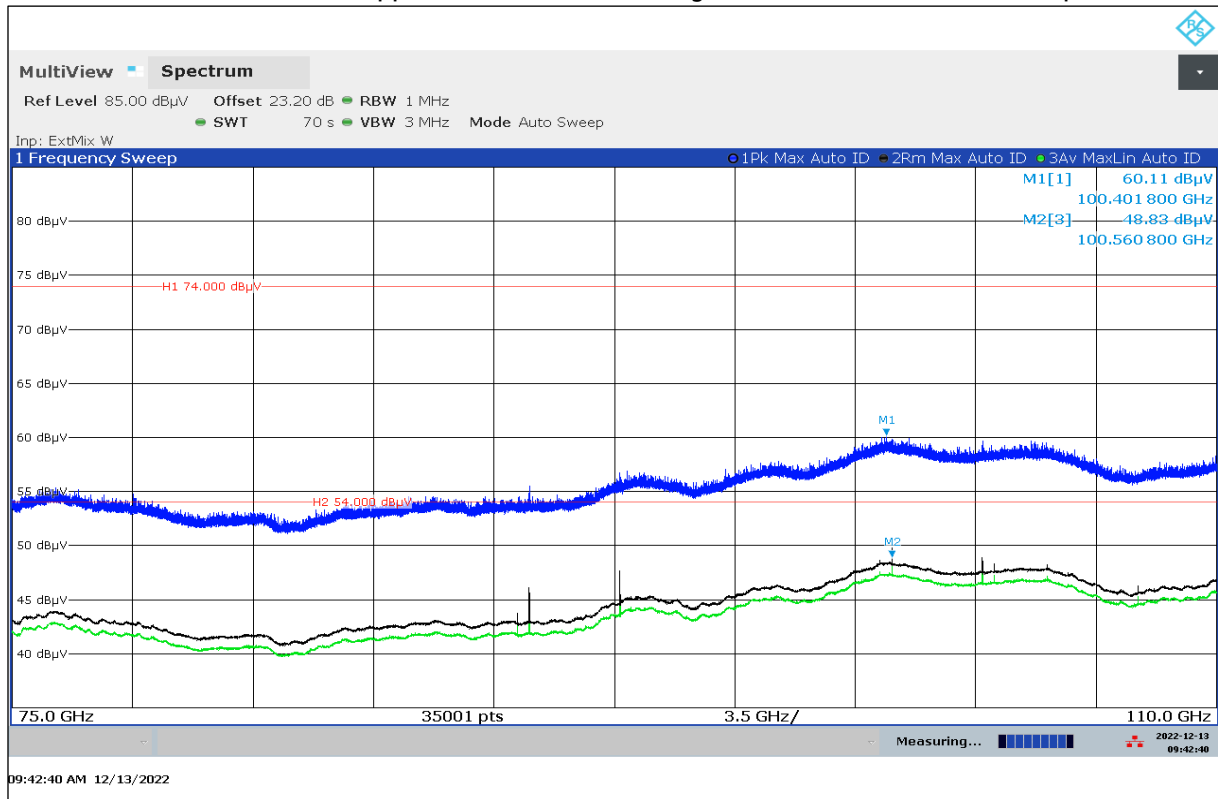

12.4 Conducted emissions < 30 MHz

Description:

Measurement of the conducted spurious emissions in transmit mode below 30 MHz. Both power lines, phase and neutral line, are measured. Found peaks are re-measured with average and quasi peak detection to show compliance to the limits.

Measurement:

Parameter	
Detector:	Peak - Quasi Peak / Average
Sweep time:	Auto
Video bandwidth:	F < 150 kHz: 200 Hz F > 150 kHz: 9 kHz
Resolution bandwidth:	F < 150 kHz: 1 kHz F > 150 kHz: 100 kHz
Span:	9 kHz to 30 MHz
Trace-Mode:	Max Hold

Limits:

FCC		
CFR Part 15.207(a)		
Conducted Spurious Emissions < 30 MHz		
Frequency (MHz)	Quasi-Peak (dB μ V/m)	Average (dB μ V/m)
0.15 – 0.5	66 to 56*	56 to 46*
0.5 – 5	56	46
5 – 30.0	60	50

*Decreases with the logarithm of the frequency

Measurement results:

See plots below.

Plot 29: Phase line

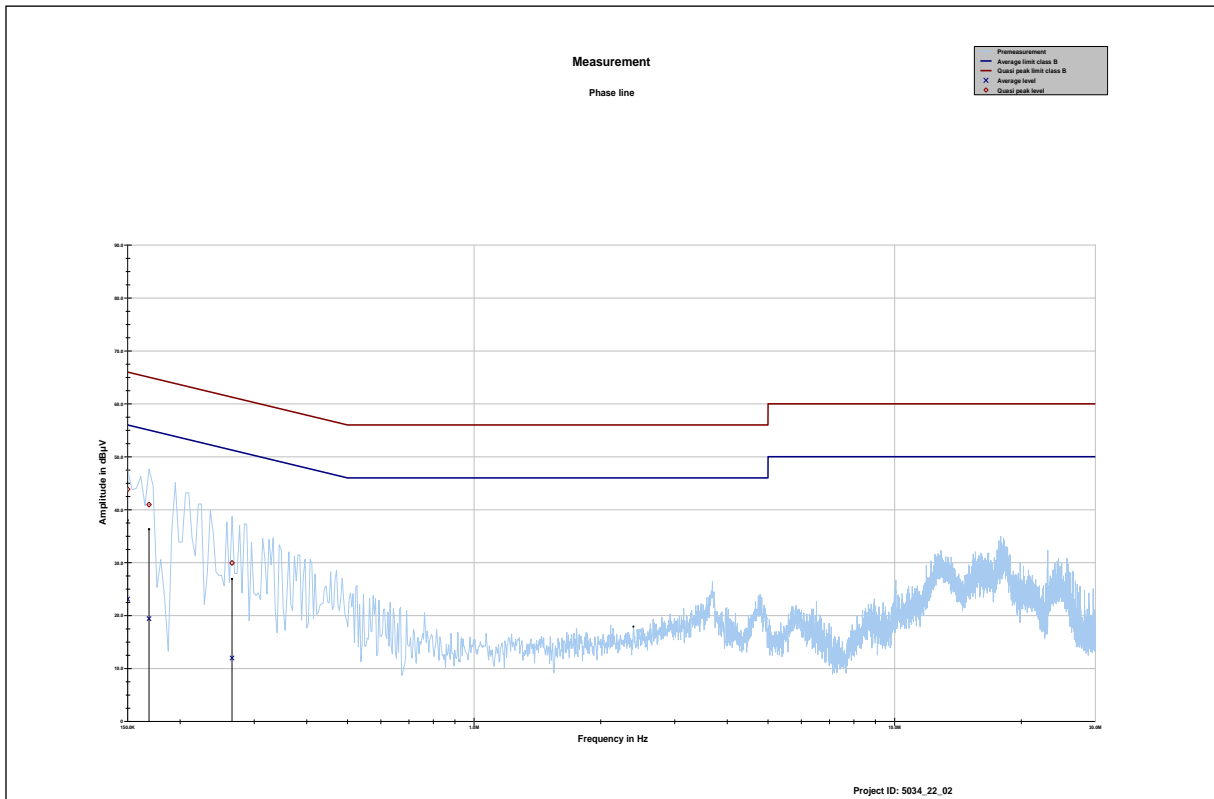

Frequency	Quasi peak level	Margin quasi peak	Limit QP	Average level	Margin average	Limit AVG
MHz	dBµV	dB	dBµV	dBµV	dB	dBµV
0.150000	43.86	22.14	66.000	23.10	32.90	56.000
0.168656	40.96	24.07	65.026	19.42	36.05	55.467
0.265669	29.93	31.32	61.252	11.98	40.72	52.695

Plot 30: Neutral line

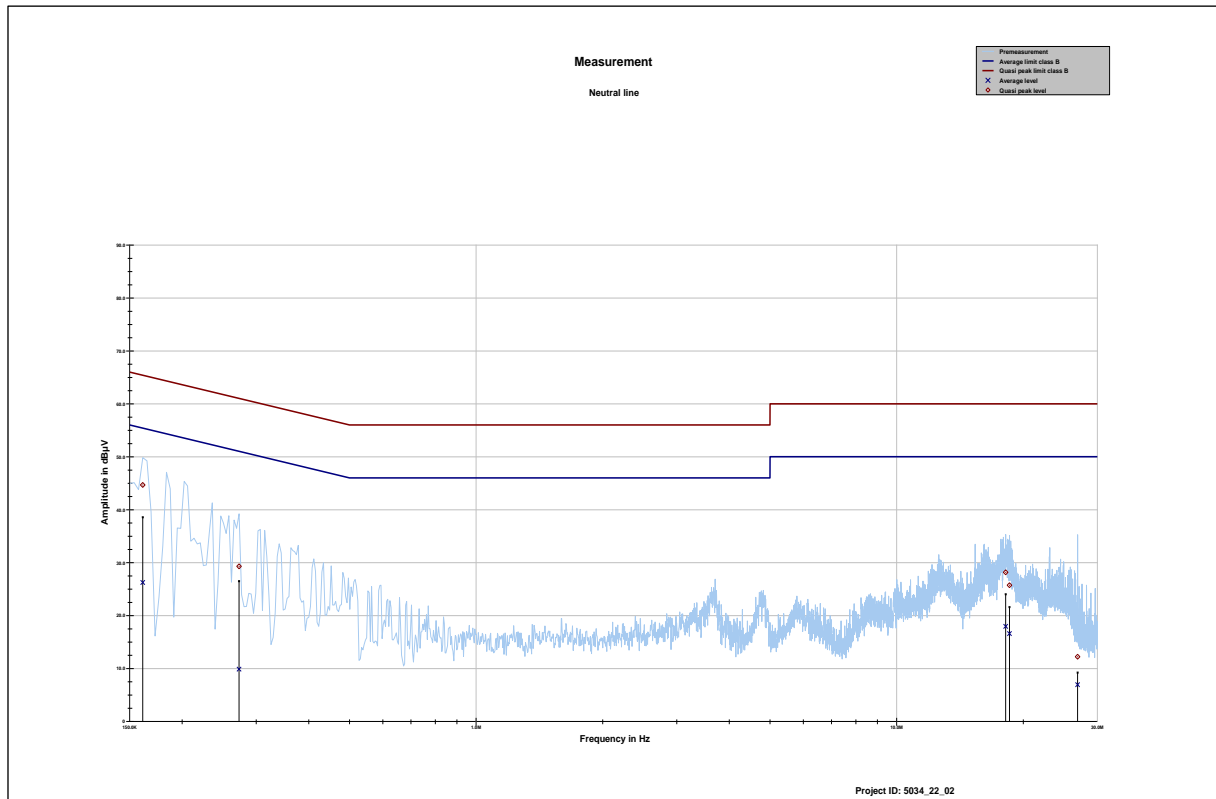

Frequency	Quasi peak level	Margin quasi peak	Limit QP	Average level	Margin average	Limit AVG
MHz	dBµV	dB	dBµV	dBµV	dB	dBµV
0.161194	44.67	20.73	65.402	26.24	29.44	55.680
0.273131	29.29	31.73	61.022	9.88	42.61	52.482
18.164475	28.16	31.84	60.000	17.96	32.04	50.000
18.552525	25.73	34.27	60.000	16.58	33.42	50.000
26.940375	12.21	47.79	60.000	6.93	43.07	50.000

12.5 Frequency Stability

Description:

§15.215(c) Intentional radiators operating under the alternative provisions to the general emission limits, as contained in §§15.217 through 15.257 and in subpart E of this part, must be designed to ensure that the 20 dB bandwidth of the emission, or whatever bandwidth may otherwise be specified in the specific rule section under which the equipment operates, is contained within the frequency band designated in the rule section under which the equipment is operated. In the case of intentional radiators operating under the provisions of subpart E, the emission bandwidth may span across multiple contiguous frequency bands identified in that subpart. The requirement to contain the designated bandwidth of the emission within the specified frequency band includes the effects from frequency sweeping, frequency hopping and other modulation techniques that may be employed as well as the frequency stability of the transmitter over expected variations in temperature and supply voltage. If a frequency stability is not specified in the regulations, it is recommended that the fundamental emission be kept within at least the central 80% of the permitted band in order to minimize the possibility of out-of-band operation.

Measurement:

Parameter	
Detector:	Pos-Peak
Sweep time:	See plots
Resolution bandwidth:	1 MHz
Video bandwidth:	3 MHz
Trace-Mode:	Max Hold

Limits:

FCC
CFR Part 15.215(c)
Frequency Stability
As specified in Section 15.215(c), the bandwidth of the fundamental emission must be contained within the frequency band over the temperature range -20 to +50 degrees Celsius with an input voltage variation of 85% to 115% of rated input voltage.

Measurement results:

Test Conditions Channel F2	f _L in GHz	f _H in GHz	Bandwidth (MHz)
-40 °C / V _{nom}	24.068 761	24.239 946	171.2
-20 °C / V _{nom}	24.068 752	24.239 814	171.1
-10 °C / V _{nom}	24.068 732	24.239 690	171.0
0 °C / V _{nom}	24.068 711	24.239 603	170.9
10 °C / V _{nom}	24.068 110	24.239 464	171.4
20 °C / V _{min-max}	24.067 926	24.239 371	171.4
30 °C / V _{nom}	24.067 574	24.239 335	171.8
40 °C / V _{nom}	24.067 411	24.239 386	171.9
50 °C / V _{nom}	24.067 413	24.239 431	172.0
80 °C / V _{nom}	24.067 498	24.239 512	172.0

Voltage variation does not affect the radiated signal

Plot 31: - 40°C, Normal Mode, V_{nom}

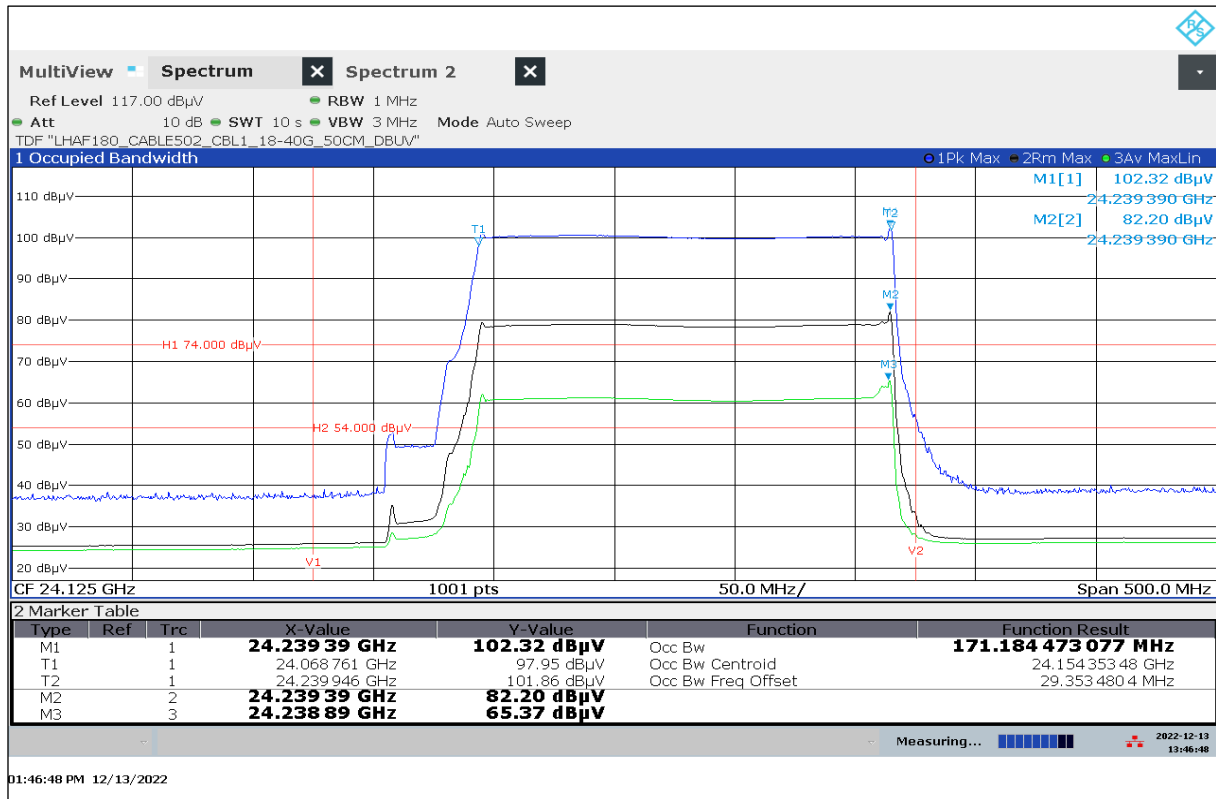

Plot 32: - 20°C, Normal Mode, V_{nom}

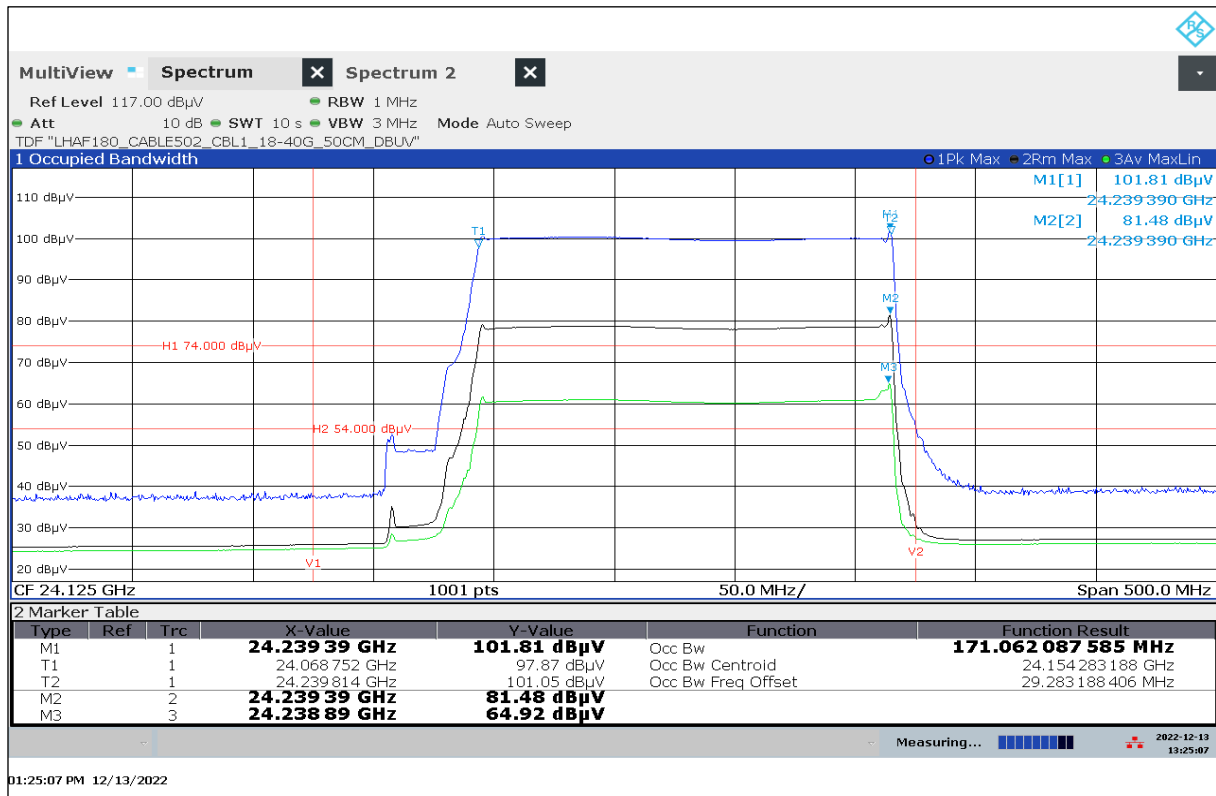

Plot 33: - 10°C, Normal Mode, V_{nom}

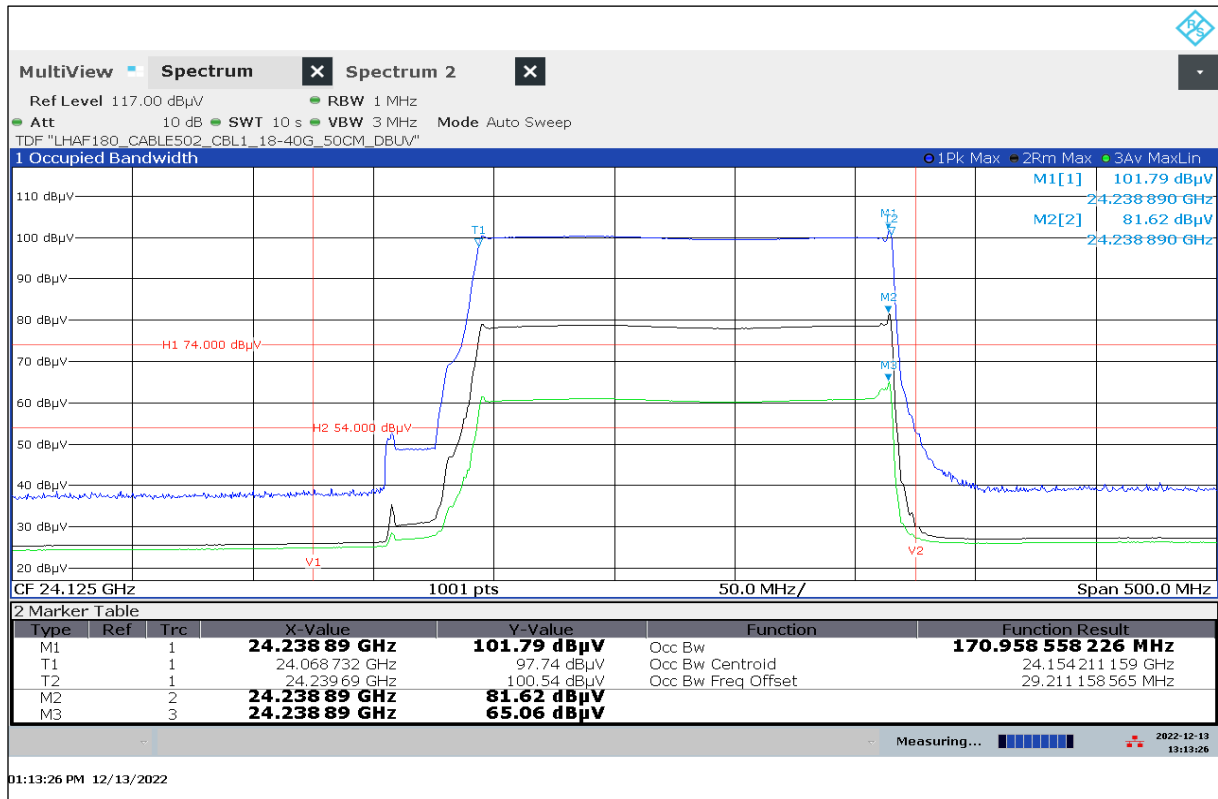

Plot 34: 0°C, Normal Mode, V_{nom}

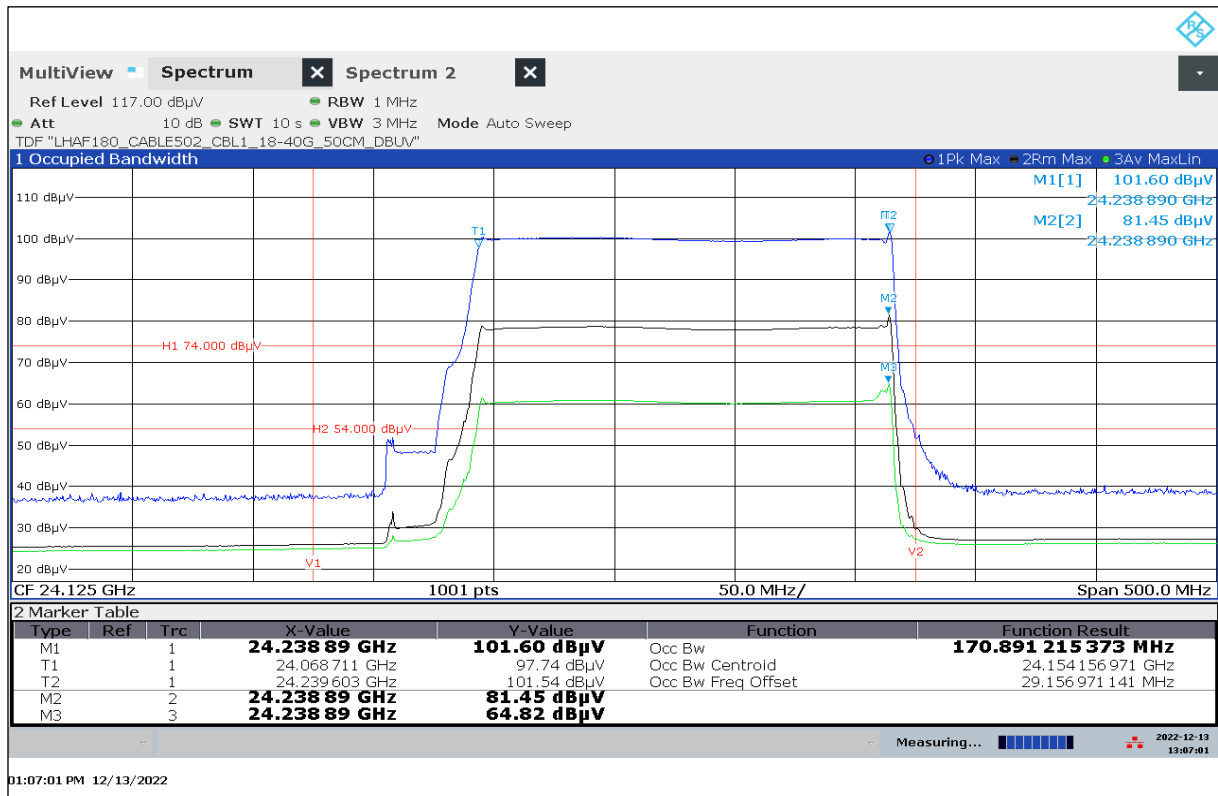

Plot 35: 10°C, Normal Mode, V_{nom}

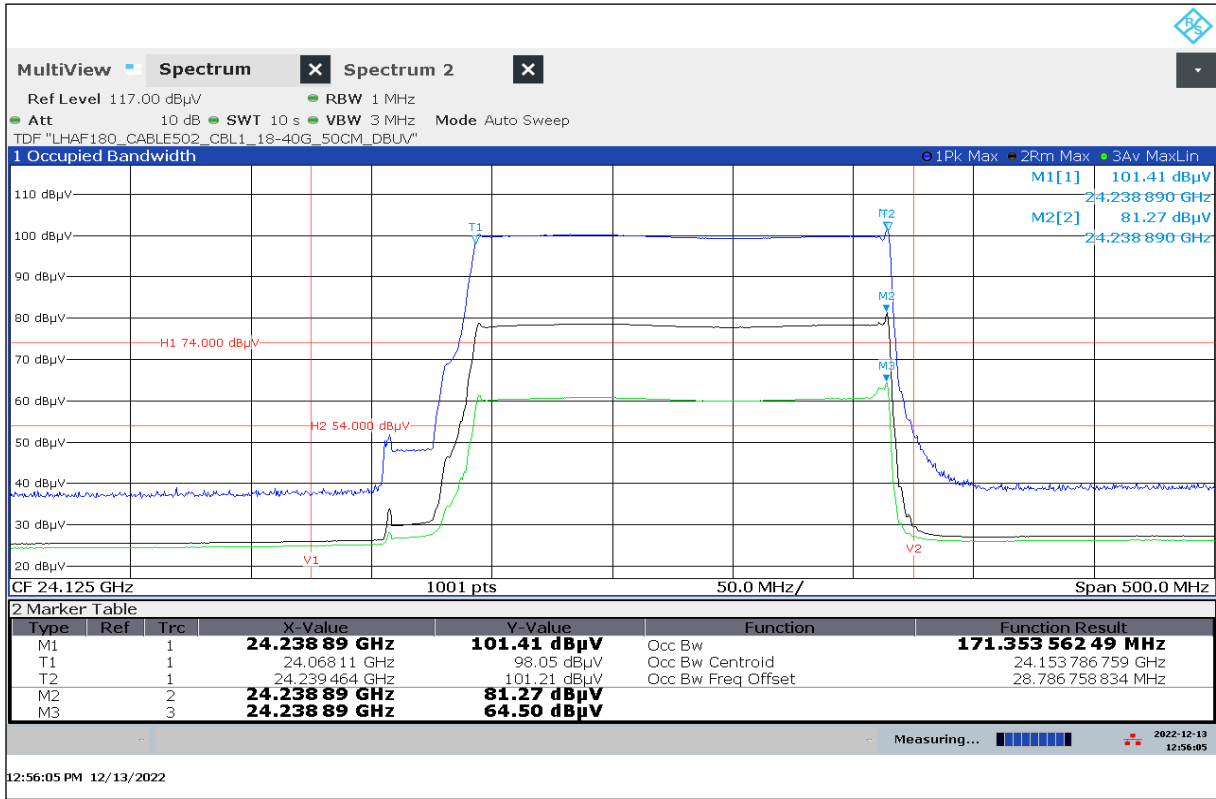

Plot 36: 20°C, Normal Mode, $V_{min-max}$

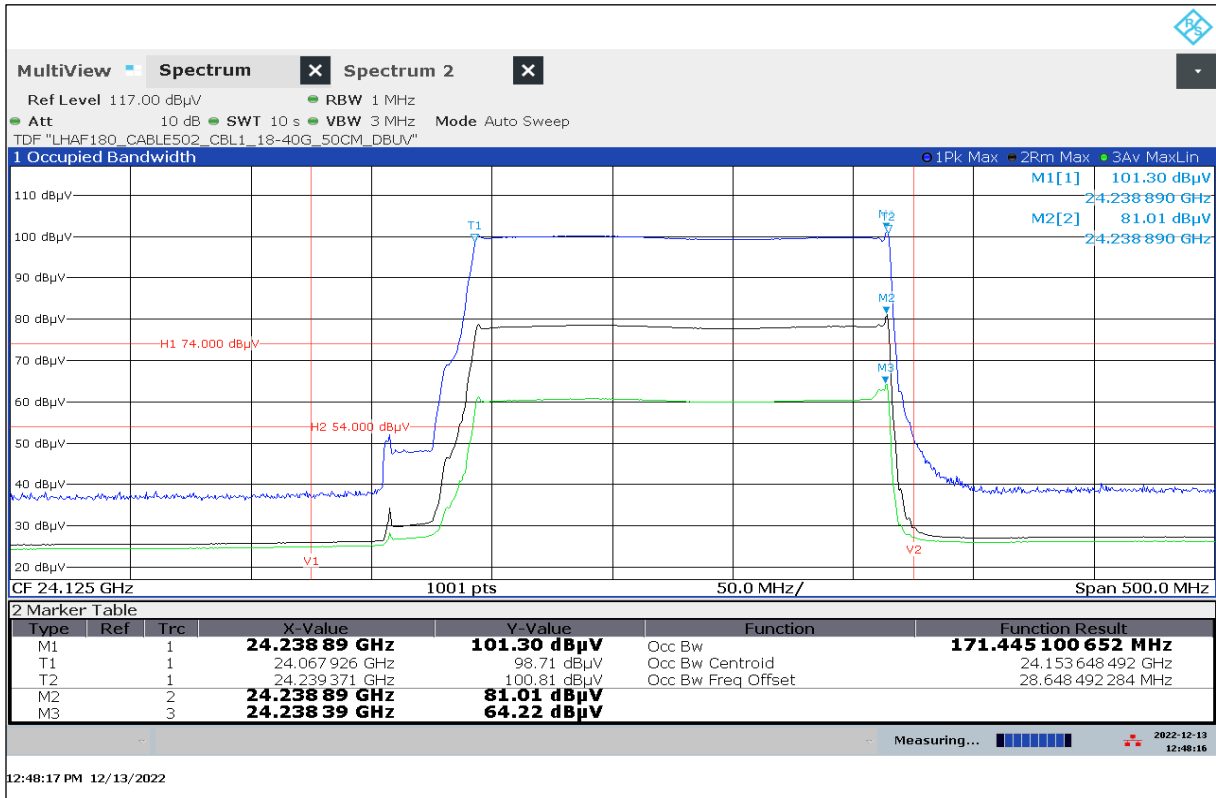

Plot 37: 30°C, Normal Mode, V_{nom}

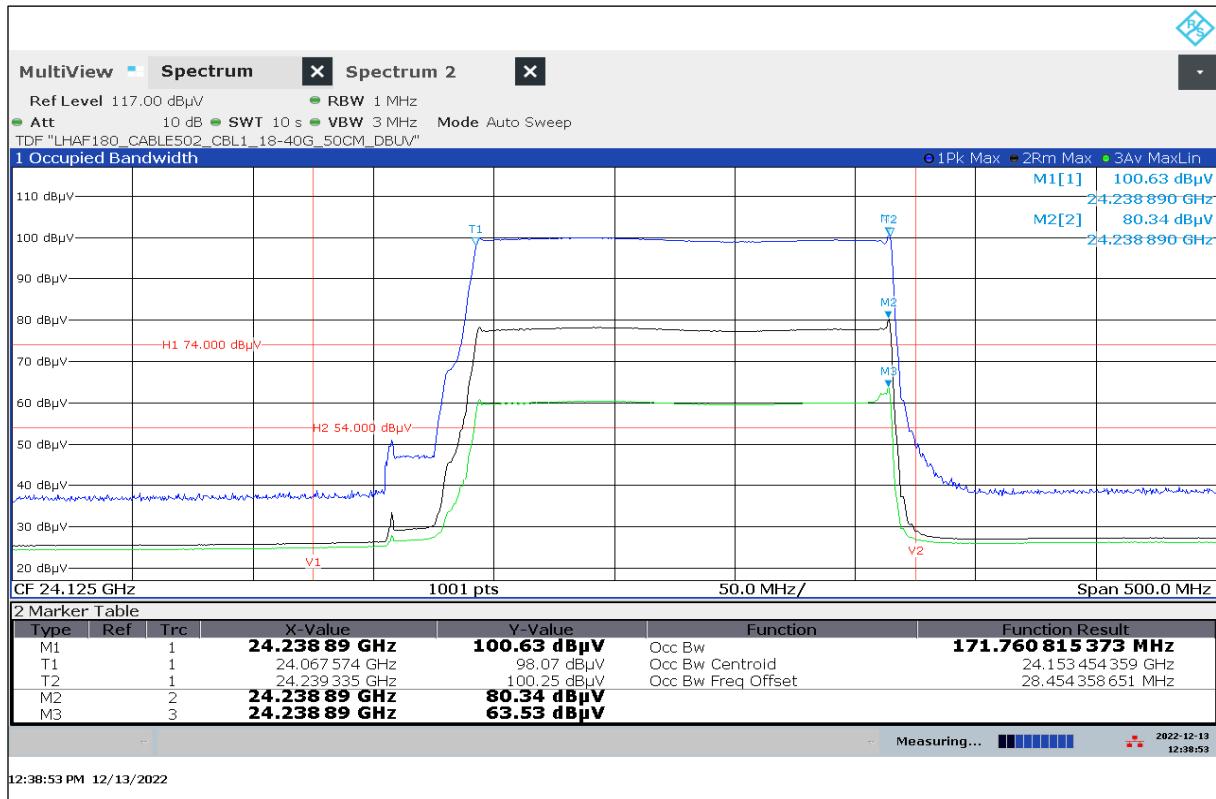

Plot 38: 40°C, Normal Mode, V_{nom}

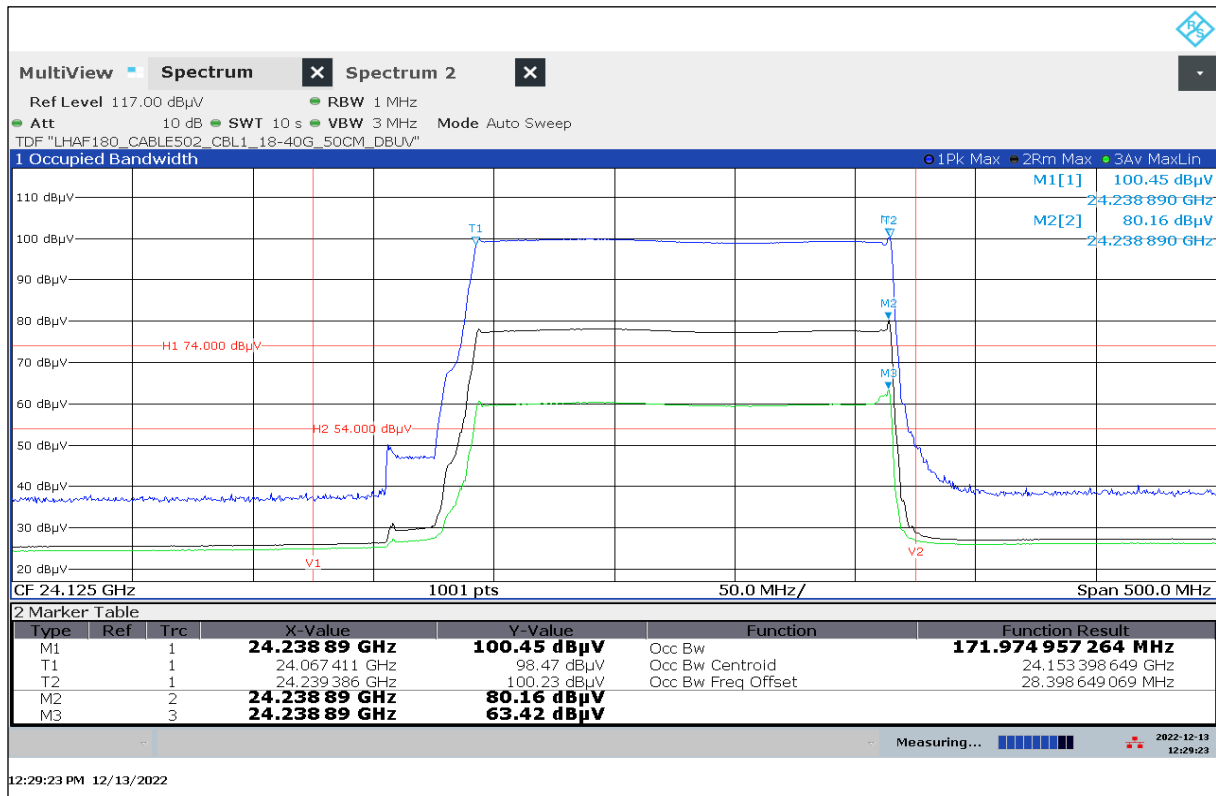

Plot 39: 50°C, Normal Mode, V_{nom}

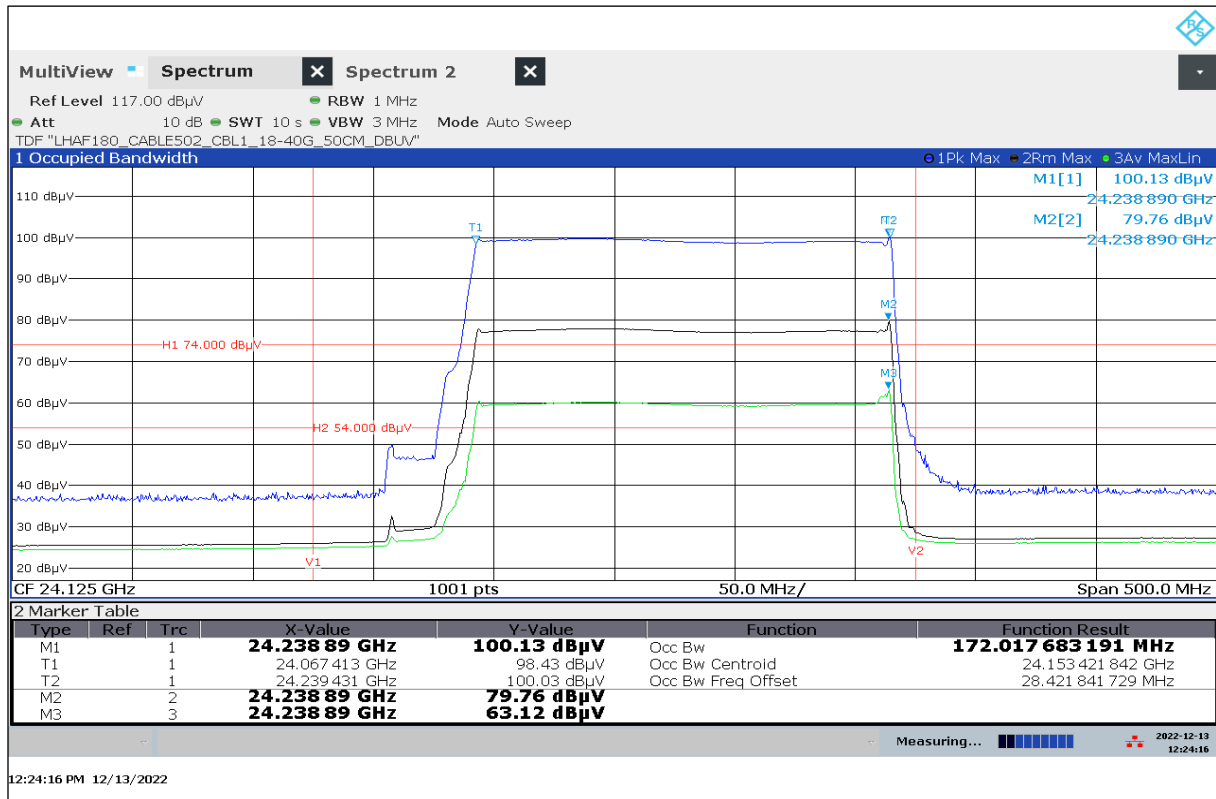

Plot 40: 80°C, Normal Mode, V_{nom}

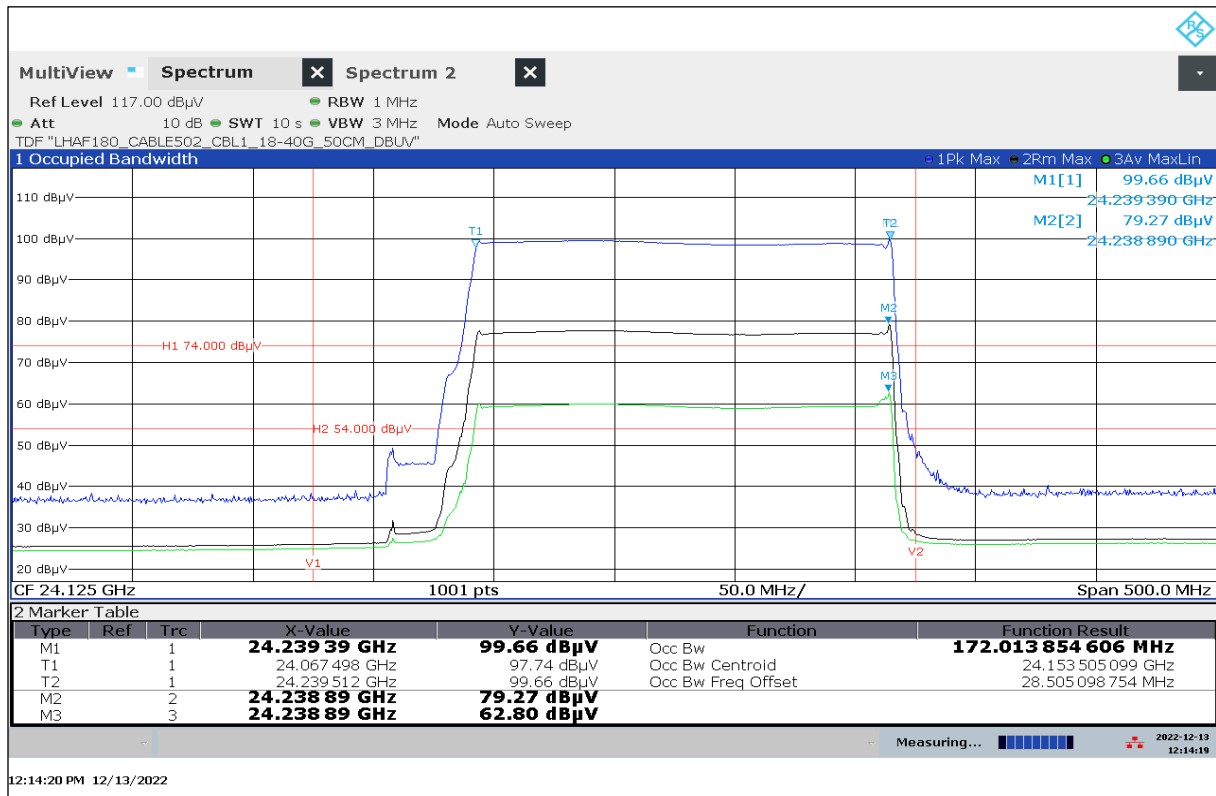

13 Glossary

EUT	Equipment under test
DUT	Device under test
UUT	Unit under test
GUE	GNSS User Equipment
ETSI	European Telecommunications Standards Institute
EN	European Standard
FCC	Federal Communications Commission
FCC ID	Company Identifier at FCC
IC	Industry Canada
PMN	Product marketing name
HMN	Host marketing name
HVIN	Hardware version identification number
FVIN	Firmware version identification number
EMC	Electromagnetic Compatibility
HW	Hardware
SW	Software
Inv. No.	Inventory number
S/N or SN	Serial number
C	Compliant
NC	Not compliant
NA	Not applicable
NP	Not performed
PP	Positive peak
QP	Quasi peak
AVG	Average
OC	Operating channel
OCW	Operating channel bandwidth
OBW	Occupied bandwidth
OOB	Out of band
DFS	Dynamic frequency selection
CAC	Channel availability check
OP	Occupancy period
NOP	Non occupancy period
DC	Duty cycle
PER	Packet error rate
CW	Clean wave
MC	Modulated carrier
WLAN	Wireless local area network
RLAN	Radio local area network
DSSS	Dynamic sequence spread spectrum
OFDM	Orthogonal frequency division multiplexing
FHSS	Frequency hopping spread spectrum
GNSS	Global Navigation Satellite System
C/N₀	Carrier to noise-density ratio, expressed in dB-Hz

14 Document history

Version	Applied changes	Date of release
-/-	Initial release - DRAFT	2023-01-27
-/-	Minor changes	2023-02-02

15 Accreditation Certificate – D-PL-12076-01-05

first page	last page
 <p>Deutsche Akkreditierungsstelle GmbH</p> <p>Entrusted according to Section 8 subsection 1 AkkStelleG in connection with Section 1 subsection 1 AkkStelleGBV Signatory to the Multilateral Agreements of EA, ILAC and IAF for Mutual Recognition</p> <p>Accreditation </p> <p>The Deutsche Akkreditierungsstelle GmbH attests that the testing laboratory CTC advanced GmbH Untertürkheimer Straße 6-10, 66117 Saarbrücken is competent under the terms of DIN EN ISO/IEC 17025:2018 to carry out tests in the following fields: Telecommunication (FCC Requirements)</p> <p>The accreditation certificate shall only apply in connection with the notice of accreditation of 09.06.2020 with the accreditation number D-PL-12076-01. It comprises the cover sheet, the reverse side of the cover sheet and the following annex with a total of 05 pages.</p> <p>Registration number of the certificate: D-PL-12076-01-05</p> <p>Frankfurt am Main, 09.06.2020  by Dr. Ingrid Egner Head of Division</p> <p><small>The certificate together with its annex reflects the status at the time of the date of issue. The current status of the scope of accreditation can be found in the database of accredited bodies of Deutsche Akkreditierungsstelle GmbH. https://www.dakks.de/en/content/accredited-bodies-dakks See notes on cover sheet.</small></p>	<p>Deutsche Akkreditierungsstelle GmbH</p> <p>Office Berlin Spittelmarkt 10 10117 Berlin</p> <p>Office Frankfurt am Main Europa-Allee 52 60327 Frankfurt am Main</p> <p>Office Braunschweig Bundesallee 100 38116 Braunschweig</p> <p>The publication of extracts of the accreditation certificate is subject to the prior written approval by Deutsche Akkreditierungsstelle GmbH (DAkKS). Exempted is the unchanged form of separate disseminations of the cover sheet by the conformity assessment body mentioned overleaf.</p> <p>No impression shall be made that the accreditation also extends to fields beyond the scope of accreditation attested by DAkKS.</p> <p>The accreditation was granted pursuant to the Act on the Accreditation Body (AkkStelleG) of 31 July 2009 (Federal Law Gazette I p. 2625) and the Regulation (EC) No 765/2008 of the European Parliament and of the Council of 9 July 2008 setting out the requirements for accreditation and market surveillance relating to the marketing of products (Official Journal of the European Union L 218 of 9 July 2008, p. 30). DAkKS is a signatory to the Multilateral Agreements for Mutual Recognition of the European co-operation for Accreditation (EA), International Accreditation Forum (IAF) and International Laboratory Accreditation Cooperation (ILAC). The signatories to these agreements recognise each other's accreditations.</p> <p>The up-to-date state of membership can be retrieved from the following websites: EA: www.european-accreditation.org ILAC: www.ilac.org IAF: www.iaf.nu</p>

Note: The current certificate annex is published on the websites (link see below).

<https://www.dakks.de/files/data/as/pdf/D-PL-12076-01-05e.pdf>

OR

https://ctcadvanced.com/app/uploads/2020/06/D-PL-12076-01-05_TCB_USA.pdf

END OF TEST REPORT