

TEST REPORT # EMCC-080534GAA, 2019-02-20

EQUIPMENT UNDER TEST:

Trade Name: K-Band Transceiver
Type/Model: IPS-280
Serial Number(s): 00001222
Application: K-Band Radar
FCC ID: UXS-IPS280
Manufacturer: InnoSenT GmbH
Address: Am Roedertor 30
97499 Donnersdorf
GERMANY

Name: Mr Barrett Lee
Phone: +49 9528 9518-1265
E-Mail: Barrett.Lee@innosent.de

RELEVANT STANDARD(S) : 47 CFR § 15.245

MEASUREMENT PROCEDURE: : ANSI C63.10-2013

TEST REPORT PREPARED BY:

Patrick Reusch
EMCCons DR. RAŠEK GmbH & Co. KG
Boelwiese 8
91320 Ebermannstadt
Germany
Phone: +49 9194 7262-336
Fax: +49 9194 7262-199
E-Mail: p.reusch@emcc.de

Tested:



Patrick Reusch
-Test engineer-

Checked:



Wolfgang Döring
-Head of Commercial EMC and Radio Dept. -

| CONTENTS | | PAGE |
|-----------------|---|-------------|
| 1 | GENERAL INFORMATION | 3 |
| 1.1 | Purpose | 3 |
| 1.2 | Limits and Reservations | 3 |
| 1.3 | Test Laboratory | 3 |
| 1.4 | Customer | 3 |
| 1.5 | Manufacturer | 3 |
| 1.6 | Dates and Test Location | 4 |
| 1.7 | Ordering Information | 4 |
| 1.8 | Climatic Conditions | 4 |
| 2 | PRODUCT DESCRIPTION | 5 |
| 2.1 | Equipment Under Test (EUT) | 5 |
| 2.2 | Intended Use | 6 |
| 2.3 | EUT Peripherals/Simulators | 6 |
| 2.4 | Mode of operation during testing and test setup | 6 |
| 2.5 | Modifications required for compliance | 6 |
| 3 | TEST RESULTS SUMMARY | 7 |
| 4 | DETAILED TEST RESULTS | 8 |
| 4.1 | AC Power Line Conducted Emissions | 8 |
| 4.2 | Occupied Bandwidth | 12 |
| 4.3 | Field Strength of Fundamental | 17 |
| 4.4 | Radiated Emissions | 24 |
| 5 | TEST INSTRUMENTS | 67 |
| 6 | MEASUREMENT UNCERTAINTY | 69 |
| 7 | LIST OF ANNEXES | 70 |

Test on InnoSenT GmbH IPS-280 to 47 CFR § 15.245

1 GENERAL INFORMATION

1.1 Purpose

The purpose of this report is to show compliance with the 47 CFR §15.245 requirements applicable to intentional radiators (subpart C).

1.2 Limits and Reservations

The test results in this report apply only to the particular equipment under test (EUT) as declared in this report. This test report shall not be reproduced except in full without the written permission of EMCCCons DR. RAŠEK GmbH & Co. KG.

1.3 Test Laboratory

| | |
|--|---|
| Test Laboratory: | EMCCCons DR. RAŠEK GmbH & Co. KG |
| Accreditation No.: | D-PL-12067-01-02 |
| Address of Labs I, II, III and Head Office: | EMCCCons DR. RAŠEK GmbH & Co. KG Boelwiese 8 91320 Ebermannstadt GERMANY |
| Address of Labs IV and V: | EMCCCons DR. RAŠEK GmbH & Co. KG Stoernhofer Berg 15 91364 Unterleinleiter GERMANY |
| Phone: | +49 9194 7262-0 |
| Fax: | +49 9194 7262-199 |
| E-Mail: | info@emcc.de |
| Web: | www.emcc.de |

1.4 Customer

| | |
|---------------|-------------------------|
| Company Name: | InnoSenT GmbH |
| Street: | Am Roedertor 30 |
| City: | 97499 Donnersdorf |
| Country: | GERMANY |
| Name: | Mr Barrett Lee |
| Phone: | +49 9528 9518-1265 |
| Fax: | +49 9528 9518-99 |
| E-Mail: | Barrett.Lee@innosent.de |

1.5 Manufacturer

| | |
|---------------|-------------------------|
| Company Name: | InnoSenT GmbH |
| Street: | Am Roedertor 30 |
| City: | 97499 Donnersdorf |
| Country: | GERMANY |
| Phone: | +49 9528 9518-1265 |
| E-Mail: | Barrett.Lee@innosent.de |

Test on InnoSenT GmbH IPS-280 to 47 CFR § 15.245

1.6 Dates and Test Location

Date of receipt of EUT: 2018-12-07
Test Date: CW 51/2018 to CW 03/2019
Test Location: Lab IV

1.7 Ordering Information

Purchase Order: B201803598
Date: 2018-11-30
Vendor-Number: n/a

1.8 Climatic Conditions

| Date | Temperature | Relative Humidity | Air Pressure | Lab | Customer attended tests |
|------------|-------------|-------------------|--------------|-----|-------------------------|
| -- | °C | % | hPa | -- | -- |
| 2018-12-17 | 21 | 30 | 979 | IV | No |
| 2018-12-18 | 22 | 32 | 984 | IV | No |
| 2018-12-19 | 22 | 30 | 976 | IV | No |
| 2018-12-21 | 22 | 34 | 968 | IV | No |
| 2019-01-07 | 20 | 36 | 988 | IV | No |
| 2019-01-08 | 21 | 34 | 969 | IV | No |
| 2019-01-14 | 22 | 32 | 966 | IV | No |

Test on InnoSenT GmbH IPS-280 to 47 CFR § 15.245

2 PRODUCT DESCRIPTION

2.1 Equipment Under Test (EUT)

The following data is based on customer's information.

| | |
|-------------------------------|--|
| Manufacturer: | InnoSenT GmbH |
| Type: | IPS-280 |
| Application: | K-Band Radar |
| No of variants: | 0 |
| Serial No(s): | 00001222 |
| Firmware version: | n/a |
| Hardware version: | Rev 2 |
| FCC ID: | UXS-IPS280 |
| Highest internal frequency: | 24.175 GHz |
| TX operating frequency range: | 24.075 .. 24.175 GHz |
| No of operating channels: | 1 |
| Used channels during test: | n/a |
| Power source: | External DC (3.2 .. 3.4 V _{DC}) |
| Voltage for testing: | 3.3 V _{DC} (from laboratory power supply) |
| Ports: | 2.54mm hole grid for internal connection to host pcb |
| Antenna: | Integral (patch antenna) |
| Max. antenna gain: | 18 dBi RX, 12 dBi TX |
| Remarks: | None |

Test on InnoSenT GmbH IPS-280 to 47 CFR § 15.245

2.2 Intended Use

The following description was taken from product datasheet "Data Sheet IPS-280 Version 1.3 – 13.02.2017".

*High sensitivity K-Band CW Doppler Radar with adjustable frequency and I Q - outputs.
The shutdown option can be used for intermittent operation in battery powered applications.*

Features:

- radar-based speed & motion sensor*
- advanced MMIC technology*
- integrated low noise amplifier*
- extended temperature range from -40°C up to +85°C*
- shutdown feature for low power operation*

2.3 EUT Peripherals/Simulators

None.

2.4 Mode of operation during testing and test setup

The equipment under test (EUT) was operated during the tests under the following conditions:

Mode: Active

By applying power to the EUT it enters its normal operation mode with a continuous transmission at its normal output power and enabling the receive path.

The EUT was powered by laboratory power supply.

2.5 Modifications required for compliance

None.

Test on InnoSenT GmbH IPS-280 to 47 CFR § 15.245

3 TEST RESULTS SUMMARY

Summary of test results for the following EUT:

Manufacturer: InnoSenT GmbH
Type: IPS-280
Serial No.: 00001222

| Requirement | 47 CFR Section | Report Section | Tested EUT | Result |
|--|----------------------|----------------|------------|--------|
| AC Power Line Conducted Emissions | § 15.207 | 4.1 | 00001222 | Passed |
| Occupied Bandwidth | § 15.215 | 4.2 | 00001222 | Passed |
| Radiated Field Strength of Fundamental | § 15.245 | 4.3 | 00001222 | Passed |
| Radiated Emissions | § 15.245, §15.209 | 4.4 | 00001222 | Passed |

N.A. – not applicable; N.T. – Not tested acc. to applicant's order.

The client has made the determination that EUT Condition, Characterization, and Mode of Operation are representative of production units and meet the requirements of the specifications referenced herein.

Consistent with Industry practice, measurement and test equipment not directly involved in obtaining measurement results but having an impact on measurements (such as cable loss, antenna factors, etc.) are factored into the "Correction Factor" documented in certain test results. Instrumentation employed for testing meets tolerances consistent with known Industry Standards and Regulations.

The measurements contained in this report were made in accordance with the procedures described in ANSI C63.10-2013 and all applicable Public Notices received prior to the date of testing. All requirements were found to be within the limits outlined in this report.

The test results in this report apply only to the particular equipment under test (EUT) as declared in this report.

Test personnel: Patrick Reusch
Issuance date: 2019-02-20

4 DETAILED TEST RESULTS

4.1 AC Power Line Conducted Emissions

4.1.1 Regulation

47 CFR § 15.207 Conducted limits

(a) Except as shown in paragraphs (b) and (c) of this section, for an intentional radiator that is designed to be connected to the public utility (AC) power line, the radio frequency voltage that is conducted back onto the AC power line on any frequency or frequencies, within the band 150 kHz to 30 MHz, shall not exceed the limits in the following table, as measured using a 50 μ H/50 ohms line impedance stabilization network (LISN). Compliance with the provisions of this paragraph shall be based on the measurement of the radio frequency voltage between each power line and ground at the power terminal. The lower limit applies at the boundary between the frequency ranges.

| Frequency of emission (MHz) | Conducted limit (dB μ V) | |
|-----------------------------|------------------------------|-----------|
| | Quasi-peak | Average |
| 0.15-0.5 | 66 to 56* | 56 to 46* |
| 0.5-5 | 56 | 46 |
| 5-30 | 60 | 50 |

*Decreases with the logarithm of the frequency.

4.1.2 Test Procedures

Testing is performed acc. to ANSI C63.10-2013.

Tabletop and their ancillary devices are placed on a nonconducting table with nominal dimension of 1.0 m by 1.5 m, height 0.8 m above the ground plane. The EUT is centered laterally (left to right facing the tabletop) on the tabletop and its rear is flush with the rear of the table. Accessories or peripherals that are part of a system tested on a tabletop are being placed in a test arrangement on one or both sides of the host with a 10 cm separation between the nearest points of the cabinets.

Interconnecting cables that hang closer than 40 cm to the ground plane are folded back and forth in the center forming a bundle 30 cm to 40 cm long.

The EUT's DC port was connected to a laboratory DC power supply (EMCC-ID#4721), which was connected to a LISN.

The measurement receiver is connected to the 50 Ω RF port of the LISN.

Test on InnoSenT GmbH IPS-280 to 47 CFR § 15.245

4.1.3 Test Setup

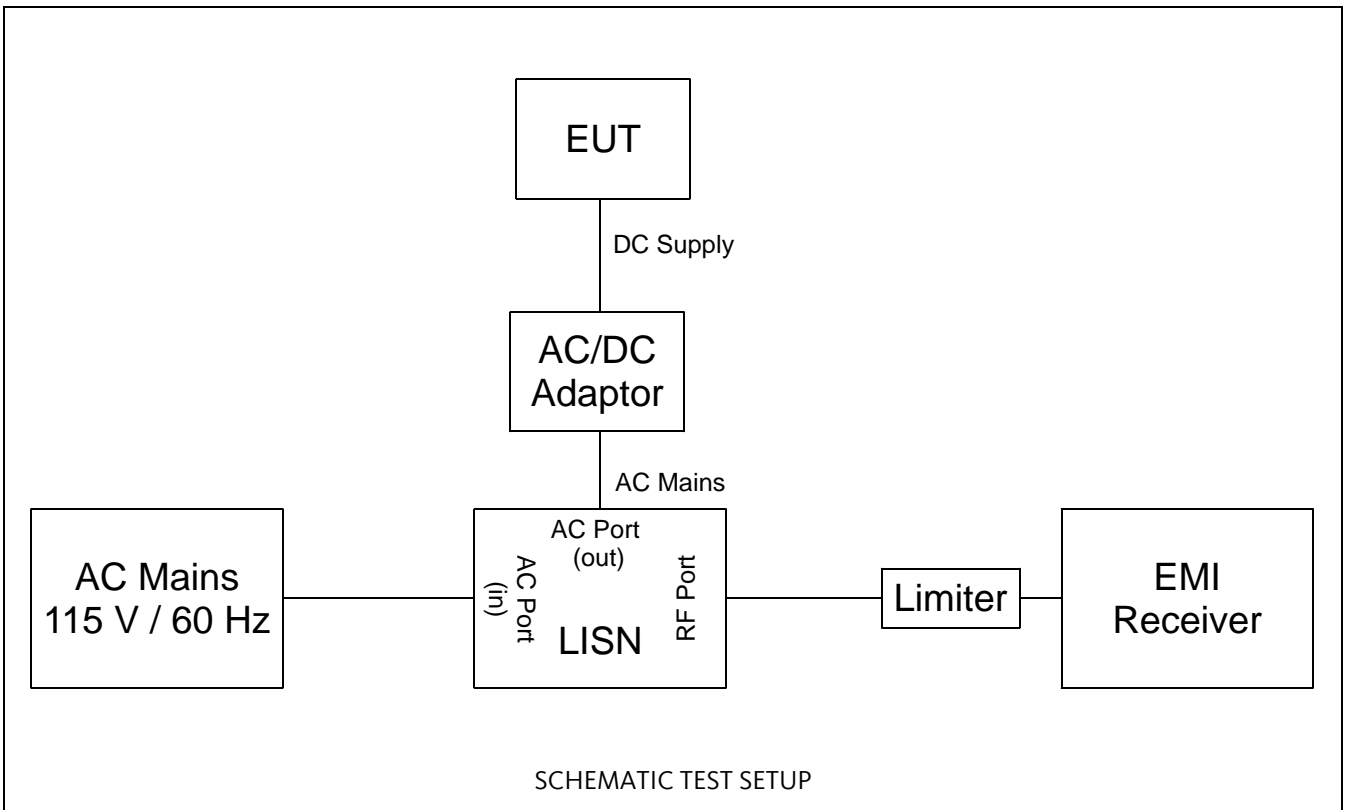

Requirement: 47 CFR, § 15.207
Procedure: ANSI C63.10-2013

Power Source: #001
Receiver: #516
LISN: #1901

TEST EQUIPMENT USED:
Refer to chapter 5 of this document.
001, 516, 1890, 1901, 3184, 3880, 4524,
4597, 4717, 4721, 5392, 5551

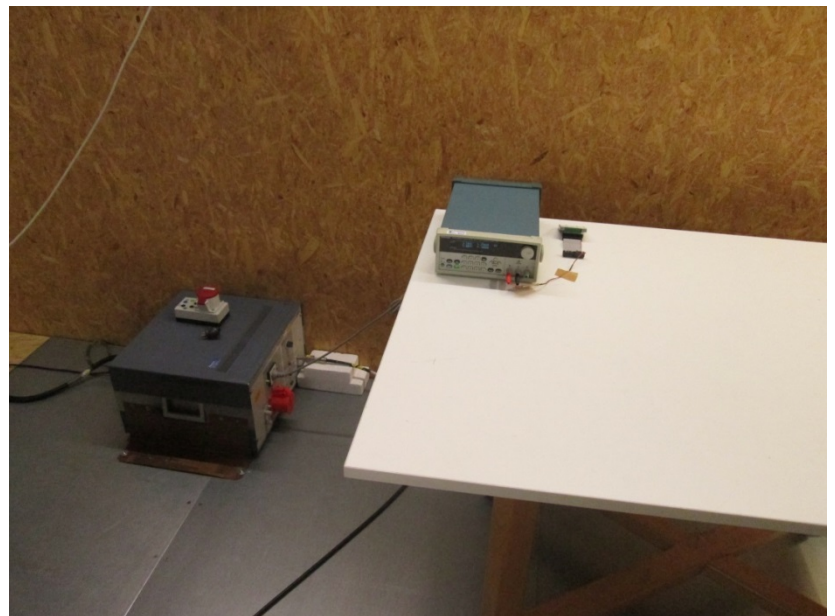

Sample photo of setup

Test on InnoSenT GmbH IPS-280 to 47 CFR § 15.245

4.1.4 Detailed Test Data

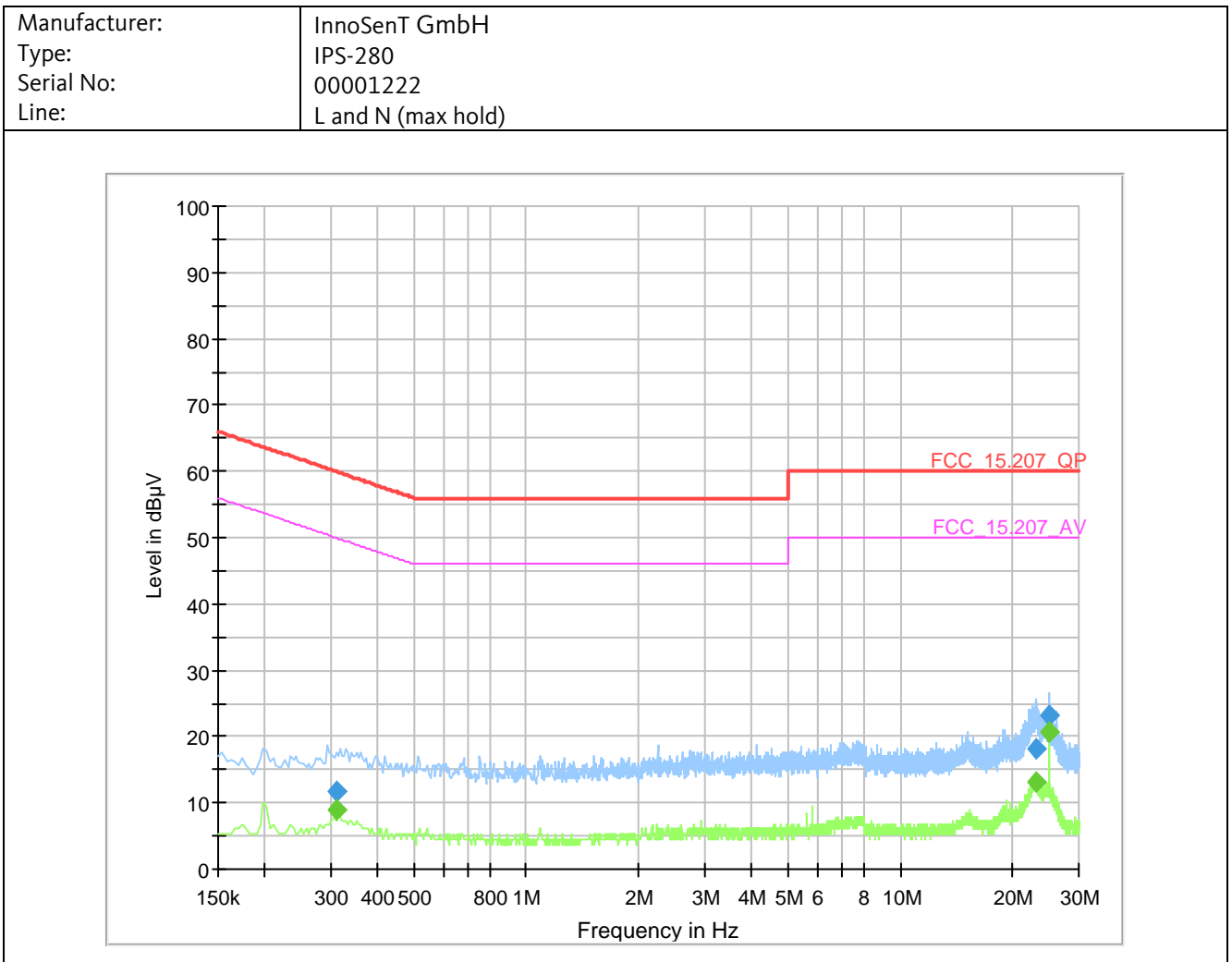

Final Result:

| Frequency MHz | Detector | Result dBµV | Margin dB |
|---------------|----------|-------------|-----------|
| 0.310500 | QP | 11.67 | 48.29 |
| 22.965500 | QP | 18.24 | 41.76 |
| 25.057500 | QP | 23.32 | 36.68 |

| Frequency MHz | Detector | Result dBµV | Margin dB |
|---------------|----------|-------------|-----------|
| 0.310500 | AV | 9.04 | 40.92 |
| 22.965500 | AV | 13.06 | 36.94 |
| 25.057500 | AV | 20.69 | 29.31 |

Worst case results listed, only.

Note: EUT was supplied by laboratory power supply (EMCC-ID #4721) hence no power adaptor is being sold with these modules by the customer.

Test on InnoSenT GmbH IPS-280 to 47 CFR § 15.245

4.1.5 Test Result

Manufacturer: InnoSenT GmbH
Type: IPS-280
Serial No.: 00001222
Test date: 2019-01-14
Test personnel: Patrick Reusch

The EUT meets the requirements of this section.

4.2 Occupied Bandwidth

4.2.1 Regulation

47CFR § 15.215 Additional provisions to the general radiated emission limitations.

(c) Intentional radiators operating under the alternative provisions to the general emission limits, as contained in §§15.217 through 15.257 and in subpart E of this part, must be designed to ensure that the 20 dB bandwidth of the emission, or whatever bandwidth may otherwise be specified in the specific rule section under which the equipment operates, is contained within the frequency band designated in the rule section under which the equipment is operated. In the case of intentional radiators operating under the provisions of subpart E, the emission bandwidth may span across multiple contiguous frequency bands identified in that subpart. The requirement to contain the designated bandwidth of the emission within the specified frequency band includes the effects from frequency sweeping, frequency hopping and other modulation techniques that may be employed as well as the frequency stability of the transmitter over expected variations in temperature and supply voltage. If a frequency stability is not specified in the regulations, it is recommended that the fundamental emission be kept within at least the central 80% of the permitted band in order to minimize the possibility of out-of-band operation.

47CFR § 15.245 Operation within the bands 902-928 MHz, 2435-2465 MHz, 5785-5815 MHz, 10500-10550 MHz, and 24075-24175 MHz.

(b) The field strength of emissions from intentional radiators operated within these frequency bands shall comply with the following:

| Fundamental frequency (MHz) | Field strength of fundamental (millivolts/meter) | Field strength of harmonics (millivolts/meter) |
|------------------------------------|---|---|
| 902-928 | 500 | 1.6 |
| 2435-2465 | 500 | 1.6 |
| 5785-5815 | 500 | 1.6 |
| 10500-10550 | 2500 | 25.0 |
| 24075-24175 | 2500 | 25.0 |

4.2.3 Test Procedures

Testing is performed acc. to ANSI C63.10-2013.

- a) The spectrum analyzer center frequency is set to the nominal EUT channel center frequency. The span range for the EMI receiver or spectrum analyzer shall be between two times and five times the OBW.
- b) The nominal IF filter bandwidth (3 dB RBW) shall be in the range of 1% to 5% of the OBW and video bandwidth (VBW) shall be approximately three times RBW, unless otherwise specified by the applicable requirement.
- c) Set the reference level of the instrument as required, keeping the signal from exceeding the maximum input mixer level for linear operation. In general, the peak of the spectral envelope shall be more than $[10 \log (OBW/RBW)]$ below the reference level. Specific guidance is given in 4.1.5.2.
- d) Steps a) through c) might require iteration to adjust within the specified tolerances.
- e) The dynamic range of the instrument at the selected RBW shall be more than 10 dB below the target “-xx dB down” requirement; that is, if the requirement calls for measuring the -20 dB OBW, the instrument noise floor at the selected RBW shall be at least 30 dB below the reference value.
- f) Set detection mode to peak and trace mode to max hold.
- g) Determine the reference value: Set the EUT to transmit an unmodulated carrier or modulated signal, as applicable. Allow the trace to stabilize. Set the spectrum analyzer marker to the highest level of the displayed trace (this is the reference value).
- h) Determine the “-xx dB down amplitude” using $[(\text{reference value}) - xx]$. Alternatively, this calculation may be made by using the marker-delta function of the instrument.
- i) If the reference value is determined by an unmodulated carrier, then turn the EUT modulation ON, and either clear the existing trace or start a new trace on the spectrum analyzer and allow the new trace to stabilize. Otherwise, the trace from step g) shall be used for step j).
- j) Place two markers, one at the lowest frequency and the other at the highest frequency of the envelope of the spectral display, such that each marker is at or slightly below the “-xx dB down amplitude” determined in step h). If a marker is below this “-xx dB down amplitude” value, then it shall be as close as possible to this value. The occupied bandwidth is the frequency difference between the two markers. Alternatively, set a marker at the lowest frequency of the envelope of the spectral display, such that the marker is at or slightly below the “-xx dB down amplitude” determined in step h). Reset the marker-delta function and move the marker to the other side of the emission until the delta marker amplitude is at the same level as the reference marker amplitude. The marker-delta frequency reading at this point is the specified emission bandwidth.
- k) The occupied bandwidth shall be reported by providing plot(s) of the measuring instrument display; the plot axes and the scale units per division shall be clearly labeled. Tabular data may be reported in addition to the plot(s).

Test on InnoSenT GmbH IPS-280 to 47 CFR § 15.245

4.2.4 Test Setup

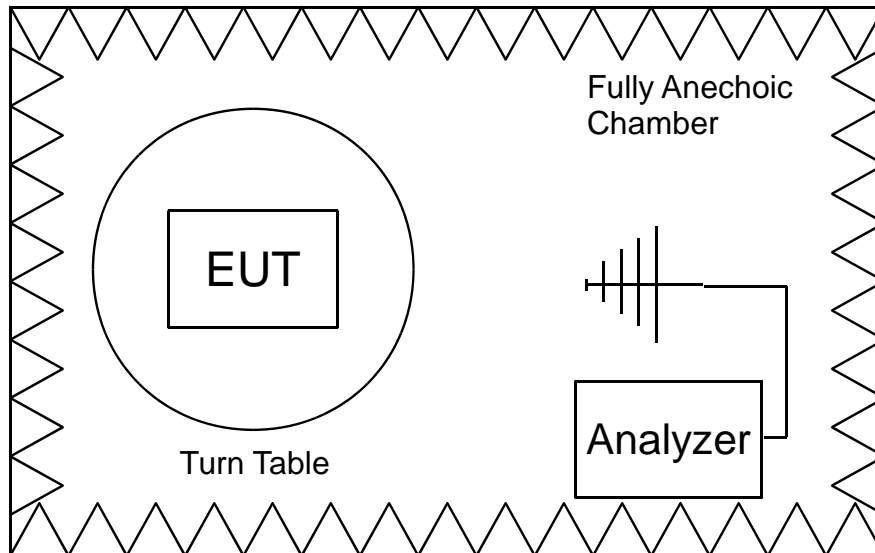

SCHEMATIC TEST SETUP

Requirement: 47 CFR, § 15.215
Procedure: ANSI C63.10-2013

Receiver: #3831
Antenna: #1300

Test Distance: 1 m

TEST EQUIPMENT USED:
Refer to chapter 5 of this document.
1294, 1300, 1301, 1868, 3831, 4524,
4717, 4721, 5612

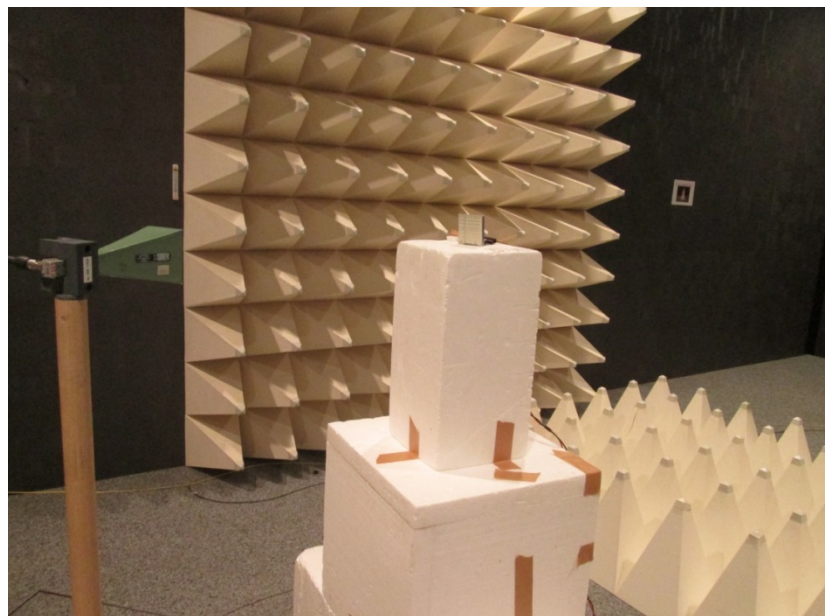

Sample photo of setup

Test on InnoSenT GmbH IPS-280 to 47 CFR § 15.245

4.2.5 Detailed Test Data

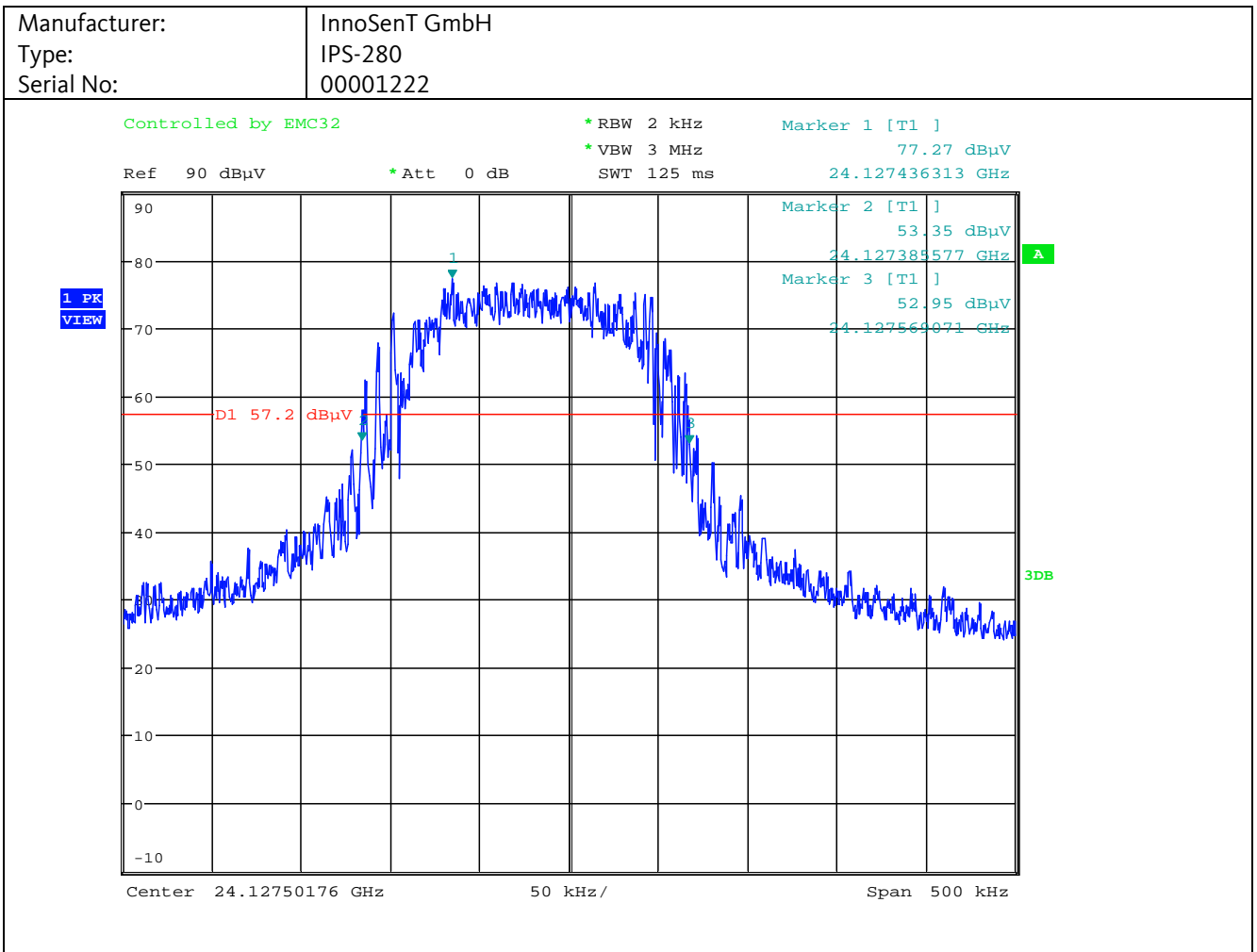

Final Result:

| Center Frequency | Lower 20 dB Freq. Edge | Upper 20 dB Freq. Edge | 20 dB Bandwidth | Limit |
|------------------|------------------------|------------------------|-----------------|----------------------------------|
| [GHz] | [GHz] | [GHz] | [kHz] | --- |
| 24.13 | 24.1273856 | 24.1275691 | 183.5 | Within band 24.075-24.175 GHz |

Test on InnoSenT GmbH IPS-280 to 47 CFR § 15.245

4.2.6 Test Result

Manufacturer: InnoSenT GmbH
Type: IPS-280
Serial No.: 00001222
Test date: 2018-12-21
Test personnel: Patrick Reusch

The EUT meets the requirements of this section.

Test on InnoSenT GmbH IPS-280 to 47 CFR § 15.245

4.3 Field Strength of Fundamental

4.3.1 Regulation

47CFR §15.245 Operation within the bands 902-928 MHz, 2435-2465 MHz, 5785-5815 MHz, 10500-10550 MHz, and 24075-24175 MHz.

(b) The field strength of emissions from intentional radiators operated within these frequency bands shall comply with the following:

| Fundamental frequency (MHz) | Field strength of fundamental (millivolts/meter) | Field strength of harmonics (millivolts/meter) |
|-----------------------------|--|--|
| 902-928 | 500 | 1.6 |
| 2435-2465 | 500 | 1.6 |
| 5785-5815 | 500 | 1.6 |
| 10500-10550 | 2500 | 25.0 |
| 24075-24175 | 2500 | 25.0 |

(2) Field strength limits are specified at a distance of 3 meters.

4.3.2 Test Procedures

ANSI C63.10-2013, 6.6.4.1 General

Subclauses 6.6.4.2 and 6.6.4.3 describe the procedures that shall be used for making exploratory and final radiated emission tests for frequencies above 1 GHz. Measurements may be performed at a distance closer than that specified in the requirements; however, an attempt shall be made to avoid making measurements in the near field of both the measurement antenna and the EUT for final measurements.

In performing these measurements, the sensitivity of the complete measurement system relative to the limit shall be determined before the test. If the overall measurement sensitivity does not provide a noise floor more than 6 dB below the limit, then low-noise preamplifiers, closer test distances, higher gain antennas, or narrower bandwidths might be required. If closer measurement distances are used, then the beamwidth of the measurement antenna versus the size of the EUT shall be taken into account. Also, measurement system overload protection shall be determined to be adequate when preamplifiers are used [see item b) of 4.1.3]. The effects of using bandwidths different from those specified shall also be determined (see also 6.3). Any changes from the specific measurement conditions shall be described in the report of the measurements (see also Annex E).

Install an appropriate filter at the input of the measurement system power amplifier. This filter shall attenuate the fundamental emission of the EUT and allow an accurate measurement of the associated harmonics and spurious emissions. The filter shall be characterized, and any attenuation/loss factors shall be accounted for in the measurement results.

Data shall be recorded in peak and average detection up to the highest measurement frequency required (unless stated otherwise in the applicable requirements).

ANSI C63.10-2013, 6.6.4.2 Exploratory radiated emissions measurements

Exploratory radiated measurements shall be performed at the measurement distance or at a closer distance than that specified for compliance to determine the emission characteristics of the EUT and, if applicable, the EUT configuration that produces the maximum level of emissions. The frequencies of maximum emission may be determined by manually positioning the antenna close to the EUT, and then moving the antenna over all sides of the EUT while observing a spectral display. It is advantageous to have prior knowledge of the frequencies of emissions, although this may be determined from such a near-field scan. The near-field scan shall only be used to determine the frequency but not the amplitude of the emissions. Where exploratory measurements are not adequate to determine the worst-case operating

Test on InnoSenT GmbH IPS-280 to 47 CFR § 15.245

modes and are used only to identify the frequencies of the highest emissions, additional preliminary tests can be required.

Preliminary tests shall be performed following the procedures in 6.3 on a site meeting the requirements of 5.2. For emissions from the EUT, the maximum level shall be determined by rotating the EUT and its antenna through 0° to 360°. For each mode of operation required to be tested, the frequency spectrum (based on findings from exploratory measurements) shall be monitored.

Broadband antennas and a spectrum analyzer or a radio-noise meter with a panoramic display are often useful in this type of test. If either antenna height or EUT azimuth are not fully measured during exploratory testing, then complete testing can be required at the OATS or semi-anechoic chamber when the final full spectrum testing is performed.

ANSI C63.10-2013, 6.6.4.3 Final radiated emissions measurements

The final measurements are performed on a site meeting the requirements of 5.2. Using the orientation and equipment arrangement of the EUT based on the measurement results found during the preliminary (exploratory) measurements per 6.6.4.2, the EUT arrangement, appropriate modulation, and modes of operation that produce the emissions that have the highest amplitude relative to the limit shall be selected for the final measurement. The final measurement shall follow all the procedures in 6.3 with the EUT operating on frequencies per 5.6. For each mode selected, record the frequency and amplitude of the highest fundamental emission (if applicable), as well as the frequency and amplitude of the six highest spurious emissions relative to the limit. Emissions more than 20 dB below the limit do not need to be reported.

Measurements are performed with the EUT rotated from 0° to 360°; the antenna height scanned in accordance with 6.6.3.1, 6.6.3.2, or 6.6.3.3, as appropriate; and the antenna rotated to repeat the measurements for both the horizontal and vertical antenna polarizations. Variations in cable or wire placement shall be explored to maximize the measured emissions.

The emission signal shall be kept within the illumination area of the 3 dB beamwidth of the antenna so that the maximum emission from the EUT is measured. This may be achieved by either pointing the antenna at an angle toward the source of the emission or by testing the EUT as described in 6.6.3.3. If the emission is pulsed, then refer to Annex C for guidelines on selecting bandwidth and determining pulse desensitization factors, as necessary.

As noted in 6.6.4.1, when performing these measurements, the sensitivity of the complete measurement system relative to the limit shall be determined before the test. If the overall measurement sensitivity is inadequate, then low-noise preamplifiers, closer measurement distances, higher gain antennas, or narrower bandwidths may be used. If closer measurement distances or higher gain antennas are used, then the beamwidth of the measurement antenna versus the physical size of the EUT shall be taken into account, so that the physical sizes of the EUT dimensions are encompassed by the beamwidth of the measurement antenna. Also, measurement system overload protection shall be determined to be adequate when preamplifiers are used. The effects on the measured emission value using bandwidths different from those specified shall be determined if such bandwidth changes are made. Any changes from the specific measurement conditions shall be described in the report of the measurements.

Unless specified otherwise by the regulatory authority, the instrumentation, detector functions, and bandwidths specified in 4.1.4.2.1 and 4.1.4.2.2 shall be used. For pulsed emissions, the procedure in 4.1.4.2.4 shall be used

| Radiated Emissions Test Characteristics | |
|--|------------------------------|
| Frequency range | 24 GHz |
| Test distance | 1 m |
| Test instrumentation resolution bandwidth | 1 MHz |
| Receive antenna height | 1.5 m |
| Receive antenna polarization | Vertical/Horizontal |
| Measurement chamber | Fully anechoic chamber (FAC) |

Test on InnoSenT GmbH IPS-280 to 47 CFR § 15.245

4.3.3 Calculation of Field Strength Limits

E.g. radiated emissions field strength limits for the inside the band 24.075- 24.175 GHz:

2500 mV/m (=2 500 000 μ V/m) at 3 meters

Using the equation:

$$E_{dB\mu V/m} = 20 \log (E_{\mu V/m})$$

where

$E_{dB\mu V/m}$ = Field Strength in logarithmic units (in dB μ V/m)

$E_{\mu V/m}$ = Field Strength in linear units (in μ V/m)

A field strength limit of 2 500 000 μ V/m corresponds with 128 dB μ V/m.

Distance correction (limit)

Remark: The preferred method is the correction of the measured field strength (refer to 4.2.3) instead of limit correction. Only one correction method shall be applied to a particular measurement.

In case of testing being performed in a distance other than specified, the limit may be adjusted by a Distance Extrapolation Factor DF of 20 dB per decade, which is calculated by the following equation:

$$DF = 20 \log (D_{test}/D_{specification})$$

where

DF = Distance Extrapolation Factor (in dB)

D_{test} = Distance, where measurement was performed (in m)

$D_{specification}$ = Distance acc. to specification (in m)

Example: Assume a limit specified in 3 m and a measurement performed at 1 m: The distance correction factor is $20 \log (3/1) = 9.5$. This factor is mathematically added to the limit by the following equation:

$$E_{dB\mu V/m_new} = E_{dB\mu V/m} + DF$$

where

$E_{dB\mu V/m}$ = Field Strength limit in logarithmic units (in dB μ V/m)

$E_{dB\mu V/m_new}$ = Corrected Field Strength limit in logarithmic units (in dB μ V/m)

DF = Distance Extrapolation Factor (in dB)

Example: Assume a limit of 128 dB μ V/m specified in 3 m distance and the measurement performed at 1 m. The limit is adjusted by the distance correction factor of 9.5 dB to the new limit of 137.5 dB μ V/m.

Test on InnoSenT GmbH IPS-280 to 47 CFR § 15.245

4.3.4 Field Strength Calculation

The field strength is calculated by adding the Antenna Factor and Cable Factor. The basic equation with a sample calculation is as follows:

$$FS = RA + AF + CF$$

where

FS = Field Strength (in dB μ V/m)

RA = Receiver Amplitude (in dB μ V)

AF = Antenna Factor (in dB (1/m))

CF = Cable Attenuation Factor (in dB)

Assume a receiver reading of 82.6 dB μ V is obtained. The Antenna Factor of 37.2 dB(1/m) and a Cable Factor of 2.7 dB are added, giving a field strength of 122.5 dB μ V/m in the measurement distance. The field strength of 122.5 dB μ V/m value can be mathematically converted to its corresponding level in μ V/m.

$$FS = 82.6 + 37.2 + 2.7 = 122.5$$

$$\text{Level (in } \mu\text{V/m)} = \text{Common Antilogarithm (122.5/20)} = 1\ 333\ 521$$

Distance correction (field strength)

Remark: The preferred method is the correction of the measured field strength instead of limit correction (refer to 4.2.2). Only one correction method shall be applied to a particular measurement..

If a measurement is performed at a different distance other than specified, the field strength at the specified distance can be obtained by the following equation:

$$FS_{D_{\text{specified}}} = FS_{D_{\text{test}}} + 20 \log (D_{\text{test}}/D_{\text{specified}})$$

where

$FS_{D_{\text{specified}}}$ = Field Strength at specified distance $D_{\text{specified}}$ (in dB μ V/m)

$FS_{D_{\text{test}}}$ = Field Strength at specified distance D_{test} (in dB μ V/m)

D_{test} = Measurement distance where test was performed (in m)

$D_{\text{specified}}$ = Measurement distance as specified by the rules (in m)

Assuming a recorded field strength of 122.5 dB μ V/m in a distance of 1 m. If the rules are specifying a limit in a distance of 3 m, the field strength recorded in 1 m is corrected by the distance. Therefore, the field strength $FS_{D_{\text{specified}}}$ is $122.5 + 20 \log (1 / 3) = 113.0$ (in dB μ V/m).

Test on InnoSenT GmbH IPS-280 to 47 CFR § 15.245

4.3.5 Test Setup

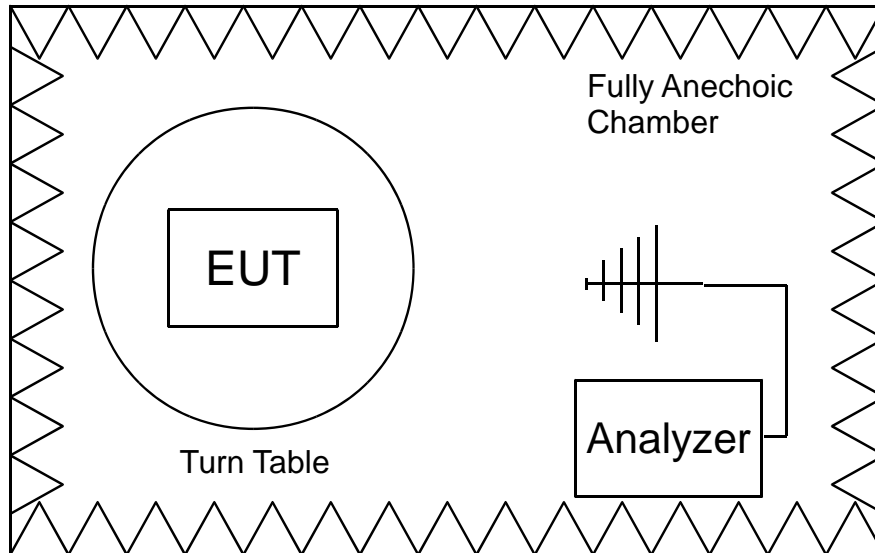

SCHEMATIC TEST SETUP

Requirement: 47 CFR, § 15.245
Procedure: ANSI C63.10-2013

Receiver: #3831
Antenna: #1300

Test distance: 1 m

TEST EQUIPMENT USED:
Refer to chapter 5 of this document.
1294, 1300, 1301, 1868, 3831, 4524,
4717, 4721, 5612

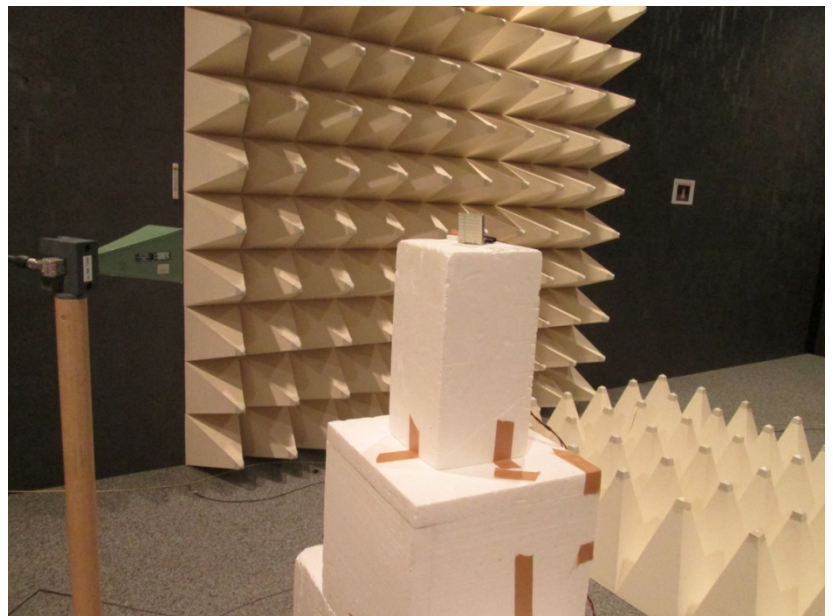

Sample photo of setup

Test on InnoSenT GmbH IPS-280 to 47 CFR § 15.245

4.3.6 Detailed Test Data

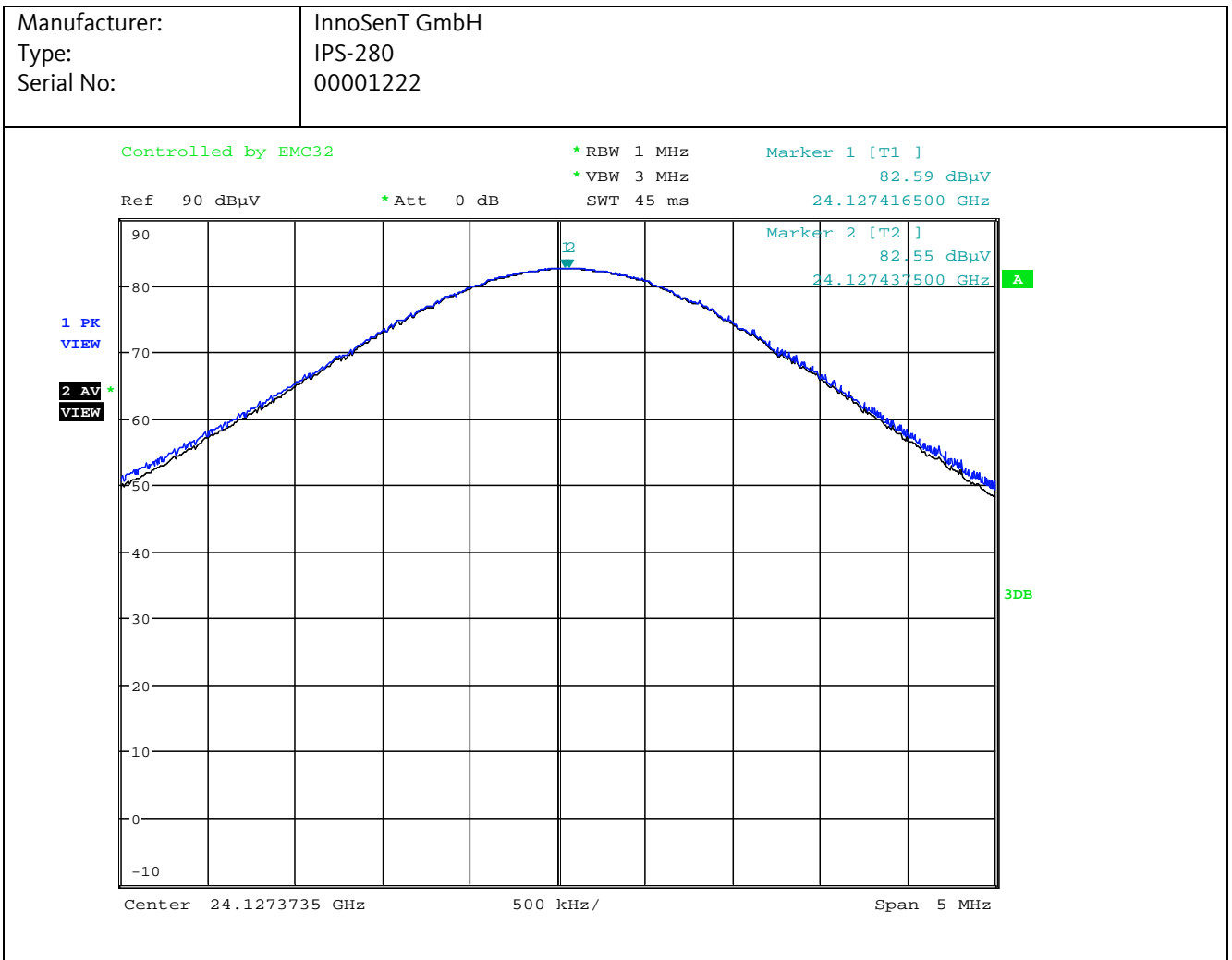

Note: the plot is showing the raw measurement data without correction factors applied.

Final Result:

| Frequency | AV-Reading | Test Distance | Cable Loss | Antenna Factor | Result @ 3m | AV-Limit | Margin |
|-----------|------------|---------------|------------|----------------|-------------|----------|--------|
| [GHz] | [dBμV] | [m] | [dB] | [dB/m] | [dBμV/m] | [dBμV/m] | [dB] |
| 24.13 | 82.6 | 1.0 | 2.7 | 37.2 | 113.0 | 128.0 | 15.0 |

Test on InnoSenT GmbH IPS-280 to 47 CFR § 15.245

4.3.7 Test Result

Manufacturer: InnoSenT GmbH
Type: IPS-280
Serial No.: 00001222
Test date: 2018-12-21
Test personnel: Patrick Reusch

The EUT meets the requirements of this section.

4.4 Radiated Emissions

4.4.1 Regulation

47CFR § 15.33 Frequency range of radiated measurements

(a) For an intentional radiator, the spectrum shall be investigated from the lowest radio frequency signal generated in the device, without going below 9 kHz, up to at least the frequency shown in this paragraph:

- (1) If the intentional radiator operates below 10 GHz: to the tenth harmonic of the highest fundamental frequency or to 40 GHz, whichever is lower.
- (2) If the intentional radiator operates at or above 10 GHz and below 30 GHz: to the fifth harmonic of the highest fundamental frequency or to 100 GHz, whichever is lower.
- (3) If the intentional radiator operates at or above 30 GHz: to the fifth harmonic of the highest fundamental frequency or to 200 GHz, whichever is lower, unless specified otherwise elsewhere in the rules.
- (4) If the intentional radiator contains a digital device, regardless of whether this digital device controls the functions of the intentional radiator or the digital device is used for additional control or function purposes other than to enable the operation of the intentional radiator, the frequency range shall be investigated up to the range specified in paragraphs (a)(1) through (a)(3) of this section or the range applicable to the digital device, as shown in paragraph (b)(1) of this section, whichever is the higher frequency range of investigation.

47 CFR § 15.35 Measurement detector functions and bandwidths.

(a) On any frequency or frequencies below or equal to 1000 MHz, the limits shown are based on measuring equipment employing a CISPR quasi-peak detector function and related measurement bandwidths, unless otherwise specified. The specifications for the measuring instrumentation using the CISPR quasi-peak detector can be found in ANSI C63.4-2014, clause 4 (incorporated by reference, see §15.38). As an alternative to CISPR quasi-peak measurements, the responsible party, at its option, may demonstrate compliance with the emission limits using measuring equipment employing a peak detector function as long as the same bandwidth as indicated for CISPR quasi-peak measurements are employed.

47 CFR § 15.209 Radiated emission limits; general requirements.

(a) Except as provided elsewhere in this subpart, the emissions from an intentional radiator shall not exceed the field strength levels specified in the following table:

| Frequency (MHz) | Field strength (microvolts/meter) | Measurement distance (meters) |
|-----------------|-----------------------------------|-------------------------------|
| 0.009-0.490 | 2400/F(kHz) | 300 |
| 0.490-1.705 | 24000/F(kHz) | 30 |
| 1.705-30.0 | 30 | 30 |
| 30-88 | 100** | 3 |
| 88-216 | 150** | 3 |
| 216-960 | 200** | 3 |
| Above 960 | 500 | 3 |

**Except as provided in paragraph (g), fundamental emissions from intentional radiators operating under this section shall not be located in the frequency bands 54-72 MHz, 76-88 MHz, 174-216 MHz or 470-806 MHz. However, operation within these frequency bands is permitted under other sections of this part, e.g., §§15.231 and 15.241.

(e) The provisions in §§15.31, 15.33, and 15.35 for measuring emissions at distances other than the distances specified in the above table, determining the frequency range over which radiated emissions are to be measured, and limiting peak emissions apply to all devices operated under this part.

Test on InnoSenT GmbH IPS-280 to 47 CFR § 15.245

47CFR §15.245 Operation within the bands 902-928 MHz, 2435-2465 MHz, 5785-5815 MHz, 10500-10550 MHz, and 24075-24175 MHz.

(b) The field strength of emissions from intentional radiators operated within these frequency bands shall comply with the following:

| Fundamental frequency (MHz) | Field strength of fundamental (millivolts/meter) | Field strength of harmonics (millivolts/meter) |
|-----------------------------|--|--|
| 902-928 | 500 | 1.6 |
| 2435-2465 | 500 | 1.6 |
| 5785-5815 | 500 | 1.6 |
| 10500-10550 | 2500 | 25.0 |
| 24075-24175 | 2500 | 25.0 |

(1) Regardless of the limits shown in the above table, harmonic emissions in the restricted bands below 17.7 GHz, as specified in §15.205, shall not exceed the field strength limits shown in §15.209. Harmonic emissions in the restricted bands at and above 17.7 GHz shall not exceed the following field strength limits:

- (i) For the second and third harmonics of field disturbance sensors operating in the 24075-24175 MHz band and for other field disturbance sensors designed for use only within a building or to open building doors, 25.0 mV/m.
- (ii) For all other field disturbance sensors, 7.5 mV/m.
- (iii) Field disturbance sensors designed to be used in motor vehicles or aircraft must include features to prevent continuous operation unless their emissions in the restricted bands, other than the second and third harmonics from devices operating in the 24075-24175 MHz band, fully comply with the limits given in §15.209. Continuous operation of field disturbance sensors designed to be used in farm equipment, vehicles such as fork lifts that are intended primarily for use indoors or for very specialized operations, or railroad locomotives, railroad cars and other equipment which travels on fixed tracks is permitted. A field disturbance sensor will be considered not to be operating in a continuous mode if its operation is limited to specific activities of limited duration (e.g., putting a vehicle into reverse gear, activating a turn signal, etc.).

(2) Field strength limits are specified at a distance of 3 meters.

(3) Emissions radiated outside of the specified frequency bands, except for harmonics, shall be attenuated by at least 50 dB below the level of the fundamental or to the general radiated emission limits in §15.209, whichever is the lesser attenuation.

(4) The emission limits shown above are based on measurement instrumentation employing an average detector. The provisions in §15.35 for limiting peak emissions apply.

Test on InnoSenT GmbH IPS-280 to 47 CFR § 15.245

4.4.2 Calculation of Field Strength Limits

E.g. radiated emissions field strength limits for the frequency band 30 - 88 MHz:

100 $\mu\text{V}/\text{m}$ at 3 meters

Using the equation:

$$E_{\text{dB}\mu\text{V}/\text{m}} = 20 \log (E_{\mu\text{V}/\text{m}})$$

where

$E_{\text{dB}\mu\text{V}/\text{m}}$ = Field Strength in logarithmic units (in $\text{dB}\mu\text{V}/\text{m}$)

$E_{\mu\text{V}/\text{m}}$ = Field Strength in linear units (in $\mu\text{V}/\text{m}$)

A field strength limit of 100 $\mu\text{V}/\text{m}$ corresponds with 40.0 $\text{dB}\mu\text{V}/\text{m}$.

Distance correction (limit)

Remark: The preferred method is the correction of the measured field strength (refer to 4.2.3) instead of limit correction. Only one correction method shall be applied to a particular measurement.

In case of testing being performed in a distance other than specified, the limit may be adjusted by a Distance Extrapolation Factor DF of 20 dB per decade, which is calculated by the following equation:

$$\text{DF} = 20 \log (D_{\text{test}}/D_{\text{specification}})$$

where

DF = Distance Extrapolation Factor (in dB)

D_{test} = Distance, where measurement was performed (in m)

$D_{\text{specification}}$ = Distance acc. to specification (in m)

Example: Assume a limit specified in 3 m and a measurement performed at 1 m: The distance correction factor is $20 \log (3 / 1) = 9.5$. This factor is mathematically added to the limit by the following equation:

$$E_{\text{dB}\mu\text{V}/\text{m}_{\text{new}}} = E_{\text{dB}\mu\text{V}/\text{m}} + \text{DF}$$

where

$E_{\text{dB}\mu\text{V}/\text{m}}$ = Field Strength limit in logarithmic units (in $\text{dB}\mu\text{V}/\text{m}$)

$E_{\text{dB}\mu\text{V}/\text{m}_{\text{new}}}$ = Corrected Field Strength limit in logarithmic units (in $\text{dB}\mu\text{V}/\text{m}$)

DF = Distance Extrapolation Factor (in dB)

Example: Assume a limit of 40.0 $\text{dB}\mu\text{V}/\text{m}$ specified in 3 m distance and the measurement performed at 3 m. The limit is adjusted by the distance correction factor of 9.5 dB to the new limit of 49.5 $\text{dB}\mu\text{V}/\text{m}$.

Test on InnoSenT GmbH IPS-280 to 47 CFR § 15.245

4.4.3 Field Strength Calculation

The field strength is calculated by adding the Antenna Factor and Cable Factor. The basic equation with a sample calculation is as follows:

$$FS = RA + AF + CF$$

where

FS = Field Strength (in dB μ V/m)

RA = Receiver Amplitude (in dB μ V)

AF = Antenna Factor (in dB (1/m))

CF = Cable Attenuation Factor (in dB)

Assume a receiver reading of 30 dB μ V is obtained. The Antenna Factor of 10 dB(1/m) and a Cable Factor of 1.2 dB are added, giving a field strength of 41.2 dB μ V/m in the measurement distance. The field strength of 41.2 dB μ V/m value can be mathematically converted to its corresponding level in μ V/m.

$$FS = 30 + 10 + 1.2 = 41.2$$

$$\text{Level (in } \mu\text{V/m)} = \text{Common Antilogarithm (41.2/20)} = 114.8$$

Distance correction (field strength)

Remark: The preferred method is the correction of the measured field strength instead of limit correction (refer to 4.2.2). Only one correction method shall be applied to a particular measurement..

If a measurement is performed at a different distance other than specified, the field strength at the specified distance can be obtained by the following equation:

$$FS_{D_{\text{specified}}} = FS_{D_{\text{test}}} + 20 \log (D_{\text{test}}/D_{\text{specified}})$$

where

$FS_{D_{\text{specified}}}$ = Field Strength at specified distance $D_{\text{specified}}$ (in dB μ V/m)

$FS_{D_{\text{test}}}$ = Field Strength at specified distance D_{test} (in dB μ V/m)

D_{test} = Measurement distance where test was performed (in m)

$D_{\text{specified}}$ = Measurement distance as specified by the rules (in m)

Assuming a recorded field strength of 41.2 dB μ V/m in a distance of 1 m. If the rules are specifying a limit in a distance of 3 m, the field strength recorded in 1 m is corrected by the distance. Therefore, the field strength $FS_{D_{\text{specified}}}$ is $41.2 + 20 \log (1 / 3) = 31.7$ (in dB μ V/m).

Remark: Using EMC32 software corrections are combined in the Corr. Factor as listed in the results' table.

"Result" represents the FS Result, "Corr." is the combined correction factor.

Test on InnoSenT GmbH IPS-280 to 47 CFR § 15.245

4.4.4 Radiated Emissions 9 kHz – 30 MHz

4.4.4.1 Test Procedures

ANSI C63.10-2013, 6.4.3 Measuring antenna selection, location, and test distance

Radiated emission tests shall be performed in the frequency range of 9 kHz to 30 MHz, using a calibrated loop antenna as specified in 4.3.2, at a suitable site and measurement distance as specified in 5.3. This method is applicable for measuring radiated RF emissions from all units, cables, power cords, and interconnect cabling or wiring of the EUT, by applying the guidance provided in 5.10 along with guidance provided subsequently.

ANSI C63.10-2013, 6.4.6 Exploratory radiated emission tests

The tests shall be performed in the frequency range specified in 5.5 and 5.6, using the procedures in Clause 5, applying the appropriate modulating signal to the EUT, to determine cable or wire positions of the EUT system that produce the emission with the highest amplitude relative to the limit.

Exploratory measurements below 30 MHz are useful in determining the maximum level of emissions while manipulating and rotating the EUT; however, exploratory and final measurements may be made concurrently, provided care is taken to determine the maximum level of emissions for all configurations and orientations.

The test arrangement, measuring antenna guidelines and operational configurations in 6.3.1 and 6.3.2, shall be followed. The measurement antenna shall be positioned with its plane perpendicular to the ground at the specified distance. When perpendicular to the ground plane, the lowest height of the magnetic antenna shall be 1 m above the ground and shall be positioned at the specified distance from the EUT. When the EUT contains a loop antenna that can only be placed in a vertical axis, normal measurements shall be made aligning the measurement antenna along the site axis, and then orthogonal to the axis. For each measurement antenna alignment, the EUT shall be rotated through 0° to 360° on a turntable. When the EUT contains a loop antenna that can be placed in a horizontal or vertical axis, normal measurements shall be made aligning the measurement antenna along the site axis, orthogonal to the axis, and then with the measurement antenna horizontal. For each measurement antenna alignment, the EUT shall be rotated through 0° to 360° on a turntable. The report shall list the six emissions with the smallest margin relative to the limit, for each of the three antenna orientations (parallel, perpendicular, and ground-parallel) unless the margin is greater than 20 dB, then the following statement shall be made: “all emissions were greater than 20 dB below the limit.”

ANSI C63.10-2013, 6.4.7 Final radiated emission tests

Using the orientation and equipment arrangement of the EUT determined in 6.4.6, and applying the appropriate modulating signal to the EUT, perform final radiated emission measurements on the fundamental and highest spurious emissions.

Unless otherwise specified by the regulatory authority, the instrumentation, detector functions, and bandwidths specified in 4.1.4.2.1 shall be used. For pulsed emissions, the procedure in 4.1.4.2.4 shall be used.

| Radiated Emissions Test Characteristics | |
|---|---|
| Frequency range | 9 kHz – 30 MHz |
| Test distance | 3 m |
| Test instrumentation resolution bandwidth | 200 Hz (< 150 kHz) 9 kHz (≥ 150 kHz) |
| Receive antenna height | 1 m |
| Receive antenna orientations | 2 |
| Measurement chamber | Semi anechoic chamber (SAC) |

Following the test procedure described in KDB 414788, an open field measurement has to be performed in addition to the measurements performed in a semi anechoic chamber to evaluate a correction of the open field measurement to the semi-anechoic chamber measurement.

Hence laboratory experience has shown, that the correction factor is always negative, resulting in a lower level at the open field, these open field measurements are omitted, if there are all measurement emissions more than 20 dB below the limit.

Test on InnoSenT GmbH IPS-280 to 47 CFR § 15.245

4.4.4.2 Test Setup

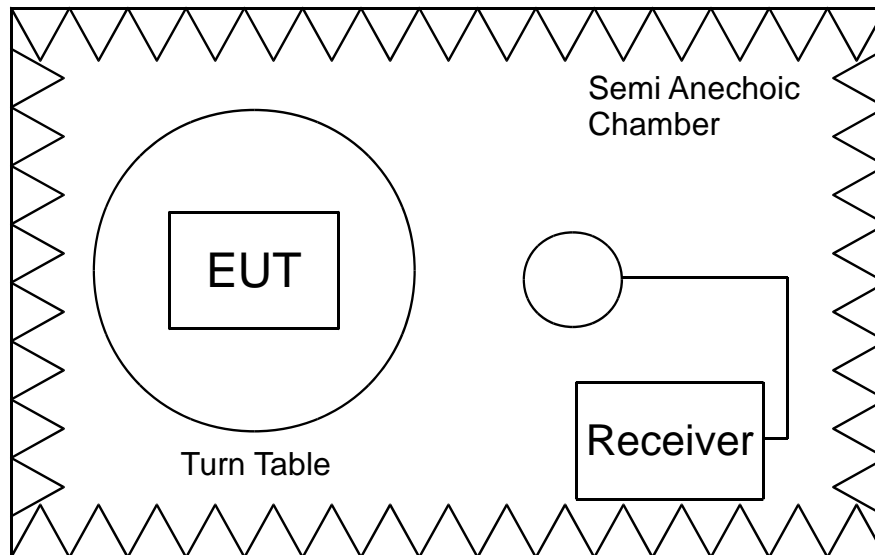

SCHEMATIC TEST SETUP

Requirement: 47 CFR, § 15.209
Procedure: ANSI C63.10-2013

Receiver: #3846
Antenna: #374

Test distance: 3 m

TEST EQUIPMENT USED:
Refer to chapter 5 of this document.
374, 1889, 1292, 3846, 4075, 4717,
4721, 5392

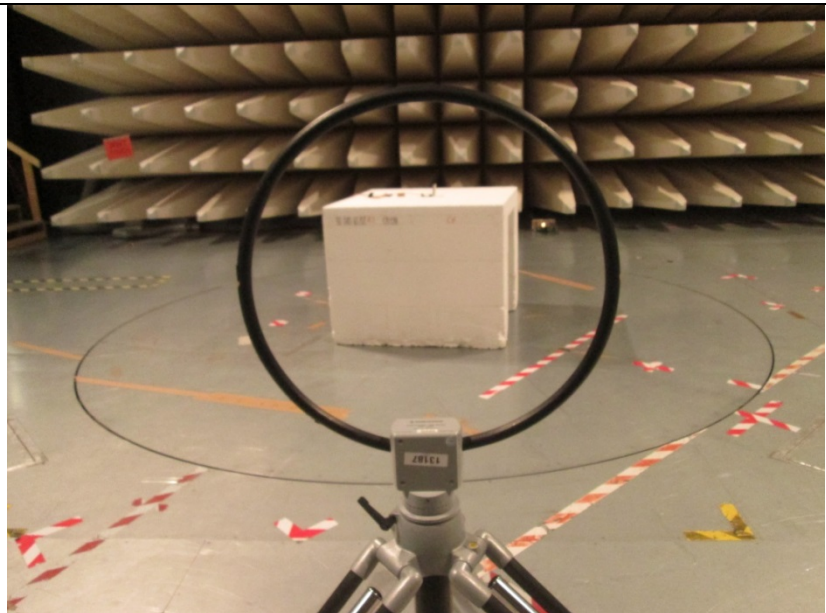

Sample photo of setup

Test on InnoSenT GmbH IPS-280 to 47 CFR § 15.245

4.4.4.3 Detailed Test Data

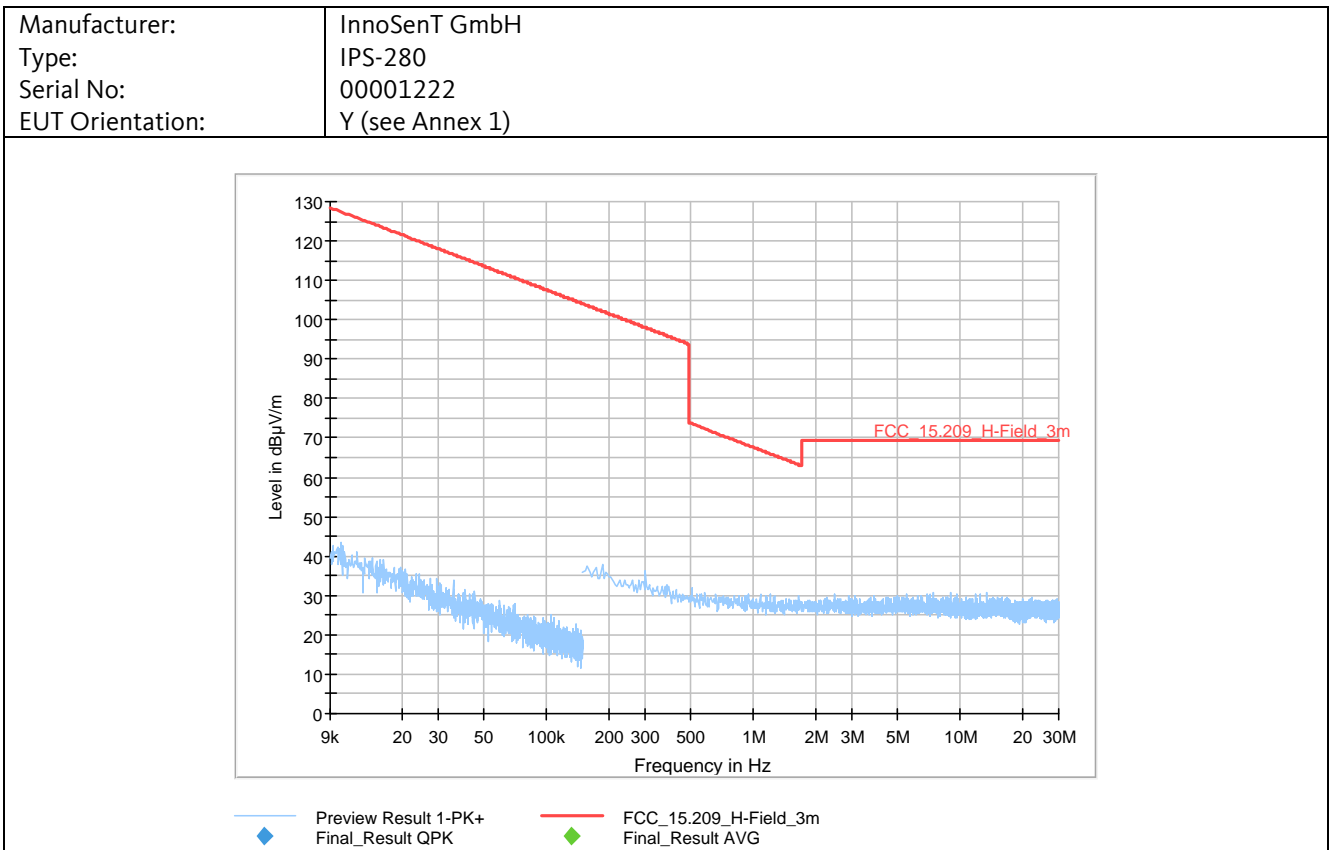
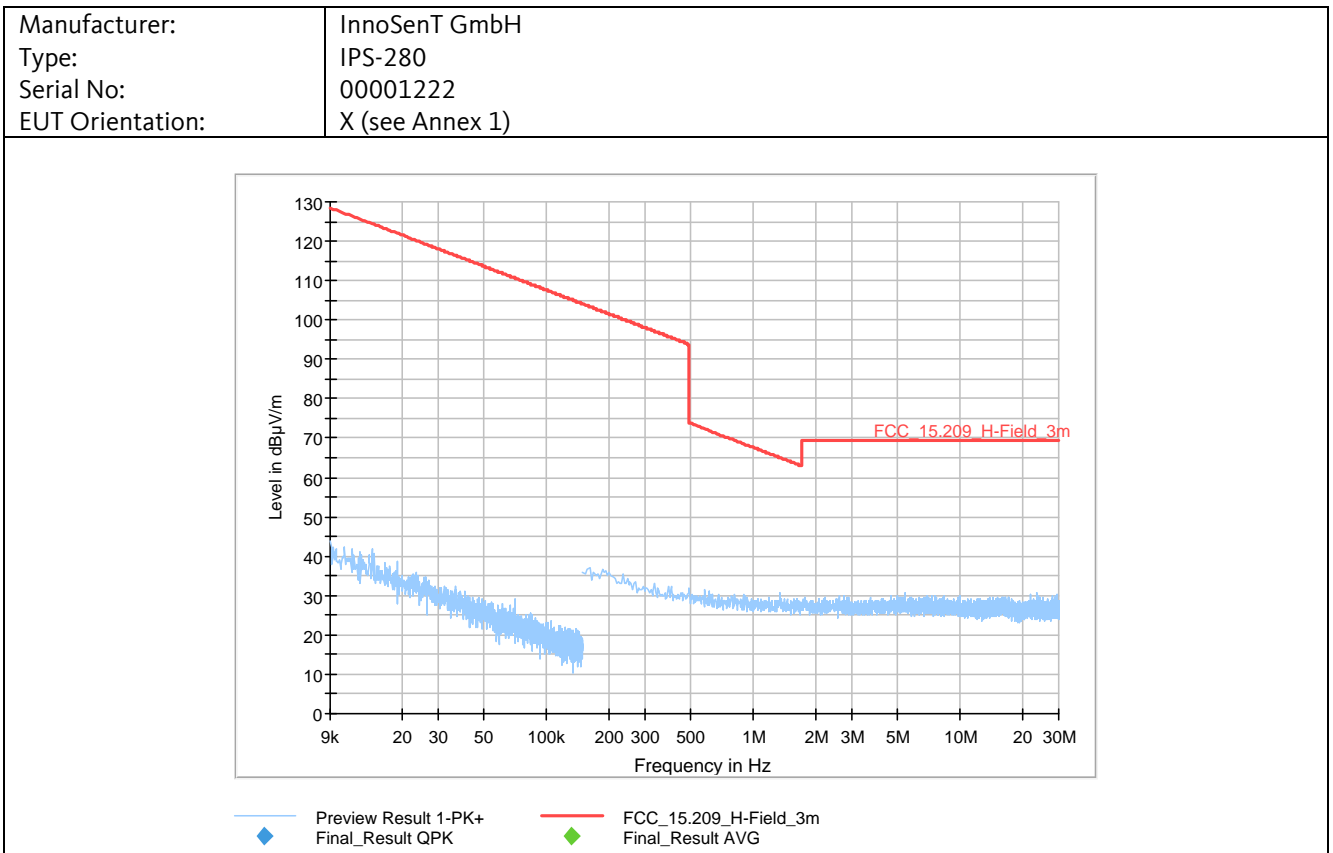

Test on InnoSenT GmbH IPS-280 to 47 CFR § 15.245

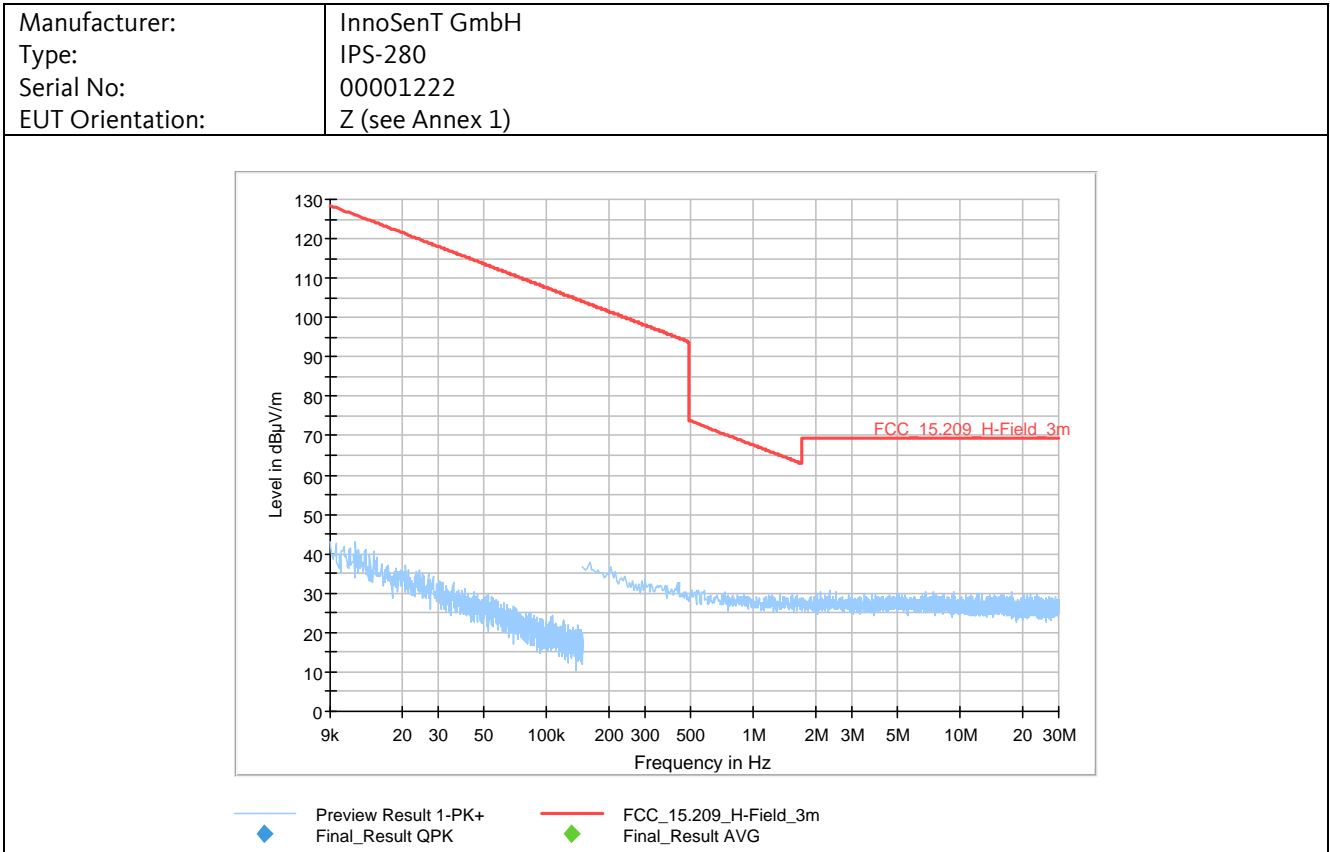

Final Result:

| Frequency MHz | QuasiPeak dBµV/m | Limit dBµV/m | Margin dB | Meas. Time ms | Bandwidth Hz | Height cm | Pol -- | Azimuth deg | Corr. dB/m |
|--|---------------------|-----------------|--------------|------------------|-----------------|--------------|-----------|----------------|---------------|
| All emissions were greater than 20 dB below the limit. Therefore, no final measurement performed. | | | | | | | | | |

All tests performed at the distance denoted in chapter 4.4.4.1. The limit was adjusted to correspond with the test distance. The table above contains worst-case emissions, only. For further details refer to the pre-scan test plot above.

4.4.4.4 Test Result

Manufacturer: InnoSenT GmbH
 Type: IPS-280
 Serial No.: 00001222
 Test date: 2018-12-18
 Test personnel: Patrick Reusch

The EUT meets the requirements of this section.

4.4.5 Radiated Emissions 30 MHz – 1000 MHz

4.4.5.1 Test Procedures

ANSI C63.10-2013 6.5 Radiated emissions from unlicensed wireless devices in the frequency range of 30 MHz to 1000 MHz

This subclause specifies conditions for compliance testing in the frequency range above 30 MHz and below 1 GHz. The following subclauses describe the procedures that shall be used for making exploratory and final radiated emission tests for frequencies between 30 MHz and 1000 MHz. Measurements may be performed at a distance closer than that specified in the requirements, provided the measuring antenna is beyond its near-field range as determined by the Rayleigh criteria.

ANSI C63.10-2013, 6.5.3 Exploratory radiated emission tests

Exploratory measurements are used to identify the frequencies and amplitudes of the emissions while manipulating and rotating the EUT.

Exploratory radiated measurements shall be performed at the measurement distance or at a closer distance than that specified for compliance to determine the emission characteristics of the EUT. At near distances, for EUTs of comparably small size, it is relatively easy to determine the spectrum signature of the EUT and, if applicable, the EUT configuration that produces the maximum level of emissions. Exploratory measurements shall be made on a test site per 5.2. Shielded rooms, not treated with RF absorption material, shall not be used for exploratory measurements.

For each mode of operation required to be tested, the frequency spectrum shall be monitored. The highest signal levels relative to the limit shall be determined by rotating the EUT from 0° to 360° and with varying the measurement antenna height between 1 m and 4 m in vertical and horizontal polarizations.

ANSI C63.10-2013, 6.5.4 Final radiated emission tests

Using the orientation and equipment arrangement of the EUT, and based on the measurement results found during the exploratory measurement in 6.5.3, the EUT arrangement, appropriate modulation, and modes of operation that produce the emissions that have the highest amplitude relative to the limit shall be selected for the final measurement. The final measurement shall follow all the procedures in 6.3 with the EUT operating on frequencies per 5.6. For each mode selected, record the frequency and amplitude of the highest fundamental emission (if applicable) and the frequency and amplitude of the six highest spurious emissions relative to the limit; emissions more than 20 dB below the limit do not need to be reported.

Measurements are performed with the EUT rotated from 0° to 360°, the antenna height scanned between 1 m and 4 m, and the antenna rotated to repeat the measurements for both the horizontal and vertical antenna polarizations.

Variations in cable or wire placement shall be explored to maximize the measured emissions.

Unless specified otherwise by the regulatory authority, the instrumentation, detector functions, and bandwidths specified in 4.1.4.2.1 and 4.1.4.2.2 shall be used. For pulsed emissions, the procedure in 4.1.4.2.4 shall be used.

| Radiated Emissions Test Characteristics | |
|--|-----------------------------|
| Frequency range | 30 MHz – 1000 MHz |
| Test distance | 3 m |
| Test instrumentation resolution bandwidth | 120 kHz |
| Receive antenna height | 1 m - 4 m |
| Angular steps size during prescan: | 90 ° |
| Receive antenna polarization | Vertical/Horizontal |
| Measurement location | Semi Anechoic Chamber (SAC) |

Test on InnoSenT GmbH IPS-280 to 47 CFR § 15.245

4.4.5.2 Test Setup

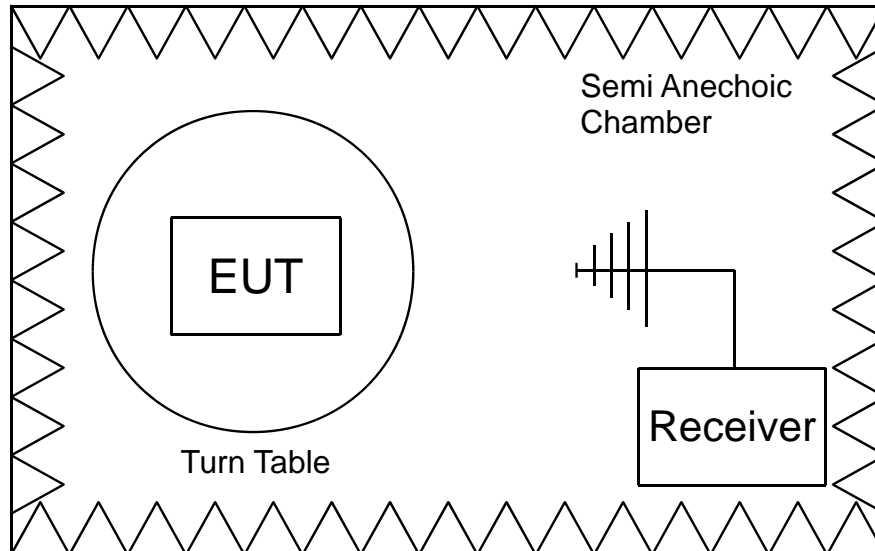

SCHEMATIC TEST SETUP

Requirement: 47 CFR, § 15.209
Procedure: ANSI C63.10-2013

Receiver: #3846
Antenna: #6041

Test distance: 3 m

TEST EQUIPMENT USED:
Refer to chapter 5 of this document.
54, 1291, 1292, 1889, 2724, 3846,
4075, 4717, 4721, 5392, 6041

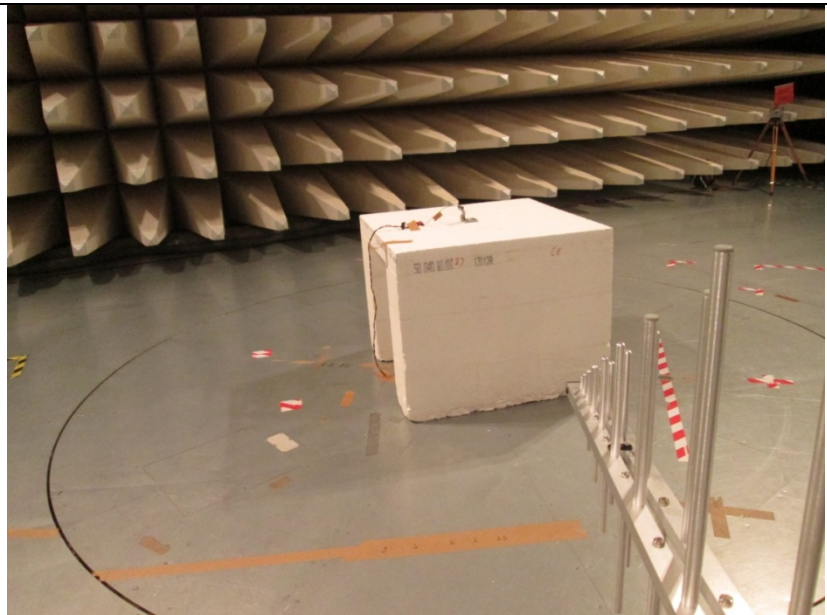

Sample photo of setup

Test on InnoSenT GmbH IPS-280 to 47 CFR § 15.245

4.4.5.3 Detailed Test Data

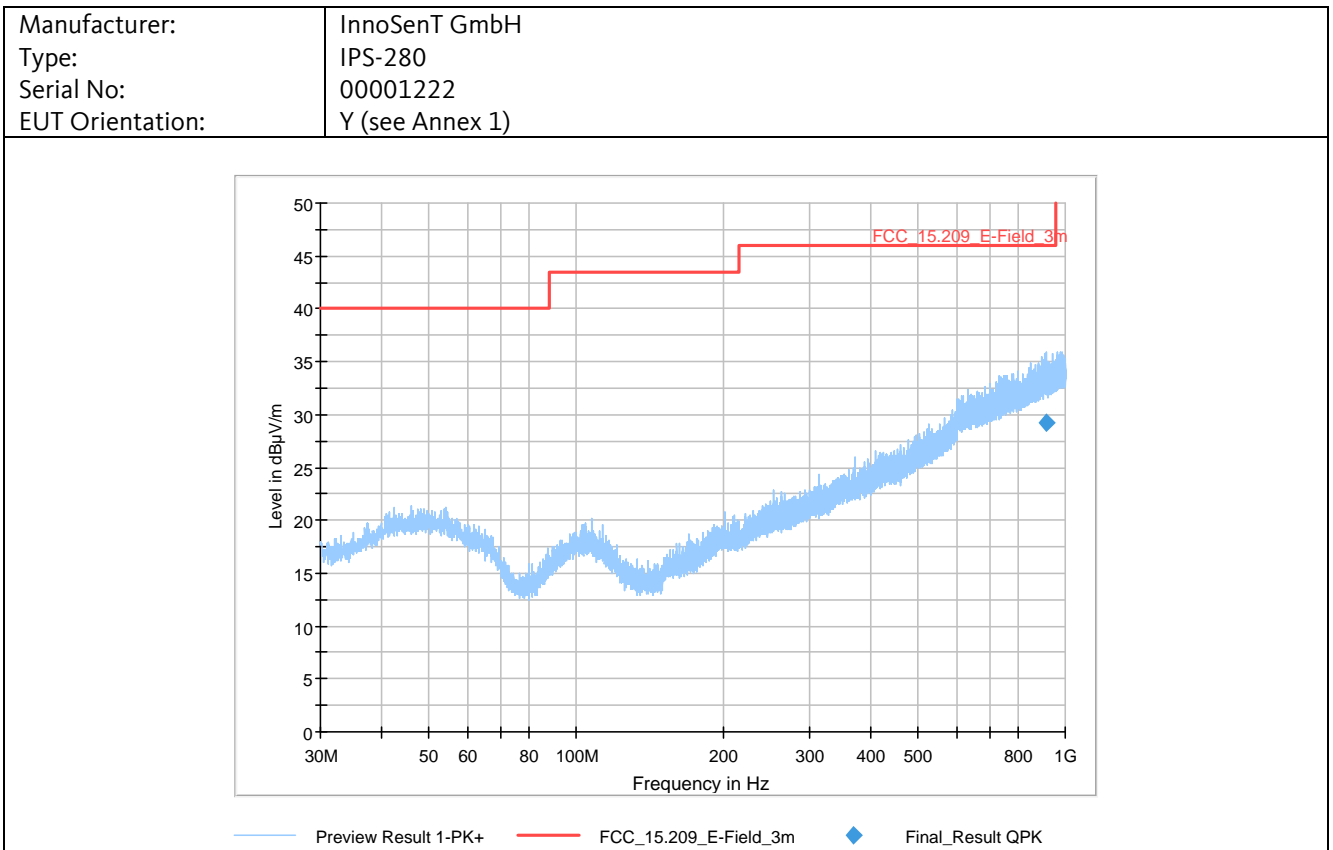
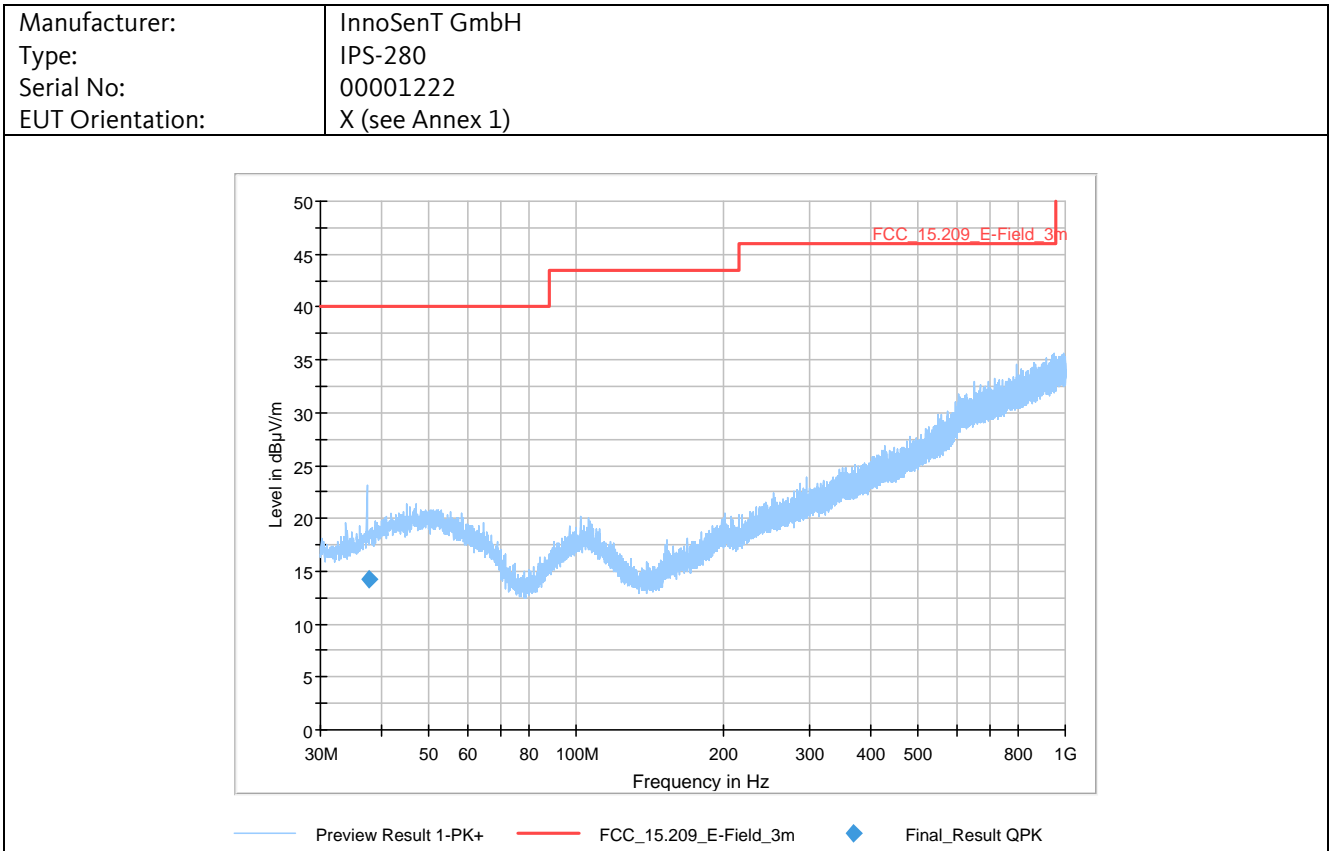

Test on InnoSenT GmbH IPS-280 to 47 CFR § 15.245

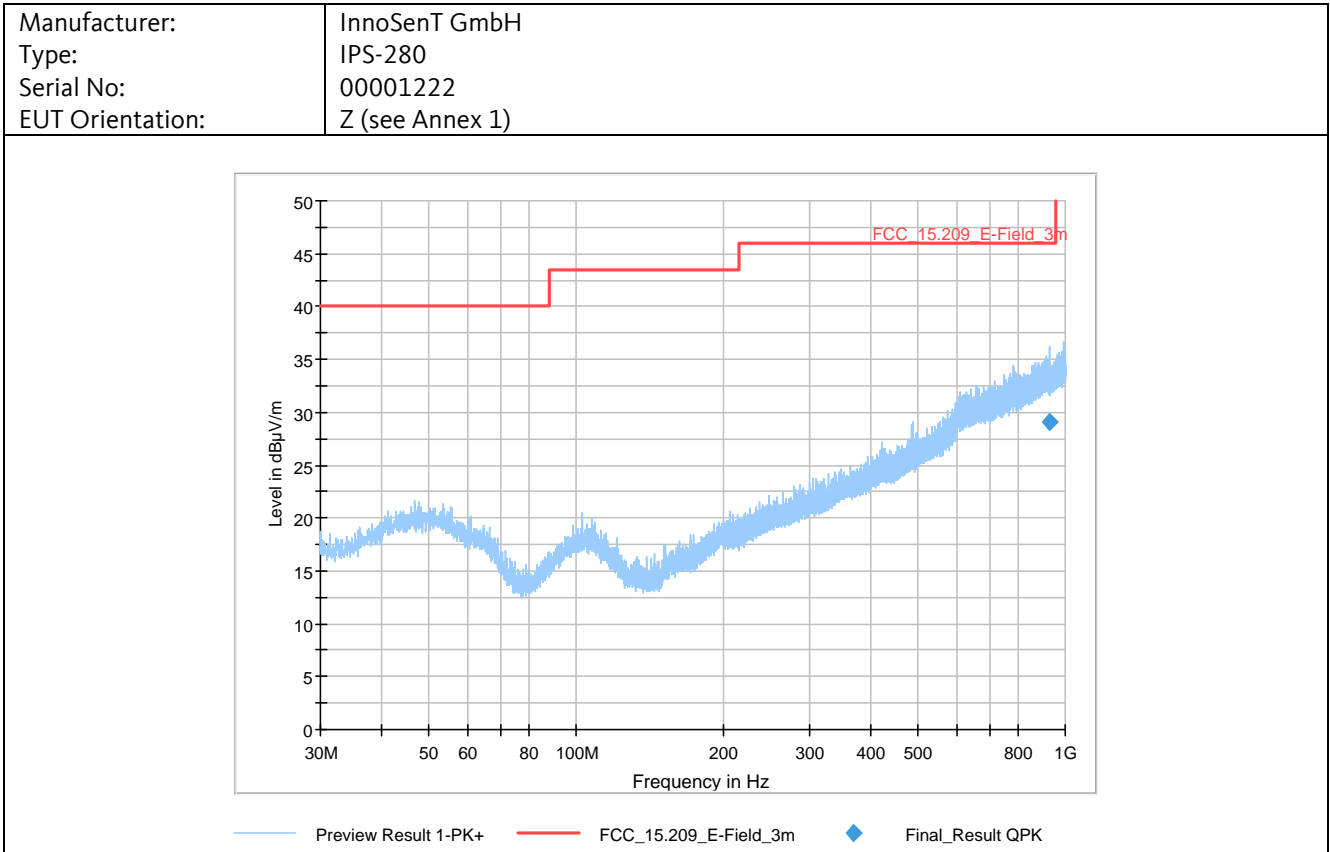

Final Result:

| Frequency MHz | QuasiPeak dBµV/m | Limit dBµV/m | Margin dB | Meas. Time ms | Bandwidth Hz | Height cm | Pol -- | Azimuth deg | Corr. dB/m |
|------------------|---------------------|-----------------|--------------|------------------|-----------------|--------------|-----------|----------------|---------------|
| 37.6 | 14.3 | 40.0 | 25.8 | 1000 | 120 | 315 | H | 105 | 18.0 |
| 917.9 | 29.2 | 46.0 | 16.8 | 1000 | 120 | 363 | H | 80 | 29.9 |
| 926.8 | 29.1 | 46.0 | 16.9 | 1000 | 120 | 100 | V | -78 | 30.0 |

All tests performed at the distance denoted in chapter 4.4.5.1. The limit was adjusted to correspond with the test distance.
The table above contains worst-case emissions, only. For further details refer to the pre-scan test plot above.

4.4.5.4 Test Result

Manufacturer: InnoSenT GmbH
 Type: IPS-280
 Serial No.: 00001222
 Test date: 2018-12-17/18
 Test personnel: Patrick Reusch

The EUT meets the requirements of this section.

4.4.6 Radiated Emissions 1 – 6 GHz

4.4.6.1 Test Procedures

ANSI C63.10-2013, 6.6.4.1 General

Subclauses 6.6.4.2 and 6.6.4.3 describe the procedures that shall be used for making exploratory and final radiated emission tests for frequencies above 1 GHz. Measurements may be performed at a distance closer than that specified in the requirements; however, an attempt shall be made to avoid making measurements in the near field of both the measurement antenna and the EUT for final measurements.

In performing these measurements, the sensitivity of the complete measurement system relative to the limit shall be determined before the test. If the overall measurement sensitivity does not provide a noise floor more than 6 dB below the limit, then low-noise preamplifiers, closer test distances, higher gain antennas, or narrower bandwidths might be required. If closer measurement distances are used, then the beamwidth of the measurement antenna versus the size of the EUT shall be taken into account. Also, measurement system overload protection shall be determined to be adequate when preamplifiers are used [see item b) of 4.1.3]. The effects of using bandwidths different from those specified shall also be determined (see also 6.3). Any changes from the specific measurement conditions shall be described in the report of the measurements (see also Annex E).

Install an appropriate filter at the input of the measurement system power amplifier. This filter shall attenuate the fundamental emission of the EUT and allow an accurate measurement of the associated harmonics and spurious emissions. The filter shall be characterized, and any attenuation/loss factors shall be accounted for in the measurement results.

Data shall be recorded in peak and average detection up to the highest measurement frequency required (unless stated otherwise in the applicable requirements).

ANSI C63.10-2013, 6.6.4.2 Exploratory radiated emissions measurements

Exploratory radiated measurements shall be performed at the measurement distance or at a closer distance than that specified for compliance to determine the emission characteristics of the EUT and, if applicable, the EUT configuration that produces the maximum level of emissions. The frequencies of maximum emission may be determined by manually positioning the antenna close to the EUT, and then moving the antenna over all sides of the EUT while observing a spectral display. It is advantageous to have prior knowledge of the frequencies of emissions, although this may be determined from such a near-field scan. The near-field scan shall only be used to determine the frequency but not the amplitude of the emissions. Where exploratory measurements are not adequate to determine the worst-case operating modes and are used only to identify the frequencies of the highest emissions, additional preliminary tests can be required.

Preliminary tests shall be performed following the procedures in 6.3 on a site meeting the requirements of 5.2. For emissions from the EUT, the maximum level shall be determined by rotating the EUT and its antenna through 0° to 360°. For each mode of operation required to be tested, the frequency spectrum (based on findings from exploratory measurements) shall be monitored.

Broadband antennas and a spectrum analyzer or a radio-noise meter with a panoramic display are often useful in this type of test. If either antenna height or EUT azimuth are not fully measured during exploratory testing, then complete testing can be required at the OATS or semi-anechoic chamber when the final full spectrum testing is performed.

ANSI C63.10.2013, 6.6.4.3 Final radiated emissions measurements

The final measurements are performed on a site meeting the requirements of 5.2. Using the orientation and equipment arrangement of the EUT based on the measurement results found during the preliminary (exploratory) measurements per 6.6.4.2, the EUT arrangement, appropriate modulation, and modes of operation that produce the emissions that have the highest amplitude relative to the limit shall be selected for the final measurement. The final measurement shall follow all the procedures in 6.3 with the EUT operating on frequencies per 5.6. For each mode selected, record the frequency and amplitude of the highest fundamental emission (if applicable), as well as the frequency and amplitude of the six highest spurious emissions relative to the limit. Emissions more than 20 dB below the limit do not need to be reported.

Measurements are performed with the EUT rotated from 0° to 360°; the antenna height scanned in accordance with 6.6.3.1, 6.6.3.2, or 6.6.3.3, as appropriate; and the antenna rotated to repeat the measurements for both the horizontal and vertical antenna polarizations. Variations in cable or wire placement shall be explored to maximize the measured emissions.

Test on InnoSenT GmbH IPS-280 to 47 CFR § 15.245

The emission signal shall be kept within the illumination area of the 3 dB beamwidth of the antenna so that the maximum emission from the EUT is measured. This may be achieved by either pointing the antenna at an angle toward the source of the emission or by testing the EUT as described in 6.6.3.3.

If the emission is pulsed, then refer to Annex C for guidelines on selecting bandwidth and determining pulse desensitization factors, as necessary.

As noted in 6.6.4.1, when performing these measurements, the sensitivity of the complete measurement system relative to the limit shall be determined before the test. If the overall measurement sensitivity is inadequate, then low-noise preamplifiers, closer measurement distances, higher gain antennas, or narrower bandwidths may be used. If closer measurement distances or higher gain antennas are used, then the beamwidth of the measurement antenna versus the physical size of the EUT shall be taken into account, so that the physical sizes of the EUT dimensions are encompassed by the beamwidth of the measurement antenna. Also, measurement system overload protection shall be determined to be adequate when preamplifiers are used. The effects on the measured emission value using bandwidths different from those specified shall be determined if such bandwidth changes are made. Any changes from the specific measurement conditions shall be described in the report of the measurements.

Unless specified otherwise by the regulatory authority, the instrumentation, detector functions, and bandwidths specified in 4.1.4.2.1 and 4.1.4.2.2 shall be used. For pulsed emissions, the procedure in 4.1.4.2.4 shall be used.

| Radiated Emissions Test Characteristics | |
|--|---|
| Frequency range | 1 GHz – 6 GHz |
| Test distance | 3 m |
| Test instrumentation resolution bandwidth | 1 MHz |
| Receive antenna height | 1 m – 4 m |
| Receive antenna polarization | Vertical/Horizontal |
| Measurement chamber | Semi anechoic chamber (SAC) with rf absorbers on the floor |

Test on InnoSenT GmbH IPS-280 to 47 CFR § 15.245

4.4.6.2 Test Setup

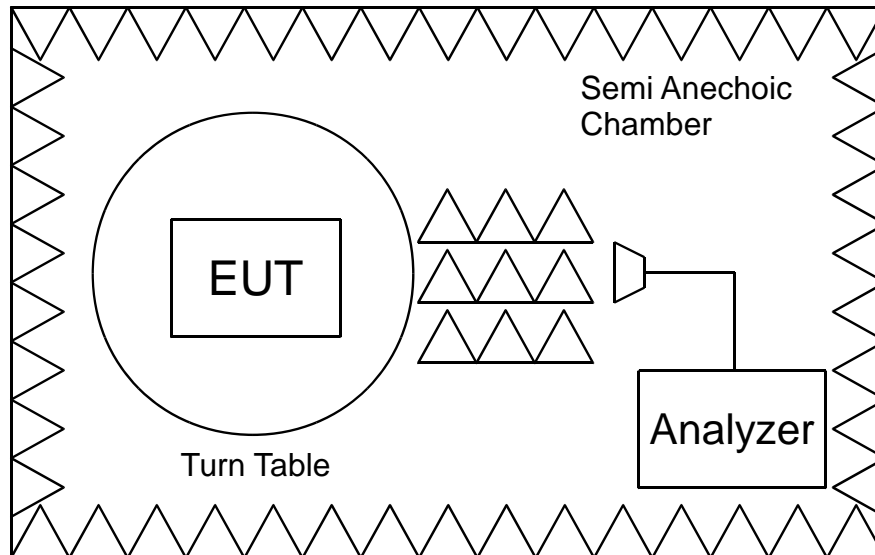

SCHEMATIC TEST SETUP

Requirement: 47 CFR, § 15.209
Procedure: ANSI C63.10-2013

Receiver: #516
Antenna: #3235

Test distance: 3 m

TEST EQUIPMENT USED:
Refer to chapter 5 of this document.
516, 1889, 3235, 4075, 4717, 4721,
5392, 5535, 5536, 5544, 5545, 5615

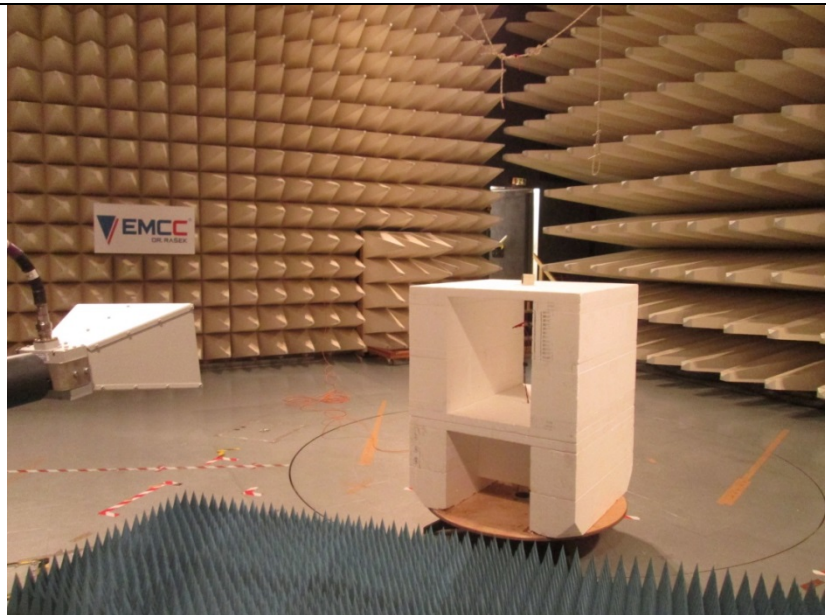

Sample photo of setup

Test on InnoSenT GmbH IPS-280 to 47 CFR § 15.245

4.4.6.3 Detailed Test Data

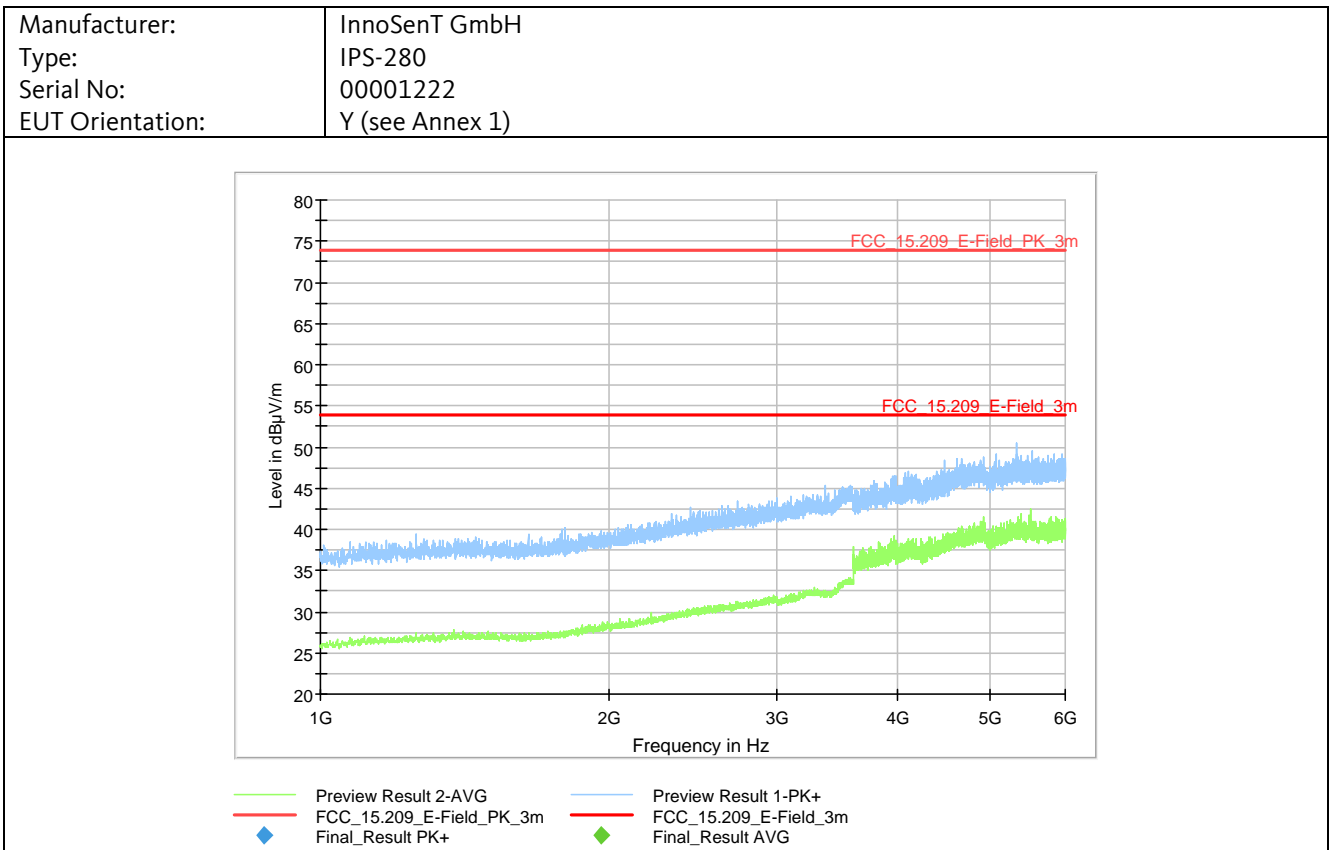
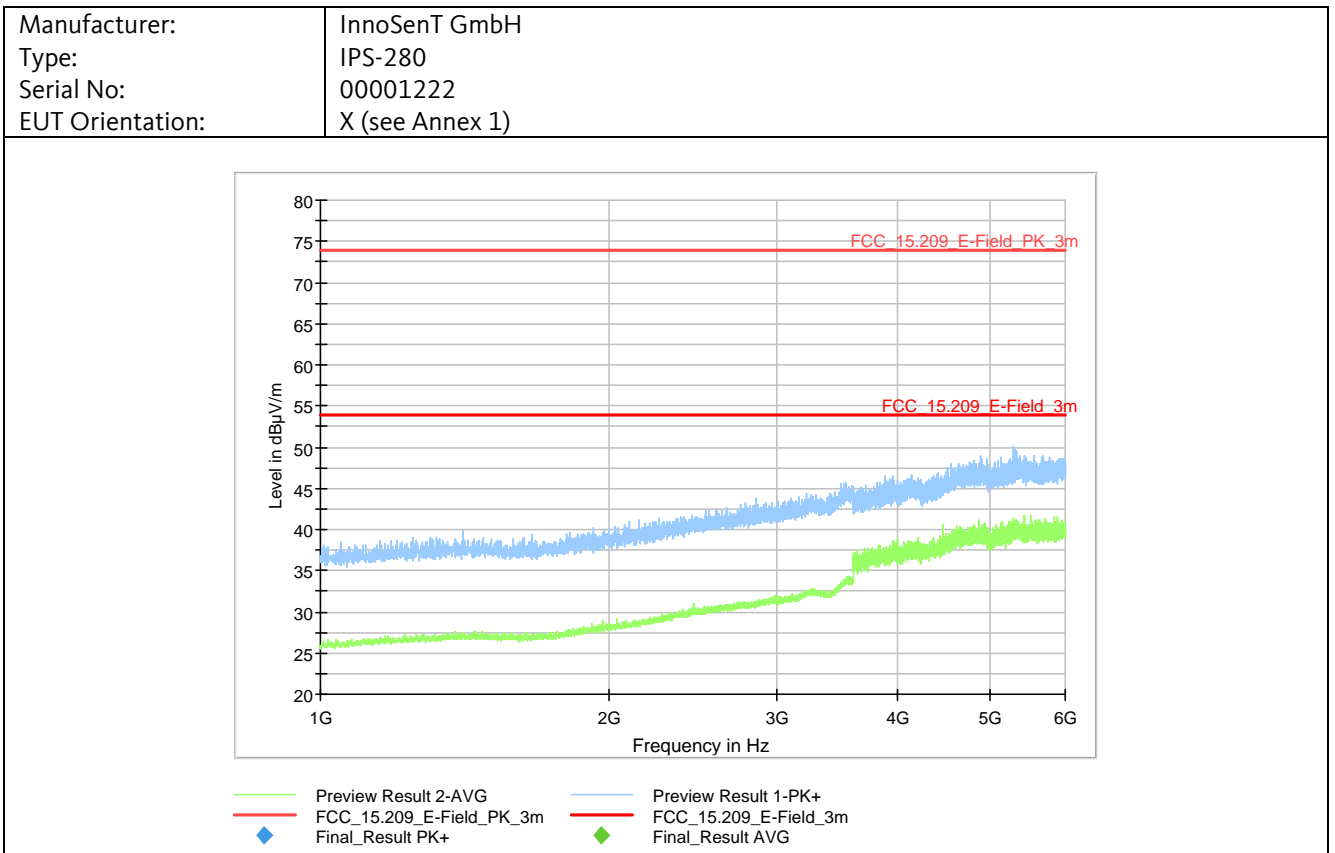

Test on InnoSenT GmbH IPS-280 to 47 CFR § 15.245

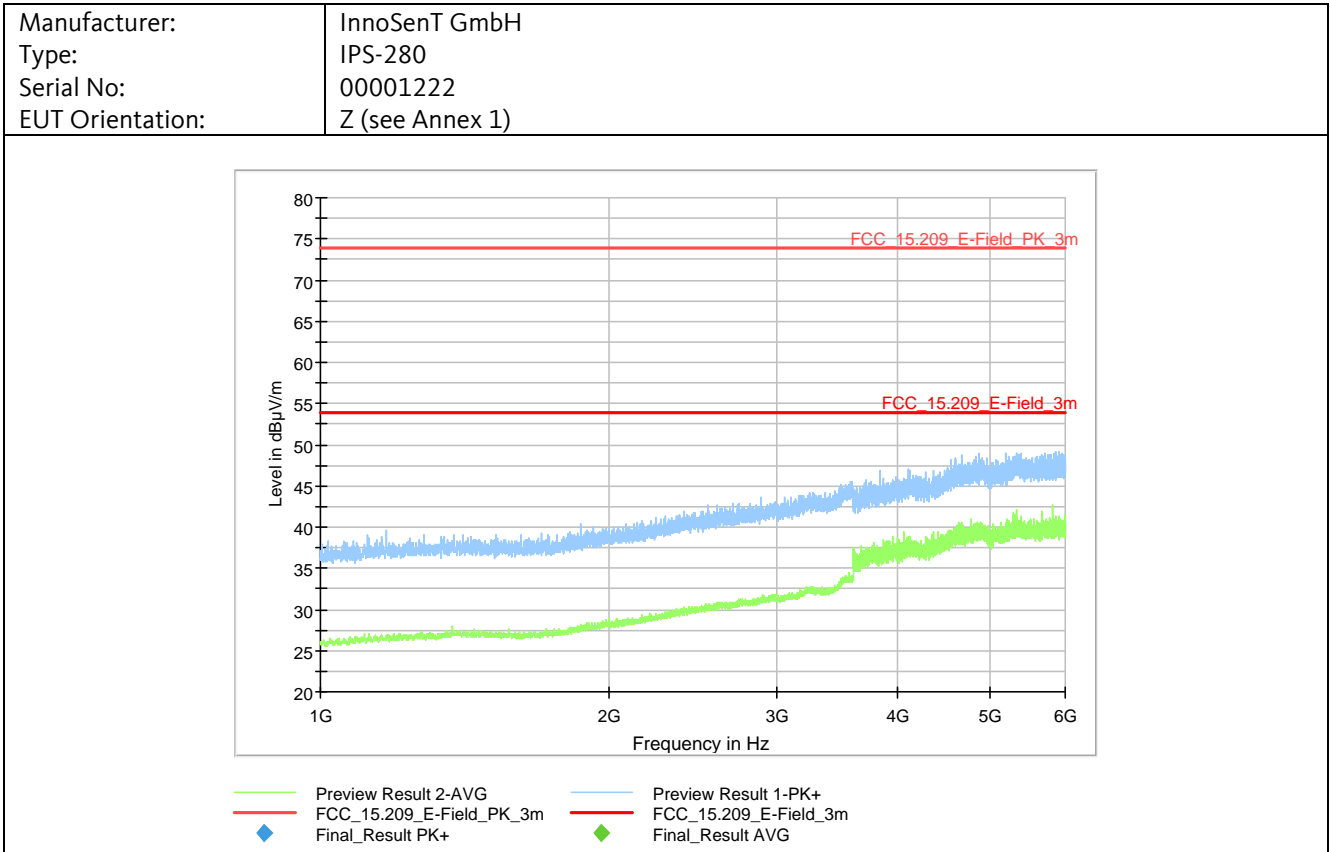

Final Result:

| Frequency MHz | MaxPeak dBµV/m | Average dBµV/m | Limit dBµV/m | Margin dB | Meas. Time ms | Bandwidth kHz | Height cm | Pol -- | Azimuth deg | Corr. dB/m |
|--|-------------------|-------------------|-----------------|--------------|------------------|------------------|--------------|-----------|----------------|---------------|
| <div style="border: 1px solid black; padding: 5px; margin: auto; width: 80%;"> <p>All peak emissions were below the average limit. Therefore, no final measurement performed.</p> </div> | | | | | | | | | | |

All tests performed at the distance denoted in chapter 4.4.6.1. The limit was adjusted to correspond with the test distance. The table above contains worst-case emissions, only. For further details refer to the pre-scan test plot above.

4.4.6.4 Test Result

Manufacturer: InnoSenT GmbH
 Type: IPS-280
 Serial No.: 00001222
 Test date: 2018-12-19
 Test personnel: Patrick Reusch

The EUT meets the requirements of this section.

4.4.7 Radiated Emissions 6 – 18 GHz

4.4.7.1 Test Procedures

ANSI C63.10-2013, 6.6.4.1 General

Subclauses 6.6.4.2 and 6.6.4.3 describe the procedures that shall be used for making exploratory and final radiated emission tests for frequencies above 1 GHz. Measurements may be performed at a distance closer than that specified in the requirements; however, an attempt shall be made to avoid making measurements in the near field of both the measurement antenna and the EUT for final measurements.

In performing these measurements, the sensitivity of the complete measurement system relative to the limit shall be determined before the test. If the overall measurement sensitivity does not provide a noise floor more than 6 dB below the limit, then low-noise preamplifiers, closer test distances, higher gain antennas, or narrower bandwidths might be required. If closer measurement distances are used, then the beamwidth of the measurement antenna versus the size of the EUT shall be taken into account. Also, measurement system overload protection shall be determined to be adequate when preamplifiers are used [see item b) of 4.1.3]. The effects of using bandwidths different from those specified shall also be determined (see also 6.3). Any changes from the specific measurement conditions shall be described in the report of the measurements (see also Annex E).

Install an appropriate filter at the input of the measurement system power amplifier. This filter shall attenuate the fundamental emission of the EUT and allow an accurate measurement of the associated harmonics and spurious emissions. The filter shall be characterized, and any attenuation/loss factors shall be accounted for in the measurement results.

Data shall be recorded in peak and average detection upto the highest measurement frequency required (unless stated otherwise in the applicable requirements).

ANSI C63.10-2013, 6.6.4.2 Exploratory radiated emissions measurements

Exploratory radiated measurements shall be performed at the measurement distance or at a closer distance than that specified for compliance to determine the emission characteristics of the EUT and, if applicable, the EUT configuration that produces the maximum level of emissions. The frequencies of maximum emission may be determined by manually positioning the antenna close to the EUT, and then moving the antenna over all sides of the EUT while observing a spectral display. It is advantageous to have prior knowledge of the frequencies of emissions, although this may be determined from such a near-field scan. The near-field scan shall only be used to determine the frequency but not the amplitude of the emissions. Where exploratory measurements are not adequate to determine the worst-case operating modes and are used only to identify the frequencies of the highest emissions, additional preliminary tests can be required.

Preliminary tests shall be performed following the procedures in 6.3 on a site meeting the requirements of 5.2. For emissions from the EUT, the maximum level shall be determined by rotating the EUT and its antenna through 0° to 360°. For each mode of operation required to be tested, the frequency spectrum (based on findings from exploratory measurements) shall be monitored.

Broadband antennas and a spectrum analyzer or a radio-noise meter with a panoramic display are often useful in this type of test. If either antenna height or EUT azimuth are not fully measured during exploratory testing, then complete testing can be required at the OATS or semi-anechoic chamber when the final full spectrum testing is performed.

ANSI C63.10.2013, 6.6.4.3 Final radiated emissions measurements

The final measurements are performed on a site meeting the requirements of 5.2. Using the orientation and equipment arrangement of the EUT based on the measurement results found during the preliminary (exploratory) measurements per 6.6.4.2, the EUT arrangement, appropriate modulation, and modes of operation that produce the emissions that have the highest amplitude relative to the limit shall be selected for the final measurement. The final measurement shall follow all the procedures in 6.3 with the EUT operating on frequencies per 5.6. For each mode selected, record the frequency and amplitude of the highest fundamental emission (if applicable), as well as the frequency and amplitude of the six highest spurious emissions relative to the limit. Emissions more than 20 dB below the limit do not need to be reported.

Measurements are performed with the EUT rotated from 0° to 360°; the antenna height scanned in accordance with 6.6.3.1, 6.6.3.2, or 6.6.3.3, as appropriate; and the antenna rotated to repeat the measurements for both the horizontal and vertical antenna polarizations. Variations in cable or wire placement shall be explored to maximize the measured emissions.

Test on InnoSenT GmbH IPS-280 to 47 CFR § 15.245

The emission signal shall be kept within the illumination area of the 3 dB beamwidth of the antenna so that the maximum emission from the EUT is measured. This may be achieved by either pointing the antenna at an angle toward the source of the emission or by testing the EUT as described in 6.6.3.3.

If the emission is pulsed, then refer to Annex C for guidelines on selecting bandwidth and determining pulse desensitization factors, as necessary.

As noted in 6.6.4.1, when performing these measurements, the sensitivity of the complete measurement system relative to the limit shall be determined before the test. If the overall measurement sensitivity is inadequate, then low-noise preamplifiers, closer measurement distances, higher gain antennas, or narrower bandwidths may be used. If closer measurement distances or higher gain antennas are used, then the beamwidth of the measurement antenna versus the physical size of the EUT shall be taken into account, so that the physical sizes of the EUT dimensions are encompassed by the beamwidth of the measurement antenna. Also, measurement system overload protection shall be determined to be adequate when preamplifiers are used. The effects on the measured emission value using bandwidths different from those specified shall be determined if such bandwidth changes are made. Any changes from the specific measurement conditions shall be described in the report of the measurements.

Unless specified otherwise by the regulatory authority, the instrumentation, detector functions, and bandwidths specified in 4.1.4.2.1 and 4.1.4.2.2 shall be used. For pulsed emissions, the procedure in 4.1.4.2.4 shall be used.

| Radiated Emissions Test Characteristics | |
|--|---|
| Frequency range | 6 GHz – 18 GHz |
| Test distance | 1 m |
| Test instrumentation resolution bandwidth | 1 MHz |
| Receive antenna height | 1.5 m |
| Receive antenna polarization | Vertical/Horizontal |
| Measurement chamber | Semi anechoic chamber (SAC) with rf absorbers on the floor |

Test on InnoSenT GmbH IPS-280 to 47 CFR § 15.245

4.4.7.2 Test Setup

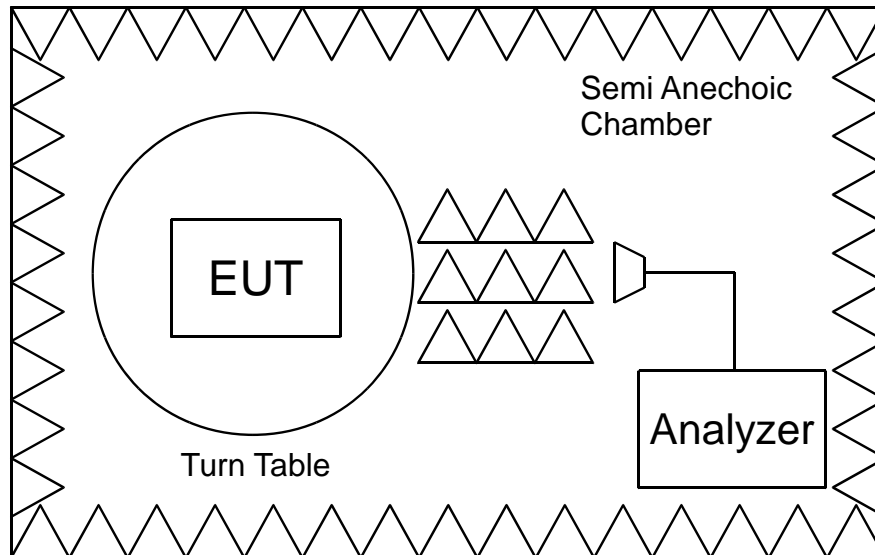

SCHEMATIC TEST SETUP

Requirement: 47 CFR, § 15.209
Procedure: ANSI C63.10-2013

Receiver: #516
Antenna: #3235

Test distance: 1 m

TEST EQUIPMENT USED:
Refer to chapter 5 of this document.
516, 1889, 3235, 4075, 4717, 4721,
5392, 5535, 5536, 5544, 5545, 5615

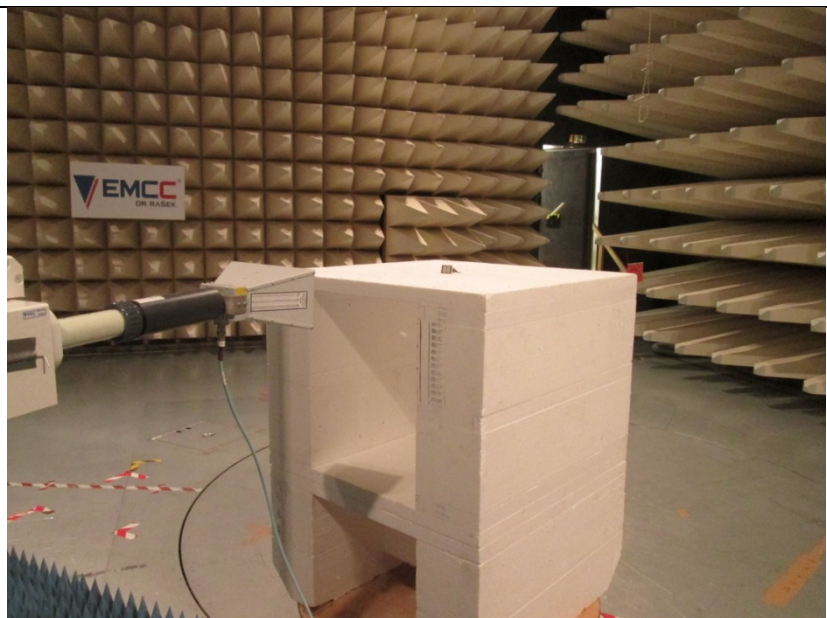

Sample photo of setup showing a different EUT (IPS-354)

Test on InnoSenT GmbH IPS-280 to 47 CFR § 15.245

4.4.7.3 Detailed Test Data

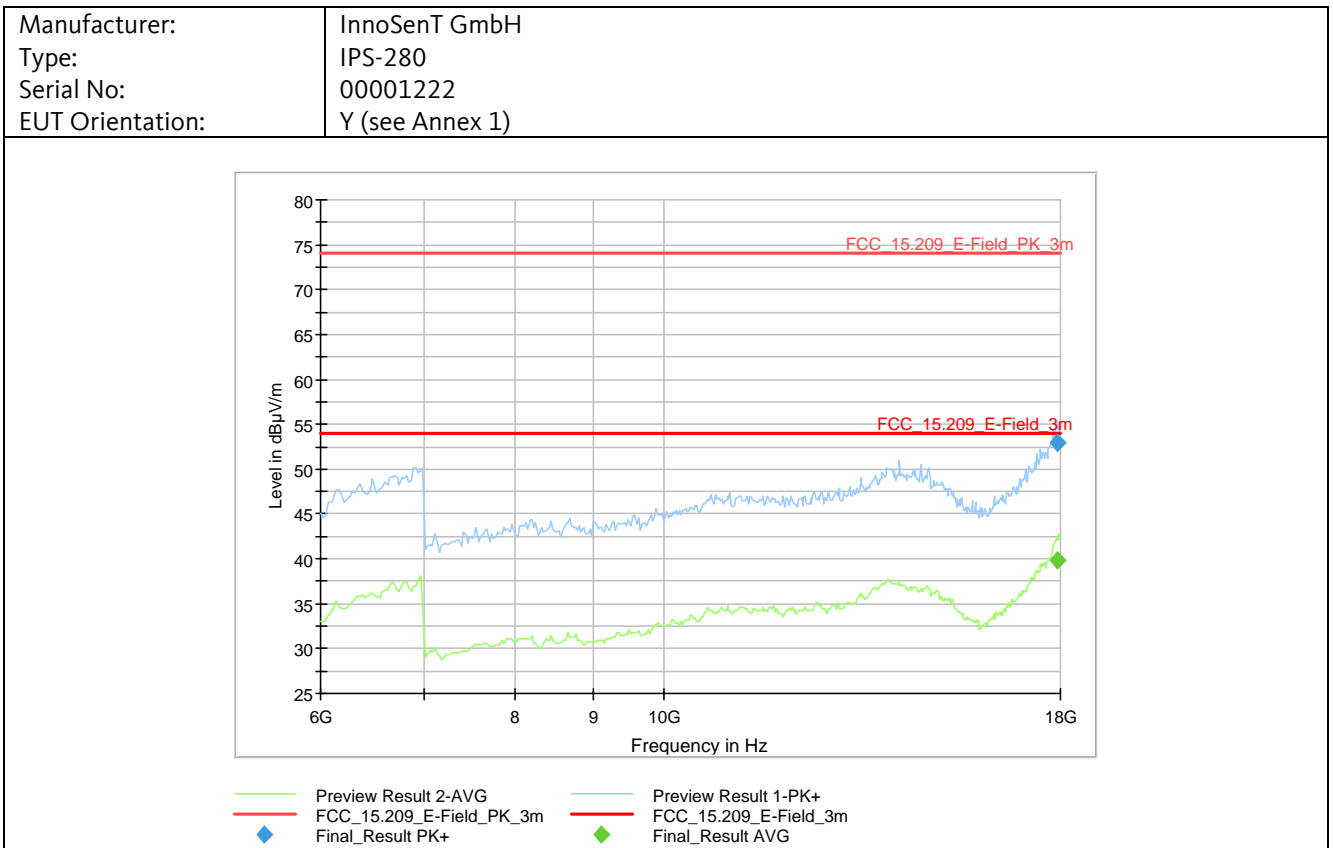
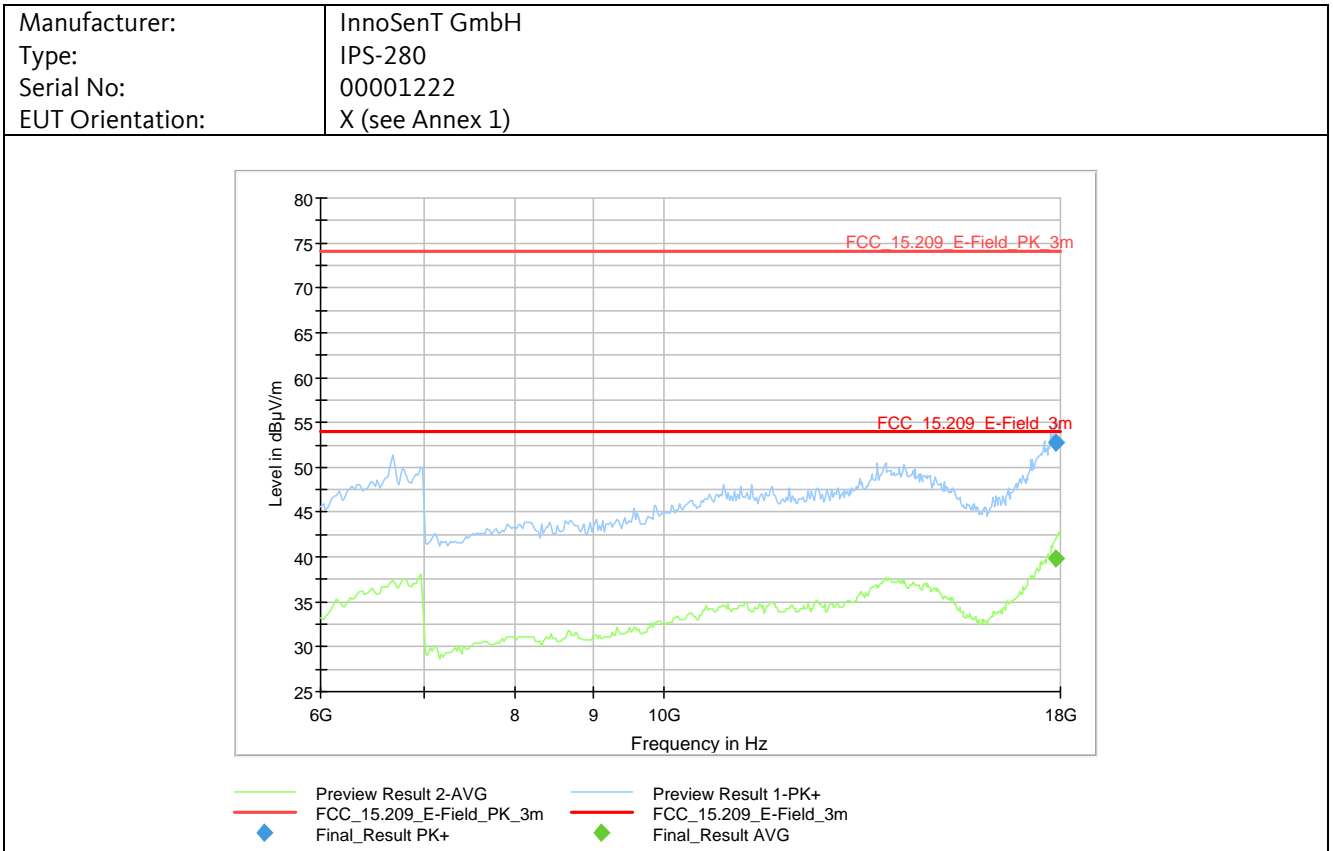

Test on InnoSenT GmbH IPS-280 to 47 CFR § 15.245

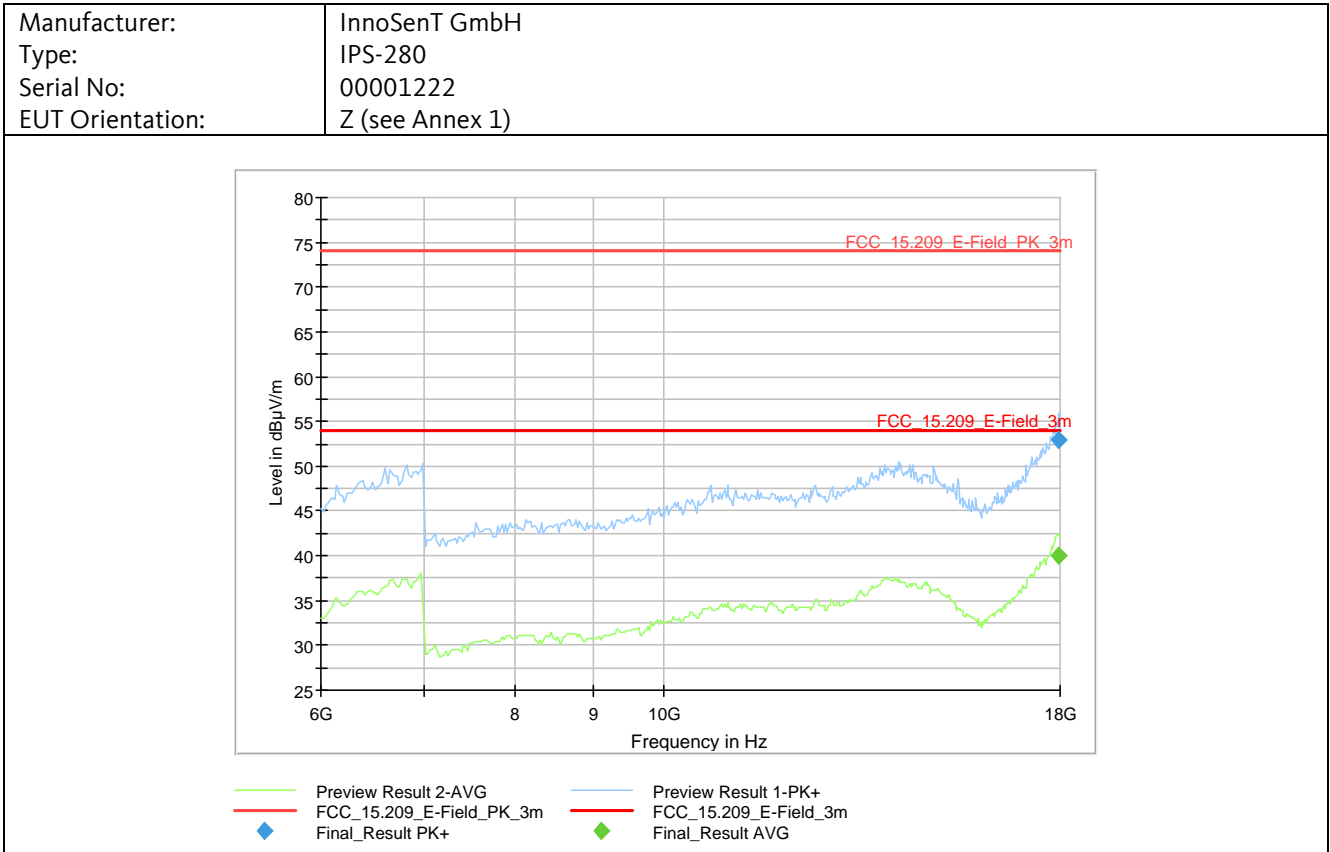

Final Result:

| Frequency MHz | MaxPeak dBµV/m | Average dBµV/m | Limit dBµV/m | Margin dB | Meas. Time ms | Bandwidth kHz | Height cm | Pol -- | Azimuth deg | Corr. dB/m |
|------------------|-------------------|-------------------|-----------------|--------------|------------------|------------------|--------------|-----------|----------------|---------------|
| 17854.6 | --- | 39.8 | 54.0 | 14.2 | 100 | 1000 | 168 | V | 272 | 39.1 |
| 17854.6 | 52.8 | --- | 74.0 | 21.2 | 100 | 1000 | 168 | V | 272 | 39.1 |
| 17929.2 | --- | 39.9 | 54.0 | 14.1 | 100 | 1000 | 245 | V | 199 | 39.6 |
| 17929.2 | 53.0 | --- | 74.0 | 21.0 | 100 | 1000 | 245 | V | 199 | 39.6 |
| 17977.8 | --- | 40.0 | 54.0 | 14.0 | 100 | 1000 | 194 | V | 11 | 39.9 |
| 17977.8 | 52.9 | --- | 74.0 | 21.1 | 100 | 1000 | 194 | V | 11 | 39.9 |

All tests performed at the distance denoted in chapter 4.4.7.1. The limit was adjusted to correspond with the test distance.
The table above contains worst-case emissions, only. For further details refer to the pre-scan test plot above.

4.4.7.4 Test Result

Manufacturer: InnoSenT GmbH
Type: IPS-280
Serial No.: 00001222
Test date: 2018-12-19
Test personnel: Patrick Reusch

The EUT meets the requirements of this section.

4.4.8 Radiated Emissions 18 – 50 GHz

4.4.8.1 Test Procedures

ANSI C63.10-2013, 6.6.4.1 General

Subclauses 6.6.4.2 and 6.6.4.3 describe the procedures that shall be used for making exploratory and final radiated emission tests for frequencies above 1 GHz. Measurements may be performed at a distance closer than that specified in the requirements; however, an attempt shall be made to avoid making measurements in the near field of both the measurement antenna and the EUT for final measurements.

In performing these measurements, the sensitivity of the complete measurement system relative to the limit shall be determined before the test. If the overall measurement sensitivity does not provide a noise floor more than 6 dB below the limit, then low-noise preamplifiers, closer test distances, higher gain antennas, or narrower bandwidths might be required. If closer measurement distances are used, then the beamwidth of the measurement antenna versus the size of the EUT shall be taken into account. Also, measurement system overload protection shall be determined to be adequate when preamplifiers are used [see item b) of 4.1.3]. The effects of using bandwidths different from those specified shall also be determined (see also 6.3). Any changes from the specific measurement conditions shall be described in the report of the measurements (see also Annex E).

Install an appropriate filter at the input of the measurement system power amplifier. This filter shall attenuate the fundamental emission of the EUT and allow an accurate measurement of the associated harmonics and spurious emissions. The filter shall be characterized, and any attenuation/loss factors shall be accounted for in the measurement results.

Data shall be recorded in peak and average detection upto the highest measurement frequency required (unless stated otherwise in the applicable requirements).

ANSI C63.10-2013, 6.6.4.2 Exploratory radiated emissions measurements

Exploratory radiated measurements shall be performed at the measurement distance or at a closer distance than that specified for compliance to determine the emission characteristics of the EUT and, if applicable, the EUT configuration that produces the maximum level of emissions. The frequencies of maximum emission may be determined by manually positioning the antenna close to the EUT, and then moving the antenna over all sides of the EUT while observing a spectral display. It is advantageous to have prior knowledge of the frequencies of emissions, although this may be determined from such a near-field scan. The near-field scan shall only be used to determine the frequency but not the amplitude of the emissions. Where exploratory measurements are not adequate to determine the worst-case operating modes and are used only to identify the frequencies of the highest emissions, additional preliminary tests can be required.

Preliminary tests shall be performed following the procedures in 6.3 on a site meeting the requirements of 5.2. For emissions from the EUT, the maximum level shall be determined by rotating the EUT and its antenna through 0° to 360°. For each mode of operation required to be tested, the frequency spectrum (based on findings from exploratory measurements) shall be monitored.

Broadband antennas and a spectrum analyzer or a radio-noise meter with a panoramic display are often useful in this type of test. If either antenna height or EUT azimuth are not fully measured during exploratory testing, then complete testing can be required at the OATS or semi-anechoic chamber when the final full spectrum testing is performed.

ANSI C63.10.2013, 6.6.4.3 Final radiated emissions measurements

The final measurements are performed on a site meeting the requirements of 5.2. Using the orientation and equipment arrangement of the EUT based on the measurement results found during the preliminary (exploratory) measurements per 6.6.4.2, the EUT arrangement, appropriate modulation, and modes of operation that produce the emissions that have the highest amplitude relative to the limit shall be selected for the final measurement. The final measurement shall follow all the procedures in 6.3 with the EUT operating on frequencies per 5.6. For each mode selected, record the frequency and amplitude of the highest fundamental emission (if applicable), as well as the frequency and amplitude of the six highest spurious emissions relative to the limit. Emissions more than 20 dB below the limit do not need to be reported.

Measurements are performed with the EUT rotated from 0° to 360°; the antenna height scanned in accordance with 6.6.3.1, 6.6.3.2, or 6.6.3.3, as appropriate; and the antenna rotated to repeat the measurements for both the horizontal and vertical antenna polarizations. Variations in cable or wire placement shall be explored to maximize the measured emissions.

 Test on InnoSenT GmbH IPS-280 to 47 CFR § 15.245

The emission signal shall be kept within the illumination area of the 3 dB beamwidth of the antenna so that the maximum emission from the EUT is measured. This may be achieved by either pointing the antenna at an angle toward the source of the emission or by testing the EUT as described in 6.6.3.3.

If the emission is pulsed, then refer to Annex C for guidelines on selecting bandwidth and determining pulse desensitization factors, as necessary.

As noted in 6.6.4.1, when performing these measurements, the sensitivity of the complete measurement system relative to the limit shall be determined before the test. If the overall measurement sensitivity is inadequate, then low-noise preamplifiers, closer measurement distances, higher gain antennas, or narrower bandwidths may be used. If closer measurement distances or higher gain antennas are used, then the beamwidth of the measurement antenna versus the physical size of the EUT shall be taken into account, so that the physical sizes of the EUT dimensions are encompassed by the beamwidth of the measurement antenna. Also, measurement system overload protection shall be determined to be adequate when preamplifiers are used. The effects on the measured emission value using bandwidths different from those specified shall be determined if such bandwidth changes are made. Any changes from the specific measurement conditions shall be described in the report of the measurements.

Unless specified otherwise by the regulatory authority, the instrumentation, detector functions, and bandwidths specified in 4.1.4.2.1 and 4.1.4.2.2 shall be used. For pulsed emissions, the procedure in 4.1.4.2.4 shall be used.

| Radiated Emissions Test Characteristics | |
|--|--|
| Frequency range | 18 GHz – 50 GHz |
| Test distance | 1 m (18 – 40 GHz) 0.5 m (40 – 50 GHz) |
| Test instrumentation resolution bandwidth | 1 MHz |
| Receive antenna height | 1.5 m |
| Receive antenna polarization | Vertical/Horizontal |
| Measurement chamber | Fully anechoic chamber (FAC) |

Test on InnoSenT GmbH IPS-280 to 47 CFR § 15.245

4.4.8.2 Test Setup

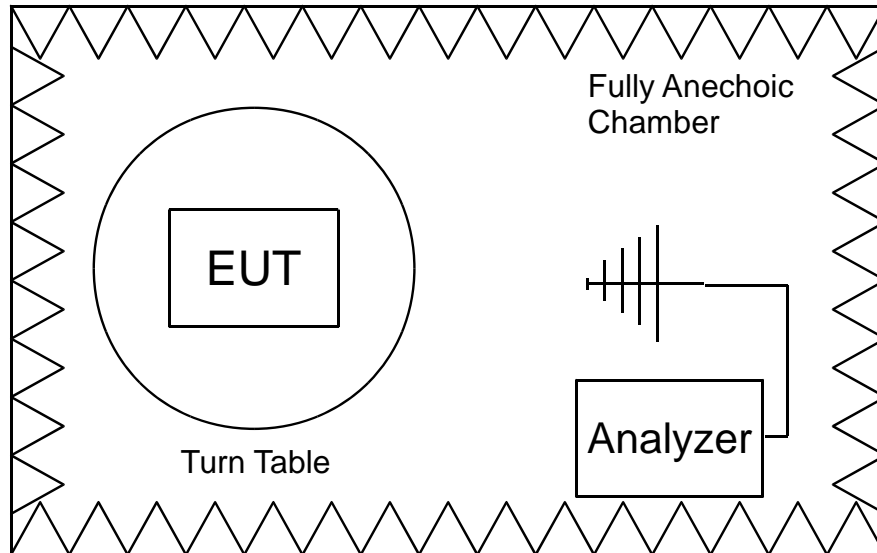

SCHEMATIC TEST SETUP

Requirement: 47 CFR, § 15.209
Procedure: ANSI C63.10-2013

Receiver: #3831
Antenna: #1300 (18 – 26.5 GHz)
 #1229 (26.5 – 40 GHz)
 #2113 (40 – 50 GHz)

Test distance: 1 m (18 – 40 GHz)
 0.5 m (40 – 50 GHz)

TEST EQUIPMENT USED:
Refer to chapter 5 of this document.
1229, 1294, 1300, 1301, 1348, 1868,
2111, 2113, 3831, 3968, 4524, 4717,
4721, 4914, 5392, 5612

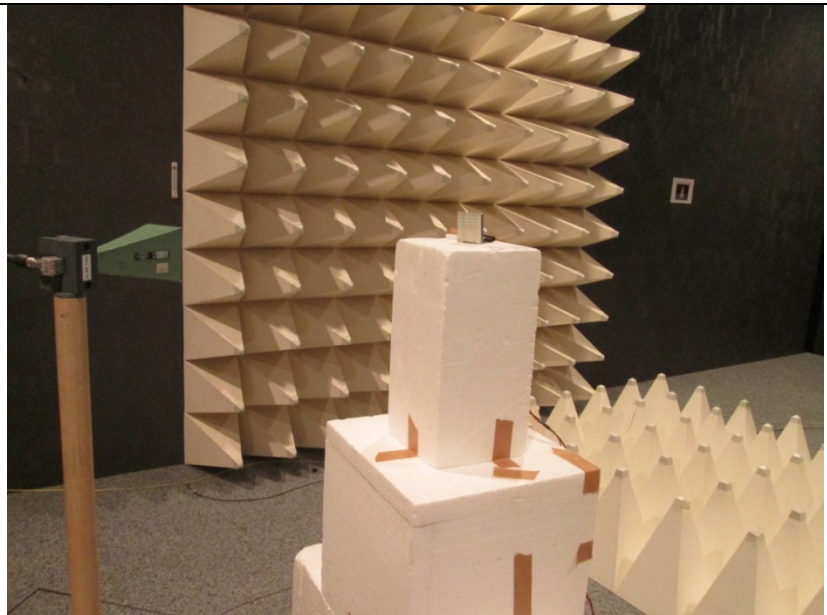

Sample photo of setup

Test on InnoSenT GmbH IPS-280 to 47 CFR § 15.245

4.4.8.3 Detailed Test Data

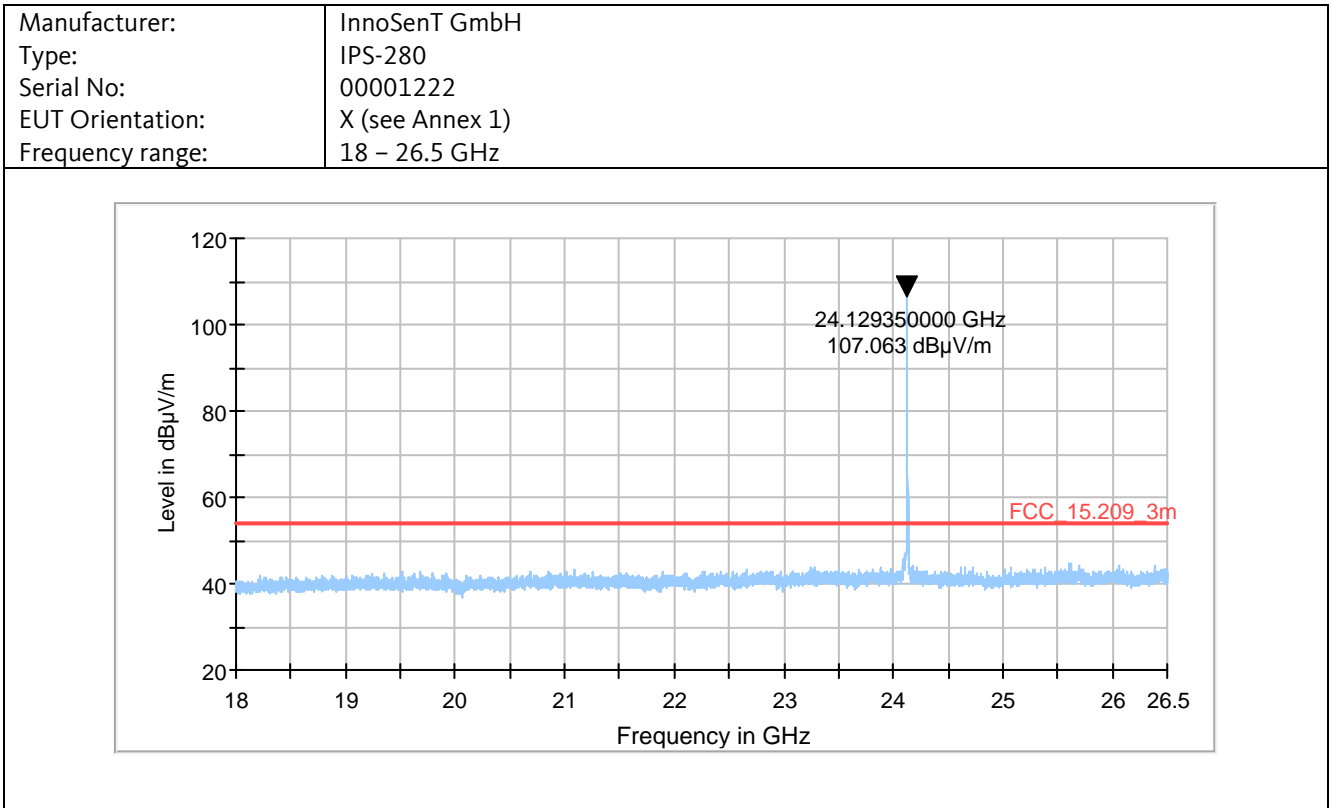

Note: the emission at 24.1 GHz is the carrier frequency. Please refer to the band edge measurements hereafter.

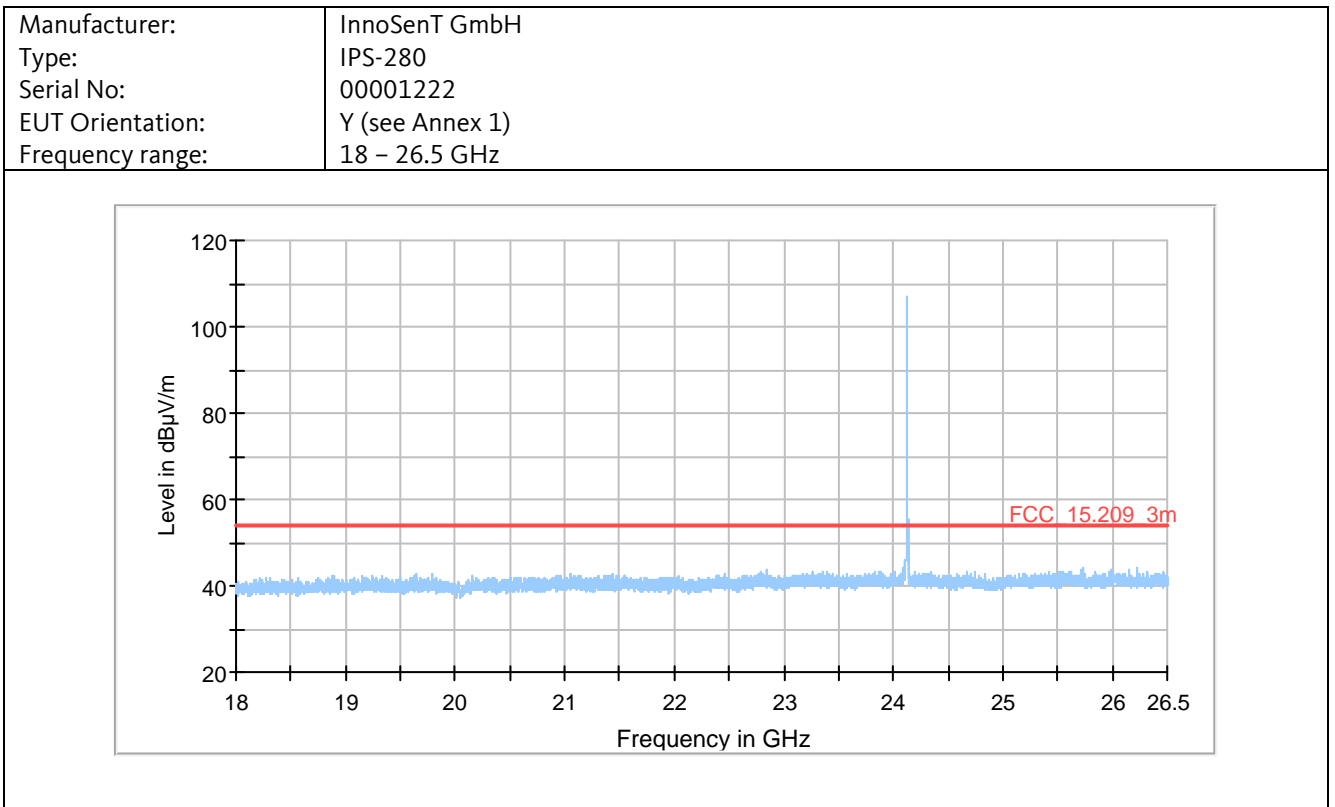

Note: the emission at 24.1 GHz is the carrier frequency. Please refer to the band edge measurements hereafter.

Test on InnoSenT GmbH IPS-280 to 47 CFR § 15.245

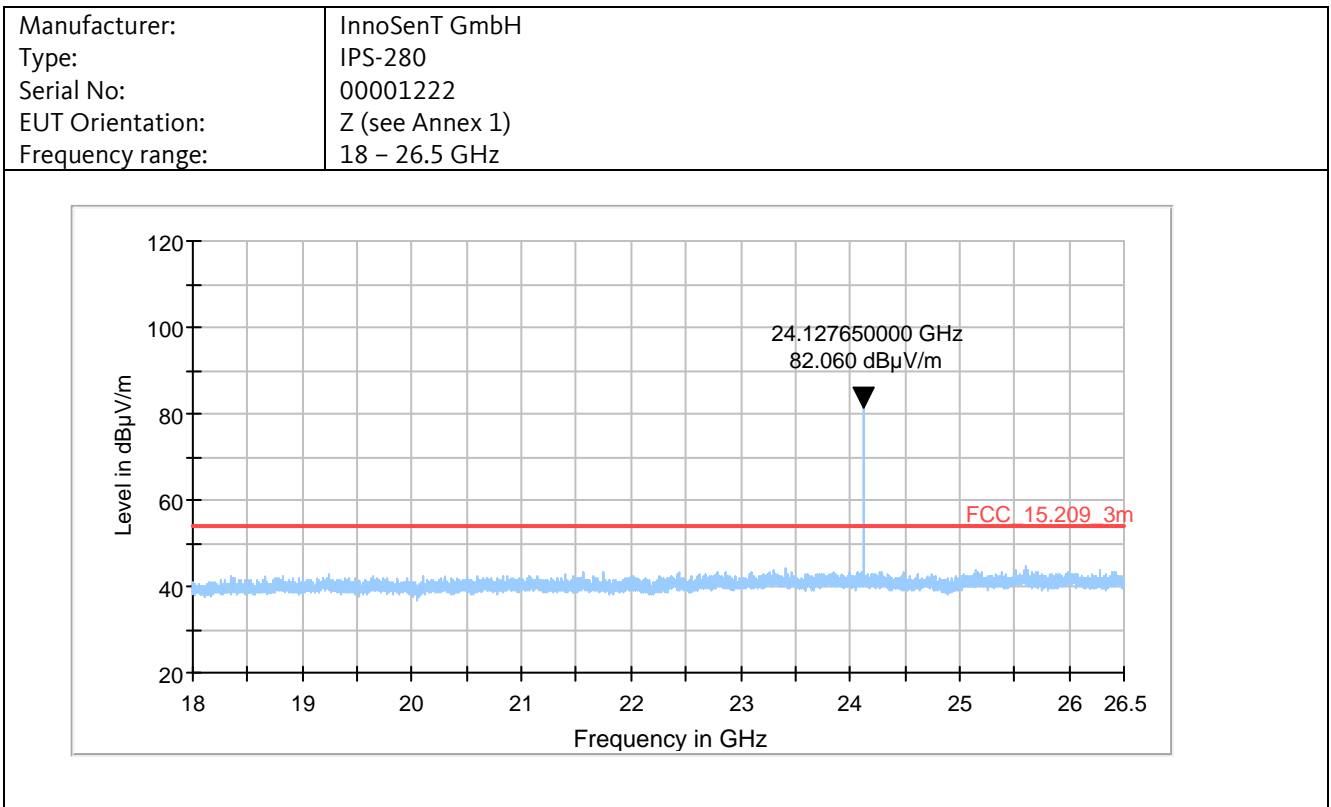

Note: the emission at 24.1 GHz is the carrier frequency. Please refer to the band edge measurements hereafter.

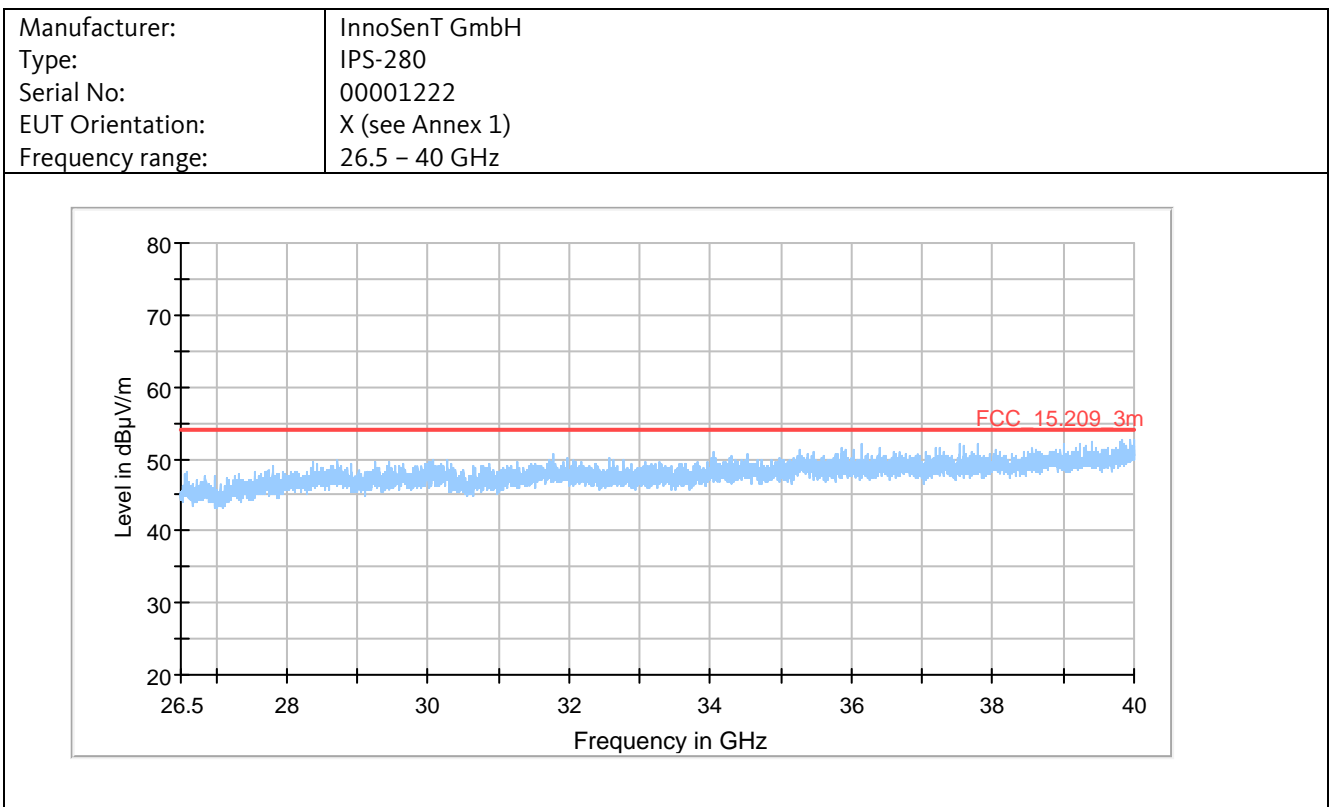

Test on InnoSenT GmbH IPS-280 to 47 CFR § 15.245

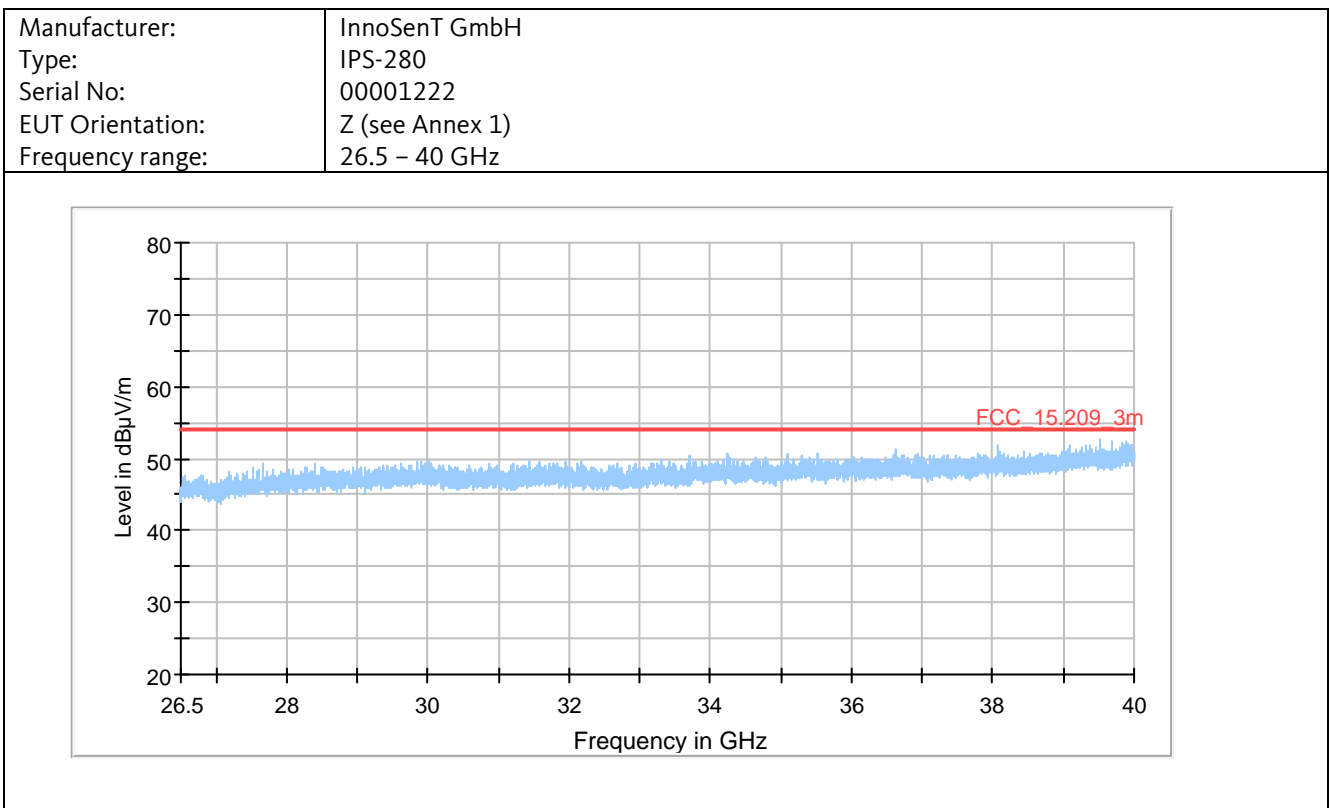
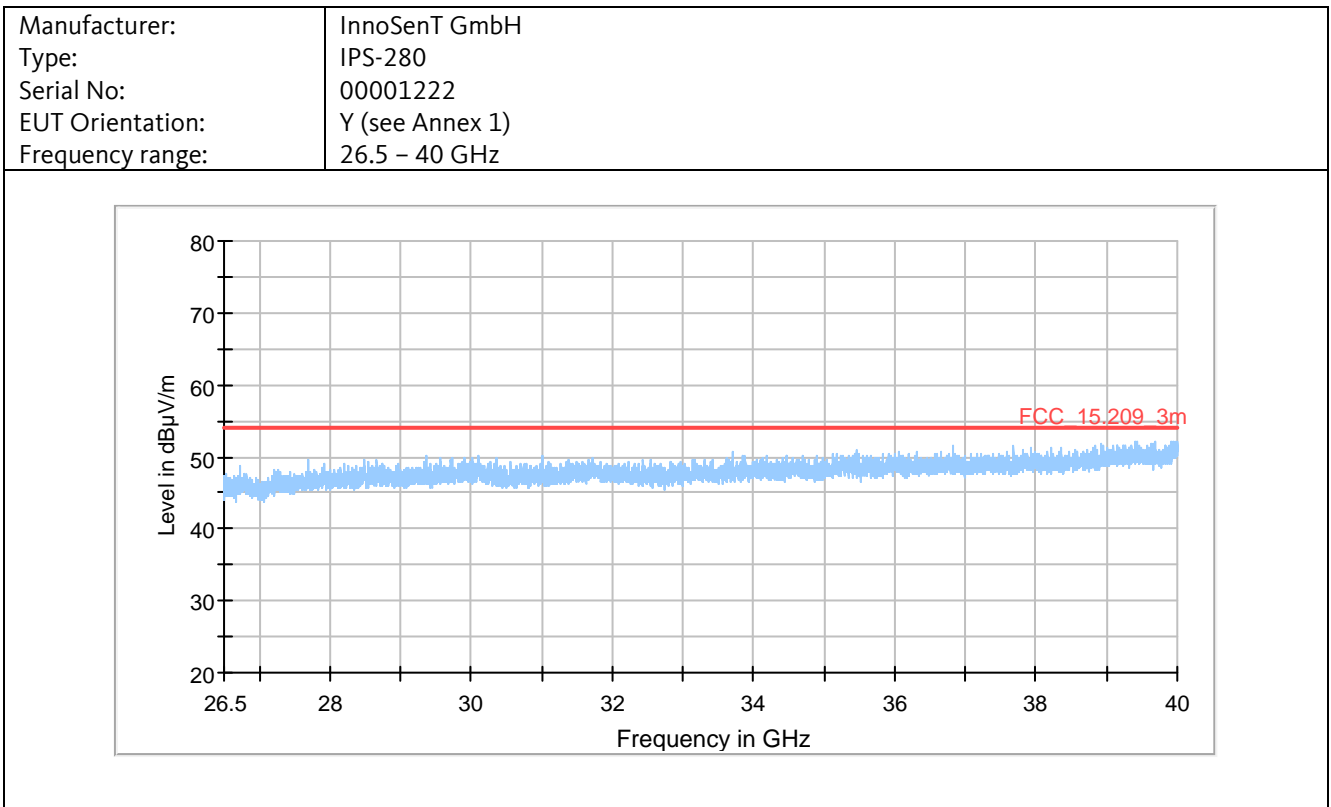

Test on InnoSenT GmbH IPS-280 to 47 CFR § 15.245

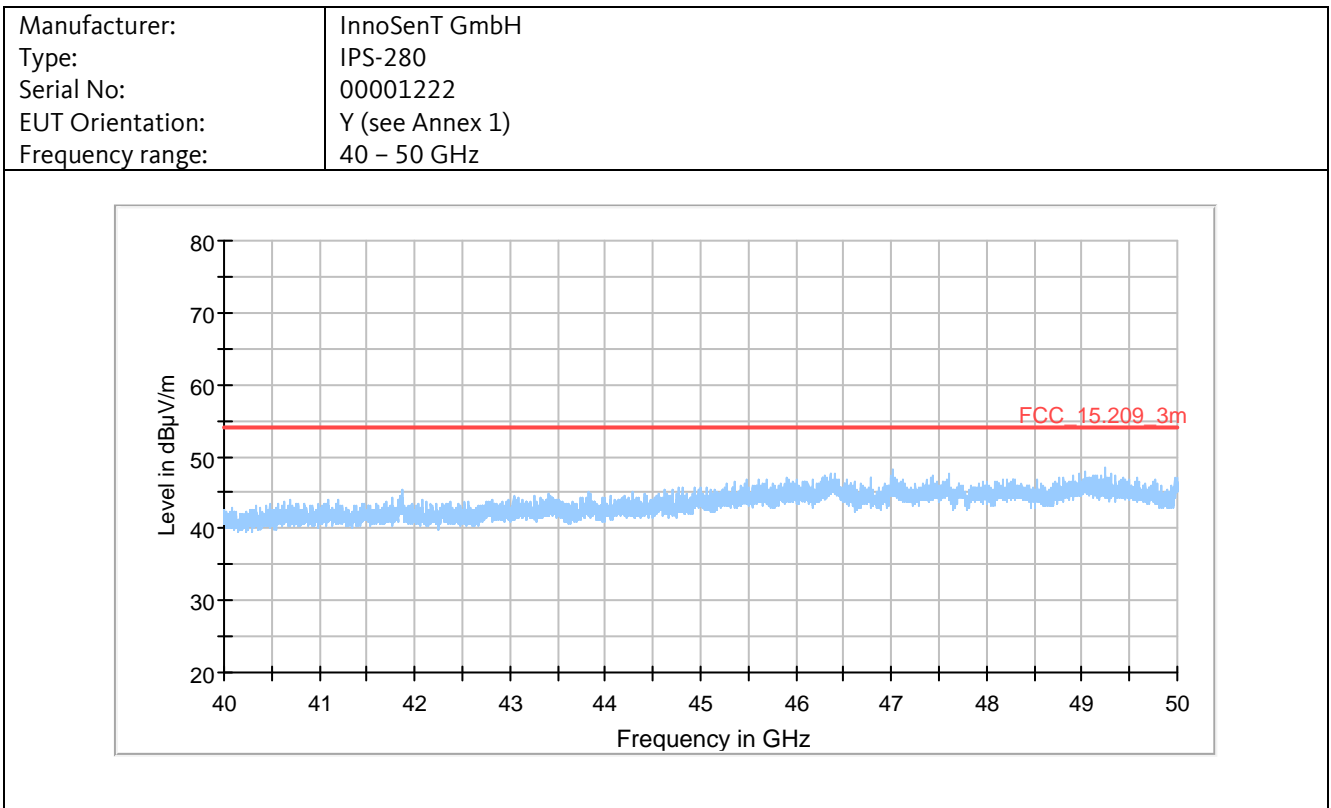
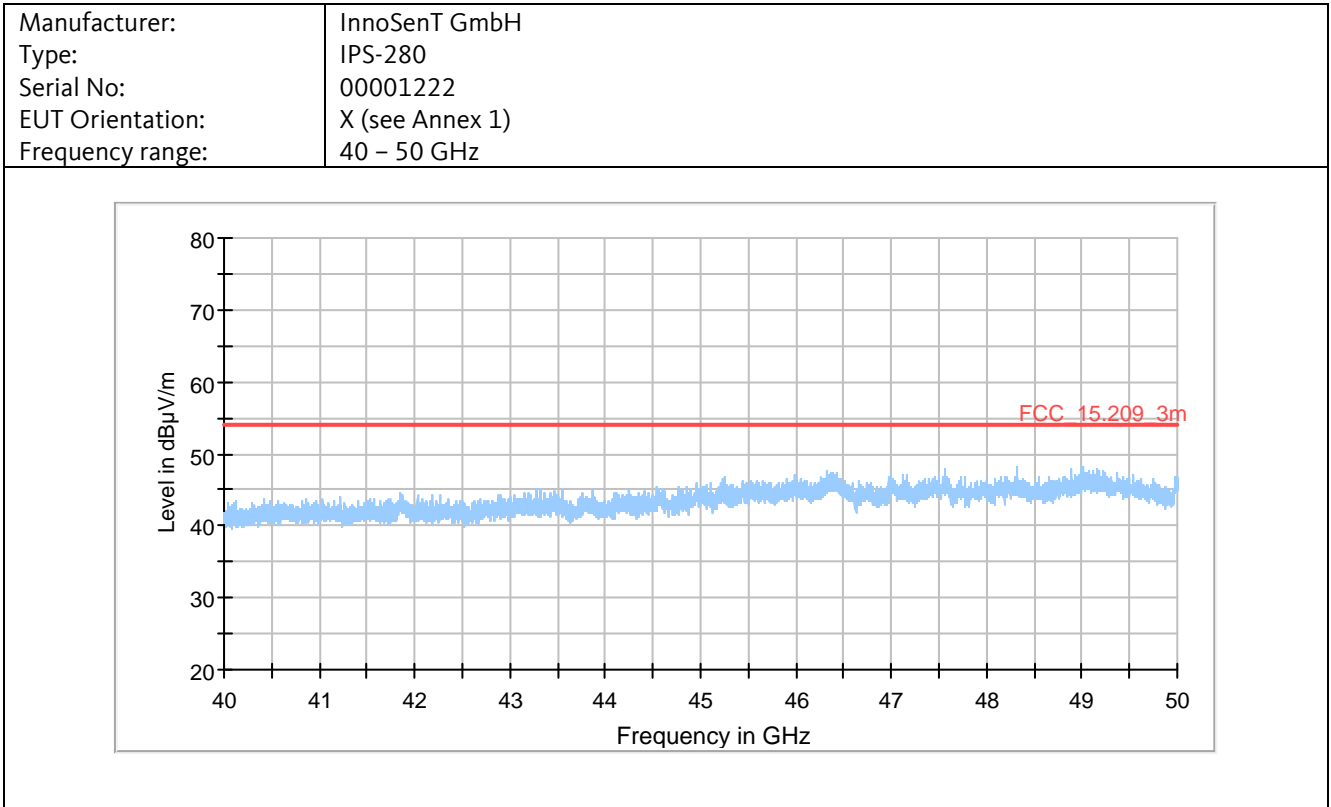

Test on InnoSenT GmbH IPS-280 to 47 CFR § 15.245

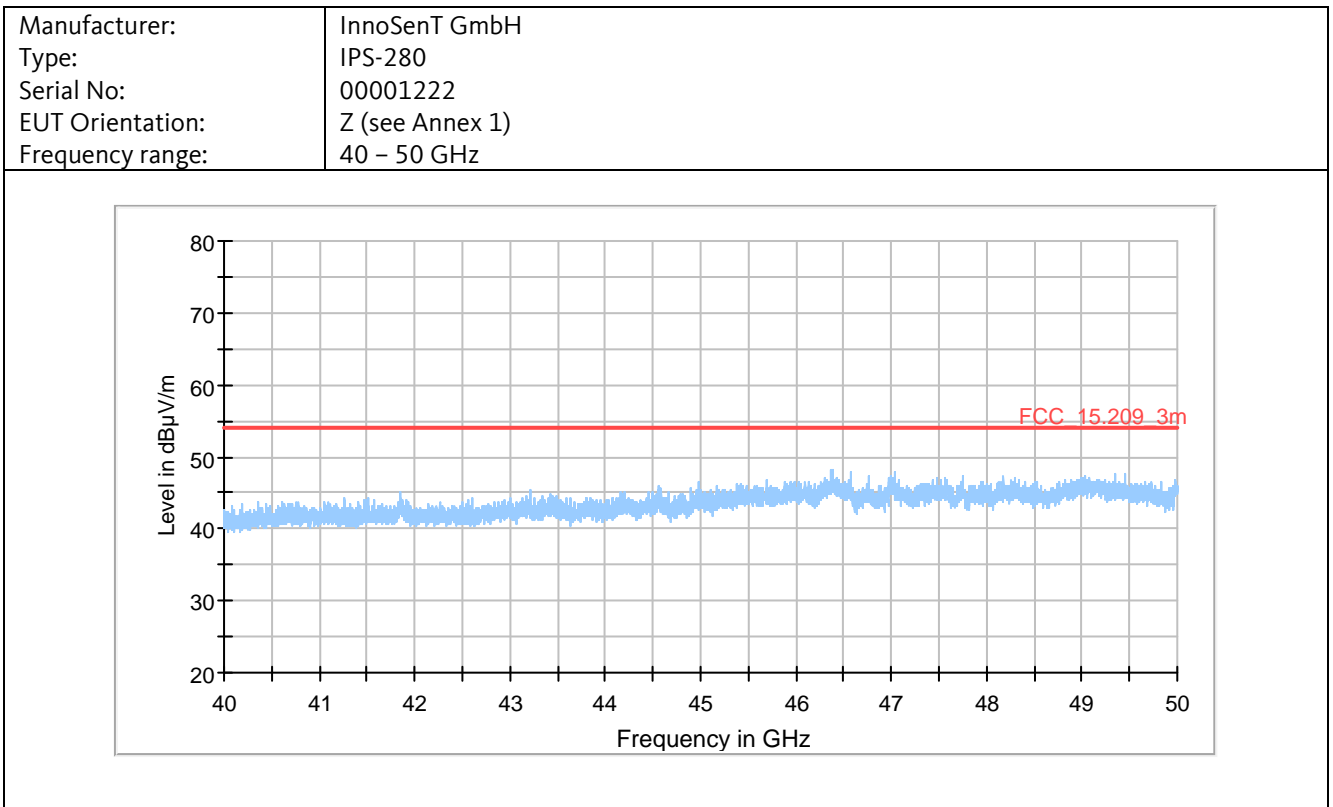

Test on InnoSenT GmbH IPS-280 to 47 CFR § 15.245

| | |
|------------------|-----------------|
| Manufacturer: | InnoSenT GmbH |
| Type: | IPS-280 |
| Serial No: | 00001222 |
| EUT Orientation: | X (see Annex 1) |
| Frequency range: | Lower bandedge |

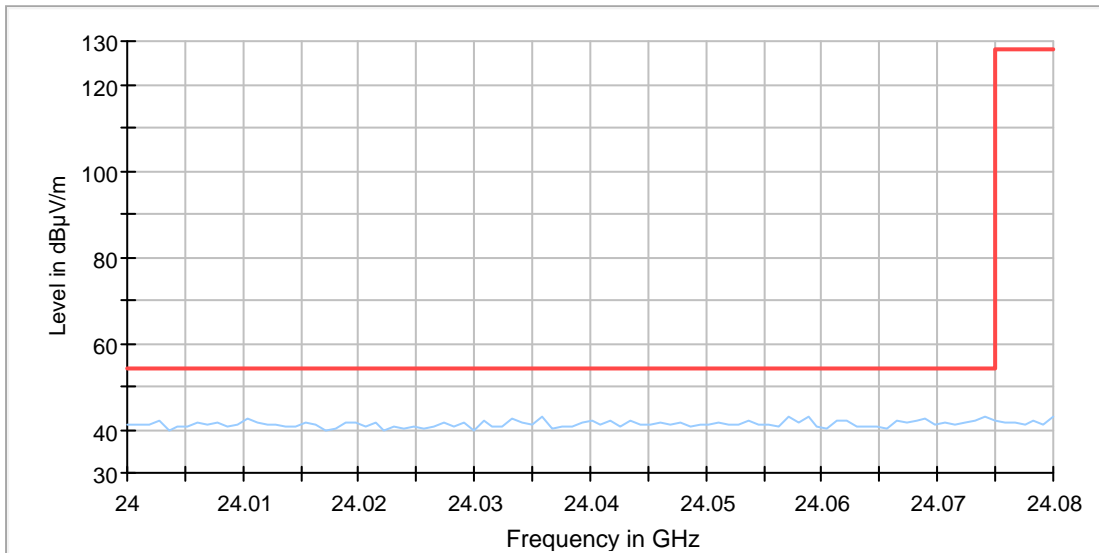

| | |
|------------------|-----------------|
| Manufacturer: | InnoSenT GmbH |
| Type: | IPS-280 |
| Serial No: | 00001222 |
| EUT Orientation: | X (see Annex 1) |
| Frequency range: | Upper bandedge |

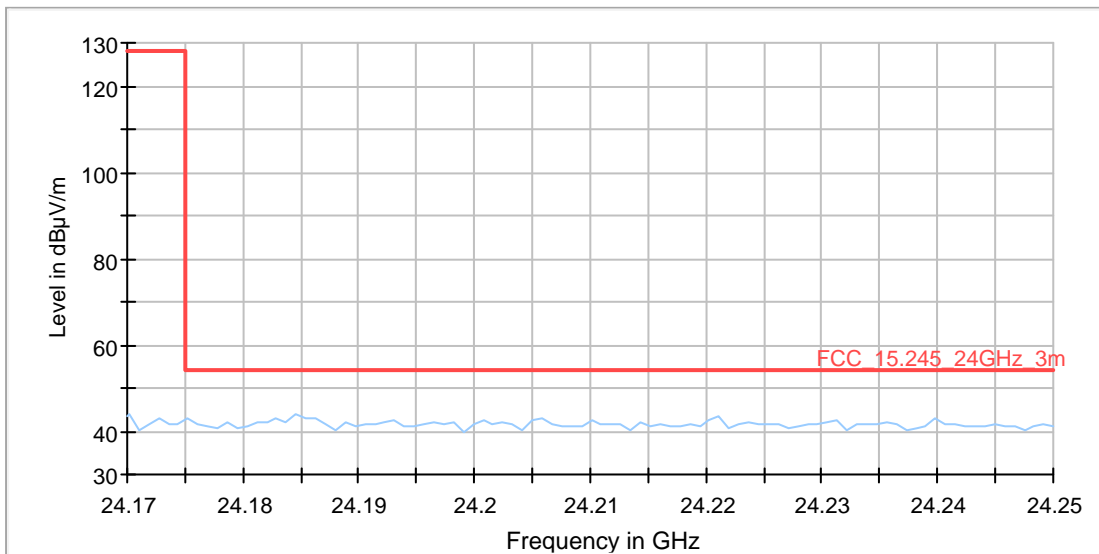

Test on InnoSenT GmbH IPS-280 to 47 CFR § 15.245

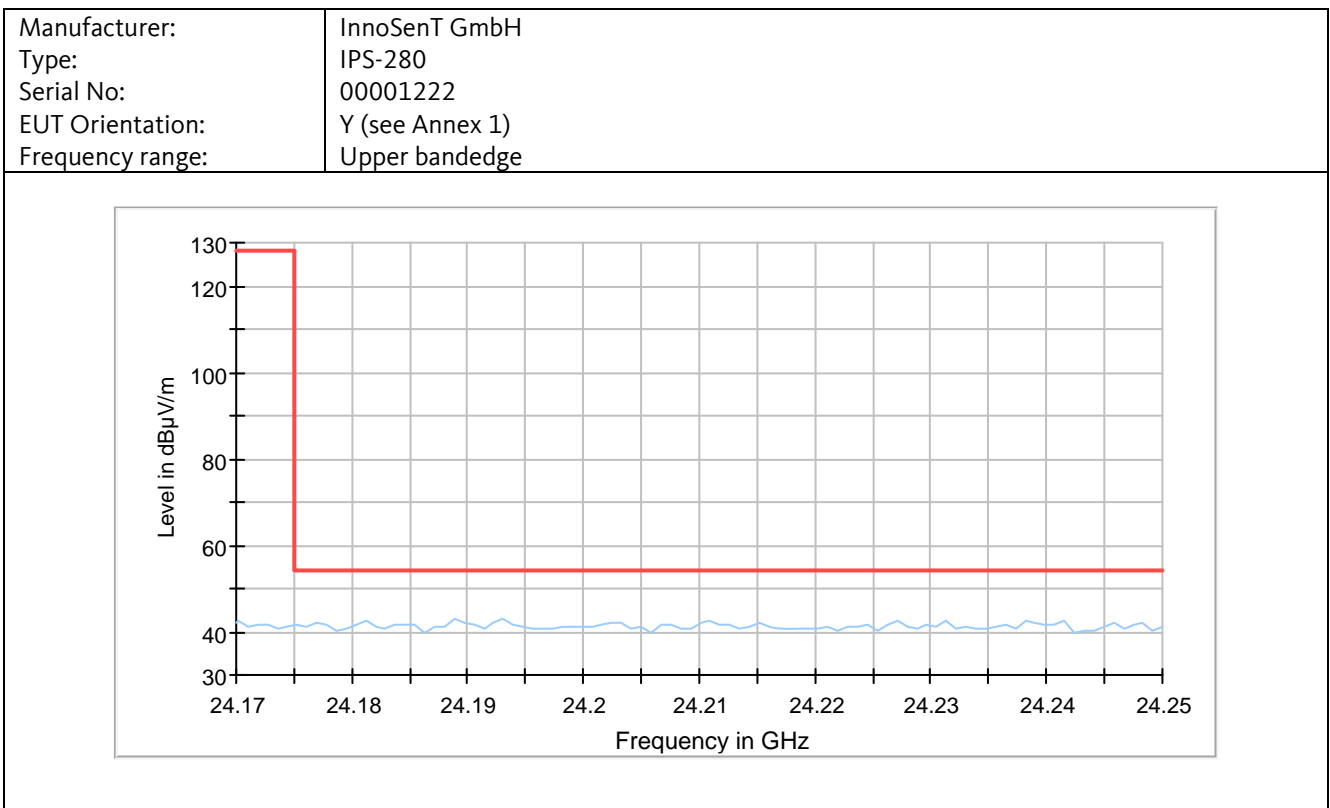
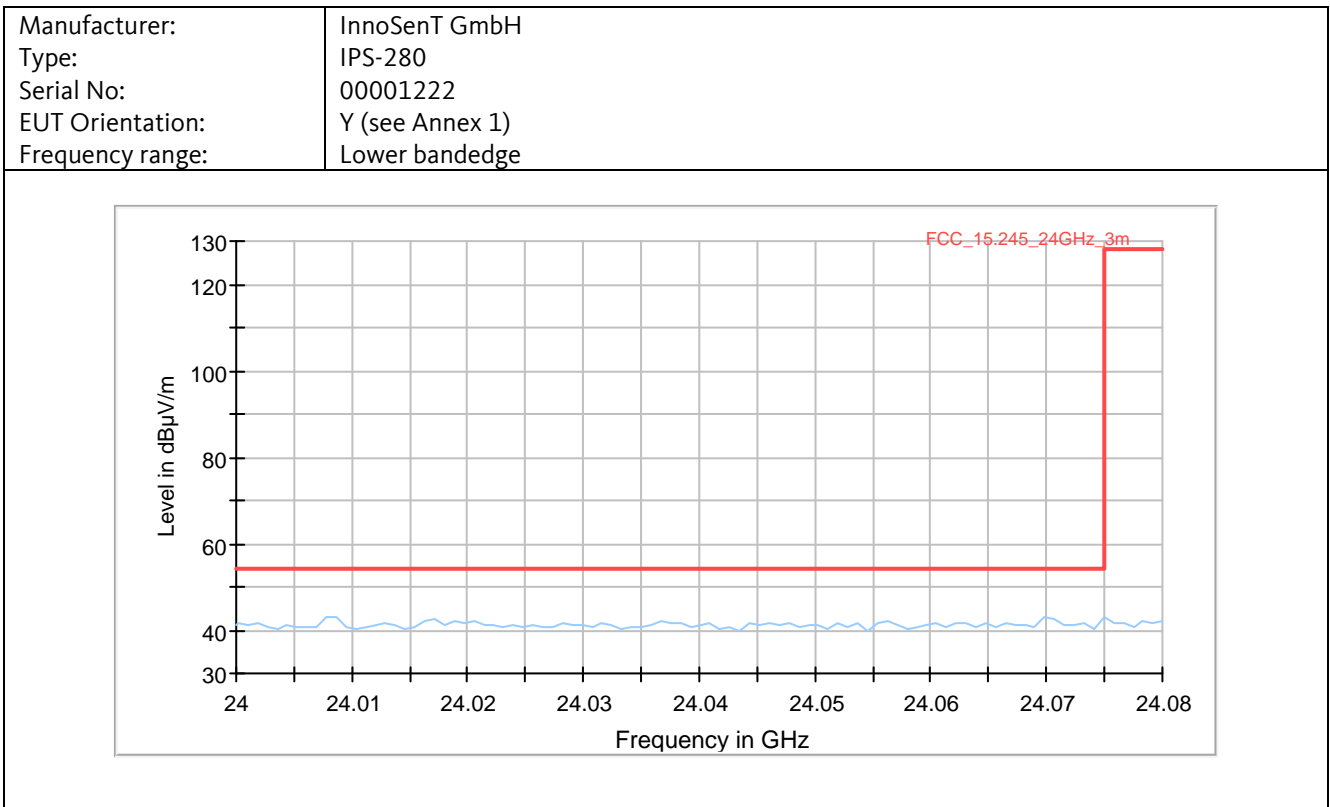

Test on InnoSenT GmbH IPS-280 to 47 CFR § 15.245

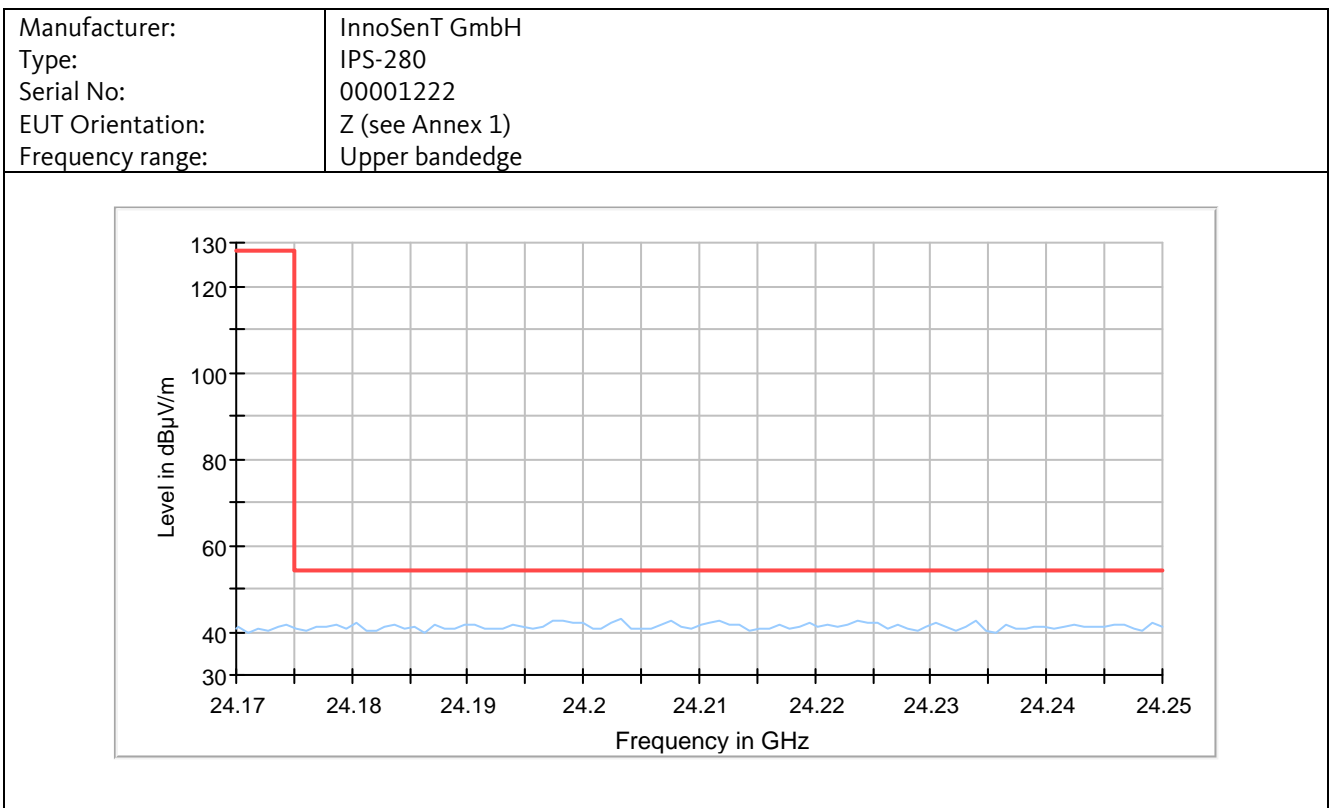
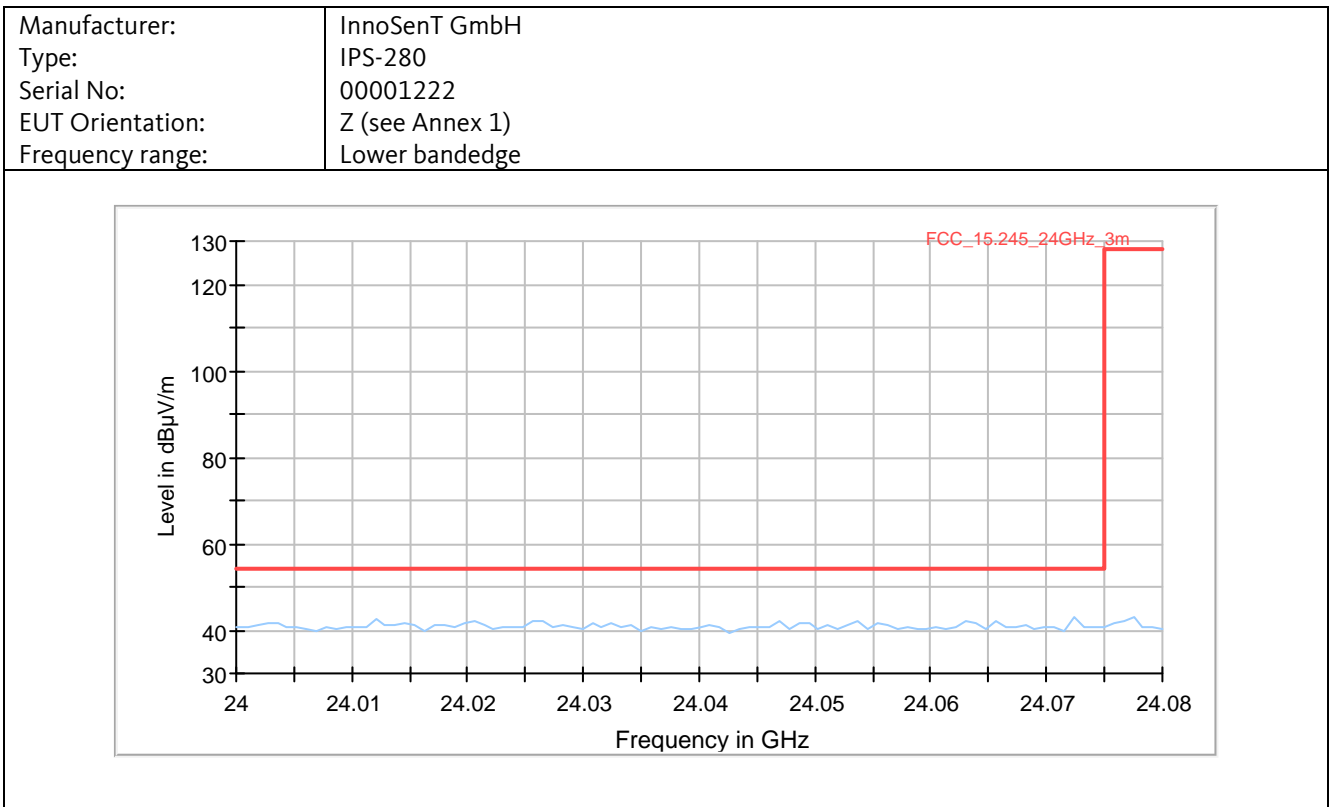

Test on InnoSenT GmbH IPS-280 to 47 CFR § 15.245

Final Result:

| Frequency MHz | MaxPeak dBμV/m | Average dBμV/m | Limit dBμV/m | Margin dB | Meas. Time ms | Bandwidth kHz | Height cm | Pol -- | Azimuth deg | Corr. dB/m |
|--|-------------------|-------------------|-----------------|--------------|------------------|------------------|--------------|-----------|----------------|---------------|
| | | | | | | | | | | |
| All peak emissions were below the average limit. Therefore, no final measurement performed. | | | | | | | | | | |
| | | | | | | | | | | |
| | | | | | | | | | | |
| | | | | | | | | | | |

All tests performed at the distance denoted in chapter 4.4.8.1. The limit was adjusted to correspond with the test distance. The table above contains worst-case emissions, only. For further details refer to the pre-scan test plot above.

4.4.8.4 Test Result

Manufacturer: InnoSenT GmbH
Type: IPS-280
Serial No.: 00001222
Test date: 2018-12-21 / 2019-01-07
Test personnel: Patrick Reusch

The EUT meets the requirements of this section.

4.4.9 Radiated Emissions 50 – 100 GHz

4.4.9.1 Test Procedures

ANSI C63.10-2013, 6.6.4.1 General

Subclauses 6.6.4.2 and 6.6.4.3 describe the procedures that shall be used for making exploratory and final radiated emission tests for frequencies above 1 GHz. Measurements may be performed at a distance closer than that specified in the requirements; however, an attempt shall be made to avoid making measurements in the near field of both the measurement antenna and the EUT for final measurements.

In performing these measurements, the sensitivity of the complete measurement system relative to the limit shall be determined before the test. If the overall measurement sensitivity does not provide a noise floor more than 6 dB below the limit, then low-noise preamplifiers, closer test distances, higher gain antennas, or narrower bandwidths might be required. If closer measurement distances are used, then the beamwidth of the measurement antenna versus the size of the EUT shall be taken into account. Also, measurement system overload protection shall be determined to be adequate when preamplifiers are used [see item b) of 4.1.3]. The effects of using bandwidths different from those specified shall also be determined (see also 6.3). Any changes from the specific measurement conditions shall be described in the report of the measurements (see also Annex E).

Install an appropriate filter at the input of the measurement system power amplifier. This filter shall attenuate the fundamental emission of the EUT and allow an accurate measurement of the associated harmonics and spurious emissions. The filter shall be characterized, and any attenuation/loss factors shall be accounted for in the measurement results.

Data shall be recorded in peak and average detection upto the highest measurement frequency required (unless stated otherwise in the applicable requirements).

ANSI C63.10-2013, 6.6.4.2 Exploratory radiated emissions measurements

Exploratory radiated measurements shall be performed at the measurement distance or at a closer distance than that specified for compliance to determine the emission characteristics of the EUT and, if applicable, the EUT configuration that produces the maximum level of emissions. The frequencies of maximum emission may be determined by manually positioning the antenna close to the EUT, and then moving the antenna over all sides of the EUT while observing a spectral display. It is advantageous to have prior knowledge of the frequencies of emissions, although this may be determined from such a near-field scan. The near-field scan shall only be used to determine the frequency but not the amplitude of the emissions. Where exploratory measurements are not adequate to determine the worst-case operating modes and are used only to identify the frequencies of the highest emissions, additional preliminary tests can be required.

Preliminary tests shall be performed following the procedures in 6.3 on a site meeting the requirements of 5.2. For emissions from the EUT, the maximum level shall be determined by rotating the EUT and its antenna through 0° to 360°. For each mode of operation required to be tested, the frequency spectrum (based on findings from exploratory measurements) shall be monitored.

Broadband antennas and a spectrum analyzer or a radio-noise meter with a panoramic display are often useful in this type of test. If either antenna height or EUT azimuth are not fully measured during exploratory testing, then complete testing can be required at the OATS or semi-anechoic chamber when the final full spectrum testing is performed.

ANSI C63.10.2013, 6.6.4.3 Final radiated emissions measurements

The final measurements are performed on a site meeting the requirements of 5.2. Using the orientation and equipment arrangement of the EUT based on the measurement results found during the preliminary (exploratory) measurements per 6.6.4.2, the EUT arrangement, appropriate modulation, and modes of operation that produce the emissions that have the highest amplitude relative to the limit shall be selected for the final measurement. The final measurement shall follow all the procedures in 6.3 with the EUT operating on frequencies per 5.6. For each mode selected, record the frequency and amplitude of the highest fundamental emission (if applicable), as well as the frequency and amplitude of the six highest spurious emissions relative to the limit. Emissions more than 20 dB below the limit do not need to be reported.

Measurements are performed with the EUT rotated from 0° to 360°; the antenna height scanned in accordance with 6.6.3.1, 6.6.3.2, or 6.6.3.3, as appropriate; and the antenna rotated to repeat the measurements for both the horizontal and vertical antenna polarizations. Variations in cable or wire placement shall be explored to maximize the measured emissions.

Test on InnoSenT GmbH IPS-280 to 47 CFR § 15.245

The emission signal shall be kept within the illumination area of the 3 dB beamwidth of the antenna so that the maximum emission from the EUT is measured. This may be achieved by either pointing the antenna at an angle toward the source of the emission or by testing the EUT as described in 6.6.3.3.

If the emission is pulsed, then refer to Annex C for guidelines on selecting bandwidth and determining pulse desensitization factors, as necessary.

As noted in 6.6.4.1, when performing these measurements, the sensitivity of the complete measurement system relative to the limit shall be determined before the test. If the overall measurement sensitivity is inadequate, then low-noise preamplifiers, closer measurement distances, higher gain antennas, or narrower bandwidths may be used. If closer measurement distances or higher gain antennas are used, then the beamwidth of the measurement antenna versus the physical size of the EUT shall be taken into account, so that the physical sizes of the EUT dimensions are encompassed by the beamwidth of the measurement antenna. Also, measurement system overload protection shall be determined to be adequate when preamplifiers are used. The effects on the measured emission value using bandwidths different from those specified shall be determined if such bandwidth changes are made. Any changes from the specific measurement conditions shall be described in the report of the measurements.

Unless specified otherwise by the regulatory authority, the instrumentation, detector functions, and bandwidths specified in 4.1.4.2.1 and 4.1.4.2.2 shall be used. For pulsed emissions, the procedure in 4.1.4.2.4 shall be used.

| Radiated Emissions Test Characteristics | |
|--|---|
| Frequency range | 50 GHz – 100 GHz |
| Test distance | Explorative measurement in close distance |
| Test instrumentation resolution bandwidth | 1 MHz |
| Receive antenna height | 1.5 m |
| Receive antenna polarization | Vertical/Horizontal |
| Measurement chamber | Fully anechoic chamber (FAC) |

Test on InnoSenT GmbH IPS-280 to 47 CFR § 15.245

4.4.9.2 Test Setup

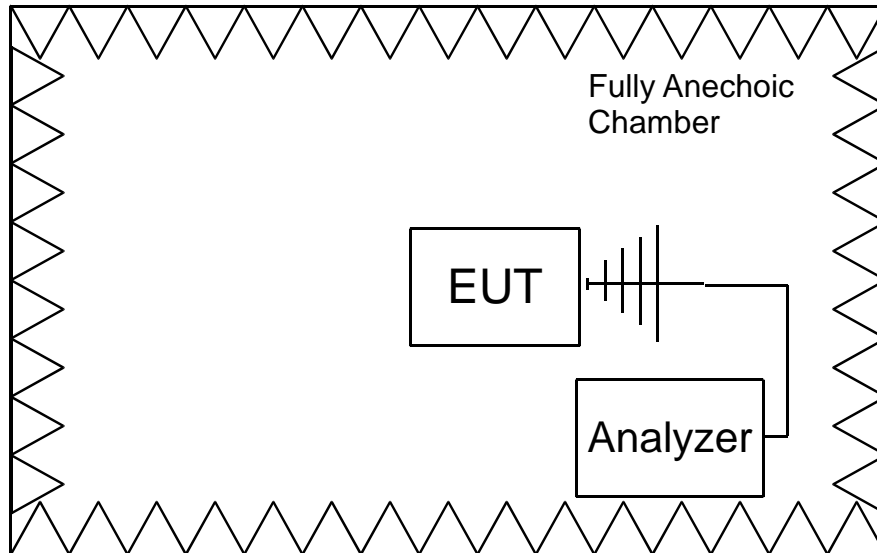

SCHEMATIC TEST SETUP

Requirement: 47 CFR, § 15.209
Procedure: ANSI C63.10-2013

Receiver: #3831
Antenna: #2591 (50 - 75 GHz)
#2600 (75 - 100 GHz)

Test distance: n/a

TEST EQUIPMENT USED:
Refer to chapter 5 of this document.
1441, 1546, 1548, 1798, 1799, 1800,
1868, 2112, 2114, 2591, 2594, 2597,
2600, 2696, 3831, 4717, 4721

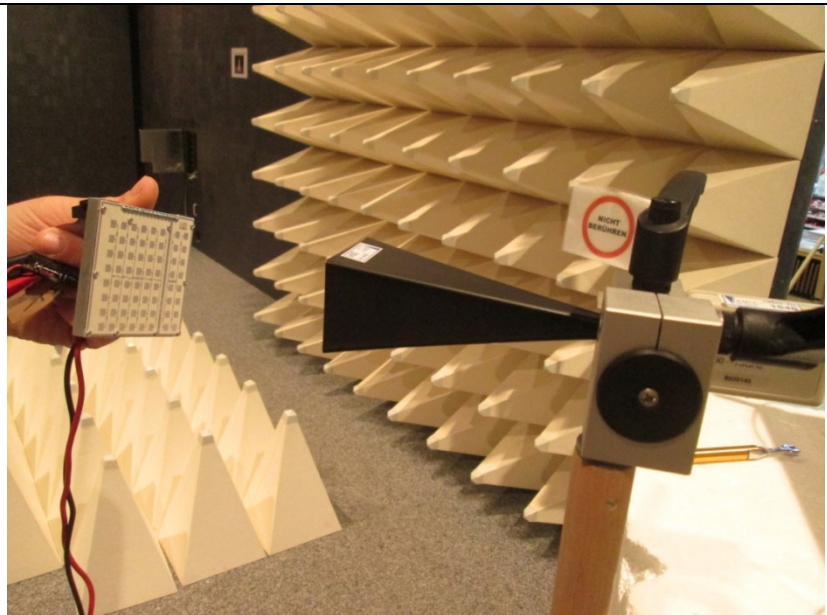

Sample photo of setup

Test on InnoSenT GmbH IPS-280 to 47 CFR § 15.245

4.4.9.3 Detailed Test Data

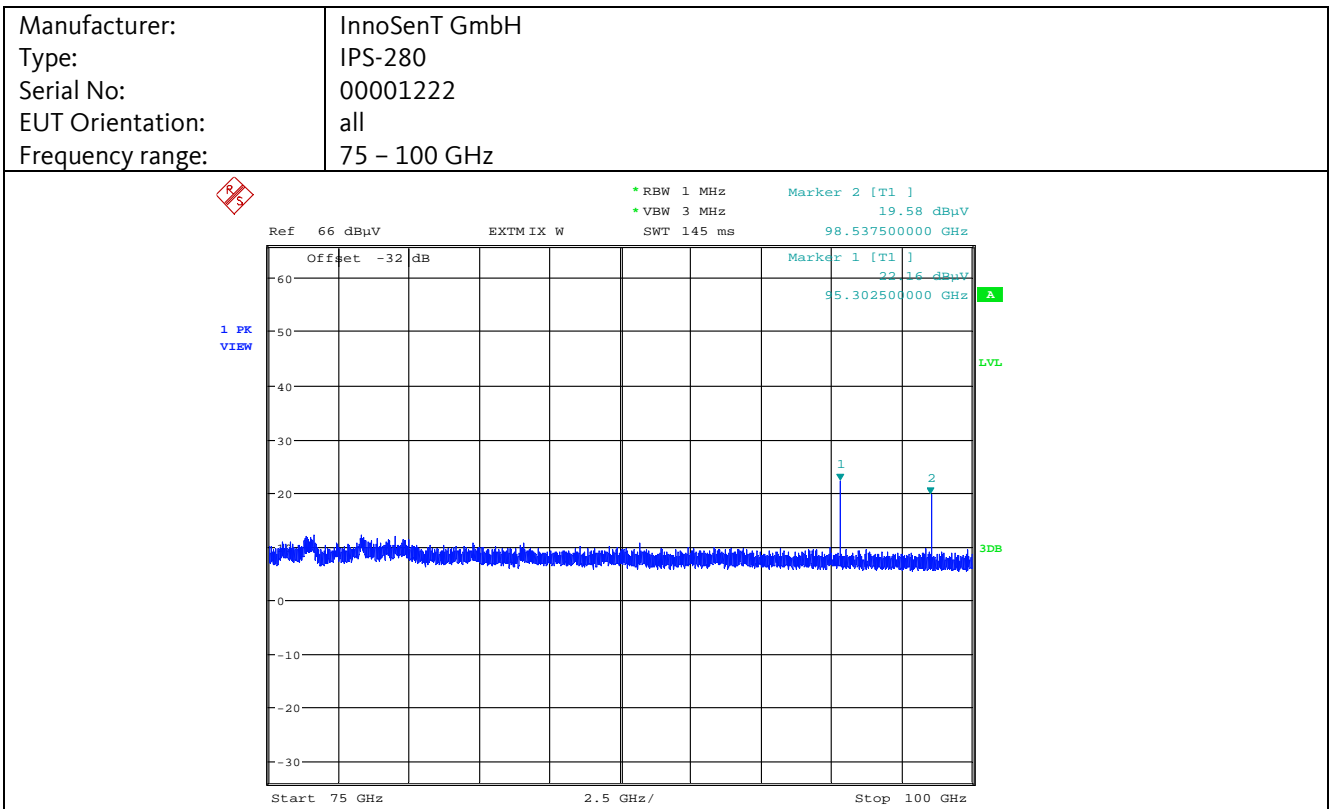
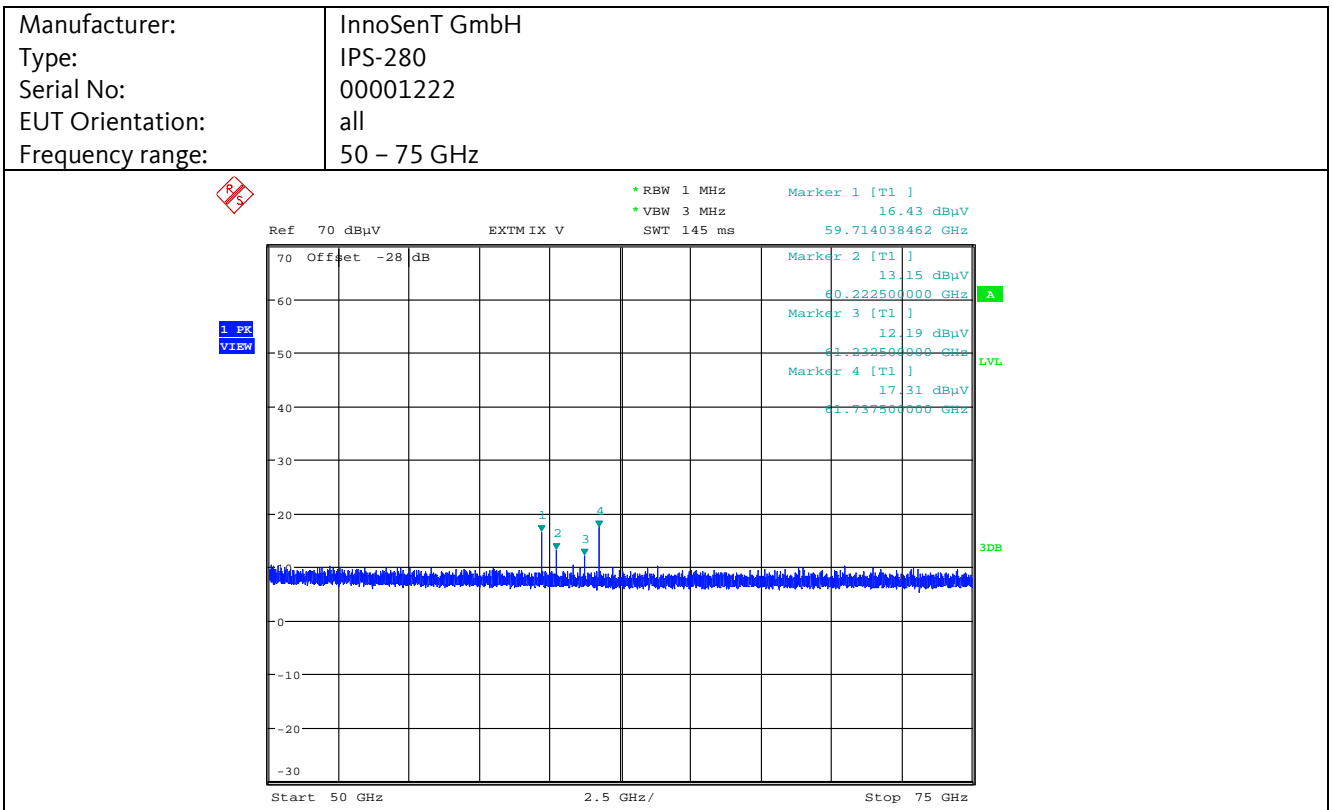

Note: prescan plots above are showing the measurement receiver's reading, only, without any transducer/correction factors applied. All emission detected were investigated in the following by use of SignalID-function to prove their validity. Please refer to the following plots for details.

Test on InnoSenT GmbH IPS-280 to 47 CFR § 15.245

| | |
|---------------|---|
| Manufacturer: | InnoSenT GmbH |
| Type: | IPS-280 |
| Serial No: | 00001222 |
| Remarks: | Emission at Marker #1 of plot 50-75GHz, investigated by use of SignalID-function. Result: displayed emission is a mixing product and not real. |

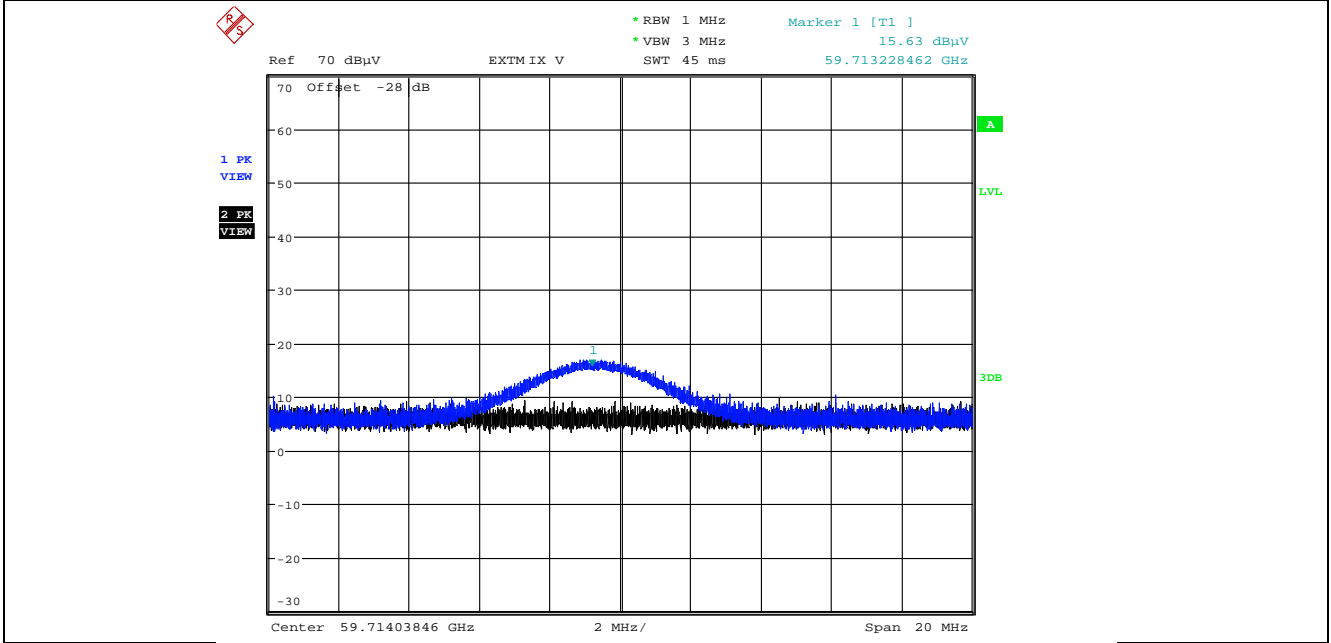

| | |
|---------------|---|
| Manufacturer: | InnoSenT GmbH |
| Type: | IPS-280 |
| Serial No: | 00001222 |
| Remarks: | Emission at Marker #2 of plot 50-75GHz, investigated by use of SignalID-function. Result: displayed emission is a mixing product and not real. |

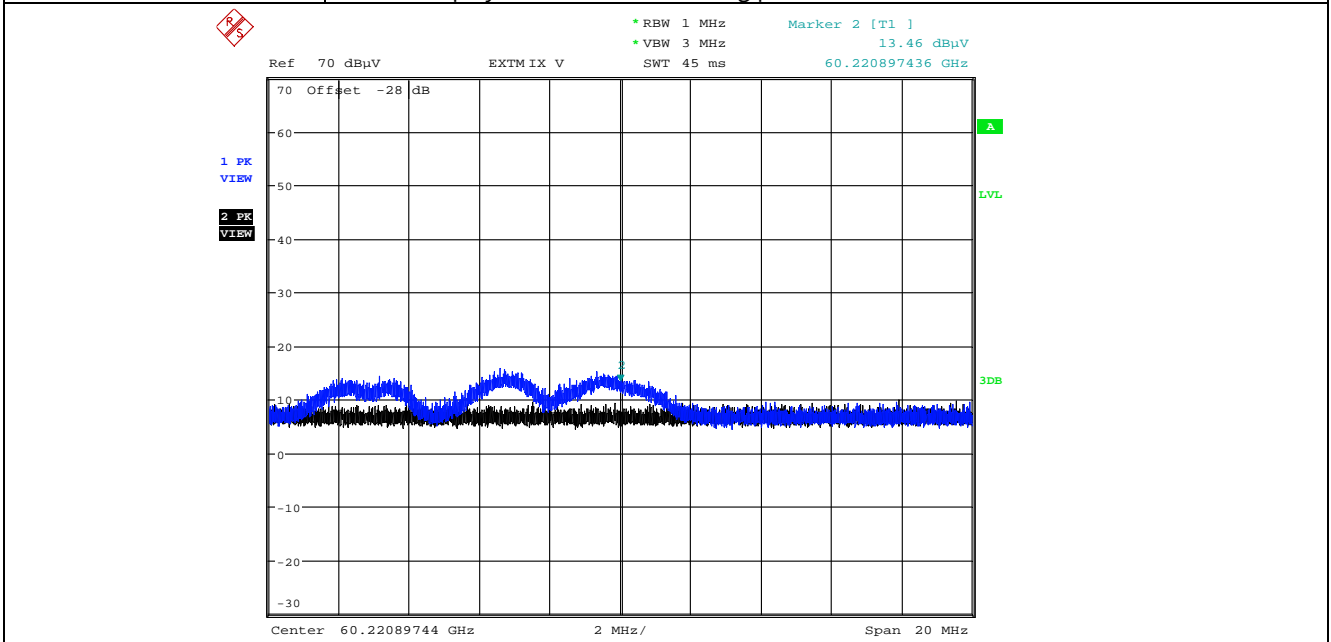

Test on InnoSenT GmbH IPS-280 to 47 CFR § 15.245

| | |
|---------------|---|
| Manufacturer: | InnoSenT GmbH |
| Type: | IPS-280 |
| Serial No: | 00001222 |
| Remarks: | Emission at Marker #3 of plot 50-75GHz, investigated by use of SignalID-function. Result: displayed emission is a mixing product and not real. |

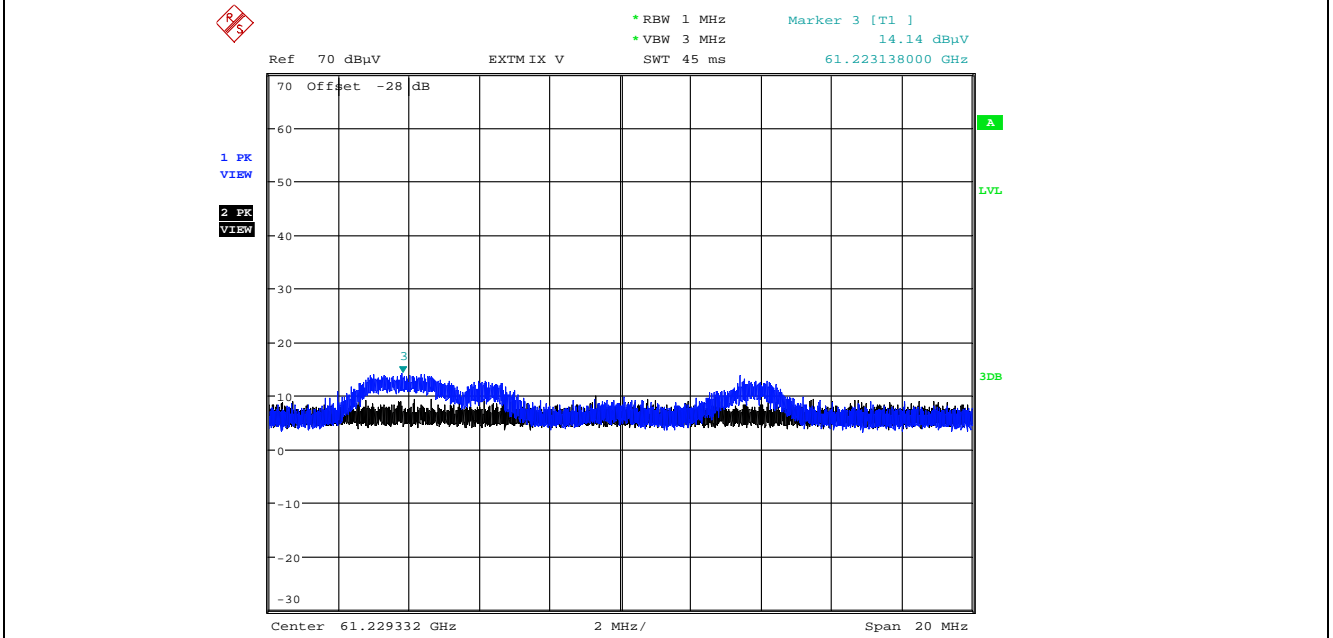

| | |
|---------------|---|
| Manufacturer: | InnoSenT GmbH |
| Type: | IPS-280 |
| Serial No: | 00001222 |
| Remarks: | Emission at Marker #4 of plot 50-75GHz, investigated by use of SignalID-function. Result: displayed emission is a mixing product and not real. |

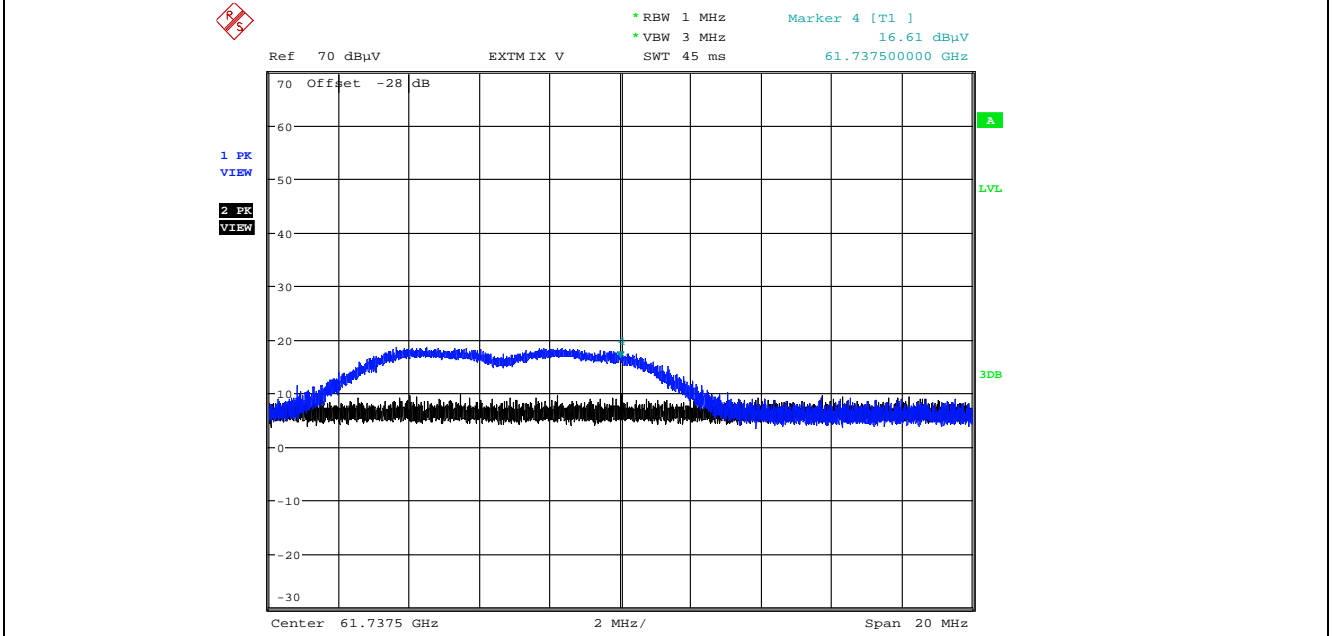

Test on InnoSenT GmbH IPS-280 to 47 CFR § 15.245

| | |
|---------------|--|
| Manufacturer: | InnoSenT GmbH |
| Type: | IPS-280 |
| Serial No: | 00001222 |
| Remarks: | Emission at Marker #1 of plot 75-100GHz, investigated by use of SignalID-function. Result: displayed emission is a mixing product and not real. |

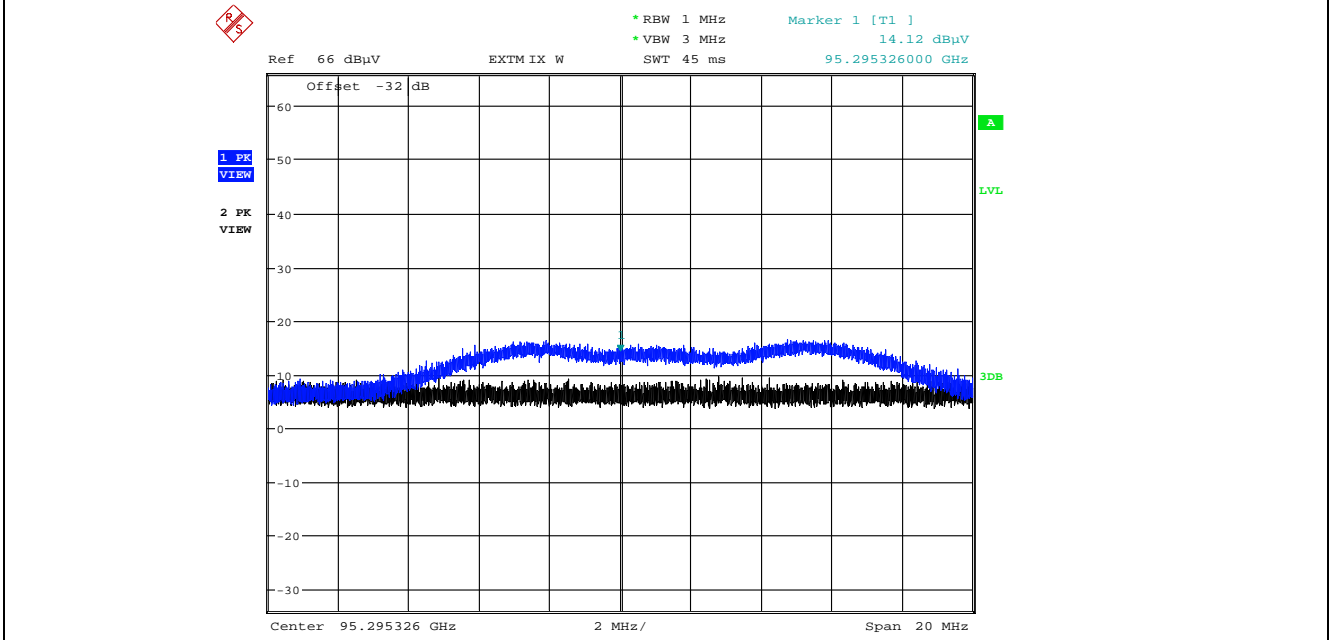

| | |
|---------------|--|
| Manufacturer: | InnoSenT GmbH |
| Type: | IPS-280 |
| Serial No: | 00001222 |
| Remarks: | Emission at Marker #2 of plot 75-100GHz, investigated by use of SignalID-function. Result: displayed emission is a mixing product and not real. |

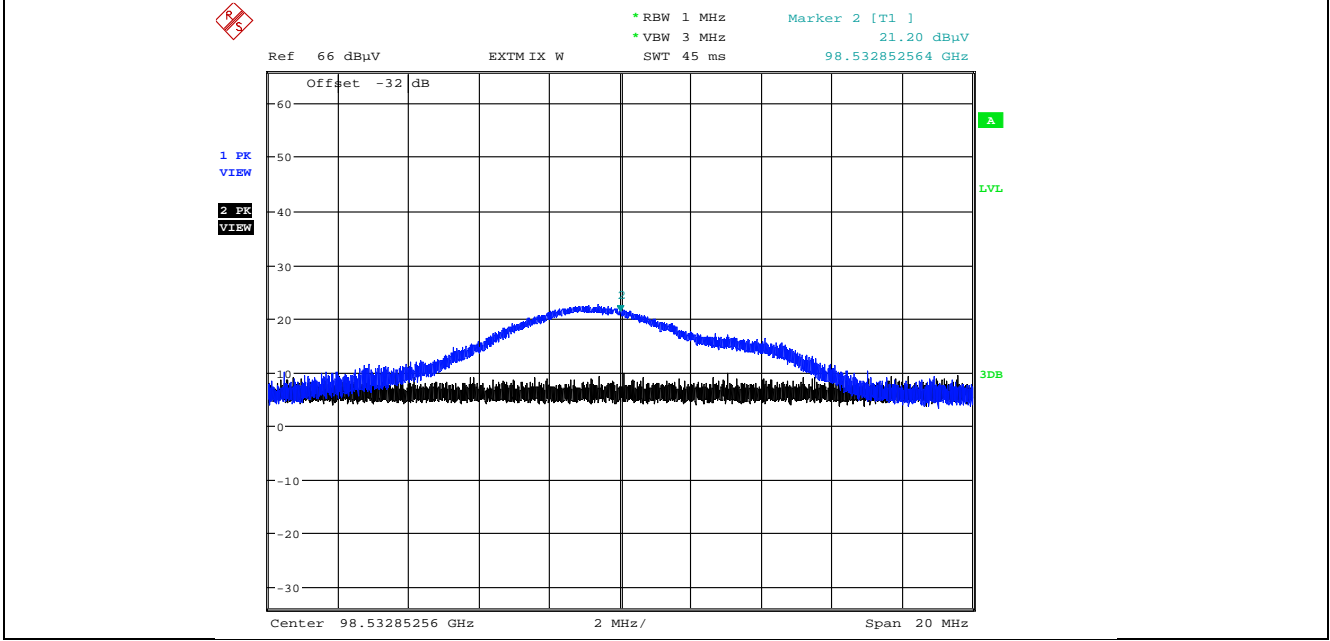

Test on InnoSenT GmbH IPS-280 to 47 CFR § 15.245

| | |
|---------------|---|
| Manufacturer: | InnoSenT GmbH |
| Type: | IPS-280 |
| Serial No: | 00001222 |
| Remarks: | Zoomed to 3 rd harmonic frequency. Result: no harmonic emission found above the noise floor (34 dB μ V/m at 3m) |

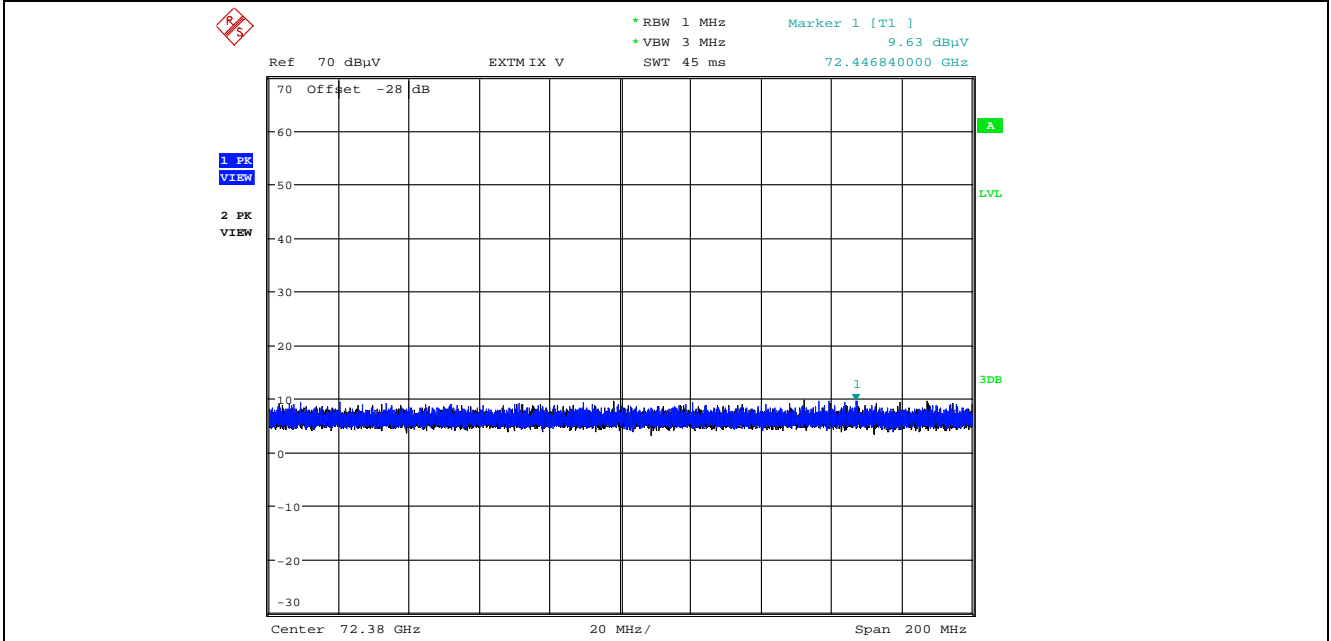

| | |
|---------------|---|
| Manufacturer: | InnoSenT GmbH |
| Type: | IPS-280 |
| Serial No: | 00001222 |
| Remarks: | Zoomed to 4 th harmonic frequency. Result: no harmonic emission found above the noise floor (48 dB μ V/m at 3m) |

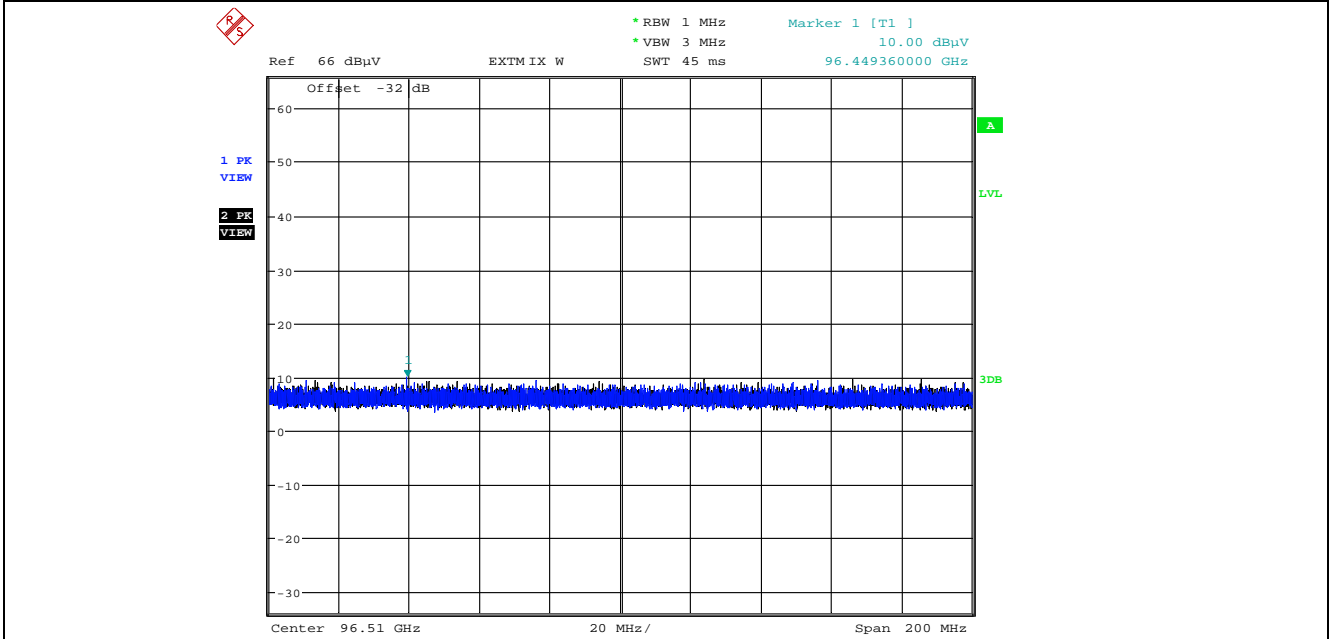

Test on InnoSenT GmbH IPS-280 to 47 CFR § 15.245

Final Result:

| Frequency MHz | MaxPeak dBμV/m | Average dBμV/m | Limit dBμV/m | Margin dB | Meas. Time ms | Bandwidth kHz | Height cm | Pol -- | Azimuth deg | Corr. dB/m |
|--|-------------------|-------------------|-----------------|--------------|------------------|------------------|--------------|-----------|----------------|---------------|
| | | | | | | | | | | |
| All emissions are below the noise level (< 50 dBμV/m at 3m). Therefore, no final measurement performed. | | | | | | | | | | |
| | | | | | | | | | | |
| | | | | | | | | | | |
| | | | | | | | | | | |

All tests performed at the distance denoted in chapter 4.4.9.1. The limit was adjusted to correspond with the test distance.
 The table above contains worst-case emissions, only. For further details refer to the pre-scan test plot above.

4.4.9.4 Test Result

Manufacturer: InnoSenT GmbH
 Type: IPS-280
 Serial No.: 00001222
 Test date: 2019-01-08
 Test personnel: Patrick Reusch

The EUT meets the requirements of this section.

Test on InnoSent GmbH IPS-280 to 47 CFR § 15.245

5 TEST INSTRUMENTS

| EMCC ID # | Instrument | Manufacturer | Model No. | Last Calibration | Calibration valid until |
|-----------|--|---------------------|----------------|------------------|-------------------------|
| 54 | N-Cable N/50 | Rohde & Schwarz | HFU2-Z5 | n/a | n/a |
| 374 | Loop Antenna | Rohde & Schwarz | HFH 2-Z2 | 2018-11 | 2021-02 |
| 516 | EMI Test Receiver | Rohde & Schwarz | ESIB40 | 2018-03 | 2019-03 |
| 1229 | Standard Gain Horn Antenna | Mid Century | MC 22/31B | 2014-07 | 2024-07 |
| 1291 | Antenna Mast | Frankonia | FAM4 | n/a | n/a |
| 1292 | Multi Device Controller | Frankonia | FC02 | n/a | n/a |
| 1294 | Multi Device Controller | Frankonia | FC03 | n/a | n/a |
| 1300 | Standard Gain Horn Antenna | Mid Century | MC 20/31B | 2014-07 | 2024-07 |
| 1301 | Waveguide/SMAf-Adapter | GHz Gardena | K 173 | 2018-09 | 2020-09 |
| 1348 | Wav./Kf/SMAf-Adap., R-band | fmi/pro nova | 22093-KF20 | 2018-09 | 2020-09 |
| 1441 | Precis.Var.Waveg.Attn. | FMI/Singer | 2611 | n/a | n/a |
| 1546 | Waveguide Mixer | Rohde & Schwarz | FS-Z110/WM782W | n/a | n/a |
| 1548 | Waveguide Mixer | Rohde & Schwarz | FS-Z75/WM782V | n/a | n/a |
| 1798 | Tripler 90...120 GHz | VDI Virginia Diodes | WR9.3x3 | n/a | n/a |
| 1799 | Tripler 60...90 GHz | Spacek Labs | AE-3X | n/a | n/a |
| 1800 | Doubler 40...60 GHz | Spacek Labs | AU-2X | n/a | n/a |
| 1868 | SR-ULL-03, Fully Anechoic Chamber (FAC) | EMCC/FRANKONIA | | n/a | n/a |
| 1889 | SR-ULL-01, Semi-Anechoic Chamber (SAC) | EMCC/FRANK. | SAC-10 | n/a | n/a |
| 1890 | SR-ULL-05, Absorber-Lined Shielded Chamber | EMCC / SIEM / FRANK | SC2-ULL | n/a | n/a |
| 1901 | V-LISN 50 ohms/(50 uH + 5 ohms) | Rohde & Schwarz | ESH2-Z5 | 2018-11 | 2019-11 |
| 2111 | Tapered Transition | FMI/Pro NOVA | 23000-24 | n/a | n/a |
| 2112 | RF Power Meter | Hewlett-Packard | 432 A | n/a | n/a |
| 2113 | Standard Gain Horn Antenna | FMI/Pro NOVA | 2424-25 | n/a | n/a |
| 2114 | Precis.Var.Waveg.Attn. | FMI/Tho | 2411 | n/a | n/a |
| 2591 | Standard Gain Horn Antenna | Electrof./Tho | WG25-25 | n/a | n/a |
| 2594 | Precis.Var.Waveg.Attn. | Millitech | DRA-10-R0000 | n/a | n/a |
| 2596 | Thermistor Mount | Millitech | THM-10-RF000 | 2015-08 | 2020-08 |
| 2597 | Thermistor Mount | Millitech | THM-15-RF000 | 2015-08 | 2020-08 |
| 2600 | Standard Gain Horn Antenna | Electrof./Tho | WG27-25 | n/a | n/a |
| 2724 | 5 W Attenuator 6dB | Weinschel | 2 | 2017-06 | 2019-06 |
| 3184 | Pulse Limiter | MTS | MTA-IMP-136 | 2017-07 | 2019-07 |
| 3235 | Double Ridged Guide Antenna | Schwarzbeck | BBHA 9120D | 2017-05 | 2019-05 |
| 3831 | Spectrum Analyzer | Rohde & Schwarz | FSU50 | 2018-10 | 2019-10 |
| 3846 | EMI Test Receiver | Rohde & Schwarz | ESU8 | 2018-01 | 2019-01 |
| 3880 | Digital Multimeter | Agilent | U1241B | 2018-07 | 2020-07 |

Test on InnoSent GmbH IPS-280 to 47 CFR § 15.245

| EMCC ID # | Instrument | Manufacturer | Model No. | Last Calibration | Calibration valid until |
|-----------|---|----------------------------|---------------------|------------------|-------------------------|
| 3968 | 50 GHz Cable, 2.4 mm | Insulated Wire | 2PS-1401-250-2PS | n/a | n/a |
| 4075 | Workstation | Dell | Optiplex 7010 | n/a | n/a |
| 4524 | Notebook | Dell | Latitude E6430 | n/a | n/a |
| 4597 | USB to GPIB adapter | National Instruments | GPIB-USB-HS | n/a | n/a |
| 4717 | Web-Thermo-Hygrobarograph | Wiesemann & Theis GmbH WUT | 57613 Web-T/Rh/P | 2018-01 | 2020-01 |
| 4721 | DC Power Supply | Tektronix | PWS4205 | n/a | n/a |
| 4914 | Adaptor, Waveguide to Coax | FLANN | 23093-TF30 UG-383/U | n/a | n/a |
| 5392 | EMC Measurement Software, V10.35.01 / V10.35.02 | Rohde & Schwarz | EMC32 | n/a | n/a |
| 5535 | Positioning controller | Rohde & Schwarz | HCC | n/a | n/a |
| 5536 | Rotary table | Rohde & Schwarz | HCT | n/a | n/a |
| 5544 | Antenna Mast | innco systems GmbH | MA 5000-XPET | n/a | n/a |
| 5545 | Antenna Mast Controller | innco systems GmbH | CO 3000-1D | n/a | n/a |
| 5551 | BNC cable | EMCC | BNC003m0 | n/a | n/a |
| 5612 | RF cable assembly | Rosenberger | LA1-008-1400 | n/a | n/a |
| 5615 | RF cable assembly | Rosenberger | LA2-025-7000 | n/a | n/a |
| 6041 | TRILOG Broadband Antenna | Schwarzbeck | VULB 9163 | 2017-09 | 2019-09 |

Test on InnoSenT GmbH IPS-280 to 47 CFR § 15.245

6 MEASUREMENT UNCERTAINTY

| Measurement | Measurement Uncertainty |
|--|-------------------------|
| Conducted Emissions, AC mains (150 kHz – 30 MHz) | ±3.5 dB |
| Radiated Emissions below 1000 MHz | ±5.6 dB |
| Radiated Emissions above 1000 MHz | ±4.6 dB |

The reported uncertainty values are based on a standard uncertainty multiplied by a coverage factor of $k=2$, providing a level of confidence of 95%.

The given values have been calculated on the basis of the following documents:

CISPR 16-4-2:2011+A1:2014, Specification for radio disturbance and immunity measuring apparatus and methods - Part 4-2: Uncertainties, statistics and limit modelling - Measurement instrumentation uncertainty.

JCGM 100:2008, Evaluation of measurement data - Guide to the expression of uncertainty in measurement.

Test on InnoSenT GmbH IPS-280 to 47 CFR § 15.245

7 LIST OF ANNEXES

The following annexes are separated parts from this test report.

| Description | Pages |
|---|-------|
| Annex 1: Photographs of test setup | 8 |
| Annex 2: External photographs of equipment under test | 3 |
| Annex 3: Internal photographs of equipment under test | 2 |
| Annex 4: Photographs of ancillary equipment | 2 |

ANNEX 1 TO TEST REPORT # EMCC-080534GAA, 2019-02-20

PHOTOGRAPHS OF TEST SETUP

EQUIPMENT UNDER TEST:

| | |
|-------------------|---|
| Trade Name: | K-Band Transceiver |
| Type/Model: | IPS-280 |
| Serial Number(s): | 00001222 |
| Application: | K-Band Radar |
| FCC ID: | UXS-IPS280 |
| Manufacturer: | InnoSenT GmbH |
| Address: | Am Roedertor 30 97499 Donnersdorf GERMANY |
| Phone: | +49 9528 9518-1265 |
| E-Mail: | Barrett.Lee@innosent.de |

RELEVANT STANDARD(S) : 47 CFR § 15.245

MEASUREMENT PROCEDURE: : ANSI C63.10-2013

ILLUSTRATION LIST ANNEX 1

| | |
|--|---|
| Photograph A1-1: Sample photo of position "X" | 2 |
| Photograph A1-2: Sample photo of position "Y" | 2 |
| Photograph A1-3: Sample photo of position "Z" | 3 |
| Photograph A1-4: Conducted emissions | 3 |
| Photograph A1-5: Radiated emissions 9 kHz – 30 MHz at 3 m distance | 4 |
| Photograph A1-6: Radiated emissions 30 – 1000 MHz at 3 m distance | 4 |
| Photograph A1-7: Radiated emissions 1 – 6 GHz at 3 m distance | 5 |
| Photograph A1-7: Sample setup photo of radiated emissions 6 – 18 GHz at 1 m distance | 5 |
| Photograph A1-9: Radiated emissions 18 – 26.5 GHz at 1 m distance | 6 |
| Photograph A1-10: Radiated emissions 26.5 – 40 GHz at 1 m distance | 6 |
| Photograph A1-11: Radiated emissions 40 – 50 GHz at 1 m distance | 7 |
| Photograph A1-12: Radiated emissions 50 – 75 GHz at close distance | 7 |
| Photograph A1-13: Radiated emissions 75 – 100 GHz at close distance | 8 |

Test on InnoSenT GmbH IPS-280 to 47 CFR § 15.245

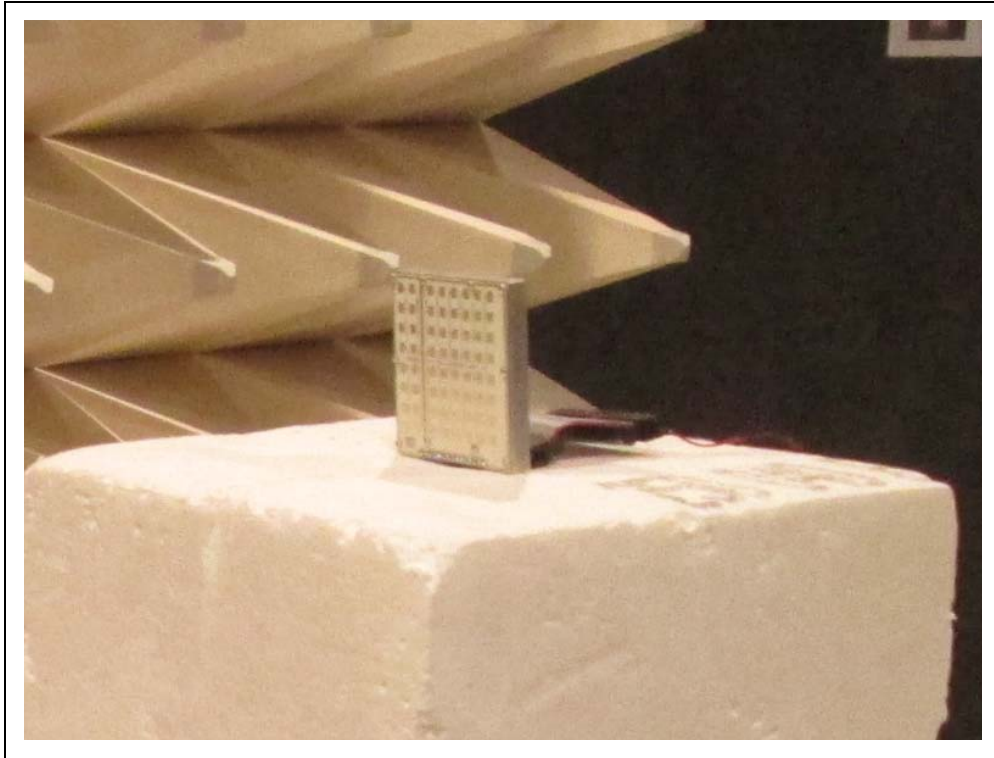

Photograph A1-1: Sample photo of position "X"

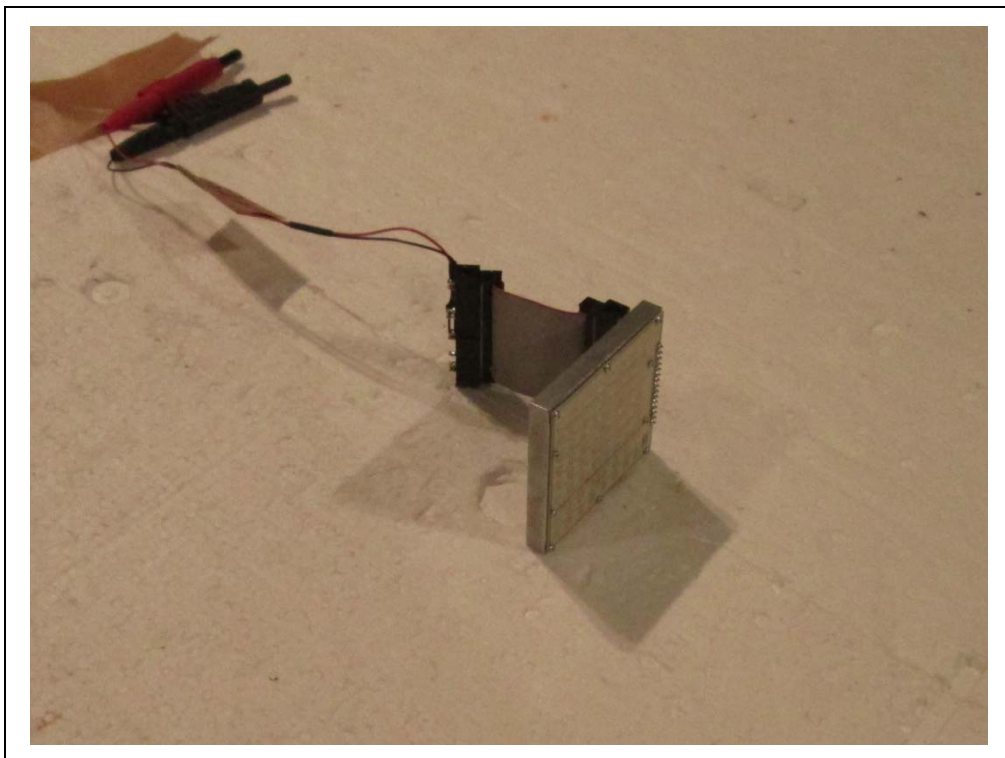

Photograph A1-2: Sample photo of position "Y"

Test on InnoSenT GmbH IPS-280 to 47 CFR § 15.245

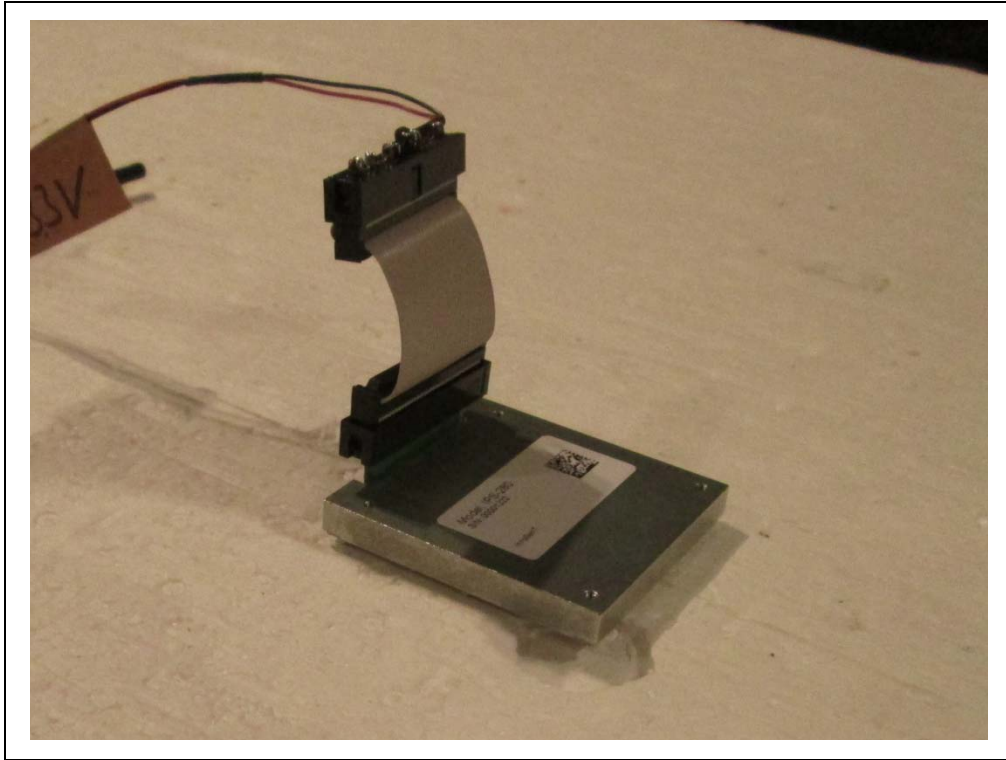

Photograph A1-3: Sample photo of position "Z"

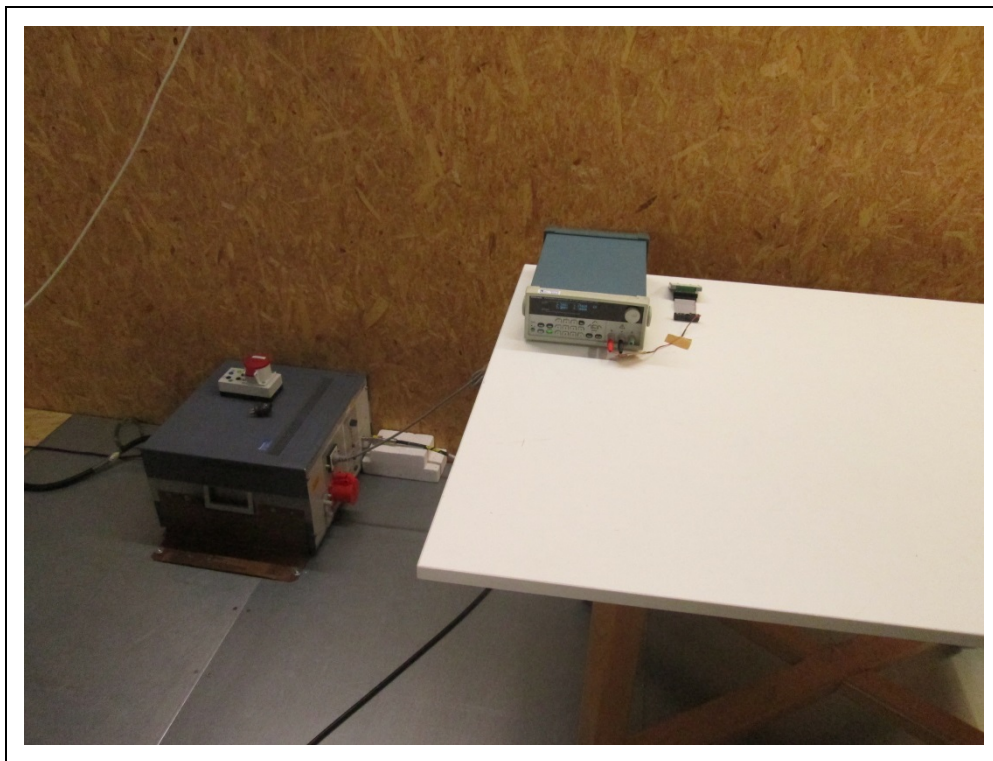

Photograph A1-4: Conducted emissions

Test on InnoSenT GmbH IPS-280 to 47 CFR § 15.245

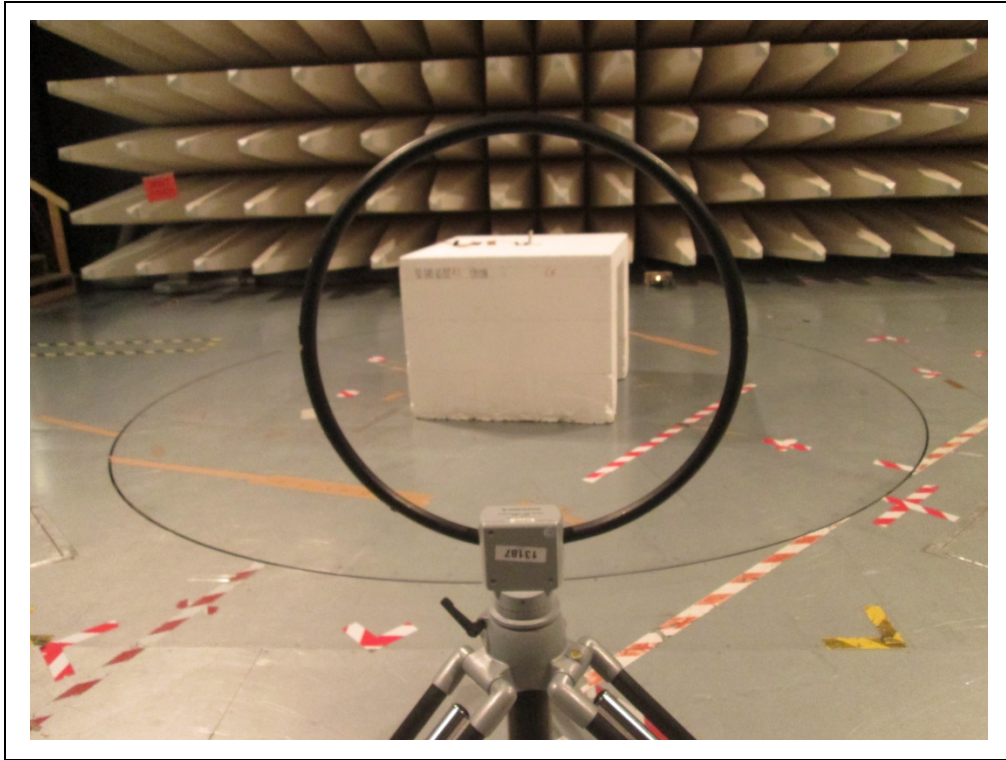

Photograph A1-5: Radiated emissions 9 kHz – 30 MHz at 3 m distance

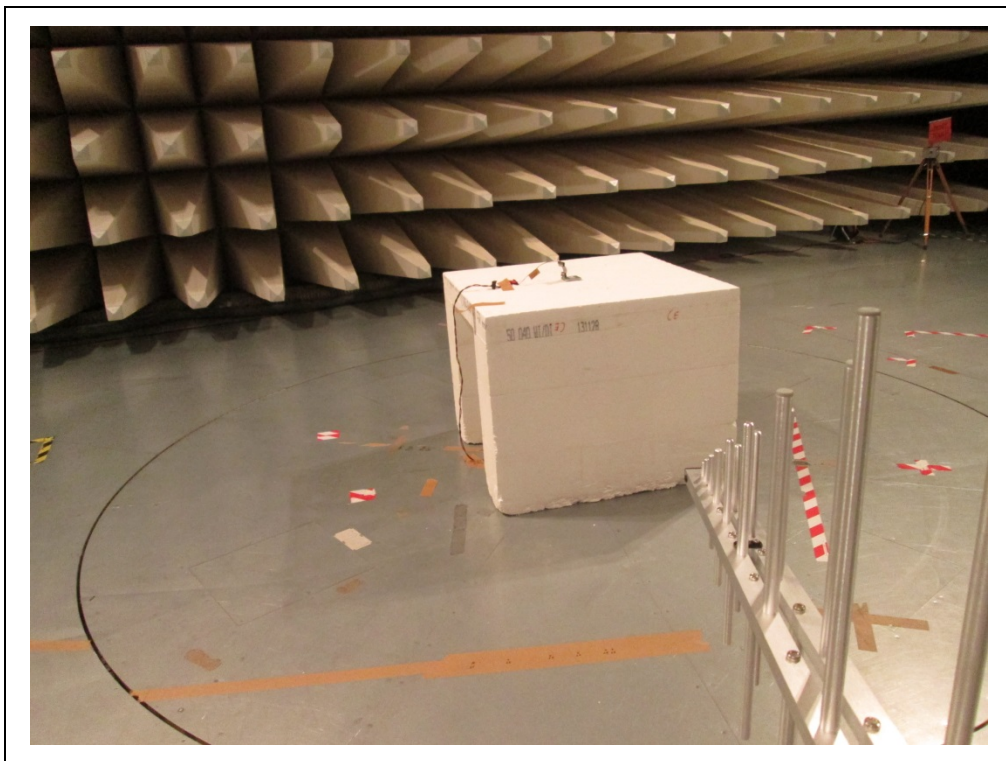

Photograph A1-6: Radiated emissions 30 – 1000 MHz at 3 m distance

Test on InnoSenT GmbH IPS-280 to 47 CFR § 15.245

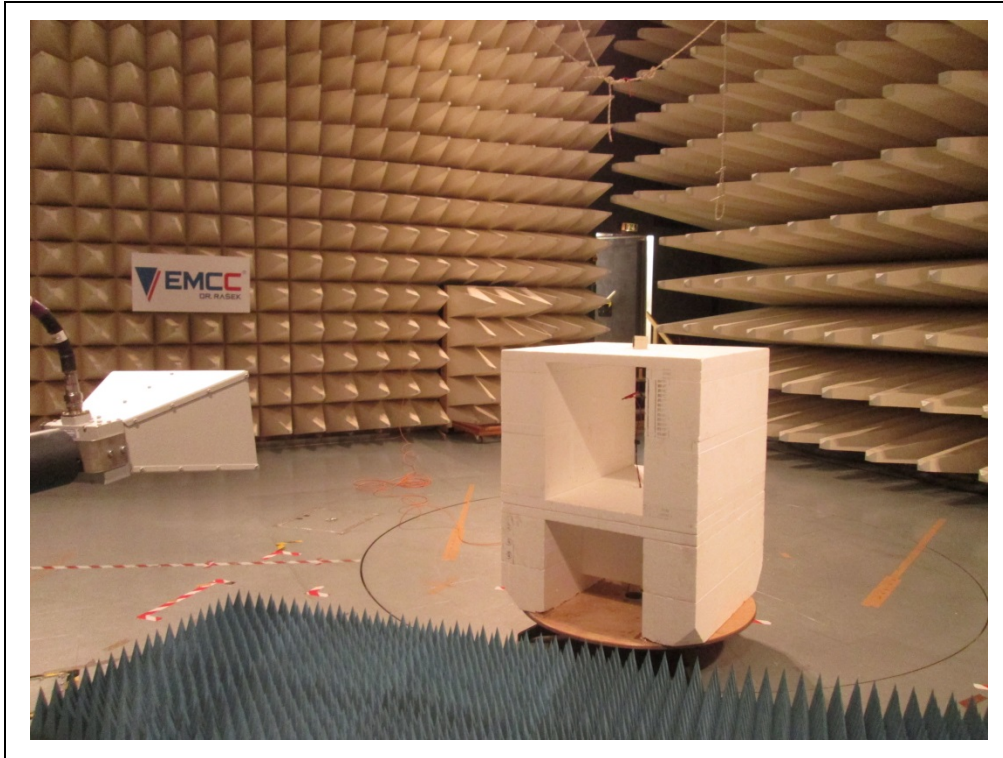

Photograph A1-7: Radiated emissions 1 – 6 GHz at 3 m distance

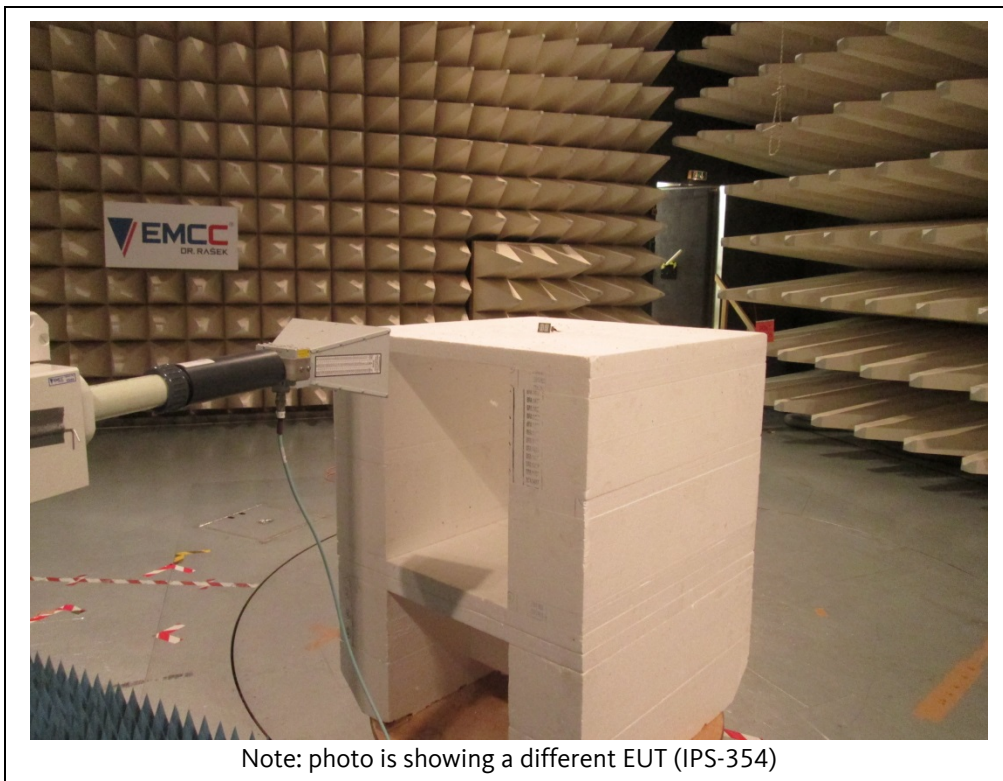

Note: photo is showing a different EUT (IPS-354)

Photograph A1-8: Sample setup photo of radiated emissions 6 – 18 GHz at 1 m distance

Test on InnoSenT GmbH IPS-280 to 47 CFR § 15.245

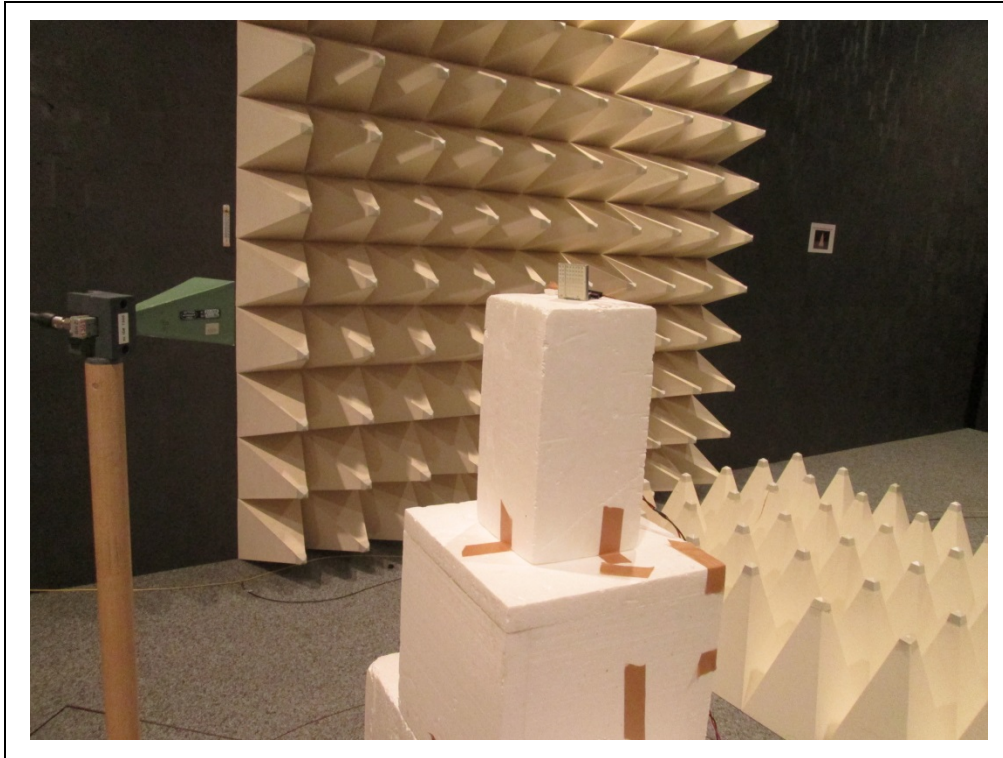

Photograph A1-9: Radiated emissions 18 – 26.5 GHz at 1 m distance

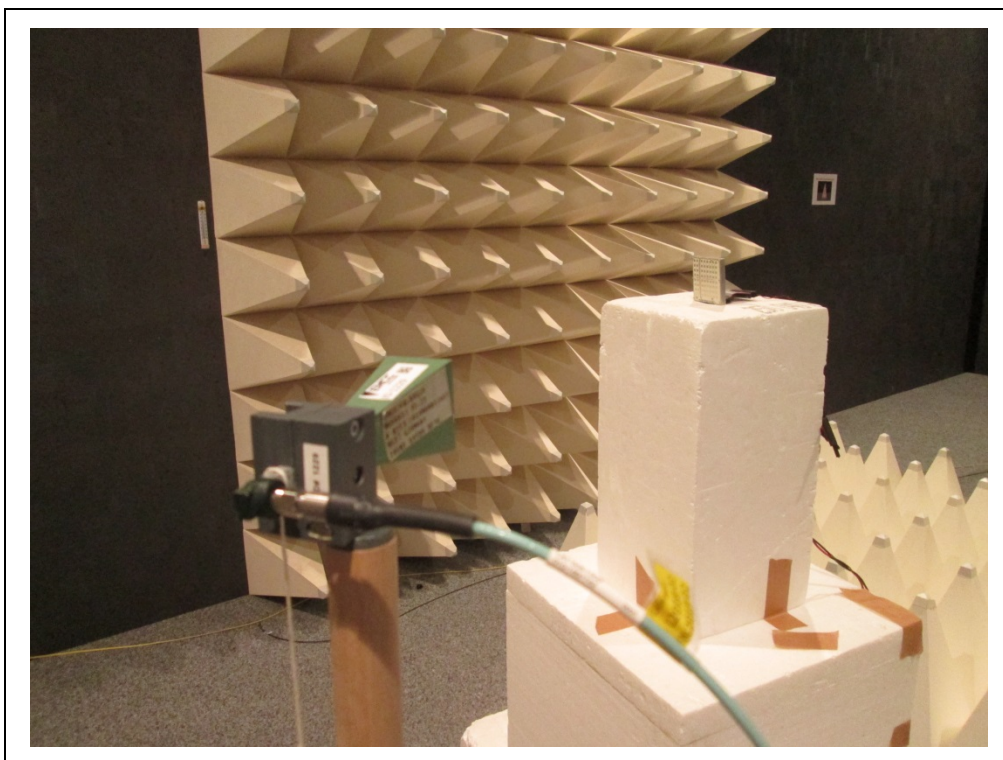

Photograph A1-10: Radiated emissions 26.5 – 40 GHz at 1 m distance

Test on InnoSenT GmbH IPS-280 to 47 CFR § 15.245

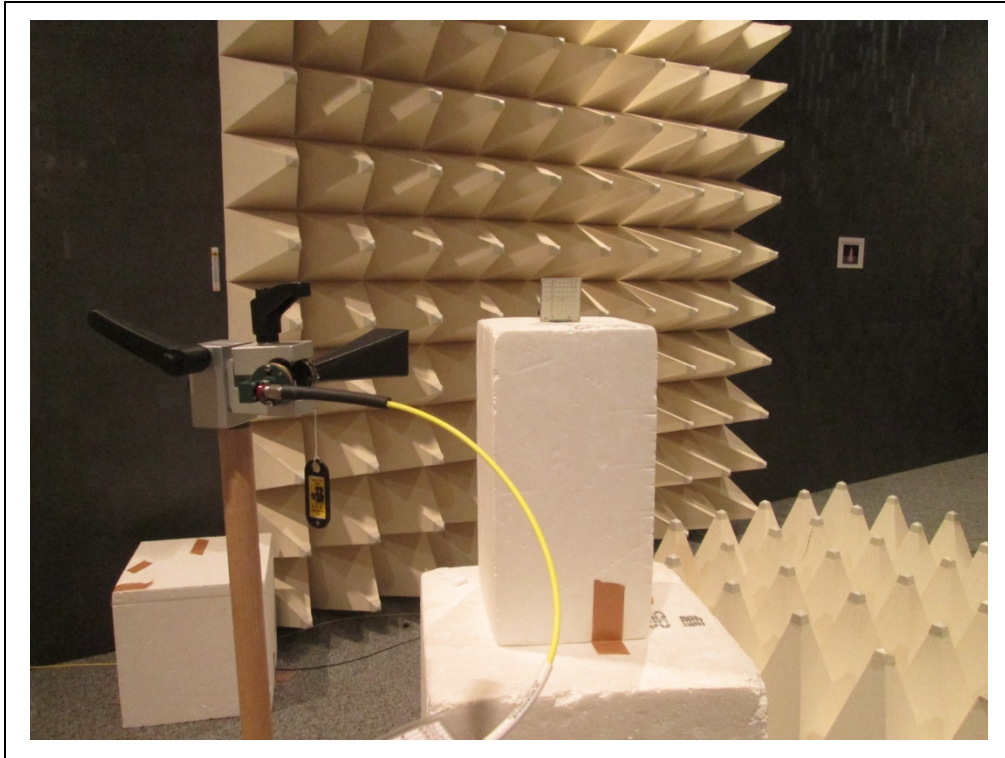

Photograph A1-11: Radiated emissions 40 – 50 GHz at 1 m distance

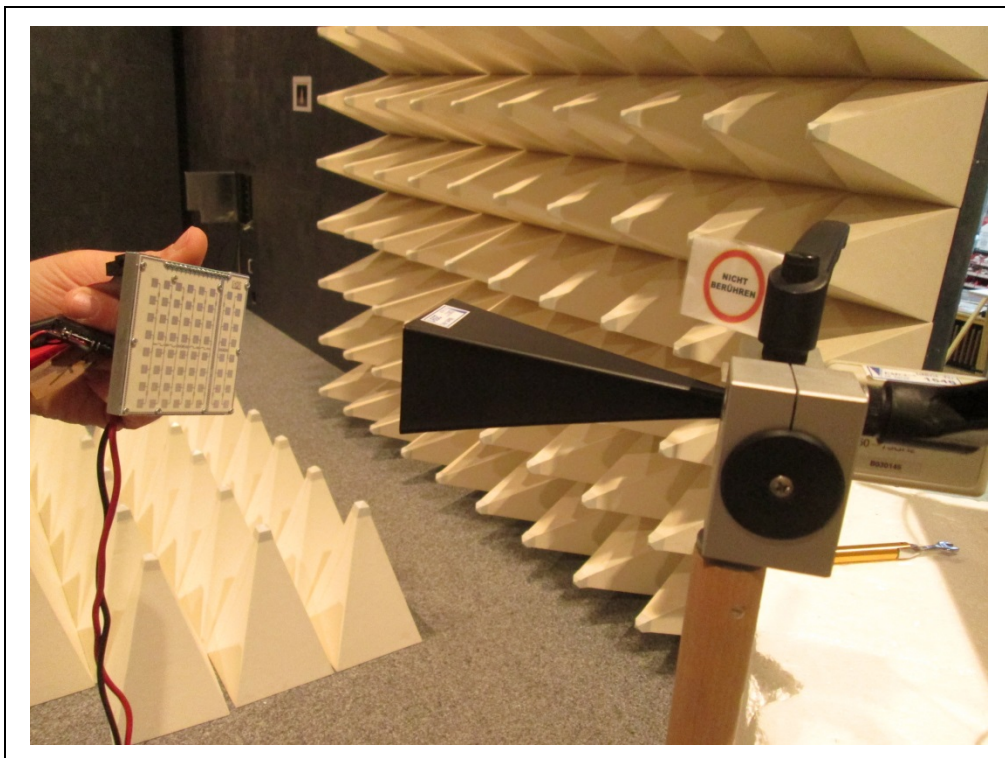

Photograph A1-12: Radiated emissions 50 – 75 GHz at close distance

Test on InnoSenT GmbH IPS-280 to 47 CFR § 15.245

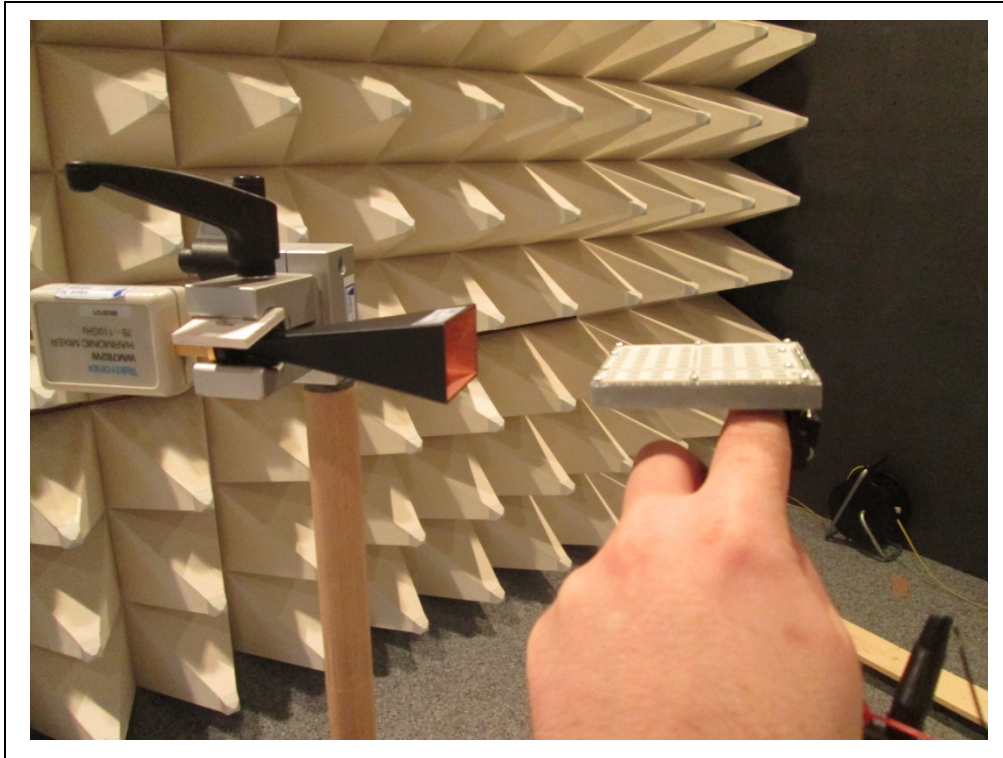

Photograph A1-13: Radiated emissions 75 – 100 GHz at close distance

ANNEX 2 TO TEST REPORT # EMCC-080534GAA, 2019-02-20

EXTERNAL PHOTOGRAPHS OF EQUIPMENT UNDER TEST

EQUIPMENT UNDER TEST:

| | |
|-------------------|---|
| Trade Name: | K-Band Transceiver |
| Type/Model: | IPS-280 |
| Serial Number(s): | 00001222 |
| Application: | K-Band Radar |
| FCC ID: | UXS-IPS280 |
| Manufacturer: | InnoSenT GmbH |
| Address: | Am Roedertor 30 97499 Donnersdorf GERMANY |
| Phone: | +49 9528 9518-1265 |
| E-Mail: | Barrett.Lee@innosent.de |

RELEVANT STANDARD(S) : 47 CFR § 15.245

MEASUREMENT PROCEDURE: : ANSI C63.10-2013

ILLUSTRATION LIST ANNEX 2

| | |
|----------------------------|---|
| Photograph A2-1: EUT front | 2 |
| Photograph A2-2: EUT back | 2 |
| Photograph A2-3: Connector | 3 |
| Photograph A2-4: Label | 3 |

Test on InnoSenT GmbH IPS-280 to 47 CFR § 15.245



Photograph A2-1: EUT front

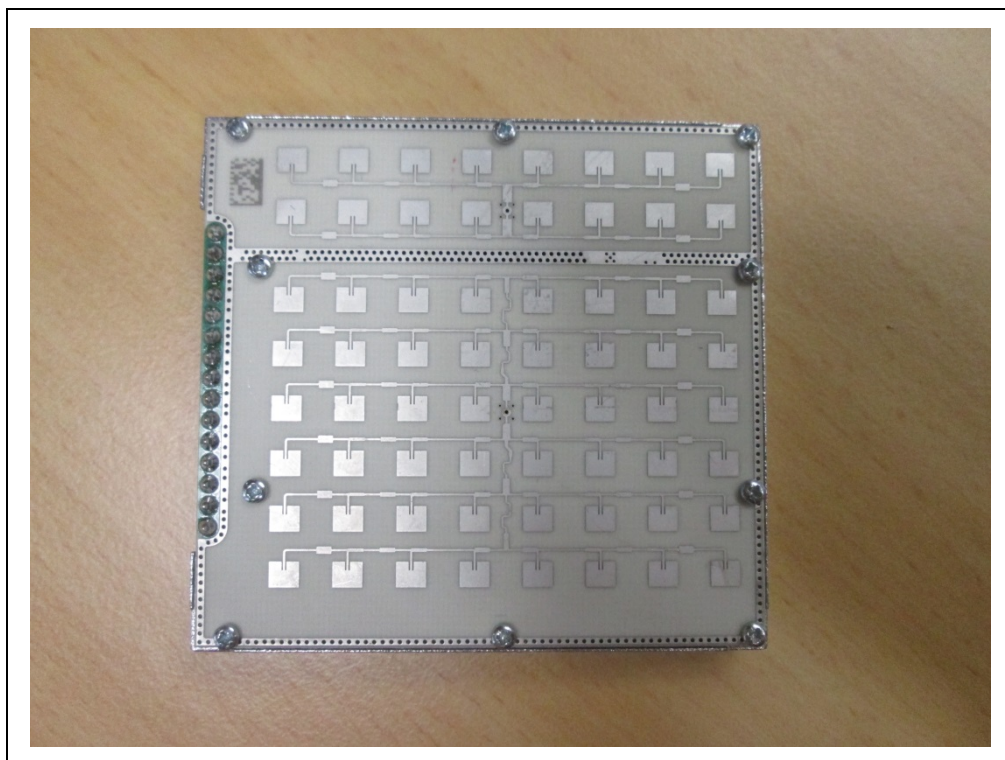

Photograph A2-2: EUT back

Test on InnoSenT GmbH IPS-280 to 47 CFR § 15.245



Photograph A2-3: Connector



Photograph A2-4: Label

ANNEX 3 TO TEST REPORT # EMCC-080534GAA, 2019-02-20

INTERNAL PHOTOGRAPHS OF EQUIPMENT UNDER TEST

EQUIPMENT UNDER TEST:

| | |
|-------------------|---|
| Trade Name: | K-Band Transceiver |
| Type/Model: | IPS-280 |
| Serial Number(s): | 00001222 |
| Application: | K-Band Radar |
| FCC ID: | UXS-IPS280 |
| Manufacturer: | InnoSenT GmbH |
| Address: | Am Roedertor 30 97499 Donnersdorf GERMANY |
| Phone: | +49 9528 9518-1265 |
| E-Mail: | Barrett.Lee@innosent.de |

RELEVANT STANDARD(S) : 47 CFR § 15.245

MEASUREMENT PROCEDURE: : ANSI C63.10-2013

ILLUSTRATION LIST ANNEX 3

| | |
|---|---|
| Photograph A3-1: Top internal view | 2 |
| Photograph A3-2: Bottom view of PCB (Antenna) | 2 |

Test on InnoSenT GmbH IPS-280 to 47 CFR § 15.245

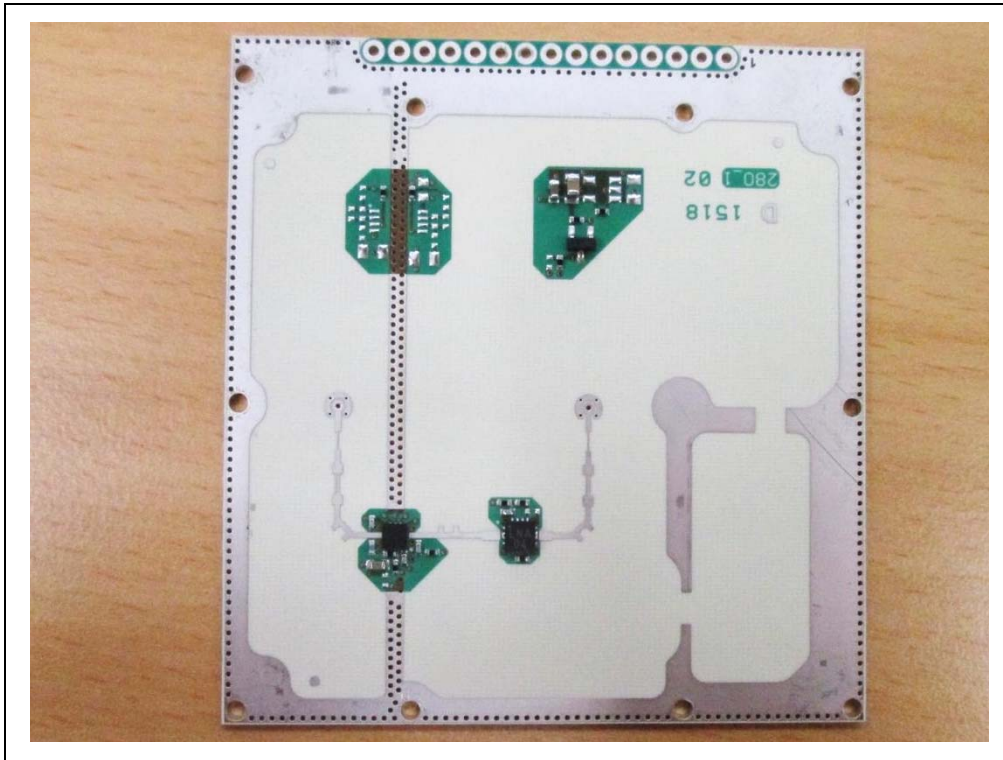

Photograph A3-1: Top internal view

Photo taken from different sample (SN 00001266) with opened cover, which was provided by customer, hence opening the original sample was not possible due to being sealed. This sample was not used for testing.

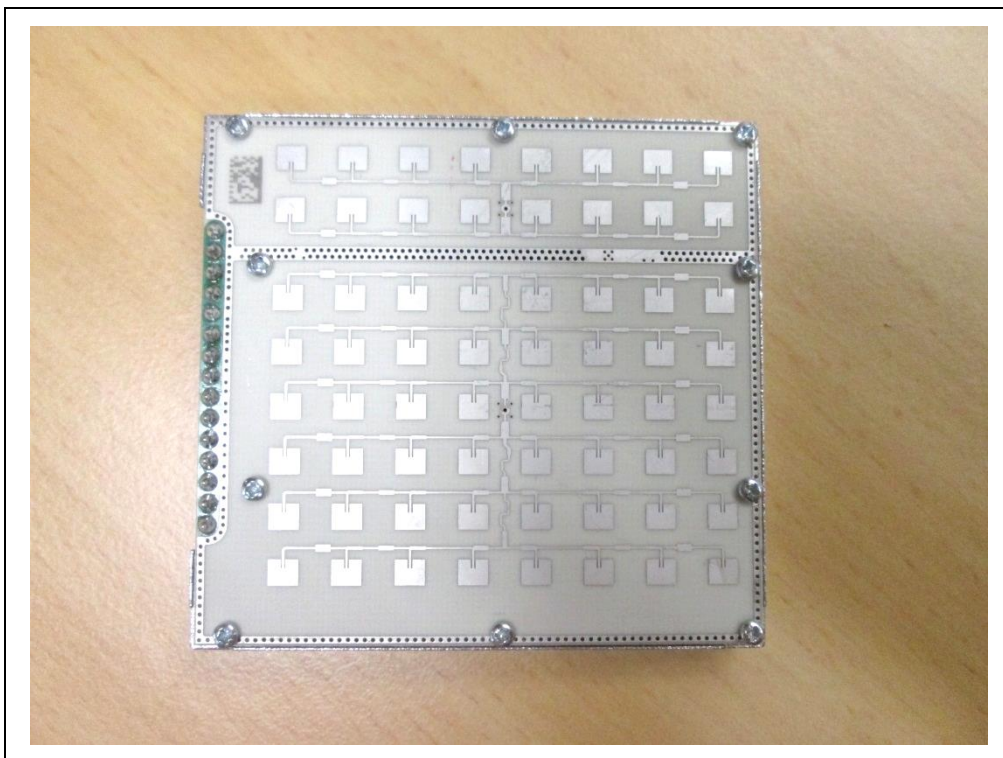

Photograph A3-2: Bottom view of PCB (Antenna)

ANNEX 4 TO TEST REPORT # EMCC-080534GAA, 2019-02-20

PHOTOGRAPHS OF ANCILLARY EQUIPMENT

EQUIPMENT UNDER TEST:

| | |
|-------------------|---|
| Trade Name: | K-Band Transceiver |
| Type/Model: | IPS-280 |
| Serial Number(s): | 00001222 |
| Application: | K-Band Radar |
| FCC ID: | UXS-IPS280 |
| Manufacturer: | InnoSenT GmbH |
| Address: | Am Roedertor 30 97499 Donnersdorf GERMANY |
| Phone: | +49 9528 9518-1265 |
| E-Mail: | Barrett.Lee@innosent.de |

RELEVANT STANDARD(S) : 47 CFR § 15.245

MEASUREMENT PROCEDURE: : ANSI C63.10-2013

ILLUSTRATION LIST ANNEX 4

Photograph A4-1: Power supply adaptor

2

Test on InnoSenT GmbH IPS-280 to 47 CFR § 15.245

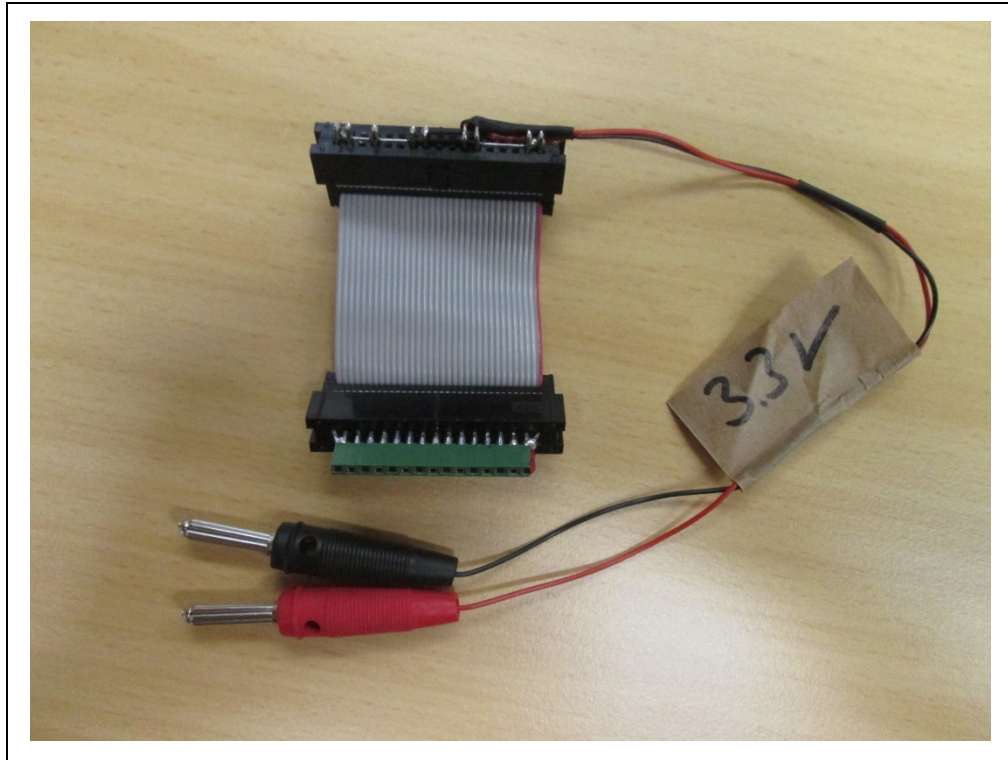

Photograph A4-1: Power supply adaptor