

TEST REPORT

Test report no.: 1-3699-01-02/11



Testing laboratory

CETECOM ICT Services GmbH
Untertuerkheimer Strasse 6 – 10
66117 Saarbruecken / Germany
Phone: + 49 681 5 98 - 0
Fax: + 49 681 5 98 - 9075
Internet: <http://www.cetecom.com>
e-mail: ict@cetecom.com

Accredited test laboratory:
The test laboratory (area of testing) is accredited according to DIN EN ISO/IEC 17025
DAkKS registration number: D-PL-12076-01-01
Area of Testing: Radio/Satellite Communications

Applicant

InnoSenT GmbH
Am Rödertor 30
97499 Donnersdorf / Germany
Phone: +49 952 895-1871
Fax: +49 952 895-1899
Contact: Stefan Bäuerlein
e-mail: stefan.baeuerlein@innosent.de
Phone: +49 952 895-1871

Manufacturer

InnoSenT GmbH
Am Rödertor 30
97499 Donnersdorf / Germany

Test standard/s

47 CFR Part 15	Title 47 of the Code of Federal Regulations; Chapter I Part 15 - Radio frequency devices
RSS - 210 Issue 8	Spectrum Management and Telecommunications - Radio Standards Specification Low-power Licence-exempt Radiocommunication Devices (All Frequency Bands): Category I Equipment

For further applied test standards please refer to section 3 of this test report.

Test item

Kind of test item:	K-Band Transceiver
Model name:	IPM-224
FCC ID:	UXS-IPM224F
IC:	6902A-IPM224F
Frequency:	24.125 GHz
Power supply:	5.00 V DC from power supply
Temperature range:	0 °C to +60 °C



This test report is electronically signed and valid without handwriting signature. For verification of the electronic signatures, the public keys can be requested at the testing laboratory.

Test performed:



Meheza Walla

Test report authorised:



Karsten Gerdaldy

1 Table of contents	
1	Table of contents2
2	General information3
2.1	Notes.....3
2.2	Application details.....3
3	Test standard/s3
4	Test environment.....3
5	Test item4
6	Test laboratories sub-contracted4
7	Summary of measurement results5
8	RF measurement testing.....6
8.1	Description of test setup6
8.1.1	Radiated measurements.....6
8.1.2	Additional comments7
8.2	RSP100 test report cover sheet / performance test data8
9	Measurement results.....9
9.1	Field strength of emissions (wanted signal)9
9.2	Occupied bandwidth (99% bandwidth)11
9.3	Field strength of emissions (radiated spurious).....13
9.4	Conducted spurious emissions < 30 MHz21
10	Test equipment and ancillaries used for tests23
Annex A	Photographs of the test setup24
Annex B	External photographs of the EUT27
Annex C	Document history31
Annex D	Further information.....31

2 General information

2.1 Notes

The test results of this test report relate exclusively to the test item specified in this test report. CETECOM ICT Services GmbH does not assume responsibility for any conclusions and generalisations drawn from the test results with regard to other specimens or samples of the type of the equipment represented by the test item. The test report may only be reproduced or published in full. Reproduction or publication of extracts from the report requires the prior written approval of CETECOM ICT Services GmbH.

This test report is electronically signed and valid without handwriting signature. For verification of the electronic signatures, the public keys can be requested at the testing laboratory.

2.2 Application details

Date of receipt of order:	2011-07-11
Date of receipt of test item:	2011-08-03
Start of test:	2011-08-04
End of test:	2011-08-10
Person(s) present during the test:	-/-

3 Test standard/s

Test standard	Version	Test standard description
47 CFR Part 15	2010-10-01	Title 47 of the Code of Federal Regulations; Chapter I Part 15 - Radio frequency devices
RSS - 210 Issue 8	2010-12-01	Spectrum Management and Telecommunications - Radio Standards Specification Low-power Licence-exempt Radiocommunication Devices (All Frequency Bands): Category I Equipment

4 Test environment

Temperature:	T_{nom}	+22 °C during room temperature tests
Relative humidity content:		45 %
Air pressure:		not relevant for this kind of testing
Power supply:	V_{nom}	5.00 V DC from power supply
	V_{max}	5.25 V
	V_{min}	4.75 V

5 Test item

Kind of test item	:	K-Band Transceiver
Type identification	:	IPM-224
S/N serial number	:	22400001
HW hardware status	:	-/-
SW software status	:	-/-
Frequency band [MHz]	:	24.075 GHz - 24.175 GHz
Type of modulation	:	-/-
Number of channels	:	1
Antenna	:	integrated patch antenna
Power supply	:	5.0 V DC from power supply
Temperature range	:	0°C to +60 °C

6 Test laboratories sub-contracted

None

7 Summary of measurement results

- No deviations from the technical specifications were ascertained
- There were deviations from the technical specifications ascertained

TC Identifier	Description	Verdict	Date	Remark
RF-Testing	47 CFR Part 15 RSS 210, Issue 8, Annex 8	Passed	2011-09-21	-/-

Test specification clause	Test case	Temperature conditions	Power source voltages	Pass	Fail	NA	NP	Results (max.)
§15.245(b) RSS 210 / A7.1	Field strength of emissions (wanted signal)	Nominal	Nominal	<input checked="" type="checkbox"/>	<input type="checkbox"/>	<input type="checkbox"/>	<input type="checkbox"/>	109.7 dBµV
§2.1049	Occupied bandwidth (99% bandwidth)	Nominal	Nominal	<input checked="" type="checkbox"/>	<input type="checkbox"/>	<input type="checkbox"/>	<input type="checkbox"/>	436.7 kHz
§15.209(a) / §15.245(b)(1)(2)(3) RSS 210 / A7.1-4	Field strength of emissions (spurious)	Nominal	Nominal	<input checked="" type="checkbox"/>	<input type="checkbox"/>	<input type="checkbox"/>	<input type="checkbox"/>	complies
§15.207(a) ICES-003	Conducted emissions < 30 MHz	Nominal	Nominal	<input checked="" type="checkbox"/>	<input type="checkbox"/>	<input type="checkbox"/>	<input type="checkbox"/>	complies

Note: NA = Not Applicable; NP = Not Performed

8 RF measurement testing

8.1 Description of test setup

8.1.1 Radiated measurements

The radiated measurements are performed in vertical and horizontal plane in the frequency range from 9 kHz to 25 GHz in semi-anechoic chambers. The EUT is positioned on a non-conductive support with a height of 0.80 m above a conductive ground plane that covers the whole chamber. The receiving antennas are confirmed with specifications ANSI C63.2-1996 clause 15 and ANSI C63.4-2009 clause 4.1.5. These antennas can be moved over the height range between 1.0 m and 4.0 m in order to search for maximum field strength emitted from EUT. The measurement distances between EUT and receiving antennas are indicated in the test setups for the various frequency ranges. For each measurement, the EUT is rotated in all three axes until the maximum field strength is received. The wanted and unwanted emissions are received by spectrum analyzers where the detector modes and resolution bandwidths over various frequency ranges are set according to requirement ANSI C63-4-2009 clause 4.2.

Antennas are confirmed with ANSI C63.2-1996 item 15.

Semi anechoic chamber

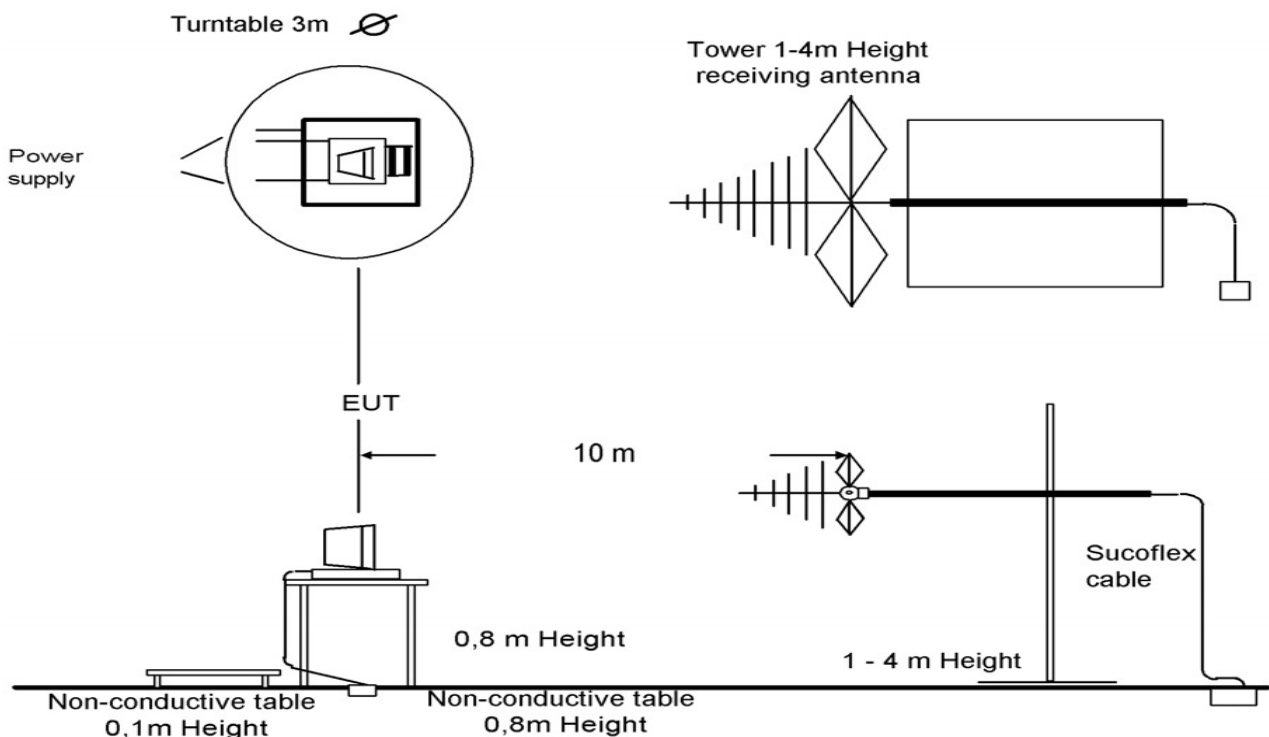

Picture 1: Diagram radiated measurements

9 kHz - 30 MHz:	active loop antenna
30 MHz – 1 GHz:	tri-log antenna
> 1 GHz:	horn antenna

The EUT is powered by an external power supply with nominal voltage

8.1.2 Additional comments

Reference documents: None

Special test descriptions: None

Configuration descriptions: None

Test mode: Normal operation, no special test mode available.

Special software was used.

8.2 RSP100 test report cover sheet / performance test data

Test report number	:	1-3699-01-02/11
Equipment model number	:	IPM-224
Certification number	:	6902A-IPM224F
Manufacturer (complete address)	:	InnoSenT GmbH Am Rödertor 30 97499 Donnersdorf / Germany
Tested to radio standards specification no.	:	RSS 210, Issue 8, Annex 7
Open area test site IC No.	:	IC 3462C-1
Frequency range	:	24.075 GHz to 24.175 GHz
RF-field strength [dB μ V] (max.)	:	109.7 dB μ V
Occupied bandwidth (99%-BW)	:	436.7 kHz
Type of modulation	:	-/-
Emission designator (TRC-43)	:	436k7N0N
Antenna information	:	Integrated patch antenna array
Transmitter spurious (worst case)	:	67.9 dB μ V/m (2 nd harmonic)
Receiver spurious (worst case)	:	n.a. - no receiver mode

ATTESTATION:
DECLARATION OF COMPLIANCE:

I attest that the testing was performed or supervised by me; that the test measurements were made in accordance with the above-mentioned Industry Canada standard(s); and that the equipment identified in this application has been subjected to all the applicable test conditions specified in the Industry Canada standards and all of the requirements of the standard have been met.

Laboratory manager:

2011-09-21
Date

Meheza Walla
Name

Signature

9 Measurement results

9.1 Field strength of emissions (wanted signal)

Description:

Measurement of the maximum radiated field strength of the wanted signal.

Measurement:

Measurement parameter	
Detector:	Pos-Peak
Sweep time:	Auto
Video bandwidth:	Auto
Resolution bandwidth:	1 MHz
Span:	max. 100 MHz
Trace-Mode:	Max Hold

Limits:

FCC		IC	
CFR Part 15.245(b)		RSS - 210, Annex 7	
Field strength of emissions			
The field strength of emissions from intentional radiators operated within these frequency bands shall comply with the following:			
Frequency [GHz]	Field Strength [mV/m / dB μ V/m]	Measurement distance	
24075 – 24175	2500 / 128	3	

Result:

TEST CONDITIONS	Maximum field strength		
	Frequency [GHz]	Field strength E [mV/m] @ 3 m	Field strength e [dB μ V/m] @ 3 m
T _{nom} / V _{nom}	24.1243	305.5	109.7
Measurement uncertainty	± 3 dB		

Result: The measurement is passed.

Plot 1:

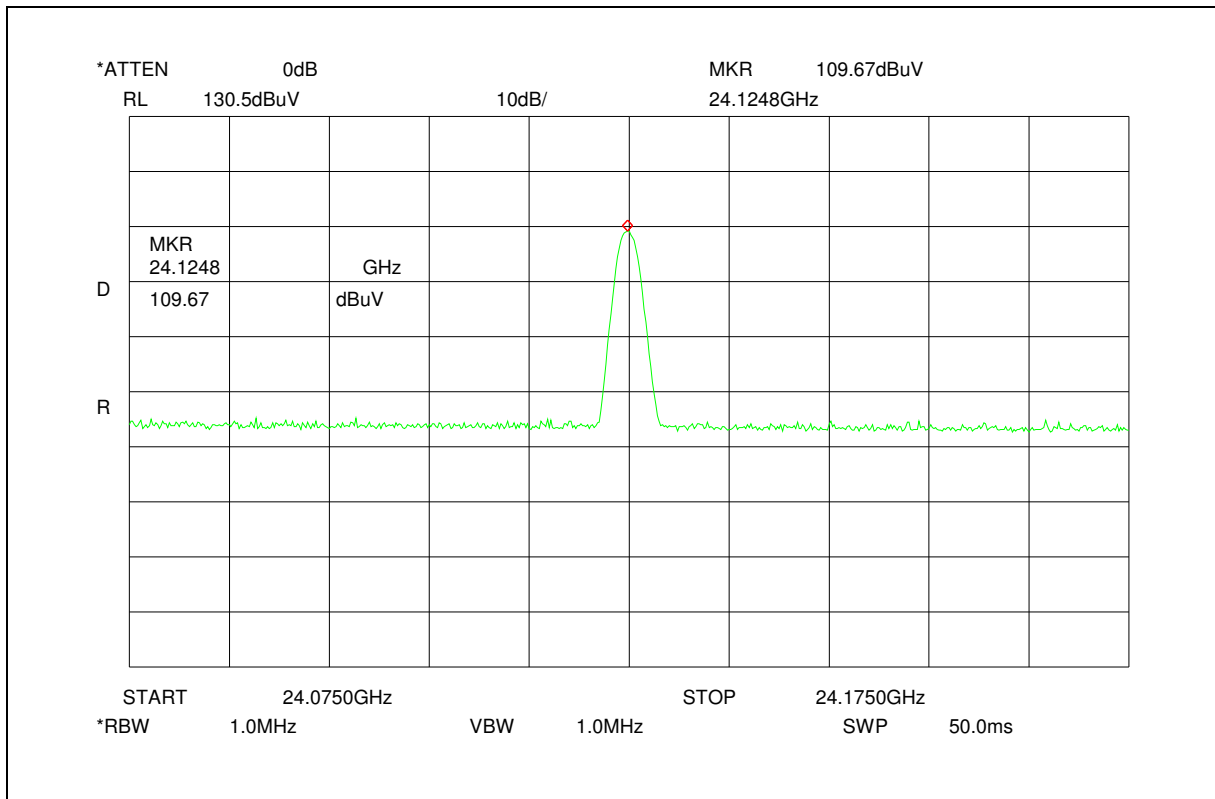

Plot 2:

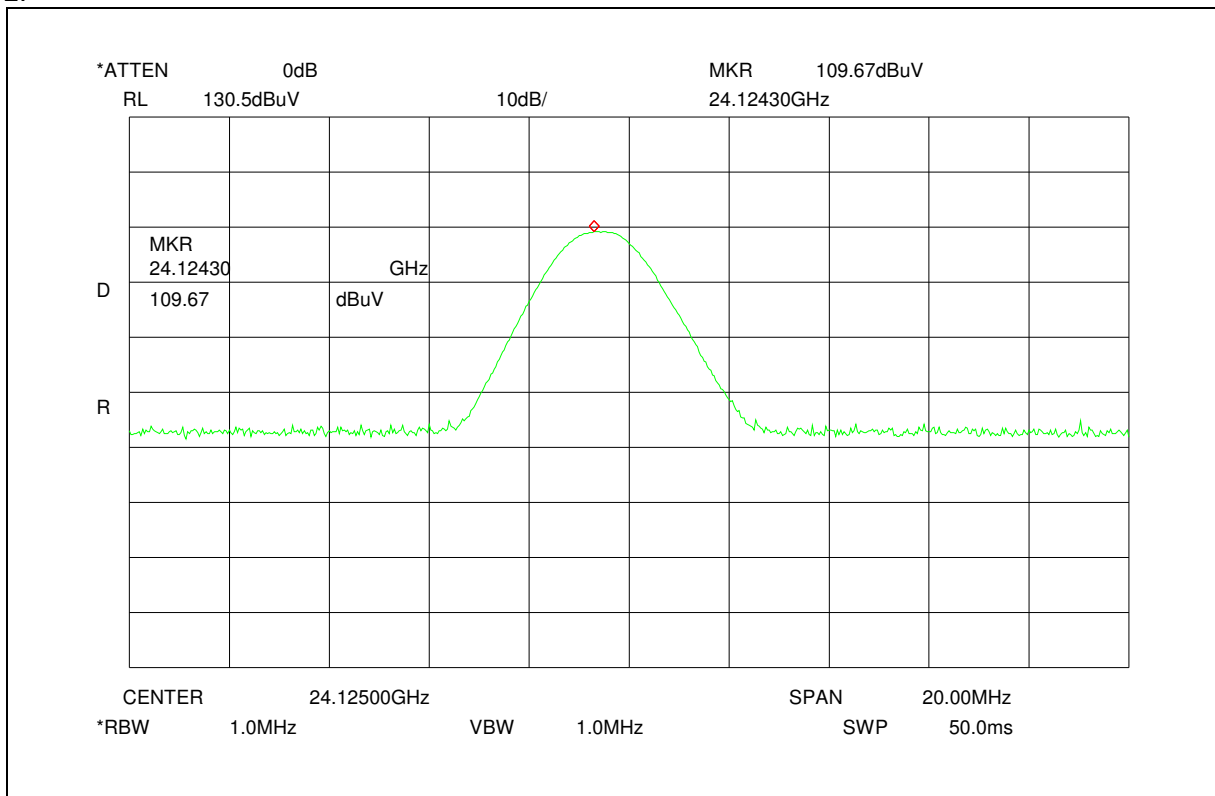

9.2 Occupied bandwidth (99% bandwidth)

Description:

Measurement of the 99% bandwidth of the wanted signal.

Measurement:

Measurement parameter	
Detector:	Peak
Sweep time:	Auto
Video bandwidth:	100 kHz
Resolution bandwidth:	100 kHz
Span:	8 MHz
Trace-Mode:	Max Hold

Results:

TEST CONDITIONS	Occupied bandwidth		
	Frequency [GHz]	Occupied bandwidth [kHz]	see plot no.
$T_{nom} / V_{min} - V_{max}$	24.123	436.7	3 - 4
Measurement uncertainty	± 3 dB		

Note:

When measuring the 99% occupied bandwidth the power supply voltage was varied from 4.75 V_{DC} to 5.25 V_{DC}.

Result: The measurement is passed.

Plot 3: (with fixed power supply voltage: 5.0 V_{DC})

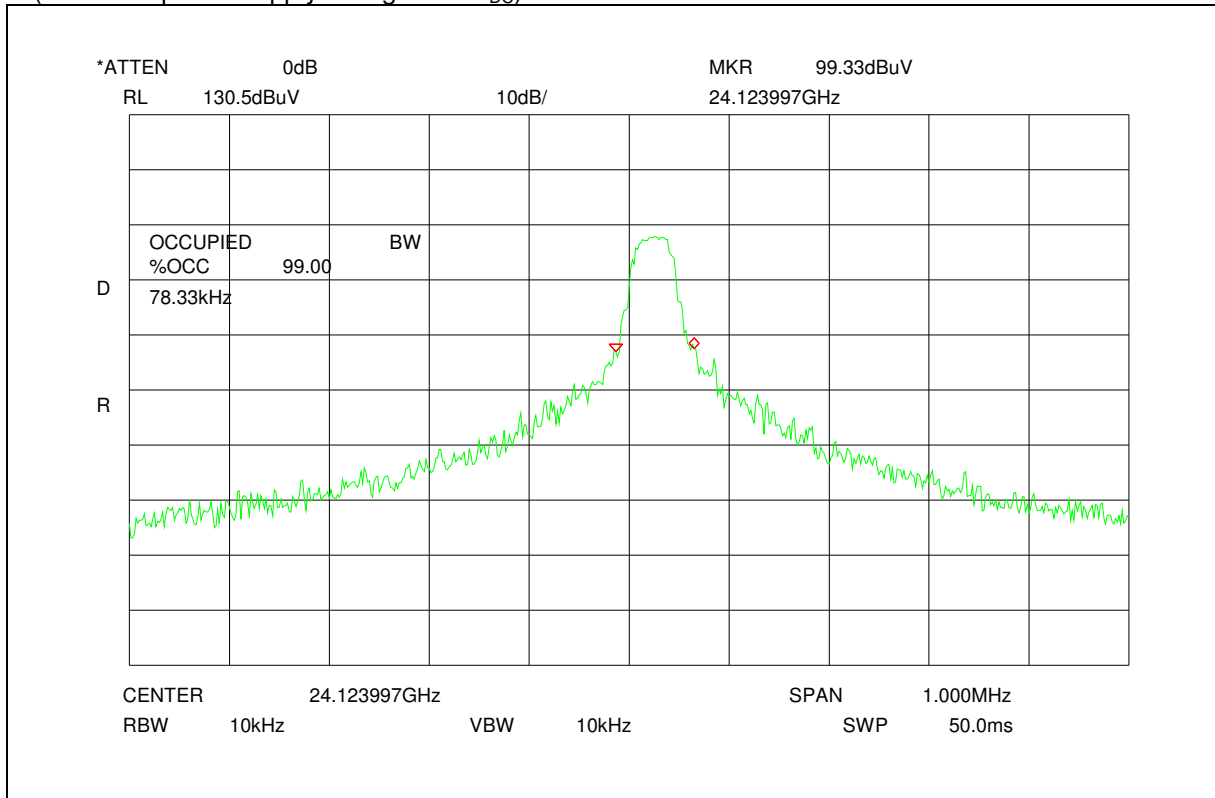

Plot 4: (with variation of power supply voltage: 4.75 V_{DC} - 5.25 V_{DC})

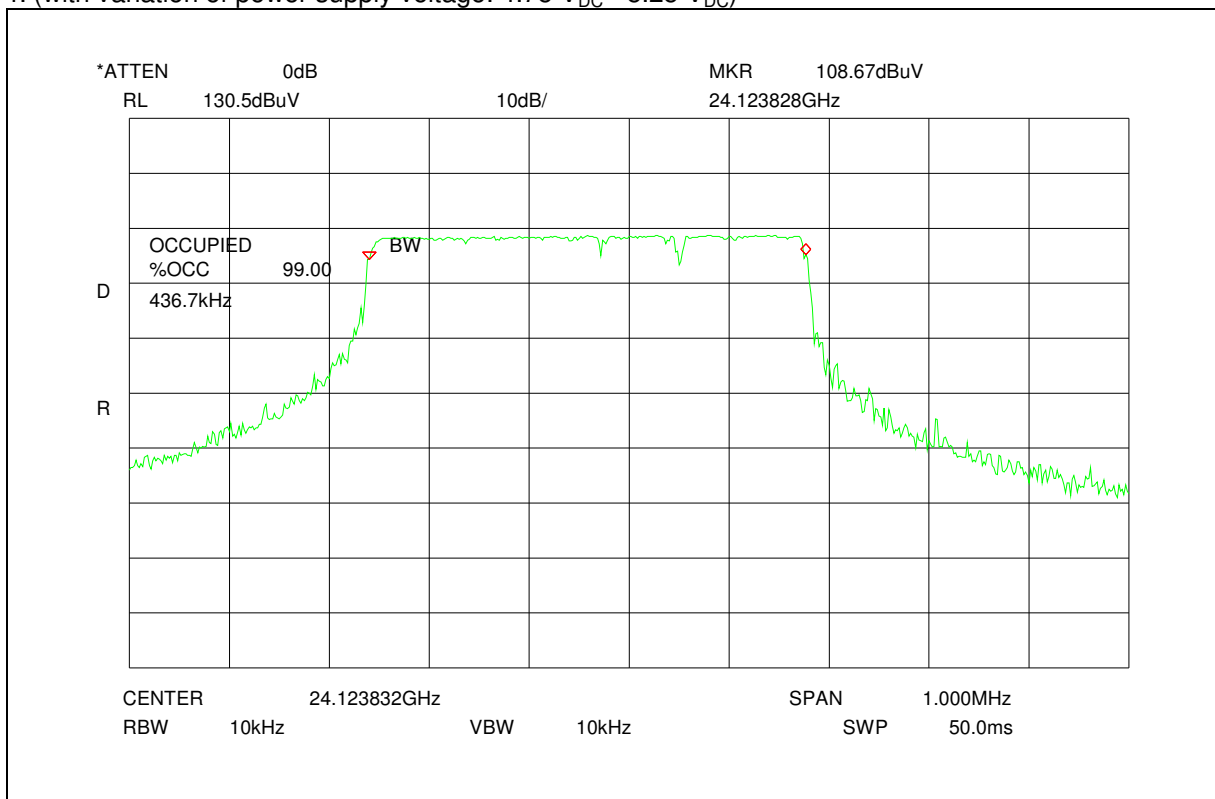

9.3 Field strength of emissions (radiated spurious)

Description:

Measurement of the radiated spurious emissions in transmit mode.

Measurement:

Measurement parameter	
Detector:	Peak / Quasi Peak
Sweep time:	Auto
Video bandwidth:	Auto
Resolution bandwidth:	F < 1 GHz: 100 kHz F > 1 GHz: 1 MHz
Frequency range:	30 MHz to 100 GHz
Trace-Mode:	Max Hold

Limits:

FCC		IC	
CFR Part 15.209(a)		RSS - GEN	
Radiated Spurious Emissions			
Emissions radiated outside of the specified frequency bands, except for harmonics, shall be attenuated by at least 50 dB below the level of the fundamental or to the general radiated emission limits in § 15.209, whichever is the lesser attenuation.			
Frequency (MHz)	Field Strength (dB μ V/m)	Measurement distance	
0.009 – 0.490	2400/F(kHz)	300	
0.490 – 1.705	24000/F(kHz)	30	
1.705 – 30.0	30	30	
30 – 88	30.0	10	
88 – 216	33.5	10	
216 – 960	36.0	10	
Above 960	54.0	3	

Results:

TX Spurious Emissions Radiated [dB μ V/m]								
Lowest			Middle			Highest		
Frequency [GHz]	Detector	Level [dB μ V/m]	Frequency [GHz]	Detector	Level [dB μ V/m]	Frequency [GHz]	Detector	Level [dB μ V/m]
No critical peaks found!			48.248	AVG	67.9	No critical peaks found!		
			72.372	Peak	53.8			
Measurement uncertainty			± 3 dB					

Result: The measurement is passed.

Plot 5: 9 kHz - 30 MHz

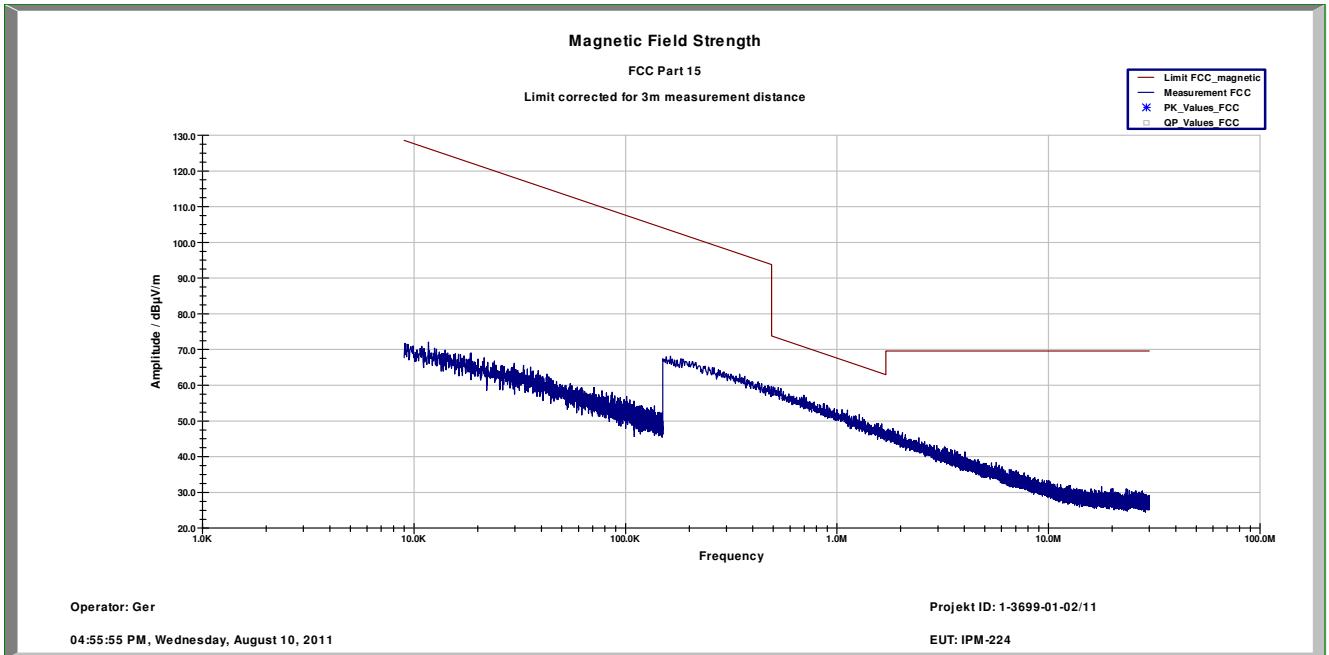

Plot 6: 30 MHz to 1 GHz, horizontal/vertical polarization

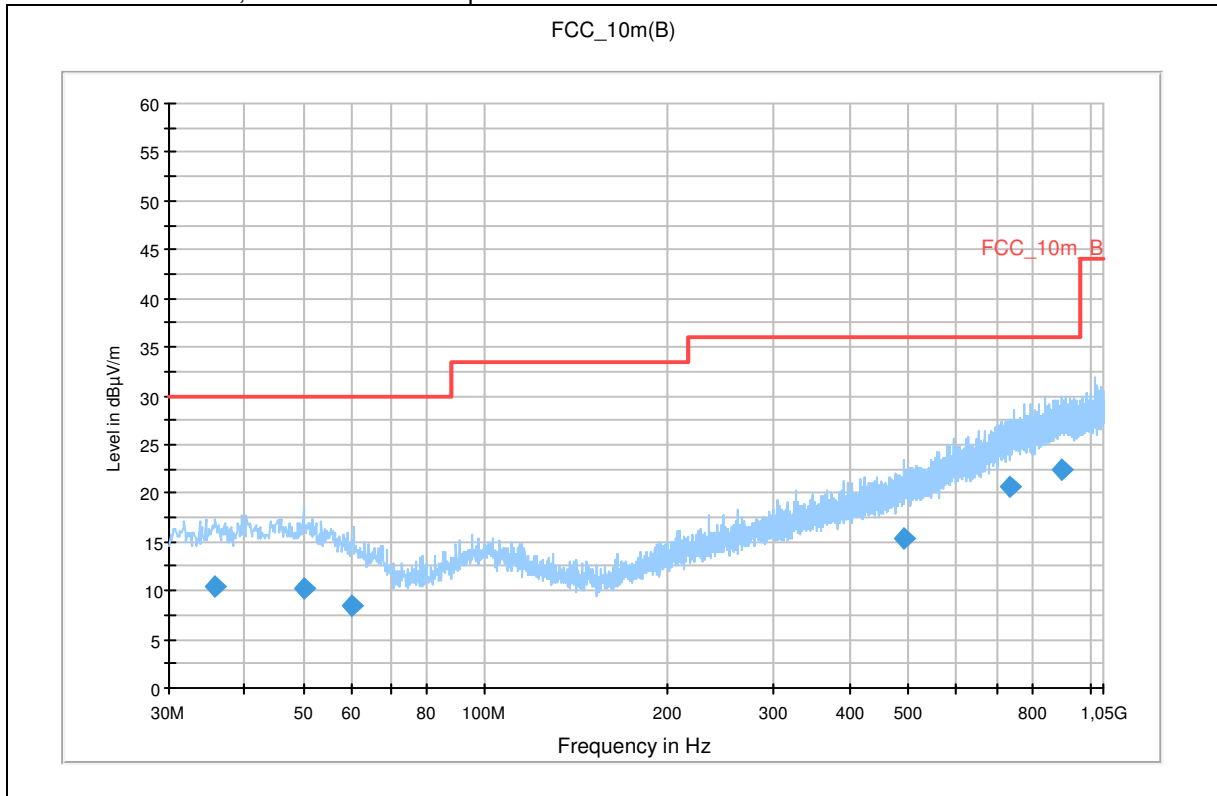

Plot 7: 1 GHz to 12 GHz, horizontal/vertical polarization

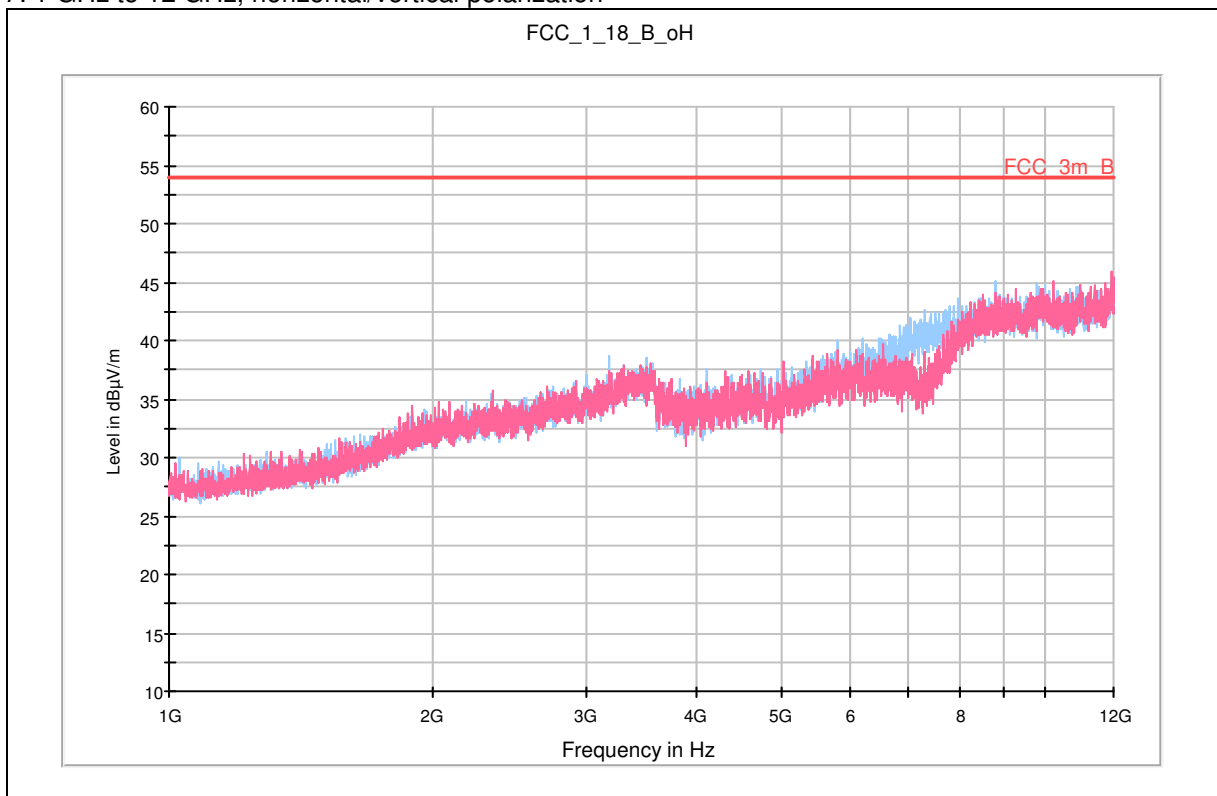

Plot 8: 12 GHz to 18 GHz, horizontal / vertical polarization

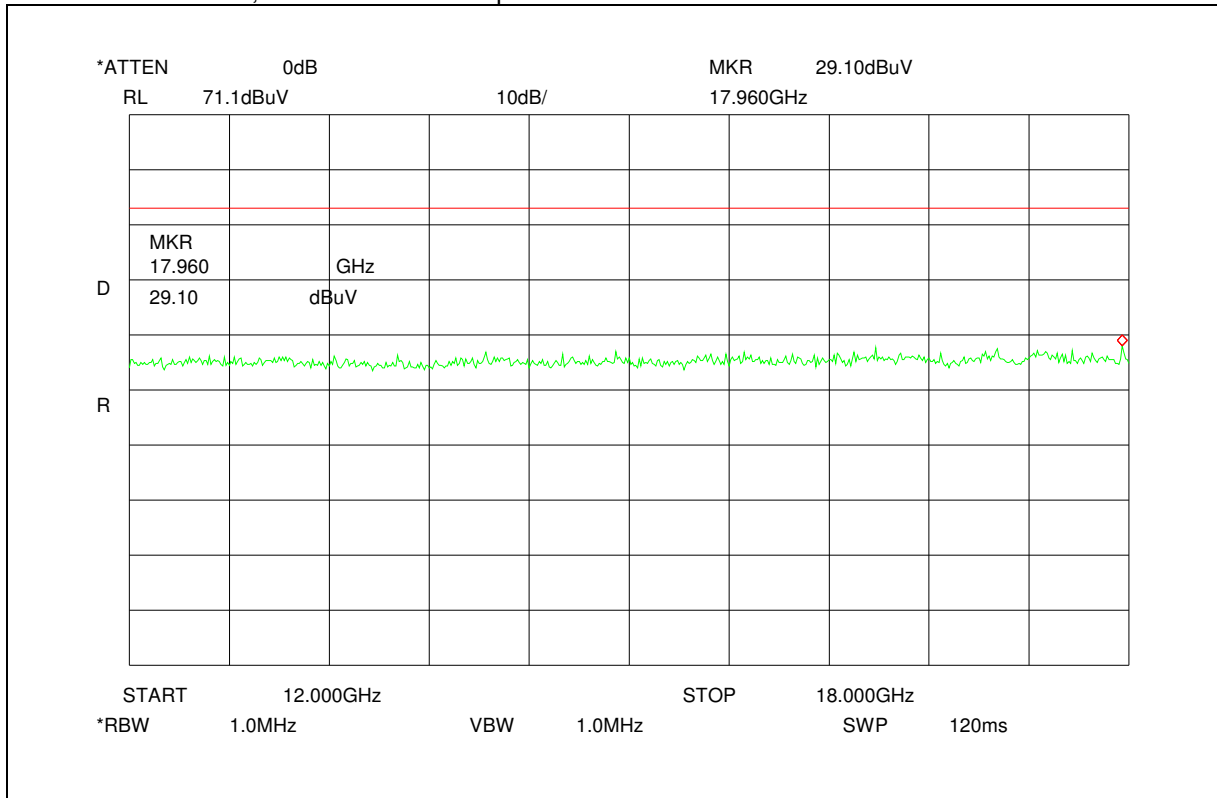

Plot 9: 18 GHz to 26 GHz, horizontal / vertical polarization (plot shows wanted signal)

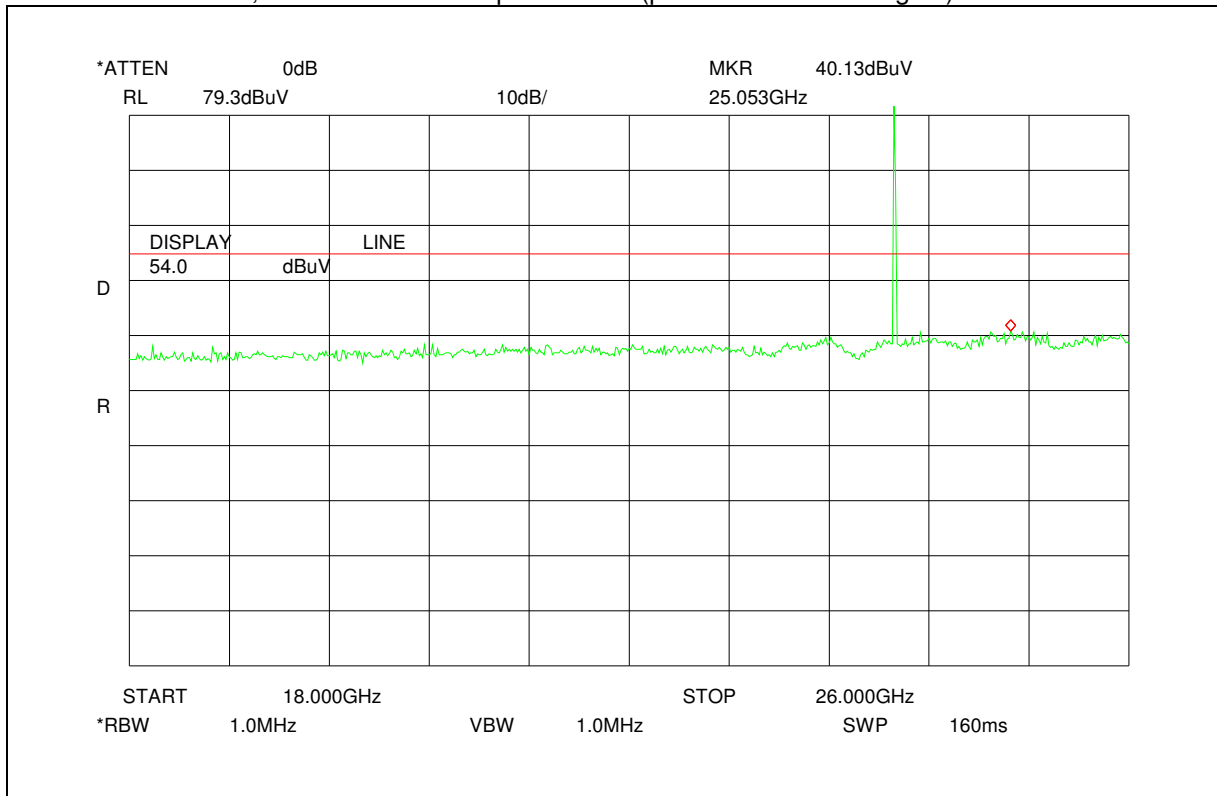

Plot 10: 26 GHz to 40 GHz, horizontal / vertical polarization

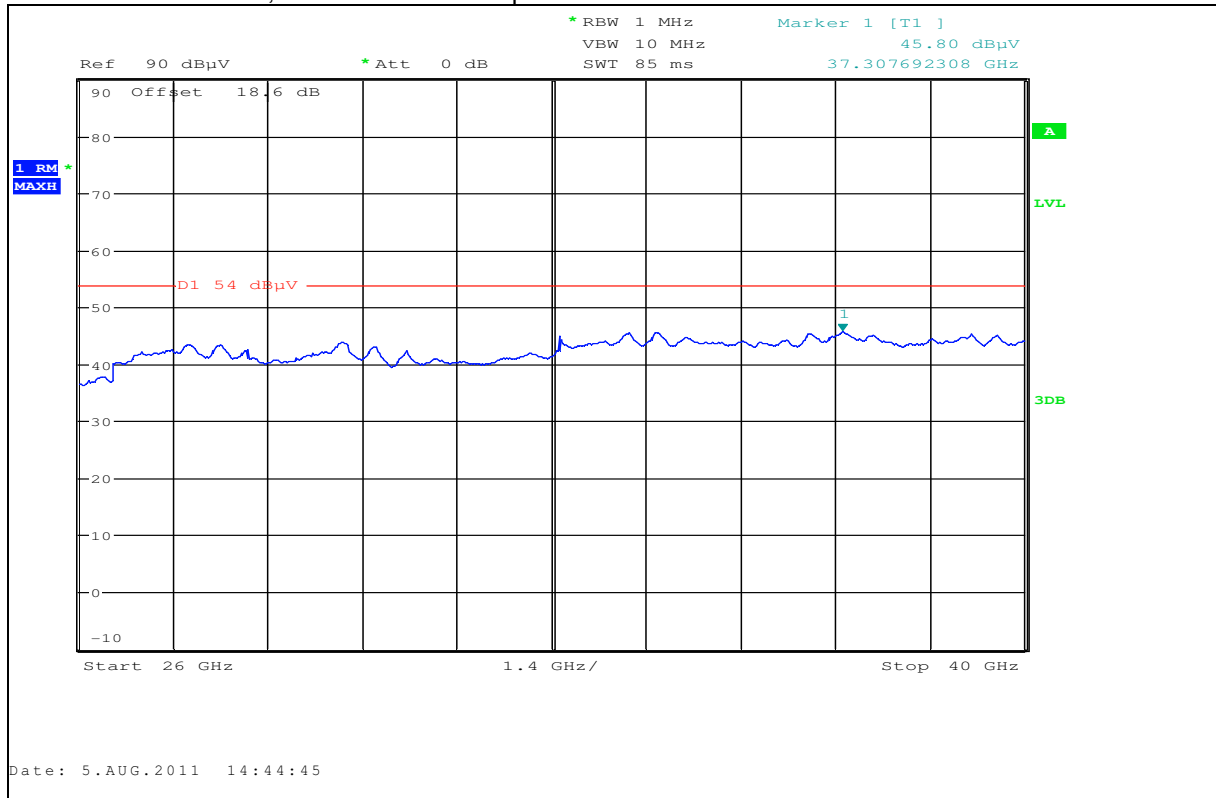

Plot 11: 40 GHz to 50 GHz, horizontal / vertical polarization

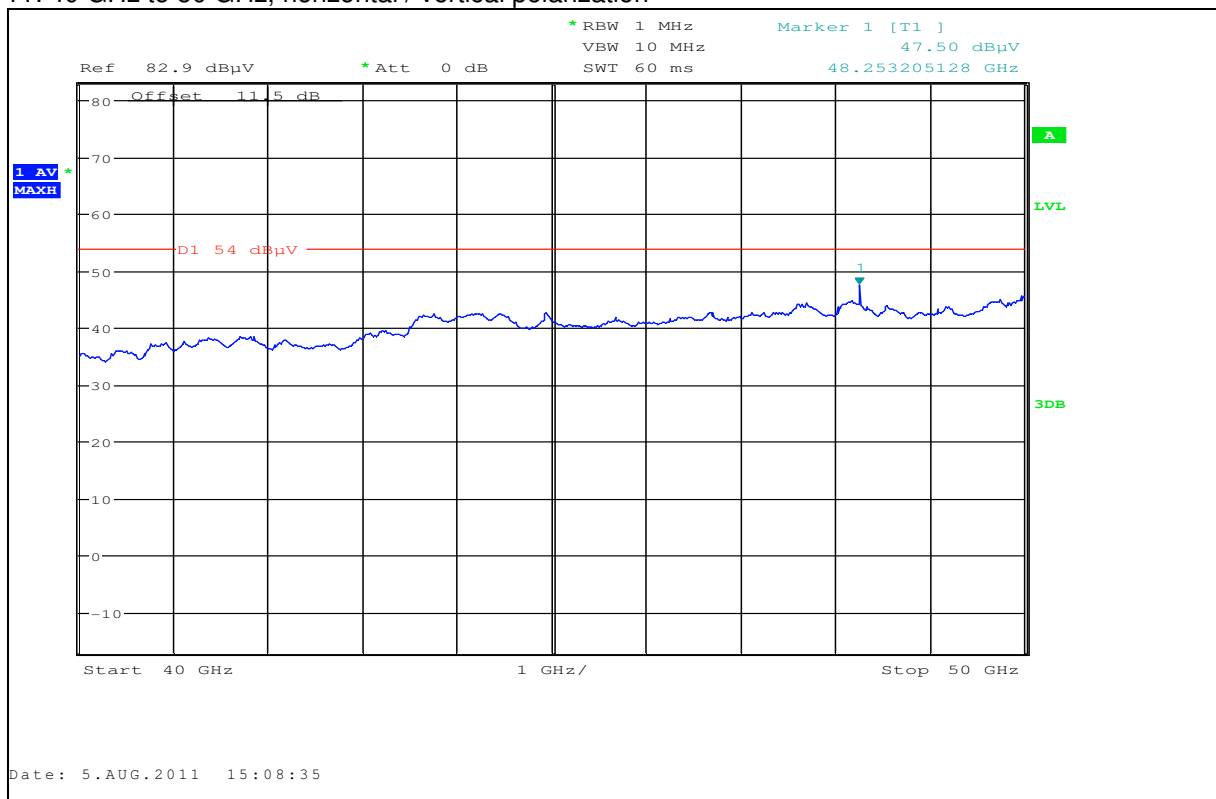

Plot 12: 48.25 GHz (2nd harmonic), horizontal / vertical polarization

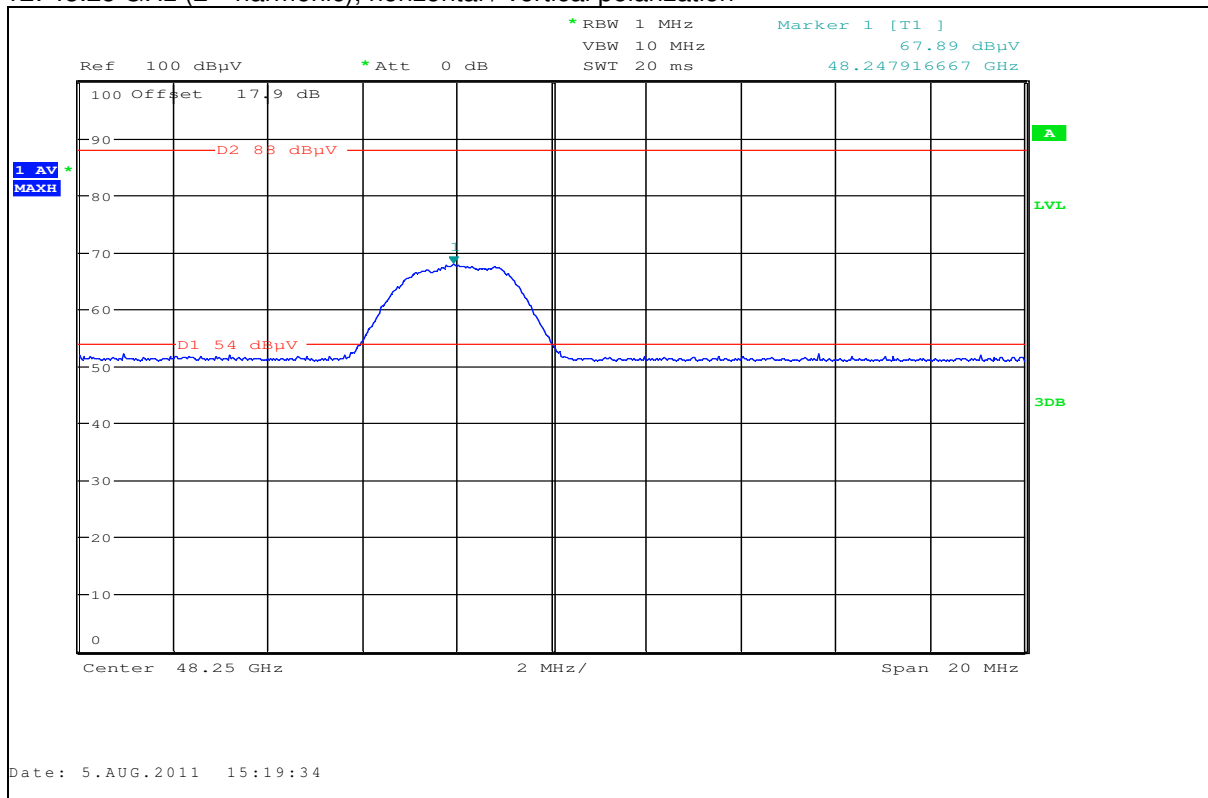

Plot 13: 50 GHz to 75 GHz, horizontal / vertical polarization

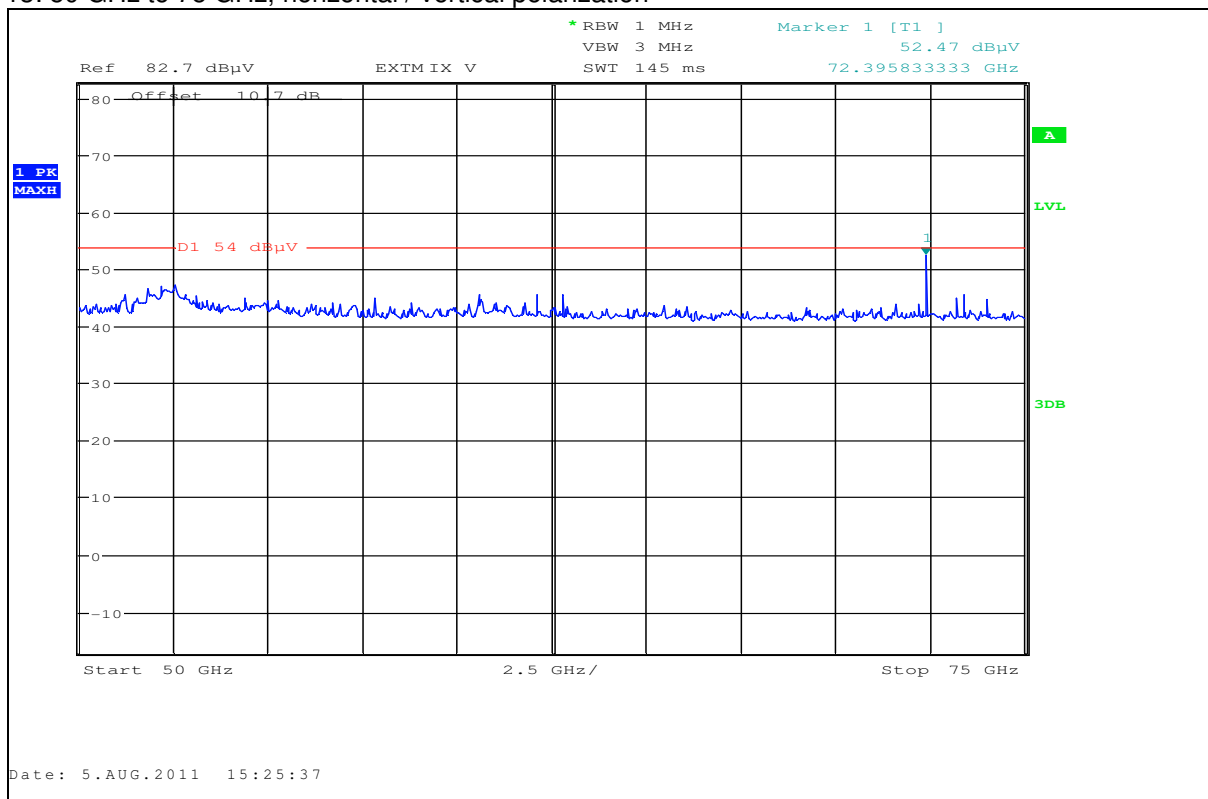

Plot 14: 72.375 GHz (3rd harmonic), horizontal / vertical polarization

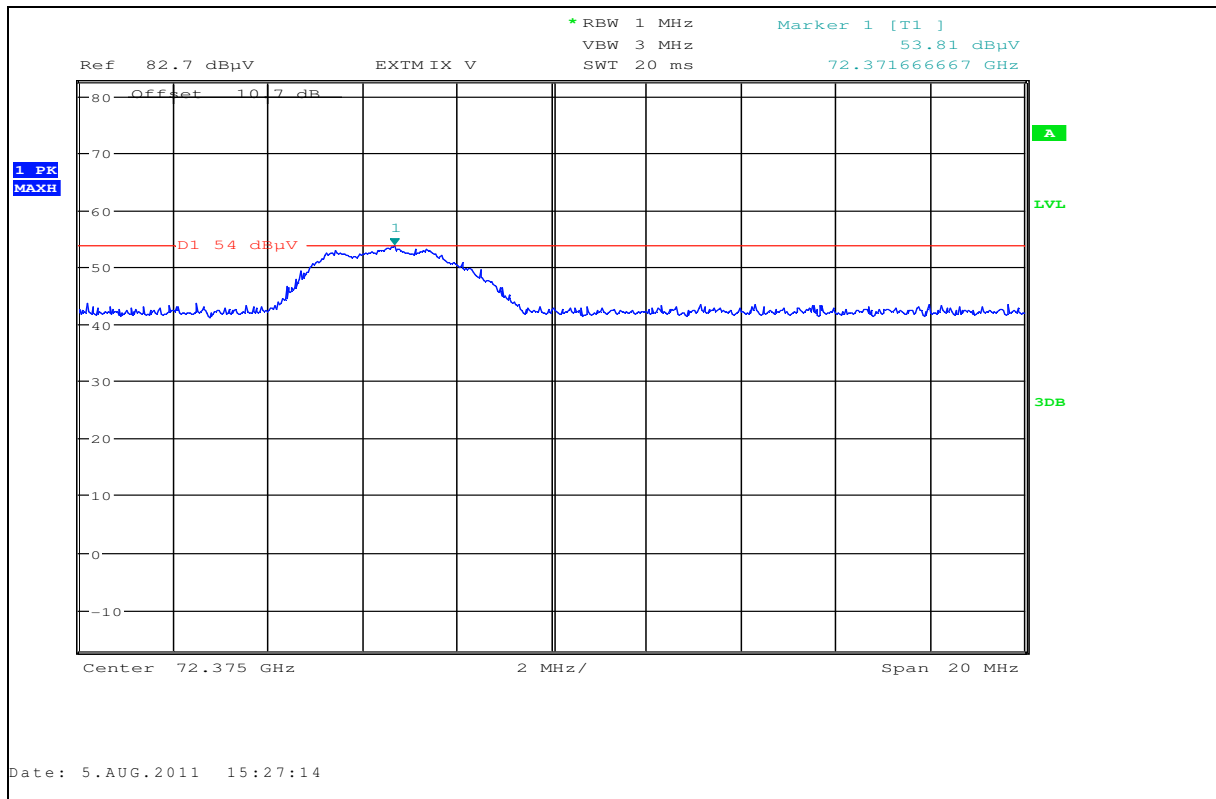

Plot 15: 75 GHz to 110 GHz, horizontal / vertical polarization

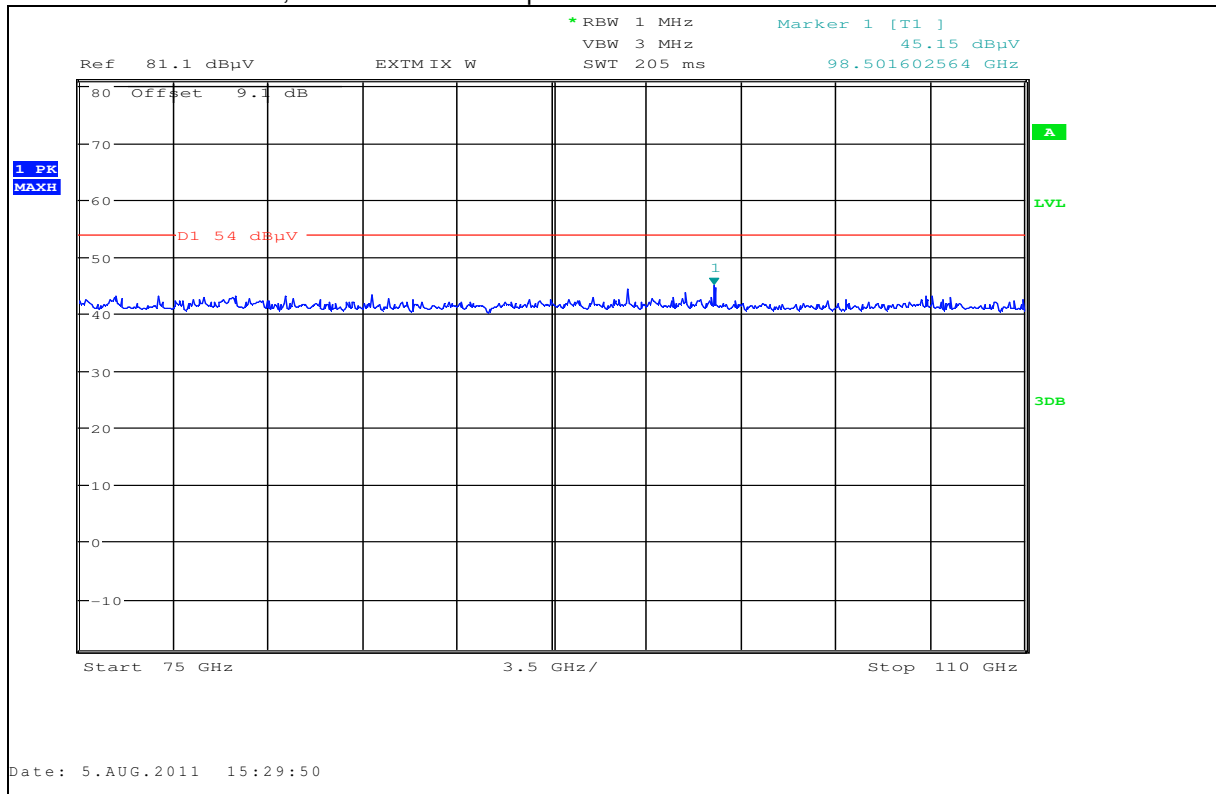

9.4 Conducted spurious emissions < 30 MHz

Description:

Measurement of the conducted spurious emissions in transmit mode below 30 MHz. Both power lines, phase and neutral line, are measured. Found peaks are re-measured with average and quasi peak detection to show compliance to the limits.

Measurement:

Measurement parameter	
Detector:	Peak - Quasi Peak / Average
Sweep time:	Auto
Video bandwidth:	F < 150 kHz: 200 Hz F > 150 kHz: 9 kHz
Resolution bandwidth:	F < 150 kHz: 1 kHz F > 150 kHz: 100 kHz
Span:	9 kHz to 30 MHz
Trace-Mode:	Max Hold

Limits:

FCC		IC	
CFR Part 15.207(a)		ICES-003, Issue 4	
Conducted Spurious Emissions < 30 MHz			
Frequency (MHz)	Quasi-Peak (dB μ V/m)	Average (dB μ V/m)	
0.15 – 0.5	66 to 56*	56 to 46*	
0.5 – 5	56	46	
5 – 30.0	60	50	

*Decreases with the logarithm of the frequency

Results:

Conducted Spurious Emissions < 30 MHz [dB μ V/m]		
F [MHz]	Detector	Level [dB μ V/m]
No critical peaks found!		
Measurement uncertainty	± 3 dB	

Result: The measurement is passed.

Plot 16: Phase line

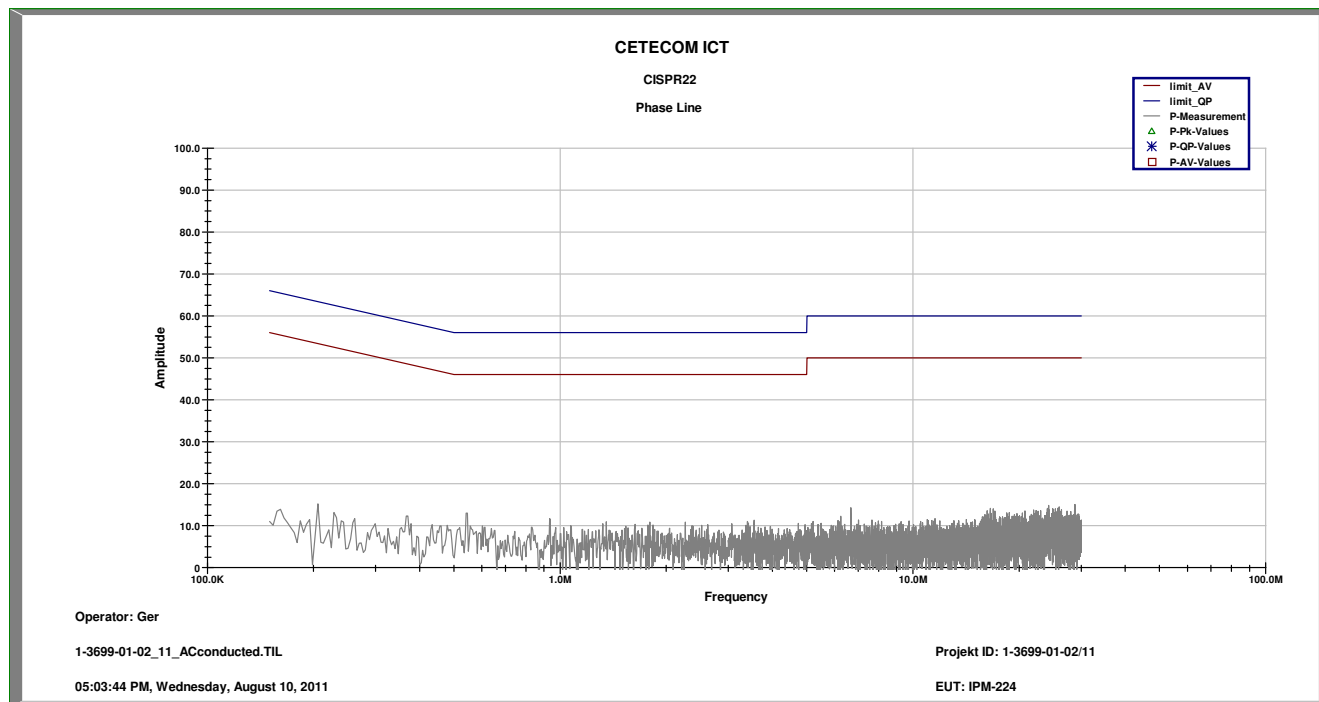

Plot 17: Neutral line

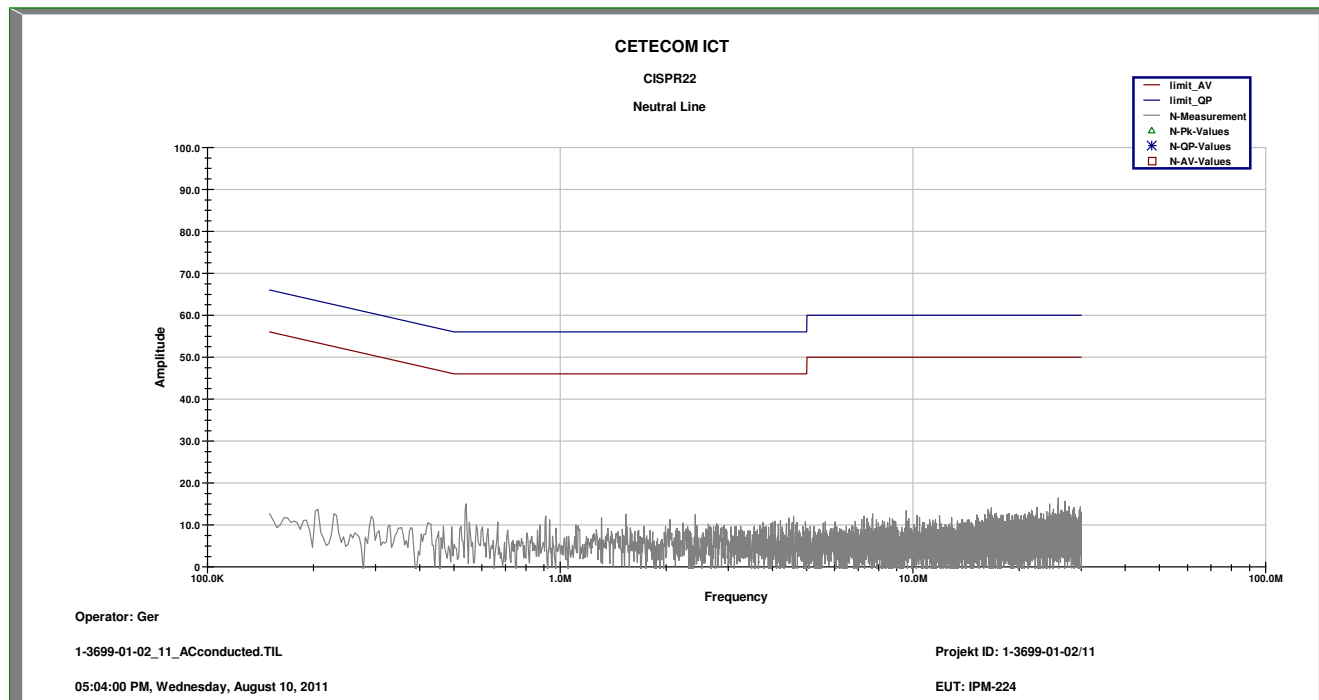

10 Test equipment and ancillaries used for tests

Typically, the calibrations of the test apparatus are commissioned to and performed by an accredited calibration laboratory. The calibration intervals are determined in accordance with the DIN EN ISO/IEC 17025. In addition to the external calibrations, the laboratory executes comparison measurements with other calibrated test systems or effective verifications. Weekly chamber inspections and range calibrations are performed. Where possible, rf-generating and signalling equipment as well as measuring receivers and analyzers are connected to an external high-precision 10 MHz reference (GPS-based or rubidium frequency standard).

In order to simplify the identification of the equipment used at some special tests, some items of test equipment and ancillaries can be provided with an identifier or number in the equipment list below (Lab/Item).

No	Equipment/Type	Manuf.	Serial Nr.	Inv. No. Cetecom	Last Calibration	Next Calibration
1	Anechoic chamber	MWB	87400/02	300000996	Monthly verification	
2	System-Rack 85900	HP I.V.	*	300000222	n.a.	
3	Measurement System 1					
4	PSA-Spektrumanalysator 3 Hz - 26.5 GHz	Agilent	MY48250080	300003812	08.09.2010	08.09.2012
5	EMI Preselector 9 kHz - 1 GHz (N9039A)	Agilent	MY48260003	300003825	08.09.2010	08.09.2012
6	Microwave Analog Signal Generator (N5183A)	Agilent	MY47420220	300003813	08.09.2010	08.09.2012
7	PC	F+W			n.a.	
8	TILE	TILE			n.a.	
9	TRILOG Super Broadband Antenna (VULB9163)	Schwarzbeck	371	300003854	Monthly verification (System cal.)	
10	Double Ridged Antenna 3115	EMCO	3088	300001032	Monthly verification (System cal.)	
11	Active Loop Antenna 6502	EMCO	2210	300001015	Monthly verification (System cal.)	
12	Switch / Control Unit 3488A	HP	2719A15013	300001156	n.a.	
13	Power Supply 6032A	HP	2818A03450	300001040	08.01.2009	08.01.2012
14	Busisolator	Kontron		300001056	n.a.	
15	Leitungsteiler 11850C	HP		300000997	Monthly verification (System cal.)	
16	Power attenuator 8325	Byrd	1530	300001595	Monthly verification (System cal.)	
17	Band reject filter WRCG1855/1910	Wainwright	7	300003350	Monthly verification (System cal.)	
18	Band reject filter WRCG2400/2483	Wainwright	11	300003351	Monthly verification (System cal.)	
19	Hochpassfilter WHK1.1/15G-10SS	Wainwright	3	300003255	Monthly verification (System cal.)	
20	Hochpassfilter WHKX2.9/18G-12SS	Wainwright	1	300003492	Monthly verification (System cal.)	
21	Hochpassfilter WHKX7.0/18G-8SS	Wainwright	18	300003789	Monthly verification (System cal.)	
22	Switch / Control Unit 3488A	HP	2605e08770	300001443	n.a.	
23	Trenntrafo RT5A	Grundig	9242	300001263	n.a.	
24	Relais Matrix PSU	R&S	890167/024	300001168	n.a.	
25	Netznachbildung ESH3-Z5	R&S	828576/020	300001210	n.a.	
26	Control Computer	F+W	FW0502032	300003303	-/-	-/-
27	Trilog Antenna VULB 9163	Schwarzbeck	295	300003787	01.04.2010	01.04.2012
28	Amplifier - 0518C-138	Veritech	-/-	-/-	-/-	-/-
29	Switch - 3488A	HP		300000368	-/-	-/-
30	EMI Test receiver - ESCI	R&S	100083	300003312	05.01.2011	05.01.2013
31	Turntable Controller - 1061 3M	EMCO	1218	300000661	-/-	-/-
32	Tower Controller / 1051 Controller	EMCO	1262	300000625	-/-	-/-
33	Tower - 1051	EMCO	1262	300000625	-/-	-/-
34	Ultra Notch-Filter Rejected band Ch. 62	WRCD	9	-/-	-/-	-/-
35	Spectrum Analyser FSU50	R&S	200012	300003443	01.07.2010	01.07.2012
36	Spectrum Analyser 8565E	HP	3738A00773	300001665	08.01.2010	08.01.2012
37	Amplifier 0.1 to 26.0 GHz 83017A	HP	00419	300002267	10.03.2011	10.03.2012
38	DC Power supply 6038A	HP	2848A07027	300001174	07.01.2009	07.01.2012
39	RF-cable	H & S		-/-	cyclic verification	
40	SGH 12.0 to 18.0 GHz, 639	narda	8402	300000787	-/-	-/-
41	SGH 18.0 to 27.0 GHz, 638	narda	8205	300002442	-/-	-/-
42	SGH 27.0 to 40.0 GHz, 637	narda	7911	300001751	-/-	-/-
43	SGH 33.0 to 50.0 GHz, 2324-20	Flann	57	-/-	-/-	-/-
44	SGH 50 to 75 GHz, 2524-20	Flann	-/-	300001983	-/-	-/-
45	Mixer 50 to 75 GHz, FS-Z75	R&S	100099	300003949	19.01.2011	19.01.2012
46	SGH 75 to 110 GHz, 2724-20	Flann	-/-	300002338	-/-	-/-
47	Mixer 75 to 110 GHz, SAM-110-7	R&S	002	300004155	01.02.2011	01.08.2012

Annex A Photographs of the test setup

Photo 1:



Photo 2:

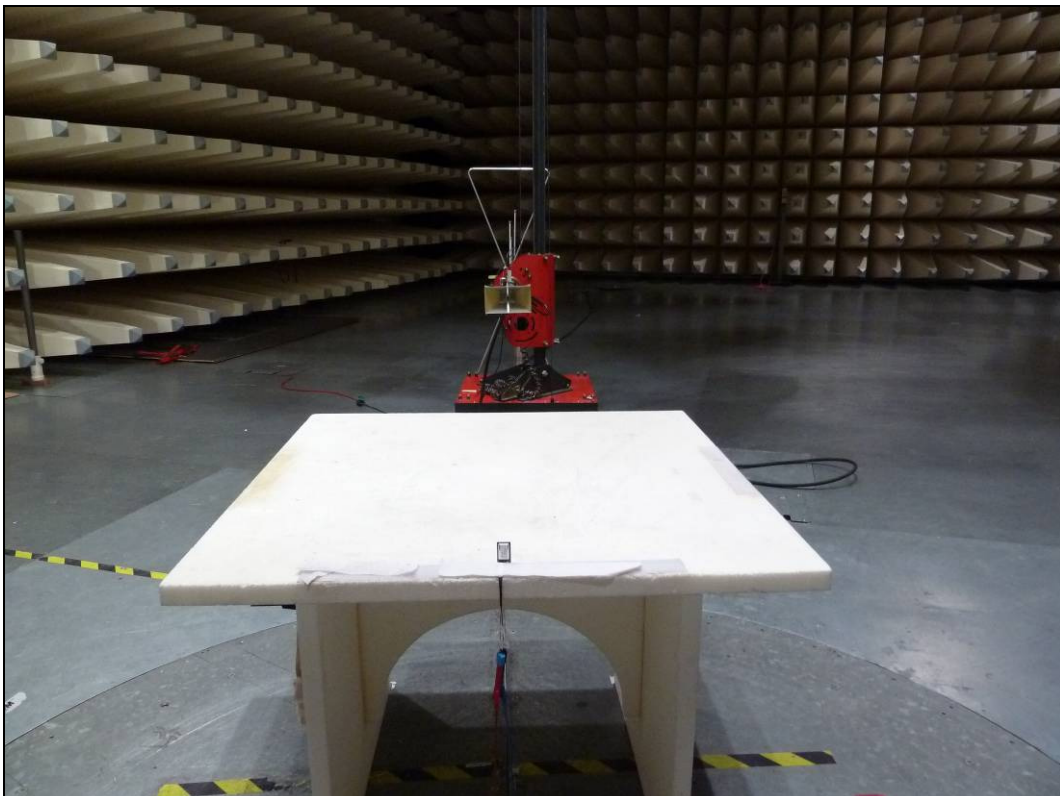

Photo 3:

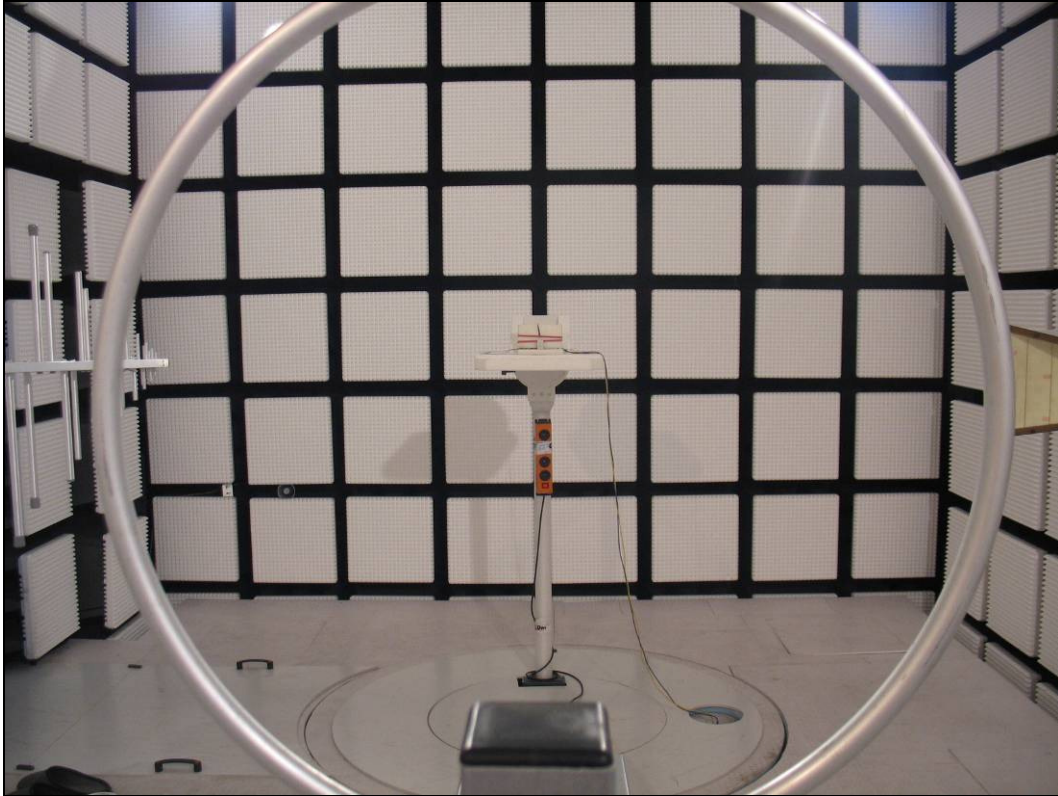

Photo 4:



Photo 5:



Annex B External photographs of the EUT

Photo 1:

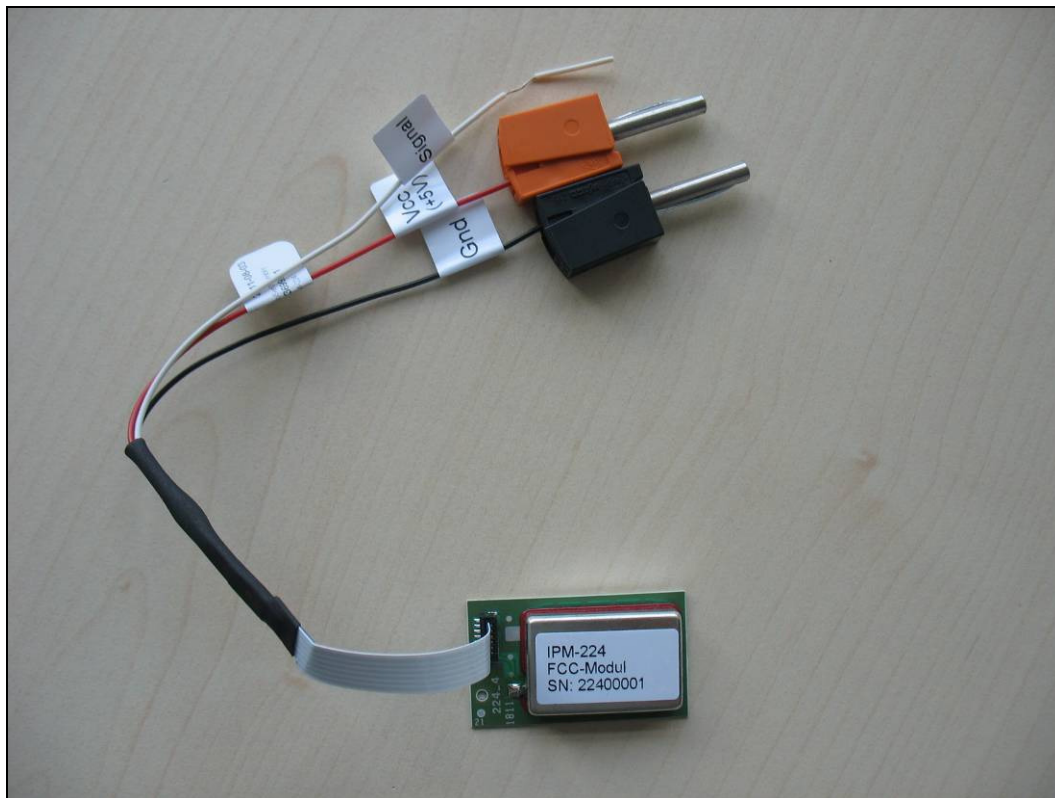

Photo 2:



Photo 3:

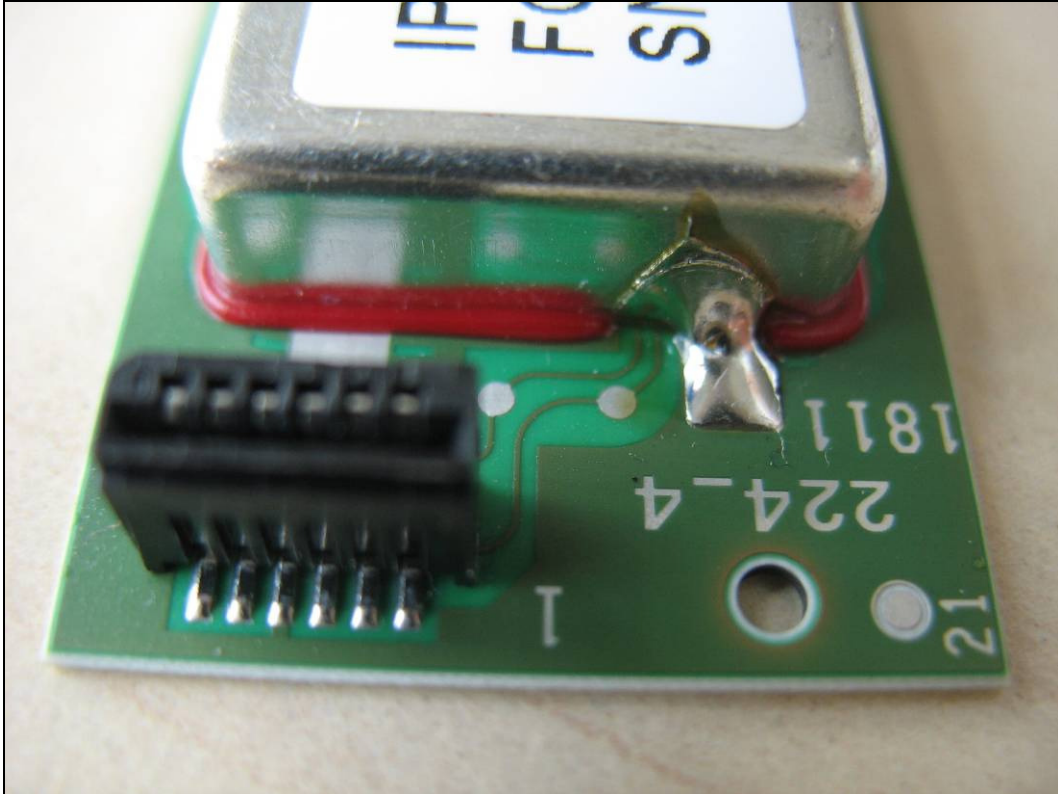

Photo 4:

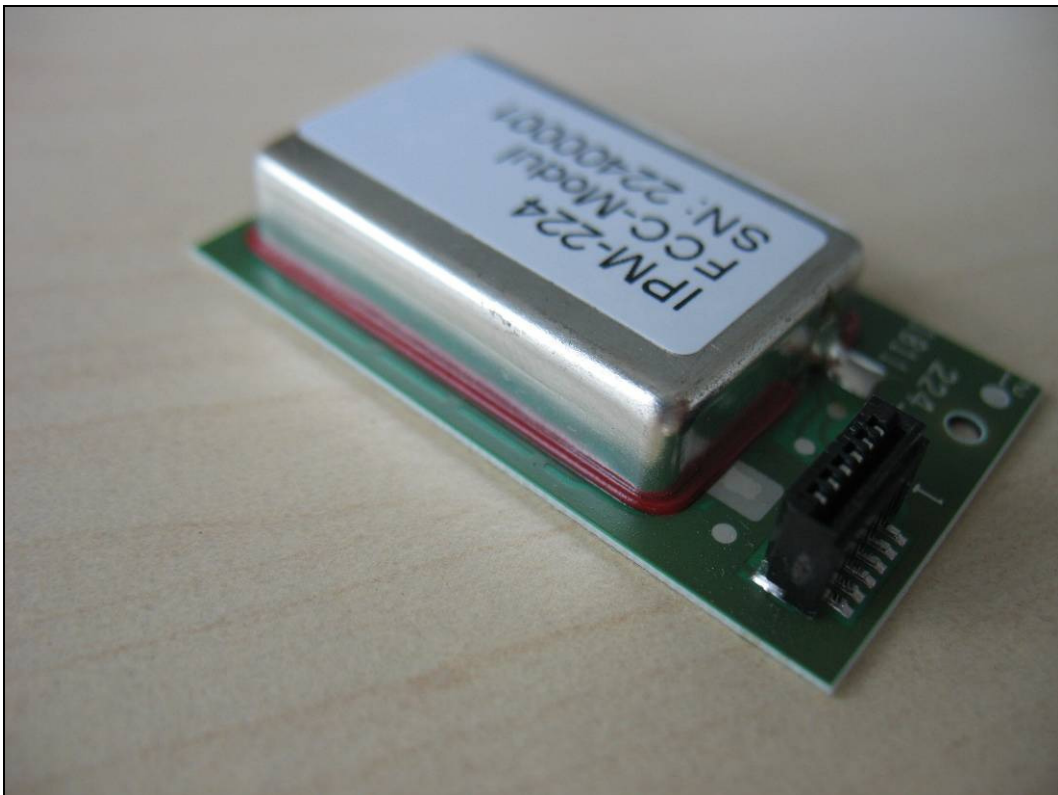

Photo 5:

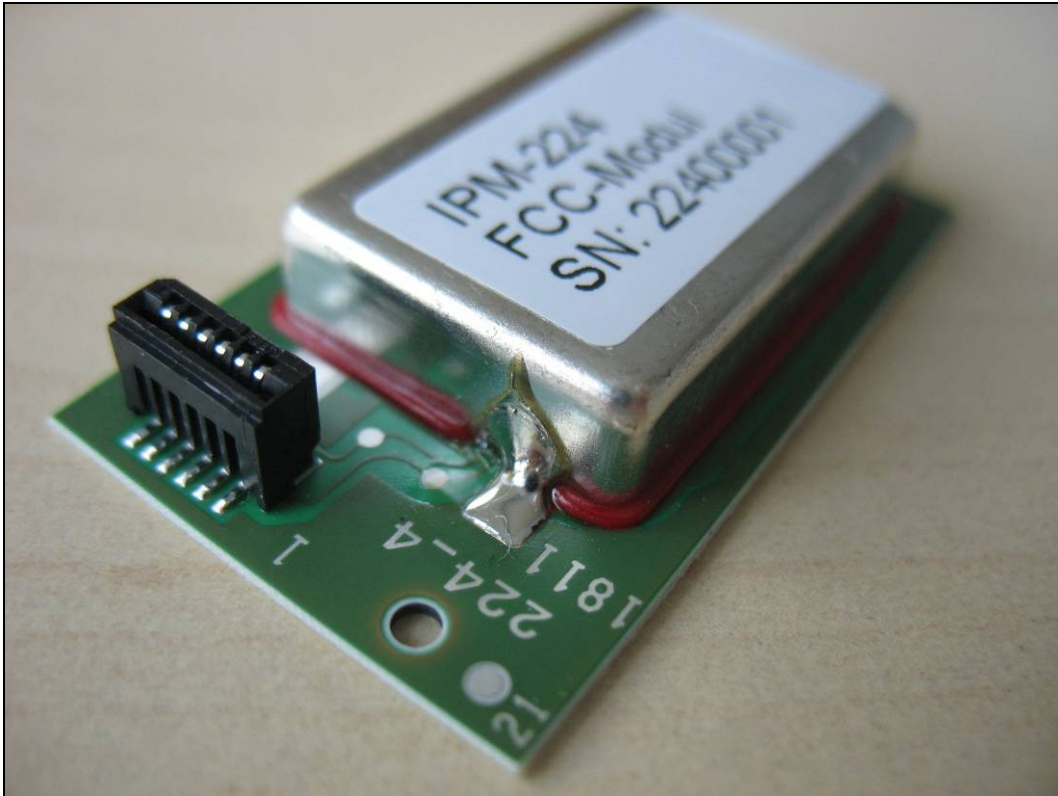
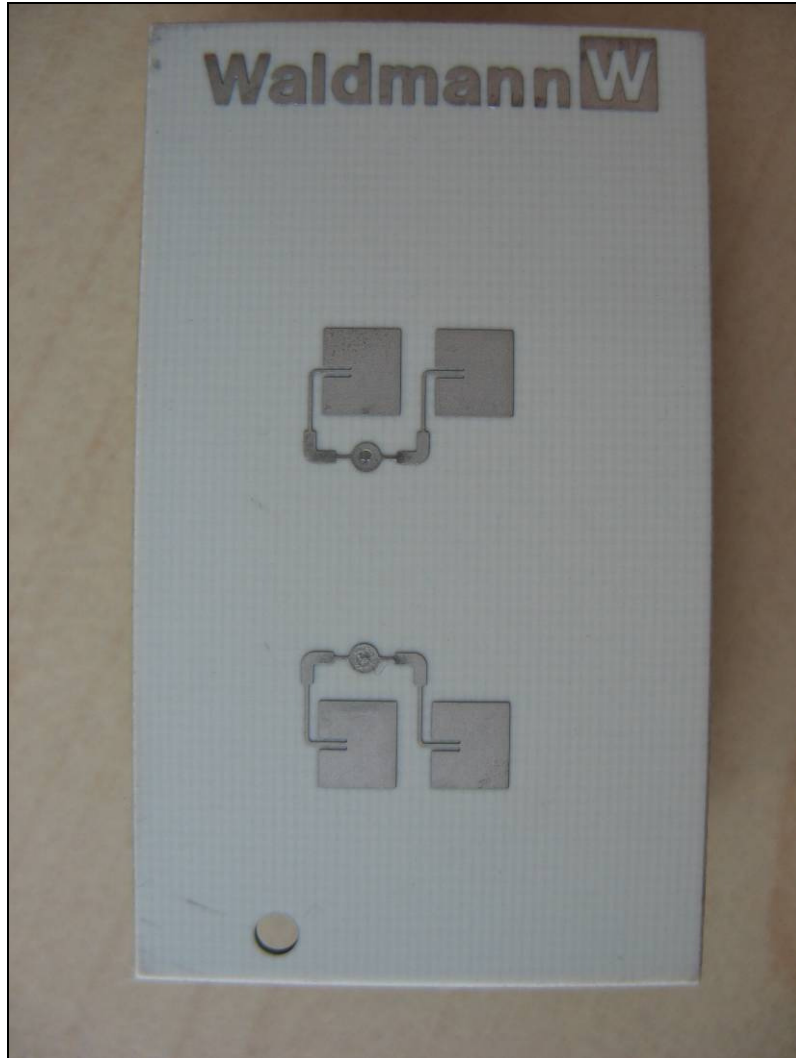

Photo 6:



Photo 7:



Annex C Document history

Version	Applied changes	Date of release
1.0	Initial release	2011-08-17

Annex D Further information**Glossary**

AVG	-	Average
DUT	-	Device under test
EMC	-	Electromagnetic Compatibility
EN	-	European Standard
EUT	-	Equipment under test
ETSI	-	European Telecommunications Standard Institute
FCC	-	Federal Communication Commission
FCC ID	-	Company Identifier at FCC
HW	-	Hardware
IC	-	Industry Canada
Inv. No.	-	Inventory number
N/A	-	Not applicable
PP	-	Positive peak
QP	-	Quasi peak
S/N	-	Serial number
SW	-	Software