



**FCC 47 CFR PART 15 SUBPART C  
ISED RSS-247 ISSUE 2**

**CERTIFICATION TEST REPORT**

*For*

**Wireless Speaker**

**MODEL NUMBER: LSX**

**FCC ID: UXD18002**

**IC: 21561-18002**

**REPORT NUMBER: 4788430402-6**

**ISSUE DATE: July 08, 2018**

*Prepared for*

**GP Electronics (HK) Ltd.**

**9/F, Building 12W, 12 Science Park West Avenue, Hong Kong Science Park, Pak  
Shek Kok New Territories - Hong Kong**

*Prepared by*

**UL Verification Services (Guangzhou) Co., Ltd, Song Shan Lake Branch  
Building 10, Innovation Technology Park, No. 1, Li Bin Road,  
Song Shan Lake Hi-Tech Development Zone, Dongguan, People's Republic of China**

**Tel: +86 769-22038881**

**Fax: +86 769 33244054**

**Website: [www.ul.com](http://www.ul.com)**



Revision History

<u>Rev.</u>	<u>Issue Date</u>	<u>Revisions</u>	<u>Revised By</u>
--	7/8/2018	Initial Issue	



Summary of Test Results			
Clause	Test Items	FCC/IC Rules	Test Results
1	6db DTS Bandwidth and 99% Bandwidth	FCC 15.247 (a) (2) RSS-247 Clause 5.2 (a) RSS-Gen Clause 6.6	PASS
2	Peak Conducted Power	FCC 15.247 (b) (3) RSS-247 Clause 5.4 (e)	PASS
3	Power Spectral Density	FCC 15.247 (e) RSS-247 Clause 5.2 (b)	PASS
4	Conducted Band edge And Spurious emission	FCC 15.247 (d) RSS-247 Clause 5.5	PASS
5	Radiated Band edges and Spurious emission	FCC 15.247 (d) FCC 15.209 FCC 15.205 RSS-247 Clause 5.5 RSS-GEN Clause 8.9 RSS-GEN Clause 8.10	PASS
6	Conducted Emission Test For AC Power Port	FCC 15.207 RSS-GEN Clause 8.8	PASS
7	Antenna Requirement	FCC 15.203 RSS-GEN Clause 8.3	PASS



## TABLE OF CONTENTS

<b>1. ATTESTATION OF TEST RESULTS .....</b>	<b>6</b>
<b>2. TEST METHODOLOGY .....</b>	<b>7</b>
<b>3. FACILITIES AND ACCREDITATION .....</b>	<b>7</b>
<b>4. CALIBRATION AND UNCERTAINTY .....</b>	<b>8</b>
4.1. MEASURING INSTRUMENT CALIBRATION .....	8
4.2. MEASUREMENT UNCERTAINTY.....	8
<b>5. EQUIPMENT UNDER TEST .....</b>	<b>9</b>
5.1. DESCRIPTION OF EUT .....	9
5.2. MAXIMUM OUTPUT POWER.....	9
5.3. CHANNEL LIST.....	9
5.4. TEST CHANNEL CONFIGURATION.....	10
5.5. THE WORSE CASE POWER SETTING PARAMETER.....	10
5.6. DESCRIPTION OF AVAILABLE ANTENNAS .....	10
5.7. TEST ENVIRONMENT .....	10
5.8. DESCRIPTION OF TEST SETUP.....	11
5.9. MEASURING INSTRUMENT AND SOFTWARE USED.....	12
<b>6. MEASUREMENT METHODS .....</b>	<b>13</b>
<b>7. ANTENNA PORT TEST RESULTS .....</b>	<b>14</b>
7.1. ON TIME AND DUTY CYCLE.....	14
7.2. 6 dB DTS BANDWIDTH AND 99% BANDWIDTH.....	16
7.3. PEAK CONDUCTED OUTPUT POWER.....	19
7.4. POWER SPECTRAL DENSITY .....	21
7.5. CONDUCTED BANDEDGE AND SPURIOUS EMISSIONS.....	24
<b>8. RADIATED TEST RESULTS.....</b>	<b>29</b>
8.1. RESTRICTED BANDEDGE.....	33
8.2. SPURIOUS EMISSIONS (1~3GHz).....	37
8.3. SPURIOUS EMISSIONS (3~18GHz).....	43
8.4. SPURIOUS EMISSIONS 18G ~ 26GHz.....	49
8.5. SPURIOUS EMISSIONS 30M ~ 1 GHz .....	51
8.6. SPURIOUS EMISSIONS BELOW 30M.....	53



9. AC POWER LINE CONDUCTED EMISSIONS .....57  
10. ANTENNA REQUIREMENTS .....60



# 1. ATTESTATION OF TEST RESULTS

## Applicant Information

Company Name: GP Electronics (HK) Ltd.  
Address: 9/F, Building 12W, 12 Science Park West Avenue, Hong Kong  
Science Park, Pak Shek Kok New Territories - Hong Kong

## Manufacturer Information

Company Name: GP Electronics (HK) Ltd.  
Address: 9/F, Building 12W, 12 Science Park West Avenue, Hong Kong  
Science Park, Pak Shek Kok New Territories - Hong Kong

## EUT Description

Product Name: Wireless Speaker  
Model Name: LSX  
Sample Status: Good  
Sample Received date: April 23, 2018  
Date Tested: April 23~July 6, 2018

APPLICABLE STANDARDS	
STANDARD	TEST RESULTS
CFR 47 Part 15 Subpart C	PASS
ISED RSS-247 Issue 2	PASS
ISED RSS-GEN Issue 5	PASS

Tested By:

Checked By:

Kebo Zhang  
Engineer  
Approved By:

Shawn Wen  
Laboratory Leader

Stephen Guo  
Laboratory Manager



## 2. TEST METHODOLOGY

The tests documented in this report were performed in accordance with KDB414788 D01 Radiated Test Site v01, ANSI C63.10-2013, KDB558074 D01 DTS Meas Guidance v04, FCC CFR 47 Part 2, FCC CFR 47 Part 15, RSS-GEN Issue 5, and RSS-247 Issue 2.

## 3. FACILITIES AND ACCREDITATION

Accreditation Certificate	<p><b>A2LA (Certificate No.: 4102.01)</b> UL Verification Services (Guangzhou) Co., Ltd. Song Shan Lake Branch. has been assessed and proved to be in compliance with A2LA.</p> <p><b>IAS (Lab Code: TL-702)</b> UL Verification Services (Guangzhou) Co., Ltd. Song Shan Lake Branch. has demonstrated compliance with ISO/IEC Standard 17025:2005, General requirements for the competence of testing and calibration laboratories</p> <p><b>FCC (FCC Designation No.: CN1187)</b> UL Verification Services (Guangzhou) Co., Ltd. Song Shan Lake Branch. Has been recognized to perform compliance testing on equipment subject to the Commission's Declaration of Conformity (DoC) and Certification rules</p> <p><b>IC(Company No.: 21320)</b> UL Verification Services (Guangzhou) Co., Ltd. Song Shan Lake Branch. has been registered and fully described in a report filed with Industry Canada. The Company Number is 21320.</p> <p><b>VCCI (Registration No.: G-20019, R-20004, C-20012 and T-20011)</b> UL Verification Services (Guangzhou) Co., Ltd. Song Shan Lake Branch. has been assessed and proved to be in compliance with VCCI, the Membership No. is 3793. Facility Name: Chamber D, the VCCI registration No. is G-20019 and R-20004 Shielding Room B , the VCCI registration No. is C-20012 and T-20011</p>
---------------------------	---

Note1 : All tests measurement facilities use to collect the measurement data are located at Building 10, Innovation Technology Park, Song Shan Lake Hi tech Development Zone, Dongguan, 523808, China

Note 2: The test anechoic chamber in UL Verification Services (Guangzhou) Co., Ltd. Song Shan Lake Branch had been calibrated and compared to the open field sites and the test anechoic chamber is shown to be equivalent to or worst case from the open field site.



## 4. CALIBRATION AND UNCERTAINTY

### 4.1. MEASURING INSTRUMENT CALIBRATION

The measuring equipment utilized to perform the tests documented in this report has been calibrated in accordance with the manufacturer's recommendations, and is traceable to recognize national standards.

### 4.2. MEASUREMENT UNCERTAINTY

Where relevant, the following measurement uncertainty levels have been estimated for tests performed on the apparatus:

Test Item	Uncertainty
Uncertainty for Conduction emission test	2.90dB
Uncertainty for Radiation Emission test(include Fundamental emission) (9KHz-30MHz)	2.2dB
Uncertainty for Radiation Emission test(include Fundamental emission) (30MHz-1GHz)	4.52dB
Uncertainty for Radiation Emission test (1GHz to 26GHz)( include Fundamental emission)	5.04dB(1-6GHz)
	5.30dB (6GHz-18Gz)
	5.23dB (18GHz-26Gz)
Note: This uncertainty represents an expanded uncertainty expressed at approximately the 95% confidence level using a coverage factor of k=2.	





## 5. EQUIPMENT UNDER TEST

### 5.1. DESCRIPTION OF EUT

Equipment	Wireless Speaker		
Model Name	LSX		
Product Description	Operation Frequency	2406 MHz ~ 2474 MHz	
	Modulation Type	Data Rate	
	8FSK	1Mbps	
Power Supply	AC120V/60Hz		

### 5.2. MAXIMUM OUTPUT POWER

Test Mode	Frequency (MHz)	Channel Number	Max Output Power (dBm)	EIRP (dBm)
2.4G	2406-2474	1-18[18]	-2.3	5.2

### 5.3. CHANNEL LIST

Channel	Frequency (MHz)	Channel	Frequency (MHz)
1	2406	10	2442
2	2410	11	2446
3	2414	12	2450
4	2418	13	2454
5	2422	14	2458
6	2426	15	2462
7	2430	16	2466
8	2434	17	2470
9	2438	18	2474



#### 5.4. TEST CHANNEL CONFIGURATION

Test Mode	Test Channel	Frequency
8FSK	CH 1, CH 10, CH 18	2406MHz, 2442MHz, 2474MHz

#### 5.5. THE WORSE CASE POWER SETTING PARAMETER

The Worst Case Power Setting Parameter under 2400 ~ 2483.5MHz Band				
Test Software		PurePathWireless Configurator		
Modulation Type	Transmit Antenna Number	Test Channel		
		CH 00	CH 19	CH 39
8FSK	1	-2	-2	-2

#### 5.6. DESCRIPTION OF AVAILABLE ANTENNAS

Ant.	Frequency (MHz)	Antenna Type	Antenna Gain (dBi)
1	2406-2474	External Antenna	7.5

Test Mode	Transmit and Receive Mode	Description
8FSK	1TX, 1RX	Chain 1 can be used as transmitting/receiving antenna.

#### 5.7. TEST ENVIRONMENT

Environment Parameter	Selected Values During Tests	
Relative Humidity	55 ~ 65%	
Atmospheric Pressure:	1025Pa	
Temperature	TN	23 ~ 28°C
Voltage :	VL	N/A
	VN	AC 120V 60Hz
	VH	N/A

Note: VL= Lower Extreme Test Voltage  
 VN= Nominal Voltage  
 VH= Upper Extreme Test Voltage  
 TN= Normal Temperature

## 5.8. DESCRIPTION OF TEST SETUP

### SUPPORT EQUIPMENT

Item	Equipment	Brand Name	Model Name	P/N
1	Laptop	ThinkPad	T460S	SL10K24796 JS
2	USB TO CC Debugger	N/A	N/A	N/A

### I/O CABLES

Cable No	Port	Connector Type	Cable Type	Cable Length(m)	Remarks
1	N/A	N/A	N/A	N/A	N/A

### ACCESSORY

Item	Accessory	Brand Name	Model Name	Description
1	N/A	N/A	N/A	N/A

### TEST SETUP

The EUT can work in an engineer mode with a software through a laptop before the test.

### SETUP DIAGRAM FOR TEST

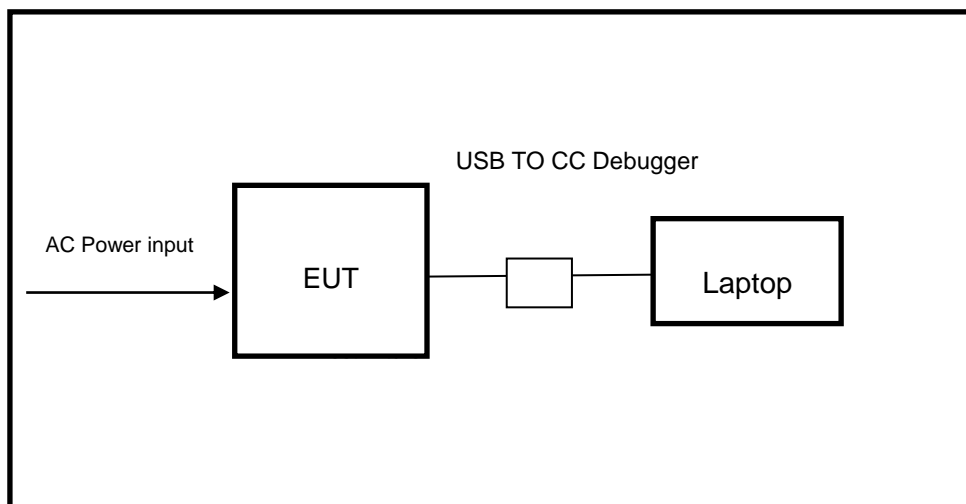



### 5.9. MEASURING INSTRUMENT AND SOFTWARE USED

Conducted Emissions						
Used	Equipment	Manufacturer	Model No.	Serial No.	Last Cal.	Next Cal.
<input checked="" type="checkbox"/>	EMI Test Receiver	R&S	ESR3	101961	Dec.12, 2017	Dec.11, 2018
<input checked="" type="checkbox"/>	Two-Line V-Network	R&S	ENV216	101983	Dec.12, 2017	Dec.11, 2018
<input checked="" type="checkbox"/>	Artificial Mains Networks	Schwarzbeck	NSLK 8126	8126465	Dec.12, 2017	Dec.11, 2018
Software						
Used	Description	Manufacturer	Name	Version		
<input checked="" type="checkbox"/>	Test Software for Conducted disturbance	UL	Antenna port	Ver. 7.2		
Radiated Emissions						
Used	Equipment	Manufacturer	Model No.	Serial No.	Last Cal.	Next Cal.
<input checked="" type="checkbox"/>	MXE EMI Receiver	KESIGHT	N9038A	MY56400036	Dec.12, 2017	Dec.11, 2018
<input checked="" type="checkbox"/>	Hybrid Log Periodic Antenna	TDK	HLP-3003C	130960	Jan.09, 2016	Jan.09, 2019
<input checked="" type="checkbox"/>	Preamplifier	HP	8447D	2944A09099	Dec.12, 2017	Dec.11, 2018
<input checked="" type="checkbox"/>	EMI Measurement Receiver	R&S	ESR26	101377	Dec.12, 2017	Dec.11, 2018
<input checked="" type="checkbox"/>	Horn Antenna	TDK	HRN-0118	130939	Jan. 09, 2016	Jan. 09, 2019
<input checked="" type="checkbox"/>	High Gain Horn Antenna	Schwarzbeck	BBHA-9170	691	Jan.06, 2016	Jan.06, 2019
<input checked="" type="checkbox"/>	Preamplifier	TDK	PA-02-0118	TRS-305-00066	Dec.12, 2017	Dec.11, 2018
<input checked="" type="checkbox"/>	Preamplifier	TDK	PA-02-2	TRS-307-00003	Dec.12, 2017	Dec.11, 2018
<input checked="" type="checkbox"/>	Loop antenna	Schwarzbeck	1519B	00008	Mar. 26, 2016	Mar. 26, 2019
Software						
Used	Description	Manufacturer	Name	Version		
<input checked="" type="checkbox"/>	Test Software for Radiated disturbance	Farad	EZ-EMC	Ver. UL-3A1		
Other instruments						
Used	Equipment	Manufacturer	Model No.	Serial No.	Last Cal.	Next Cal.
<input checked="" type="checkbox"/>	Spectrum Analyzer	Keysight	N9030A	MY55410512	Dec.12, 2017	Dec.11, 2018
<input checked="" type="checkbox"/>	Power Meter	Keysight	N9031A	MY55416024	Dec.12, 2017	Dec.11, 2018
<input checked="" type="checkbox"/>	Power Sensor	Keysight	N9323A	MY55440013	Dec.12, 2017	Dec.11, 2018
<input checked="" type="checkbox"/>	Power Sensor	Keysight	U2021XA	MY57030004	Dec.12, 2017	Dec.11, 2018



## 6. MEASUREMENT METHODS

No.	Test Item	KDB Name	Section
1	6 dB Bandwidth	KDB 558074 D01 DTS Meas Guidance v04	8.0
2	Peak Output Power	KDB 558074 D01 DTS Meas Guidance v04	9.1.3
3	Power Spectral Density	KDB 558074 D01 DTS Meas Guidance v04	10.2
4	Out-of-band emissions in non-restricted bands	KDB 558074 D01 DTS Meas Guidance v04	11.0
5	Out-of-band emissions in restricted bands	KDB 558074 D01 DTS Meas Guidance v04	12.1
6	Band-edge	KDB 558074 D01 DTS Meas Guidance v04	13.3.2
7	Conducted Emission Test For AC Power Port	ANSI C63.10-2013	6.2



## 7. ANTENNA PORT TEST RESULTS

### 7.1. ON TIME AND DUTY CYCLE

#### LIMITS

None; for reporting purposes only

#### PROCEDURE

KDB 558074 Zero-Span Spectrum Analyzer Method

#### TEST SETUP

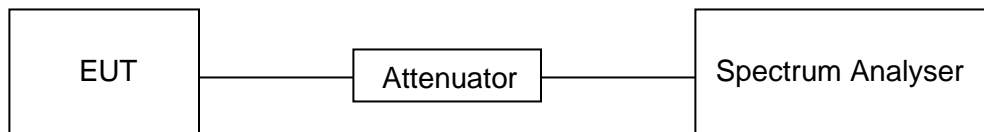

#### TEST ENVIRONMENT

Temperature	24.2°C	Relative Humidity	58%
Atmosphere Pressure	101kPa	Test Voltage	AC 120V



**RESULTS**

Channel	On Time (msec)	Period (msec)	Duty Cycle x (Linear)	Duty Cycle (%)	Duty Cycle Correction Factor (db)	1/T Minimum VBW (KHz)
Mid	133.1	133.1	1.0	100	0	0.01

Note: Duty Cycle Correction Factor=10log(1/x).  
 Where: x is Duty Cycle(Linear)  
 Where: T is On Time (transmit duration)

**ON TIME AND DUTY CYCLE MID CH**

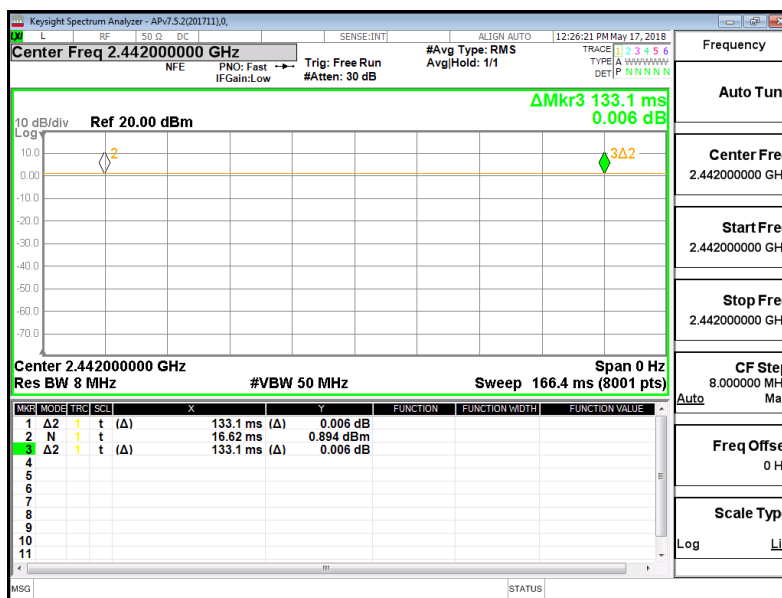

## 7.2. 6 dB DTS BANDWIDTH AND 99% BANDWIDTH

### LIMITS

FCC Part15 (15.247) Subpart C RSS-247 ISSUE 2			
Section	Test Item	Limit	Frequency Range (MHz)
FCC 15.247(a)(2) RSS-247 5.2 (a)	6dB Bandwidth	$\geq 500\text{KHz}$	2400-2483.5
RSS-Gen Clause 6.6	99% Bandwidth	For reporting purposes only.	2400-2483.5

### TEST PROCEDURE

Connect the UUT to the spectrum analyser and use the following settings:

Center Frequency	The center frequency of the channel under test
Detector	Peak
RBW	For 6 dB Bandwidth :100K For 99% Bandwidth :1% to 5% of the occupied bandwidth
VBW	For 6dB Bandwidth : $\geq 3 \times \text{RBW}$ For 99% Bandwidth : approximately $3 \times \text{RBW}$
Trace	Max hold
Sweep	Auto couple

Allow the trace to stabilize and measure the maximum width of the emission that is constrained by the frequencies associated with the two outermost amplitude points (upper and lower frequencies) that are attenuated by 6 dB relative to the maximum level measured in the fundamental emission.

### TEST SETUP

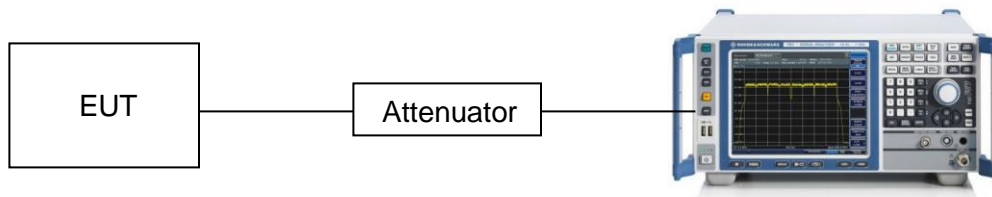





**TEST ENVIRONMENT**

Temperature	24.2°C	Relative Humidity	58%
Atmosphere Pressure	101kPa	Test Voltage	AC 120V

**RESULTS**

Channel	Frequency (MHz)	6dB bandwidth (MHz)	99% bandwidth (MHz)	Limit (kHz)	Result
Low	2406	2.212	3.5760	500	Pass
Middle	2442	2.200	3.5296	500	Pass
High	2474	2.205	3.5598	500	Pass

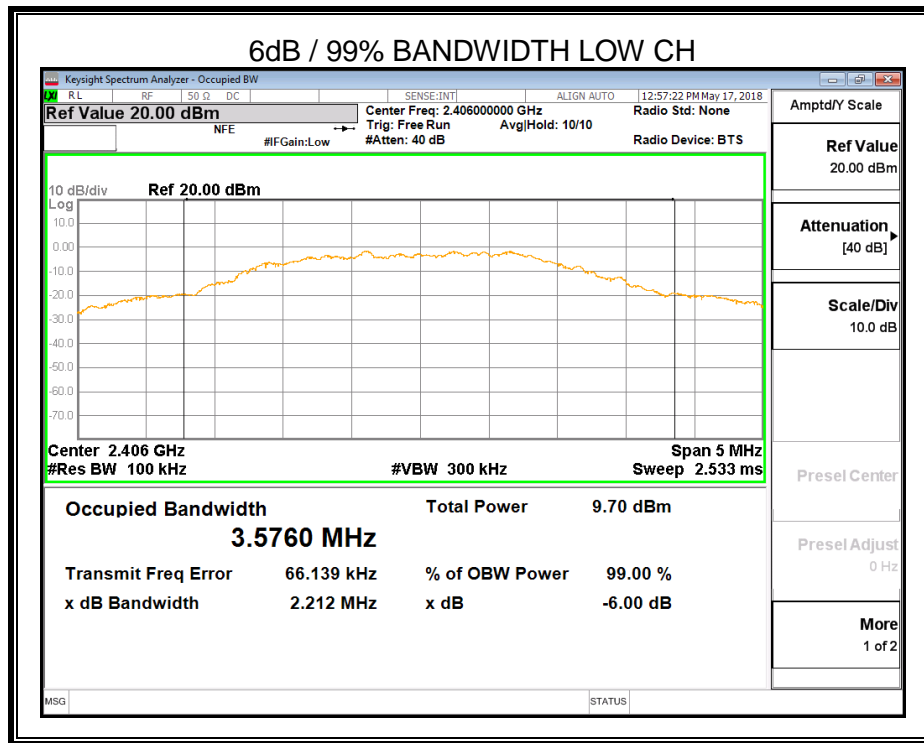

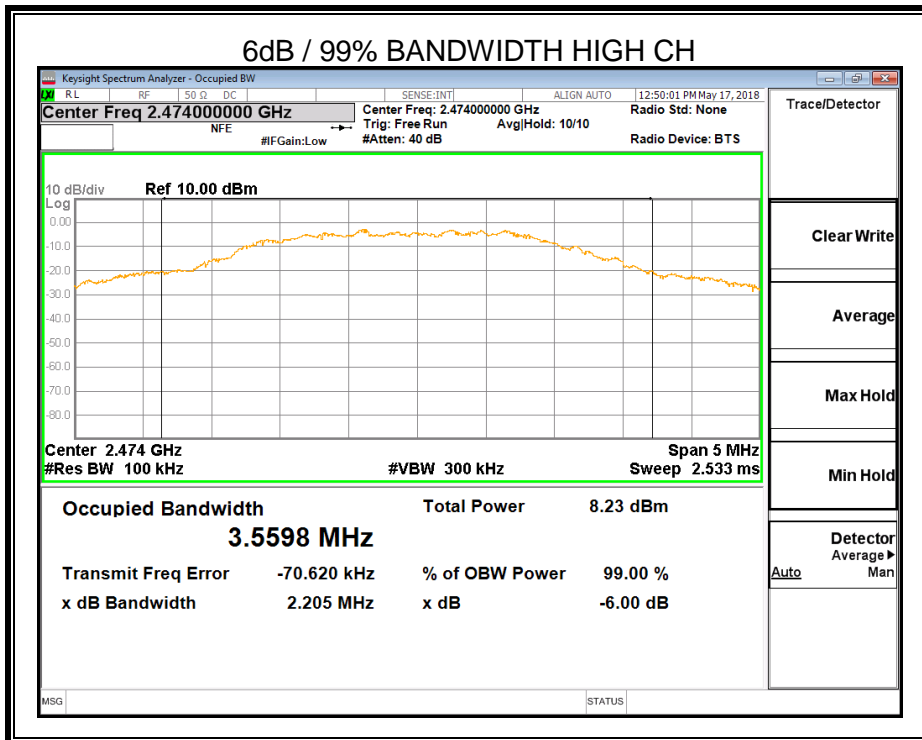
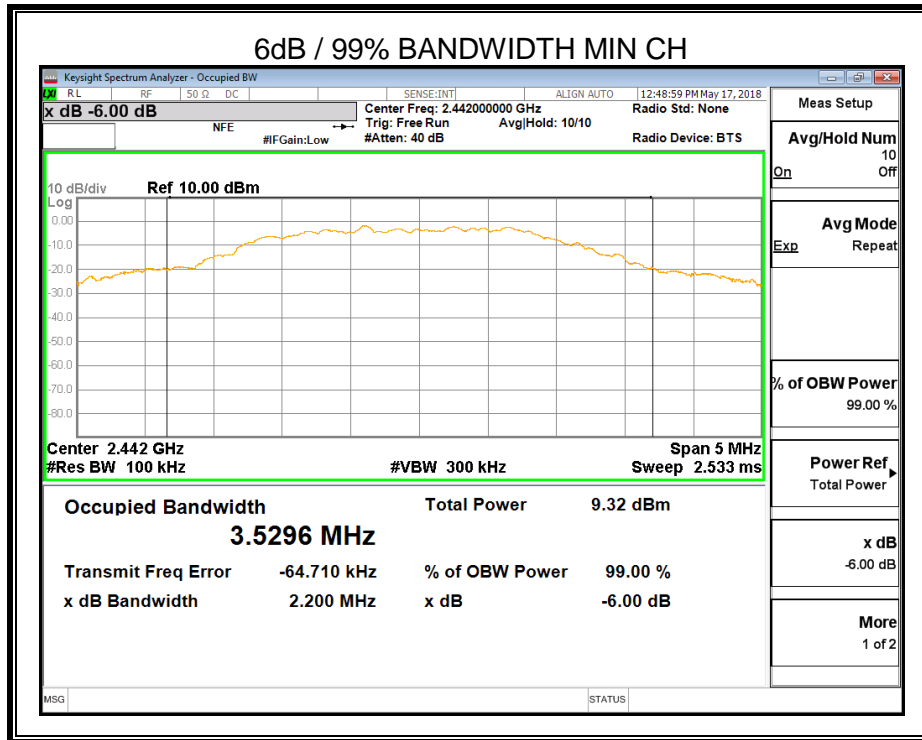

### 7.3. PEAK CONDUCTED OUTPUT POWER

#### LIMITS

FCC Part15 (15.247) Subpart C RSS-247 ISSUE 2			
Section	Test Item	Limit	Frequency Range (MHz)
FCC 15.247(b)(3) RSS-247 5.4 (e)	Peak Output Power	1 watt or 30dBm	2400-2483.5

#### TEST PROCEDURE

Connect the UUT to the spectrum analyser and use the following settings:

Center Frequency	The center frequency of the channel under test
Detector	Peak
RBW	$\geq$ DTS bandwidth(e.g. 1 MHz for BLE)
VBW	$\geq 3 \times$ RBW
Span	$3 \times$ RBW
Trace	Max hold
Sweep time	Auto couple.

Allow trace to fully stabilize and use peak marker function to determine the peak amplitude level.

#### TEST SETUP

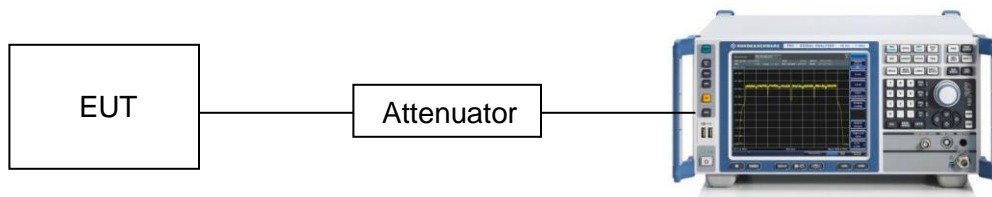

#### TEST ENVIRONMENT

Temperature	24.2°C	Relative Humidity	58%
Atmosphere Pressure	101kPa	Test Voltage	AC 120V

**RESULTS**

Test Channel	Frequency	Maximum Conducted Output Power(PK)	EIRP	LIMIT
	(MHz)	(dBm)	(dBm)	dBm
CH01	2406	-2.3	5.2	29
CH10	2442	-2.9	4.6	29
CH18	2474	-3.8	3.7	29

NOTE: EIRP= Maximum Conducted Output Power + ANT GAIN

## 7.4. POWER SPECTRAL DENSITY

### LIMITS

FCC Part15 (15.247) Subpart C RSS-247 ISSUE 2			
Section	Test Item	Limit	Frequency Range (MHz)
FCC §15.247 (e) RSS-247 5.2 (b)	Power Spectral Density	8 dBm in any 3 kHz band	2400-2483.5

### TEST PROCEDURE

Connect the UUT to the spectrum analyser and use the following settings:

Center Frequency	The center frequency of the channel under test
Detector	Peak
RBW	$3 \text{ kHz} \leq \text{RBW} \leq 100 \text{ kHz}$
VBW	$\geq 3 \times \text{RBW}$
Span	1.5 x DTS bandwidth
Trace	Max hold
Sweep time	Auto couple.

Allow trace to fully stabilize and use the peak marker function to determine the maximum amplitude level within the RBW.

If measured value exceeds limit, reduce RBW (no less than 3 kHz) and repeat.

### TEST SETUP

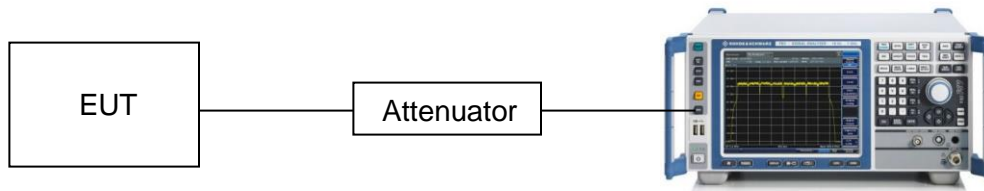

### TEST ENVIRONMENT

Temperature	24.2°C	Relative Humidity	58%
Atmosphere Pressure	101kPa	Test Voltage	AC 120V



**RESULTS**

Frequency	Power Spectral Density (dBm/3kHz)	Limit (dBm/3kHz)	Result
2406 MHz	-15.349	0.5	PASS
2442 MHz	-15.753	0.5	PASS
2474 MHz	-16.765	0.5	PASS

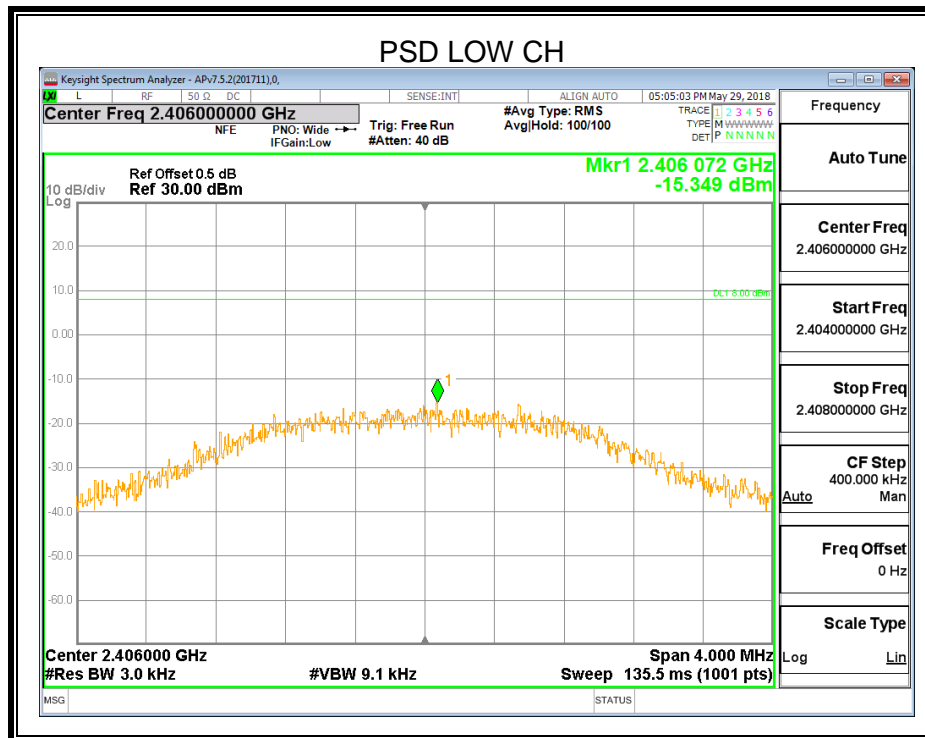

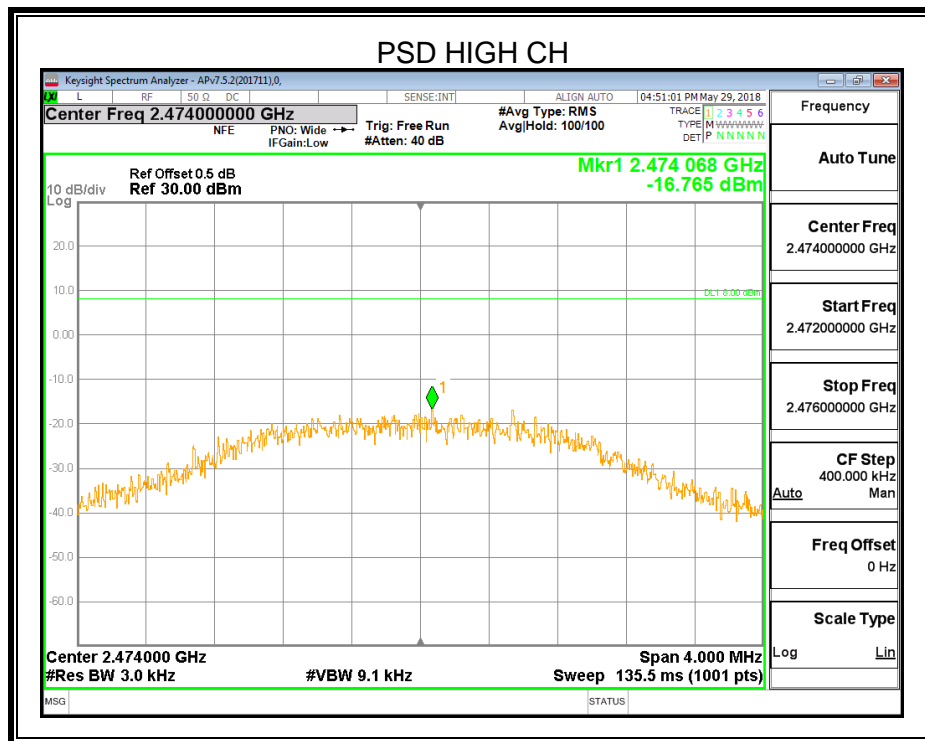
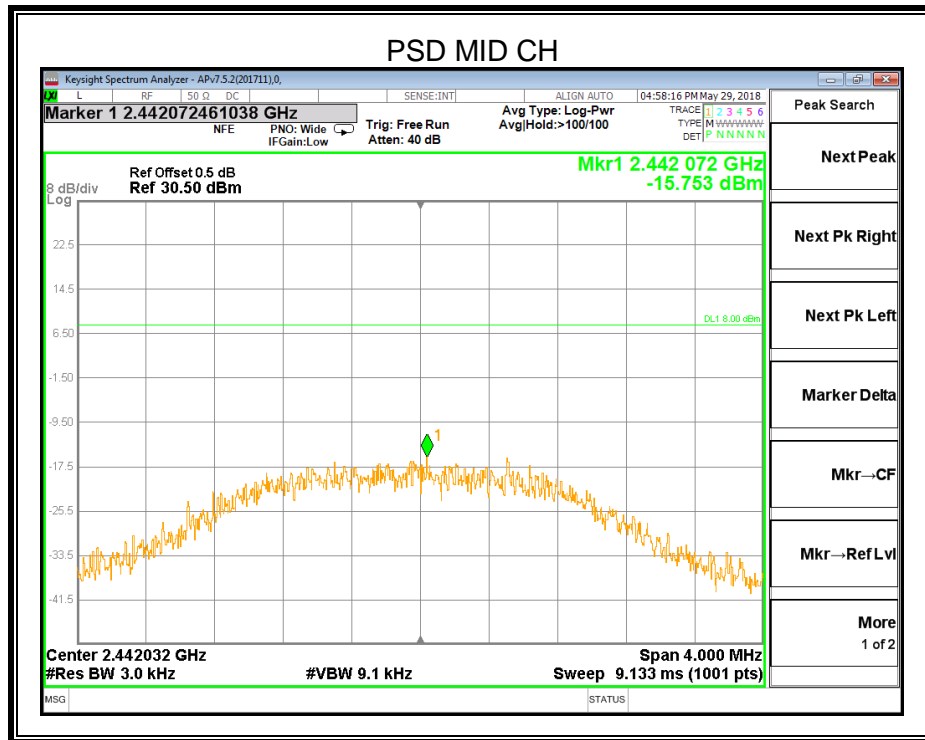

## 7.5. CONDUCTED BANDEGE AND SPURIOUS EMISSIONS

### LIMITS

FCC Part15 (15.247) Subpart C RSS-247 ISSUE 2		
Section	Test Item	Limit
FCC §15.247 (d) RSS-247 5.5	Conducted Bandedge and Spurious Emissions	at least 20 dB below that in the 100 kHz bandwidth within the band that contains the highest level of the desired power

### TEST PROCEDURE

Connect the UUT to the spectrum analyser and use the following settings:

Center Frequency	The center frequency of the channel under test
Detector	Peak
RBW	100K
VBW	$\geq 3 \times \text{RBW}$
Span	1.5 x DTS bandwidth
Trace	Max hold
Sweep time	Auto couple.

Use the peak marker function to determine the maximum PSD level.

Span	Set the center frequency and span to encompass frequency range to be measured
Detector	Peak
RBW	100K
VBW	$\geq 3 \times \text{RBW}$
measurement points	$\geq \text{span}/\text{RBW}$
Trace	Max hold
Sweep time	Auto couple.

Use the peak marker function to determine the maximum amplitude level.

### TEST SETUP

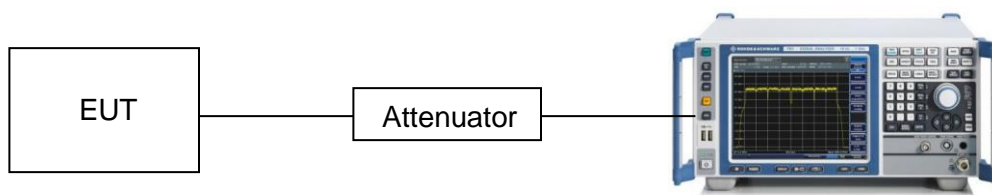





**TEST ENVIRONMENT**

Temperature	24.2°C	Relative Humidity	58%
Atmosphere Pressure	101kPa	Test Voltage	AC 120V

**RESULTS**

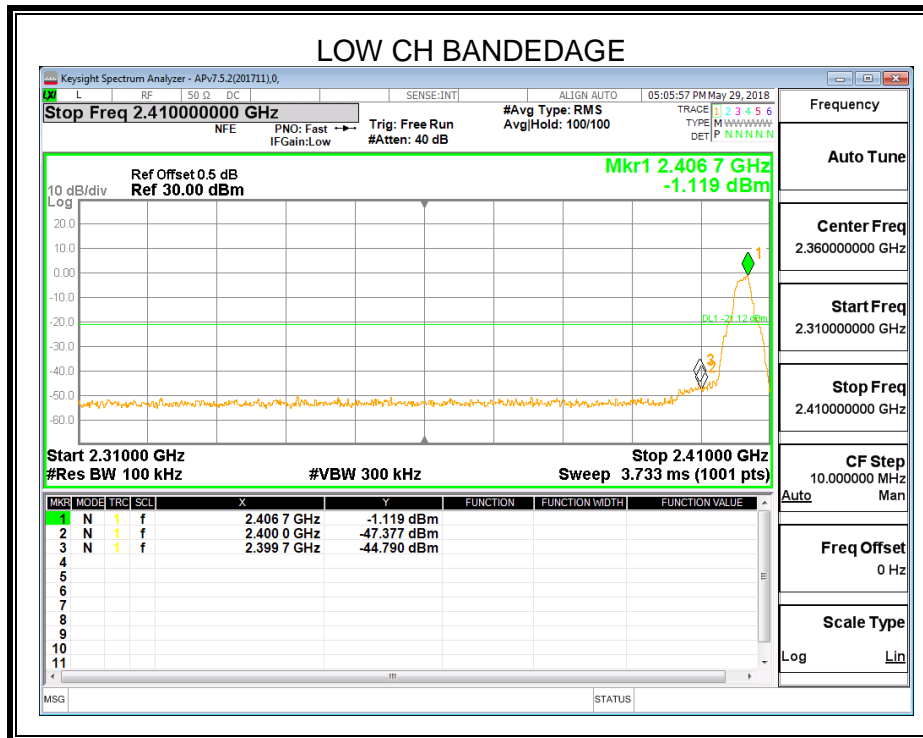

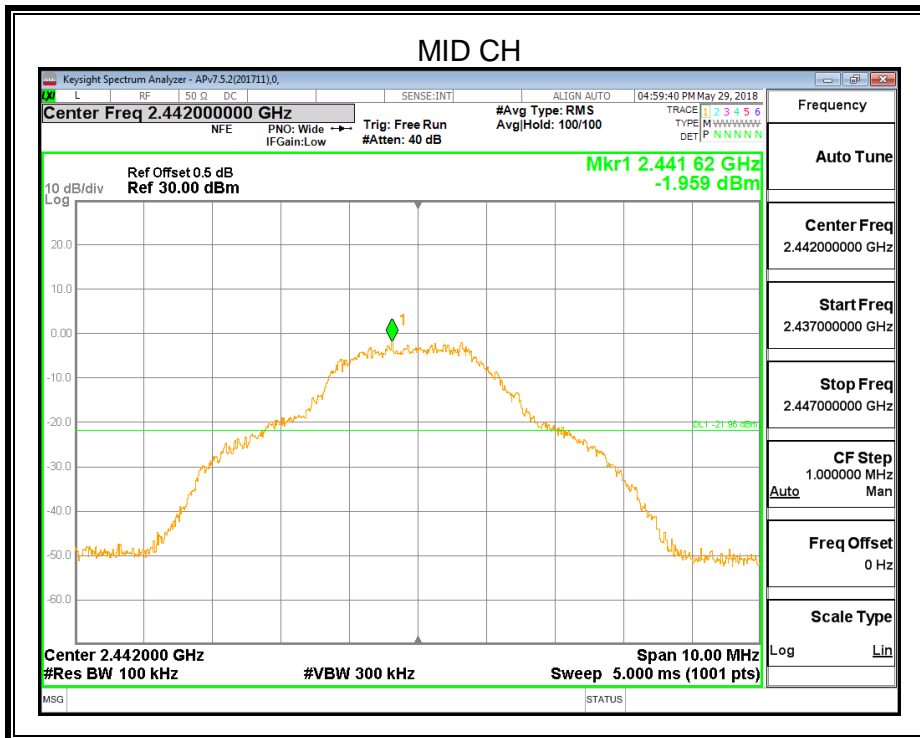
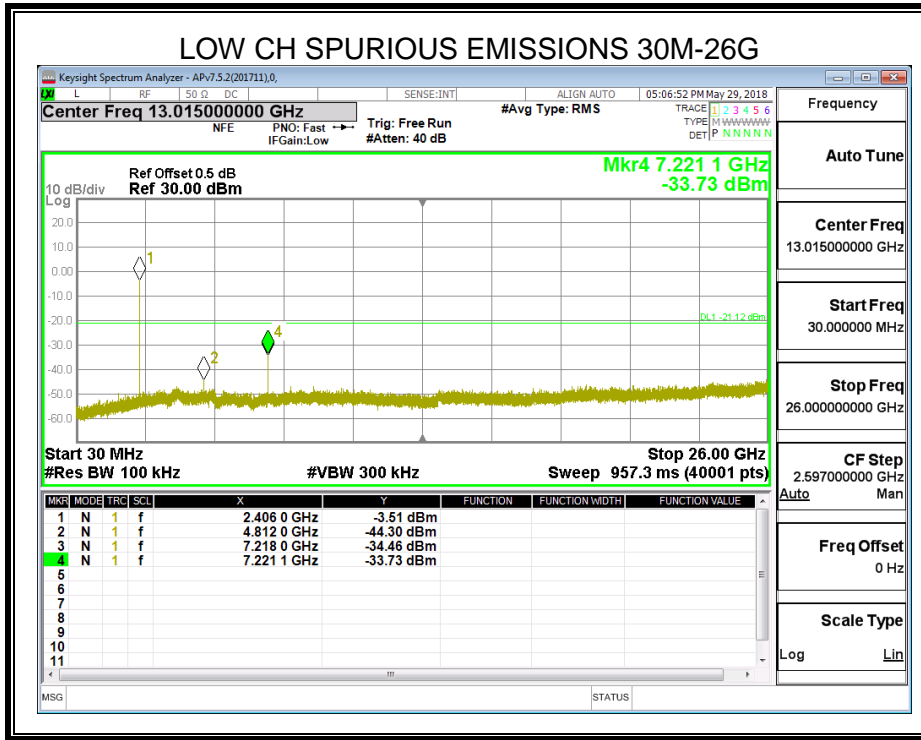

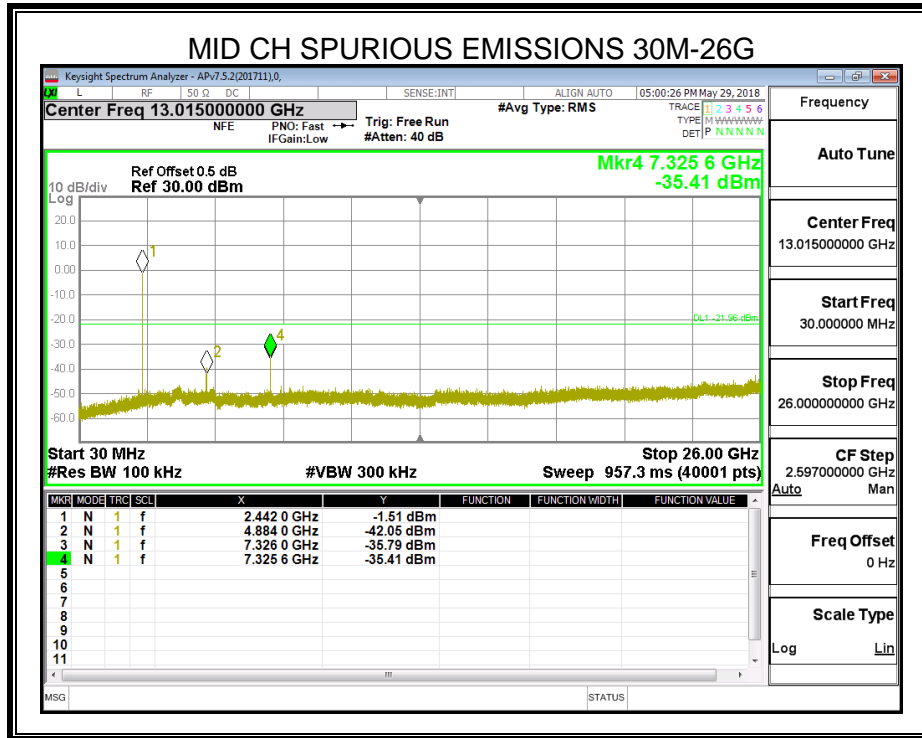

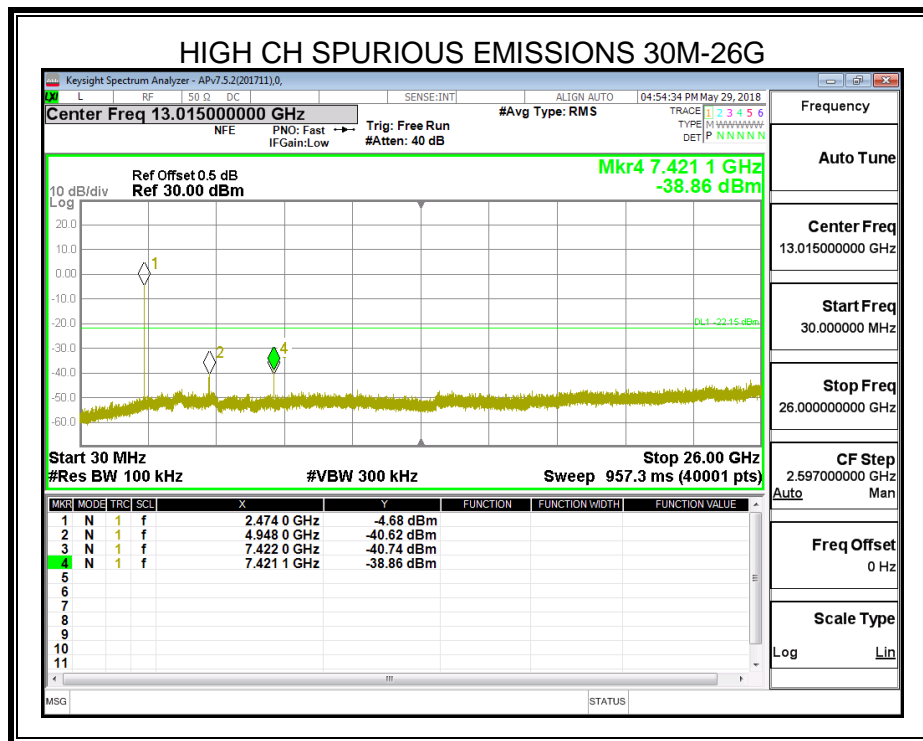
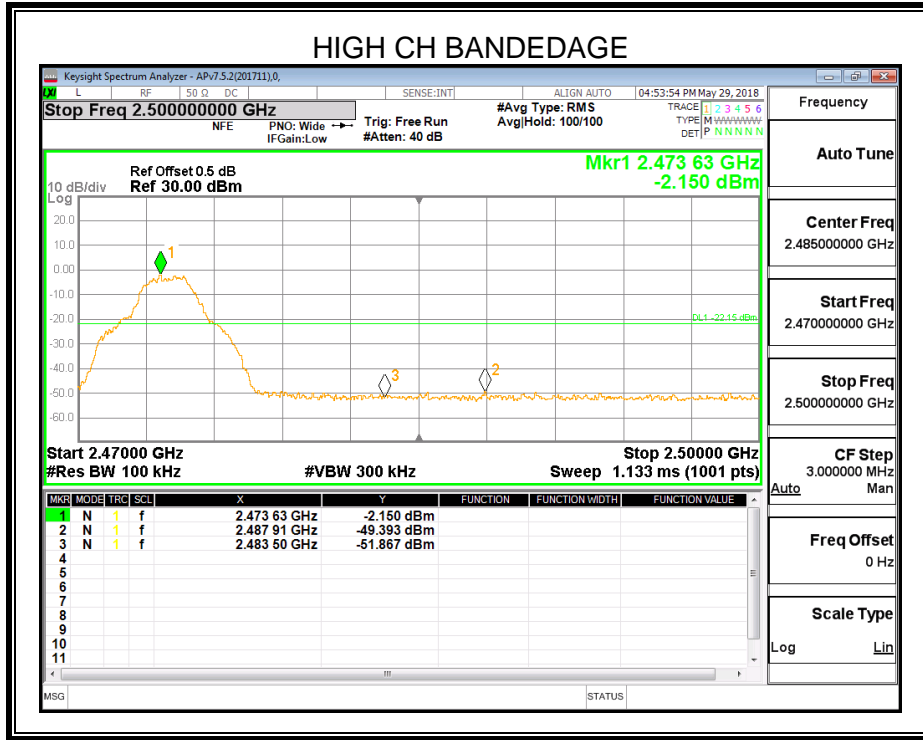



## 8. RADIATED TEST RESULTS

### LIMITS

Please refer to FCC §15.205 and §15.209  
Please refer to RSS-GEN Clause 8.9 and Clause 8.10

Radiation Disturbance Test Limit for FCC (Class B)(9KHz-1GHz)

Frequency (MHz)	Field Strength (microvolts/meter)	Measurement Distance (meters)
0.009~0.490	2400/F(KHz)	300
0.490~1.705	24000/F(KHz)	30
1.705~30.0	30	30
30~88	100	3
88~216	150	3
216~960	200	3
960~1000	500	3

Note: 1) At frequencies at or above 30 MHz, measurements may be performed at a distance other than what is specified provided: measurements are not made in the near field except where it can be shown that near field measurements are appropriate due to the characteristics of the device; and it can be demonstrated that the signal levels needed to be measured at the distance employed can be detected by the measurement equipment. Measurements shall not be performed at a distance greater than 30 meters unless it can be further demonstrated that measurements at a distance of 30 meters or less are impractical. When performing measurements at a distance other than that specified, the results shall be extrapolated to the specified distance using an extrapolation factor of 20 dB/decade (inverse linear-distance for field strength measurements; inverse-linear-distance-squared for power density measurements).

(2) At frequencies below 30 MHz, measurements may be performed at a distance closer than that specified in the regulations; however, an attempt should be made to avoid making measurements in the near field. Pending the development of an appropriate measurement procedure for measurements performed below 30 MHz, when performing measurements at a closer distance than specified, the results shall be extrapolated to the specified distance by either making measurements at a minimum of two distances on at least one radial to determine the proper extrapolation factor or by using the square of an inverse linear distance extrapolation factor (40 dB/decade). This paragraph (f) shall not apply to Access BPL devices operating below 30 MHz.

Radiation Disturbance Test Limit for FCC (Above 1G)

Frequency (MHz)	dB(uV/m) (at 3 meters)	
	Peak	Average

About Restricted bands of operation please refer to RSS-Gen section 8.10 and FCC §15.205 (a)

## TEST SETUP AND PROCEDURE

Below 30MHz

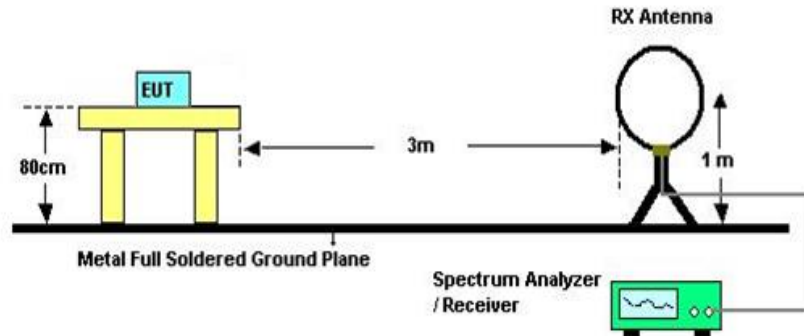

The setting of the spectrum analyser

RBW	200Hz (From 9kHz to 0.15MHz)/ 9KHz (From 0.15MHz to 30MHz)
VBW	200Hz (From 9kHz to 0.15MHz)/ 9KHz (From 0.15MHz to 30MHz)
Sweep	Auto
Trace	Max hold

1. The testing follows the guidelines in ANSI C63.10-2013
2. The EUT was arranged to its worst case and then turntable (from 0 degree to 360 degrees) to find the maximum reading. A pre-amp and a high pass filter are used for the test in order to get better signal level. Both horizontal and vertical polarizations of the antenna are set to make the measurement.
3. The EUT was placed on a turntable with 80cm above ground.
4. The EUT was set 3 meters from the interference receiving antenna, which was mounted on the top of a variable height antenna tower.
5. The radiated emission limits are based on measurements employing a CISPR quasi-peak detector except for the frequency bands 9-90 kHz, 110-490 kHz and above 1000 MHz. Radiated emission limits in these three bands are based on measurements employing an average detector.
6. For measurement below 1GHz, the initial step in collecting conducted emission data is a spectrum analyzer peak detector mode pre-scanning the measurement frequency range. Significant peaks are then marked and then Quasi Peak and average detector mode re-measured. If the emission level of the EUT measured by the peak detector is 3 dB lower than the applicable limit, the peak emission level will be reported. Otherwise, the emission measurement will be repeated using the quasi-peak and average detector and reported.
7. For the actual test configuration, please refer to the related item in this test report (Photographs of the Test Configuration)
8. Although these tests were performed other than open area test site, adequate comparison measurements were confirmed against 30m open are test site. Therefore sufficient tests were made to demonstrate that the alternative site produces results that correlate with the ones of tests made in an open field based on KDB 414788.

Below 1G and above 30MHz

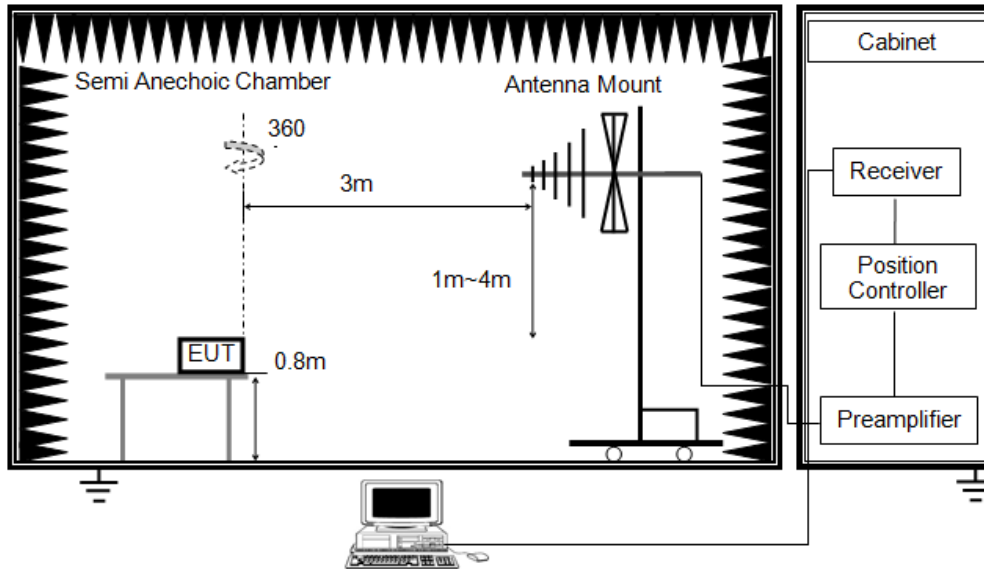

The setting of the spectrum analyser

RBW	120K
VBW	300K
Sweep	Auto
Detector	Peak/QP
Trace	Max hold

1. The testing follows the guidelines in ANSI C63.10-2013.
2. The EUT was arranged to its worst case and then tune the antenna tower (from 1 m to 4 m) and turntable (from 0 degree to 360 degrees) to find the maximum reading. A pre-amp and a high pass filter are used for the test in order to get better signal level. Both horizontal and vertical polarizations of the antenna are set to make the measurement.
3. The EUT was placed on a turntable with 80cm above ground.
4. The EUT was set 3 meters from the interference receiving antenna, which was mounted on the top of a variable height antenna tower.
5. For measurement below 1GHz, the initial step in collecting conducted emission data is a spectrum analyzer peak detector mode pre-scanning the measurement frequency range. Significant peaks are then marked and then Quasi Peak detector mode re-measured. If the emission level of the EUT measured by the peak detector is 3 dB lower than the applicable limit, the peak emission level will be reported. Otherwise, the emission measurement will be repeated using the quasi-peak detector and reported.
6. For the actual test configuration, please refer to the related item in this test report (Photographs of the Test Configuration)

Above 1G

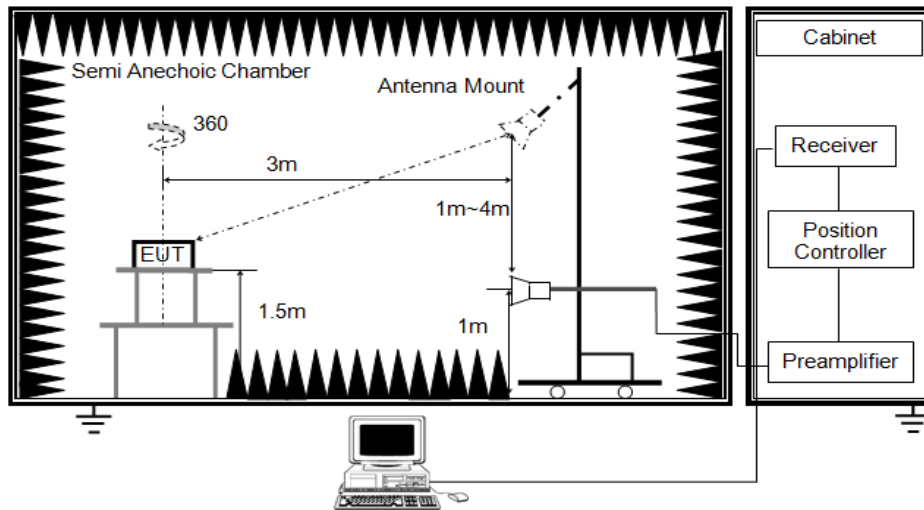

The setting of the spectrum analyser

RBW	1M
VBW	PEAK: 3M AVG: see note 6
Sweep	Auto
Detector	Peak
Trace	Max hold

1. The testing follows the guidelines in ANSI C63.10-2013.
2. The EUT was arranged to its worst case and then tune the antenna tower (1.5 m) and turntable (from 0 degree to 360 degrees) to find the maximum reading. A pre-amp and a high pass filter are used for the test in order to get better signal level. Both horizontal and vertical polarizations of the antenna are set to make the measurement.
3. The EUT was placed on a turntable with 80cm above ground.
4. The EUT was set 3 meters from the interference receiving antenna, which was mounted on the top of a variable height antenna tower.
5. For measurement above 1GHz, the emission measurement will be measured by the peak detector. This peak level, once corrected, must comply with the limit specified in Section 15.209.
6. For measurements above 1 GHz the resolution bandwidth is set to 1 MHz, then the video bandwidth is set to 3 MHz for peak measurements and 1 MHz resolution bandwidth with 1/T video bandwidth with peak detector. For the Duty Cycle and Correction Factor please refer to clause 7.1.ON TIME AND DUTY CYCLE. The EUT is configured to transmit with  $D \geq 98\%$ , then set  $VBW \leq RBW / 100$ , but not less than 10 Hz.
7. For the actual test configuration, please refer to the related Item in this test report (Photographs of the Test Configuration)





X axis, Y axis, Z axis positions:

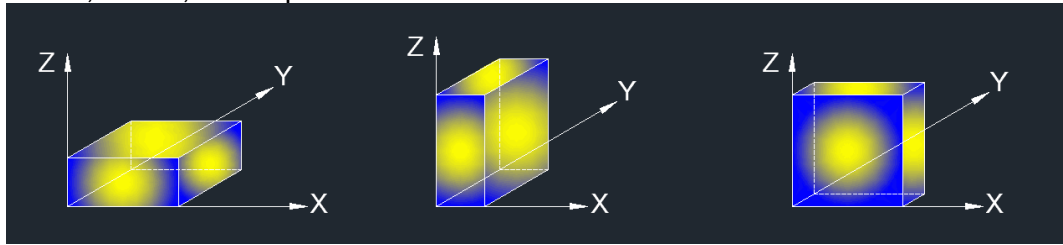

Note: For all radiated test, EUT in each of three orthogonal axis emissions had been tested, but only the worst case (X axis) data recorded in the report.

**TEST ENVIRONMENT**

Temperature	24.8°C	Relative Humidity	56%
Atmosphere Pressure	101kPa	Test Voltage	AC 120V

**8.1. RESTRICTED BANDEDGE**

**RESTRICTED BANDEDGE (LOW CHANNEL, HORIZONTAL)**

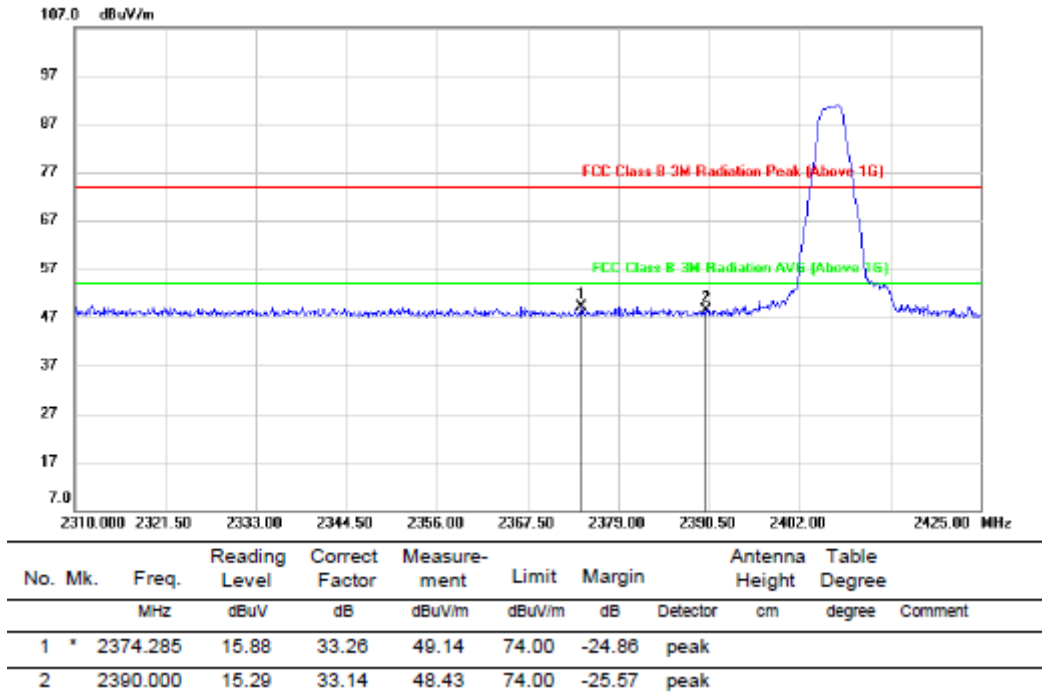

Note: 1. Measurement = Reading Level + Correct Factor.  
 2. If Peak Result complies with AV limit, AV Result is deemed to comply with AV limit.  
 3. Peak: Peak detector.



**RESTRICTED BANDEDGE (LOW CHANNEL, VERTICAL)**

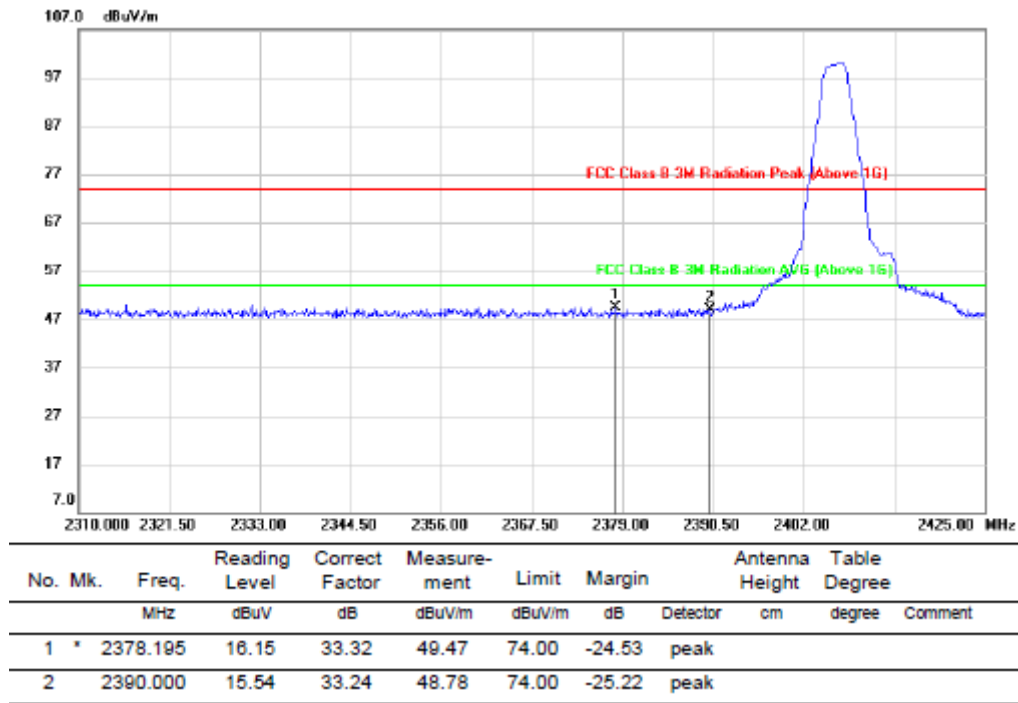

- Note: 1. Measurement = Reading Level + Correct Factor.  
 2. If Peak Result complies with AV limit, AV Result is deemed to comply with AV limit.  
 3. Peak: Peak detector.



**RESTRICTED BANDEDGE (HIGH CHANNEL, HORIZONTAL)**

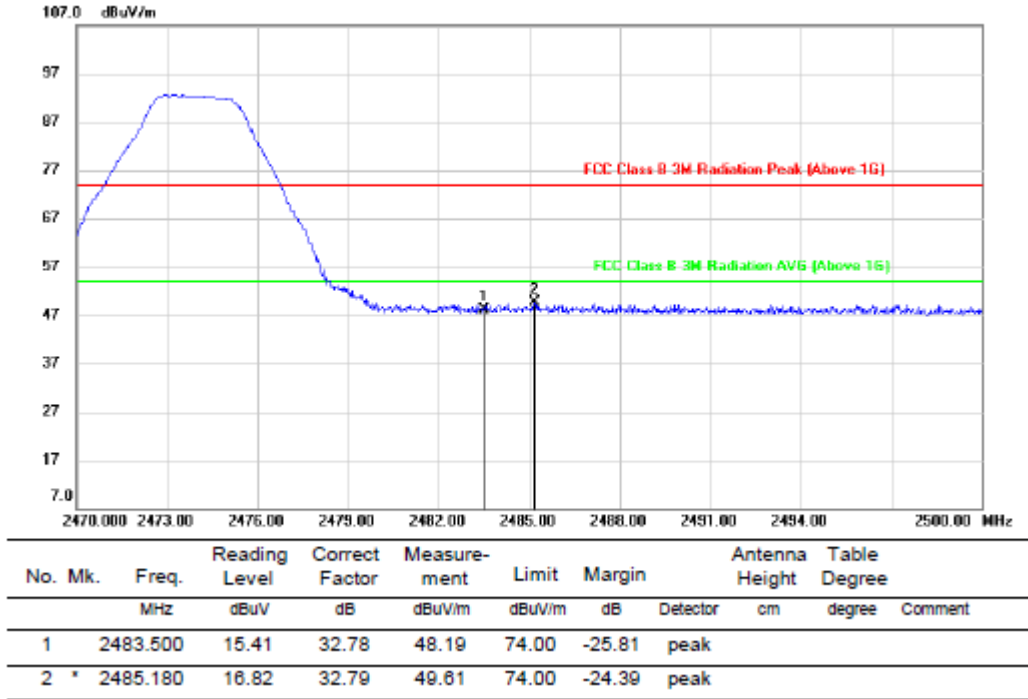

- Note: 1. Measurement = Reading Level + Correct Factor.  
 2. If Peak Result complies with AV limit, AV Result is deemed to comply with AV limit.  
 3. Peak: Peak detector.



**RESTRICTED BANDEDGE (HIGH CHANNEL, VERTICAL)**

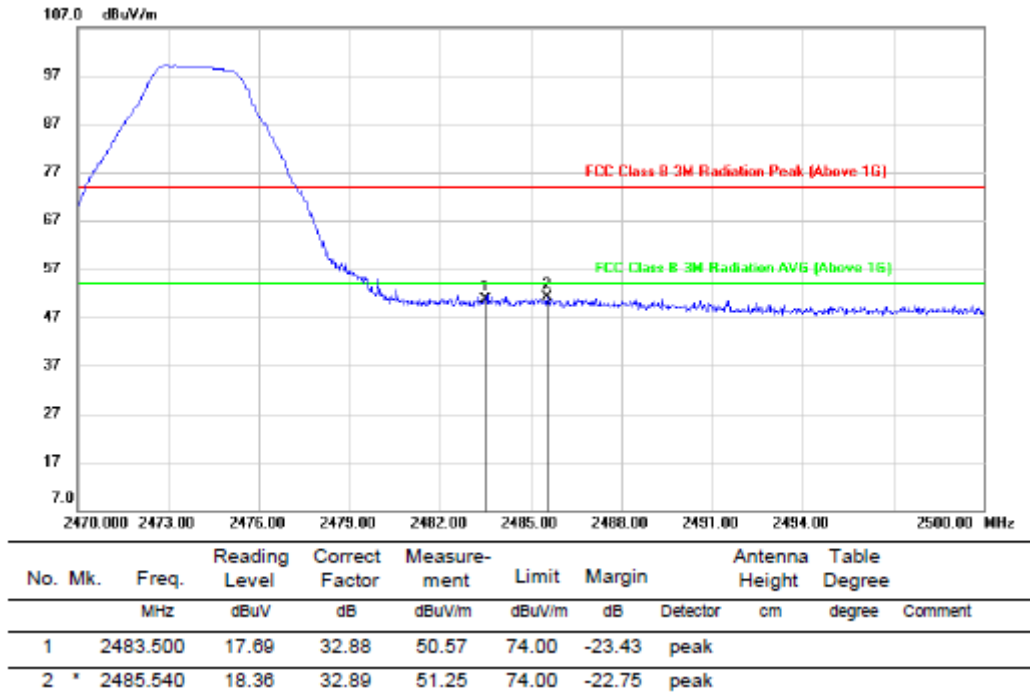

- Note:
1. Measurement = Reading Level + Correct Factor.
  2. If Peak Result complies with AV limit, AV Result is deemed to comply with AV limit.
  3. Peak: Peak detector.



## 8.2. SPURIOUS EMISSIONS (1~3GHz)

### HARMONICS AND SPURIOUS EMISSIONS (LOW CHANNEL, HORIZONTAL)

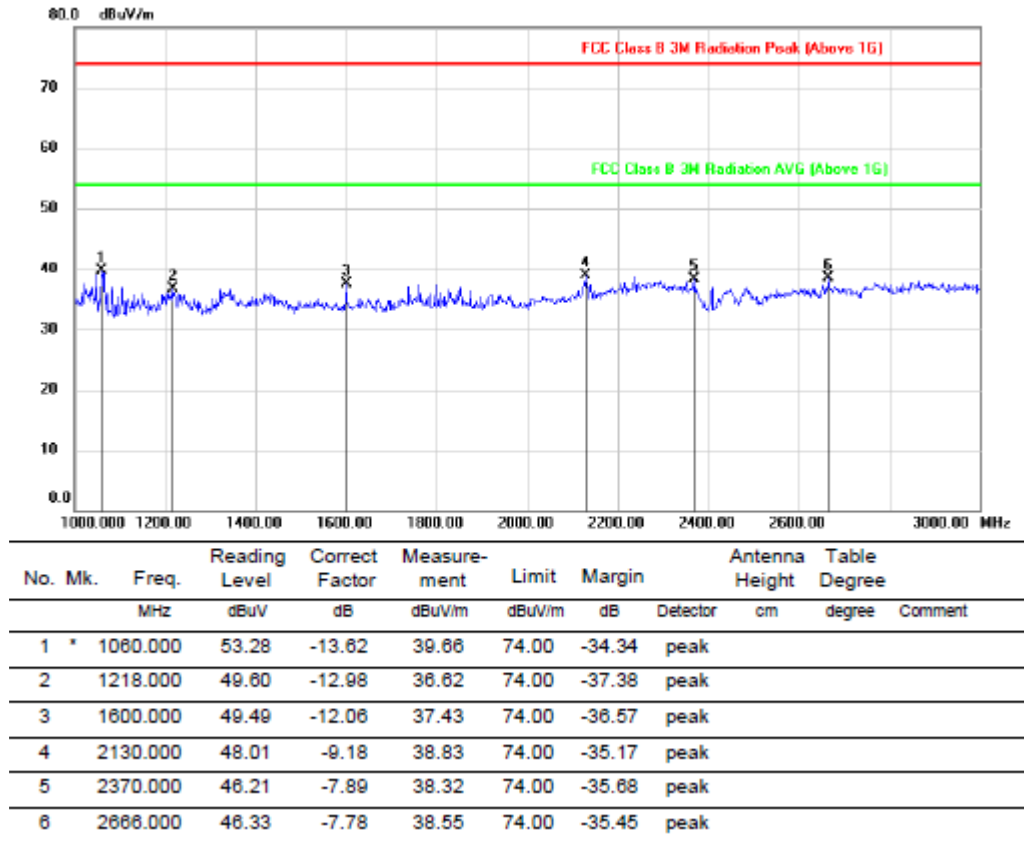

Note: 1. Peak Result = Reading Level + Correct Factor.  
 2. If Peak Result complies with AV limit, AV Result is deemed to comply with AV limit.  
 3. Peak: Peak detector.



**HARMONICS AND SPURIOUS EMISSIONS (LOW CHANNEL, VERTICAL)**

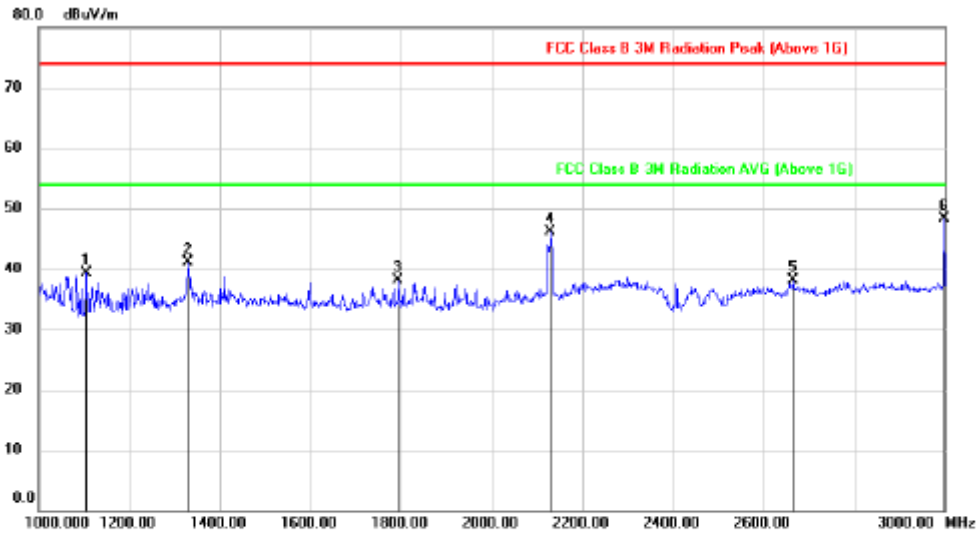

No. Mk.	Freq. MHz	Reading Level dBuV	Correct Factor dB	Measurement dBuV/m	Limit dBuV/m	Margin dB	Antenna Height cm	Table Degree	Comment
1	1106.000	53.10	-13.83	39.27	74.00	-34.73	peak		
2	1330.000	53.56	-12.50	41.06	74.00	-32.94	peak		
3	1794.000	49.21	-11.15	38.06	74.00	-35.94	peak		
4	2130.000	55.37	-9.28	46.09	74.00	-27.91	peak		
5	2666.000	46.00	-7.84	38.16	74.00	-35.84	peak		
6 *	2998.000	54.99	-8.60	48.39	74.00	-25.61	peak		

- Note: 1. Peak Result = Reading Level + Correct Factor.  
 2. If Peak Result complies with AV limit, AV Result is deemed to comply with AV limit.  
 3. Peak: Peak detector.



**HARMONICS AND SPURIOUS EMISSIONS (MID CHANNEL, HORIZONTAL)**

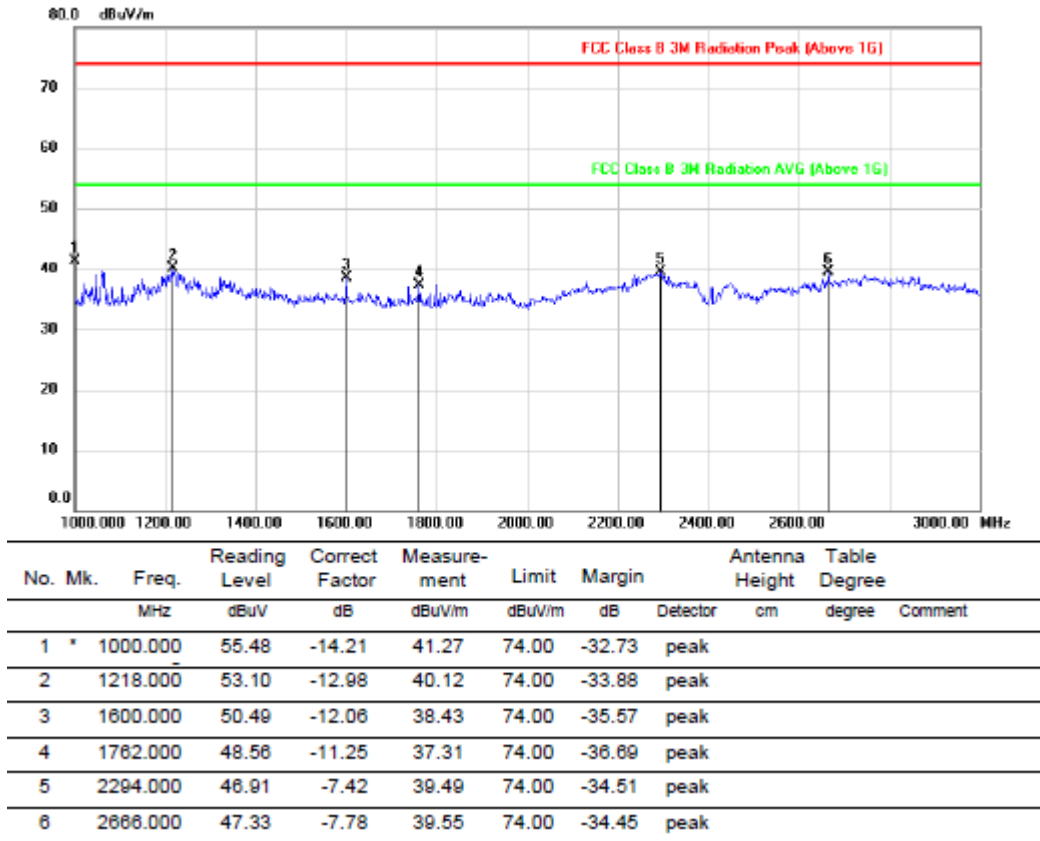

Note: 1. Peak Result = Reading Level + Correct Factor.  
 2. If Peak Result complies with AV limit, AV Result is deemed to comply with AV limit.  
 3. Peak: Peak detector.



**HARMONICS AND SPURIOUS EMISSIONS (MID CHANNEL, VERTICAL)**

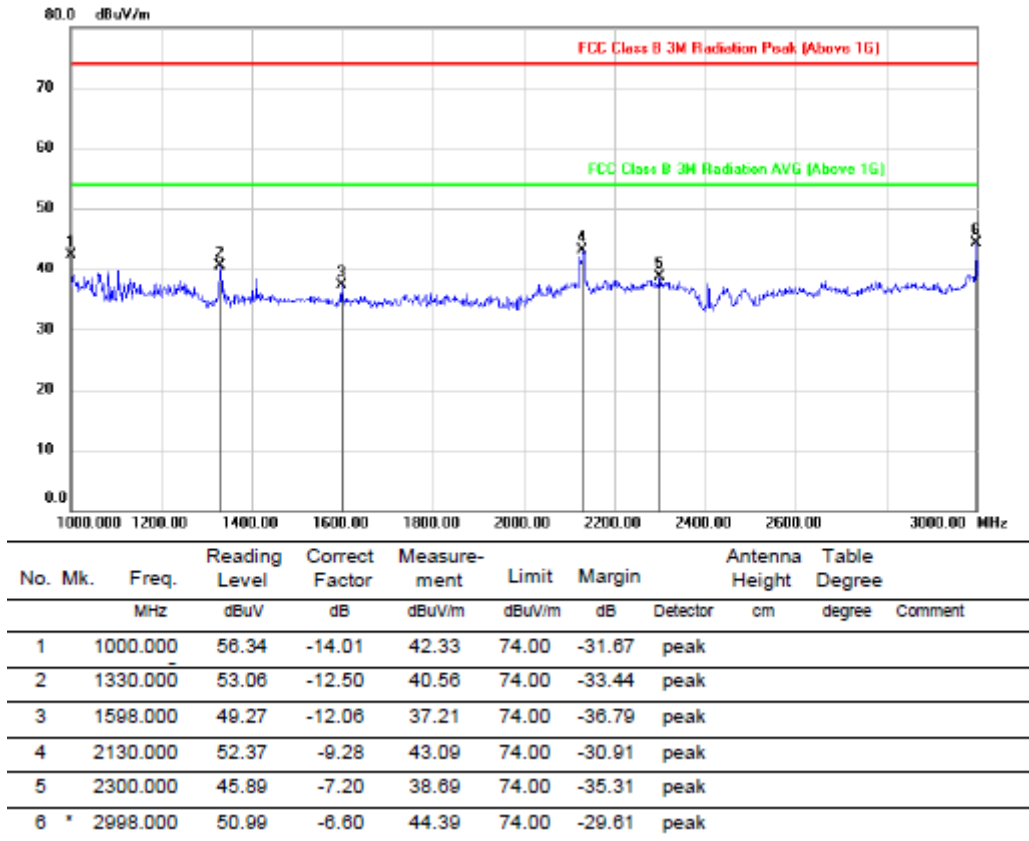

Note: 1. Peak Result = Reading Level + Correct Factor.  
 2. If Peak Result complies with AV limit, AV Result is deemed to comply with AV limit.  
 3. Peak: Peak detector.





**HARMONICS AND SPURIOUS EMISSIONS (HIGH CHANNEL, HORIZONTAL)**

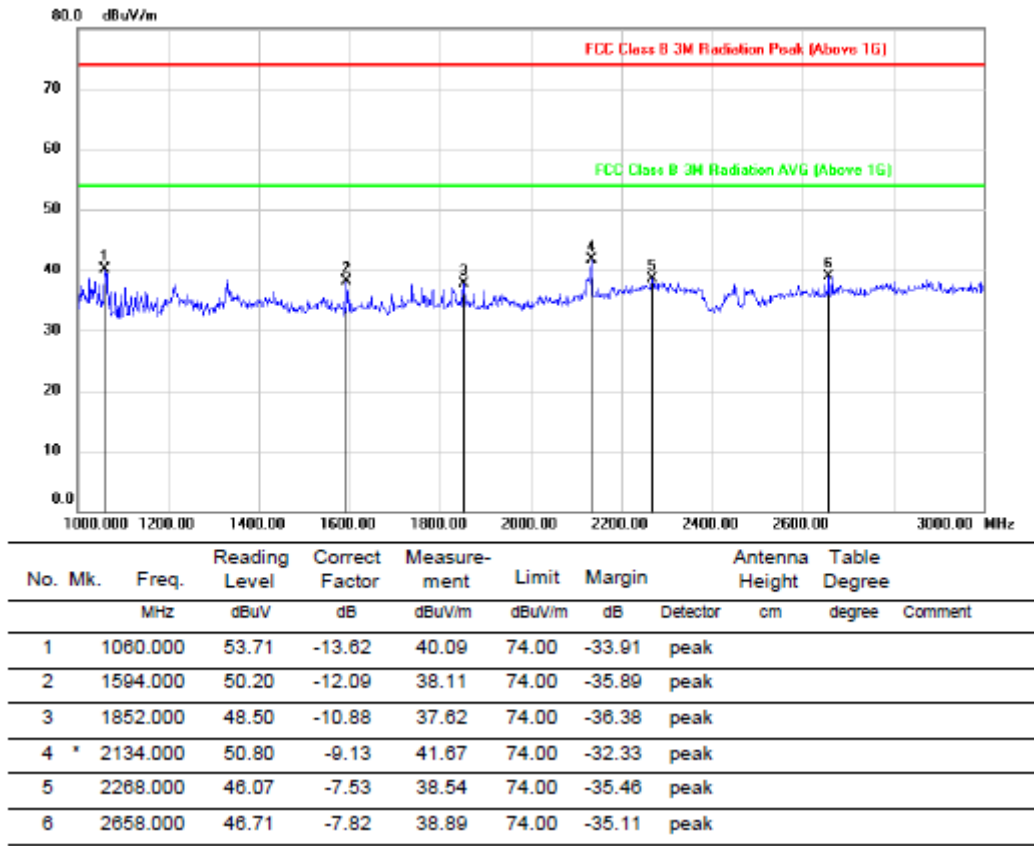

- Note: 1. Peak Result = Reading Level + Correct Factor.  
 2. If Peak Result complies with AV limit, AV Result is deemed to comply with AV limit.  
 3. Peak: Peak detector.



**HARMONICS AND SPURIOUS EMISSIONS (HIGH CHANNEL, VERTICAL)**

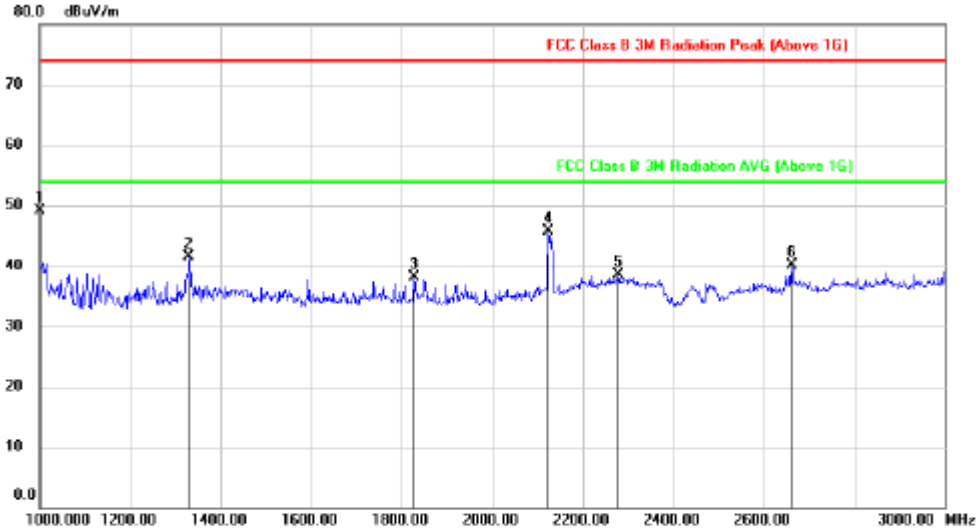

No.	Mk.	Freq.	Reading Level	Correct Factor	Measurement	Limit	Margin	Antenna Height	Table Degree	
		MHz	dBuV	dB	dBuV/m	dBuV/m	dB	cm	degree	Comment
1	*	1000.000	63.08	-14.01	49.07	74.00	-24.93	peak		
2		1330.000	53.99	-12.50	41.49	74.00	-32.51	peak		
3		1828.000	49.16	-10.99	38.17	74.00	-35.83	peak		
4		2124.000	55.13	-9.36	45.77	74.00	-28.23	peak		
5		2278.000	45.78	-7.37	38.41	74.00	-35.59	peak		
6		2662.000	47.96	-7.87	40.09	74.00	-33.91	peak		

- Note: 1. Peak Result = Reading Level + Correct Factor.  
 2. If Peak Result complies with AV limit, AV Result is deemed to comply with AV limit.  
 3. Peak: Peak detector.



### 8.3. SPURIOUS EMISSIONS (3~18GHz)

#### HARMONICS AND SPURIOUS EMISSIONS (LOW CHANNEL, HORIZONTAL)

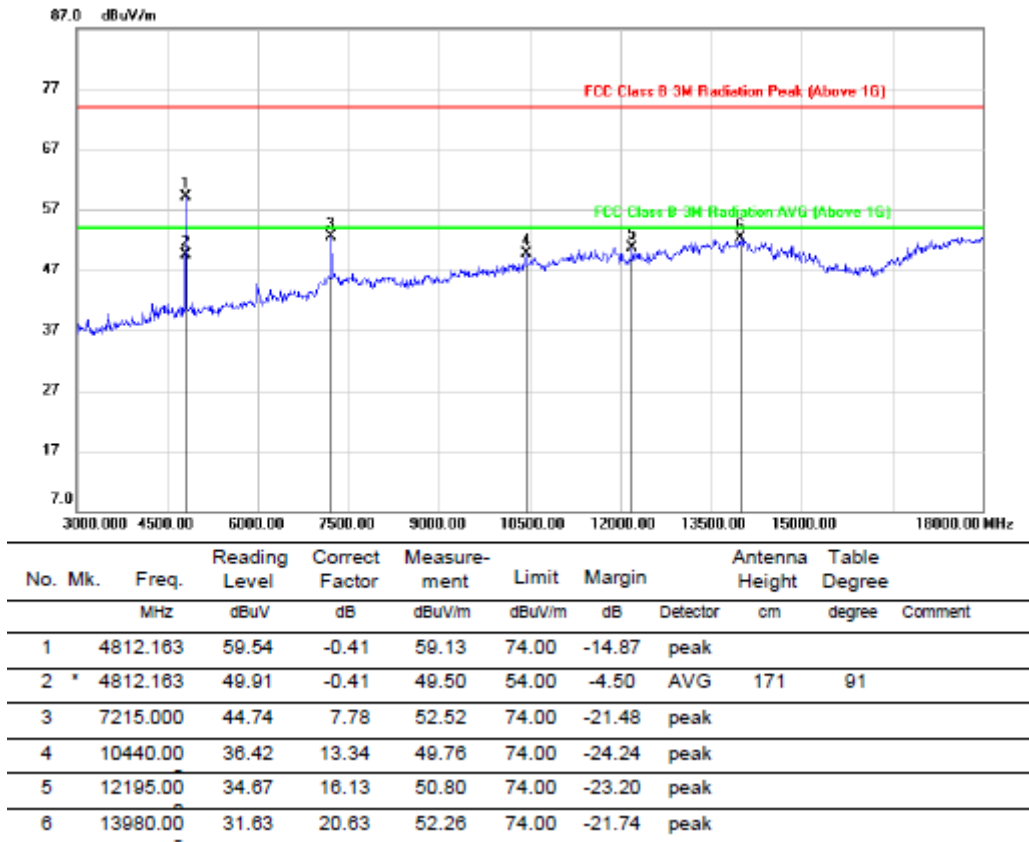

- Note: 1. Peak Result = Reading Level + Correct Factor.  
 2. If Peak Result complies with AV limit, AV Result is deemed to comply with AV limit.  
 3. Peak: Peak detector.  
 4. AVG: VBW=10Hz.  
 5. For transmit duration, please refer to clause 7.1.



**HARMONICS AND SPURIOUS EMISSIONS (LOW CHANNEL, VERTICAL)**

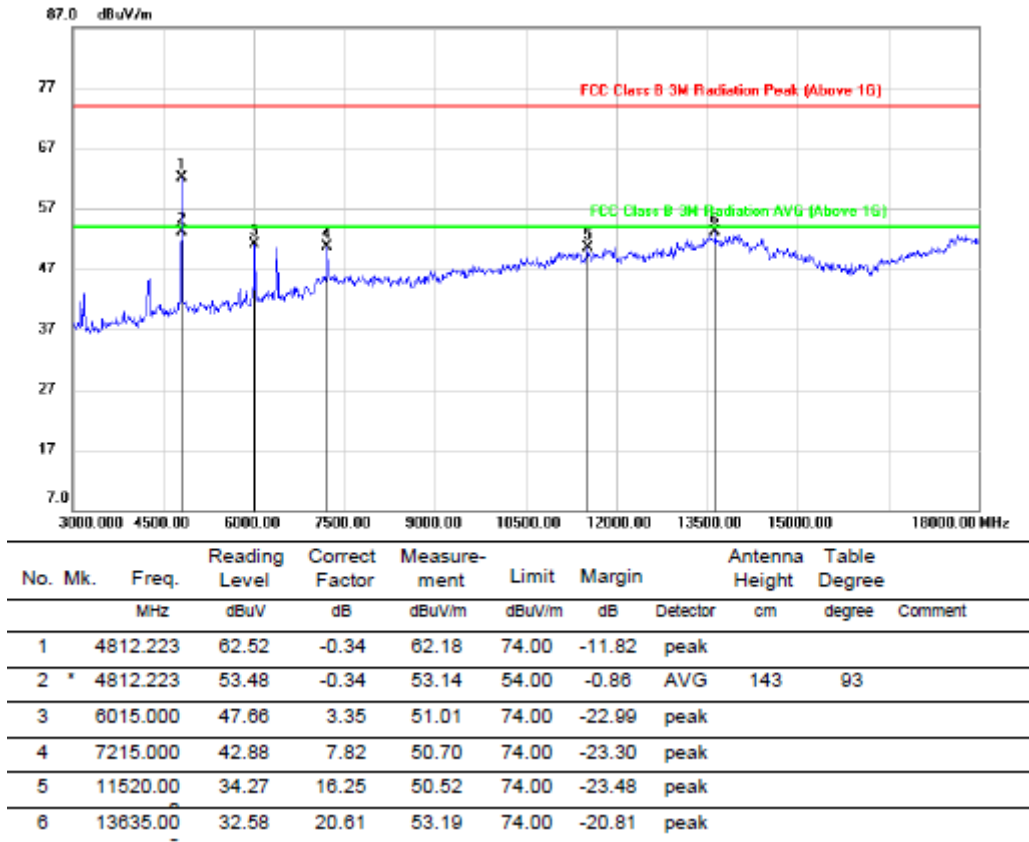

- Note: 1. Peak Result = Reading Level + Correct Factor.  
 2. If Peak Result complies with AV limit, AV Result is deemed to comply with AV limit.  
 3. Peak: Peak detector.  
 4. AVG: VBW=10Hz.  
 5. For transmit duration, please refer to clause 7.1.



**HARMONICS AND SPURIOUS EMISSIONS (MID CHANNEL, HORIZONTAL)**

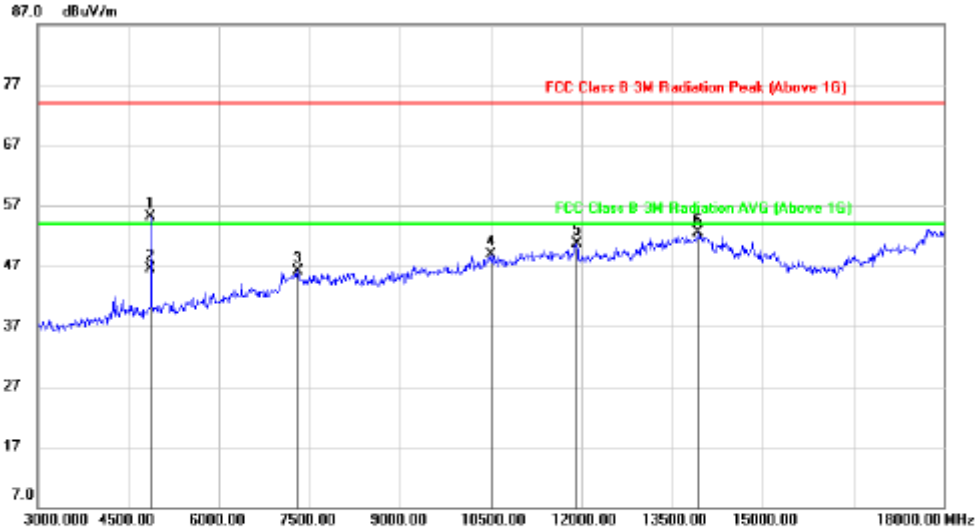

No. Mk.	Freq. MHz	Reading Level dBuV	Correct Factor dB	Measurement dBuV/m	Limit dBuV/m	Margin dB	Detector	Antenna Height cm	Table Degree	Comment
1	4883.711	54.60	0.49	55.09	74.00	-18.91	peak			
2 *	4883.711	46.02	0.49	46.51	54.00	-7.49	AVG	167	12	
3	7305.000	38.40	7.80	46.20	74.00	-27.80	peak			
4	10500.00	35.11	13.71	48.82	74.00	-25.18	peak			
5	11925.00	33.95	16.74	50.69	74.00	-23.31	peak			
6	13920.00	31.82	20.67	52.49	74.00	-21.51	peak			

- Note: 1. Peak Result = Reading Level + Correct Factor.  
 2. If Peak Result complies with AV limit, AV Result is deemed to comply with AV limit.  
 3. Peak: Peak detector.  
 4. AVG: VBW=10Hz.  
 5. For transmit duration, please refer to clause 7.1.



**HARMONICS AND SPURIOUS EMISSIONS (MID CHANNEL, VERTICAL)**

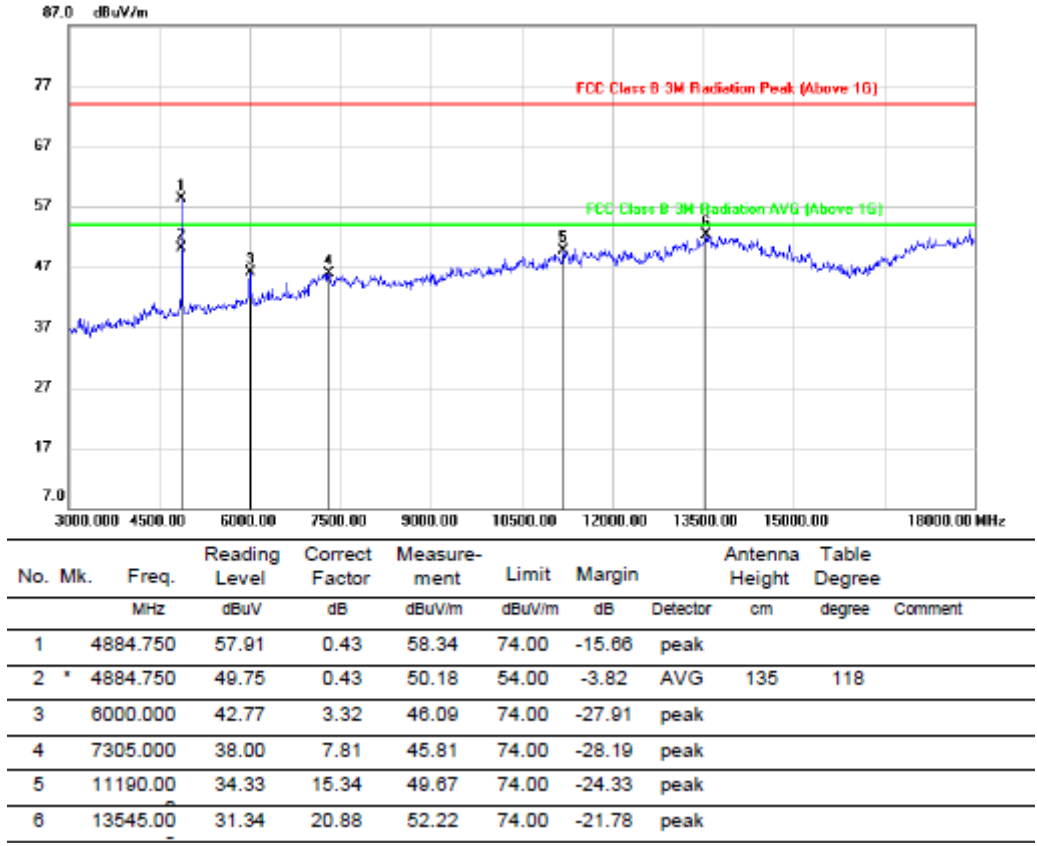

- Note:
1. Peak Result = Reading Level + Correct Factor.
  2. If Peak Result complies with AV limit, AV Result is deemed to comply with AV limit.
  3. Peak: Peak detector.
  4. AVG: VBW=10Hz.
  5. For transmit duration, please refer to clause 7.1.



**HARMONICS AND SPURIOUS EMISSIONS (HIGH CHANNEL, HORIZONTAL)**

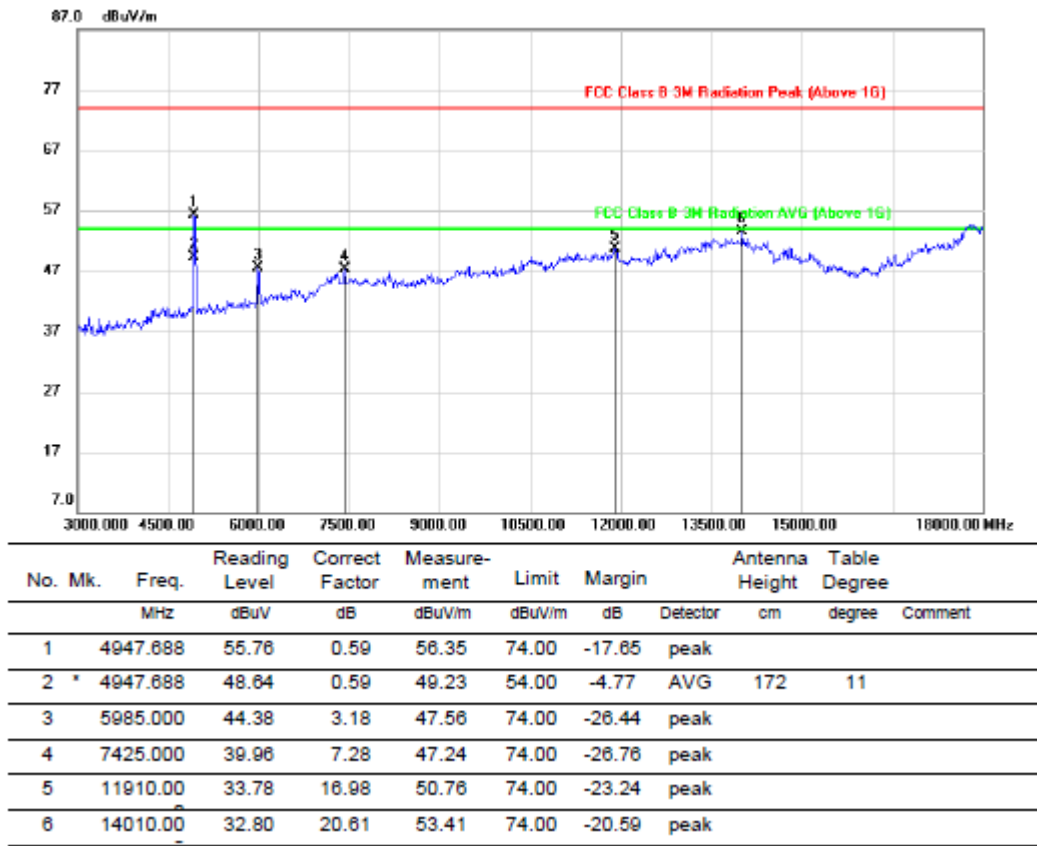

- Note:
1. Peak Result = Reading Level + Correct Factor.
  2. If Peak Result complies with AV limit, AV Result is deemed to comply with AV limit.
  3. Peak: Peak detector.
  4. AVG: VBW=10Hz.
  5. For transmit duration, please refer to clause 7.1.



**HARMONICS AND SPURIOUS EMISSIONS (HIGH CHANNEL, VERTICAL)**

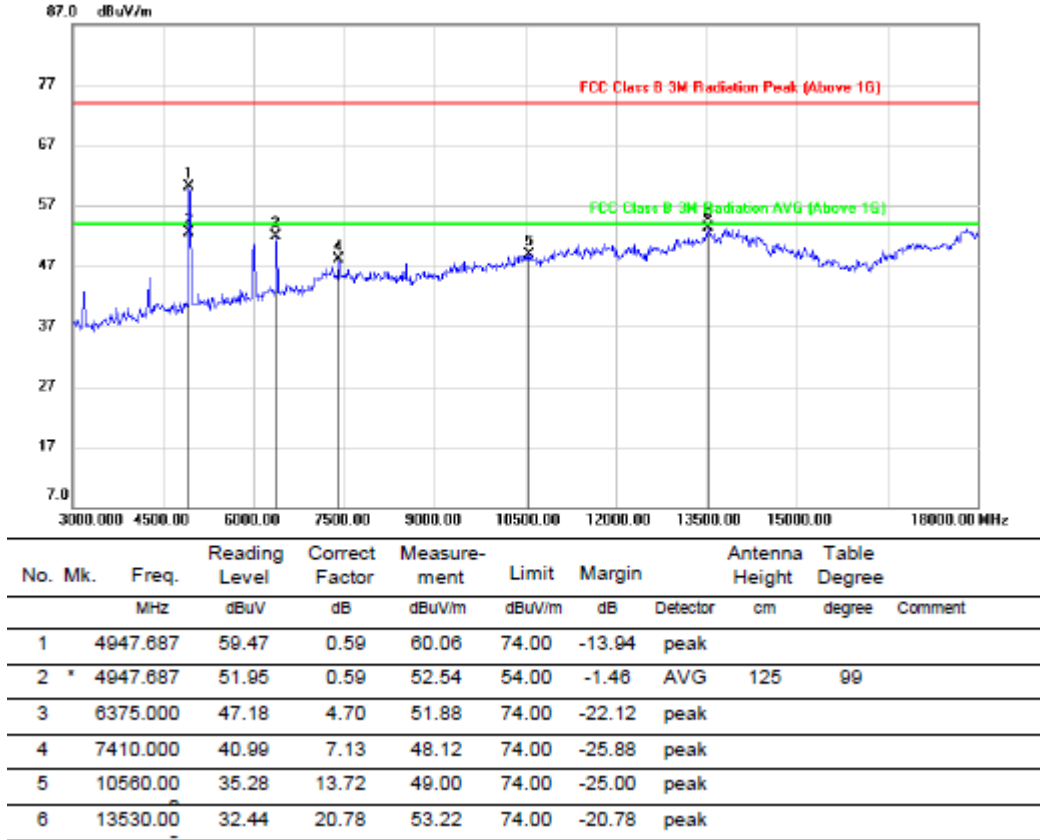

- Note: 1. Peak Result = Reading Level + Correct Factor.  
 2. If Peak Result complies with AV limit, AV Result is deemed to comply with AV limit.  
 3. Peak: Peak detector.  
 4. AVG: VBW=10Hz.  
 5. For transmit duration, please refer to clause 7.1.





### 8.4. SPURIOUS EMISSIONS 18G ~ 26GHz

**SPURIOUS EMISSIONS (MID CHANNEL, WORST-CASE CONFIGURATION, HORIZONTAL)**

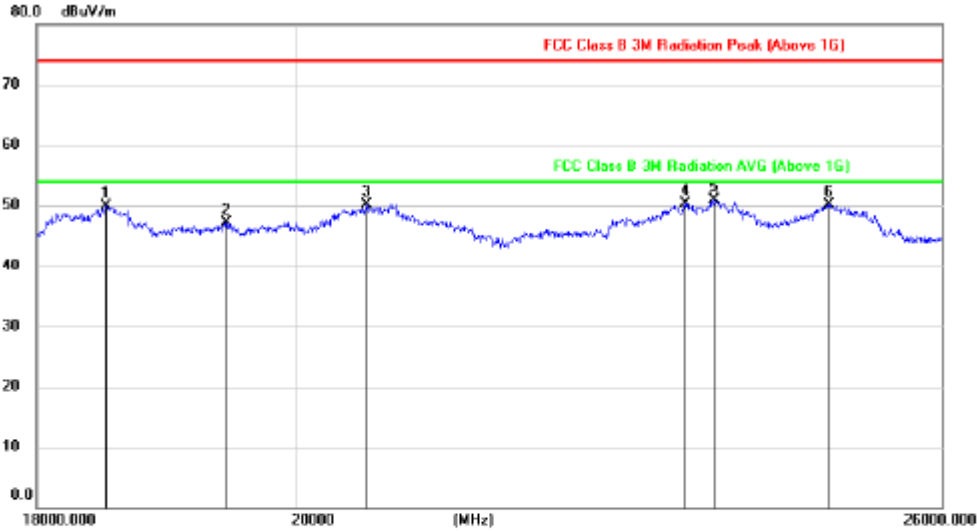

No.	Mk.	Freq. MHz	Reading Level dBuV	Correct Factor dB	Measure- ment dBuV/m	Limit dBuV/m	Margin dB	Detector	Antenna Height cm	Table Degree	Comment
1		18510.14	55.07	-5.26	49.81	74.00	-24.19	peak			
2		19445.07	52.59	-5.56	47.03	74.00	-26.97	peak			
3		20585.59	55.48	-5.27	50.19	74.00	-23.81	peak			
4		23421.89	53.43	-3.21	50.22	74.00	-23.78	peak			
5	*	23698.93	54.15	-3.18	50.97	74.00	-23.03	peak			
6		24831.94	52.27	-2.24	50.03	74.00	-23.97	peak			

- Note: 1. Peak Result = Reading Level + Correct Factor.  
 2. If Peak Result complies with AV limit, AV Result is deemed to comply with AV limit.  
 3. Peak: Peak detector.



**SPURIOUS EMISSIONS (MID CHANNEL, WORST-CASE CONFIGURATION, VERTICAL)**

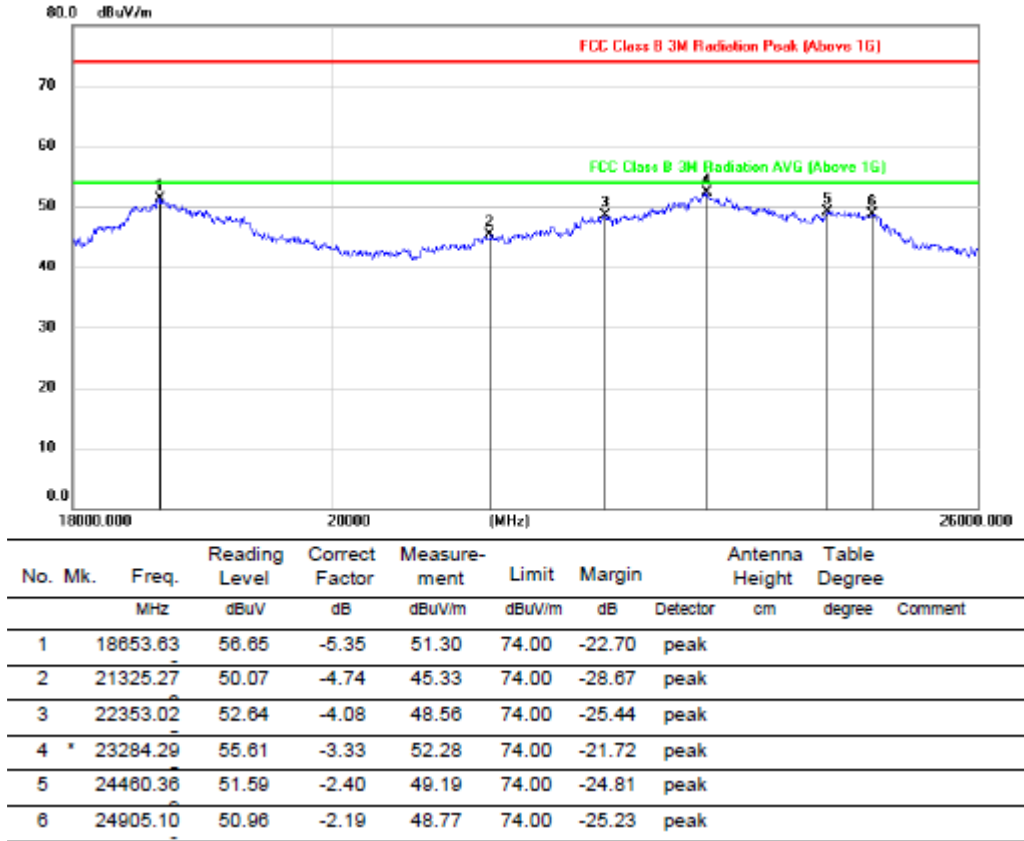

- Note: 1. Peak Result = Reading Level + Correct Factor.  
 2. If Peak Result complies with AV limit, AV Result is deemed to comply with AV limit.  
 3. Peak: Peak detector.

Note: All the modes had been tested, but only the worst data were recorded in the report.



### 8.5. SPURIOUS EMISSIONS 30M ~ 1 GHz

#### SPURIOUS EMISSIONS (MID CHANNEL, WORST-CASE CONFIGURATION, HORIZONTAL)

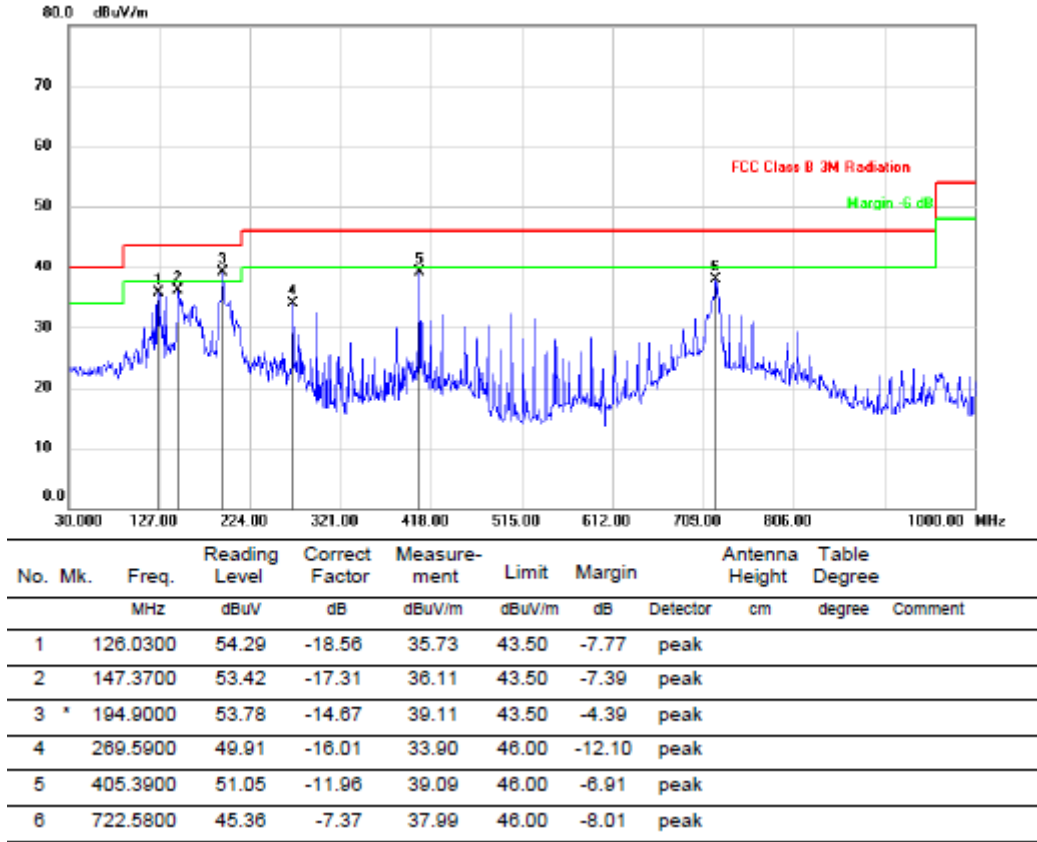

- Note: 1. Result Level = Read Level + Correct Factor.  
 2. If Peak Result complies with QP limit, QP Result is deemed to comply with QP limit.  
 3. Test setup: RBW: 120 kHz, VBW: 300 kHz, Sweep time: auto.



**SPURIOUS EMISSIONS (MID CHANNEL, WORST-CASE CONFIGURATION, VERTICAL)**

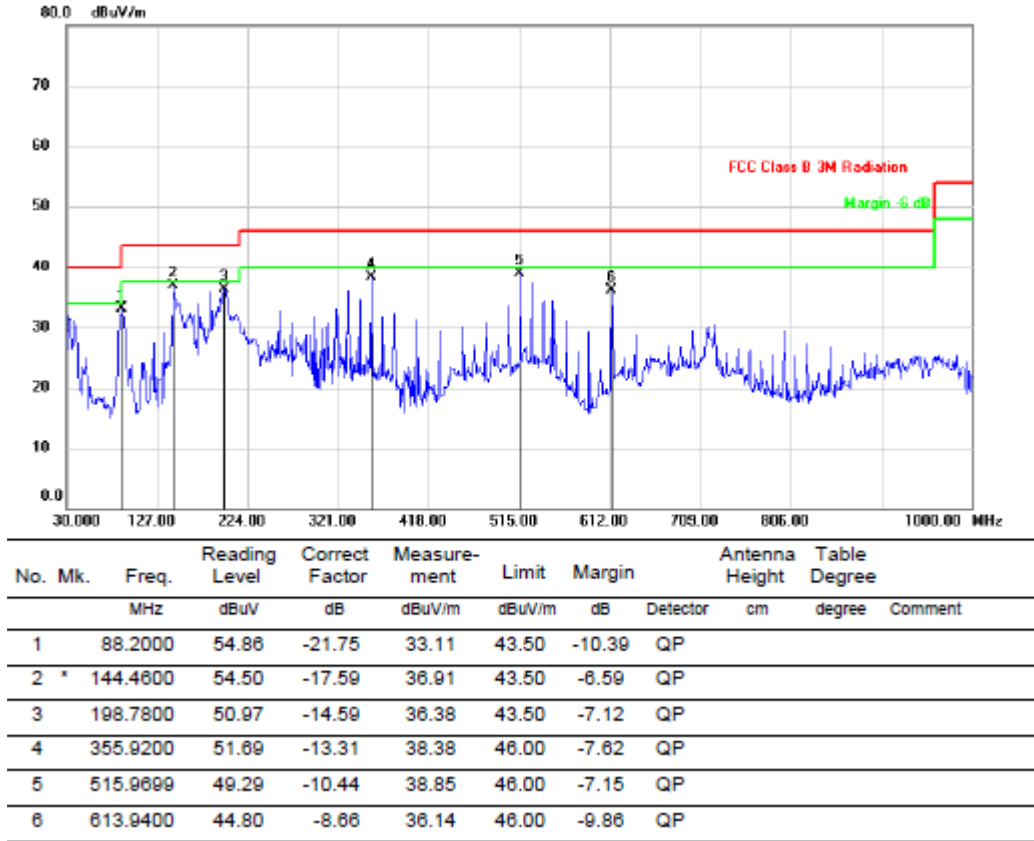

- Note: 1. Result Level = Read Level + Correct Factor.  
 2. If Peak Result complies with QP limit, QP Result is deemed to comply with QP limit.  
 3. Test setup: RBW: 120 kHz, VBW: 300 kHz, Sweep time: auto

Note: All the modes had been tested, but only the worst data were recorded in the report.



## 8.6. SPURIOUS EMISSIONS BELOW 30M

### SPURIOUS EMISSIONS (MID CHANNEL, WORST-CASE CONFIGURATION, HORIZONTAL)

#### 9KHz~ 150KHz

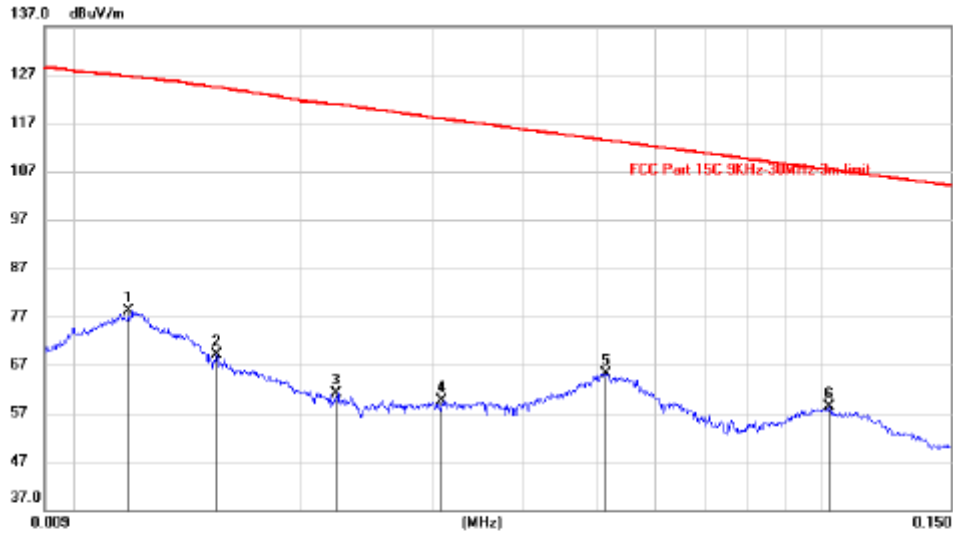

No.	Mk.	Freq. MHz	Reading Level dBuV	Correct Factor dB	Measure- ment dBuV/m	Limit dBuV/m	Margin dB	Antenna Height cm	Table Degree degree	Comment
1		0.0117	57.79	20.23	78.02	126.5	-48.58	peak		
2		0.0154	48.79	20.26	69.05	124.3	-55.30	peak		
3		0.0223	40.78	20.31	61.09	120.7	-59.68	peak		
4		0.0309	39.37	20.31	59.68	117.8	-58.16	peak		
5	*	0.0514	44.93	20.31	65.24	113.4	-48.16	peak		
6		0.1029	38.22	20.23	58.45	107.3	-48.91	peak		

- Note: 1. Measurement = Reading Level + Correct Factor.  
 2. All the modes had been tested, but only the worst data were recorded in the report.  
 3. If Peak Result complies with AV and QP limit, AV and QP Result are deemed to comply with AV limit.



**150KHz ~ 30M**

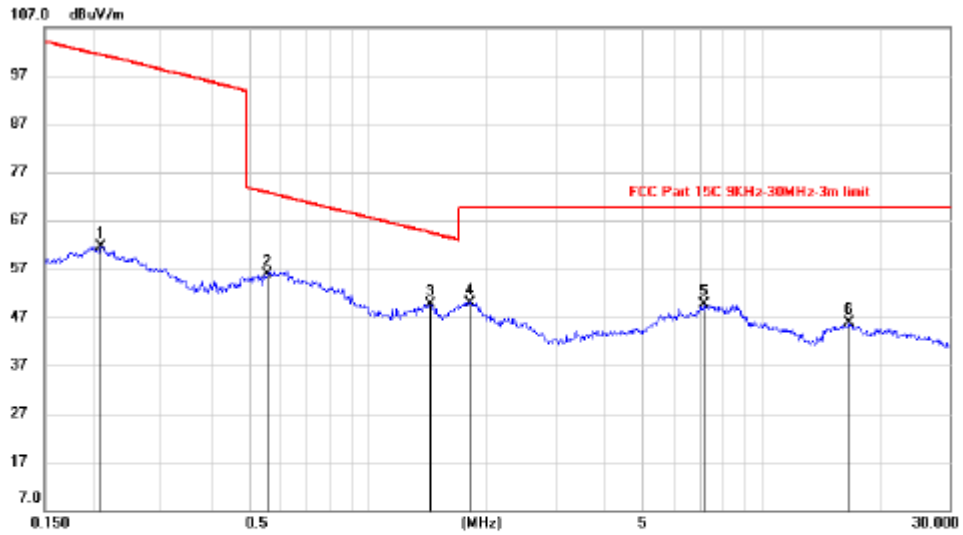

No. Mk.	Freq. MHz	Reading Level dBuV	Correct Factor dB	Measure- ment dBuV/m	Limit dBuV/m	Margin dB	Detector	Antenna Height cm	Table Degree	Comment
1	0.2083	41.28	20.36	61.64	101.2	-39.65	peak			
2	0.5551	35.72	20.26	55.98	72.76	-16.78	peak			
3 *	1.4408	29.15	20.53	49.68	64.44	-14.76	peak			
4	1.8185	29.33	20.67	50.00	69.54	-19.54	peak			
5	7.1374	28.64	20.92	49.56	69.54	-19.98	peak			
6	16.5731	25.00	20.96	45.96	69.54	-23.58	peak			

- Note: 1. Measurement = Reading Level + Correct Factor.  
 2. All the modes had been tested, but only the worst data were recorded in the report.  
 3. If Peak Result complies with AV and QP limit, AV and QP Result are deemed to comply with AV limit.



**SPURIOUS EMISSIONS (MID CHANNEL, WORST-CASE CONFIGURATION, VERTICAL)**

**9KHz~ 150KHz**

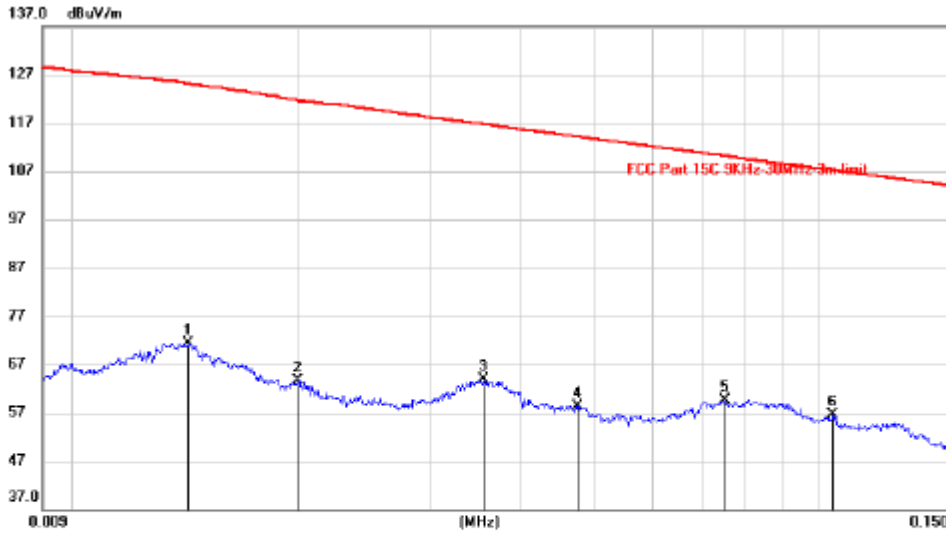

No. Mk.	Freq. MHz	Reading Level dBuV	Correct Factor dB	Measure- ment dBuV/m	Limit dBuV/m	Margin dB	Detector	Antenna Height cm	Table Degree	Comment
1	0.0142	51.20	20.25	71.45	125.0	-53.62	peak			
2	0.0200	43.44	20.31	63.75	121.5	-57.83	peak			
3	0.0354	43.47	20.31	63.78	116.7	-52.93	peak			
4	0.0475	38.14	20.31	58.45	114.1	-55.66	peak			
5 *	0.0752	39.35	20.31	59.66	110.1	-50.44	peak			
6	0.1048	36.40	20.24	56.64	107.2	-50.57	peak			

- Note: 1. Measurement = Reading Level + Correct Factor.  
 2. All the modes had been tested, but only the worst data were recorded in the report.  
 3. If Peak Result complies with AV and QP limit, AV and QP Result are deemed to comply with AV limit.



**150KHz ~ 30M**

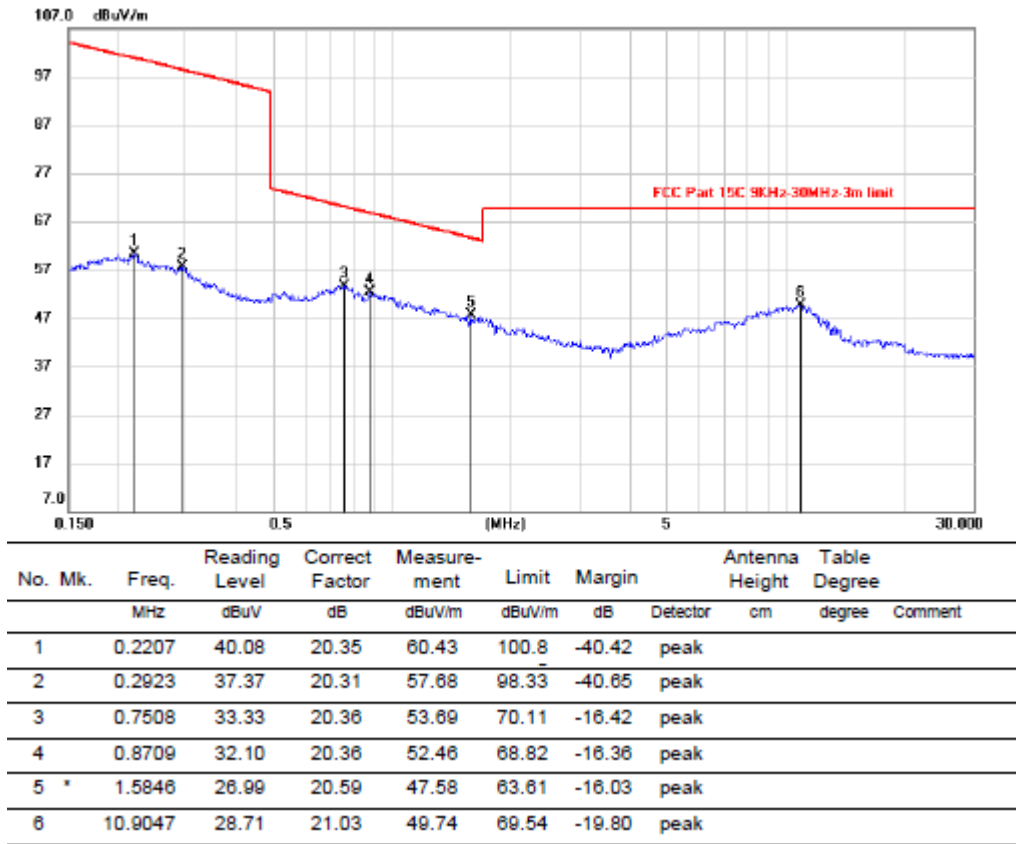

Note: 1. Measurement = Reading Level + Correct Factor.  
 2. All the modes had been tested, but only the worst data were recorded in the report.  
 3. If Peak Result complies with AV and QP limit, AV and QP Result are deemed to comply with AV limit.

Note: All the modes had been tested, but only the worst data were recorded in the report.



## 9. AC POWER LINE CONDUCTED EMISSIONS

### LIMITS

Please refer to FCC §15.207 (a) and RSS-Gen Clause 8.8

FREQUENCY (MHz)	Class A (dBuV)		Class B (dBuV)	
	Quasi-peak	Average	Quasi-peak	Average
0.15 -0.5	79.00	66.00	66 - 56 *	56 - 46 *
0.50 -5.0	73.00	60.00	56.00	46.00
5.0 -30.0	73.00	60.00	60.00	50.00

### TEST SETUP AND PROCEDURE

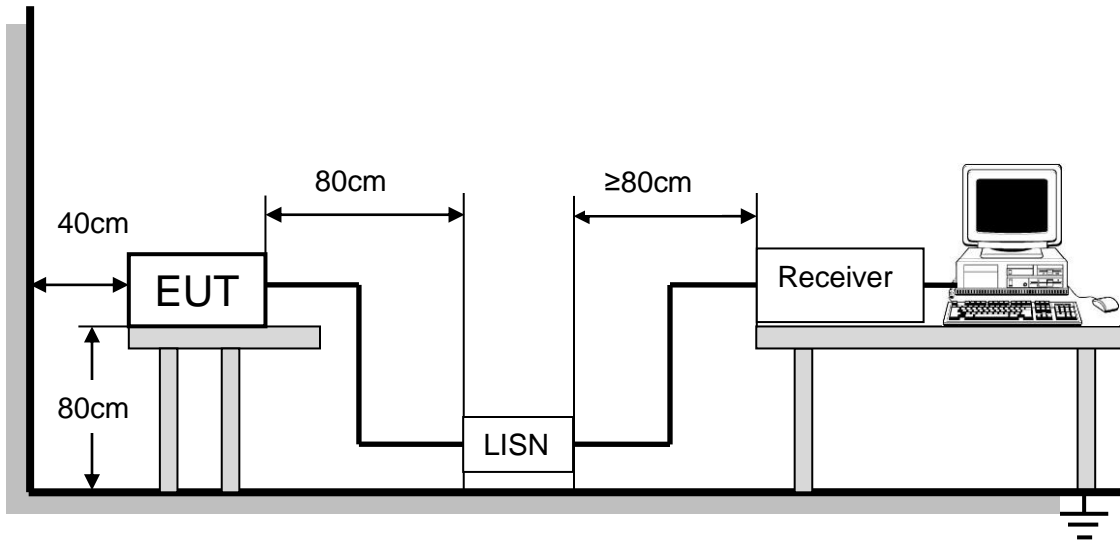

The EUT is put on a table of non-conducting material that is 80cm high. The vertical conducting wall of shielding is located 40cm to the rear of the EUT. The power line of the EUT is connected to the AC mains through a Artificial Mains Network (A.M.N.). A EMI Measurement Receiver (R&S Test Receiver ESR3) is used to test the emissions from both sides of AC line. According to the requirements in Section 6.2 of ANSI C63.10-2003. Conducted emissions from the EUT measured in the frequency range between 0.15 MHz and 30MHz using CISPR Quasi-Peak and average detector mode. The bandwidth of EMI test receiver is set at 9kHz.

The arrangement of the equipment is installed to meet the standards and operating in a manner, which tends to maximize its emission characteristics in a normal application.

### TEST ENVIRONMENT

Temperature	24.6°C	Relative Humidity	52%
Atmosphere Pressure	101kPa	Test Voltage	AC 120V



**LINE N RESULTS (LOW CHANNEL, WORST-CASE CONFIGURATION)**

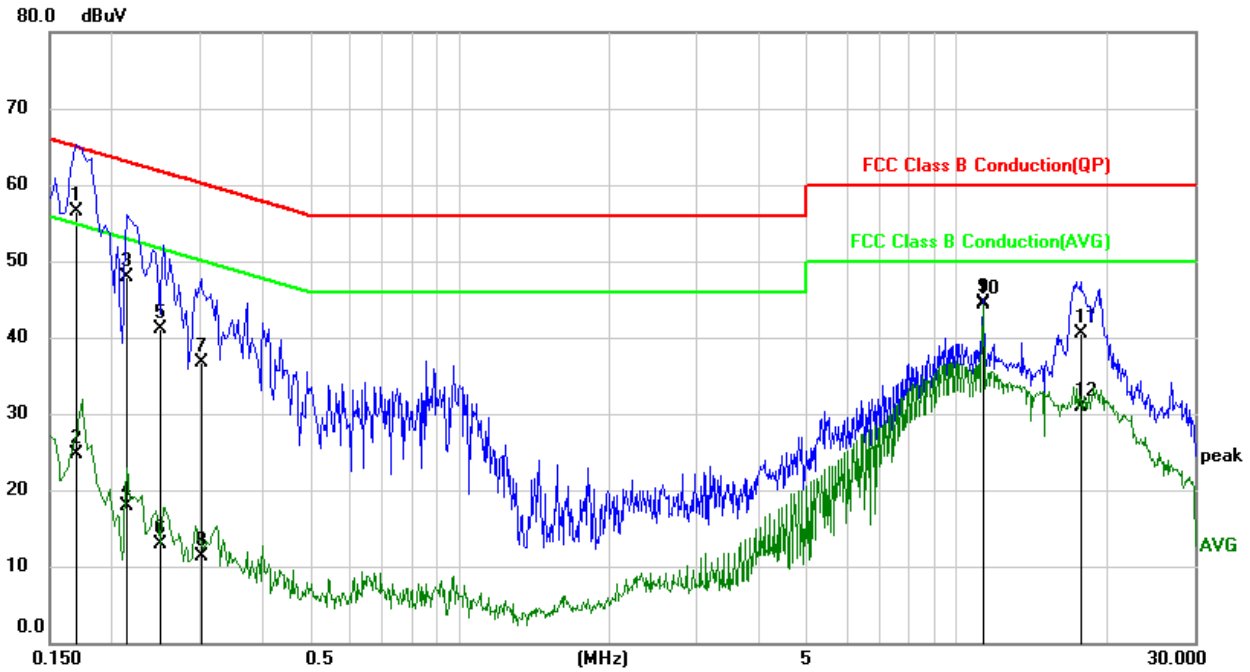

No.	Frequency (MHz)	Reading (dBuV)	Correct (dB)	Result (dBuV)	Limit (dBuV)	Margin (dB)	Remark
1	0.1698	46.89	9.62	56.51	64.97	-8.46	QP
2	0.1698	15.04	9.62	24.66	54.97	-30.31	AVG
3	0.2134	38.25	9.62	47.87	63.07	-15.20	QP
4	0.2134	8.33	9.62	17.95	53.07	-35.12	AVG
5	0.2502	31.56	9.63	41.19	61.75	-20.56	QP
6	0.2502	3.19	9.63	12.82	51.75	-38.93	AVG
7	0.3041	27.09	9.62	36.71	60.13	-23.42	QP
8	0.3041	1.65	9.62	11.27	50.13	-38.86	AVG
9	11.2895	34.41	10.05	44.46	60.00	-15.54	QP
10	11.2895	34.24	10.05	44.29	50.00	-5.71	AVG
11	17.7720	30.64	9.86	40.50	60.00	-19.50	QP
12	17.7720	21.05	9.86	30.91	50.00	-19.09	AVG

- Note: 1. Result = Reading +Correct Factor.  
 2. If QP Result complies with AV limit, AV Result is deemed to comply with AV limit.  
 3. Test setup: RBW: 200 Hz (9 kHz—150 kHz), 9 kHz (150 kHz—30 MHz).  
 4. Step size: 80Hz (0.009MHz-0.15MHz), 4 kHz (0.15MHz-30MHz), Scan time: auto.



**LINE L RESULTS (LOW CHANNEL, WORST-CASE CONFIGURATION)**

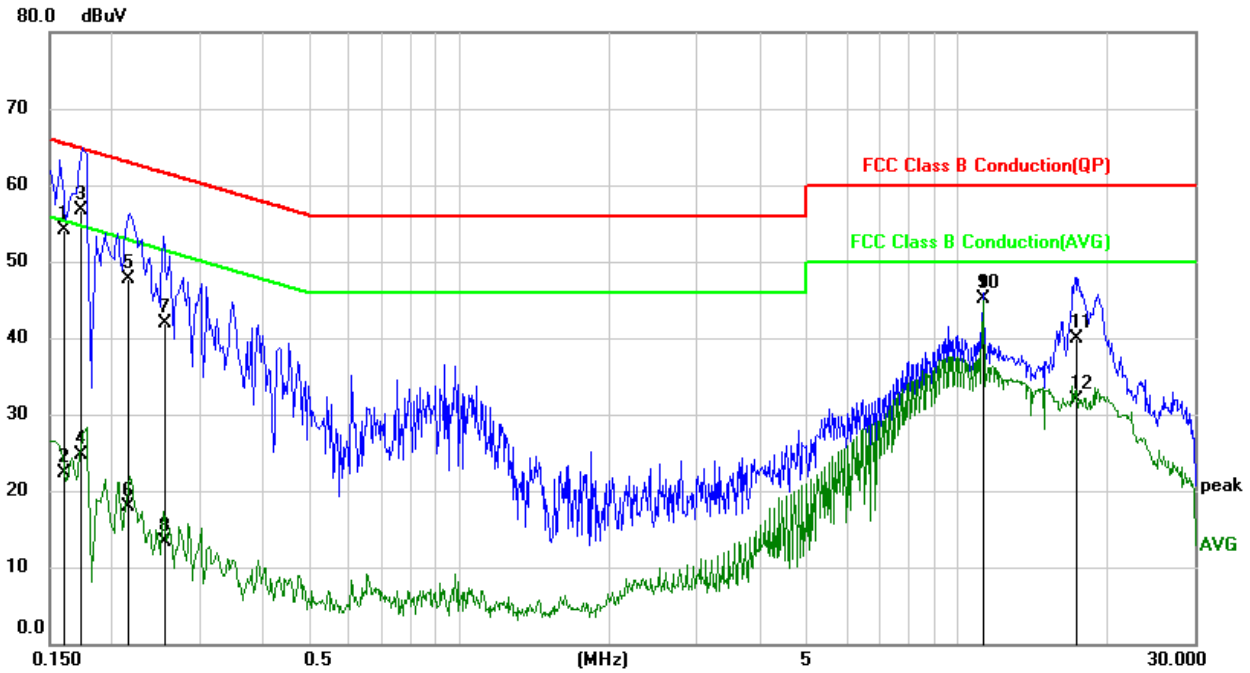

No.	Frequency (MHz)	Reading (dBuV)	Correct (dB)	Result (dBuV)	Limit (dBuV)	Margin (dB)	Remark
1	0.1616	44.49	9.63	54.12	65.38	-11.26	QP
2	0.1616	12.77	9.63	22.40	55.38	-32.98	AVG
3	0.1729	46.98	9.63	56.61	64.82	-8.21	QP
4	0.1729	15.06	9.63	24.69	54.82	-30.13	AVG
5	0.2159	38.10	9.63	47.73	62.98	-15.25	QP
6	0.2159	8.20	9.63	17.83	52.98	-35.15	AVG
7	0.2570	32.30	9.63	41.93	61.53	-19.60	QP
8	0.2570	3.66	9.63	13.29	51.53	-38.24	AVG
9	11.2895	35.16	10.04	45.20	60.00	-14.80	QP
10	11.2895	35.00	10.04	45.04	50.00	-4.96	AVG
11	17.4633	30.15	9.84	39.99	60.00	-20.01	QP
12	17.4633	21.97	9.84	31.81	50.00	-18.19	AVG

- Note: 1. Result = Reading +Correct Factor.  
 2. If QP Result complies with AV limit, AV Result is deemed to comply with AV limit.  
 3. Test setup: RBW: 200 Hz (9 kHz—150 kHz), 9 kHz (150 kHz—30 MHz).  
 4. Step size: 80Hz (0.009MHz-0.15MHz), 4 kHz (0.15MHz-30MHz), Scan time: auto.

Note: All the modes had been tested, but only the worst data were recorded in the report.



## 10. ANTENNA REQUIREMENTS

### Applicable requirements

Please refer to FCC §15.203

An intentional radiator shall be designed to ensure that no antenna other than that furnished by the responsible party shall be used with the device. The use of a permanently attached antenna or of an antenna that uses a unique coupling to the intentional radiator shall be considered sufficient to comply with the provisions of this section. The manufacturer may design the unit so that a broken antenna can be replaced by the user, but the use of a standard antenna jack or electrical connector is prohibited.

Please refer to FCC §15.247(b)(4)

The conducted output power limit specified in paragraph (b) of this section is based on the use of antennas with directional gains that do not exceed 6 dBi. Except as shown in paragraph (c) of this section, if transmitting antennas of directional gain greater than 6 dBi are used, the conducted output power from the intentional radiator shall be reduced below the stated values in paragraphs (b)(1), (b)(2), and (b)(3) of this section, as appropriate, by the amount in dB that the directional gain of the antenna exceeds 6 dBi.

### Antenna Connector

EUT has an internal antenna with antenna connector, it will be installed in a specific environment and users cannot change the antenna.

### Antenna Gain

The antenna gain of EUT is 7.5 dBi, more than 6 dBi, so the conducted output power shall be reduced to 29 dBm, and the PSD shall be reduced to 0.5 dBm.

**END OF REPORT**