



Shenzhen CTL Testing Technology Co., Ltd.
Tel: +86-755-89486194 Fax: +86-755-26636041

FCC PART 15 SUBPART C TEST REPORT

Report Reference No.: CTL1605201816-WF

Compiled by:
(position+printed name+signature)

Happy Guo
(File administrators)

Happy Guo

Tested by:
(position+printed name+signature)

Nice Nong
(Test Engineer)

Nice Nong

Approved by:
(position+printed name+signature)

Tracy Qi
(Manager)

Tracy Qi

Product Name.....: Bluetooth headphone
Model/Type reference.....: HP-6001BT, HP-6002BT, HP-6003BT, HP-6004BT, HP-6005BT, HP-6006BT, HP-6007BT, HP-6008BT, HP-6009BT, HP-6010BT, HP-6101BT, HP-6102BT, HP-6103BT, HP-6104BT, HP-6105BT, HP-6106BT, HP-6107BT, HP-6108BT, HP-6109BT, M1BT, M2BT, HP-8810, CX-05, HP-5100BT, HP-5600, HP-9010, HP-9020, HP-8510
Trade Mark.....: hualipu
FCC ID.....: UWO-HUALIPU

Applicant's name.....: SHENZHEN LISAIER TRONICS CO., LTD.
Address of applicant.....: NO.22, Xihu Industrial Park, Xikeng, Henggang Town, Shenzhen, China

Test Firm.....: Shenzhen CTL Testing Technology Co., Ltd.
Address of Test Firm.....: Floor 1-A, Baisha Technology Park, No.3011, Shahexi Road, Nanshan District, Shenzhen, China 518055

Test specification.....:
Standard.....: **FCC Part 15.249:** Operation within the bands 920-928 MHz, 2400-2483.5 MHz, 5725-5850 MHz and 24.0 - 24.25 GHz.
TRF Originator.....: Shenzhen CTL Testing Technology Co., Ltd.
Master TRF.....: Dated 2011-01

Date of Receipt.....: May 22, 2016
Date of Test Date.....: May 22, 2016 – May 31,2016
Data of Issue.....: May 31,2016
Result.....: **PASS**

Shenzhen CTL Testing Technology Co., Ltd. All rights reserved.
 This publication may be reproduced in whole or in part for non-commercial purposes as long as the Shenzhen CTL Testing Technology Co., Ltd. is acknowledged as copyright owner and source of the material. Shenzhen CTL Testing Technology Co., Ltd. takes no responsibility for and will not assume liability for damages resulting from the reader's interpretation of the reproduced material due to its placement and context.

TEST REPORT

Test Report No. :	CTL1605201816-WF	May 31,2016
		Date of issue

Equipment under Test : Bluetooth headphone

Model /Type : HP-6001BT, HP-6002BT, HP-6003BT, HP-6004BT, HP-6005BT, HP-6006BT, HP-6007BT, HP-6008BT, HP-6009BT, HP-6010BT, HP-6101BT, HP-6102BT, HP-6103BT, HP-6104BT, HP-6105BT, HP-6106BT, HP-6107BT, HP-6108BT, HP-6109BT, M1BT, M2BT, HP-8810, CX-05, HP-5100BT, HP-5600, HP-9010, HP-9020, HP-8510

Applicant : **SHENZHEN LISAIER TRONICS CO., LTD.**

Address : NO.22, Xihu Industrial Park, Xikeng, Henggang Town, Shenzhen, China

Manufacturer : **SHENZHEN LISAIER TRONICS CO., LTD.**

Address : NO.22, Xihu Industrial Park, Xikeng, Henggang Town, Shenzhen, China

Test Result according to the standards on page 4:	PASS
----------------------------------------------------------	-------------

The test report merely corresponds to the test sample.
It is not permitted to copy extracts of these test result without the written permission of the test laboratory.

Contents

1.	<u>TEST STANDARDS</u>	<u>4</u>
2.	<u>SUMMARY</u>	<u>5</u>
2.1.	Equipment Under Test	5
2.2.	Description of the Equipment under Test (EUT)	5
2.3.	EUT operation mode	6
2.4.	EUT configuration	6
2.5.	Related Submittal(s) / Grant (s)	6
2.6.	Modifications	6
3.	<u>TEST ENVIRONMENT</u>	<u>7</u>
3.1.	Address of the test laboratory	7
3.2.	Test Facility	7
3.3.	Environmental conditions	7
3.4.	Configuration of Tested System	7
3.5.	Statement of the measurement uncertainty	8
3.6.	Equipments Used during the Test	9
4.	<u>TEST CONDITIONS AND RESULTS</u>	<u>10</u>
4.1.	Conducted Emissions Test	10
4.2.	Transmitter Radiated Unwanted Emissions and Bandedge	14
4.3.	Occupied Bandwidth Measurement	20
5.	<u>ANTENNA REQUIREMENT</u>	<u>24</u>
6.	<u>TEST SETUP PHOTOS OF THE EUT</u>	<u>25</u>
7.	<u>EXTERNAL AND INTERNAL PHOTOS OF THE EUT</u>	<u>27</u>

1. TEST STANDARDS

The tests were performed according to following standards:

[FCC Rules Part 15.249](#): Operation within the bands 902 - 928 MHz, 2400 - 2483.5 MHz, 5725 - 5875 MHz, and 24.0 - 24.25 GHz.

[ANSI C63.10-2013](#)

[ANSI C63.4-2014](#)



2. SUMMARY

2.1. Equipment Under Test

Power supply system utilised

Power supply voltage : 120V / 60 Hz 115V / 60Hz
 12 V DC 24 V DC
 Other (specified in blank below)

DC 3.7V from battery

2.2. Description of the Equipment under Test (EUT)

The EUT (Bluetooth headphone) support Bluetooth function.

Name of EUT	Bluetooth headphone
Model Number	HP-6001BT
Antenna Type	Internal
BT Operation frequency	2402MHz-2480MHz
BT Modulation Type	GFSK,8DPSK, π /4DQPSK(BT V2.1+EDR)
Bluetooth	BT V2.1+EDR
Antenna Gain	0dBi

Channel List:

Channel	Frequency (MHz)	Channel	Frequency (MHz)	Channel	Frequency (MHz)
00	2402	27	2429	54	2456
01	2403	28	2430	55	2457
02	2404	29	2431	56	2458
03	2405	30	2432	57	2459
04	2406	31	2433	58	2460
05	2407	32	2434	59	2461
06	2408	33	2435	60	2462
07	2409	34	2436	61	2463
08	2410	35	2437	62	2464
09	2411	36	2438	63	2465
10	2412	37	2439	64	2466
11	2413	38	2440	65	2467
12	2414	39	2441	66	2468
13	2415	40	2442	67	2469
14	2416	41	2443	68	2470
15	2417	42	2444	69	2471
16	2418	43	2445	70	2472
17	2419	44	2446	71	2473
18	2420	45	2447	72	2474
19	2421	46	2448	73	2475
20	2422	47	2449	74	2476
21	2423	48	2450	75	2477
22	2424	49	2451	76	2478
23	2425	50	2452	77	2479
24	2426	51	2453	78	2480
25	2427	52	2454		
26	2428	53	2455		

For more details, refer to the user's manual of the EUT.

Serial number: Prototype

2.3. EUT operation mode

Test Mode(TM)	Description	Remark
TM1	Bottom Channel Transmitting	/
TM2	Middle Channel Transmitting	/
TM3	Top Channel Transmitting	/
TM4	Charging and keeping TX	power by battery

The field strength of radiation emission was measured in the following position: EUT stand-up position (Y axis), lie-down position (X, Z axis).

The following data show only with the worst case setup.

The worst case of X axis was reported.

Based on client request, all normal using modes of the normal function were tested but only the worst test data of the worst mode is reported by this report.

Remark: GFSK,8DPSK, $\pi/4$ DQPSK mode all have been tested , only the worst case mode GFSK(1Mbps) is reported for conducted and radiated emission test.

2.4. EUT configuration

The following peripheral devices and interface cables were connected during the measurement:

o - supplied by the manufacturer

● - supplied by the lab

● Notebook (FCC DOC approved)

Manufacturer: DELL

Model No.: PP18L

2.5. Related Submittal(s) / Grant (s)

This submittal(s) (test report) is intended for FCC ID: UWO-HUALIPU filing to comply with Section 15.249 of the FCC Part 15, Subpart C Rules.

2.6. Modifications

No modifications were implemented to meet testing criteria.

3. TEST ENVIRONMENT

3.1. Address of the test laboratory

Shenzhen CTL Testing Technology Co., Ltd.
Floor 1-A, Baisha Technology Park, No. 3011, Shahexi Road, Nanshan, Shenzhen 518055 China

There is one 3m semi-anechoic chamber and two line conducted labs for final test. The Test Sites meet the requirements in documents ANSI C63.4 and CISPR 22/EN 55022 requirements.

3.2. Test Facility

The test facility is recognized, certified, or accredited by the following organizations:

IC Registration No.: 9618B

The 3m alternate test site of Shenzhen CTL Testing Technology Co., Ltd. EMC Laboratory has been registered by Certification and Engineer Bureau of Industry Canada for the performance of with Registration No.: 9618B on November 13, 2013.

FCC-Registration No.: 970318

Shenzhen CTL Testing Technology Co., Ltd. EMC Laboratory has been registered and fully described in a report filed with the (FCC) Federal Communications Commission. The acceptance letter from the FCC is maintained in our files. Registration 970318, December 19, 2013.

3.3. Environmental conditions

During the measurement the environmental conditions were within the listed ranges:

Temperature: 15-35 ° C

Humidity: 30-60 %

Atmospheric pressure: 950-1050mbar

3.4. Configuration of Tested System

Fig. 2-1 Configuration of Tested System

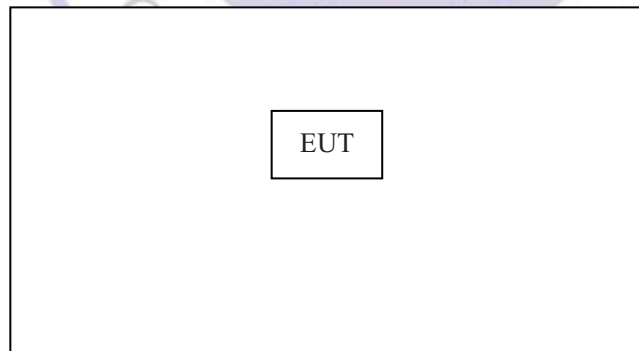

3.5. Statement of the measurement uncertainty

The data and results referenced in this document are true and accurate. The reader is cautioned that there may be errors within the calibration limits of the equipment and facilities. The measurement uncertainty was calculated for all measurements listed in this test report acc. to CISPR 16 - 4 „Specification for radio disturbance and immunity measuring apparatus and methods – Part 4: Uncertainty in EMC Measurements“ and is documented in the Shenzhen CTL Testing Technology Co., Ltd. quality system acc. to DIN EN ISO/IEC 17025. Furthermore, component and process variability of devices similar to that tested may result in additional deviation. The manufacturer has the sole responsibility of continued compliance of the device.

Hereafter the best measurement capability for CTL laboratory is reported:

Test	Range	Measurement Uncertainty	Notes
Radiated Emission	30~1000MHz	4.10dB	(1)
Radiated Emission	1~26.5GHz	4.32dB	(1)
Conducted Disturbance	0.15~30MHz	3.20dB	(1)

- (1) This uncertainty represents an expanded uncertainty expressed at approximately the 95% confidence level using a coverage factor of k=2.



3.6. Equipments Used during the Test

Test Equipment	Manufacturer	Model No.	Serial No.	Calibration Date	Calibration Due Date
BilogAntenna	Sunol Sciences Corp.	JB1	A061713	2015/06/02	2016/06/01
EMI Test Receiver	R&S	ESCI3	103710	2015/06/02	2016/06/01
Spectrum Analyzer	Agilent	E4407B	MY45108355	2016/05/21	2017/05/20
Spectrum Analyzer	Agilent	N9020A	US46220290	2015/12/10	2016/12/09
Controller	EM Electronics	Controller EM 1000	N/A	2016/05/21	2017/05/20
Horn Antenna	Sunol Sciences Corp.	DRH-118	A062013	2016/05/19	2017/05/18
Active Loop Antenna	Daze	ZN30900A	N/A	2016/05/19	2017/05/18
LISN	R&S	ENV216	101316	2015/06/02	2016/06/01
LISN	SCHWARZBECK	NSLK8127	8127687	2015/06/02	2016/06/01
Microwave Preamplifier	HP	8349B	3155A00882	2016/05/19	2017/05/18
Amplifier	HP	8447D	3113A07663	2016/05/19	2017/05/18
Transient Limiter	Com-Power	LIT-153	532226	2015/06/02	2016/06/01
Temperature/Humidity Meter	Gangxing	CTH-608	02	2016/05/20	2017/05/19
Climate Chamber	ESPEC	EL-10KA	A20120523	2016/05/20	2017/05/19
High-Pass Filter	K&L	9SH10-2700/X12750-O/O	N/A	2016/05/20	2017/05/19
High-Pass Filter	K&L	41H10-1375/U12750-O/O	N/A	2016/05/20	2017/05/19
Ultra-Broadband Antenna	ShwarzBeck	BBHA9170	25841	2016/05/19	2017/05/18
The temporary antenna connector	MMCX - SMA	1547	23657478	2016/05/20	2017/05/19
RF Cable(1-25GHz)	HUBER+SUHNER	RG214	N/A	2016/05/20	2017/05/19
RF Cable(0-1GHz)	HUBER+SUHNER	RG174	N/A	2016/05/20	2017/05/19

Note: The temporary antenna connector is soldered on the PCB board in order to perform conducted tests and this temporary antenna connector is listed in the equipment list.

4. TEST CONDITIONS AND RESULTS

4.1. Conducted Emissions Test

TEST CONFIGURATION

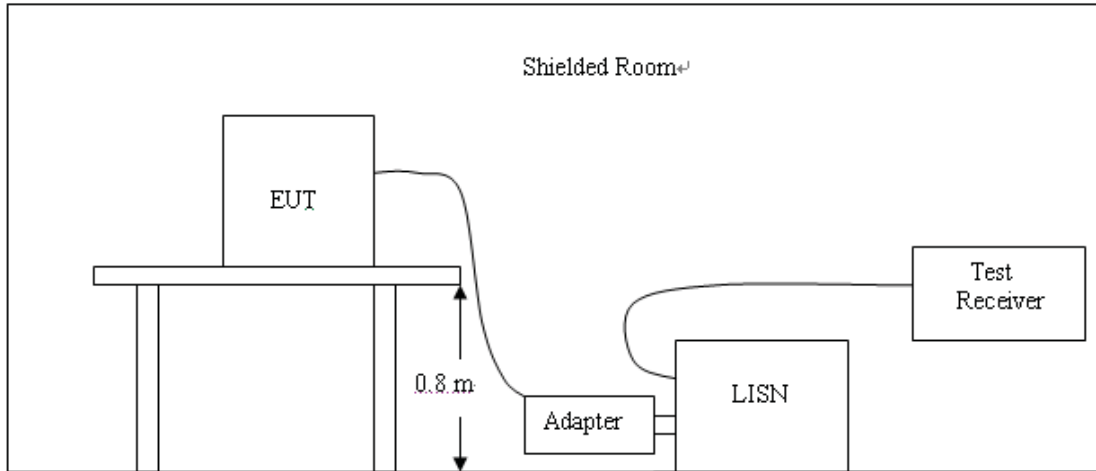

TEST PROCEDURE

- 1 The equipment was set up as per the test configuration to simulate typical actual usage per the user's manual. The EUT is a tabletop system, a wooden table with a height of 0.8 meters is used and is placed on the ground plane as per ANSI C63.10.
- 2 Support equipment, if needed, was placed as per ANSI C63.10.
- 3 All I/O cables were positioned to simulate typical actual usage as per ANSI C63.10.
- 4 If a EUT received DC power from the USB Port of Notebook PC, the PC's adapter received AC120V/60Hz power through a Line Impedance Stabilization Network (LISN) which supplied power source and was grounded to the ground plane.
- 5 All support equipments received AC power from a second LISN, if any.
- 6 The EUT test program was started. Emissions were measured on each current carrying line of the EUT using a spectrum Analyzer / Receiver connected to the LISN powering the EUT. The LISN has two monitoring points: Line 1 (Hot Side) and Line 2 (Neutral Side). Two scans were taken: one with Line 1 connected to Analyzer / Receiver and Line 2 connected to a 50 ohm load; the second scan had Line 1 connected to a 50 ohm load and Line 2 connected to the Analyzer / Receiver.
- 7 Analyzer / Receiver scanned from 150 KHz to 30MHz for emissions in each of the test modes.
- 8 During the above scans, the emissions were maximized by cable manipulation.

The RBW/VBW for 150KHz to 30MHz: 9KHz

CONDUCTED POWER LINE EMISSION LIMIT

For unintentional device, according to § 15.207(a) Line Conducted Emission Limits is as following :

Frequency (MHz)	Maximum RF Line Voltage (dB μ V)			
	CLASS A		CLASS B	
	Q.P.	Ave.	Q.P.	Ave.
0.15 - 0.50	79	66	66-56*	56-46*
0.50 - 5.00	73	60	56	46
5.00 - 30.0	73	60	60	50

* Decreasing linearly with the logarithm of the frequency

For intentional device, according to §15.207(a) Line Conducted Emission Limit is same as above table.

TEST RESULTS

SCAN TABLE: "Voltage (9K-30M) FIN"

Short Description: 150K-30M Voltage

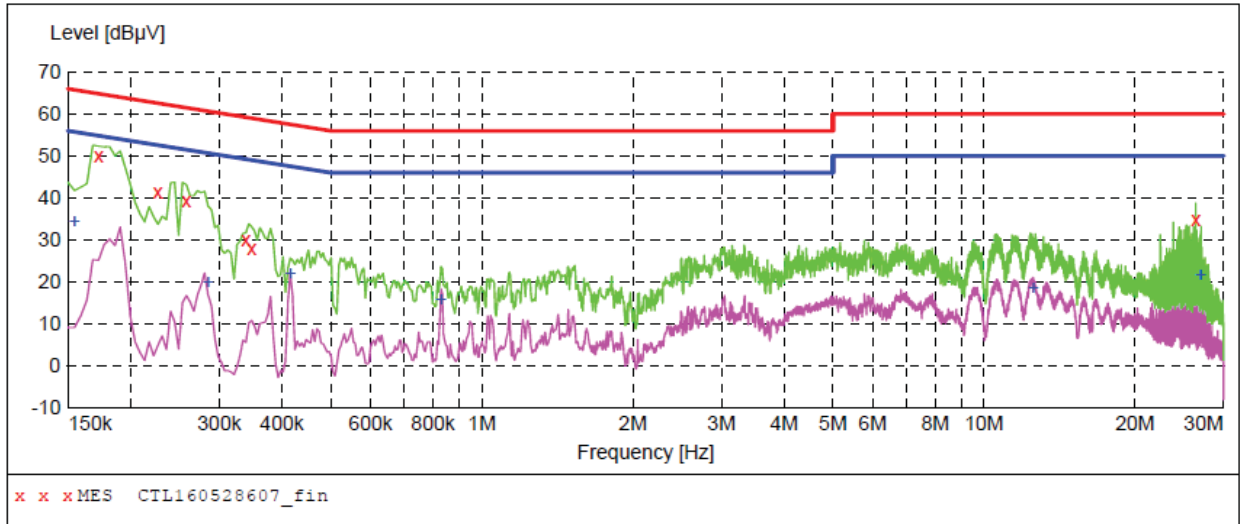

MEASUREMENT RESULT: "CTL160528607_fin"

5/28/2016 11:48AM

Frequency MHz	Level dBµV	Transd dB	Limit dBµV	Margin dB	Detector	Line	PE
0.172501	50.10	10.2	65	14.7	QP	N	GND
0.226501	41.40	10.2	63	21.2	QP	N	GND
0.258001	39.20	10.2	62	22.3	QP	N	GND
0.339001	30.00	10.2	59	29.2	QP	N	GND
0.348001	27.90	10.2	59	31.1	QP	N	GND
26.412001	34.90	11.2	60	25.1	QP	N	GND

MEASUREMENT RESULT: "CTL160528607_fin2"

5/28/2016 11:48AM

Frequency MHz	Level dBµV	Transd dB	Limit dBµV	Margin dB	Detector	Line	PE
0.154501	34.60	10.2	56	21.2	AV	N	GND
0.285001	19.80	10.2	51	30.9	AV	N	GND
0.415501	22.00	10.2	48	25.5	AV	N	GND
0.829501	15.80	10.2	46	30.2	AV	N	GND
12.534001	18.70	10.6	50	31.3	AV	N	GND
27.015001	21.80	11.2	50	28.2	AV	N	GND

SCAN TABLE: "Voltage (9K-30M)FIN"

Short Description: 150K-30M Voltage

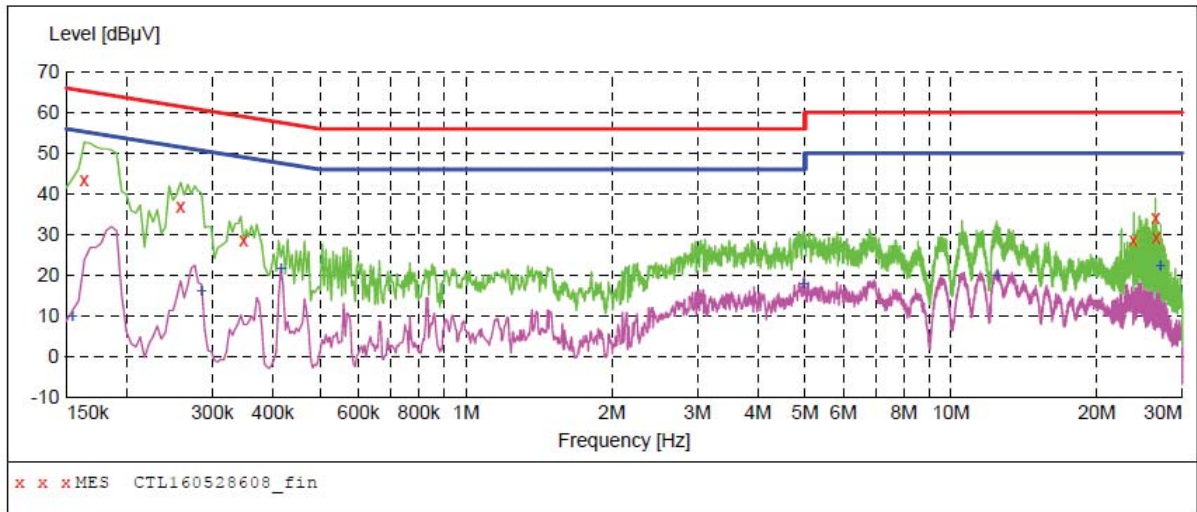

MEASUREMENT RESULT: "CTL160528608_fin"

5/28/2016 11:51AM

Frequency MHz	Level dBµV	Transd dB	Limit dBµV	Margin dB	Detector	Line	PE
0.163501	43.40	10.2	65	21.9	QP	L1	GND
0.258001	36.80	10.2	62	24.7	QP	L1	GND
0.348001	28.50	10.2	59	30.5	QP	L1	GND
23.824501	28.50	11.1	60	31.5	QP	L1	GND
26.412001	34.00	11.2	60	26.0	QP	L1	GND
26.533501	29.40	11.2	60	30.6	QP	L1	GND

MEASUREMENT RESULT: "CTL160528608_fin2"

5/28/2016 11:51AM

Frequency MHz	Level dBµV	Transd dB	Limit dBµV	Margin dB	Detector	Line	PE
0.154501	9.90	10.2	56	45.9	AV	L1	GND
0.285001	16.00	10.2	51	34.7	AV	L1	GND
0.415501	21.80	10.2	48	25.7	AV	L1	GND
4.974001	17.80	10.4	46	28.2	AV	L1	GND
12.471001	19.90	10.6	50	30.1	AV	L1	GND
27.015001	22.30	11.2	50	27.7	AV	L1	GND

4.2. Transmitter Radiated Unwanted Emissions and Bandedge

TEST CONFIGURATION

(A) Radiated Emission Test Set-Up, Frequency Below 30MHz

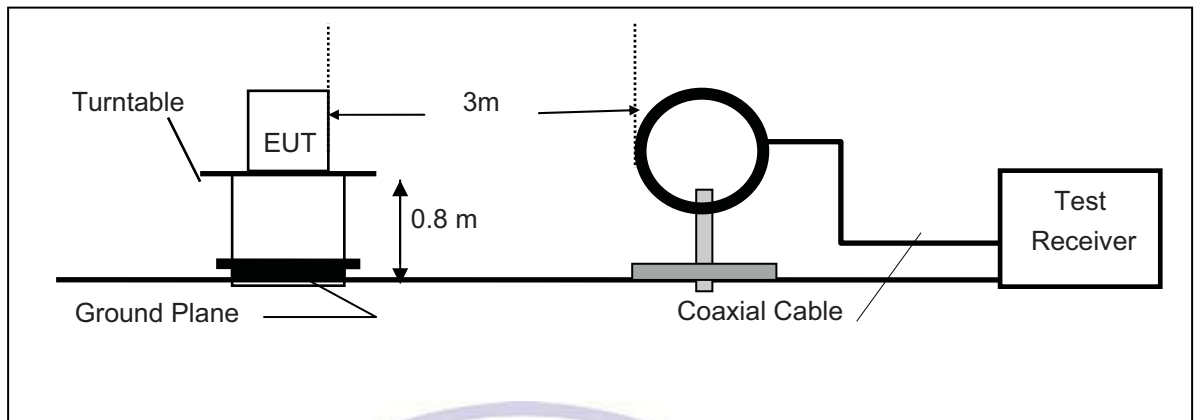

(B) Radiated Emission Test Set-Up, Frequency below 1000MHz

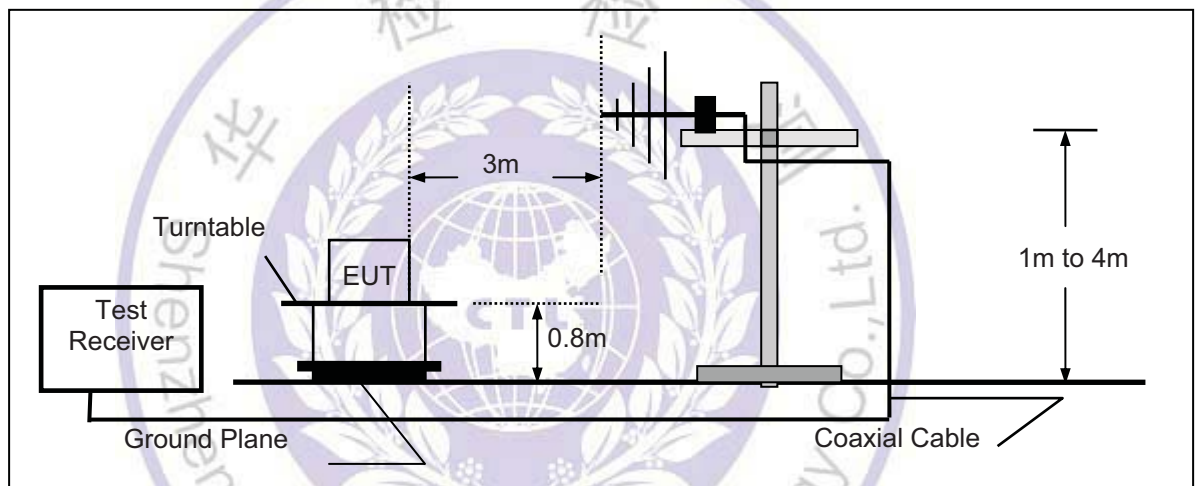

(C) Radiated Emission Test Set-Up, Frequency above 1000MHz

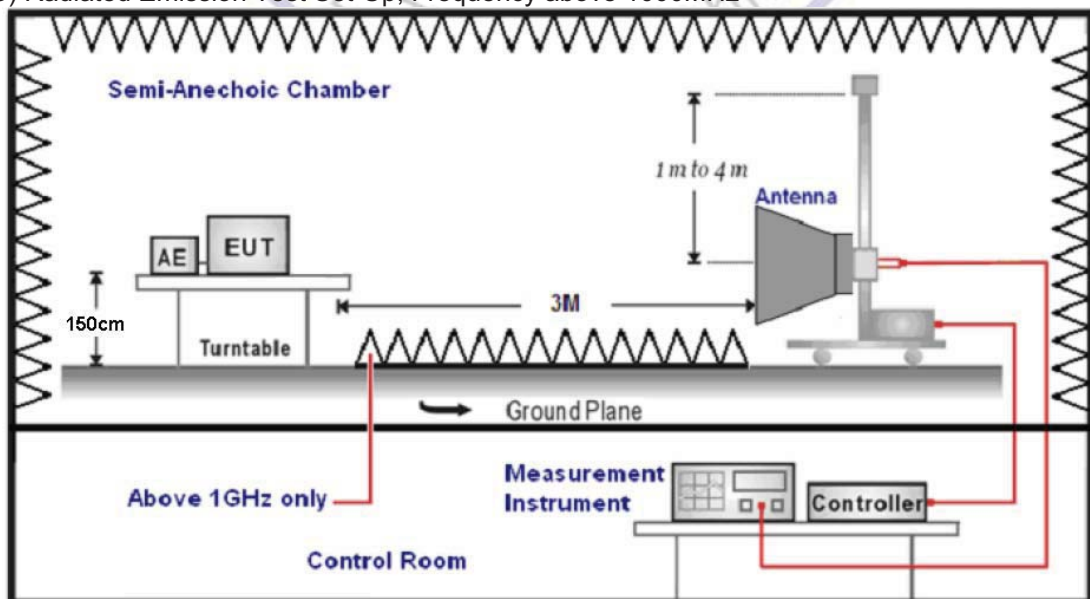

FIELD STRENGTH CALCULATION

The field strength is calculated by adding the Antenna Factor and Cable Factor and subtracting the Amplifier Gain and Duty Cycle Correction Factor(if any) from the measured reading. The basic equation with a sample calculation is as follows:

$$FS = RA + AF + CL - AG$$

Where FS = Field Strength	CL = Cable Attenuation Factor (Cable Loss)
RA = Reading Amplitude	AG = Amplifier Gain
AF = Antenna Factor	

RADIATION LIMIT

For unintentional device, according to § 15.209(a), except for Class A digital devices, the field strength of radiated emissions from unintentional radiators at a distance of 3 meters shall not exceed the following values:

Frequency (MHz)	Distance (Meters)	Radiated (dBµV/m)	Radiated (µV/m)
30-88	3	40.0	100
88-216	3	43.5	150
216-960	3	46.0	200
Above 960	3	54.0	500

For intentional device, according to § 15.209(a), the general requirement of field strength of radiated emissions from intentional radiators at a distance of 3 meters shall not exceed the above table.

TEST PROCEDURE

1. The EUT is placed on a turntable, which is 0.8m above ground plane below 1GHz and 1.5m above ground plane above 1GHz.
2. The turntable shall be rotated for 360 degrees to determine the position of maximum emission level.
3. EUT is set 3m away from the receiving antenna, which is varied from 1m to 4m to find out the highest emissions.
4. For the radiated emission test above 1GHz: Place the measurement antenna away from each area of the EUT determined to be a source of emissions at the specified measurement distance, while keeping the measurement antenna aimed at the source of emissions at each frequency of significant emissions, with polarization oriented for maximum response. The measurement antenna may have to be higher or lower than the EUT, depending on the radiation pattern of the emission and staying aimed at the emission source for receiving the maximum signal. The final measurement antenna elevation shall be that which maximizes the emissions. The measurement antenna elevation for maximum emissions shall be restricted to a range of heights of from 1 m to 4 m above the ground or reference ground plane.
5. Maximum procedure was performed on the six highest emissions to ensure EUT compliance.
6. And also, each emission was to be maximized by changing the polarization of receiving antenna both horizontal and vertical.
7. Repeat above procedures until the measurements for all frequencies are complete.
8. Based on the Frequency Generator in the device include 16MHz. The test frequency range from 9KHz to 25GHz per FCC PART 15.33(a).

Note:

Three axes are chosen for pretest, the X axis is the worst mode for final test.
For battery operated equipment, the equipment tests shall be performed using a fully-charged battery.

TEST RESULTS

All the test modes (TM1, TM2, TM3 and TM4) completed for test. The worst case of Radiated Emission is TM1; the test data of this mode was reported.

Below 1GHz Test Results:

SWEEP TABLE: "test (30M-1G)"

Short Description:		Field Strength			
Start	Stop	Detector	Meas. Time	IF Bandw.	Transducer
Frequency 30.0 MHz	Frequency 1.0 GHz	MaxPeak	300.0 ms	120 kHz	JB1

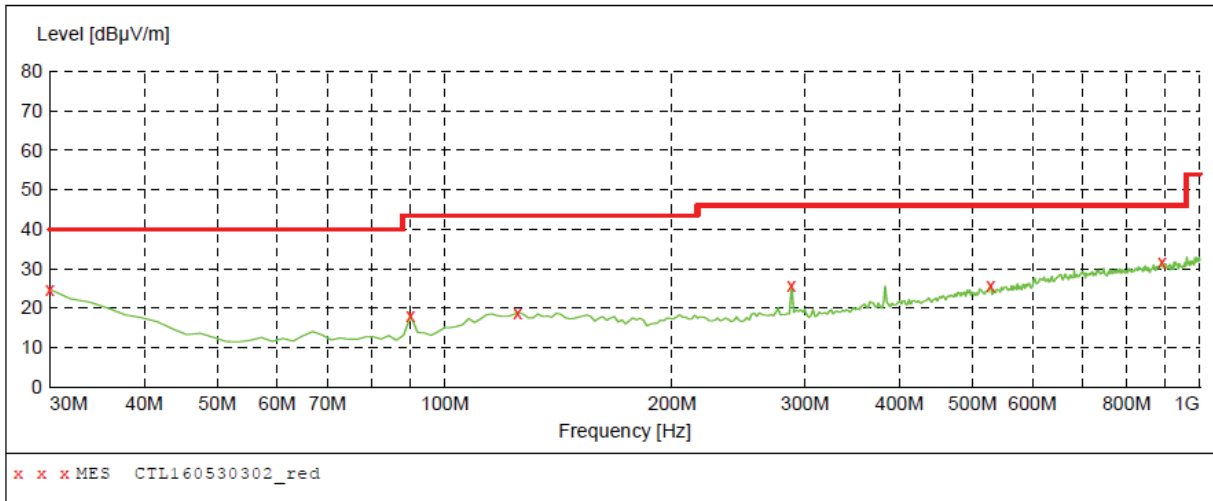

MEASUREMENT RESULT: "CTL160530302_red"

5/30/2016 9:36AM

Frequency MHz	Level dBµV/m	Transd dB	Limit dBµV/m	Margin dB	Det.	Height cm	Azimuth deg	Polarization
30.000000	24.70	20.8	40.0	15.3	---	0.0	0.00	VERTICAL
90.140000	18.00	9.4	43.5	25.5	---	0.0	0.00	VERTICAL
125.060000	18.90	14.6	43.5	24.6	---	0.0	0.00	VERTICAL
288.020000	25.80	15.2	46.0	20.2	---	0.0	0.00	VERTICAL
528.580000	25.90	20.4	46.0	20.1	---	0.0	0.00	VERTICAL
891.360000	31.80	25.8	46.0	14.2	---	0.0	0.00	VERTICAL

Remark:

- (1) Measuring frequencies from 9 KHz to the 1 GHz, Radiated emission test from 9KHz to 30MHz was verified, and no any emission was found except system noise floor.
- (2) * denotes emission frequency which appearing within the Restricted Bands specified in provision of 15.205, then the general radiated emission limits in 15.209 apply.
- (3) The IF bandwidth of EMI Test Receiver between 30MHz to 1GHz was 120KHz, 1 MHz for measuring above 1 GHz, below 30MHz was 10KHz.

SWEEP TABLE: "test (30M-1G)"

Short Description:		Field Strength			
Start	Stop	Detector	Meas. Time	IF Bandw.	Transducer
30.0 MHz	1.0 GHz	MaxPeak	300.0 ms	120 kHz	JB1

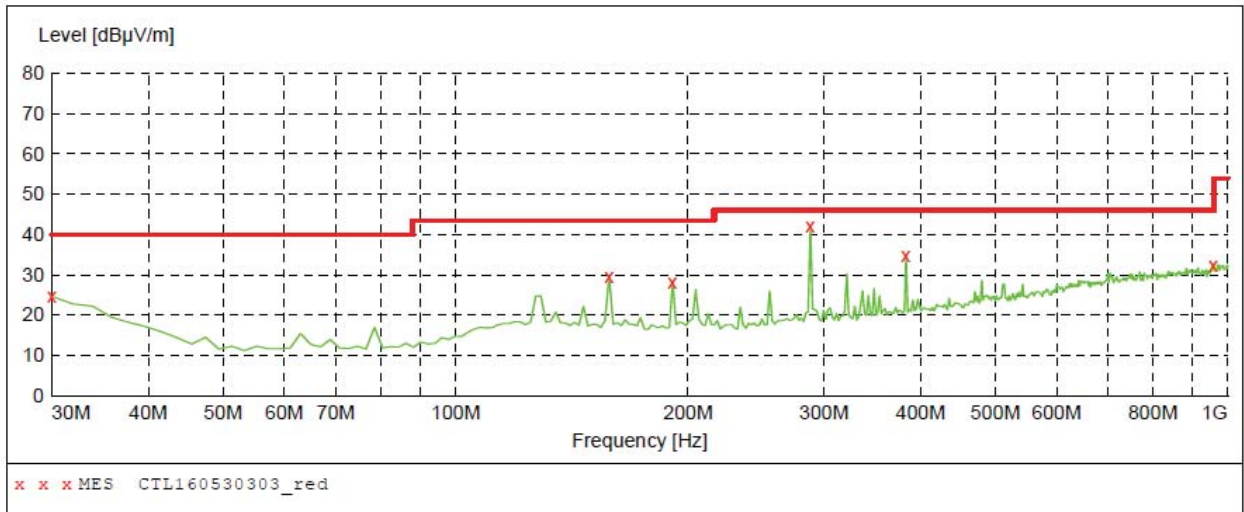

MEASUREMENT RESULT: "CTL160530303_red"

5/30/2016 9:38AM

Frequency MHz	Level dBµV/m	Transd dB	Limit dBµV/m	Margin dB	Det.	Height cm	Azimuth deg	Polarization
30.000000	24.60	20.8	40.0	15.4	---	0.0	0.00	HORIZONTAL
158.040000	29.70	13.7	43.5	13.8	---	0.0	0.00	HORIZONTAL
191.020000	28.30	13.2	43.5	15.2	---	0.0	0.00	HORIZONTAL
288.020000	42.20	15.2	46.0	3.8	---	0.0	0.00	HORIZONTAL
383.080000	34.70	17.7	46.0	11.3	---	0.0	0.00	HORIZONTAL
957.320000	32.40	26.6	46.0	13.6	---	0.0	0.00	HORIZONTAL

Remark:

- (1) Measuring frequencies from 9 KHz to the 1 GHz, Radiated emission test from 9KHz to 30MHz was verified, and no any emission was found except system noise floor.
- (2) * denotes emission frequency which appearing within the Restricted Bands specified in provision of 15.205, then the general radiated emission limits in 15.209 apply.
- (3) The IF bandwidth of EMI Test Receiver between 30MHz to 1GHz was 120KHz, 1 MHz for measuring above 1 GHz, below 30MHz was 10KHz.

Above 1 GHz Test Results:

Note: Horizontal and Vertical all have been tested , only worse case Vertical is reported.

Frequency	Emission		Limit	Margin	Raw	Antenna Factor	Cable	Pre-amplifier	Correction
(MHz)	Level		(dBuV/m)	(dB)	Value	(dB/m)	Factor	(dB)	Factor
	(dBuV/m)				(dBuV)		(dB)		(dB/m)
2402.00	97.19	PK	114	16.81	99.15	28.78	4.61	35.36	-1.96
2402.00	86.04	AV	94	7.96	88.00	28.78	4.61	35.36	-1.96
2390.00	68.97	PK	74	5.03	71.01	28.72	4.60	35.36	-2.04
2390.00	49.05	AV	54	4.95	51.09	28.72	4.60	35.36	-2.04
2400.00	70.38	PK	74	3.62	72.35	28.78	4.61	35.36	-1.97
2400.00	50.15	AV	54	3.85	52.12	28.78	4.61	35.36	-1.97
4804.00	68.02	PK	74	5.98	63.51	33.49	6.91	35.89	4.51
4804.00	50.61	AV	54	3.39	46.10	33.49	6.91	35.89	4.51
6038.00	66.03	PK	74	7.97	57.84	35.15	7.65	34.61	8.19
6038.00	46.84	AV	54	7.16	38.65	35.15	7.65	34.61	8.19
7206.00	65.05	PK	74	8.95	53.94	36.95	9.18	35.03	11.11
7206.00	46.10	AV	54	7.90	34.99	36.95	9.18	35.03	11.11

Frequency	Emission		Limit	Margin	Raw	Antenna Factor	Cable	Pre-amplifier	Correction
(MHz)	Level		(dBuV/m)	(dB)	Value	(dB/m)	Factor	(dB)	Factor
	(dBuV/m)				(dBuV)		(dB)		(dB/m)
2441.00	96.58	PK	114	17.42	98.44	28.85	4.66	35.37	-1.86
2441.00	87.34	AV	94	6.66	89.20	28.85	4.66	35.37	-1.86
3200.00	66.01	PK	74	7.99	64.65	31.24	5.47	35.35	1.36
3200.00	46.97	AV	54	7.03	45.61	31.24	5.47	35.35	1.36
3658.00	64.97	PK	74	9.03	61.62	32.38	6.01	35.04	3.35
3658.00	48.18	AV	54	5.82	44.83	32.38	6.01	35.04	3.35
4882.00	67.91	PK	74	6.09	61.55	33.60	6.95	34.19	6.36
4882.00	49.16	AV	54	4.84	42.80	33.60	6.95	34.19	6.36
6147.00	66.02	PK	74	7.98	57.67	35.20	7.82	34.66	8.35
6147.00	46.66	AV	54	7.34	38.31	35.20	7.82	34.66	8.35
7323.00	65.09	PK	74	8.91	53.39	37.46	9.23	35.00	11.70
7323.00	46.14	AV	54	7.86	34.44	37.46	9.23	35.00	11.70

Frequency	Emission		Limit	Margin	Raw	Antenna Factor	Cable	Pre-amplifier	Correction
(MHz)	Level		(dBuV/m)	(dB)	Value	(dB/m)	Factor	(dB)	Factor
	(dBuV/m)				(dBuV)		(dB)		(dB/m)
2480.00	96.32	PK	114	17.68	98.07	28.92	4.70	35.38	-1.75
2480.00	88.74	AV	94	5.26	90.49	28.92	4.70	35.38	-1.75
2483.50	63.02	PK	74	10.98	64.76	28.93	4.70	35.38	-1.74
2483.50	46.51	AV	54	7.49	48.25	28.93	4.70	35.38	-1.74
3720.00	62.96	PK	74	11.04	59.76	32.77	6.08	35.65	3.20
3720.00	45.12	AV	54	8.88	41.92	32.77	6.08	35.65	3.20
4960.00	68.04	PK	74	5.96	61.34	33.84	7.00	34.14	6.70
4960.00	50.18	AV	54	3.82	43.48	33.84	7.00	34.14	6.70
6200.00	64.22	PK	74	9.78	55.82	35.19	7.90	34.69	8.40
6200.00	46.74	AV	54	7.26	38.34	35.19	7.90	34.69	8.40
7440.00	66.81	PK	74	7.19	54.86	37.64	9.28	34.97	11.95
7440.00	45.95	AV	54	8.05	34.00	37.64	9.28	34.97	11.95

Note: above 10GHz up to 25GHz was verified, and no any emission was found except system noise floor.

Remark: RBW=1MHz VBW=3MHz peak detector for PK value, RMS detector for AV value

For fundamental frequency, RBW=3MHz VBW=3MHz peak detector for PK value, RMS detector for AV value

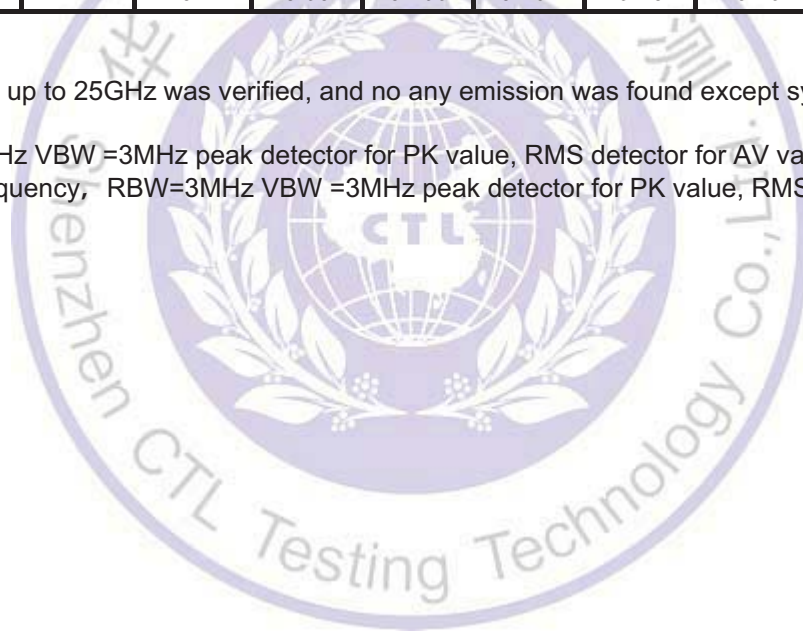

4.3. Occupied Bandwidth Measurement

Measurement Procedure

1. Set EUT as normal operation.
2. $RBW \geq 1\%$ of the 20 dB bandwidth, $VBW \geq RBW$.
3. The useful conducted emission from the EUT was detected by the spectrum analyser with peak detector.

Measurement Results

GFSK:

2402MHz

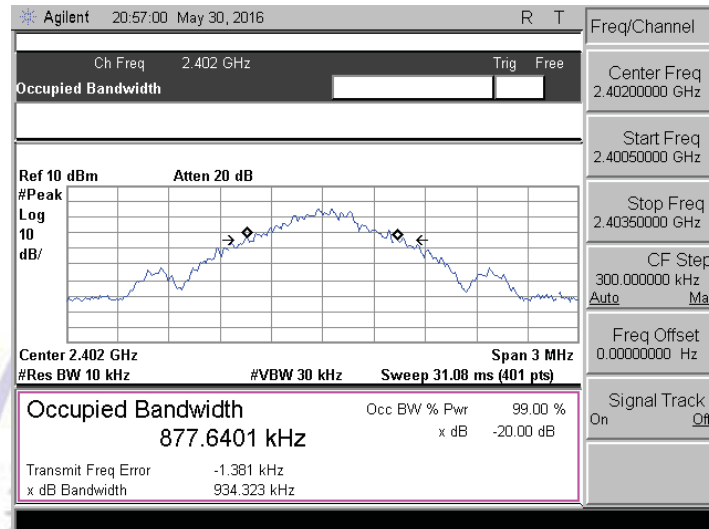

20dB Bandwidth: 934.323 KHz

2441MHz

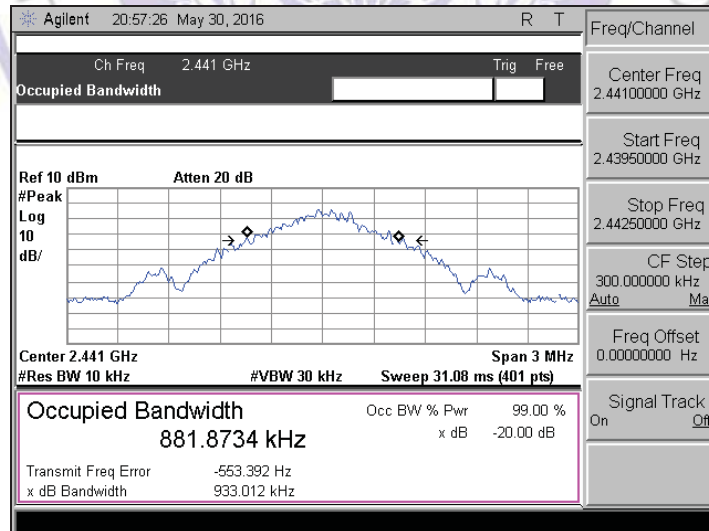

20dB Bandwidth: 933.012 KHz

2480MHz

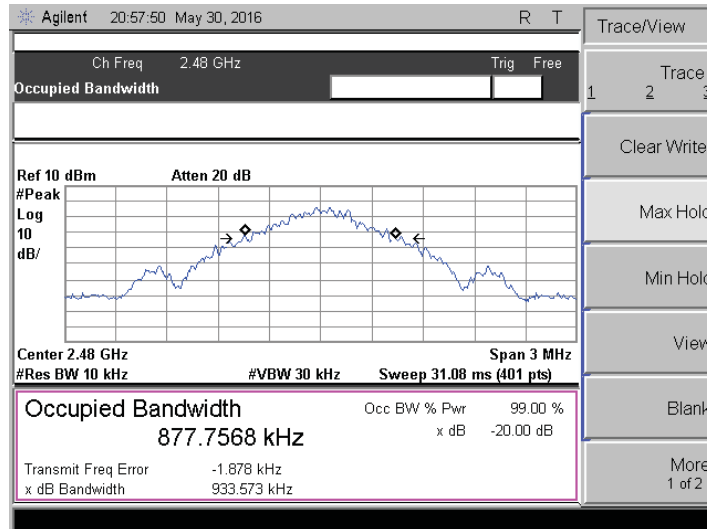

20dB Bandwidth: 933.573 KHz

π /4DQPSK mode:

2402MHz

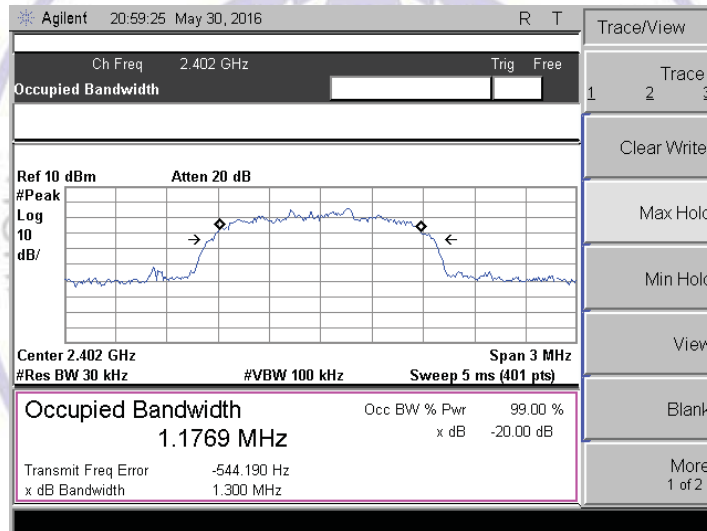

20dB Bandwidth: 1300 KHz

2441MHz

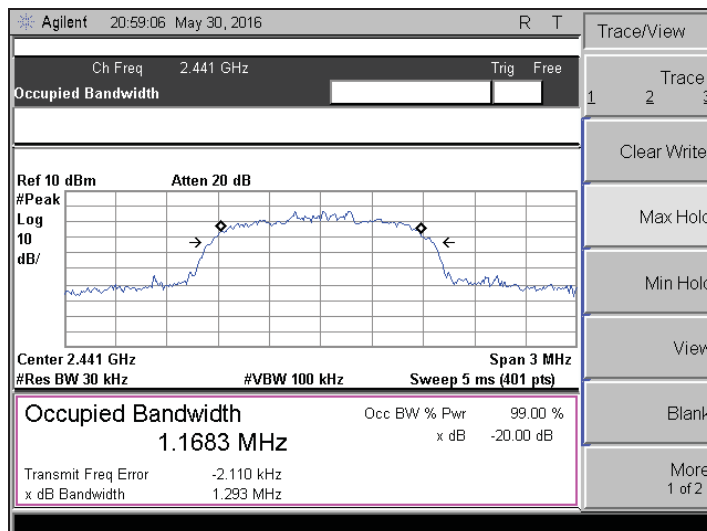

20dB Bandwidth: 1293 KHz

2480MHz

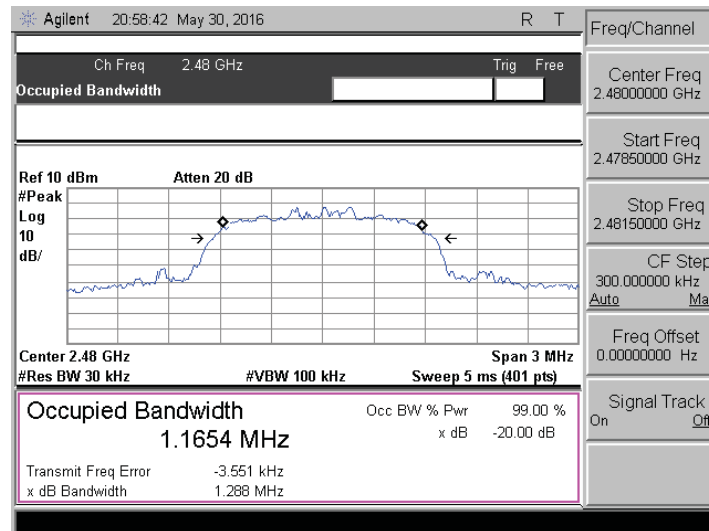

20dB Bandwidth: 1288 KHz

8DPSK mode:

2402MHz

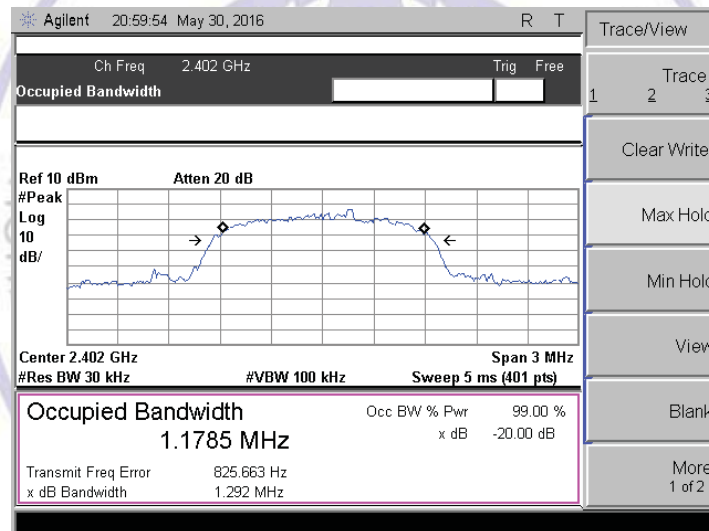

20dB Bandwidth: 1292 KHz

2441MHz

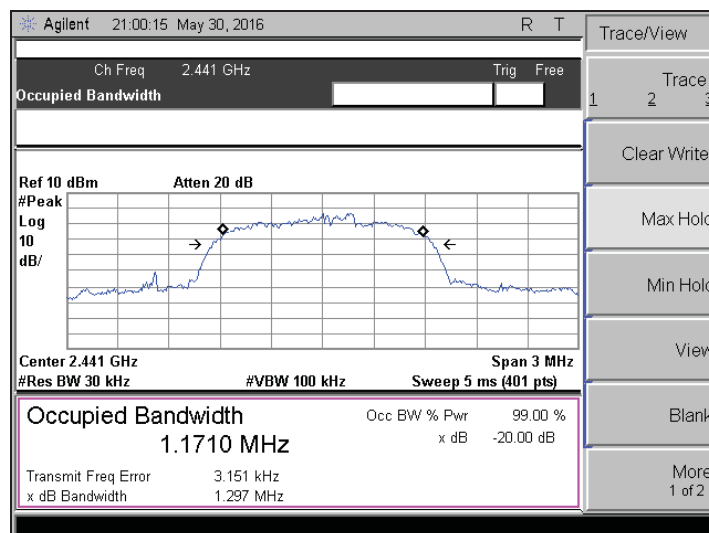

20dB Bandwidth: 1297 KHz

2480MHz

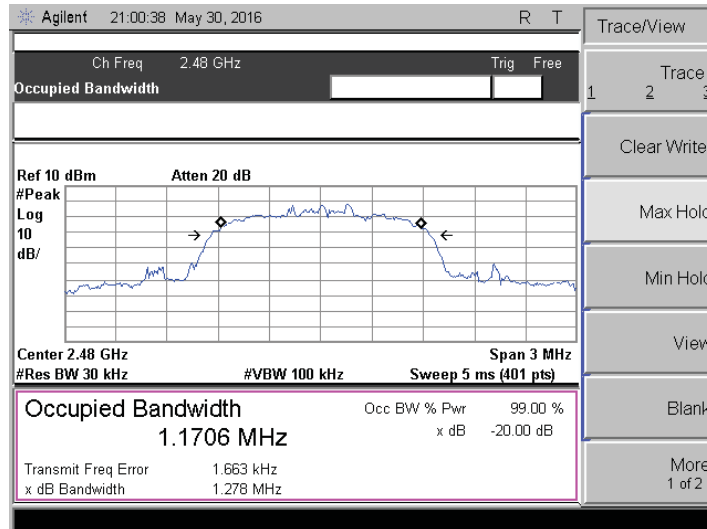

20dB Bandwidth: 1278 KHz



5. Antenna Requirement

Standard Applicable

For intentional device, according to FCC 47 CFR Section 15.203, an intentional radiator shall be designed to ensure that no antenna other than that furnished by the responsible party shall be used with the device.

And according to FCC 47 CFR Section 15.247 (c), if transmitting antennas of directional gain greater than 6dBi are used, the power shall be reduced by the amount in dB that the directional gain of the antenna exceeds 6dBi.

Refer to statement below for compliance.

The manufacturer may design the unit so that the user can replace a broken antenna, but the use of a standard antenna jack or electrical connector is prohibited. Further, this requirement does not apply to intentional radiators that must be professionally installed.

Antenna Connected Construction

The antenna used in this product is an internal Antenna, The directional gains of antenna used for transmitting is 0 dBi.



6. Test Setup Photos of the EUT

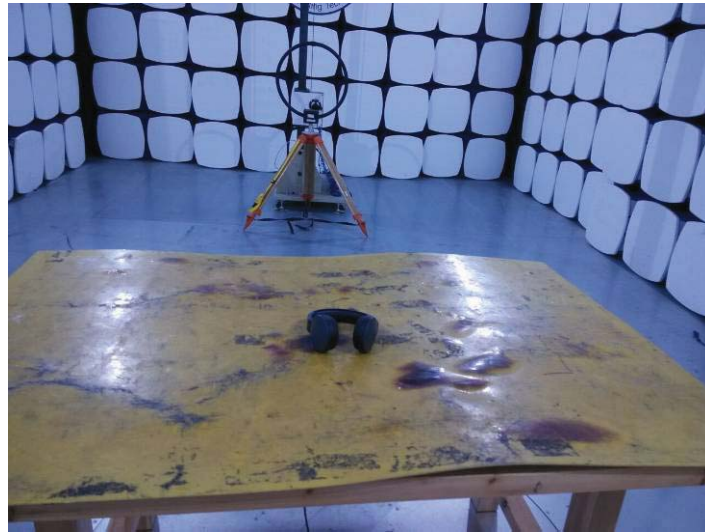



7. External and Internal Photos of the EUT

External Photos of EUT





Internal Photos of EUT

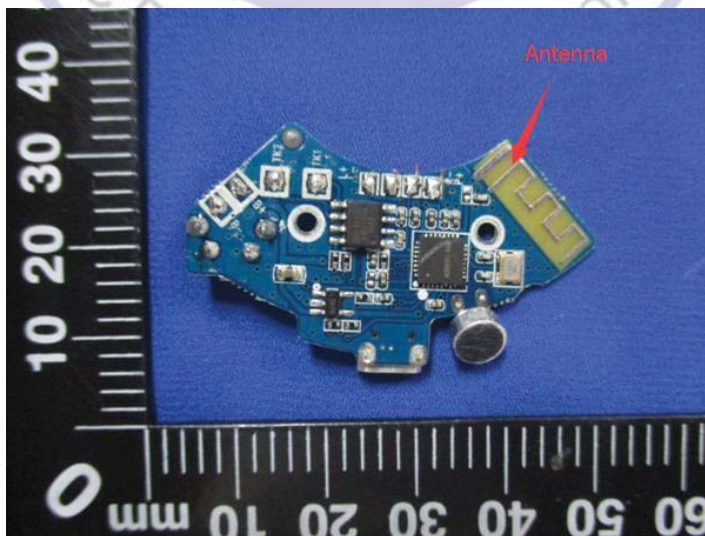
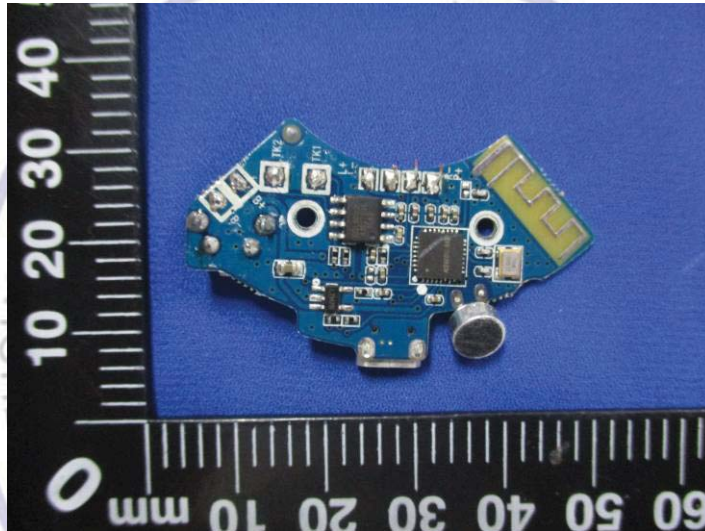

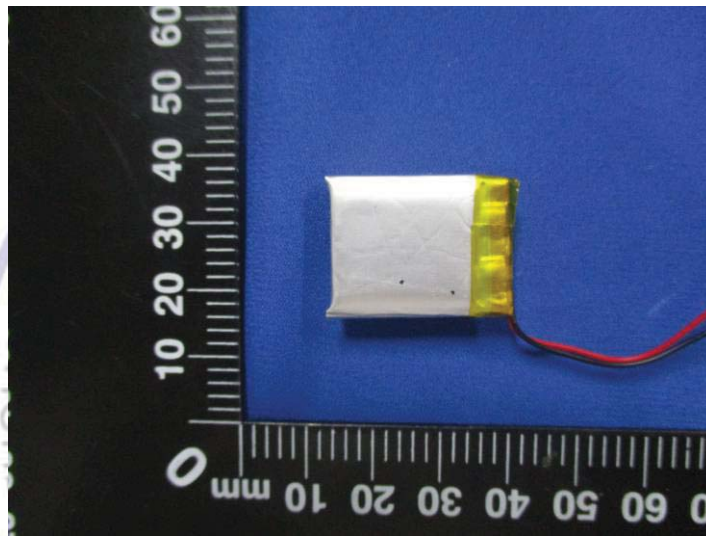
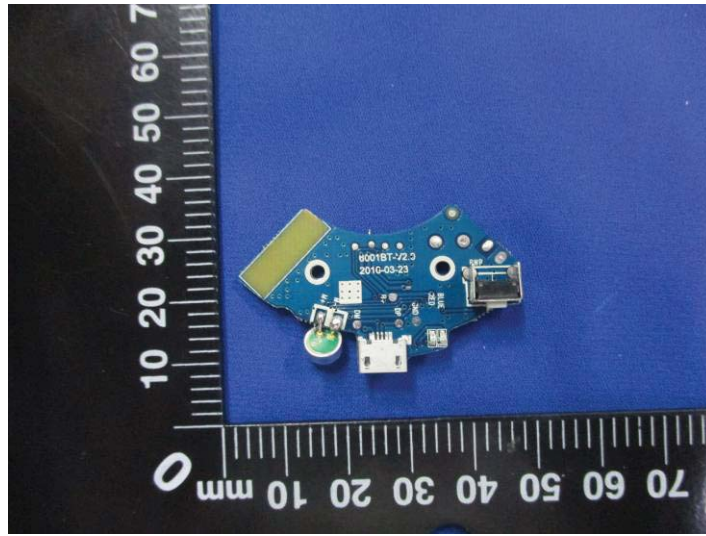

.....End of Report.....

