







| | | | |
|--|--|---|--|
|   <p>CE MARKING ELECTROMAGNETIC COMPATIBILITY ELECTRICAL SAFETY LASER SPECTROSCOPY ENVIRONMENTAL PHYSIC</p> | |  <p>www.tuv.com TÜVRheinland ID: 9105021519</p> | <p>Organizzazione con Sistema di Gestione certificato Company with Management System certified ISO 9001:2008</p>  |
| <p>G.S.D. Srl PISA - Italy</p> | | <p>Test Report n. FCC-14359B</p> | |
| | | <p>Rev. 00</p> | |
| | | | |
| <p>Manufacturer</p> | | <p>CAEN RFID s.r.l.</p> | |
| <p>Address</p> | | <p>Via Vetraia, 11 55049 Viareggio (LU) Italy</p> | |
| | | | |
| <p>Test Family Name</p> | | <p>R4300 ION (UHF)</p> | |
| | | | |
| <p>Testing Laboratory Name</p> | | <p>G.S.D. S.r.l.</p> | |
| <p>Address</p> | | <p>Via Marmiceto, 8 56121 Ospedaletto Pisa (PI) Italy</p> | |
| <p>Tel/Fax</p> | | <p>+39 050 984254 / +39 050 984262</p> | |
| <p>P.IVA/VAT</p> | | <p>01343950505</p> | |
| <p>http – e-mail</p> | | <p>www.gsd.it - info@gsd.it</p> | |
| | | <p>FCC Listed: Registration Number: 424037</p> | |
| | | | |
| <p>Location and Date of Issue</p> | | <p>Pisa, 2014 April 08</p> | |
| | | | |
| | | | |
| | | | |
| | | | |
| <p style="text-align: center;">G.S.D. s.r.l. Via Marmiceto, 8 56121 OSPEDALETTO - PISA Tel. 050.984254 - Fax 050.984262 P. IVA 01343950505</p> | | | |
| <p>SENIOR EMC TEST MANAGER Dr. Gian Luca Genovesi</p>  | | <p>QUALITY MANAGER Dr. David Pelliccia</p>  | |

INDEX

| | |
|--|-----------|
| 1. MANUFACTURER AND EUT IDENTIFICATION | 3 |
| 2. REFERENCE STANDARDS..... | 5 |
| 3. TEST GENERALITY, RESULT, CONDITION, MEASUREMENT UNCERTAINTY..... | 6 |
| 4. RADIATED EMISSIONS..... | 8 |
| 5. POWERLINE CONDUCTED EMISSIONS..... | 11 |
| 6. PHOTO..... | 20 |

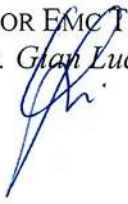
| | |
|---|--|
| 1. MANUFACTURER AND EUT IDENTIFICATION¹ | |
| Manufacturer | CAEN RFID s.r.l. |
| Address | Via Vetraia, 11 55049 Viareggio (LU) Italy |
| | |
| | |
| Test Family Name | R4300 ION (UHF) |
| | |
| | |
| Date of reception | 2014 January 23 |
| | |
| Sampling | Laboratory sample for certification |
| | |
| Test Item Description | RFID Device |
| | |
| Nominal Input Voltage | 24 Vdc |
| | |
| FCC ID | UVECAENRFID008 |
| | |

¹A detailed documentation is preserved in the internal fascicle.



Fig. 1.1
Equipment Photo

2. REFERENCE STANDARDS

Tests and measurements are performed accordingly to the reference standards given in the table below:

| <i>TEST</i> | <i>STANDARD</i> |
|---------------------------------------|--|
| Emissions: Radiated – Section 15.109 | FCC Rules ad Regulations, Title 47 (2008) Part 15 – Sub part B ANSI C63.4 (2009) – American National Standard for Methods of Measuring of Radio-Noise Emissions from Low Voltage Electrical and Electronic Equipment in the Range of 9 kHz – 40 GHz |
| Emissions: Conducted – Section 15.107 | FCC Rules ad Regulations, Title 47 (2008) Part 15 – Sub part B ANSI C63.4 (2009) – American National Standard for Methods of Measuring of Radio-Noise Emissions from Low Voltage Electrical and Electronic Equipment in the Range of 9 kHz – 40 GHz |

3. TEST GENERALITY, RESULT, CONDITION, MEASUREMENT UNCERTAINTY**Sub-part 2.1033(b)****Test And Measurement Data**

All tests and measurement data shown were performed in accordance with FCC Rules and Regulations, Volume II; Part 2 and the following individual Parts: 15.109; Unintentional Radiators

Standard Test Conditions and Engineering Practices

Except as noted herein, the following conditions and procedures were observed during the testing: In accordance with ANSI C63.4-2009, and unless otherwise indicated in the specific measurement results, the ambient temperature of the actual EUT was maintained within the range of 10° to 40°C (50° to 104 °F) unless the particular equipment requirements specify testing over a different temperature range. Also, unless otherwise indicated, the humidity levels were in the range of 10% to 90% relative humidity.

Prior to testing, the EUT was tuned up in accordance with the manufacturer's alignment procedures.

All external gain controls were maintained at the position of maximum and/or optimum gain throughout the testing.

Measurement results, unless otherwise noted, are worst-case measurements.

Summary of Test Results

| <i>TEST</i> | <i>RESULT</i> |
|--|---------------|
| <i>Emissions: conducted Section 15.107</i> | <i>Pass</i> |
| <i>Emissions: radiated Section 15.109</i> | <i>Pass</i> |

Measurement uncertainty

| <i>TEST</i> | <i>EXPANDED UNCERTAINTY</i> |
|---|-----------------------------|
| Conducted Emission – 50Ω/50μH (150 kHz - 30 MHz) | ± 3.5 dB |
| Radiated Emission – (Semianechoic Room) (30 MHz - 18 GHz) | ± 4.7 dB |

Climatic Conditions

| <i>PARAMETER</i> | <i>VALUE</i> |
|-------------------|--------------|
| Temperature | (293 ± 3) K |
| Relative humidity | (50 ± 5) % |

Extensions

The results refer only to the sampled EUT and under the specified conditions.

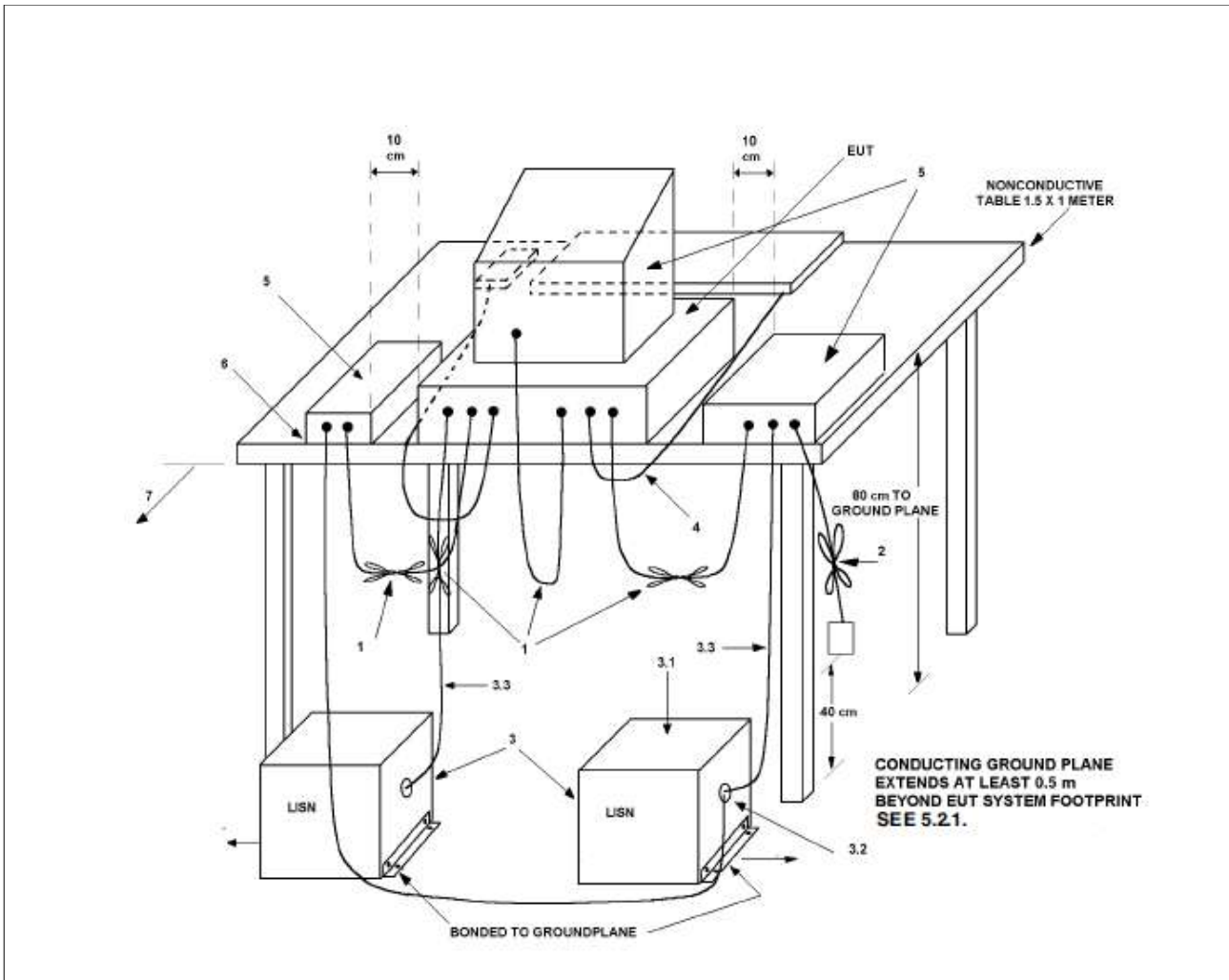

Conducted and Radiated EUT Test Set-up example (ANSI C63.4 2009)

Test Mode: the EUT was used with a personal computer and it was tested with standard SW CAEN RFID Easy Controller by USB.

4. RADIATED EMISSIONS

In the following table you can find the limits established by the reference standard:

| FREQUENCY RANGE (MHz) | Field Strength QUASI-PEAK LIMITS [dB (μV/m)] |
|----------------------------------|--|
| 30 ÷ 88 | 40 |
| 88 ÷ 216 | 43,5 |
| 216 ÷ 960 | 46 |
| Above 960 | 54 |

Test Equipment

| EQUIPMENT | MANUFACTURER | MODEL | CAL. DUE |
|-----------------------------|---------------------|--------------|-----------------|
| EMI Receiver | HP | HP8546A | 01/2015 |
| EMI Receiver Filter Section | HP | HP85460A | 01/2015 |
| Anechoic Chamber | Comtest | CSA01 | 01/2015 |
| Bilog Antenna | Schaffner | CBL6112B | 01/2015 |
| Horn Antenna | EMCO | 3115 | 01/2015 |
| Controller | Deisel | HD100 | 01/2015 |
| Turn Table | Deisel | MA240 | 01/2015 |
| LISN | GSD | NTW06 | 01/2015 |

Test procedure: RE22R02**Notes**

Azimuth position EUT-Antenna corresponding to 0° identifies the rotating table orientation (TT) in which the instrument to be tested shows the front part turned towards the antenna. Positive grades individuate clockwise rotations of TT when this one is observed from the top. For negative degrees, TT rotation is anticlockwise.

Antenna height respect to the mass plane is conventionally individuated with: MA=XXX where XXX indicates the height (always positive for $e > 100$) expressed in cm.

Antenna horizontal polarisation is indicated by POL=H.

Antenna vertical polarisation is indicated by POL=V.

EUT was tested in the three ortogonal planes.

Results and conclusions

In all the operative conditions, equipment complied with the standard limits. Graphics in following figures show the most significant registrations of the performed measurements.

Job Number FCC-14359B
 Test Name Radiated Emissions
 EUT Name CAEN RFID s.r.l. - R4300 ION (UHF)

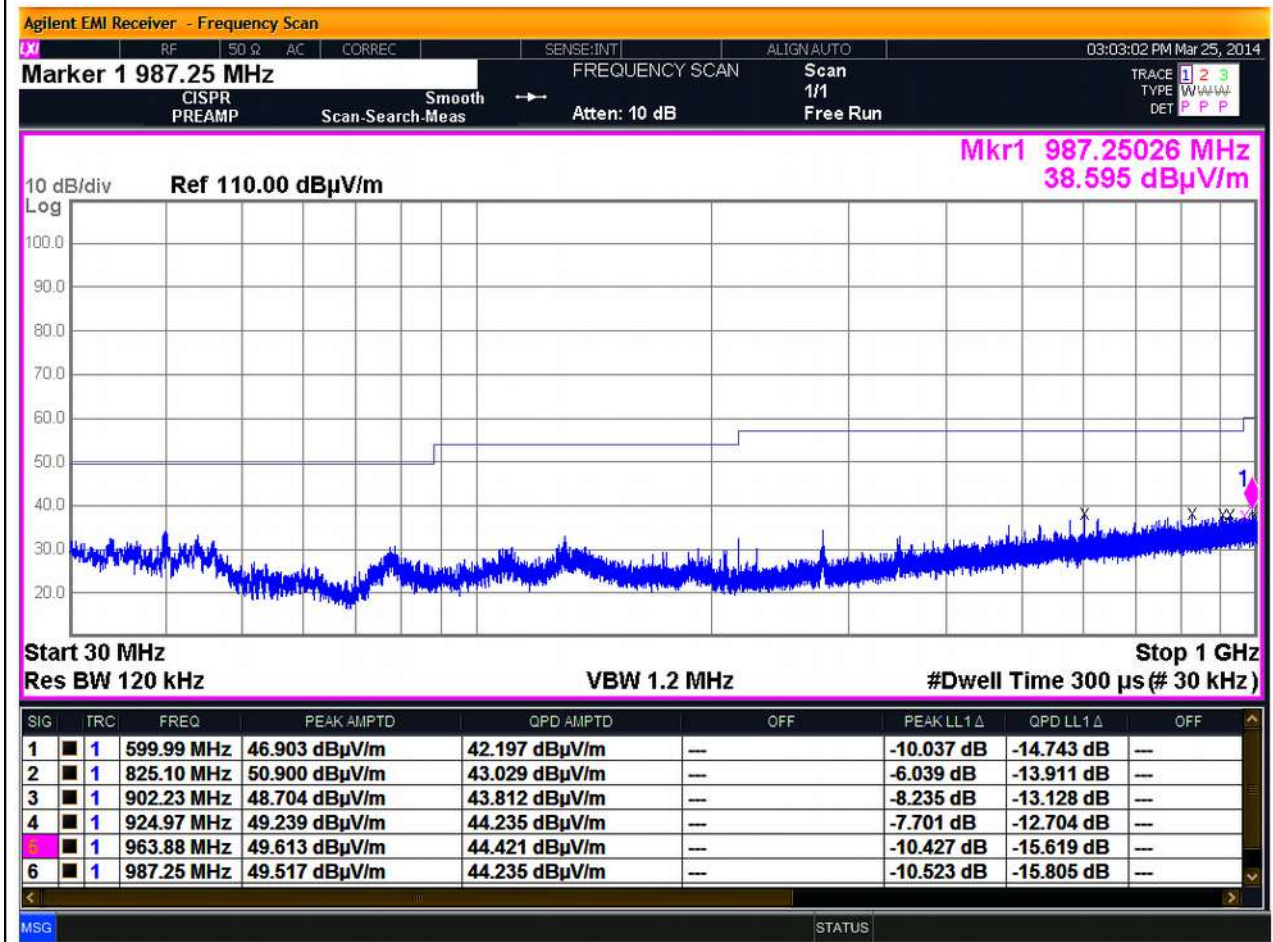

Fig. 4.1 - standby

Record of the measurement of radiated emissions (PK)
 Maximum disturbance determined in the frequency range 30 – 1000 MHz, Pol. V.

Job Number FCC-14359B
 Test Name Radiated Emissions
 EUT Name CAEN RFID s.r.l. - R4300 ION (UHF)

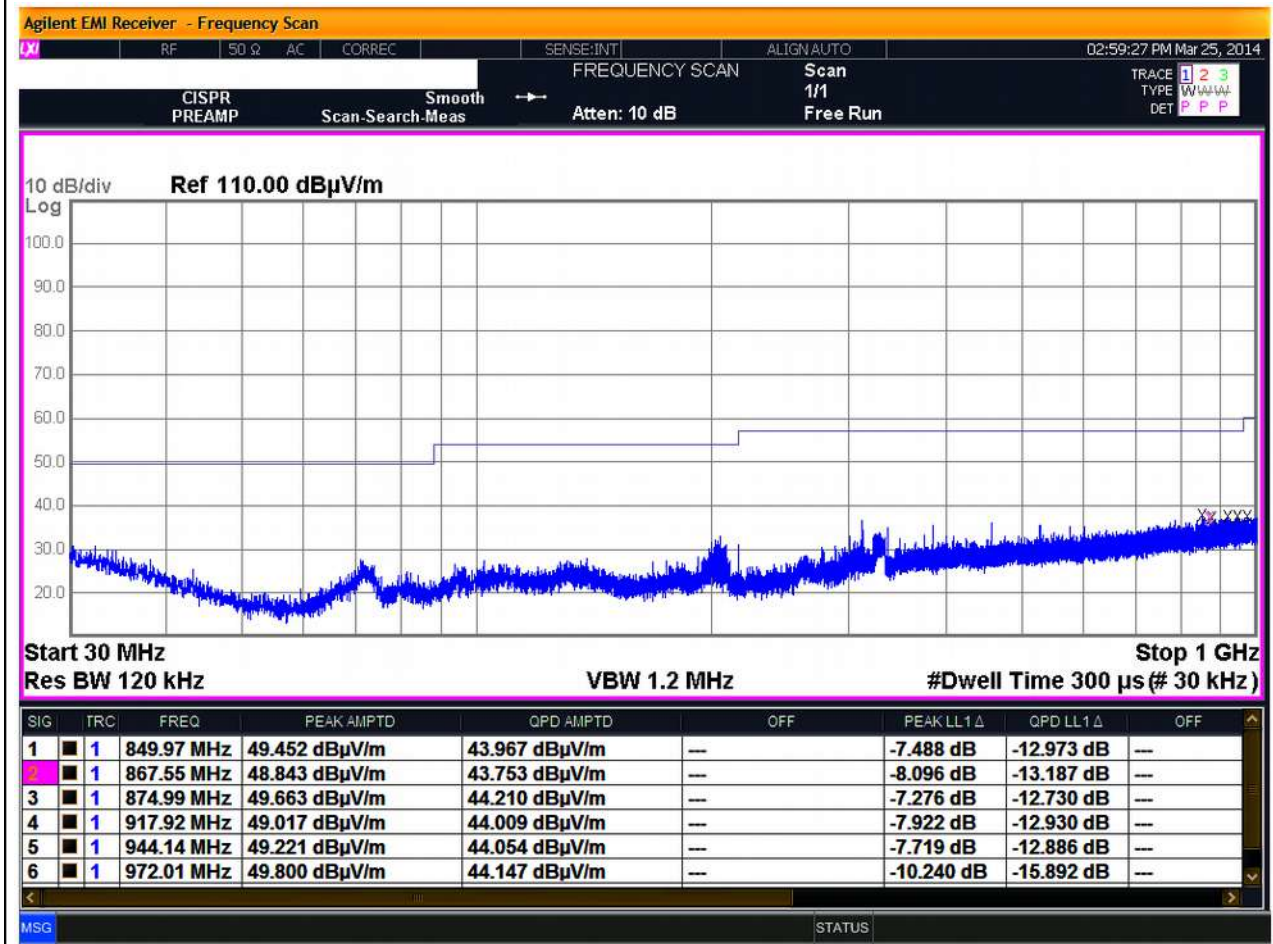

Fig. 4.2 - standby

Record of the measurement of radiated emissions (PK)
 Maximum disturbance determined in the frequency range 30 – 1000 MHz, Pol. H.

5. POWERLINE CONDUCTED EMISSIONS

Equipment shall meet the limits below when using a CISPR16 quasi-peak and average detector receivers.

FCC, 15.107

| FREQUENCY RANGE (MHz) | QUASI-PEAK LIMIT [dB (μV)] | AVERAGE LIMIT [dB (μV)] |
|---------------------------------|--------------------------------------|-----------------------------------|
| 0.15 ÷ 0.50 | 66 ÷ 56 ^(*) | 56 ÷ 46 ^(*) |
| 0.50 ÷ 5 | 56 | 46 |
| 5 ÷ 30 | 60 | 50 |

^(*) Limit decreasing linearly with logarithm of frequency

Test Equipment

| EQUIPMENT | MANUFACTURER | MODEL | CAL. DUE |
|-----------------------------|---------------------|--------------|-----------------|
| EMI Receiver | HP | HP8546A | |
| EMI Receiver Filter Section | HP | HP85460A | |
| Screened Room | GSD | CSC01 | |
| Transient Limiter | HP | 11947A | 01/2015 |
| LISN | GSD | GSDA01 | 01/2015 |

Test procedure: CE22R01

The EUT power cable was connected to a LISN and the monitored output of the LISN was connected to a spectrum analyzer by a transient limiter. The conducted emissions from 150 kHz to 30 MHz were monitored and compared to the specification limits

Test method

Test method was in accordance with the reference standard.

EUT modes of operations were tested in order to achieve the maximum level of emission.

Results

Equipment complied with the test specification limits.

Graphics in following figures show some registrations of the frequency spectrum of the conducted emissions.

Job Number FCC-14359B
 Test Name Powerline Conducted Emissions
 FCC 15.207
 EUT Name R4300 ION (UHF)

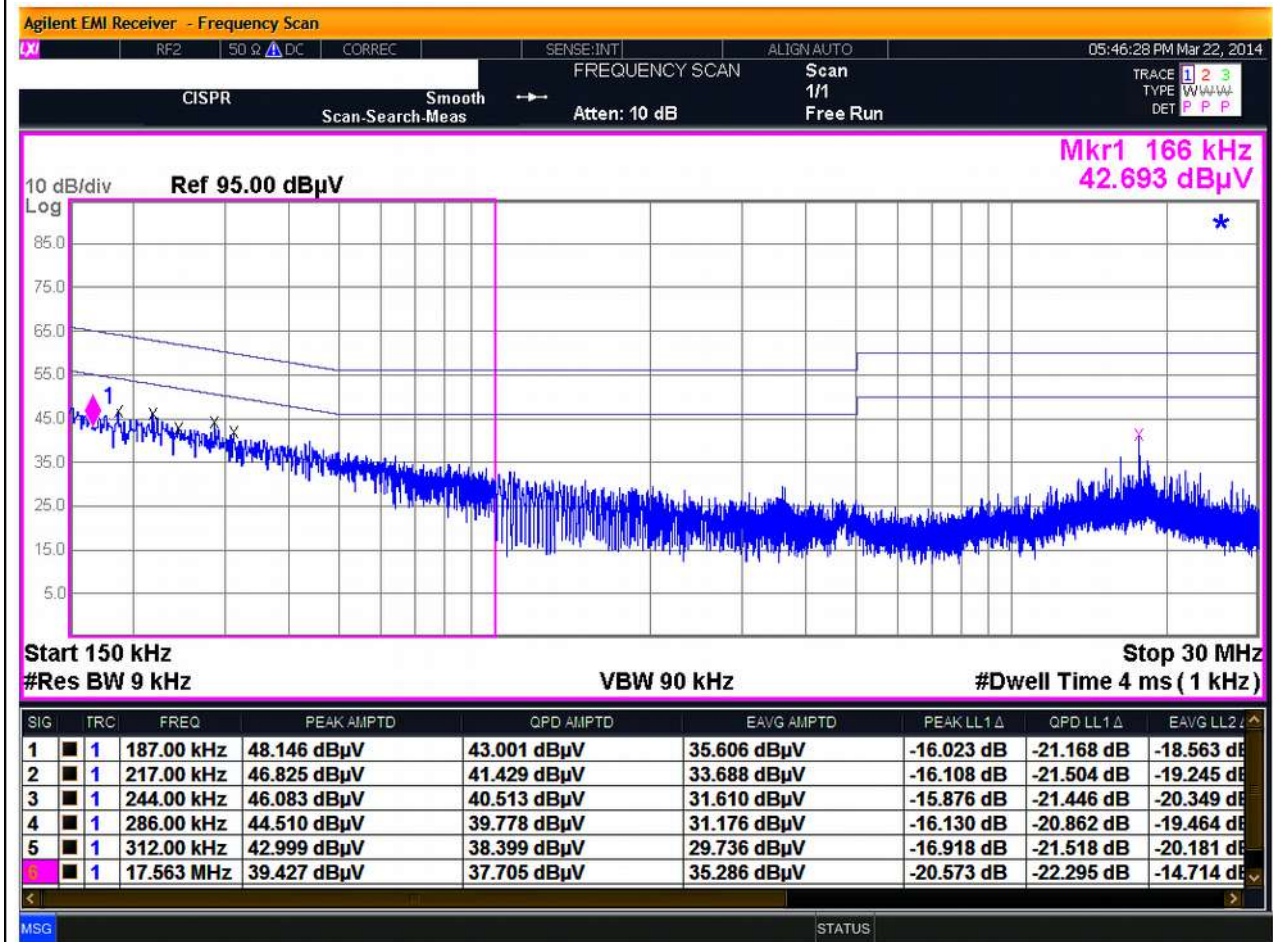

Fig. 5.1 - standby mode
 B Band (0.15 – 30 MHz): phase 1

Job Number FCC-14359B
 Test Name Powerline Conducted Emissions
 FCC 15.207
 EUT Name R4300 ION (UHF)

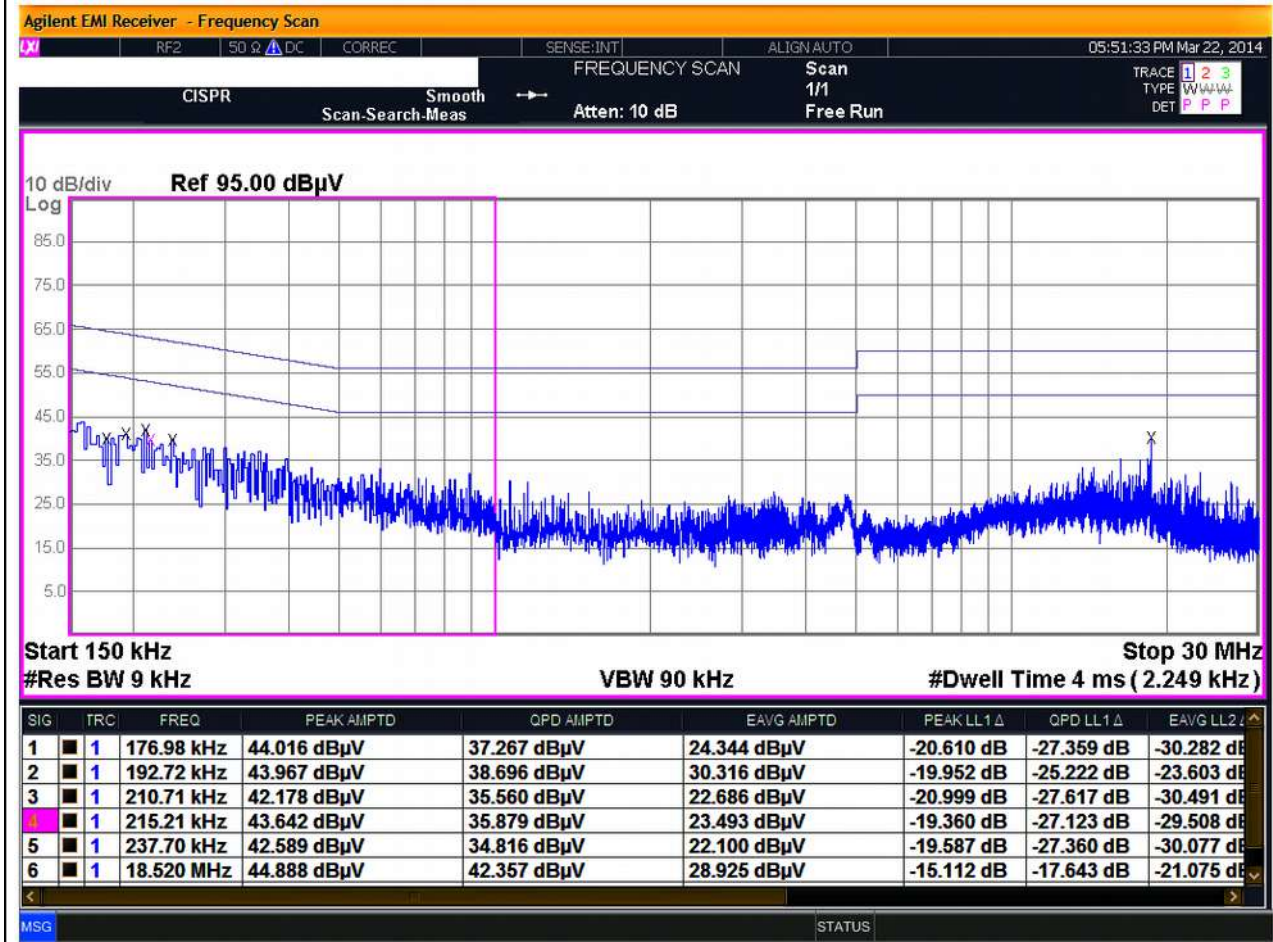

Fig. 5.2 - standby mode
 B Band (0.15 – 30 MHz): phase 2

Job Number FCC-14359B
 Test Name Powerline Conducted Emissions
 FCC 15.207
 EUT Name R4300 ION (UHF)

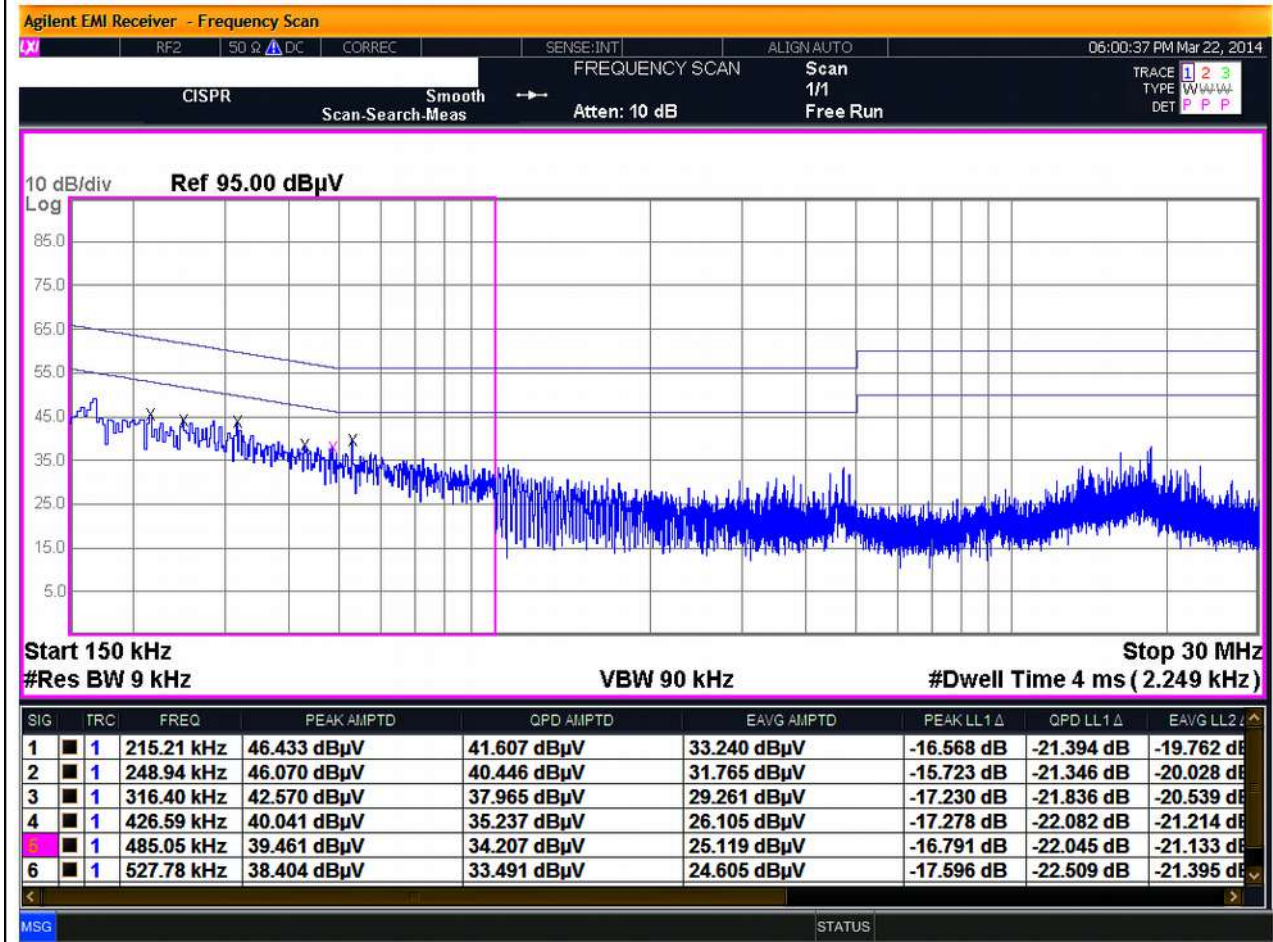

Fig. 5.3 - type 1 modulation
 B Band (0.15 – 30 MHz): phase 1

Job Number FCC-14359B
 Test Name Powerline Conducted Emissions
 FCC 15.207
 EUT Name R4300 ION (UHF)

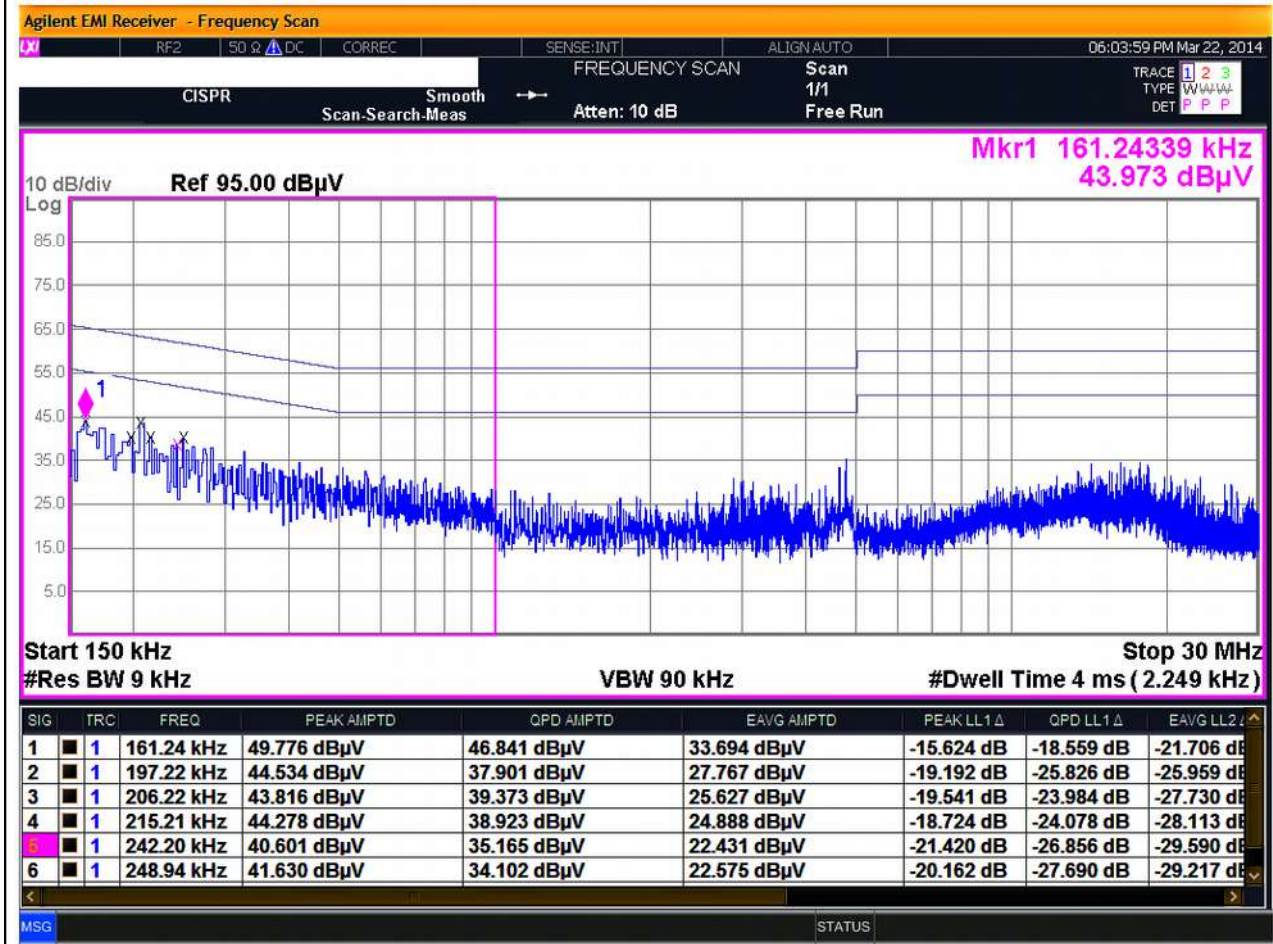

Fig. 5.4 - type 1 modulation
 B Band (0.15 – 30 MHz): phase 2

Job Number FCC-14359B
 Test Name Powerline Conducted Emissions
 FCC 15.207
 EUT Name R4300 ION (UHF)

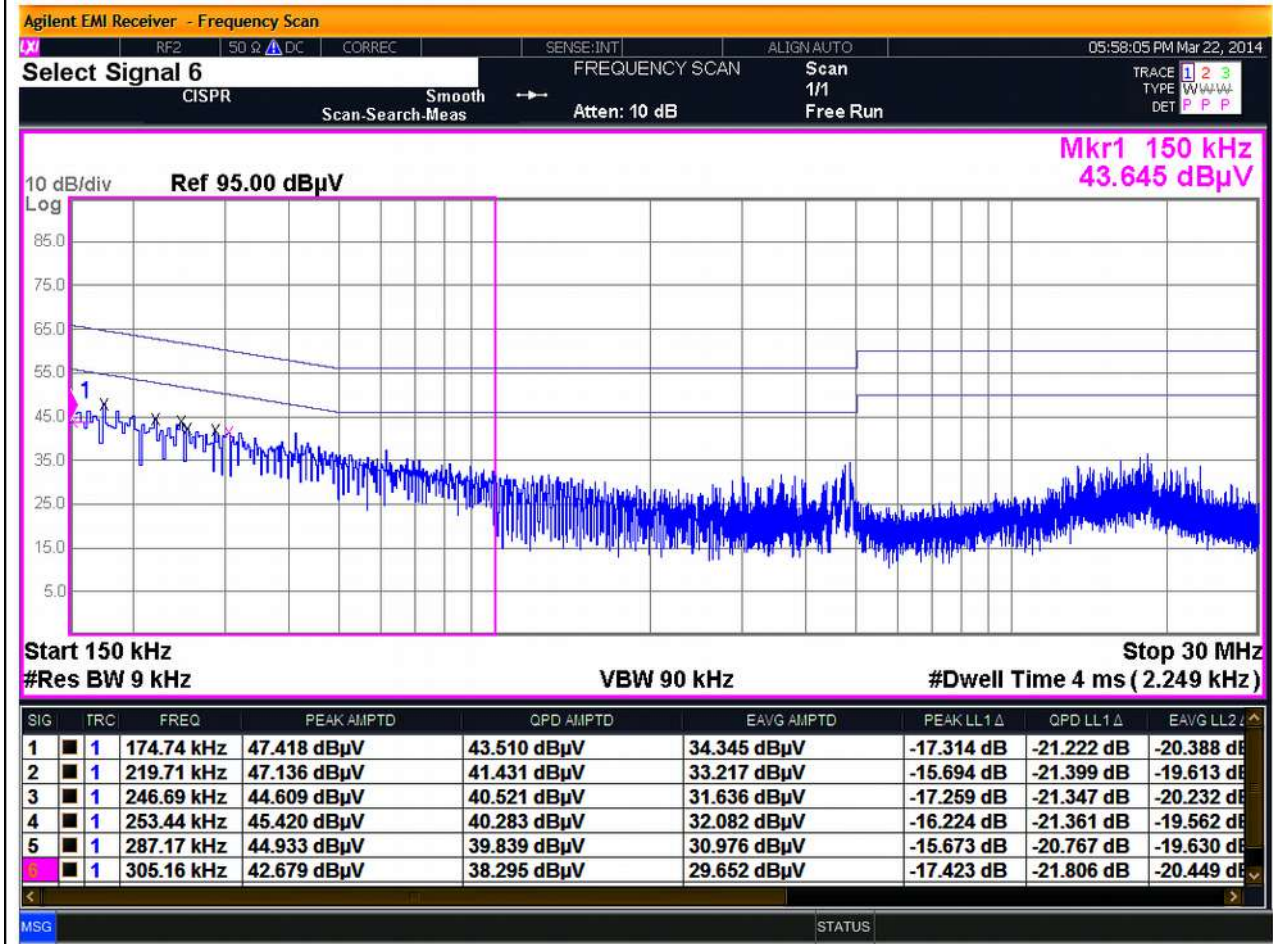

Fig. 5.5 - type 2 modulation
 B Band (0.15 – 30 MHz): phase 1

Job Number FCC-14359B
 Test Name Powerline Conducted Emissions
 FCC 15.207
 EUT Name R4300 ION (UHF)

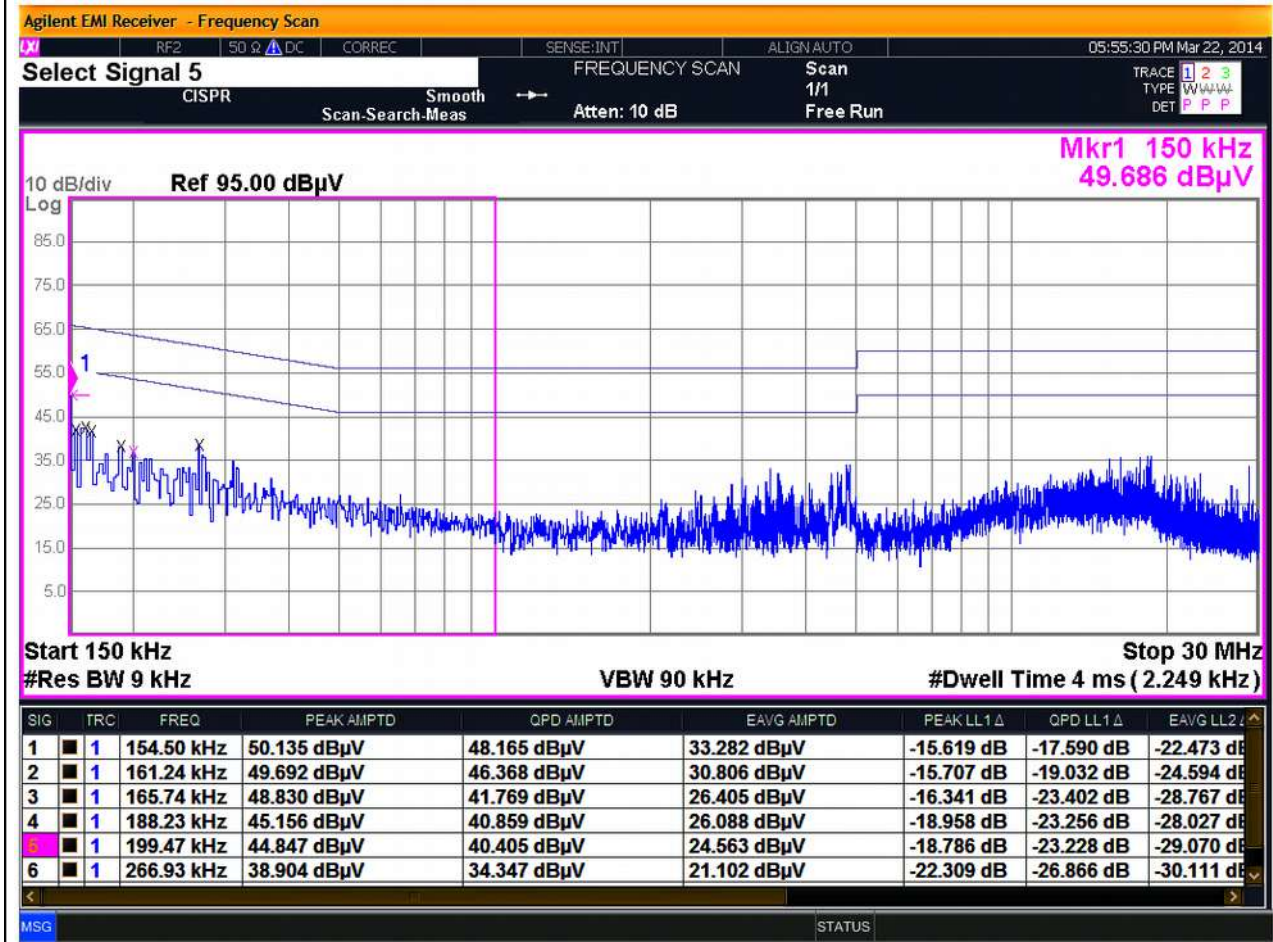

Fig. 5.6 - type 2 modulation
 B Band (0.15 – 30 MHz): phase 2

Job Number FCC-14359B
 Test Name Powerline Conducted Emissions
 FCC 15.207
 EUT Name R4300 ION (UHF)

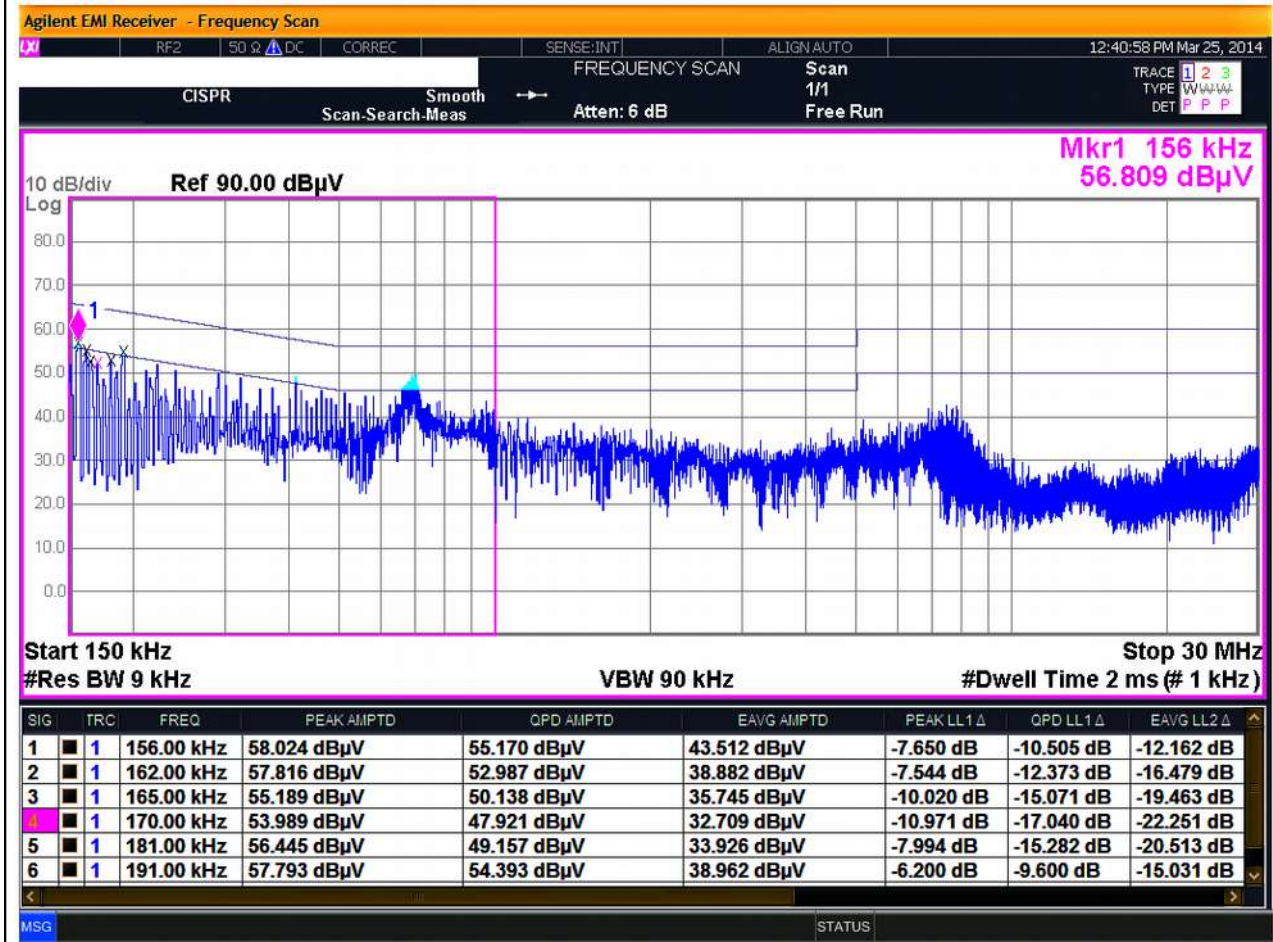

Fig. 5.7

B Band (0.15 – 30 MHz): PC (auxiliary equipment), phase 1 (worst case)

Job Number FCC-14359B
 Test Name Powerline Conducted Emissions
 FCC 15.207
 EUT Name R4300 ION (UHF)

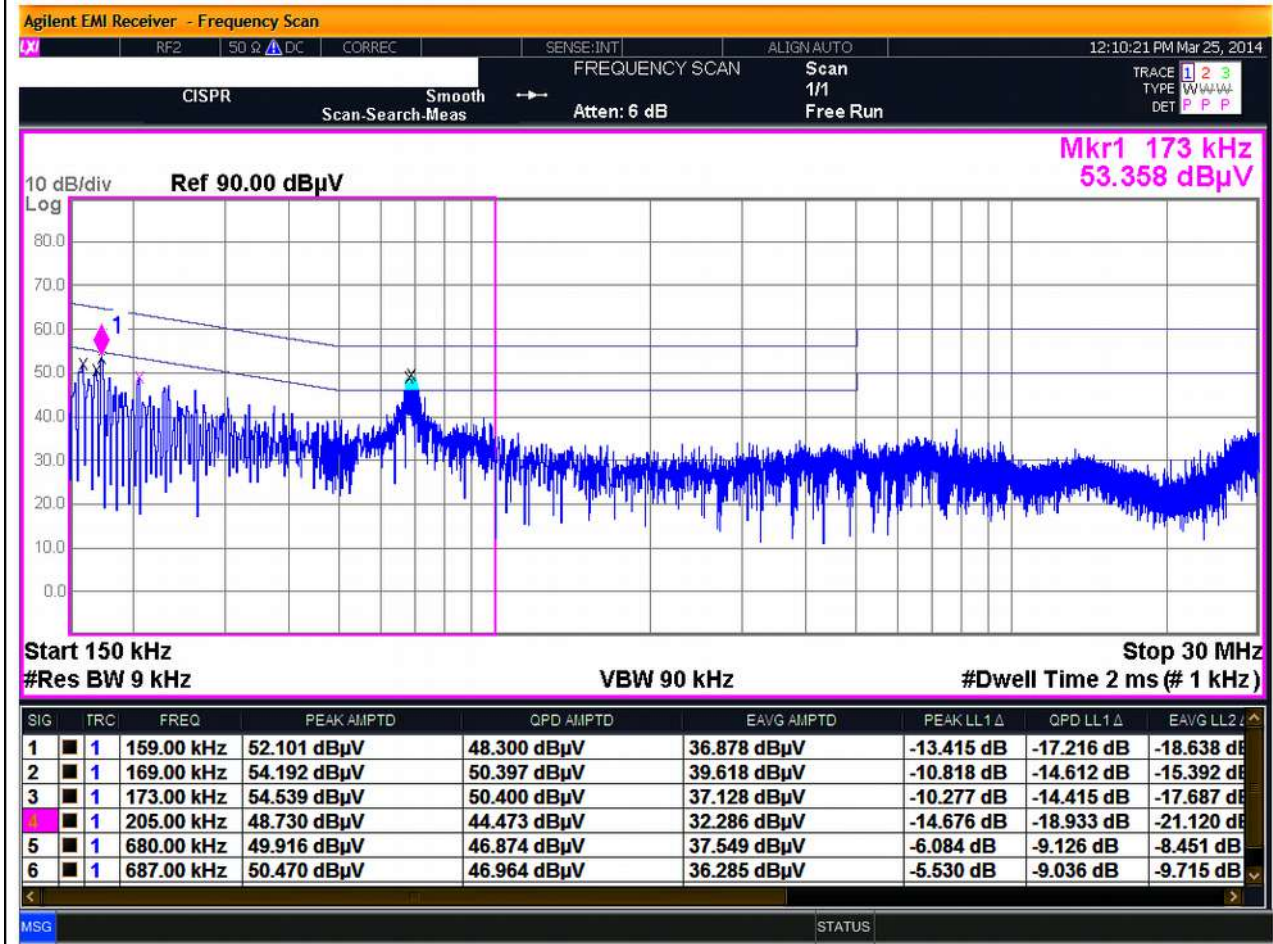

Fig. 5.8

B Band (0.15 – 30 MHz): PC (auxiliary equipment), phase 2 (worst case)

6. PHOTO

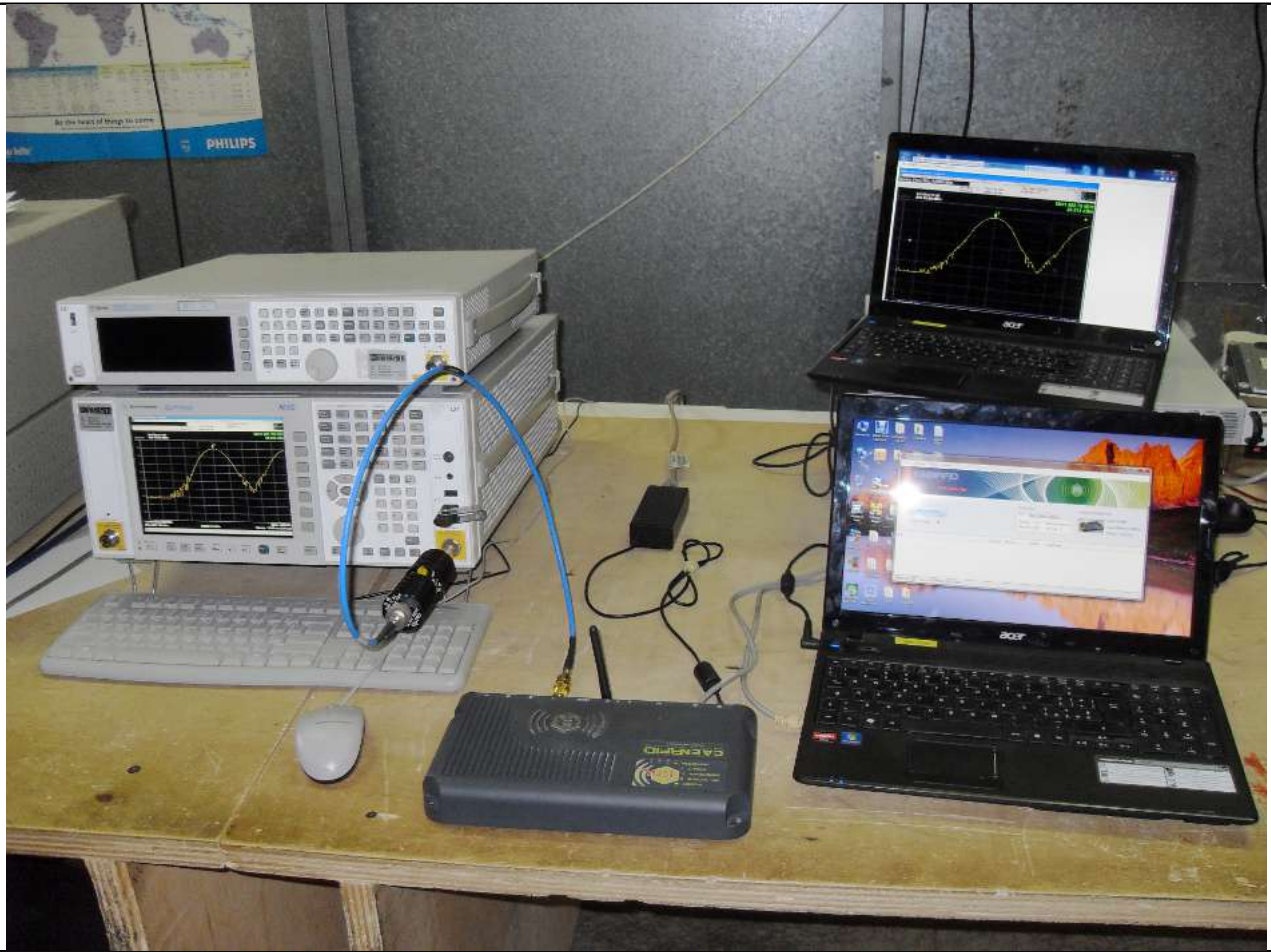

Fig. 6.1

Conducted Emissions Test Set-up



Fig. 6.2

Radiated Emissions Test Set-up