

# 47 CFR FCC Part 15 Subpart C

## Section 15.247

## TEST REPORT

Product : Blood Pressure Monitor

Trade Name : N/A

Model Number : BPM18R

FCC ID : UV3BPW-1718R

Prepared for

### AVITA Corporation

9F, No.78, Sec. 1, Kwang-Fu Road, San-Chung,  
New Taipei City, Taiwan

Prepared by

### Interocean EMC Technology Corp.

#### Interocean EMC Technology Tin-Fu Laboratory

No. 5-2, Lin 1, Tin-Fu, Lin-Kou Dist., New Taipei City,  
Taiwan 244, R.O.C.

TEL.: +886 2 2600 6861

FAX: +886 2 2600 6859



#### Remark :

The test report consists of 50 pages in total. It shall not be reproduced except in full, without the written approval of IETC. This document may be altered or revised by IETC only, and shall be noted in the revision section of the document.

The test result in this report is only subjected to the test sample.

# Table of Contents

<b>1</b>	<b>General Information</b>	<b>5</b>
1.1	Description of Equipment Under Test	5
1.2	Details of tested peripheral equipment	6
1.3	Table for Carrier Frequencies	7
1.4	Test Facility	8
1.5	Test Equipment	9
1.6	Measurement Uncertainty	9
1.7	Summary of Measurement	10
1.8	Justification	10
<b>2</b>	<b>Test Specifications</b>	<b>11</b>
2.1	Test Standard	11
2.2	Test Step of EUT	11
<b>3</b>	<b>RF Radiated Spurious Emission</b>	<b>12</b>
3.1	Limit	12
3.2	Configuration of Measurement	12
3.3	Test Procedure	13
3.4	Test Result	13
<b>4</b>	<b>RF Conducted Spurious Emission</b>	<b>16</b>
4.1	Limit	16
4.2	Configuration of Measurement	16
4.3	Test Procedure	16
4.4	Test Result	16
<b>5</b>	<b>Maximum Output Power</b>	<b>23</b>
5.1	Limit	23
5.2	Configuration of Measurement	23
5.3	Test Procedure	23
5.4	Test Result	23
<b>6</b>	<b>6dB Bandwidth</b>	<b>26</b>
6.1	Limit	26
6.2	Configuration of Measurement	26
6.3	Test Procedure	26
6.4	Test Result	26
<b>7</b>	<b>Power Spectral Density</b>	<b>29</b>
7.1	Limit	29
7.2	Configuration of Measurement	29
7.3	Test Procedure	29
7.4	Test Result	29

---

<b>8</b>	<b>Band Edge</b>	<b>32</b>
8.1	Limit	32
8.2	Configuration of Measurement	32
8.3	Test Procedure	32
8.4	Test Result	33
<b>9</b>	<b>AC Power Line Conducted Emission</b>	<b>38</b>
<b>10</b>	<b>Photographs of Test</b>	<b>39</b>
10.1	Radiated Emission Measurement	39
<b>11</b>	<b>Photographs of EUT</b>	<b>41</b>

# Statement of Compliance

**Applicant:** AVITA Corporation  
**Manufacturer:** 1. AVITA Corporation  
2. AVITA (Wujiang) Co., Ltd  
**Product:** Blood Pressure Monitor  
**Model No.:** BPM18R  
**Tested Power Voltage:** DC 3 V  
**Date of Final Test:** Jul. 05, 2017  
**Revision of Report:** Rev. 04

**Configuration of Measurements and Standards Used :**

FCC Rules and Regulations Part 15 Subpart C

I HEREBY CERTIFY THAT: The data shown in this report were made in accordance with the procedures given in ANSI C63.10 2013, and the energy emitted by the device was founded to be within the limits applicable. I assume full responsibility for accuracy and completeness of these data.

**Note:** 1. The result of the testing report relate only to the item tested.  
2. The testing report shall not be reproduced expect in full, without the written approval of IETC

Report Issued: 2017/11/06

Project Engineer:   
Elli Chang

Approved:   
Jerry Liu

## 1 General Information

### 1.1 Description of Equipment Under Test

<b>Product</b>	: Blood Pressure Monitor
<b>Model Number</b>	: BPM18R
<b>Applicant</b>	: <b>AVITA Corporation</b> 9F, No.78, Sec. 1, Kwang-Fu Road, San-Chung, New Taipei City, Taiwan
<b>Manufacturer</b>	: <b>1. AVITA Corporation</b> 9F, No.78, Sec. 1, Kwang-Fu Road, San-Chung, New Taipei City, Taiwan <b>2. AViTA (Wujiang) Co., Ltd</b> No.858, Jiao Tong Road, Wujiang Economic Development Zone, Jiangsu Province, P.R. China
<b>Power Supply</b>	: DC 3 V
<b>Operating Frequency</b>	: 2402 MHz - 2480 MHz
<b>Channel Number</b>	: 40 channels
<b>Type of Modulation</b>	: GFSK
<b>Antenna description</b>	: This device uses PCB Printed Antenna. Antenna gain: -1.5532 dBi. The antenna is integral to the device, thereby meeting the requirement of FCC 15.203.
<b>Date of Test</b>	: Jun. 20 ~ Jul. 05, 2017
<b>Additional Description</b>	: 1) The Model Number " <b>BPM18R</b> " is representative selected in the test and included in this report. 2) For more detail specification about EUT, please refer to the user's manual. 3) Compliant with Bluetooth Ver 4.0.

## 1.2 Details of tested peripheral equipment

N/A

### 1.3 Table for Carrier Frequencies

#### Bluetooth 4.0

Channel	Frequency	Channel	Frequency	Channel	Frequency
0	2402 MHz	14	2430 MHz	28	2458 MHz
1	2404 MHz	15	2432 MHz	29	2460 MHz
2	2406 MHz	16	2434 MHz	30	2462 MHz
3	2408 MHz	17	2436 MHz	31	2464 MHz
4	2410 MHz	18	2438 MHz	32	2466 MHz
5	2412 MHz	19	2440 MHz	33	2468 MHz
6	2414 MHz	20	2442 MHz	34	2470 MHz
7	2416 MHz	21	2444 MHz	35	2472 MHz
8	2418 MHz	22	2446 MHz	36	2474 MHz
9	2420 MHz	23	2448 MHz	37	2476 MHz
10	2422 MHz	24	2450 MHz	38	2478 MHz
11	2424 MHz	25	2452 MHz	39	2480 MHz
12	2426 MHz	26	2454 MHz		
13	2428 MHz	27	2456 MHz		

## 1.4 Test Facility

- Site Description** : RF Test Room Chamber 3
- Name of Firm** : Interocean EMC Technology Corp.
- Company web** : <http://www.ietc.com.tw>
- Location** : No. 5-2, Lin 1, Tin-Fu, Lin-Kou Dist., New Taipei City, Taiwan 244, R.O.C.
- Site Filing** :
- Federal Communication Commissions – USA  
Designation No.: TW1020 (Test Firm Registration #: 651092)  
Designation No.: TW1113 (Test Firm Registration #: 959554)
  - Industry Canada (IC)  
OUR FILE: 46405-4437  
Registration No. (OATS 1): Site# 4437A-1  
Registration No. (OATS 3): Site# 4437A-3  
Registration No. (Chamber 3): Site# 4437A-5  
Registration No. (OATS 5): Site# 4437A-6
  - Voluntary Control Council for Interference by Information Technology Equipment (VCCI) – Japan  
Member No.: 1349  
Registration No. (Conducted Room): C-1094  
Registration No. (Conducted Room): T-1562  
Registration No. (OATS 1): R-1040; G-10274
- Site Accreditation** :
- Bureau of Standards and Metrology and Inspection (BSMI) – Taiwan, R.O.C.  
Accreditation No.:  
SL2-IN-E-0026 for CNS 13438 / CISPR 22  
SL2-R1-E-0026 for CNS 13439 / CISPR 13  
SL2-R2-E-0026 for CNS 13439 / CISPR 13  
SL2-L1-E-0026 for CNS 14115 / CISPR 15
  - Taiwan Accreditation Foundation (TAF)  
Accreditation No.: 1113
  - Vehicle Safety Certification Center (VSCC)  
Approval No.: TW16-11
  - TÜV NORD  
Certificate No: TNTW0801R



### 1.5 Test Equipment

Instrument	Manufacturer	Model	Serial No.	Next Cal. Date
EMI Test Receiver	R&S	ESI7	830154/002	2017/09/07
Spectrum Analyzer	R&S	FSP40	100478	2018/06/19
Biconical Antenna	Schwarzbeck	VHA 9103 & BBA 9106	VHA 9103-2418	2017/07/13
Log Antenna	Schwarzbeck	UHALP 9108-A	9108-A 0739	2017/07/13
Horn Antenna	Schwarzbeck	BBHA9120	9120D-1051	2017/10/27
Horn Antenna	Schwarzbeck	BBHA 9170	213	2017/08/16
Pre-Amplifier	Burgeon	BPA-530	100216	2017/09/11
Pre-Amplifier	EMCI	EMC 051845	980110	2017/10/19
Pre-Amplifier	Agilent	83050A	3950M00225	2017/08/10
RF Cable	Jye Bao	A30N30-5005	CBL51	2017/08/02
RF Cable	Jye Bao	N30N30-5006	CBL53	2017/08/02
RF Cable	HARBOUR	27478LL142	CBL65	2017/08/02
RF Cable	Junkosha	MWX241	CBL58	2017/10/25
ATTENUATOR	Fairview Calibr	SA18S5W-10	10#2	2018/06/22

Note: The above equipments are within the valid calibration period.

### 1.6 Measurement Uncertainty

Item	Expended Uncertainty (k=2)
Conduction 1:	
Conducted Emission (9 kHz to 30 MHz)	2.98 dB
Chamber 3:	
Radiated Emission Test (30 MHz to 1 GHz)	4.86 dB
Radiated Emission Test (above 1 GHz)	5.12 dB
RF test:	
RF conducted measurement (9 kHz to 40 GHz)	2.92 dB

### 1.7 Summary of Measurement

Report Clause	Test Parameter	Reference Document CFR47 Part15	Results
3	RF Radiated spurious emission	§15.205, 15.209	PASS
4	RF Conducted spurious emission	§15.247(d)	PASS
5	Maximum Peak output power	§15.247(b)	PASS
6	6dB Bandwidth	§15.247(a)(2)	PASS
7	Power spectral density	§15.247(e)	PASS
8	Emission on the Band Edge	§15.247(d)	PASS
9	AC Power Line Conducted Emission	§15.207	N/A

### 1.8 Justification

The test of radiated measurements according to FCC Part15 Section 15.33(a) had been conducted and the field strength of the frequency band was all arrive limit requirement, thus we evaluate the EUT pass the specified test.

## **2 Test Specifications**

### **2.1 Test Standard**

The EUT was performed according to FCC Part 15 Subpart C Section 15.247 procedure and setup followed by ANSI C63.10, 2013 requirements.

### **2.2 Test Step of EUT**

- 2.2.1 Before setup the EUT for power supplying, Pin (P04) short ground 5 Sec.
- 2.2.2 Turn on the power, select low, medium, high channel.
- 2.2.3 Let the EUT continuous transmission.
- 2.2.4 Executed the test.

### 3 RF Radiated Spurious Emission

#### 3.1 Limit

For intentional radiator, the radiated emission shall comply with FCC Part 15.209(a).

For intentional radiators, according to FCC Part 15.247 (a), operation under this provision is limited to frequency hopping and direct sequence spread spectrum, and the out band emission shall be comply with FCC Part 15.247 (c)

Frequency (MHz)	Field strength dB( $\mu$ V/m)	Measurement distance (meters)
1.705 ~ 30.0	29.5	30
30 ~ 88	40	3
88 ~ 216	43.5	3
216 ~ 960	46	3
Above 960	54	3

#### 3.2 Configuration of Measurement

Measurement Frequency under 1 GHz

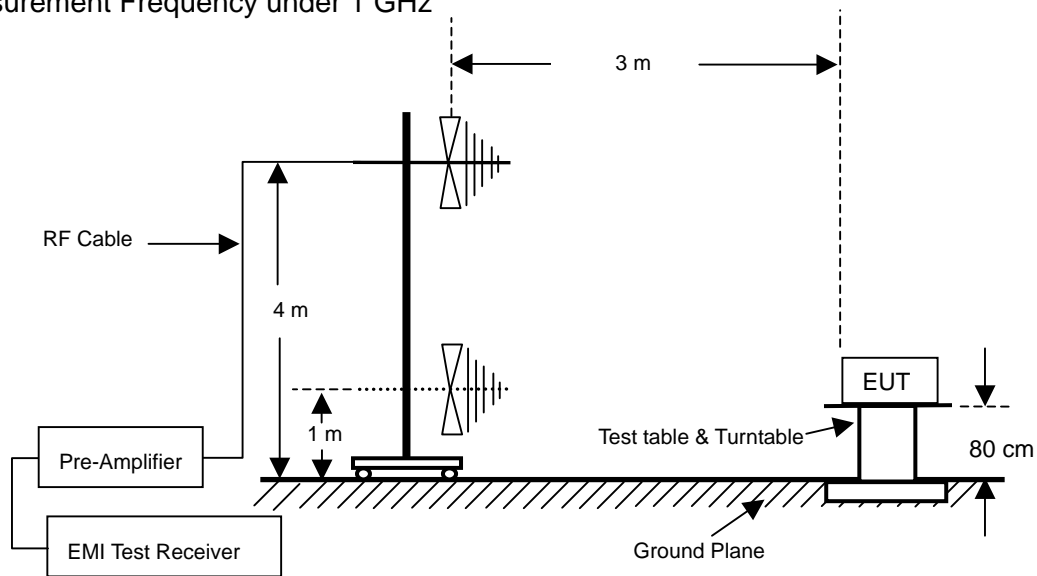

Measurement Frequency above 1 GHz

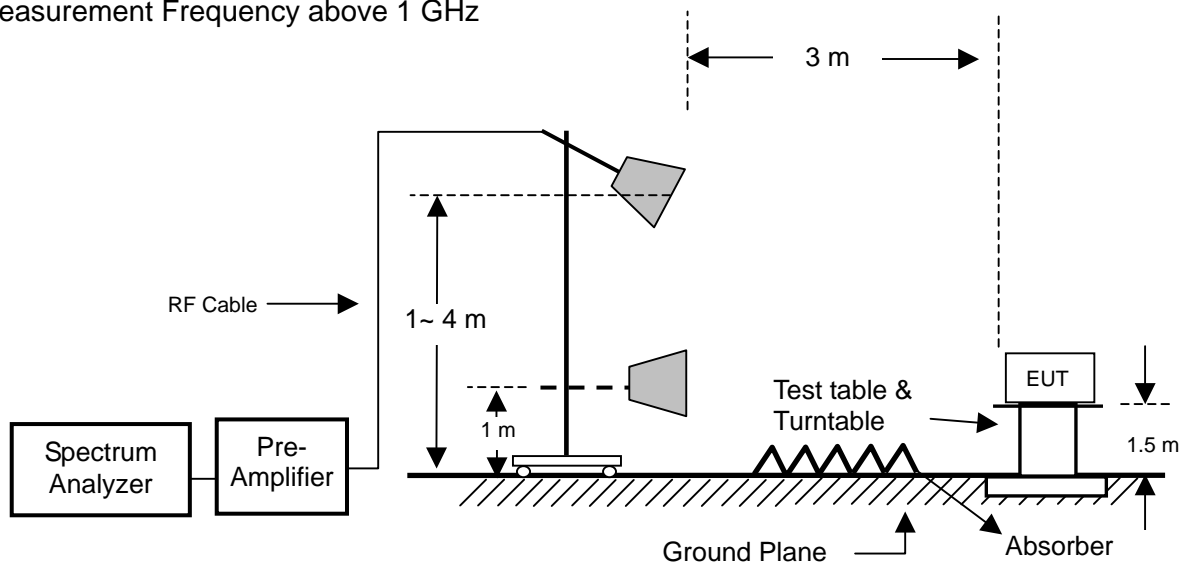

### 3.3 Test Procedure

The EUT was setup to ANSI C63.10, 2013; tested procedure of Jan. 2016 KDB558074 D01 for compliance to FCC 47CFR 15.247 requirements.

Radiated emission measurements were performed from 9kHz to 25GHz. Spectrum Analyzer set frequency range from 9kHz to 30MHz: RBW=9kHz; 30MHz to 1GHz: RBW=100kHz or greater. For frequencies above 1GHz: set RBW=VBW=1MHz for peak detector and RBW=1MHz, VBW=10Hz for average detector.

The EUT for testing is arranged on a non-conductive turntable. If some peripherals apply to the EUT, the peripherals will be connected to EUT and the whole system. During the test, all cables were arranged to produce worst-case emissions. The signal is maximized through rotation. The height of antenna and polarization is changing constantly for exploring for maximum signal level. The height of antenna can be up to 4 meter and down to 1 meter.

### 3.4 Test Result

**PASS.**

The final test data is shown as following pages.

## Radiated Emission Below 1 GHz

Frequency	Antenna	Reading	Preamp	Correction Factor	Corrected Level	Limits	Margin	Det
(MHz)	Polarization	(dBuV)	(dB)	(dB/m)	(dBuV/m)	(dBuV/m)	(dB)	Mode
118.75	H	40.18	31.44	13.99	22.73	43.52	-20.79	PK
203.65	H	33.86	31.21	18.64	21.29	43.52	-22.23	PK
299.30	H	33.20	31.34	22.49	24.35	43.52	-19.17	PK
387.20	H	37.43	31.29	19.47	25.61	46.02	-20.41	PK
453.29	H	35.53	31.30	20.85	25.08	46.02	-20.94	PK
502.33	H	37.12	31.32	21.19	26.99	46.02	-19.03	PK
87.23	V	40.00	31.55	10.27	18.72	40.00	-21.28	PK
156.90	V	40.56	31.31	13.26	22.51	43.52	-21.01	PK
254.89	V	36.05	31.28	19.10	23.87	46.02	-22.15	PK
345.78	V	38.37	31.31	17.77	24.83	46.02	-21.19	PK
412.20	V	37.21	31.29	19.17	25.09	46.02	-20.93	PK
494.33	V	36.84	31.32	20.97	26.49	46.02	-19.53	PK

Remark : Corrected Level = Reading + Correction Factor - Preamp

Correction Factor = Antenna Factor + Cable Loss

\* Mark indicated background noise level.

The frequency range from 9 kHz to 30 MHz was pre-scanned and the results were 20 dB lower than the limit line which according to FCC 15.31(o) needs not be recorded.

ANSI C63.10\_2013\_11.12.2.3: As an alternative to CISPR quasi-peak measurement, compliance can be determined for the applicable emission requirements using a peak detector.

## Radiated Emission Above 1 GHz

### CH00 (2402 MHz)

Frequency	Antenna	Reading	Preamp	Correction Factor	Corrected Level	Limits	Margin	Det
(MHz)	Polarization	(dBuV)	(dB)	(dB/m)	(dBuV/m)	(dBuV/m)	(dB)	Mode
4804	H	65.32	52.06	40.60	53.86	74	-20.14	PK
4804	H	59.08	52.06	40.60	47.62	54	-6.38	AV
7206	H	55.73	52.48	47.44	50.69	54	-3.31	PK
*9608	H	52.87	52.50	52.48	52.85	54	-1.15	PK
4804	V	64.18	52.06	40.60	52.72	74	-21.28	PK
4804	V	57.85	52.06	40.60	46.39	54	-7.61	AV
7206	V	55.60	52.48	47.44	50.56	54	-3.44	PK
*9608	V	52.65	52.50	52.48	52.63	54	-1.37	PK

### CH19 (2440 MHz)

Frequency	Antenna	Reading	Preamp	Correction Factor	Corrected Level	Limits	Margin	Det
(MHz)	Polarization	(dBuV)	(dB)	(dB/m)	(dBuV/m)	(dBuV/m)	(dB)	Mode
4880	H	65.10	52.08	40.79	53.81	74	-20.19	PK
4880	H	59.08	52.08	40.79	47.79	54	-6.21	AV
7320	H	55.85	52.41	47.82	51.26	54	-2.74	PK
*9760	H	52.51	52.50	52.77	52.78	54	-1.22	PK
4880	V	63.17	52.08	40.79	51.88	74	-22.12	PK
4880	V	56.78	52.08	40.79	45.49	54	-8.51	AV
7320	V	55.72	52.41	47.82	51.13	54	-2.87	PK
*9760	V	52.47	52.50	52.77	52.74	54	-1.26	PK

### CH39 (2480 MHz)

Frequency	Antenna	Reading	Preamp	Correction Factor	Corrected Level	Limits	Margin	Det
(MHz)	Polarization	(dBuV)	(dB)	(dB/m)	(dBuV/m)	(dBuV/m)	(dB)	Mode
4960	H	64.44	52.09	41.01	53.36	74	-20.64	PK
4960	H	58.22	52.09	41.01	47.14	54	-6.86	AV
7440	H	55.68	52.34	48.21	51.55	54	-2.45	PK
*9920	H	52.26	52.50	53.06	52.82	54	-1.18	PK
4960	V	62.93	52.09	41.01	51.85	74	-22.15	PK
4960	V	56.56	52.09	41.01	45.48	54	-8.52	AV
7440	V	55.60	52.34	48.21	51.47	54	-2.53	PK
*9920	V	52.21	52.50	53.06	52.77	54	-1.23	PK

Remark : Corrected Level = Reading + Correction Factor – Preamp

Correction Factor = Antenna Factor + Cable Loss

Margin = Correction Factor - Limits

“ \* ” Mark indicated Background Noise Level

The spurious emissions above 10 GHz were not included, because the emissions are too low.

## 4 RF Conducted Spurious Emission

### 4.1 Limit

According to FCC Part 15.247(d) requirement :

In any 100 kHz bandwidth outside the frequency band in which the spread spectrum or digitally modulated intentional radiator is operating, the radio frequency power that is produced by the intentional radiator shall be at least 20 dB below that in the 100 kHz bandwidth within the band that contains the highest level of the desired power, based on either an RF conducted or a radiated measurement, provided the transmitter demonstrates compliance with the peak conducted power limits.

### 4.2 Configuration of Measurement

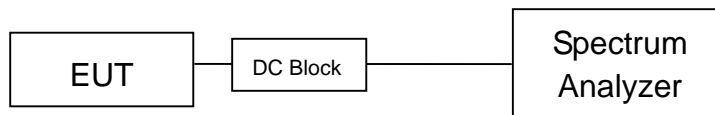

### 4.3 Test Procedure

The EUT was setup to ANSI C63.10, 2013; tested procedure of Jan. 2016 KDB558074 D01 for compliance to FCC 47CFR 15.247 requirements.

The measurements were performed from 9kHz to 25GHz RF antenna conducted per FCC 15.247 (c) was measured from the EUT antenna port using a 50ohm spectrum analyzer with the resolution bandwidth set at 100 kHz, and the video bandwidth set  $\geq$  RBW.

Harmonics and spurious noise must be at least 20dB down from the highest emission level within the authorized band as measured with a 100 kHz RBW. The table below is the results from the highest emission for each channel within the authorized band. This table was used to determine the spurious limit for each channel.

### 4.4 Test Result

**PASS.**

The final test data is shown as following pages.

Remark: The frequency range from 9 kHz to 30 MHz were pre-scanned and the results was 20 dB lower than the limit line which according to FCC 15.31(o) needs not be recorded.



# Conducted Spurious Emission

## 2402 MHz (30 M ~ 1 GHz)



\*RBW 100 kHz Marker 1 [T1 ]  
\*VBW 300 kHz -58.68 dBm  
SWT 100 ms 62.98000000 MHz

Ref 10 dBm

\*Att 20 dB

1 PK  
MAXH

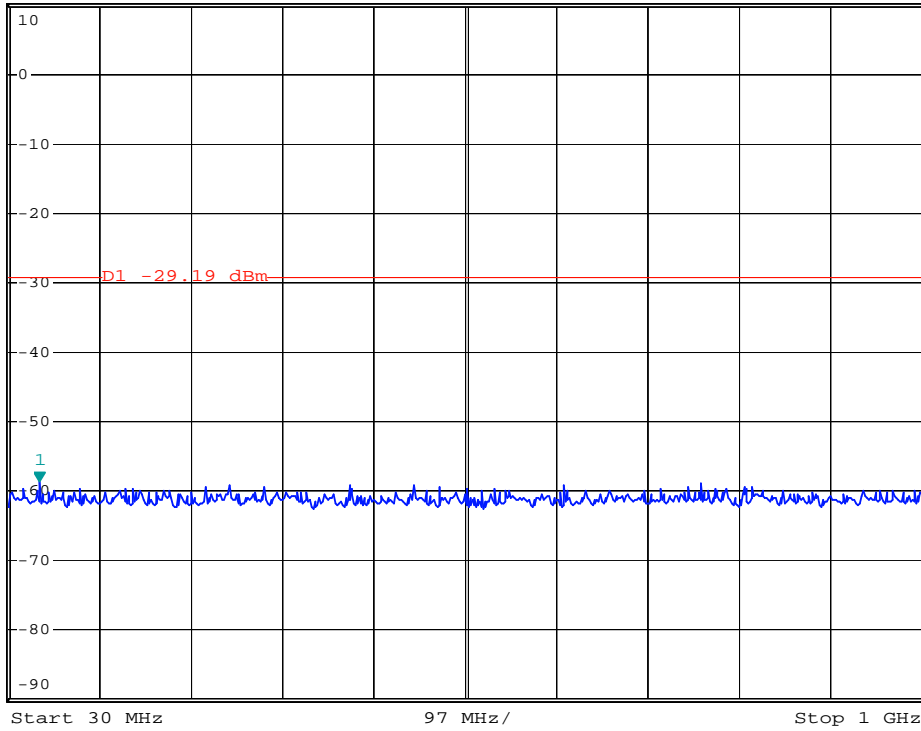

### 2402 MHz (1 G ~ 10 GHz)

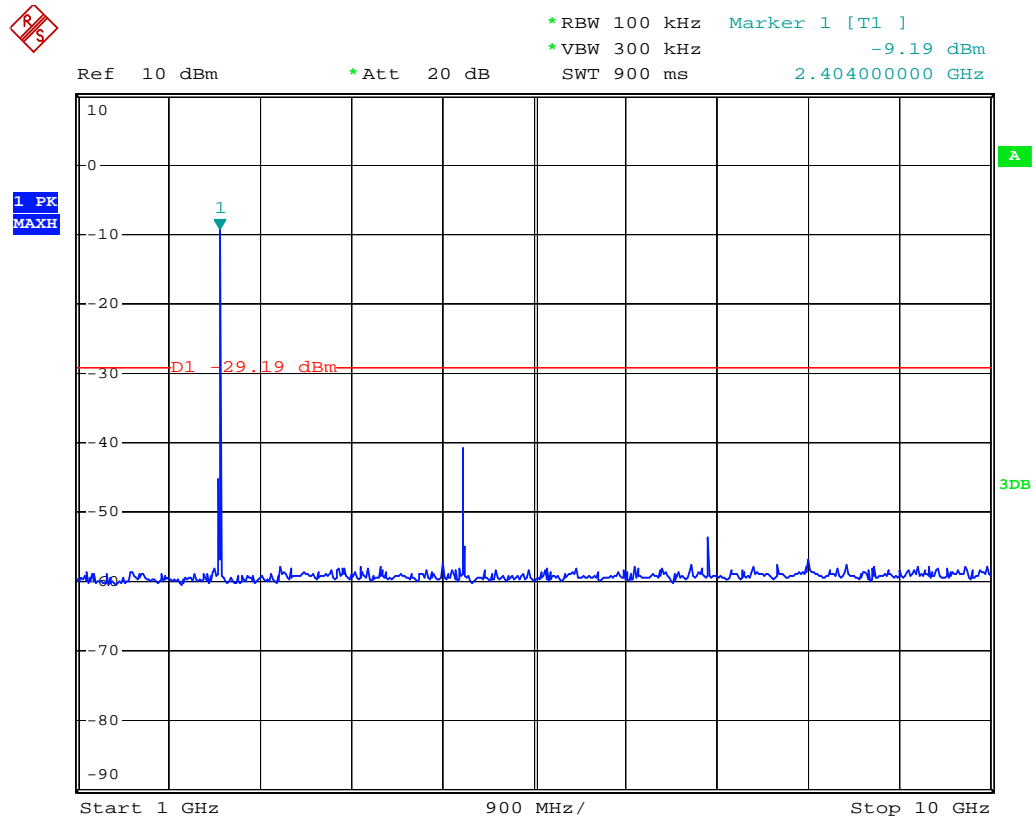

### 2402 MHz (10 G ~ 25 GHz)

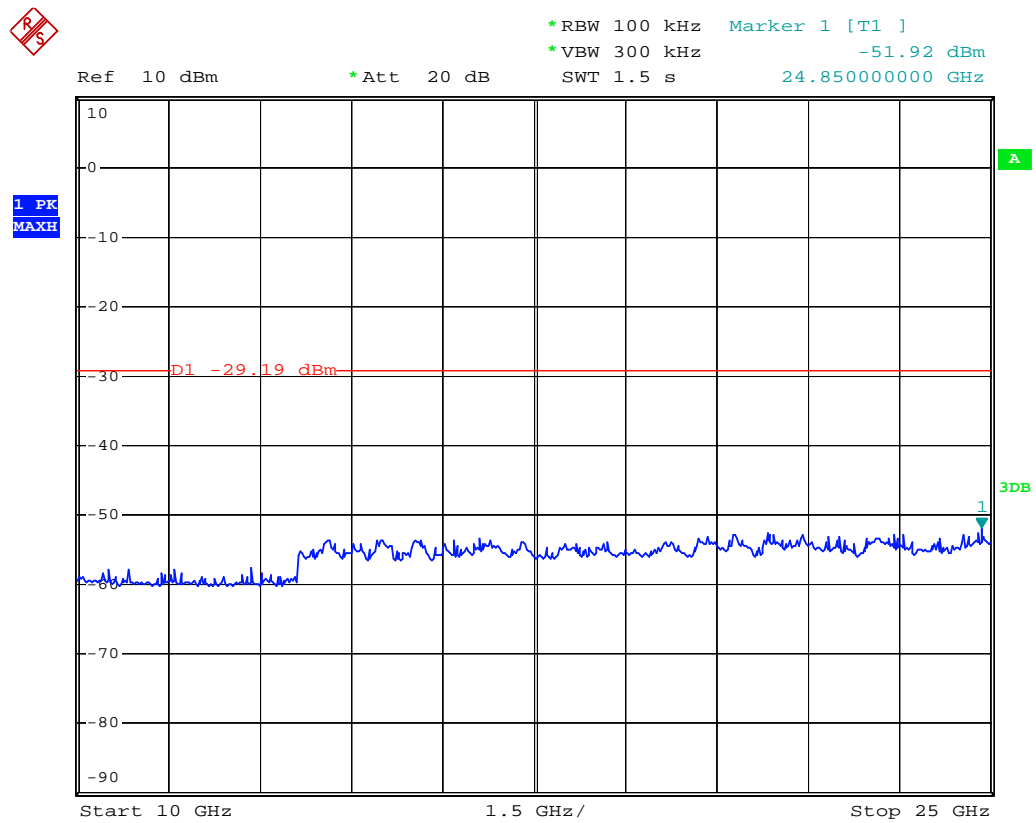

### 2440 MHz (30 M ~ 1 GHz)

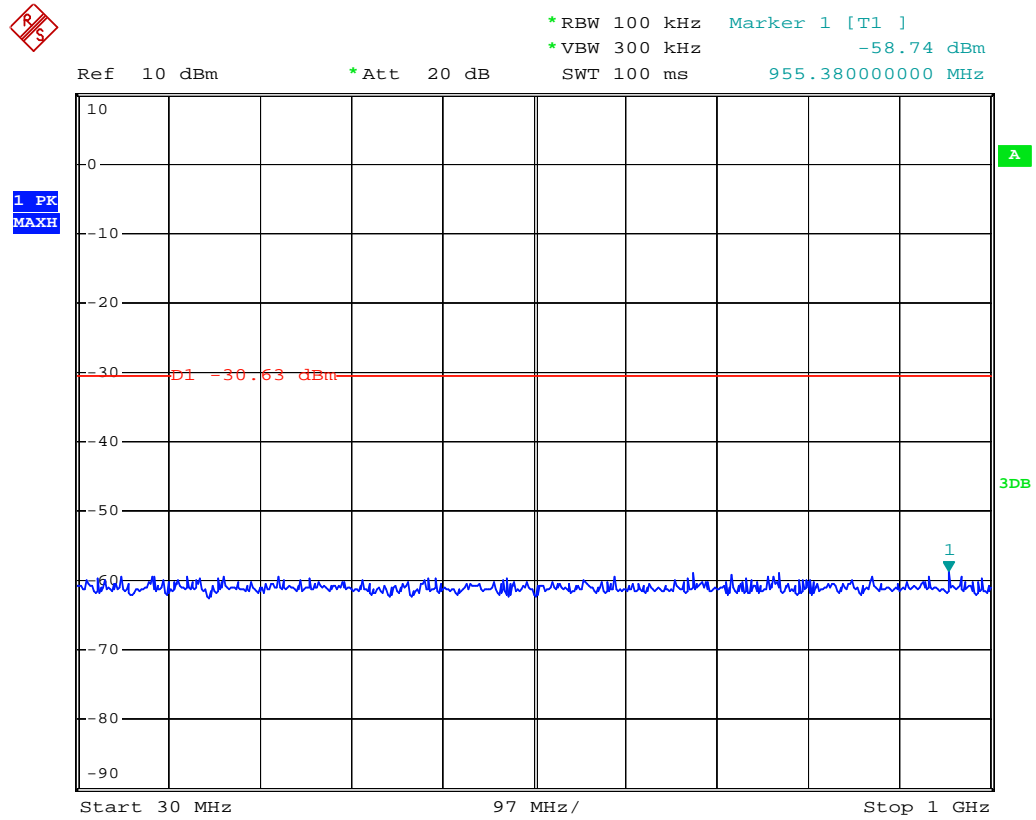

### 2440 MHz (1 G ~ 10 GHz)

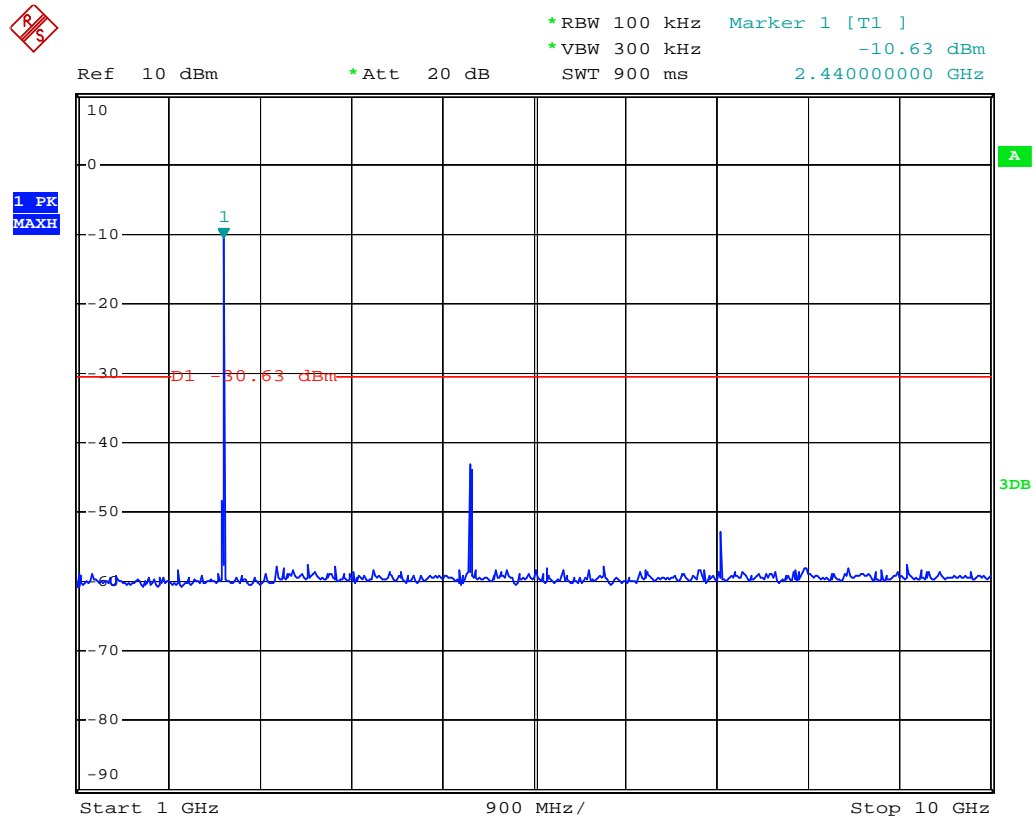

### 2440 MHz (10 G ~ 25 GHz)



\*RBW 100 kHz Marker 1 [T1 ]  
\*VBW 300 kHz -52.16 dBm  
SWT 1.5 s 15.670000000 GHz

Ref 10 dBm

\*Att 20 dB

1 PK  
MAXH

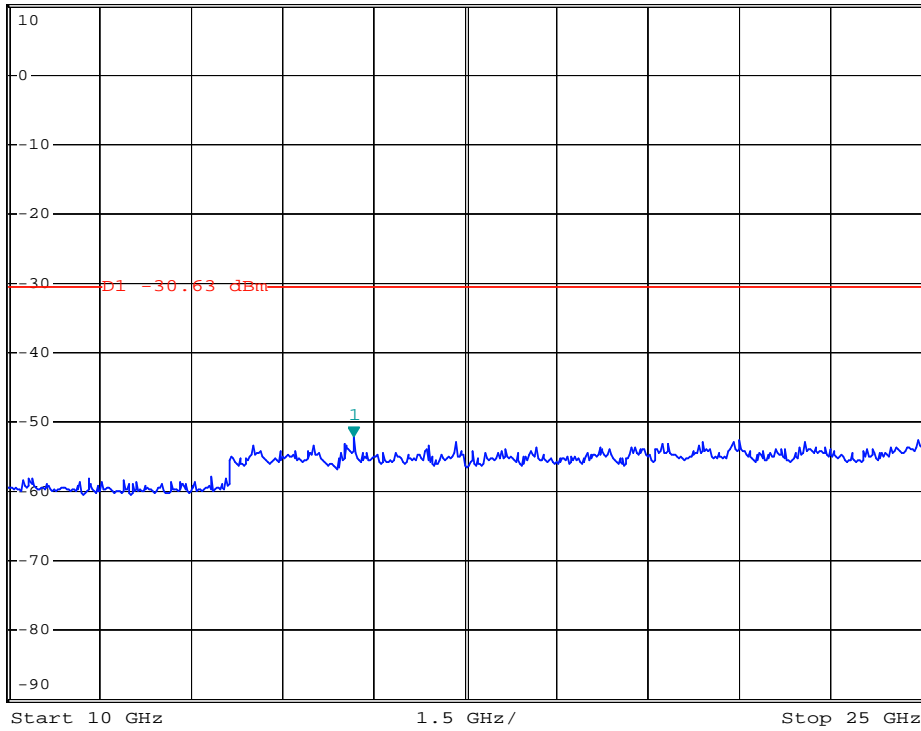

### 2480 MHz (30 M ~ 1 GHz)

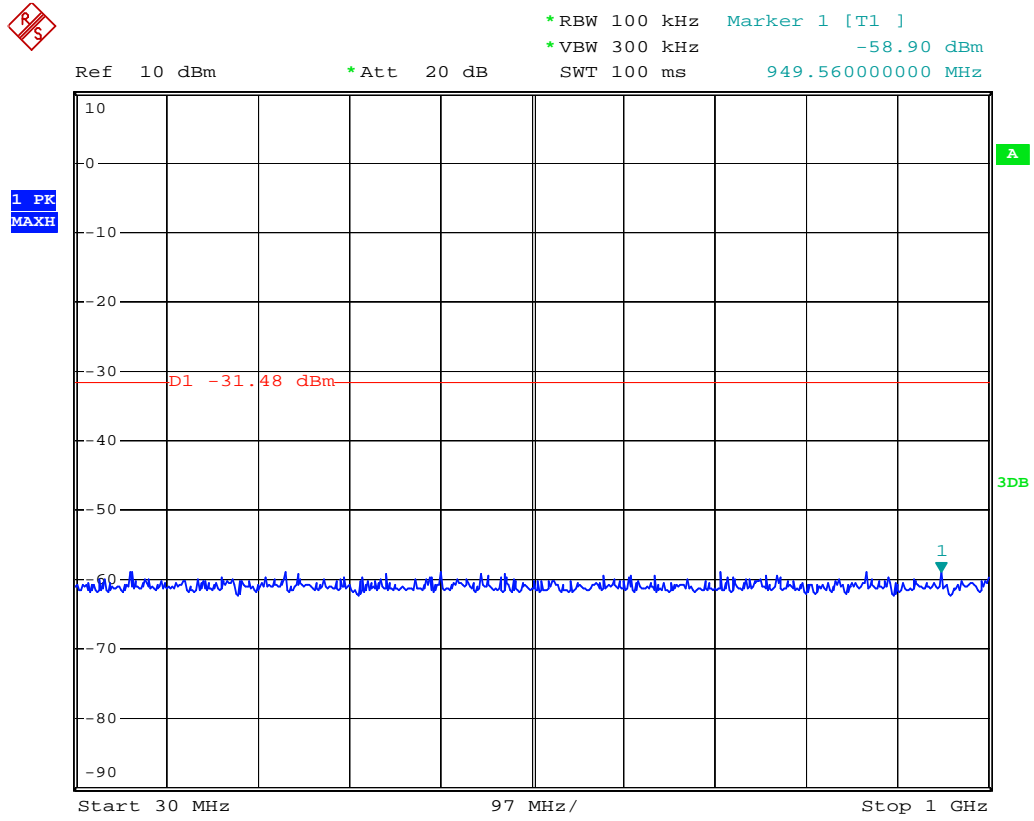

### 2480 MHz (1 G ~ 10 GHz)

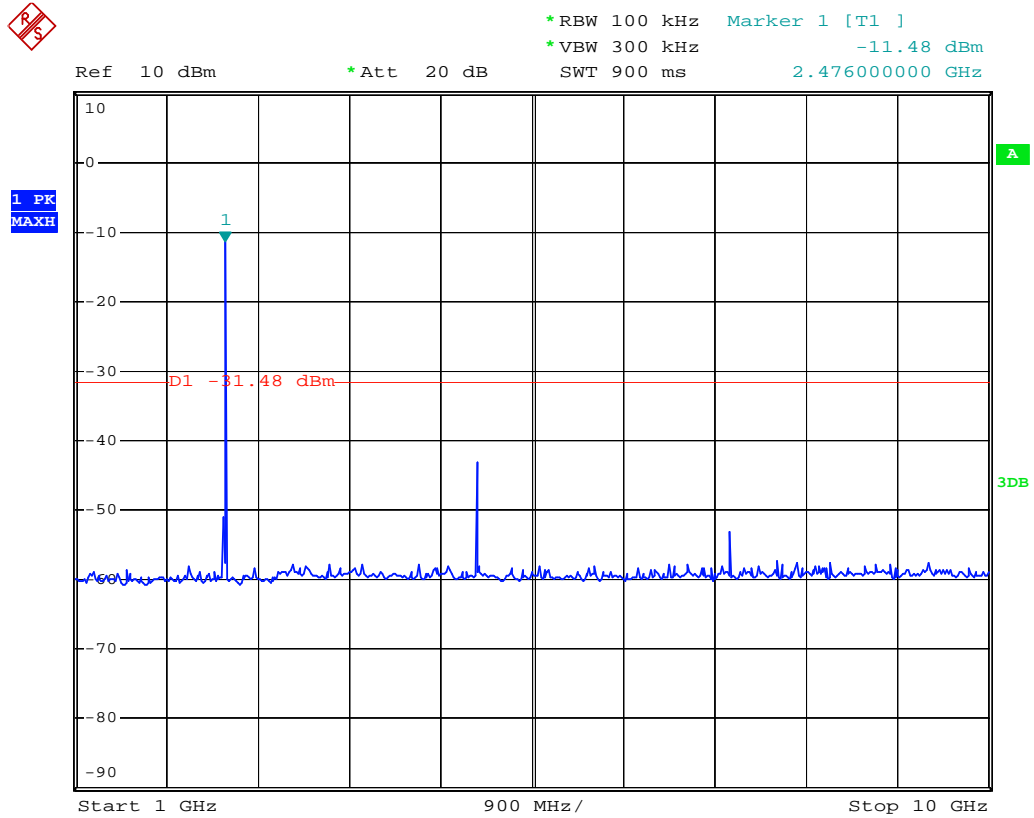

### 2480 MHz (10 G ~ 25 GHz)



\*RBW 100 kHz Marker 1 [T1 ]  
\*VBW 300 kHz -52.74 dBm  
SWT 1.5 s 24.850000000 GHz

Ref 10 dBm

\*Att 20 dB

1 PK  
MAXH

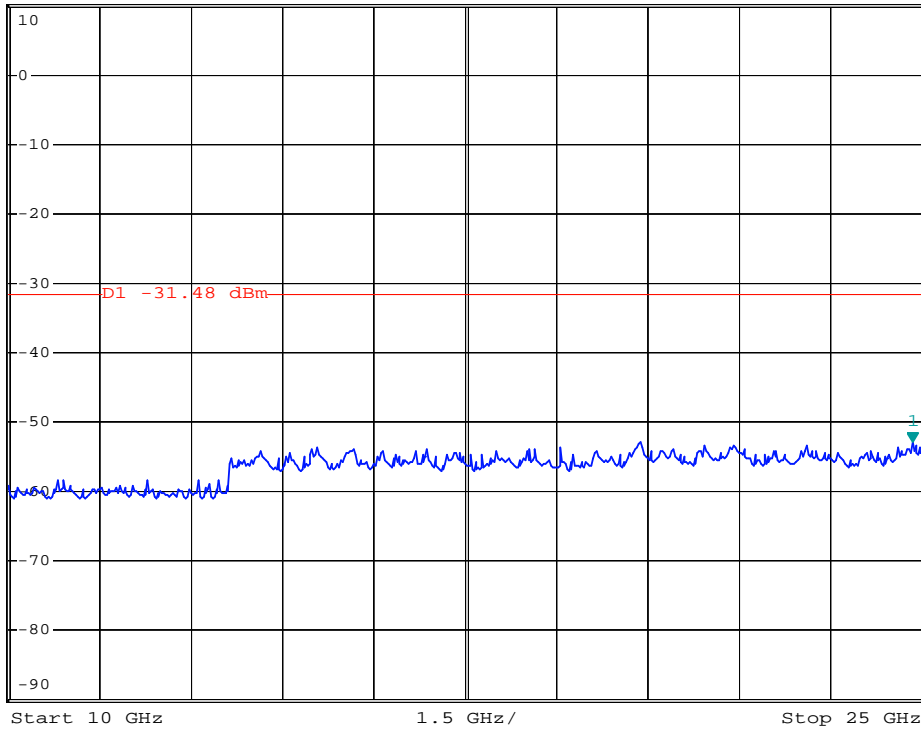

## 5 Maximum Output Power

### 5.1 Limit

For frequency hopping systems operating in the 2400-2483.5MHz band employing at least 75 non-overlapping hopping channels, and all frequency hopping systems in the 5725-5850MHz band: 1 watt.

Frequency hopping systems operating in the 2400-2483.5 MHz band may have hopping channel carrier frequencies that are separated by 25kHz or two-thirds of the 20dB bandwidth of the hopping channel, whichever is greater, provided the systems operate with an output power no greater than 125mW.

For all other frequency hopping systems in the 2400-2483.5MHz band: 0.125 watts.

For systems using digital modulation in the 2400–2483.5 MHz bands: The maximum conducted output power shall be less than 1Watt.

### 5.2 Configuration of Measurement

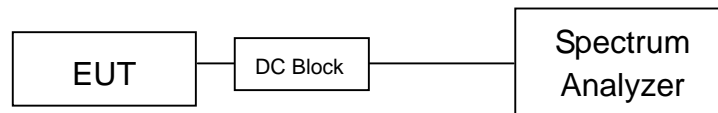

### 5.3 Test Procedure

The EUT was setup to ANSI C63.10, 2013; tested procedure of Jan. 2016 KDB558074 D01 for compliance to FCC 47CFR 15.247 requirements.

For FCC §15.247(b) the power output was measured on the EUT using a 50 ohm SMA cable connected to Spectrum Analyzer. Peak output power was read directly from Spectrum Analyzer.

Set :

1.  $RBW \geq DTS \text{ bandwidth}$ ,  $VBW \geq 3 \times RBW$
2.  $Span \geq 3 \times RBW$
3. Detector = peak, trace mode = max hold
4. All trace to fully stabilize
5. Use peak marker function to determine the peak amplitude

### 5.4 Test Result

**PASS.**

The final test data is shown as following table.

## Maximum Peak Power

CH	Test Voltage (Vdc)	Maximum Peak Power		Limit (dBm)	Margin (dB)
		dBm	Watts		
0	2402	-8.30	0.00015	30	-38.30
19	2440	-9.44	0.00011	30	-39.44
39	2480	-10.39	0.00009	30	-40.39

### 2402 MHz Maximum Peak Power

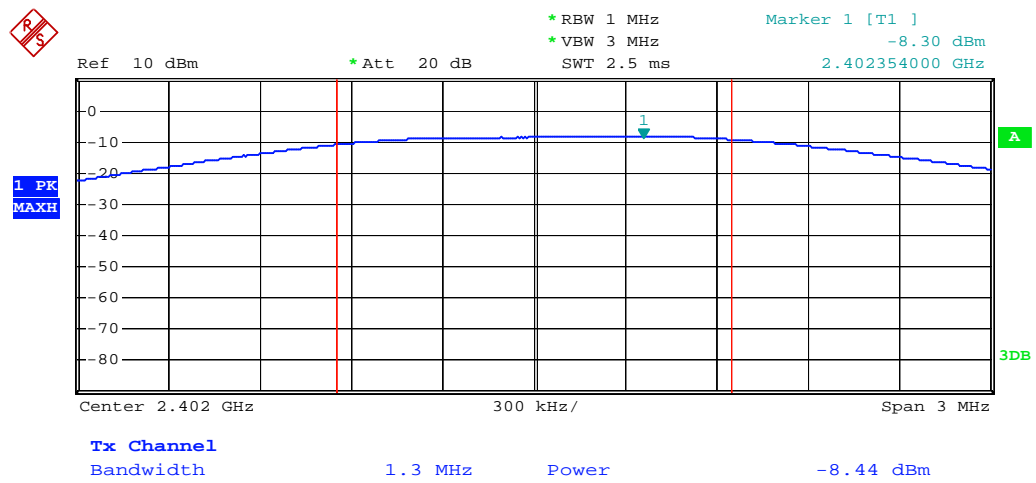

### 2440 MHz Maximum Peak Power

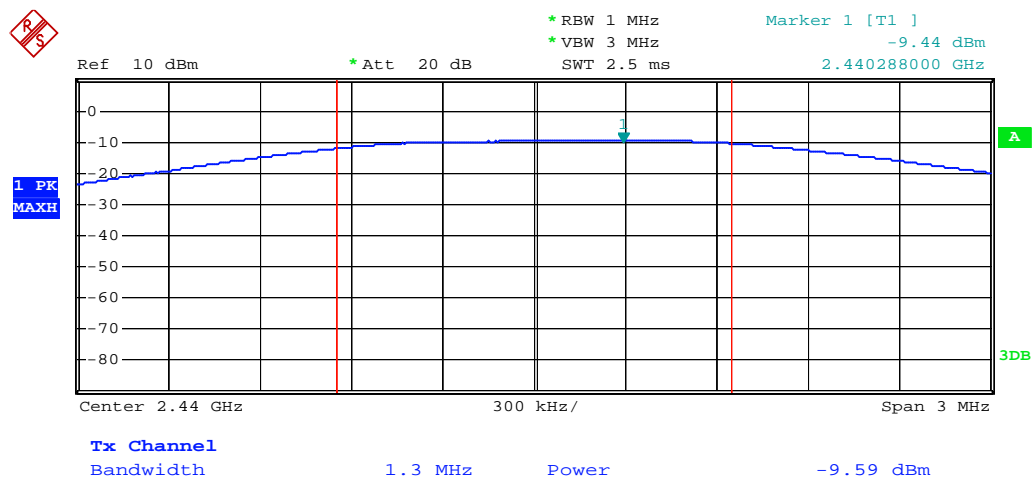



### 2480 MHz Maximum Peak Power

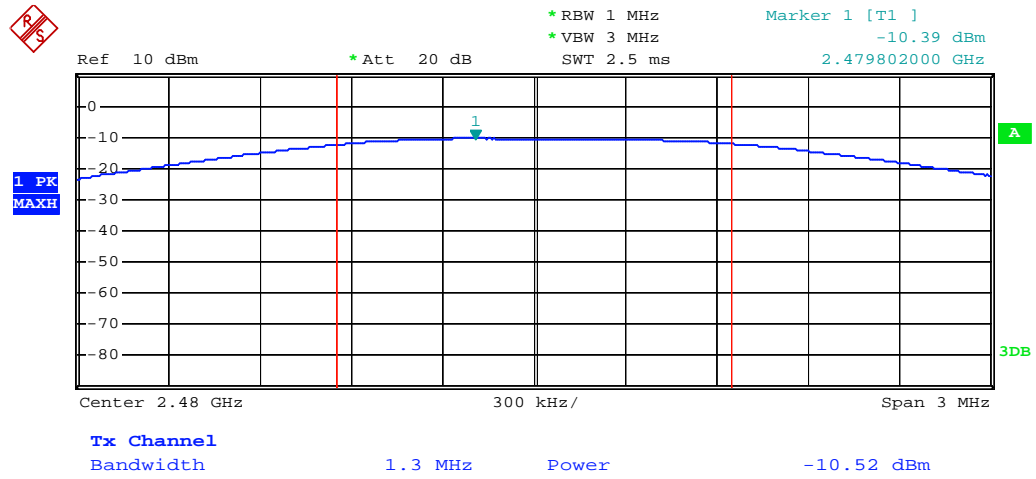

## 6 6dB Bandwidth

### 6.1 Limit

According to FCC Part15.247 (a)(2) requirement :

Systems using digital modulation techniques may operate in the 2400–2483.5 MHz, The minimum 6dB bandwidth shall be at least 500 kHz.

### 6.2 Configuration of Measurement

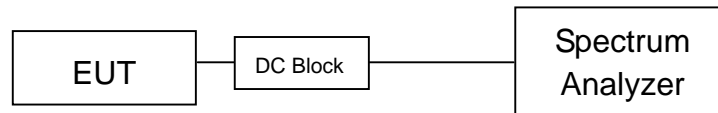

### 6.3 Test Procedure

The EUT was setup to ANSI C63.10, 2013; tested procedure of Jan. 2016 KDB558074 D01 for compliance to FCC 47 CFR 15.247 requirements.

The minimum 6dB bandwidth was measured using a 50 ohm spectrum analyzer.

- 1) RBW = 100kHz
- 2) VBW  $\geq$  3 x RBW
- 3) Detector = Peak
- 4) Trace mode = Max hold
- 5) Sweep = auto couple
- 6) All trace to fully stabilize
- 7) Measure the maximum width of the emission that is constrained by the frequencies associated with the two outermost amplitude points (upper and lower frequencies) that are attenuated by 6dB relative to the maximum level measured in the fundamental emission.

### 6.4 Test Result

**PASS.**

The final test data is shown on as following pages.

### 6dB Bandwidth

Test CH		6dB Bandwidth (kHz)	Limit (kHz)	Result
CH No.	Freq. (MHz)			
0	2402	702.00	>500	PASS
19	2440	696.00	>500	PASS
39	2480	684.00	>500	PASS

### 2402 MHz 6dB Bandwidth

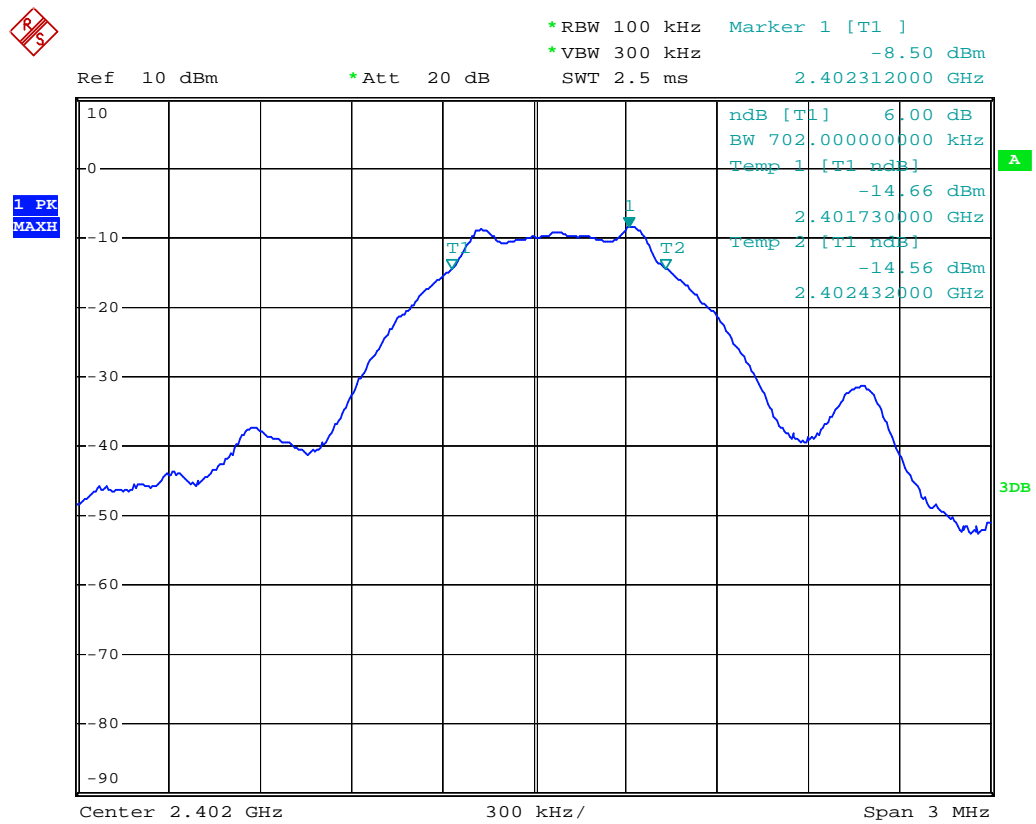

### 2440 MHz 6dB Bandwidth

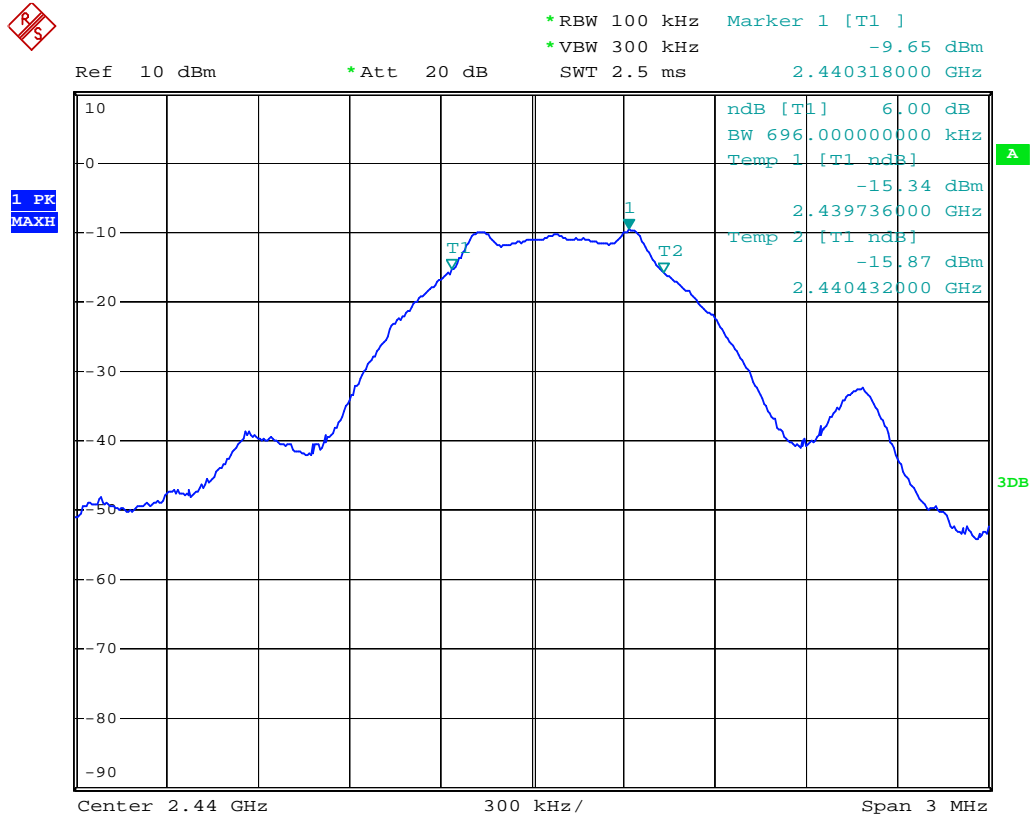

### 2480 MHz 6dB Bandwidth

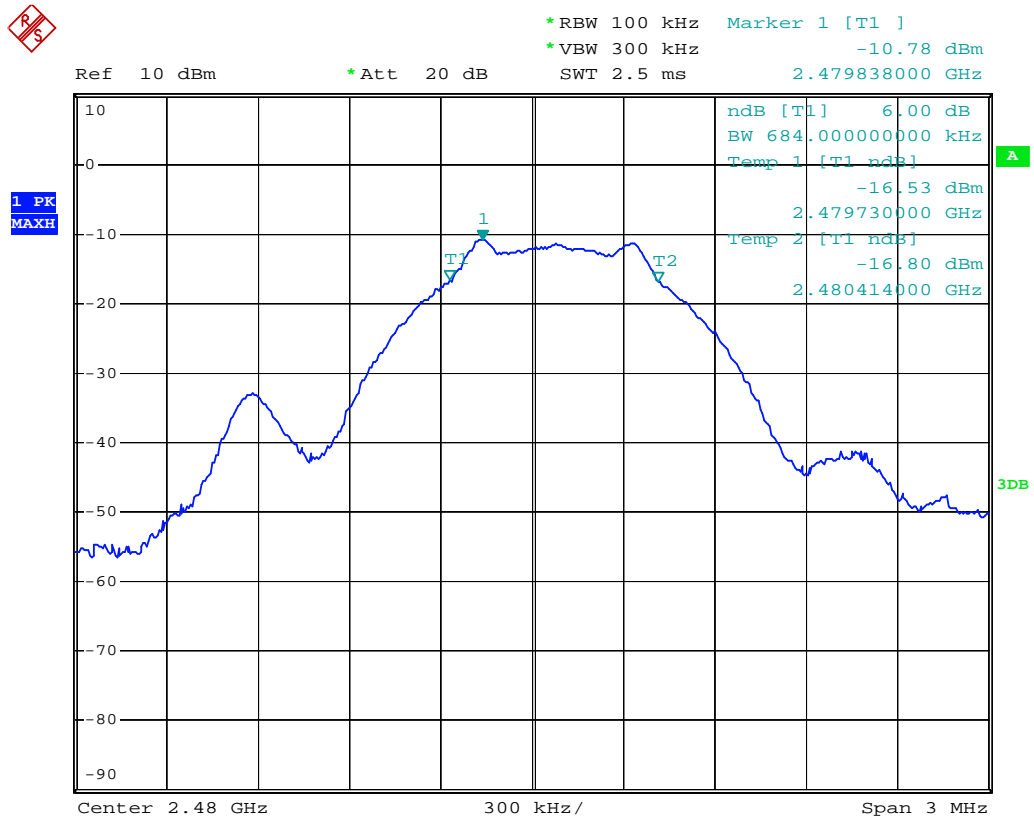

## 7 Power Spectral Density

### 7.1 Limit

According to FCC Part15.247 (e) requirement :

For digitally modulated systems, the power spectral density conducted from the intentional radiator to the antenna shall not be greater than 8 dBm in any 3 kHz band during any time interval of continuous transmission.

### 7.2 Configuration of Measurement

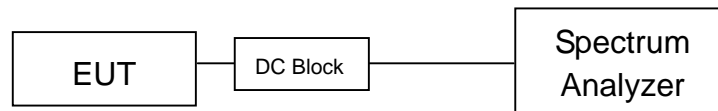

### 7.3 Test Procedure

The EUT was setup to ANSI C63.10, 2013; tested procedure of Jan. 2016 KDB558074 D01 for compliance to FCC 47CFR 15.247 requirements.

Set::

- 1) Analyzer center frequency to DTS channel center frequency
- 2) The span  $\geq 1.5$  times the DTS bandwidth
- 3) RBW:  $3\text{kHz} \leq \text{RBW} \leq 100\text{kHz}$
- 4) VBW  $\geq 3 \times \text{RBW}$
- 5) Detector = Peak
- 6) Trace mode = Max hold
- 7) Sweep = auto couple
- 8) All trace to fully stabilize
- 9) Use the peak marker function to determine the maximum amplitude level within the RBW
- 10) If measured value exceeds limit, reduce RBW (no less than 3kHz) and repeat.

### 7.4 Test Result

**PASS.**

The final test data is shown on as following pages.

## Power Spectral Density

Test CH		PSD (dBm/100kHz)	PSD (dBm/3kHz)	Limit (dBm/3kHz)	Result
CH No.	Freq. (MHz)				
0	2402	-8.56	-23.76	8	PASS
19	2440	-9.67	-24.87	8	PASS
39	2480	-10.76	-25.96	8	PASS

Note: PDCF =  $10 \cdot \log(3k/100k) = -15.2$

### 2402 MHz Power Spectral Density

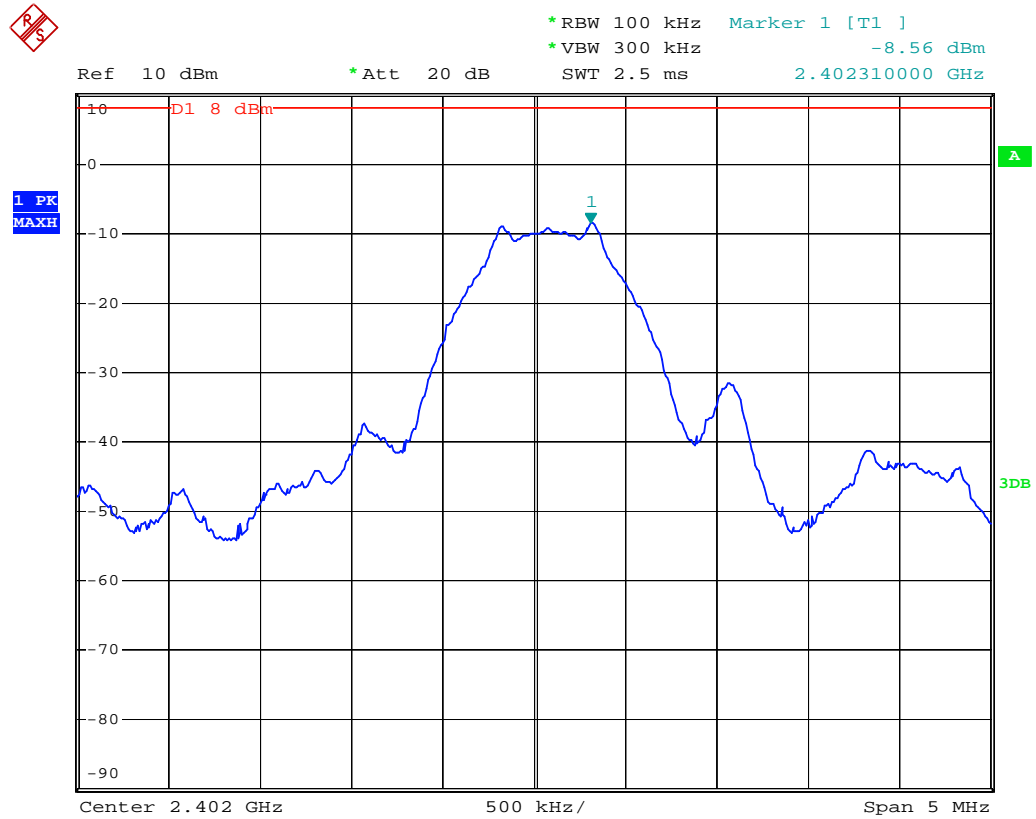

### 2440 MHz Power Spectral Density

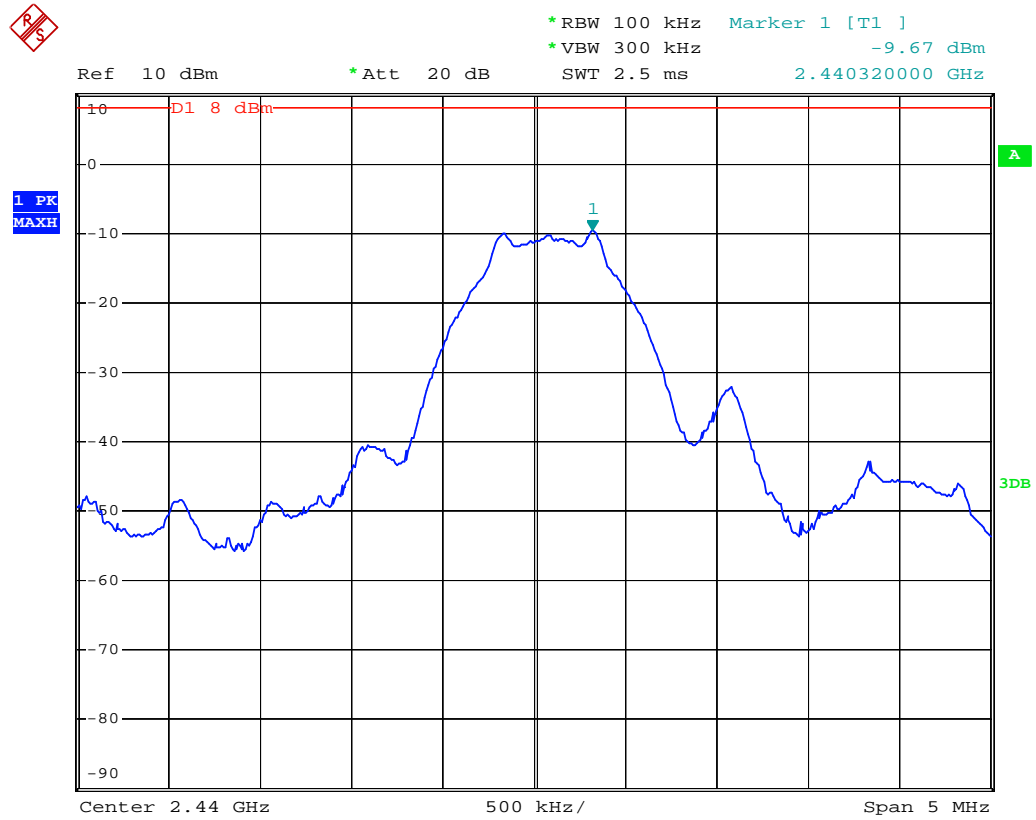

### 2480 MHz Power Spectral Density

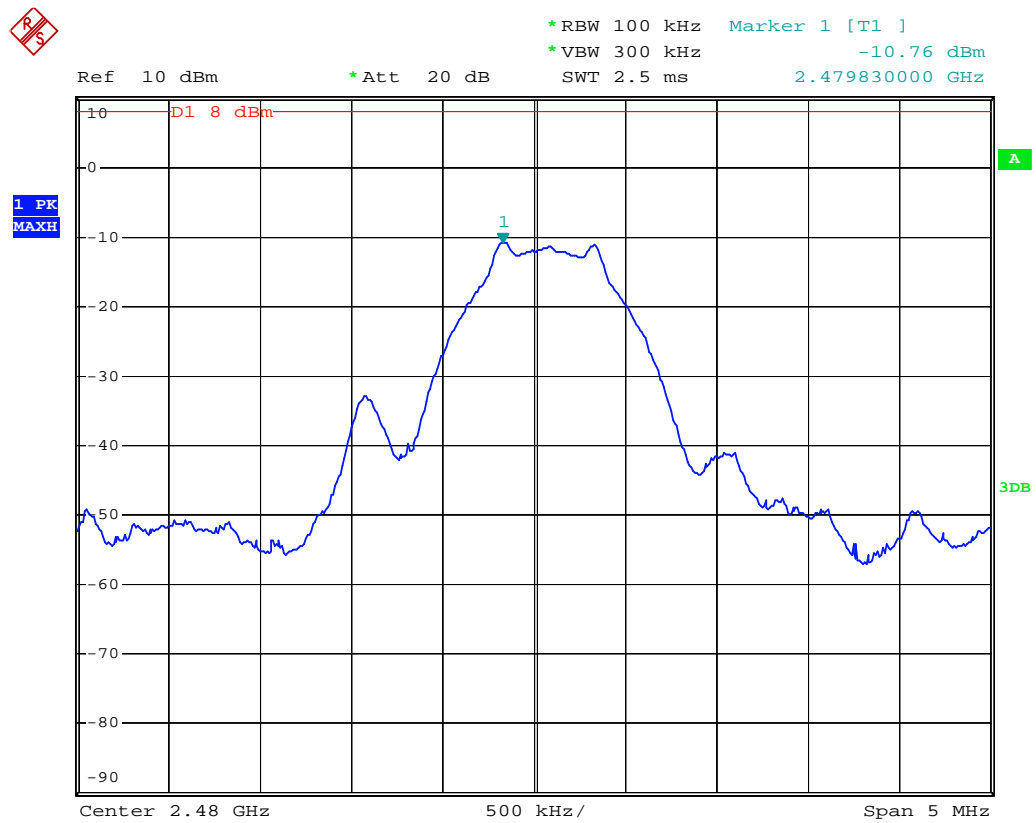

## 8 Band Edge

### 8.1 Limit

In any 100 kHz bandwidth outside the frequency band in which the spread spectrum intentional radiator is operating, the radio frequency power that is produced by the intentional radiator shall be at least 20 dB below that in the 100 KHz bandwidth within the band that contains the highest level of the desired power, based on either an RF conducted or a radiated measurement.

### 8.2 Configuration of Measurement Radiated

Measurement Frequency above 1 GHz

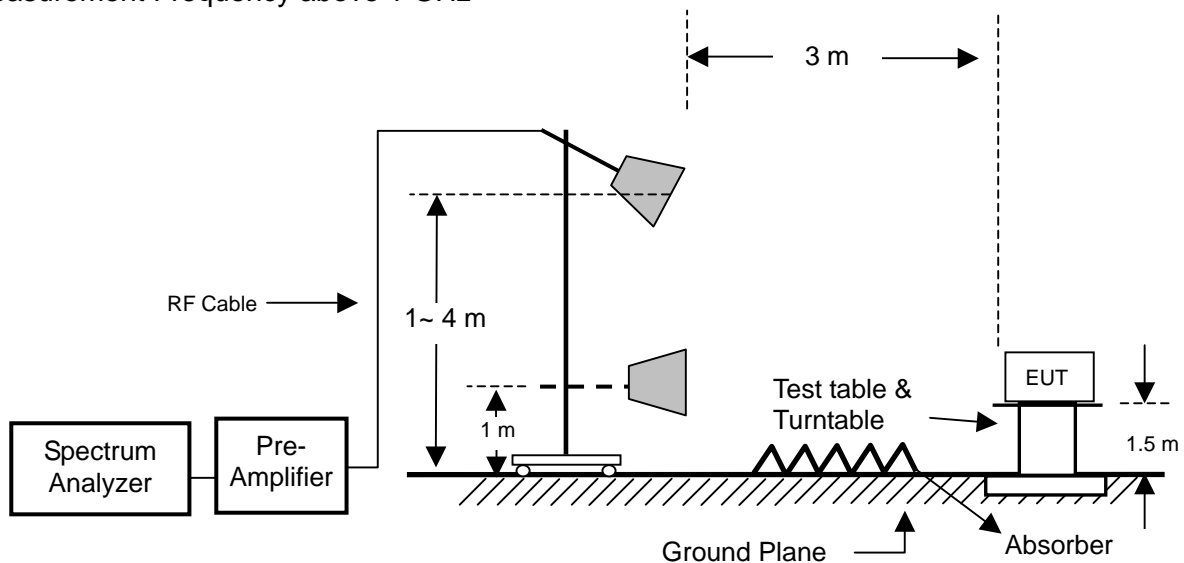

### Conducted

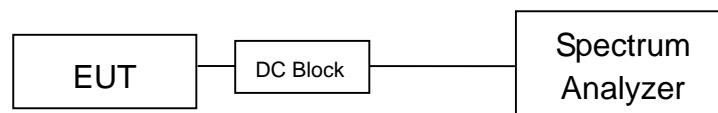

### 8.3 Test Procedure

#### Radiated

The EUT was setup to ANSI C63.10, 2013; tested procedure of Jan. 2016 KDB558074 D01 for compliance to FCC 47 CFR 15.247 requirements.

Set RBW =1MHz, VBW= RBW for peak, and RBW =1MHz, VBW=10Hz for average.

The EUT for testing is arranged on a non-conductive turntable. If some peripherals apply to the EUT, the peripherals will be connected to EUT and the whole system. During the test, all cables were arranged to produce worst-case emissions. The signal is maximized through rotation. The height of antenna and polarization is changing constantly for exploring for maximum signal level. The height of antenna can be up to 4 meter and down to 1 meter.



### **Conducted**

The EUT was setup to ANSI C63.10, 2013; tested procedure of Jan. 2016 KDB558074 D01 for compliance to FCC 47 CFR 15.247 requirements.

Set:

- 1) RBW = 100kHz.
- 2) VBW = 300kHz.
- 3) Detector: Peak.
- 4) Trace: Max hold.
- 5) All the trace to stabilize.
- 6) Use peak marker function to determine the peak amplitude.

### **8.4 Test Result**

**PASS.**

The final test data is shown as following pages.

### Band Edge (Worse: Horizontal)\_Radiated

CH	Restrict Freq. Band (MHz)	Detector Mode	Maximum Level (dBuV/m)	Limit (dBuV/m)	Magin (dB)
0 (2402MHz)	2310~2390	PK	49.83	74	-24.17
		AV	38.13	54	-15.87
39 (2480MHz)	2483.5~2500	PK	53.83	74	-20.17
		AV	47.59	54	-6.41

### Band Edge\_Conducted

CH	Frequency (MHz)	Detector Mode	Measure Result (dBm)	Limit (dBm)	Magin (dB)
0	Marker 1: 2401.956	PK	-8.78	N/A	N/A
	Marker 2: 2399.434		-44.24	-28.78	-15.46
39	Marker 1: 2479.948	PK	-10.80	N/A	N/A
	Marker 2: 2483.632		-50.61	-30.80	-19.81

### Radiated\_2402 MHz PK

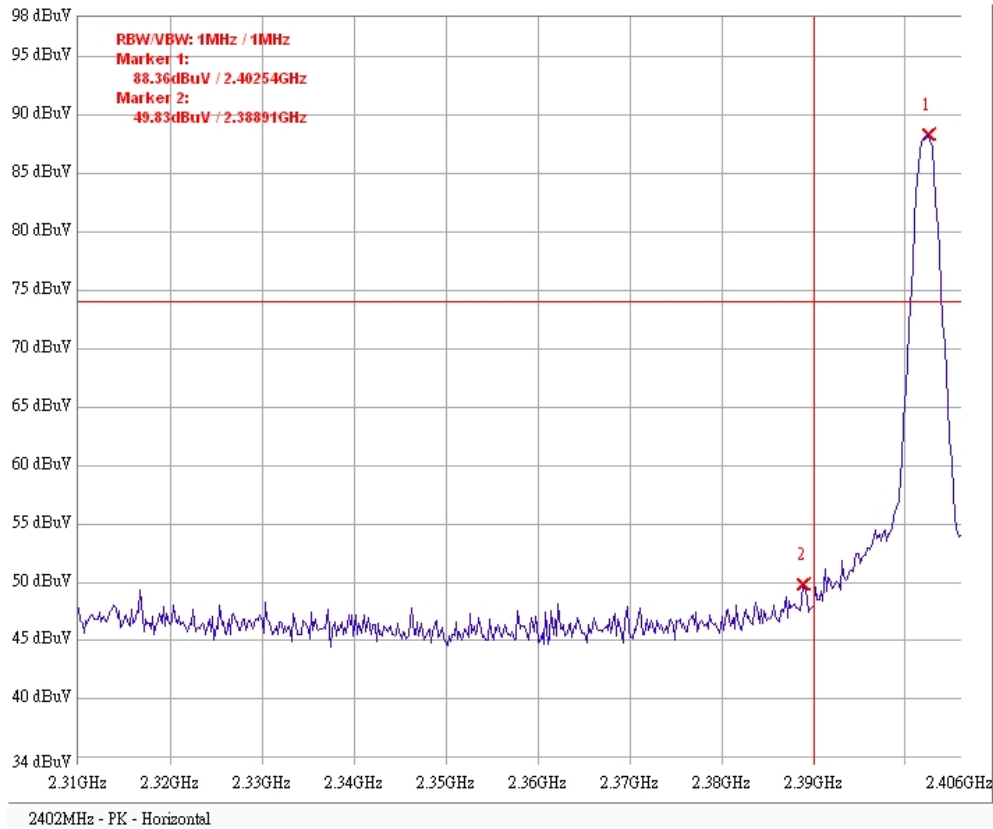

### Radiated\_2402 MHz AV

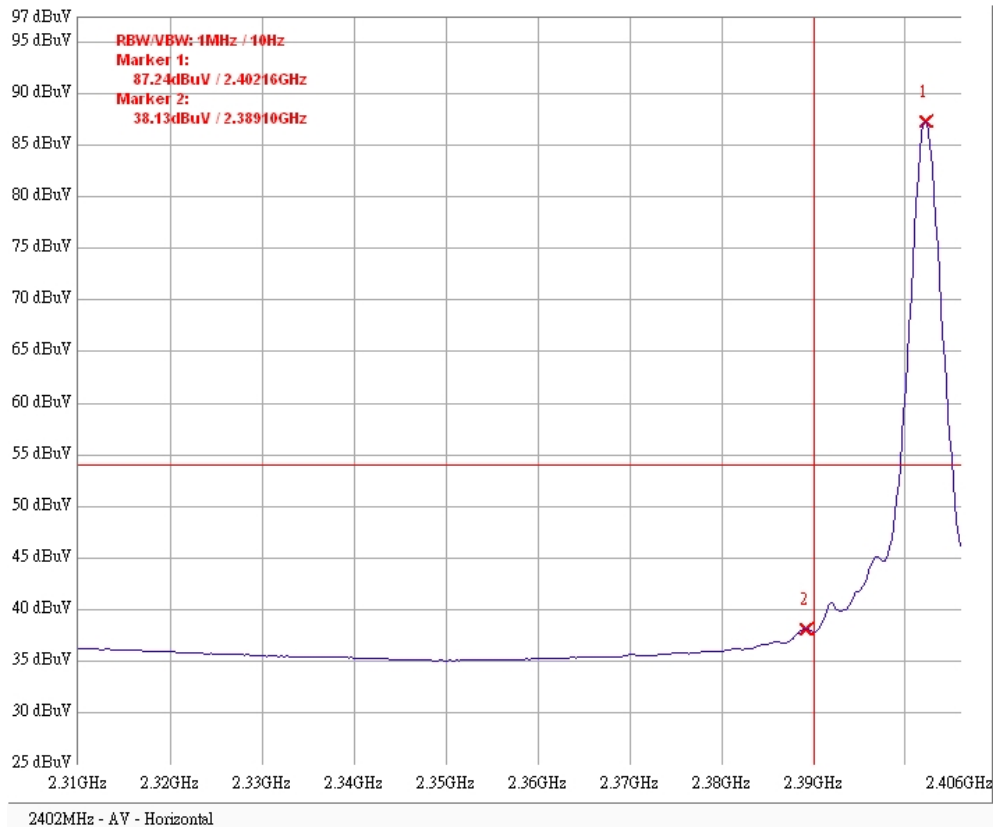

### Radiated\_2480 MHz PK

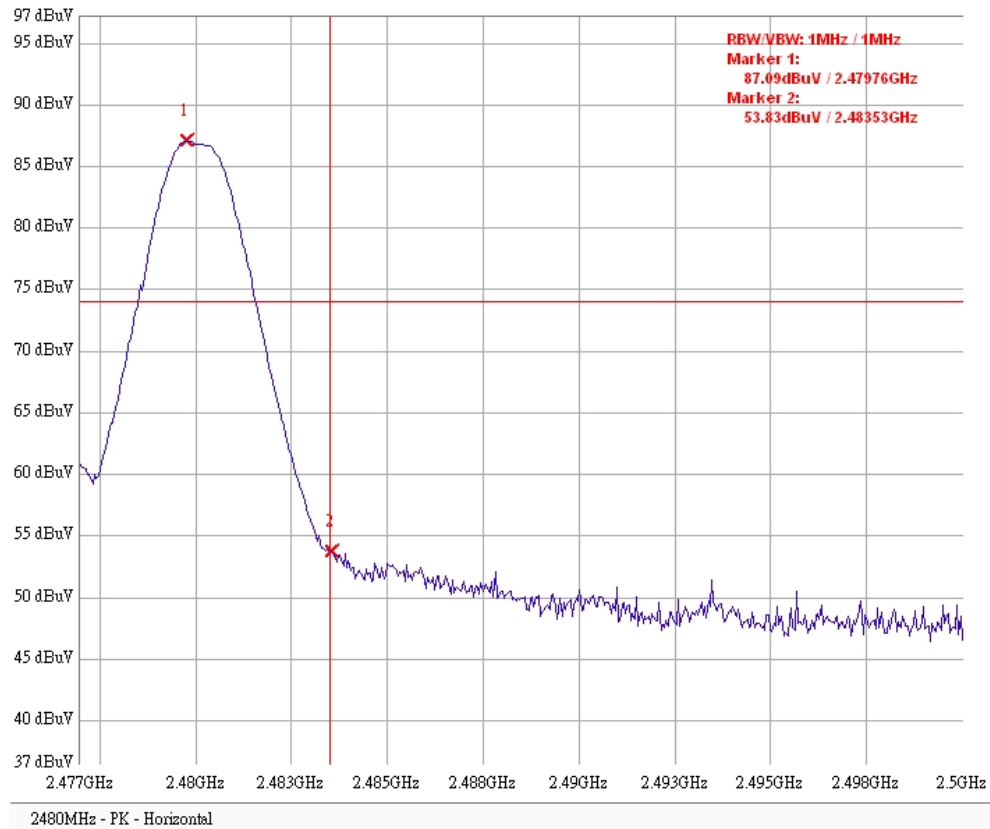

### Radiated\_2480 MHz AV

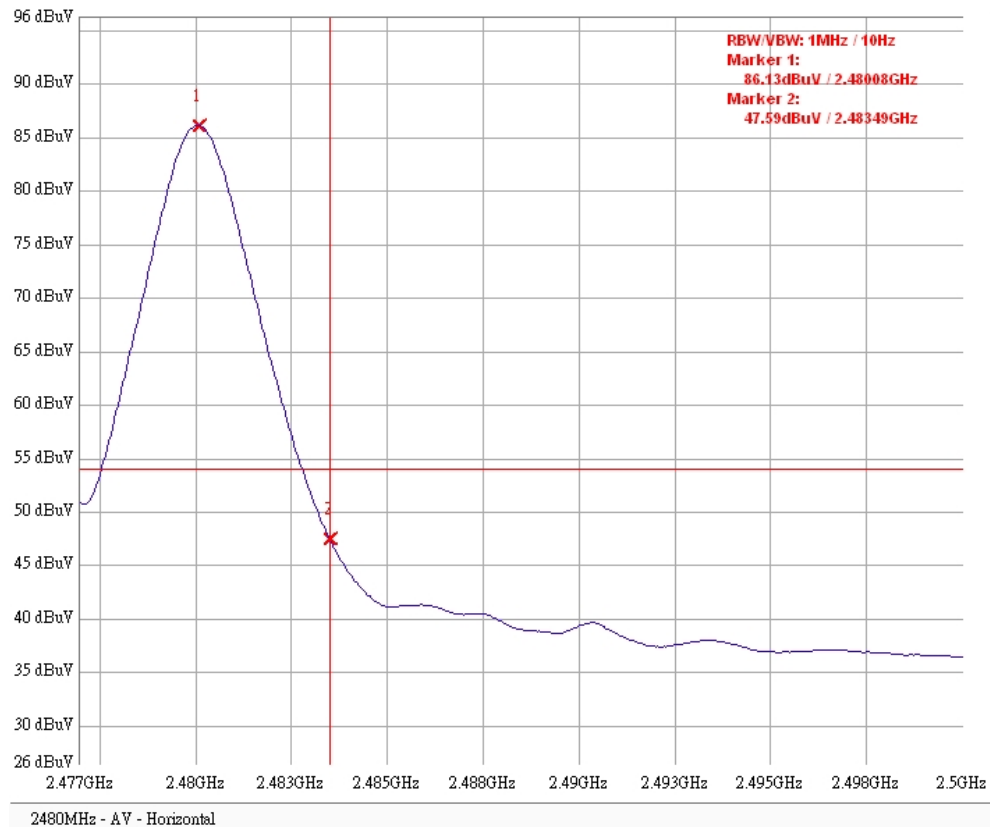

### Conducted\_2402 MHz PK

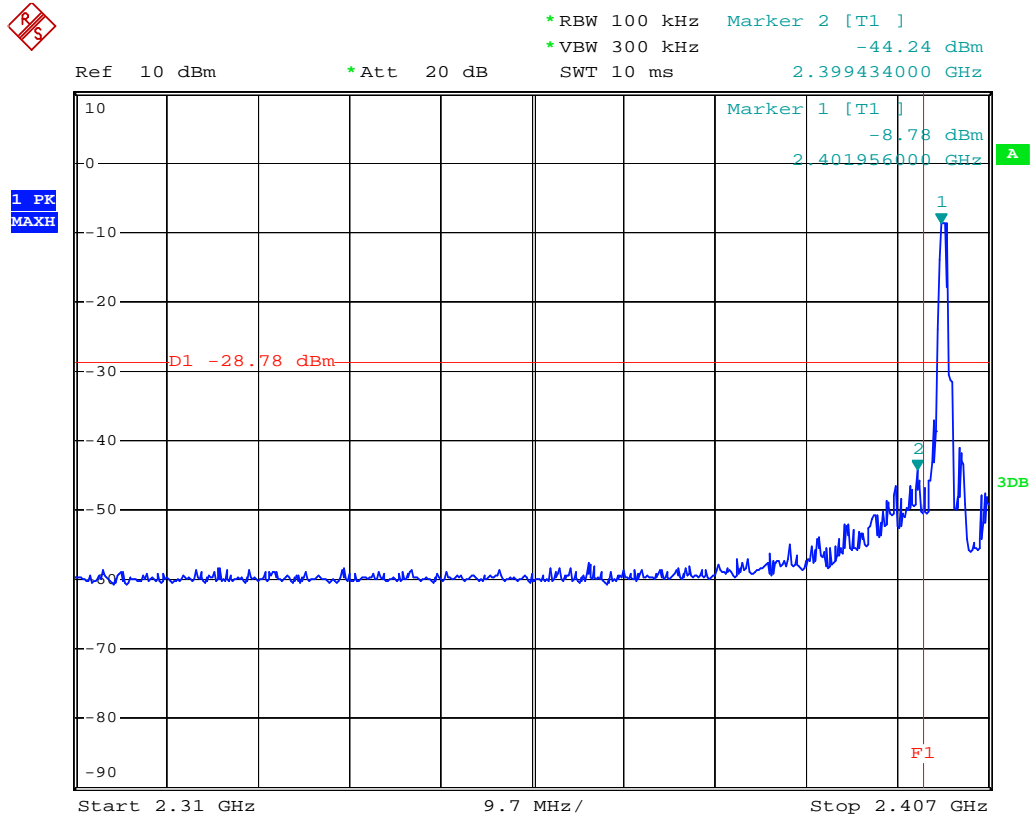

### Conducted\_2480 MHz PK

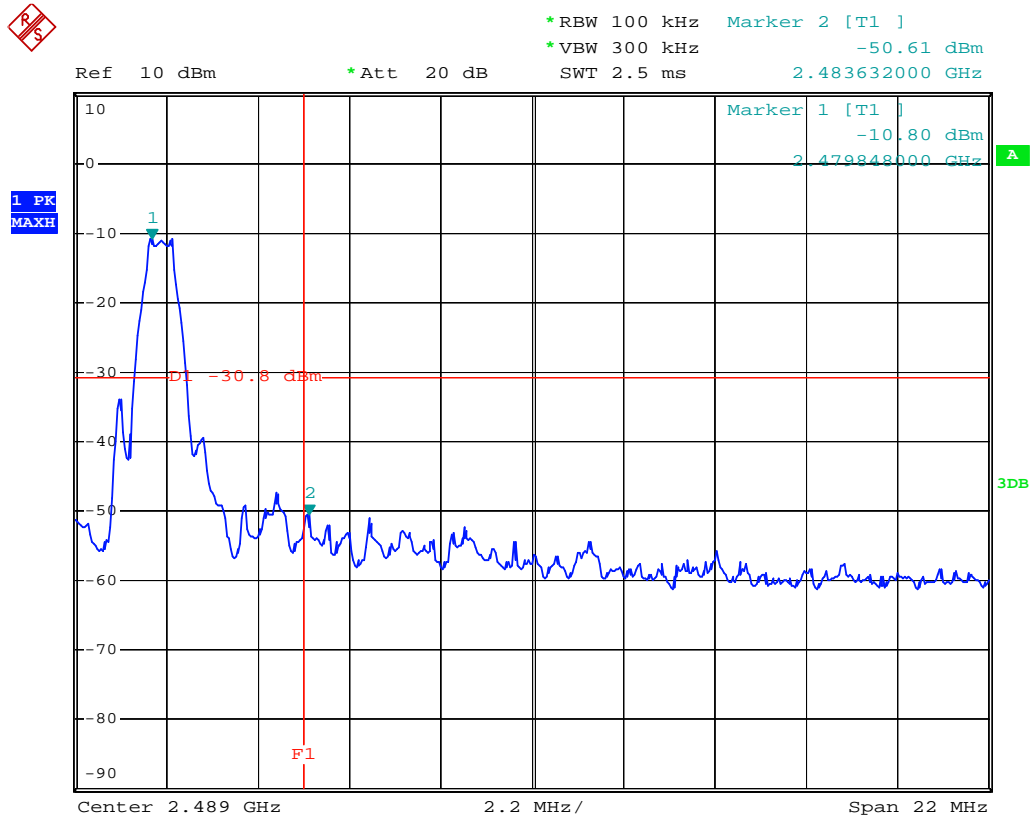

## 9 AC Power Line Conducted Emission

N/A