

COMMUNICATION CERTIFICATION LABORATORY

1940 West Alexander Street
Salt Lake City, UT 84119
801-972-6146

Test Report



Date of Test: July 27 – 29, 2009

Issue Date: August 13, 2009

Accredited Testing Laboratory By:



NVLAP Lab Code 100272-0

CERTIFICATION OF ENGINEERING REPORT

This report has been prepared by Communication Certification Laboratory to document compliance of the device described below with the requirements of Federal Communications Commission (FCC) Part 15, Subpart C, Sections 15.203, 15.207, and 15.247. This report may be reproduced in full, partial reproduction may only be made with the written consent of the laboratory. The results in this report apply only to the sample tested.

- Applicant: Mesa Laboratories, Inc.
- Manufacturer: Mesa Laboratories, Inc.
- Brand Name: Mesa Laboratories
- Model Number: DTENV-H and DTENV-R
- FCC ID Number: UUYDT002

On this 13th day of August 2009, I, individually, and for Communication Certification Laboratory, certify that the statements made in this engineering report are true, complete, and correct to the best of my knowledge, and are made in good faith.

Although NVLAP has recognized that the Communication Certification Laboratory EMC testing facilities are in good standing, this report must not be used to claim product certification, approval, or endorsement by NVLAP, NIST, or any agency of the federal government.

COMMUNICATION CERTIFICATION LABORATORY



Tested by: Norman P. Hansen
EMC Technician

TABLE OF CONTENTS

	<u>PAGE</u>
<u>SECTION 1.0 CLIENT INFORMATION</u>	4
<u>SECTION 2.0 EQUIPMENT UNDER TEST (EUT)</u>	5
<u>SECTION 3.0 TEST SPECIFICATION, METHODS & PROCEDURES</u>	9
<u>SECTION 4.0 OPERATION OF EUT DURING TESTING</u>	16
<u>SECTION 5.0 SUMMARY OF TEST RESULTS</u>	17
<u>SECTION 6.0 MEASUREMENTS, EXAMINATIONS AND DERIVED RESULTS</u>	18
<u>APPENDIX 1 TEST PROCEDURES AND TEST EQUIPMENT</u>	33
<u>APPENDIX 2 PHOTOGRAPHS</u>	41

SECTION 1.0 CLIENT INFORMATION

1.1 Applicant:

Company Name: Mesa Laboratories, Inc.
12100 W. Sixth Avenue
Lakewood, CO 80228

Contact Name: Preston Graves
Title: Director of R & D

1.2 Manufacturer:

Company Name: Mesa Laboratories, Inc.
12100 W. Sixth Avenue
Lakewood, CO 80228

Contact Name: Preston Graves
Title: Director of R & D

SECTION 2.0 EQUIPMENT UNDER TEST (EUT)**2.1 Identification of EUT:**

Brand Name: Mesa Laboratories
 Model Number: DTENV-H and DTENV-R
 Serial Number: None

2.2 Description of EUT:

The DTENV-H is a device to interface a 2.4 GHz Zigbee network and is used to program MPRF-L or transfer data from the data logging system. The DTENV-R is a repeater used in the Zigbee network to extend the network capabilities. The DTENV-H is powered by a USB port of the host system. The DTENV-R is powered by either a CUI Inc. DPD45030-P7DK, 4.5 VDC at 300 mA, power supply or a Globtek GT-4176-0605, 5 VDC at 1.2 A, power supply and has a 3.6 VDC lithium battery for backup power.

Both devices use the same Zigbee transceiver PCB. The DTENV-H uses a 9 dBi, 7 dBi, or 3 dBi monopole antenna with reverse SMA connector. The 9 dBi antenna was used for testing. The DTENV-R uses a whip antenna soldered to the transceiver PCB. Both units were tested.

The Zigbee transceiver uses 15 channels in the 2400 to 2483.5 MHz band. The individual channels are shown in the following plots.

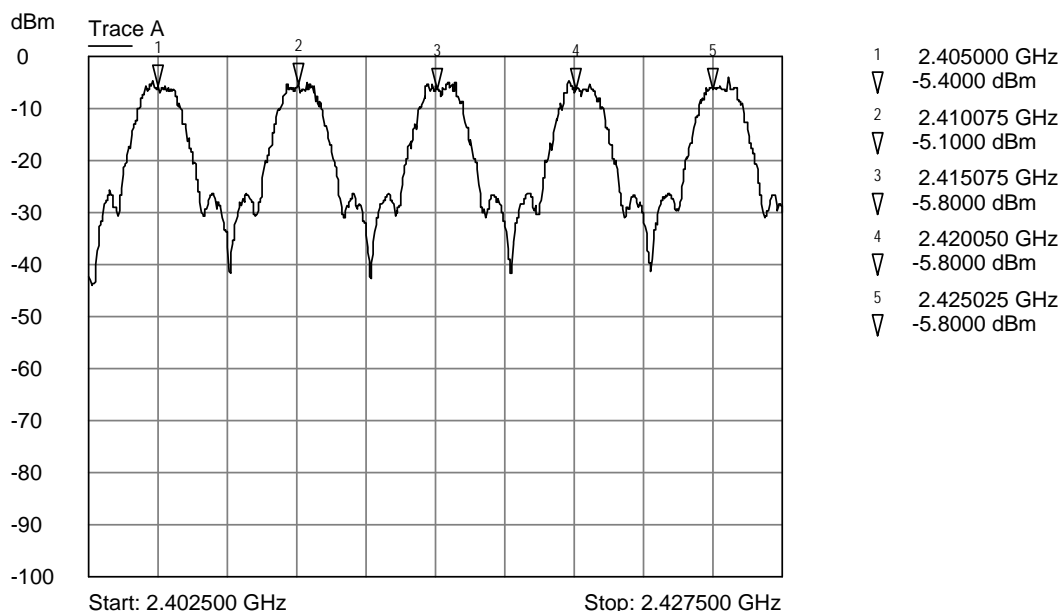

Trace A Lower 5 channels

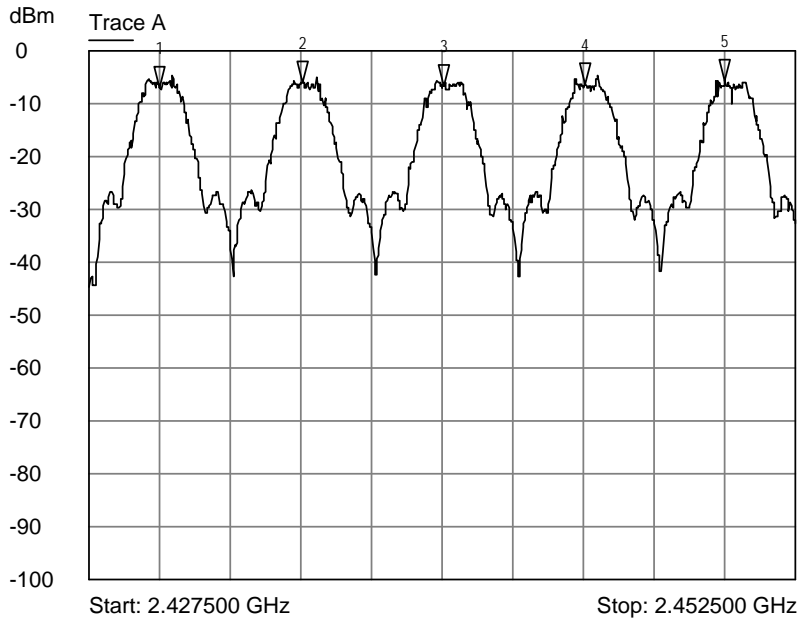

- 1 2.430000 GHz
▽ -6.5000 dBm
- 2 2.435075 GHz
▽ -5.5000 dBm
- 3 2.440075 GHz
▽ -6.2000 dBm
- 4 2.445050 GHz
▽ -6.1000 dBm
- 5 2.450025 GHz
▽ -5.3000 dBm

Trace A Middle 5 channels

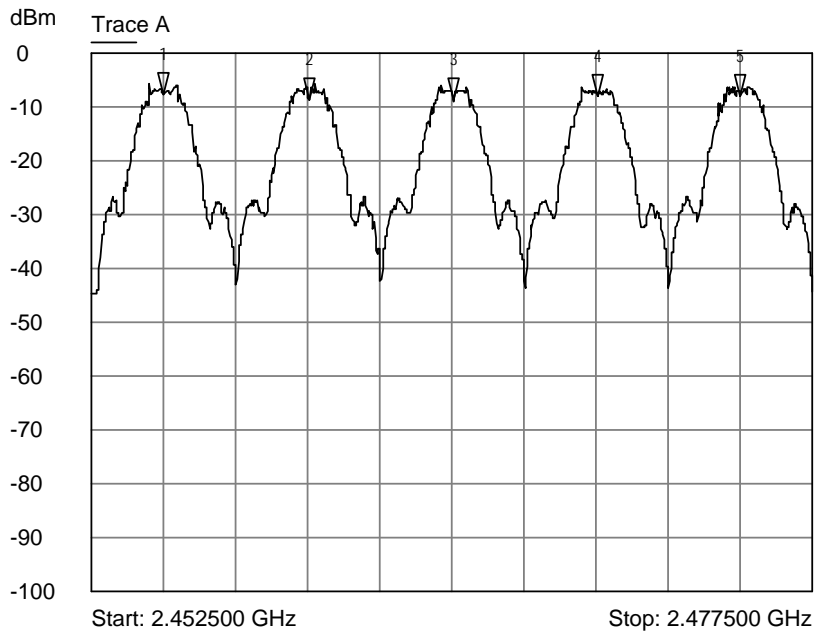

- 1 2.455000 GHz
▽ -7.4000 dBm
- 2 2.460075 GHz
▽ -8.1000 dBm
- 3 2.465075 GHz
▽ -8.2000 dBm
- 4 2.470050 GHz
▽ -7.6000 dBm
- 5 2.475025 GHz
▽ -7.5000 dBm

Trace A Upper 5 channels

This report covers the circuitry of the devices subject to FCC Part 15, Subpart C. The circuitry of the devices subject to other standards, are to be tested and covered in other reports.

2.3 EUT and Support Equipment:

The FCC ID numbers for all the EUT and support equipment used during the test are listed below:

Brand Name Model Number	FCC ID Number	Description	Name of Interface Ports / Interface Cables
BN: Mesa Laboratories MN: DTENV-H (Note 1)	UUYDT002	Network Host	See Section 2.4
BN: Mesa Laboratories MN: DTENV-R (Note 1)	UUYDT002	Network Repeater	See Section 2.4
BN: Dell MN: Inspiron 1300	DoC	Laptop Computer	USB/USB cable (Note 2) USB/USB cable from mouse (Note 3) LAN/Cat 5 cable with RJ45 connectors
BN: Dell MN: M-UAN DEL1	DoC	Mouse	USB/USB cable (Note 3)
BN: TRENDnet MN: TEG-S50TXE	DoC	5 port LAN switch	Ethernet/Cat 5 cable w/RJ45 connectors

Note: (1) EUT

(2) Interface port connected to EUT (See Section 2.4)

(3) Mouse and keyboard cable permanently attached.

The support equipment listed above was not modified in order to achieve compliance with this standard.

2.4 Interface Ports on EUT:**2.4.1 DTENV-H Ports**

Name of Ports	No. of Ports Fitted to EUT	Cable Descriptions/Length
USB	1	USB cable/1 meter

2.4.2 DTENV-R Ports

There are no ports to interface other equipment on the DTENV-R.

2.5 Modification Incorporated/Special Accessories on EUT:

The following modifications were made to the EUT by the Client during testing to comply with the specification. These modifications will be implemented during manufacturing.

1. The DTENV-H had the transmitter power setting changed to 0/3.
2. The DTENV-R had the transmitter power setting changed to 1/1.

Signature: _____

Typed Name: Preston Graves

Title: Director of R & D

SECTION 3.0 TEST SPECIFICATION, METHODS & PROCEDURES**3.1 Test Specification:**

Title: FCC PART 15, Subpart C (47 CFR 15).
15.203, 15.207, and 15.247

Limits and methods of measurement of radio interference characteristics of radio frequency devices.

Purpose of Test: The tests were performed to demonstrate initial compliance.

3.2 Methods & Procedures:**3.2.1 §15.203 Antenna Requirement**

An intentional radiator shall be designed to ensure that no antenna other than that furnished by the responsible party shall be used with the device. The use of a permanently attached antenna or of an antenna that uses a unique coupling to the intentional radiator shall be considered sufficient to comply with the provisions of this Section. The manufacturer may design the unit so that a broken antenna can be replaced by the user, but the use of a standard antenna jack or electrical connector is prohibited. This requirement does not apply to carrier current devices or to devices operated under the provisions of Sections 15.211, 15.213, 15.217, 15.219, or 15.221. Further, this requirement does not apply to intentional radiators that must be professionally installed, such as perimeter protection systems and some field disturbance sensors, or to other intentional radiators which, in accordance with Section 15.31(d), must be measured at the installation site. However, the installer shall be responsible for ensuring that the proper antenna is employed so that the limits in this Part are not exceeded.

3.2.2 §15.207 Conducted Limits

(a) Except for Class A digital devices, for equipment that is designed to be connected to the public utility (AC) power line, the radio frequency voltage that is conducted back onto the AC power line on any frequency or frequencies within the band 150 KHZ to 30 MHz shall not exceed the limits in the following table, as measured using a 50 μ H/50 ohms line impedance stabilization network (LISN). Compliance with the provisions of this paragraph shall be based on the measurement of the radio frequency voltage between each power line and ground at the power terminal. The lower limit applies at the band edges.

Frequency of Emission (MHz)	Conducted Limit (dB μ V)	
	Quasi-peak	Average
0.15 - 0.5*	66 to 56*	56 to 46*
0.5 - 5	56	46
5 - 30	60	50

*Decreases with the logarithm of the frequency.

3.2.3 §15.247 Operation within the bands 902 - 928 MHz, 2400 - 2483.5 MHz, and 5725 -5850 MHz

(a) Operation under the provisions of this Section is limited to frequency hopping and digitally modulated intentional radiators that comply with the following provisions:

(1) Frequency hopping systems shall have hopping channel carrier frequencies separated by a minimum of 25 kHz or the 20 dB bandwidth of the hopping channel, whichever is greater. Alternatively, frequency hopping systems operating in the 2400 - 2483.5 MHz band may have hopping channel carrier frequencies that are separated by 25 kHz or two-thirds of the 20 dB bandwidth of the hopping channel, whichever is greater, provided the systems operate with an output power no greater than 125 mW. The system shall hop to channel frequencies that are selected at the system hopping rate from a pseudorandomly ordered list of hopping frequencies. Each frequency must be used equally on the average by each transmitter. The system receivers shall have input bandwidths that match the hopping channel bandwidths of their corresponding transmitters and shall shift frequencies in synchronization with the transmitted signals.

(i) For frequency hopping systems operating in the 902-928 MHz band: if the 20 dB bandwidth of the hopping channel is less than 250 kHz, the system shall use at least 50 hopping frequencies and the average time of occupancy on any frequency shall not be greater than 0.4 seconds within a 20 second period; if the 20 dB bandwidth of the hopping channel is 250 kHz or greater, the system shall use at least 25 hopping frequencies and the average time of occupancy on any frequency shall not be greater than 0.4 seconds within a 10 second period. The maximum allowed 20 dB bandwidth of the hopping channel is 500 kHz.

(ii) Frequency hopping systems operating in the 5725-5850 MHz band shall use at least 75 hopping frequencies. The maximum 20 dB bandwidth of the hopping channel is 1 MHz. The average time of occupancy on any

frequency shall not be greater than 0.4 seconds within a 30 second period.

(iii) Frequency hopping systems in the 2400-2483.5 MHz band shall use at least 15 non-overlapping channels. The average time of occupancy on any channel shall not be greater than 0.4 seconds within a period of 0.4 seconds multiplied by the number of hopping channels employed. Frequency hopping systems may avoid or suppress transmissions on a particular hopping frequency provided that a minimum of 15 non-overlapping channels are used.

(2) Systems using digital modulation techniques may operate in the 902 - 928 MHz, 2400 - 2483.5 MHz, and 5725 - 5850 MHz bands. The minimum 6 dB bandwidth shall be at least 500 kHz.

(b) The maximum peak output power of the intentional radiator shall not exceed the following:

(1) For frequency hopping systems operating in the 2400-2483.5 MHz band employing at least 75 non-overlapping hopping channels, and all frequency hopping systems in the 5725-5850 MHz band: 1 watt. For all other frequency hopping systems in the 2400-2483.5 MHz band: 0.125 watts.

(2) For frequency hopping systems operating in the 902-928 MHz band: 1 watt for systems employing at least 50 hopping channels; and, 0.25 watts for systems employing less than 50 hopping channels, but at least 25 hopping channels, as permitted under paragraph (a)(1)(i) of this section.

(3) For systems using digital modulation in the 902-928 MHz, 2400-2483.5 MHz, and 5725 - 5850 MHz bands: 1 watt. As an alternative to a peak power measurement, compliance with the Conducted Output Power is defined as the total transmit power delivered to all antennas and antenna elements averaged across all symbols in the signaling alphabet when the transmitter is operating at its maximum power control level. Power must be summed across all antennas and antenna elements. The average must not include any time intervals during which the transmitter is off or is transmitting at a reduced power level. If multiple modes of operation are possible (e.g., alternative modulation methods), the maximum conducted output power is the highest total transmit power occurring in any mode.

(4) The conducted output power limit specified in paragraph (b) of this section is based on the use of antennas with directional gains that do not exceed 6 dBi. Except as shown in paragraph (c) of this section, if

transmitting antennas of directional gain greater than 6 dBi are used, the conducted power from the intentional radiator shall be reduced below the stated values in paragraphs (b)(1), (b)(2), and (b)(3) of this section, as appropriate, by the amount in dB that the directional gain of the antenna exceeds 6 dBi.

(c) Operation with directional antenna gains greater than 6 dBi.

(1) Fixed point-to-point operation:

(i) Systems operating in the 2400-2483.5 MHz band that are used exclusively for fixed, point-to-point operations may employ transmitting antennas with directional gain greater than 6 dBi provided the maximum peak output power of the intentional radiator is reduced by 1 dB for every 3 dB that the directional gain of the antenna exceeds 6 dBi.

(ii) Systems operating in the 5725-5850 MHz band that are used exclusively for fixed, point-to-point operations may employ transmitting antennas with directional gain greater than 6 dBi without any corresponding reduction in transmitter peak output power.

(iii) Fixed, point-to-point operation, as used in paragraphs (b)(4)(i) and (b)(4)(ii) of this section, excludes the use of point-to-multipoint systems, omnidirectional applications, and multiple co-located intentional radiators transmitting the same information. The operator of the spread spectrum or digitally modulated intentional radiator or, if the equipment is professionally installed, the installer is responsible for ensuring that the system is used exclusively for fixed, point-to-point operations. The instruction manual furnished with the intentional radiator shall contain language in the installation instructions informing the operator and the installer of this responsibility.

(2) In addition to the provisions in paragraphs (b)(1), (b)(3), (b)(4) and (c)(1)(i) of this section, transmitters operating in the 2400-2483.5 MHz band that emit multiple directional beams, simultaneously or sequentially, for the purpose of directing signals to individual receivers or to groups of receivers provided the emissions comply with the following:

(i) Different information must be transmitted to each receiver.

(ii) If the transmitter employs an antenna system that emits multiple directional beams but does not emit multiple directional beams simultaneously, the total output power conducted to the array or arrays that comprise the device, i.e., the sum of the power supplied to all antennas, antenna elements, staves, etc. and summed across all carriers or frequency channels, shall not exceed the limit specified in paragraph (b)(1) or (b)(3) of this section, as applicable. However, the total conducted output power shall be reduced by 1 dB below the specified limits for each 3 dB that the directional gain of the antenna /antenna array exceeds 6 dBi. The directional antenna gain shall be computed as follows:

(A) The directional gain shall be calculated as the sum of $10 \log$ (number of array elements or staves) plus the directional gain of the element or stave having the highest gain.

(B) A lower value for the directional gain than that calculated in paragraph (c)(2)(ii)(A) of this section will be accepted if sufficient evidence is presented, e.g., due to shading of the array or coherence loss in the beamforming.

(iii) If a transmitter employs an antenna that operates simultaneously on multiple directional beams using the same or different frequency channels, the power supplied to each emission beam is subject to the power limit specified in paragraph (c)(2)(ii) of this section. If transmitted beams overlap, the power shall be reduced to ensure that their aggregate power does not exceed the limit specified in paragraph (c)(2)(ii) of this section. In addition, the aggregate power transmitted simultaneously on all beams shall not exceed the limit specified in paragraph (c)(2)(ii) of this section by more than 8 dB.

(iv) Transmitters that emit a single directional beam shall operate under the provisions of paragraph (c)(1) of this section.

(d) In any 100 kHz bandwidth outside the frequency band in which the spread spectrum or digitally modulated intentional radiator is operating, the radio frequency power that is produced by the intentional radiator shall be at least 20 dB below that in the 100 kHz bandwidth within the band that contains the highest level of the desired power, based on either an RF conducted or a radiated measurement, provided the transmitter demonstrates compliance with the peak conducted power limits. If the transmitter complies with the conducted power limits based on the

use of RMS averaging over a time interval, as permitted under paragraph (b)(3) of this section, the attenuation required under this paragraph shall be 30 dB instead of 20 dB. Attenuation below the general limits specified in Section 15.209(a) is not required. In addition, radiated emissions which fall in the restricted bands, as defined in Section 15.205(a), must also comply with the radiated emission limits specified in Section 15.209(a) (see Section 15.205(c)).

(e) For digitally modulated systems, the power spectral density conducted from the intentional radiator to the antenna shall not be greater than 8 dBm in any 3 kHz band during any time interval of continuous transmission. This power spectral density shall be determined in accordance with the provisions of paragraph (b) of this section. The same method of determining the conducted output power shall be used to determine the power spectral density.

(f) For the purposes of this section, hybrid systems are those that employ a combination of both frequency hopping and digital modulation techniques. The frequency hopping operation of the hybrid system, with the direct sequence or digital modulation operation turned off, shall have an average time of occupancy on any frequency not to exceed 0.4 seconds within a time period in seconds equal to the number of hopping frequencies employed multiplied by 0.4. The digital modulation operation of the hybrid system, with the frequency hopping turned off, shall comply with the power density requirements of paragraph (d) of this section.

(g) Frequency hopping spread spectrum systems are not required to employ all available hopping channels during each transmission. However, the system, consisting of both the transmitter and the receiver, must be designed to comply with all of the regulations in this section should the transmitter be presented with a continuous data (or information) stream. In addition, a system employing short transmission bursts must comply with the definition of a frequency hopping system and must distribute its transmissions over the minimum number of hopping channels specified in this section.

(h) The incorporation of intelligence within a frequency hopping spread spectrum system that permits the system to recognize other users within the spectrum band so that it individually and independently chooses and adapts its hopsets to avoid hopping on occupied channels is permitted. The coordination of frequency hopping systems in any other manner for the express purpose of avoiding the simultaneous occupancy of individual hopping frequencies by multiple transmitters is not permitted.

(i) Systems operating under the provisions of this section shall be operated in a manner that ensures that the public is not exposed to radio frequency energy levels in excess of the

Commission's guidelines. See § 1.1307(b)(1) of this Chapter.

Note: Spread spectrum systems are sharing these bands on a noninterference basis with systems supporting critical Government requirements that have been allocated the usage of these bands, secondary only to ISM equipment operated under the provisions of Part 18 of this Chapter. Many of these Government systems are airborne radiolocation systems that emit a high EIRP which can cause interference to other users. Also, investigations of the effect of spread spectrum interference to U. S. Government operations in the 902-928 MHz band may require a future decrease in the power limits allowed for spread spectrum operation.

3.2.3 Test Procedure

The conducted disturbance at mains and telecommunications ports and radiated disturbance testing was performed according to the procedures in ANSI C63.4: 2004. Testing was performed at CCL's Wanship open area test site #2, located at 29145 Old Lincoln Highway, Wanship, UT. This site has been fully described in a report submitted to the FCC, and was accepted in a letter dated March 11, 2009 (90504).

CCL is accredited by National Voluntary Laboratory Accreditation Program (NVLAP); NVLAP Lab Code: 100272-0, which is effective until September 30, 2009.

For radiated emissions testing at 30 MHz or above that is performed at distances closer than the specified distance, an inverse proportionality factor of 20 dB per decade is used to normalize the measured data for determining compliance.

SECTION 4.0 OPERATION OF EUT DURING TESTING**4.1 Operating Environment:**

Power Supply: 120/240 VAC
AC Mains Frequency: 60/50 Hz

4.2 Operating Modes:

The transmitter was in a constant transmit mode at the desired frequency. The transceivers were placed on 3 axis, flat horizontal, vertical, and on-edge horizontal. The DTENV-H exhibited the worst-case emissions when placed flat on the table with the antenna vertical. The DTENV-R exhibited the worst-case emissions when placed with the antenna vertical. This report shows the results from testing in the worst-case configuration.

4.3 EUT Exercise Software:

Mesa Laboratories, Inc. software was used to exercise the transmitter.

4.4 Configuration & Peripherals:

The DTENV-H and DTENV-R were placed on the table and connected to the support equipment listed in Section 2.3 via each port listed in Section 2.4. Shown in Section 4.5 is a block diagram of the test configuration.

SECTION 5.0 SUMMARY OF TEST RESULTS**5.1 FCC Part 15, Subpart C****5.1.1 Summary of Tests:**

Section	Environmental Phenomena	Frequency Range (MHz)	Result
15.203	Antenna Requirements	Structural requirement	Complied
15.207	Conducted Disturbance at Mains Ports	0.15 to 30	Complied
15.247(a)	Bandwidth Requirement	2400 - 2483.5	Complied
15.247(b)	Peak Output Power	2400 - 2483.5	Complied
15.247(c)	Antenna Conducted Spurious Emissions	30 - 25000	Complied
15.247(c)	Radiated Spurious Emissions	30 - 25000	Complied
15.247(d)	Peak Power Spectral Density	2400 - 2483.5	Complied
15.247(e)	Reserved Paragraph	N/A	Not Applicable
15.247(f)	Hybrid System Requirements	2400 - 2483.5	Not Applicable
15.247(g)	Frequency Hopping Channel Usage	2400 - 2438.5	Not Applicable
15.247(h)	Frequency Hopping Intelligence	2400 - 2483.5	Not Applicable

5.2 Result

In the configuration tested, the EUT complied with the requirements of the specification.

SECTION 6.0 MEASUREMENTS, EXAMINATIONS AND DERIVED RESULTS**6.1 General Comments:**

This section contains the test results only. The conducted tests at the antenna port were all performed with the power level at the higher setting of 1/1. Details of the test methods used and a list of the test equipment used during the measurements can be found in Appendix 1 of this report.

6.2 Test Results:**6.2.1 §15.203 Antenna Requirements**

The antenna of the DTENV-R is soldered to the PCB and is not replaceable. The DTENV-H uses a monopole antenna with a reverse SMA connector. The requirements of this paragraph are met.

6.2.2 §15.207 Conducted Disturbance at the AC Mains Ports

Frequency (MHz)	AC Mains Lead	Detector	Measured Level (dBμV)	Limit (dBμV)	Margin (dB)
0.15	Hot Lead	Peak (Note 1)	41.2	56.0	-14.8
0.32	Hot Lead	Peak (Note 1)	34.4	49.8	-15.4
0.58	Hot Lead	Peak (Note 1)	31.3	46.0	-14.7
0.93	Hot Lead	Peak (Note 1)	30.1	46.0	-15.9
1.90	Hot Lead	Peak (Note 1)	29.2	46.0	-16.8
3.65	Hot Lead	Peak (Note 1)	28.8	46.0	-17.2
0.17	Neutral Lead	Peak (Note 1)	37.9	55.0	-17.1
0.36	Neutral Lead	Peak (Note 1)	37.9	48.7	-10.8
0.47	Neutral Lead	Peak (Note 1)	35.3	46.6	-11.3
2.44	Neutral Lead	Peak (Note 1)	32.6	46.0	-13.4
3.45	Neutral Lead	Peak (Note 1)	32.5	46.0	-13.5
4.63	Neutral Lead	Peak (Note 1)	31.7	46.0	-14.3

Note 1: The reference detector used for the measurements was Quasi-Peak or Peak and the data was compared to the average limit; therefore, the EUT was deemed to meet both the average and quasi-peak limits.

Note 2: The reference detector used for the measurements was quasi-peak and average and the data was compared to the respective limits.

6.2.3 §15.247(a)(2) Emission Bandwidth

A diagram of the test configuration and the test equipment used is enclosed in Appendix 1.

Frequency (MHz)	Emission 6dB Bandwidth (kHz)
2405.00	1600
2440.00	1590
2475.00	1620

RESULT

In the configuration tested, the 6 dB bandwidth was greater than 500 kHz; therefore, the EUT complied with the requirements of the specification (see spectrum analyzer plots below).

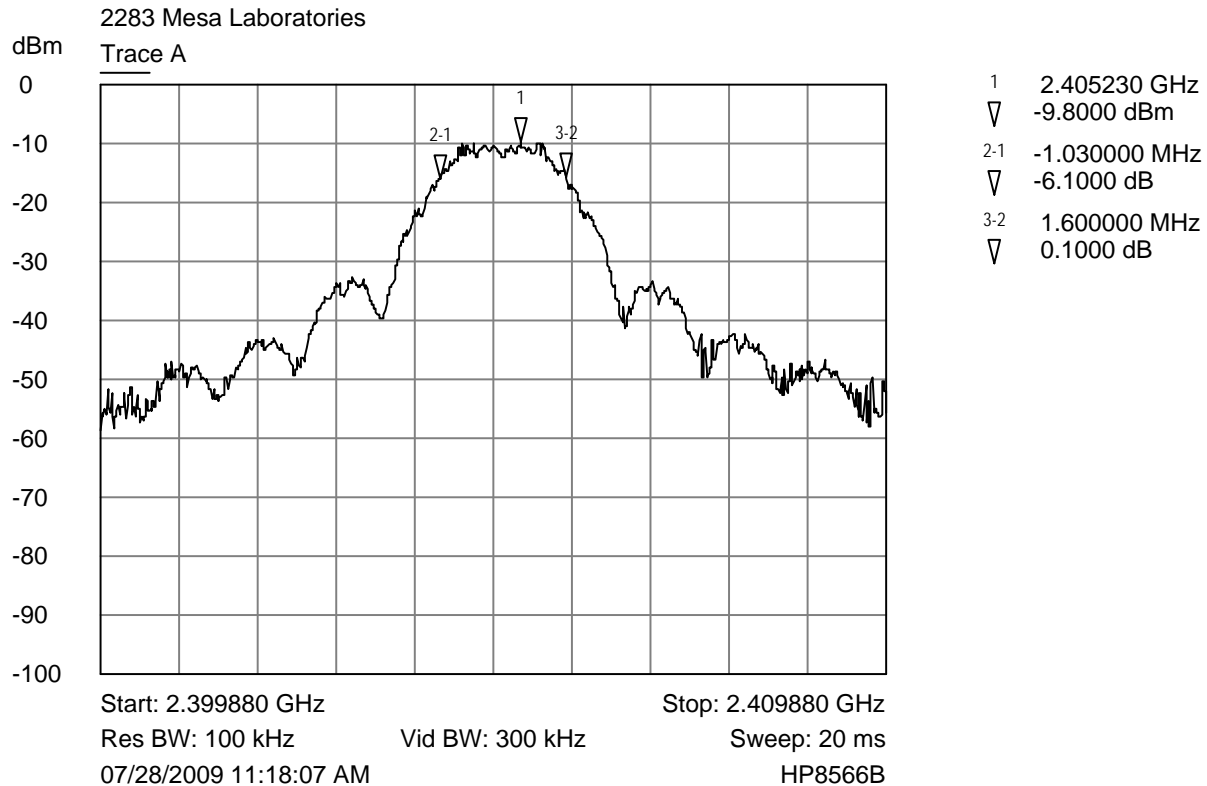

Trace A Lower channel bandwidth plot (1/1 power setting)

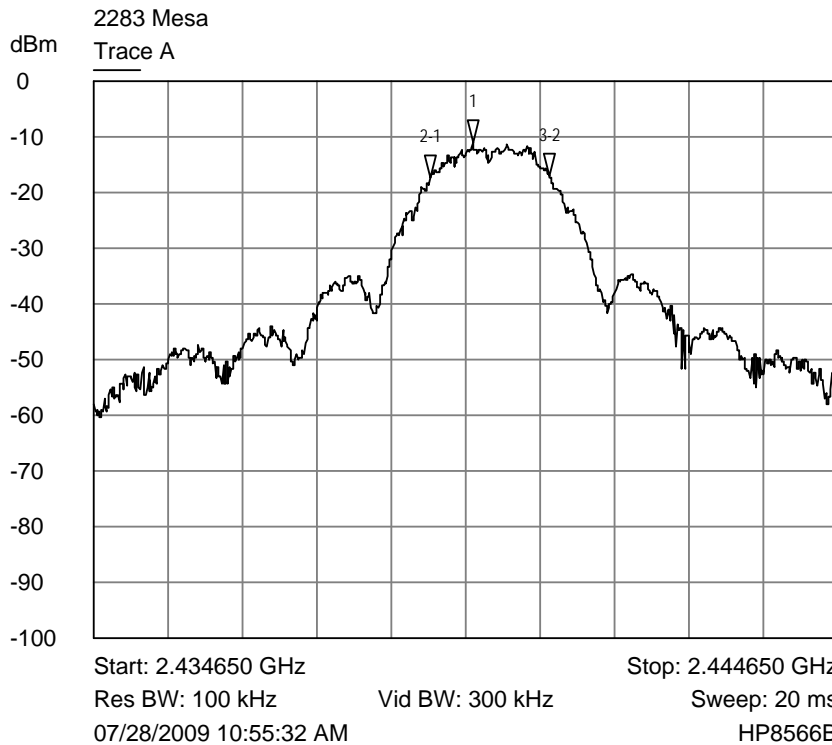

- 1 2.439740 GHz
 ▽ -11.0000 dBm
- 2-1 -560.000000 kHz
 ▽ -6.2000 dB
- 3-2 1.590000 MHz
 ▽ 0.2000 dB

Trace A Middle channel bandwidth plot (1/1 power setting)

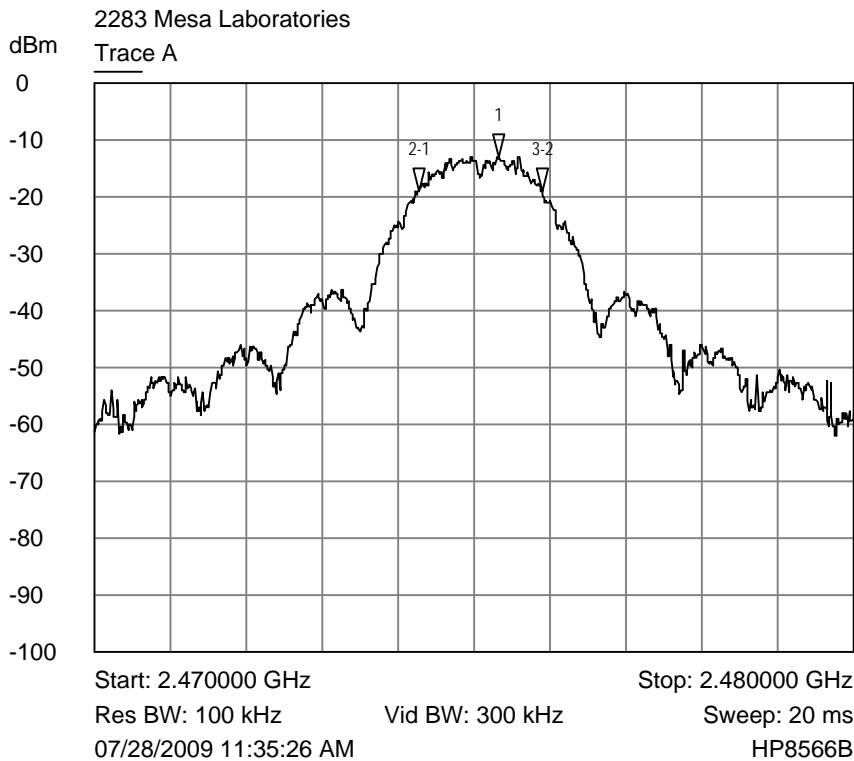

- 1 2.475330 GHz
 ▽ -13.0000 dBm
- 2-1 -1.060000 MHz
 ▽ -6.0000 dB
- 3-2 1.620000 MHz
 ▽ 0 dB

Trace A Upper channel bandwidth plot (1/1 power setting)

6.2.4 §15.247(b)(3) Peak Output Power

The maximum peak RF Conducted output power measured for this device was 0.33 mW or -4.7 dBm. The maximum directional gain of the antenna is 9 dBi. The antenna with 9 dBi gain exceeds the specified antenna gain of 6 dBi by 3 dB. Adjustment of the output power is not necessary as the conducted power is greater than 3 dB below the limit of 30 dBm to the antenna.

A diagram of the test configuration and the test equipment used is enclosed in Appendix 1.

Frequency (MHz)	Measured Output Power (dBm)	Measured Output Power (mW)
2405.00	-4.7	0.33
2440.00	-6.2	0.24
2475.00	-7.8	0.17

RESULT

In the configuration tested, the RF peak output power was less than 1 Watt; therefore, the EUT complied with the requirements of the specification (see spectrum analyzer plots below).

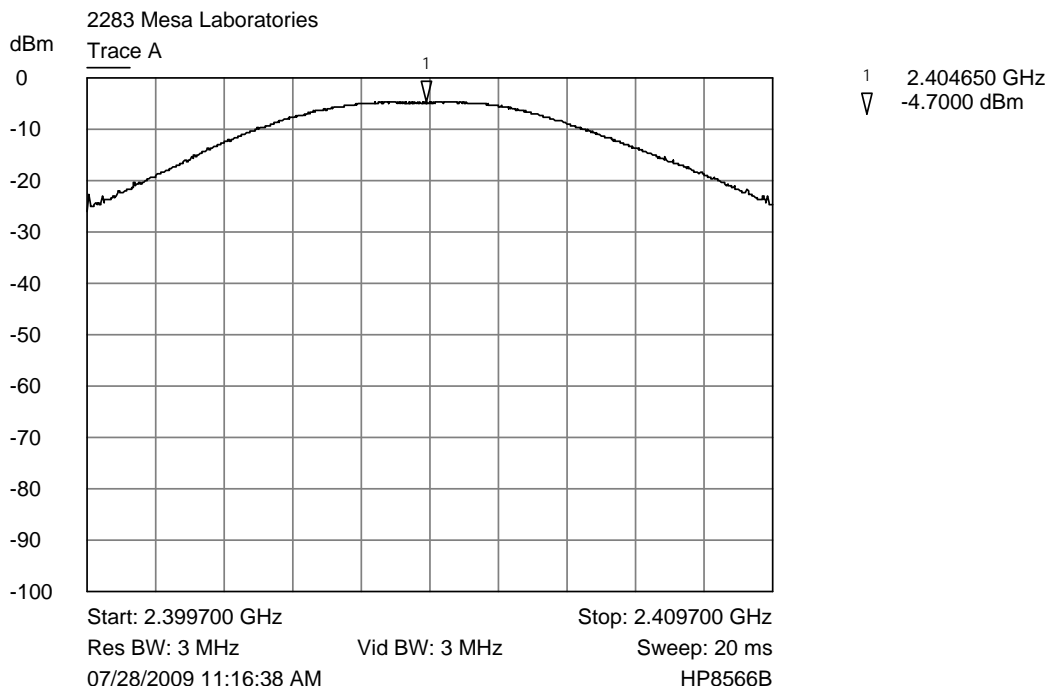

Trace A Lower channel output power plot (1/1 power setting)

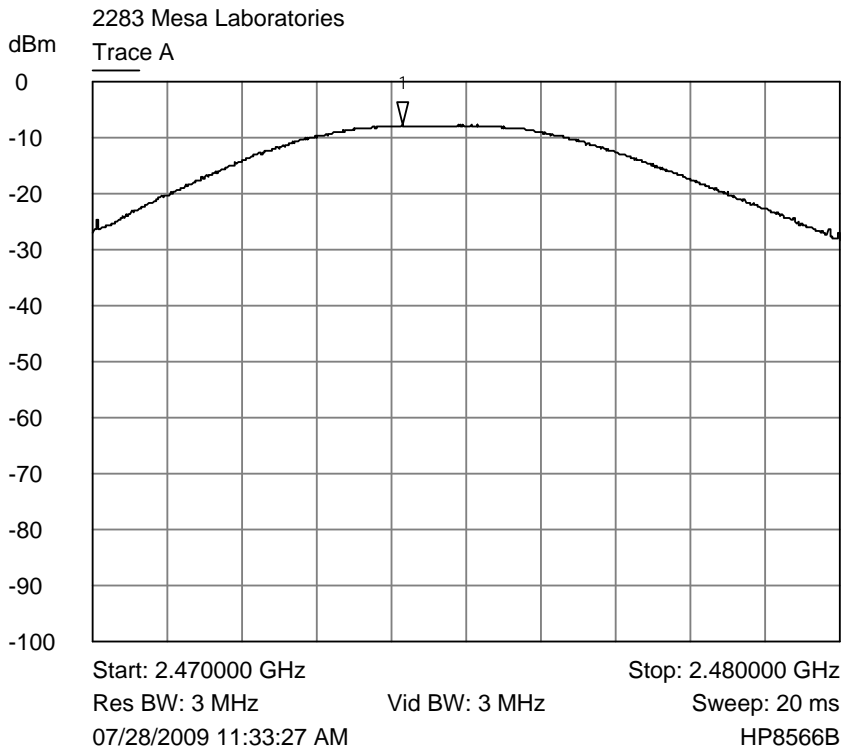

1 2.474140 GHz
▽ -7.8000 dBm

Trace A Upper channel output power plot (1/1 power setting)

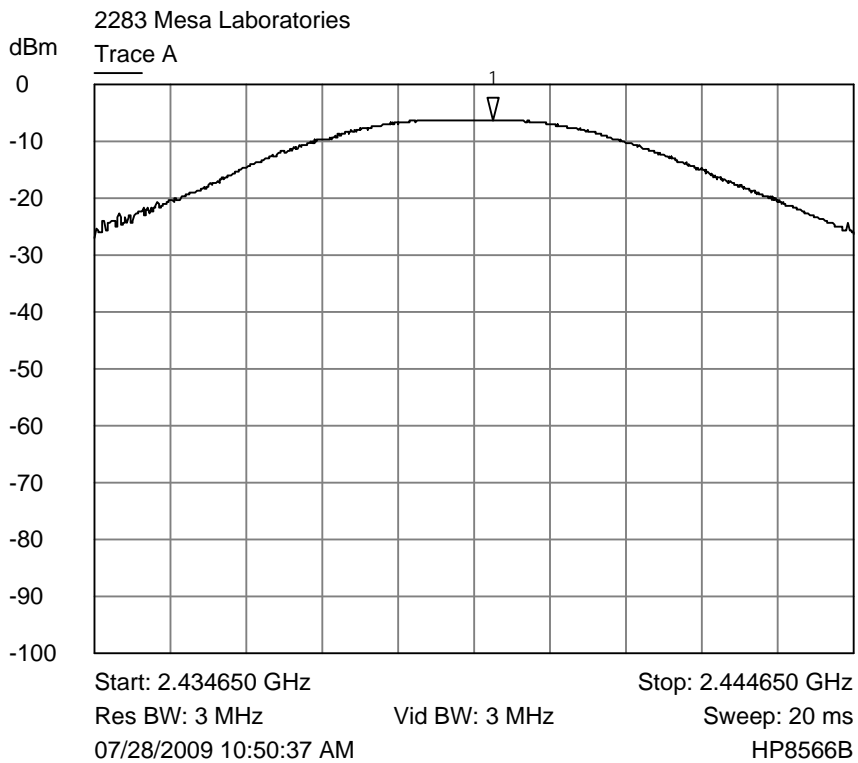

1 2.439890 GHz
▽ -6.2000 dBm

Trace A Middle channel output power plot (1/1 power setting)

6.2.5 §15.247(c) Spurious Emissions

6.2.5.1 Conducted Spurious Emissions

The frequency range from 8 MHz to the tenth harmonic of the highest fundamental frequency was investigated to measure any antenna-conducted emissions. Shown below are plots with the EUT tuned to the upper and lower channels. These demonstrate compliance with the provisions of this section at the band edges. The tables following the band edge plots shows the measurement data from spurious emissions noted across the frequency range when transmitting at the lowest frequency, middle frequency, and upper frequency.

The emissions must be attenuated 20 dB below the highest power level measured within the authorized band as measured with a 100 kHz RBW; the highest level measured was -10.8 dBm; therefore, the criteria is $-10.8 - 20.0 = -30.8$ dBm.

A diagram of the test configuration and the test equipment used is provided in Appendix 1.

RESULT

Conducted spurious emissions must be attenuated below -30.8 dBm. The highest emission noted was at -50.4 dBm; therefore, the EUT complies with the specification.

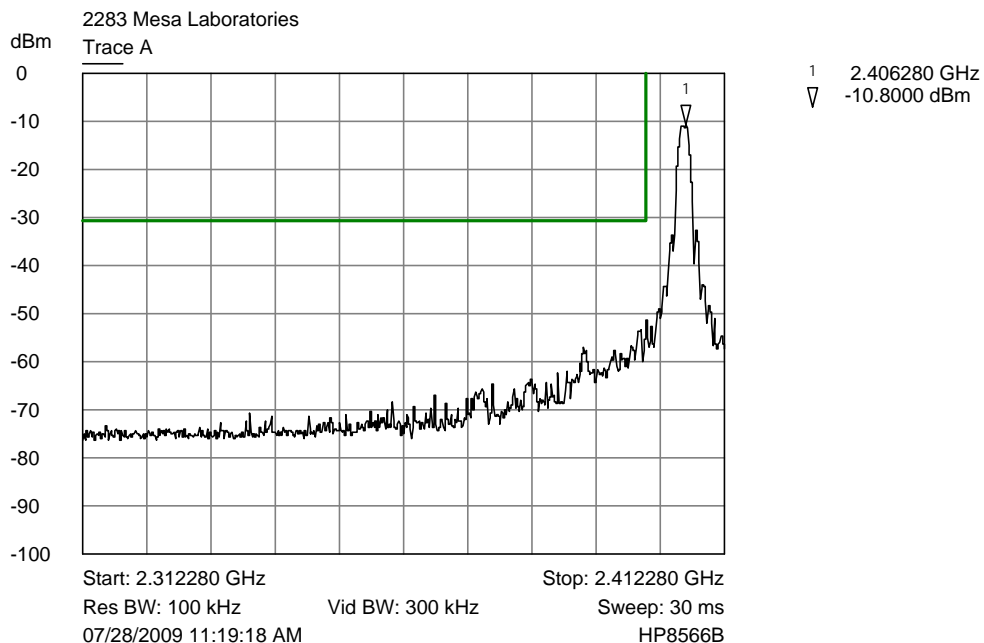

Trace A Lower channel band edge plot (1/1 power setting)

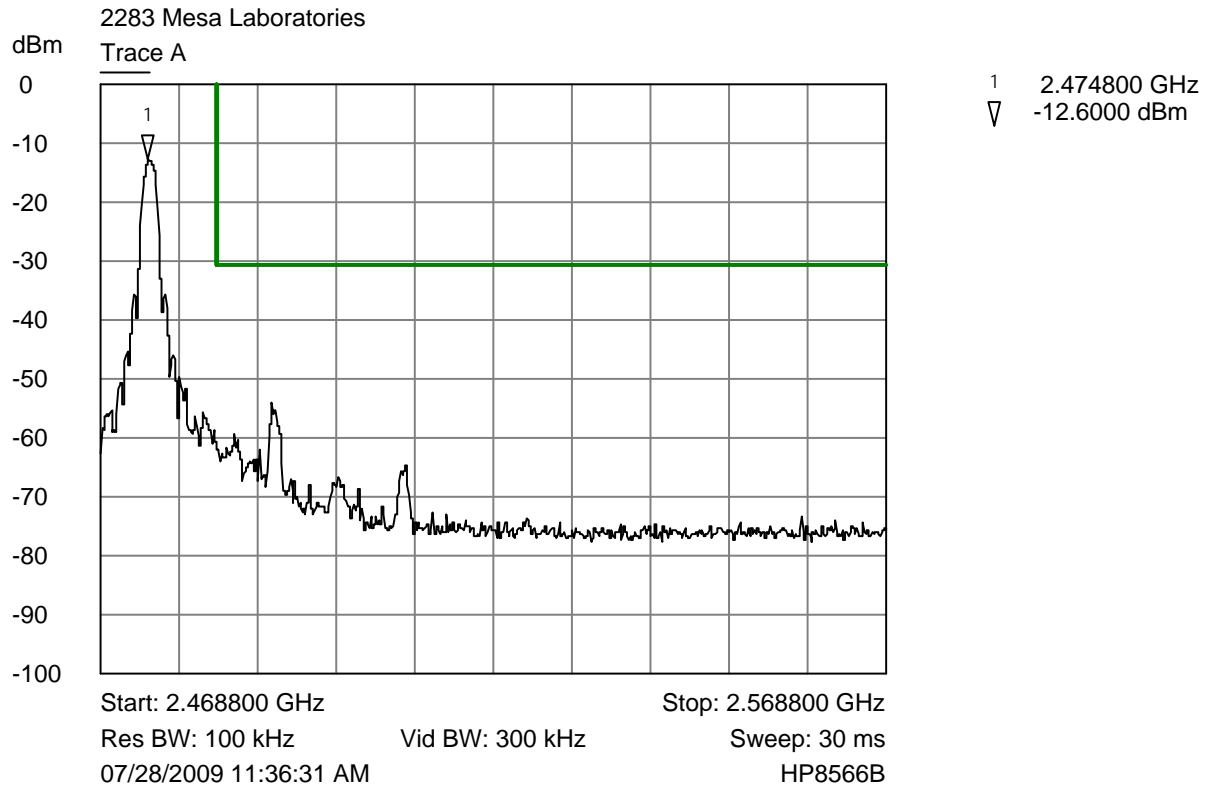

Trace A Upper channel band edge plot (1/1 power setting)

Transmitting on the Lowest Channel (2.405 GHz)

Frequency (MHz)	Corrected Level (dBm)	Criteria (dBm)
4810.0	-50.4	-30.8
7215.0	-63.1	-30.8
9620.0	-54.9	-30.8
12025.0	-69.1	-30.8
14430.0	-65.2	-30.8
16835.0	-64.6	-30.8
19240.0	-61.9	-30.8
21645.0	-59.7	-30.8
24050.0	-59.9	-30.8

Transmitting on the Middle Channel (2.440 GHz)

Frequency (MHz)	Corrected Level (dBm)	Criteria (dBm)
4880.0	-51.9	-30.8
7320.0	-64.8	-30.8
9760.0	-57.2	-30.8
12200.0	-68.8	-30.8
14640.0	-64.5	-30.8
17080.0	-65.4	-30.8
19520.0	-61.4	-30.8
21960.0	-61.0	-30.8
24400.0	-59.9	-30.8

Transmitting on the Highest Channel (2.475 GHz)

Frequency (MHz)	Corrected Level (dBm)	Criteria (dBm)
4950.0	-53.9	-30.8
7425.0	-66.2	-30.8
9900.0	-62.9	-30.8
12375.0	-70.2	-30.8
14850.0	-65.9	-30.8
17325.0	-64.9	-30.8
19800.0	-61.4	-30.8
22275.0	-60.1	-30.8
24750.0	-59.9	-30.8

6.2.5.2 Radiated Emissions in the Restricted Bands of §15.205

The frequency range from 30 MHz to 25 GHz was investigated to measure any radiated emissions in the restricted bands. The following tables show measurements of any emission that fell into the restricted bands of §15.205. The tables show the worst-case emission measured from the DTENV-H and DTENV-R. For frequencies above 7.5 GHz, a measurement distance of 1 meter was used. The noise floor was a minimum of 6 dB below the limit. The emissions in the restricted bands must meet the limits specified in §15.209. Tabular data for each of the spurious emissions is shown below for each of the units. Plots of the band edges are also shown.

A diagram of the test configuration and the test equipment used is enclosed in Appendix 1. For frequencies below 1000 MHz RBW = 100 kHz and VBW = 300 kHz, For frequencies above 1000 MHz RBW = 1 Mhz and VBW = 3 MHz.

AVERAGE FACTOR

The EUT transmits continuously therefore; there is not an average factor for this device.

RESULT

All emissions in the restricted bands of §15.205 met the limits specified in §15.209; therefore, the EUT complies with the specification.

6.2.5.2.1 DTENV-H

Transmitting at the Lowest Frequency (2.405 GHz)

Frequency (MHz)	Detection Mode	Antenna Polarity	Receiver Reading (dBμV)	Correction Factor (dB)	Field Strength (dBμV/m)	Limit (dBμV/m)	Margin (dB)
4810.0	Peak	Vertical	16.4	37.5	53.9	74.0	-20.1
4810.0	Average	Vertical	11.2	37.5	48.7	54.0	-5.3
4810.0	Peak	Horizontal	15.6	37.5	53.1	74.0	-20.9
4810.0	Average	Horizontal	10.4	37.5	47.9	54.0	-6.1
7215.0	Peak	Vertical	2.6	41.4	44.0	74.0	-30.0
7215.0	Average	Vertical	-7.7	41.4	33.7	54.0	-20.3
7215.0	Peak	Horizontal	2.6	41.4	44.0	74.0	-30.0
7215.0	Average	Horizontal	-7.2	41.4	34.2	54.0	-19.8

Transmitting at the Middle Frequency (2.440 GHz)

Frequency (MHz)	Detection Mode	Antenna Polarity	Receiver Reading (dBμV)	Correction Factor (dB)	Field Strength (dBμV/m)	Limit (dBμV/m)	Margin (dB)
4880.0	Peak	Vertical	15.5	37.6	53.1	74.0	-20.9
4880.0	Average	Vertical	10.3	37.6	47.9	54.0	-6.1
4880.0	Peak	Horizontal	13.9	37.6	51.5	74.0	-22.5
4880.0	Average	Horizontal	8.7	37.6	46.3	54.0	-7.7
7320.0	Peak	Vertical	1.8	41.7	43.5	74.0	-30.5
7320.0	Average	Vertical	-8.1	41.7	33.6	54.0	-20.4
7320.0	Peak	Horizontal	0.9	41.7	42.6	74.0	-31.4
7320.0	Average	Horizontal	-8.8	41.7	32.9	54.0	-21.1

Transmitting at the Highest Frequency (2.475 GHz)

Frequency (MHz)	Detection Mode	Antenna Polarity	Receiver Reading (dBμV)	Correction Factor (dB)	Field Strength (dBμV/m)	Limit (dBμV/m)	Margin (dB)
4950.0	Peak	Vertical	16.4	37.8	54.2	74.0	-19.8
4950.0	Average	Vertical	9.3	37.8	47.1	54.0	-6.9
4950.0	Peak	Horizontal	15.1	37.8	52.9	74.0	-21.1
4950.0	Average	Horizontal	9.3	37.8	47.1	54.0	-6.9
7425.0	Peak	Vertical	2.1	41.9	44.0	74.0	-30.0
7425.0	Average	Vertical	-6.2	41.9	35.7	54.0	-18.3
7425.0	Peak	Horizontal	2.4	41.9	44.3	74.0	-29.7
7425.0	Average	Horizontal	-7.1	41.9	34.8	54.0	-19.2

No other emissions were seen in the restricted bands. Noise floor was greater than 6 dB below the limit. At frequencies above 7.5 GHz, a 1 meter measurement distance was used.

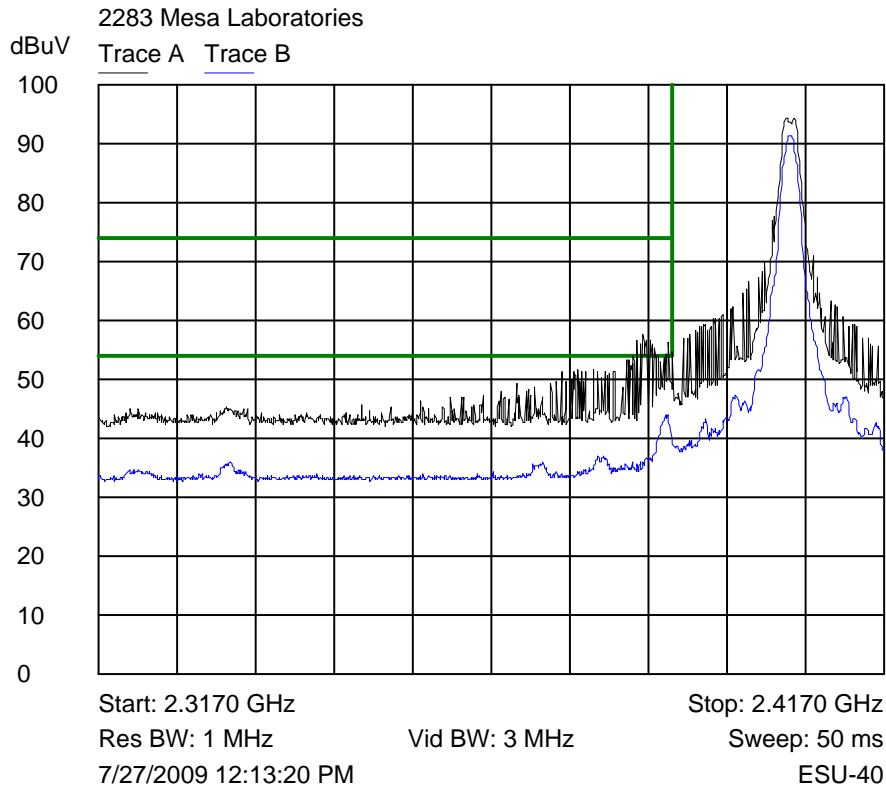

DTENV-H

Trace A lower band edge plot - peak detection

Trace B average detection

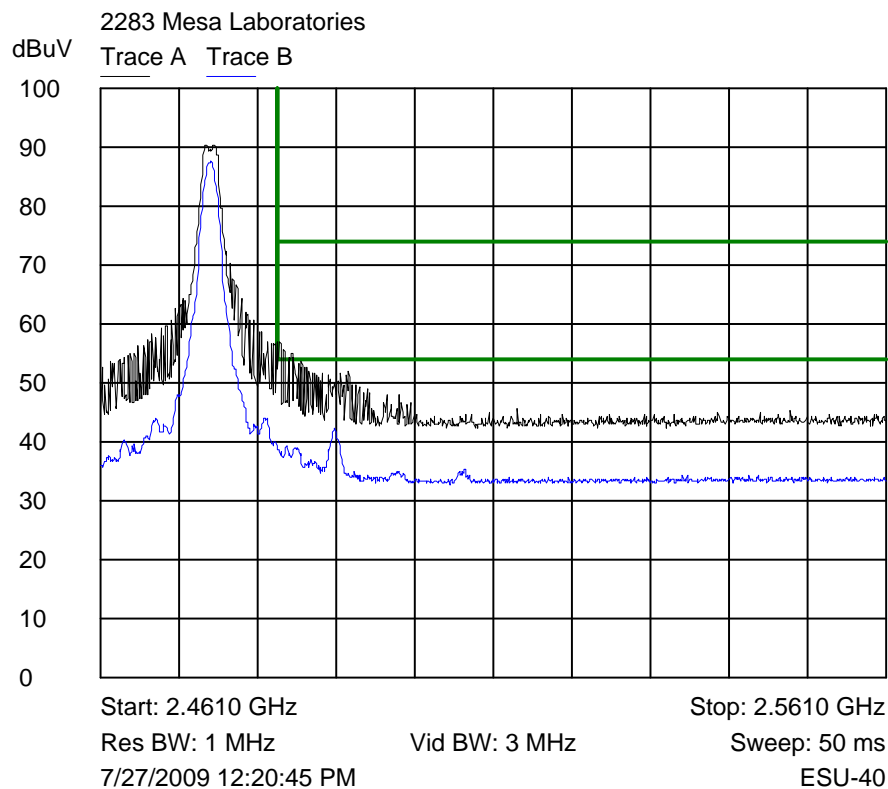

DTENV-H

Trace A lower band edge plot - peak detection

Trace B average detection

6.2.5.2.2 DTENV-R

Transmitting at the Lowest Frequency (2.405 GHz)

Frequency (MHz)	Detection Mode	Antenna Polarity	Receiver Reading (dBμV)	Correction Factor (dB)	Field Strength (dBμV/m)	Limit (dBμV/m)	Margin (dB)
4810.0	Peak	Vertical	19.5	37.5	57.0	74.0	-17.0
4810.0	Average	Vertical	14.6	37.5	52.1	54.0	-1.9
4810.0	Peak	Horizontal	16.5	37.5	54.0	74.0	-20.0
4810.0	Average	Horizontal	11.3	37.5	48.8	54.0	-5.2
7215.0	Peak	Vertical	6.9	41.4	48.3	74.0	-25.7
7215.0	Average	Vertical	-0.2	41.4	41.2	54.0	-12.8
7215.0	Peak	Horizontal	7.7	41.4	49.1	74.0	-24.9
7215.0	Average	Horizontal	-0.6	41.4	40.8	54.0	-13.2

Transmitting at the Middle Frequency (2.440 GHz)

Frequency (MHz)	Detection Mode	Antenna Polarity	Receiver Reading (dBμV)	Correction Factor (dB)	Field Strength (dBμV/m)	Limit (dBμV/m)	Margin (dB)
4880.0	Peak	Vertical	20.3	37.6	57.9	74.0	-16.1
4880.0	Average	Vertical	14.4	37.6	52.0	54.0	-2.0
4880.0	Peak	Horizontal	19.0	37.6	56.6	74.0	-17.4
4880.0	Average	Horizontal	14.1	37.6	51.7	54.0	-2.3
7320.0	Peak	Vertical	10.0	41.7	51.7	74.0	-22.3
7320.0	Average	Vertical	2.8	41.7	44.5	54.0	-9.5
7320.0	Peak	Horizontal	7.7	41.7	49.4	74.0	-24.6
7320.0	Average	Horizontal	0.9	41.7	42.6	54.0	-11.4

Transmitting at the Highest Frequency (2.475 GHz)

Frequency (MHz)	Detection Mode	Antenna Polarity	Receiver Reading (dBμV)	Correction Factor (dB)	Field Strength (dBμV/m)	Limit (dBμV/m)	Margin (dB)
4950.0	Peak	Vertical	19.9	37.8	57.7	74.0	-16.3
4950.0	Average	Vertical	15.0	37.8	52.8	54.0	-1.2
4950.0	Peak	Horizontal	19.2	37.8	57.0	74.0	-17.0
4950.0	Average	Horizontal	14.4	37.8	52.2	54.0	-1.8
7425.0	Peak	Vertical	11.3	41.9	53.2	74.0	-20.8
7425.0	Average	Vertical	5.2	41.9	47.1	54.0	-6.9
7425.0	Peak	Horizontal	9.5	41.9	51.4	74.0	-22.6
7425.0	Average	Horizontal	2.7	41.9	44.6	54.0	-9.4

No other emissions were seen in the restricted bands. Noise floor was greater than 6 dB below the limit. At frequencies above 7.5 GHz, a 1 meter measurement distance was used.

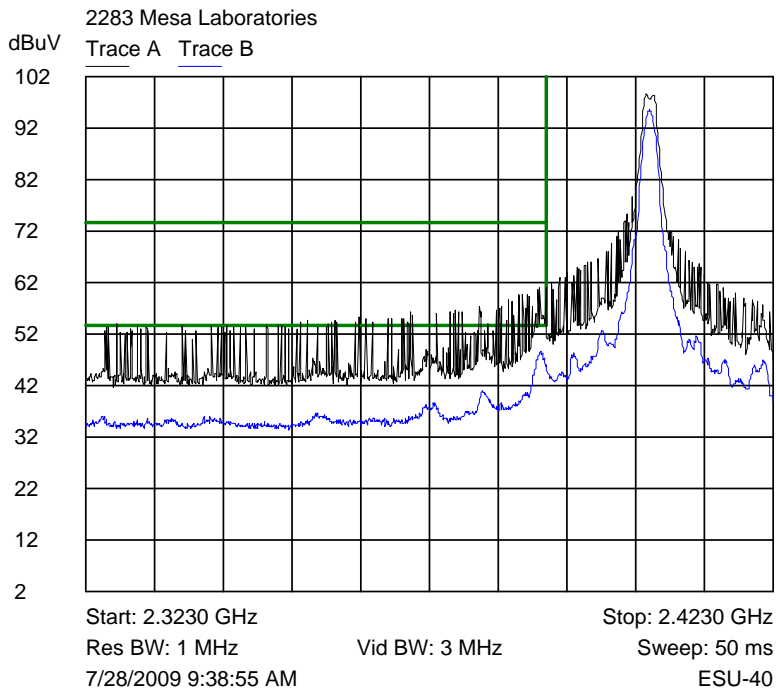

DTENV-R

Trace A lower band edge plot - peak detection

Trace B average detection

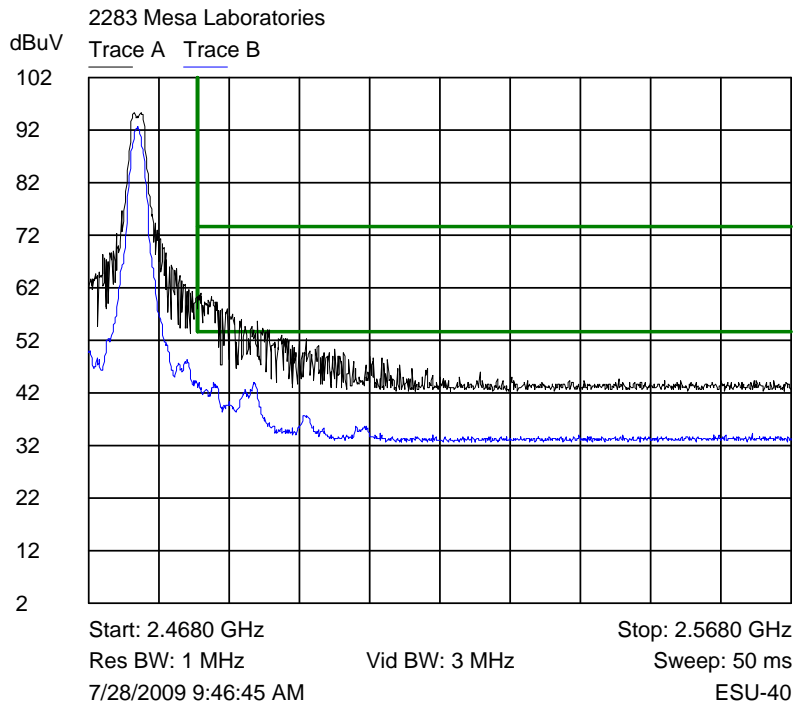

DTENV-R

Trace A lower band edge plot - peak detection

Trace B average detection

6.2.6 §15.247(d) Peak Power Spectral Density

The peak power spectral density conducted from the intentional radiator to the antenna shall not be greater than 8 dBm in any 3 kHz band during any time interval of continuous transmission. The plots are shown below and the results of this testing are summarized in the table below. Note that the peak output power of this device meets the power spectral density requirements.

Frequency (MHz)	Measurement (dBm)	Criteria (dBm)	Margin (dBm)
2405.00	-15.1	8.0	-23.1
2440.00	-16.6	8.0	-24.6
2475.00	-17.8	8.0	-25.8

A diagram of the test setup is included in Appendix 1. The spectrum analyzer RBW was set to 3 kHz and the VBW set greater than the RBW. The span was set to 1.5 MHz and the sweep was set to 500 seconds (Sweep = (Span/3 kHz)).

RESULT

The maximum peak power spectral density was -15.1 dBm. The limit is 8 dBm. The EUT complies with the specification by 23.1 dB.

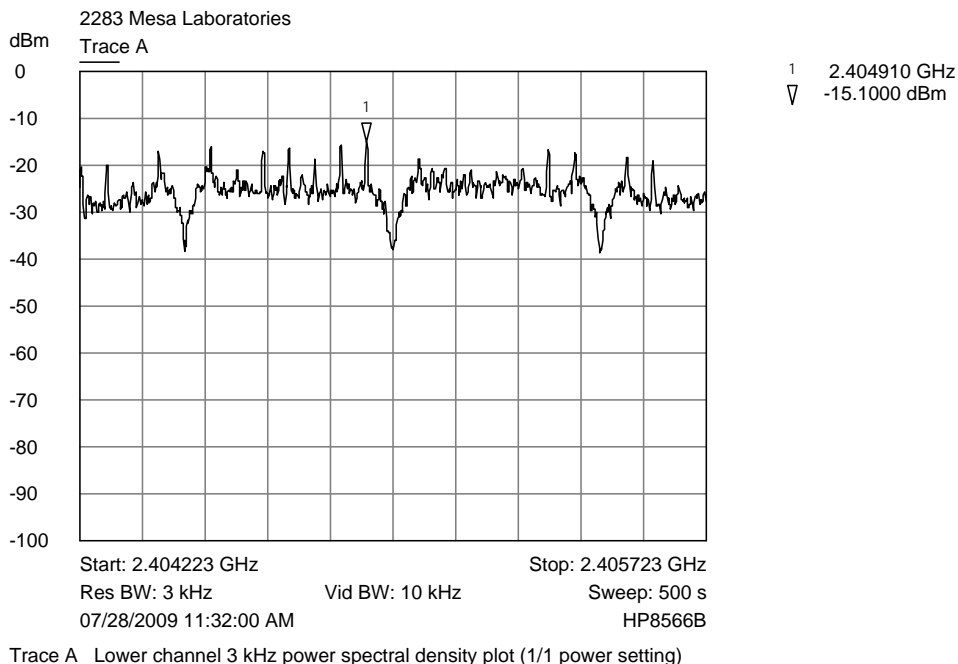

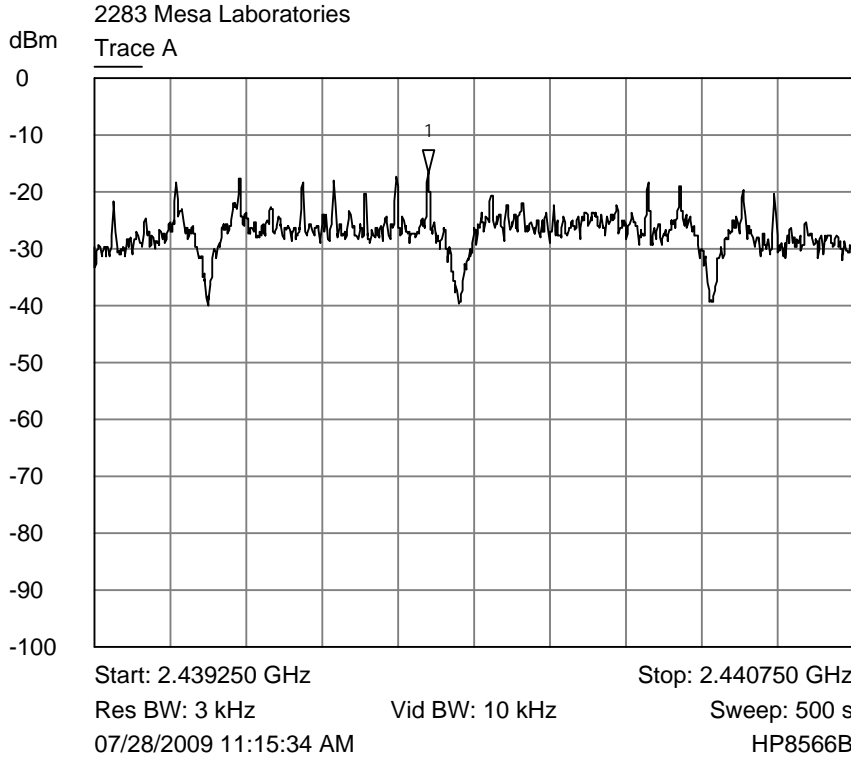

Trace A Middle channel 3 kHz power spectral density plot (1/1 power setting)

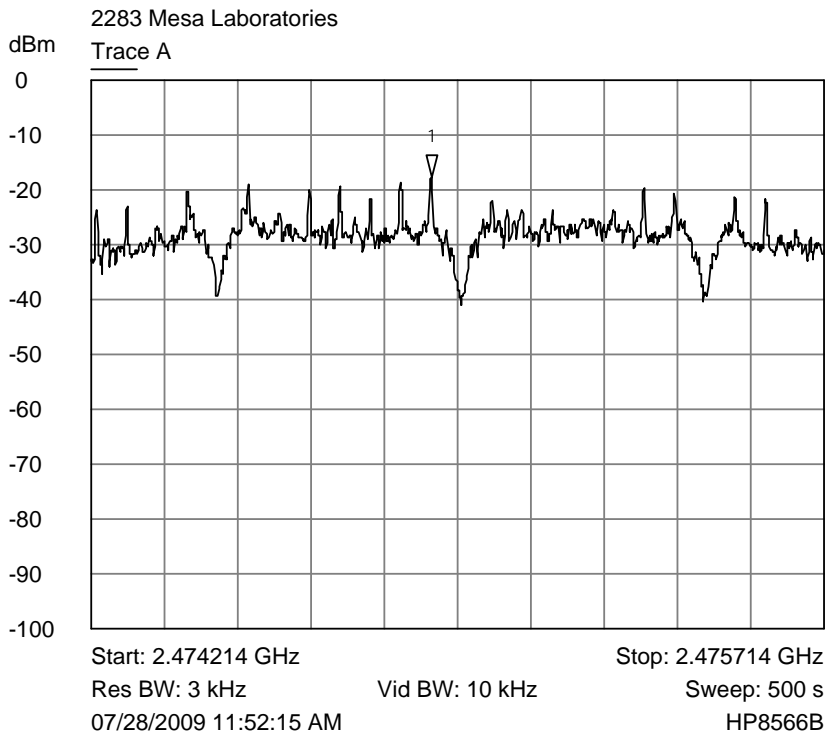

Trace A Upper channel 3 kHz power spectral density plot (1/1 power setting)

APPENDIX 1 TEST PROCEDURES AND TEST EQUIPMENT**§15.207 Conducted Disturbance at the AC Mains**

The conducted disturbance at mains ports from the EUT was measured using a spectrum analyzer with a quasi-peak adapter for peak, quasi-peak and average readings. The quasi-peak adapter uses a bandwidth of 9 kHz, with the spectrum analyzer's resolution bandwidth set at 100 kHz, for readings in the 150 kHz to 30 MHz frequency ranges.

The conducted disturbance at mains ports measurements are performed in a screen room using a (50 Ω /50 μ H) Line Impedance Stabilization Network (LISN).

Where mains flexible power cords are longer than 1 m, the excess cable is folded back and forth as far as possible so as to form a bundle not exceeding 0.4 m in length.

Where the EUT is a collection of equipment with each device having its own power cord, the point of connection for the LISN is determined from the following rules:

- a) Each power cord, which is terminated in a mains supply plug, shall be tested separately.
- b) Power cords, which are not specified by the manufacturer to be connected via a host unit, shall be tested separately.
- c) Power cords which are specified by the manufacturer to be connected via a host unit or other power supplying equipment shall be connected to that host unit and the power cords of that host unit connected to the LISN and tested.
- d) Where a special connection is specified, the necessary hardware to effect the connection is supplied by the manufacturer for the testing purpose.
- e) When testing equipment with multiple mains cords, those cords not under test are connected to an artificial mains network (AMN) different than the AMN used for the mains cord under test.

For AC mains port testing the desktop EUT are placed on a non-conducting table at least 0.8 meters from the metallic floor. The equipment is placed a minimum of 40 cm from all walls. Floor standing equipment is placed directly on the earth grounded floor.

Type of Equipment	Manufacturer	Model Number	Serial Number	Date of Last Calibration
Wanship Open Area Test Site #2	CCL	N/A	N/A	10/08/2008
Test Software	CCL	Conducted Emissions	Revision 1.2	N/A
Spectrum Analyzer	Hewlett Packard	8566B	2230A01711	10/31/2008
Quasi-Peak Detector	Hewlett Packard	85650A	2043A00137	11/05/2008
LISN	EMCO	3825/2	9305-2099	03/09/2009
Conductance Cable Wanship Site #2	CCL	Cable J	N/A	12/31/2008
Transient Limiter	Hewlett Packard	11947A	3107A02266	12/31/2008

An independent calibration laboratory or CCL personnel calibrates all the equipment listed above at intervals defined in ANSI C63.4:2003 Section 4.4 following outlined calibration procedures. All measurement instrumentation is traceable to the National Institute of Standards and Technology (NIST). Supporting documentation relative to tractability is on file and is available for examination upon request.

Conducted Emissions Test Setup

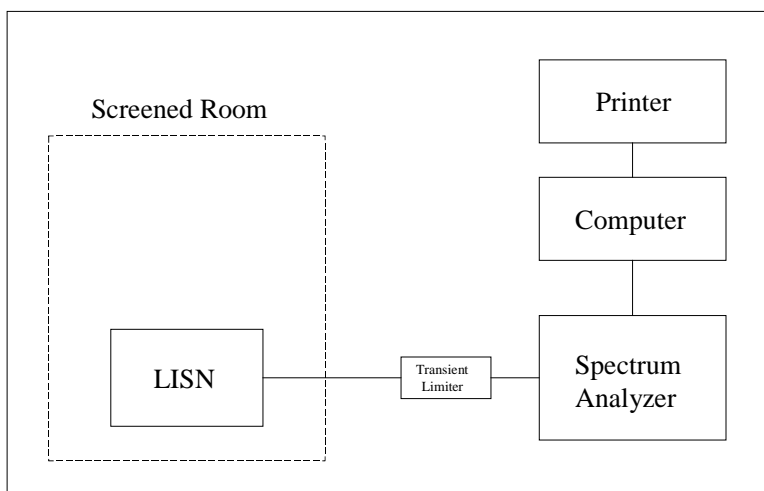

§15.247(a)(2) Emission Bandwidth

The EUT was directly connected to the spectrum analyzer via the antenna output port as shown in the block diagram below.

The measurements were performed on three channels, as per 47 CFR 15.31(m), one near the bottom of the spectrum, one near the middle of the spectrum and one near the top of the spectrum.

The spectrum analyzer's resolution bandwidth and video bandwidth were set as follows:

RBW = 100 kHz
VBW = 300 kHz

Type of Equipment	Manufacturer	Model Number	Serial Number
Spectrum Analyzer	Hewlett Packard	8566B	2230A01711
Quasi-Peak Detector	Hewlett Packard	85650A	2043A00137
Low Loss Cable (1 dB)	N/A	N/A	N/A

An independent calibration laboratory or CCL personnel calibrates all the equipment listed above at intervals defined in ANSI C63.4:2003 Section 4.4 following outlined calibration procedures. All measurement instrumentation is traceable to the National Institute of Standards and Technology (NIST). Supporting documentation relative to tractability is on file and is available for examination upon request.

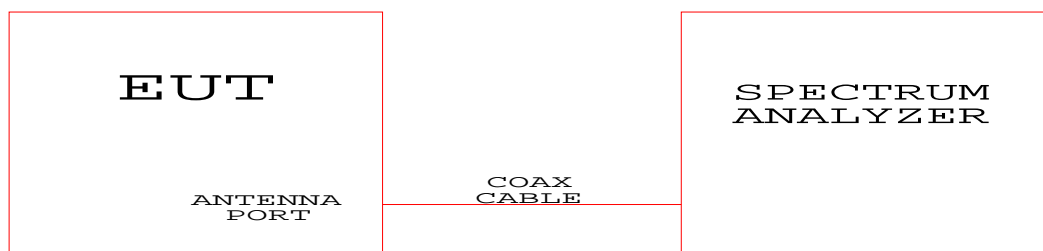
Test Configuration Block Diagram

§15.247(b)(3) Peak Output Power

The EUT was directly connected to the spectrum analyzer via the antenna output port as shown in the block diagram below.

The measurements were performed on three channels, as per 47 CFR 15.31(m), one near the bottom of the spectrum, one near the middle of the spectrum and one near the top of the spectrum.

The spectrum analyzer's resolution bandwidth and video bandwidth were set as follows:

RBW = 3 MHz

VBW = 3 MHz

Type of Equipment	Manufacturer	Model Number	Serial Number
Spectrum Analyzer	Hewlett Packard	8566B	2230A01711
Quasi-Peak Detector	Hewlett Packard	85650A	2043A00137
Low Loss Cable (1 dB)	N/A	N/A	N/A

An independent calibration laboratory or CCL personnel calibrates all the equipment listed above at intervals defined in ANSI C63.4:2003 Section 4.4 following outlined calibration procedures. All measurement instrumentation is traceable to the National Institute of Standards and Technology (NIST). Supporting documentation relative to tractability is on file and is available for examination upon request.

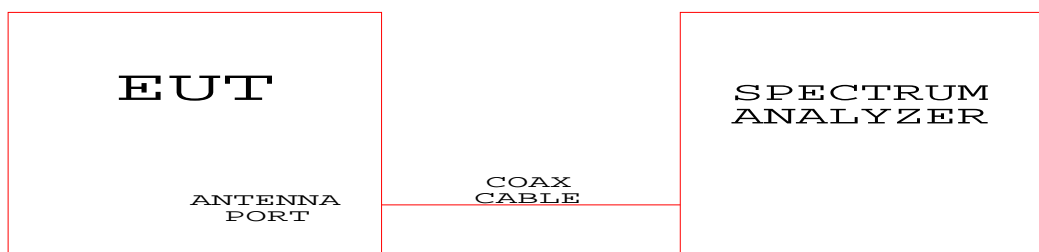
Test Configuration Block Diagram

§15.247(c) Conducted Spurious Emissions

The EUT was directly connected to the spectrum analyzer via the antenna output port as shown in the block diagram below.

The measurements were performed on three channels, as per 47 CFR 15.31(m), one near the bottom of the spectrum, one near the middle of the spectrum and one near the top of the spectrum.

The spectrum analyzer's resolution bandwidth and video bandwidth were set as follows:

RBW = 100 kHz

VBW = 300 kHz

Type of Equipment	Manufacturer	Model Number	Serial Number
Spectrum Analyzer	Hewlett Packard	8566B	2230A01711
Quasi-Peak Detector	Hewlett Packard	85650A	2043A00137
Low Loss Cable (1 dB)	N/A	N/A	N/A

An independent calibration laboratory or CCL personnel calibrates all the equipment listed above at intervals defined in ANSI C63.4:2003 Section 4.4 following outlined calibration procedures. All measurement instrumentation is traceable to the National Institute of Standards and Technology (NIST). Supporting documentation relative to tractability is on file and is available for examination upon request.

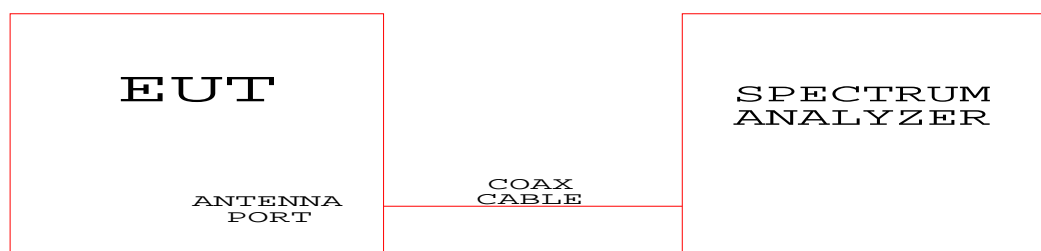
Test Configuration Block Diagram

§15.247(c) Radiated Spurious Emissions in the Restricted Bands

The radiated emissions from the intentional radiator were measured using a spectrum analyzer with a quasi-peak adapter for peak and quasi-peak readings. An amplifier and preamplifier were used to increase the sensitivity of the measuring instrumentation. The quasi-peak adapter uses a bandwidth of 120 kHz, with the spectrum analyzer's resolution bandwidth set at 1 MHz, for readings in the 30 to 1000 MHz frequency ranges. For peak emissions above 1000 MHz the spectrum analyzer's resolution bandwidth was set to 1 MHz and the video bandwidth was set to 3 MHz. For average emissions above 1000 MHz the spectrum analyzer's resolution bandwidth was set to 1 MHz and the video bandwidth was set to 10 Hz.

A biconilog antenna was used to measure the frequency range of 30 to 1000 MHz and a Double Ridge Guide Horn antenna was used to measure the frequency range of 1 GHz to 18 GHz, and a Pyramidal Horn antenna was used to measure the frequency range of 18 GHz to 25 GHz, at a distance of 3 meters from the EUT. The readings obtained by these antennas are correlated to the levels obtained with a tuned dipole antenna by adding antenna factors.

The configuration of the intentional radiator was varied to find the maximum radiated emission. The intentional radiator was connected to the peripherals listed in Section 2.4 via the interconnecting cables listed in Section 2.5. These interconnecting cables were manipulated manually by a technician to obtain worst case radiated emissions. The intentional radiator was rotated 360 degrees, and the antenna height was varied from 1 to 4 meters to find the maximum radiated emission. Where there are multiple interface ports all of the same type, cables are either placed on all of the ports or cables added to these ports until the emissions do not increase by more than 2 dB.

Desktop intentional radiators are measured on a non-conducting table 80 centimeters above the ground plane. The table is placed on a turntable which is level with the ground plane. The turntable has slip rings, which supply AC power to the intentional radiator. For equipment normally placed on floors, the equipment shall be placed directly on the turntable.

Type of Equipment	Manufacturer	Model Number	Serial Number	Date of Last Calibration
Wanship Open Area Test Site #2	CCL	N/A	N/A	10/08/2008
Test Software	CCL	Radiated Emissions	Revision 1.3	N/A

Type of Equipment	Manufacturer	Model Number	Serial Number	Date of Last Calibration
Spectrum Analyzer/Receiver	Rohde & Schwarz	1302.6005.40	100064	07/08/2009
Spectrum Analyzer	Hewlett Packard	8566B	2230A01711	10/31/2008
Quasi-Peak Detector	Hewlett Packard	85650A	2043A00137	11/05/2008
Biconilog Antenna	EMCO	3142	9601-1008	9/26/2008
Double Ridged Guide Antenna	EMCO	3115	9409-4355	03/11/2009
High Frequency Amplifier	Miteq	AFS4-01001800-43-10P-4	1096455	06/04/2009
20' High Frequency Cable	Utiflex	UFA210A-1-2400-30050U	1175	03/05/2009
3 Meter Radiated Emissions Cable Wanship Site #2	CCL	Cable K	N/A	12/31/2008
Pre/Power-Amplifier	Hewlett Packard	8447F	3113A05161	08/28/2008
6 dB Attenuator	Hewlett Packard	8491A	32835	12/31/2008

An independent calibration laboratory or CCL personnel calibrates all the equipment listed above at intervals defined in ANSI C63.4:2003 Section 4.4 following outlined calibration procedures. All measurement instrumentation is traceable to the National Institute of Standards and Technology (NIST). Supporting documentation relative to tractability is on file and is available for examination upon request.

Radiated Emissions Test Setup

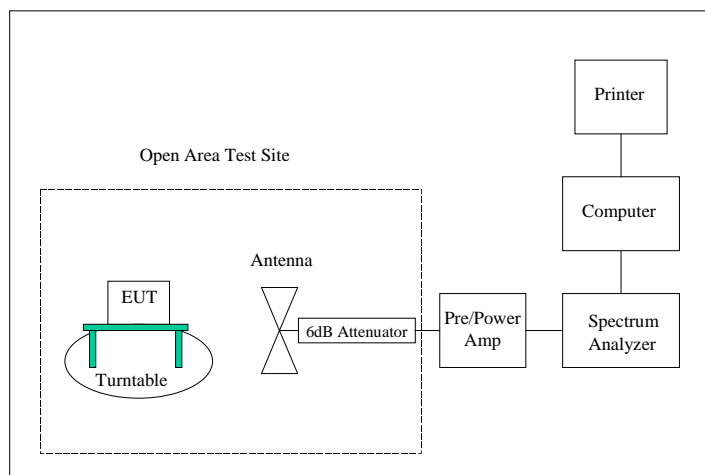

§15.247(d) Peak Power Spectral Density

The EUT was directly connected to the spectrum analyzer via the antenna output port as shown in the block diagram below.

The measurements were performed on three channels, as per 47 CFR 15.31(m), one near the bottom of the spectrum, one near the middle of the spectrum and one near the top of the spectrum.

The spectrum analyzer's resolution bandwidth and video bandwidth were set as follows:

RBW = 3 kHz
VBW = 10 kHz

Type of Equipment	Manufacturer	Model Number	Serial Number
Spectrum Analyzer	Hewlett Packard	8566B	2230A01711
Quasi-Peak Detector	Hewlett Packard	85650A	2043A00137
Low Loss Cable (1 dB)	N/A	N/A	N/A

An independent calibration laboratory or CCL personnel calibrates all the equipment listed above at intervals defined in ANSI C63.4:2003 Section 4.4 following outlined calibration procedures. All measurement instrumentation is traceable to the National Institute of Standards and Technology (NIST). Supporting documentation relative to tractability is on file and is available for examination upon request.

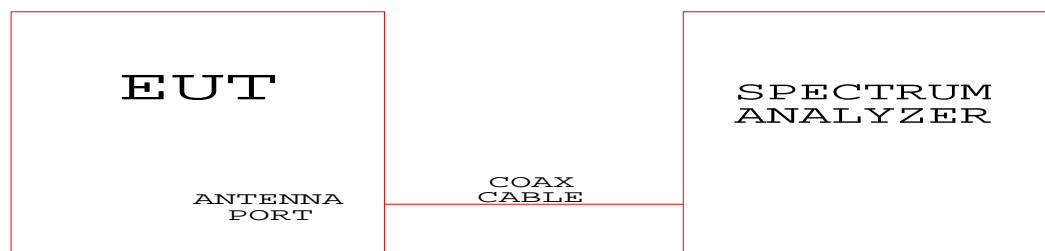
Test Configuration Block Diagram

APPENDIX 2 PHOTOGRAPHS

Photograph 1 - Front View Radiated Spurious Worst Case Configuration - DTENV-H



Photograph 2 - Back View Radiated Spurious Worst Case Configuration - DTENV-H



Photograph 3 - Front View Radiated Spurious Worst-Case Configuration - DTENV-R



Photograph 4 - Back View Radiated Spurious Worst-Case Configuration - DTENV-R

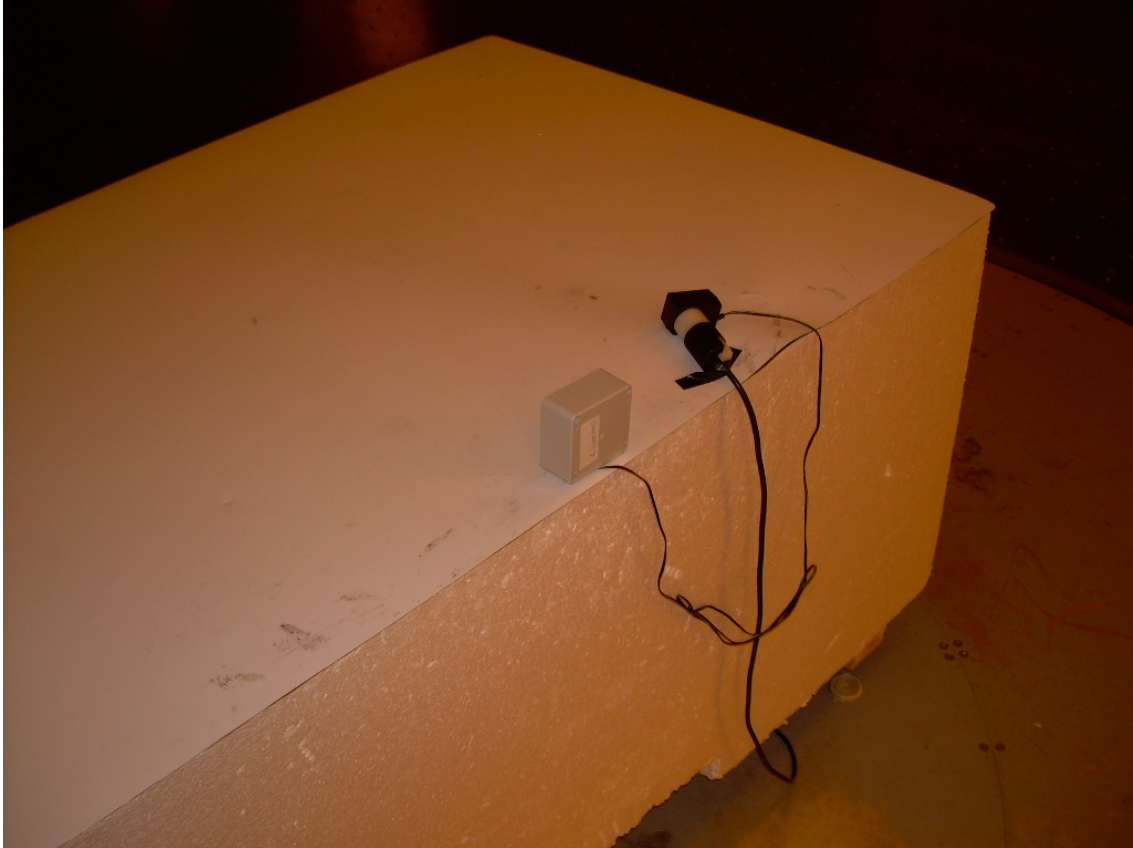

Photograph 5 - Front View Conducted Disturbance Configuration -
DTENV-R



Photograph 6 - Back View Conducted Disturbance Configuration -
DTENV-R



Photograph 7 - Front View Conducted Disturbance Configuration -
DTENV-H



Photograph 8 - Back View Conducted Disturbance Configuration -
DTENV-H



Photograph 9 - Top View of the DTENV-H

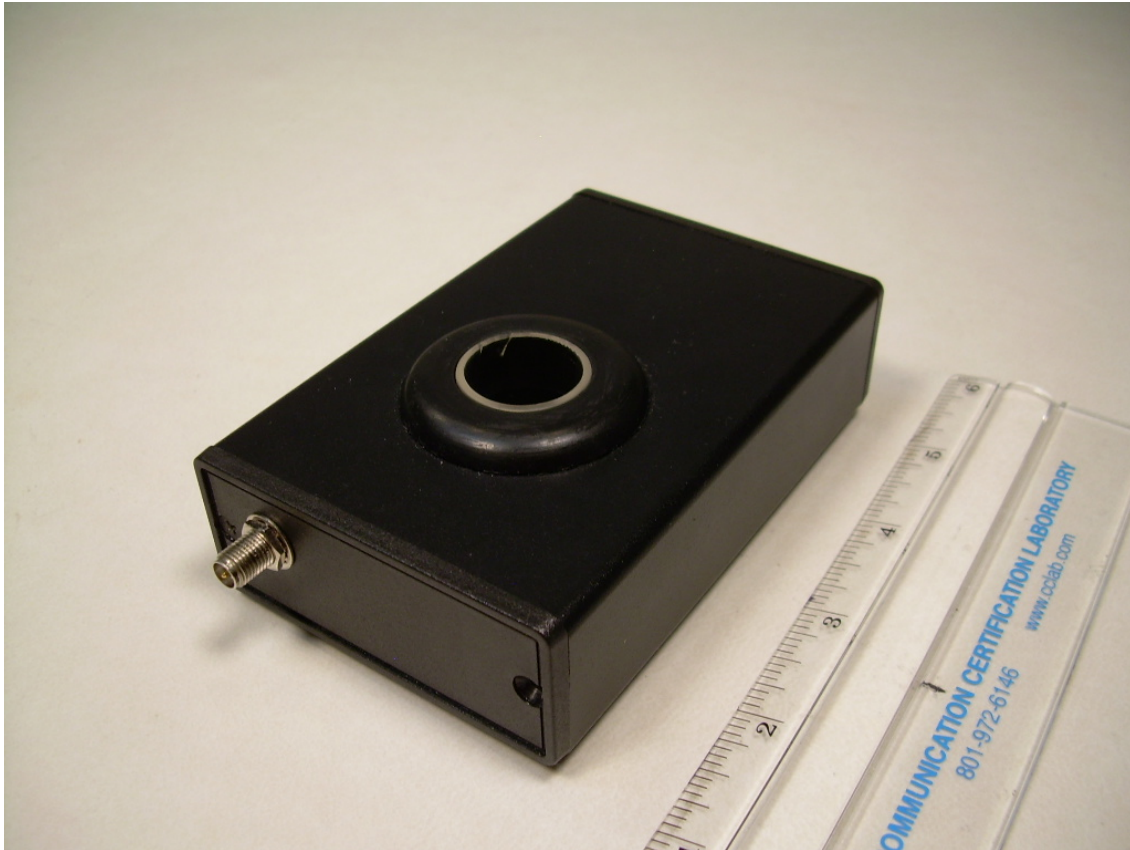

Photograph 10 - Bottom View of the DTENV-H



Photograph 11 - Component Side of the Main PCB of the DTENV-H



Photograph 12 - Component Side of the Main PCB of the DTENV-H
with Reflector Removed

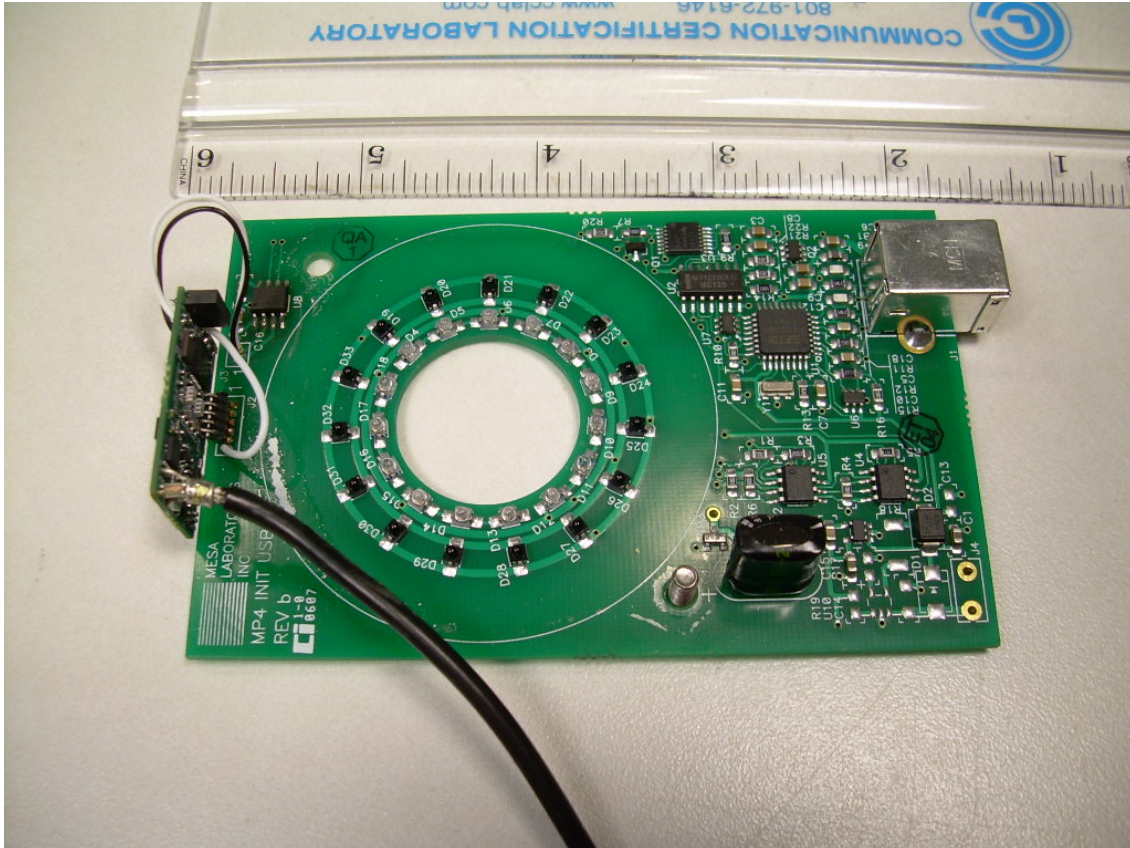

Photograph 13 - Trace Side of the Main PCB of the DTENV-H

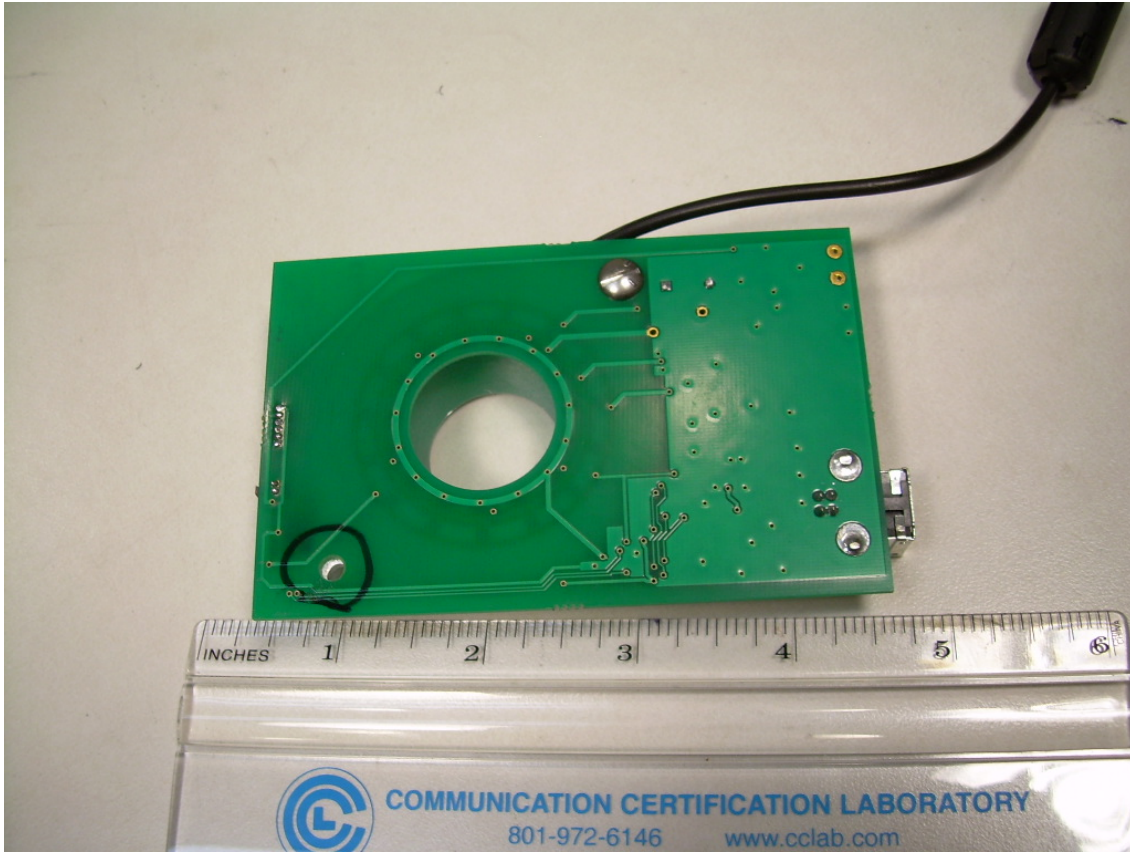

Photograph 14 - Placement of the Transceiver PCB in the DTENV-H

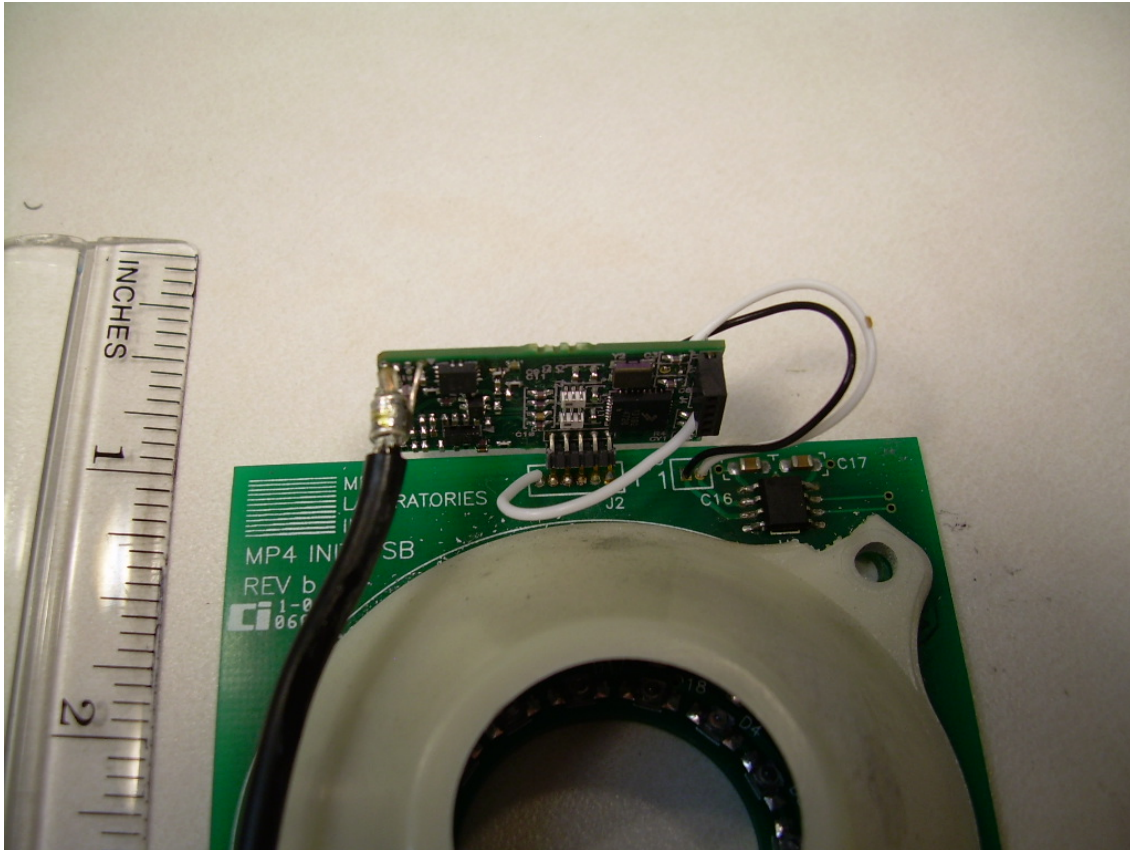

Photograph 15 - Top Side of the Transceiver PCB

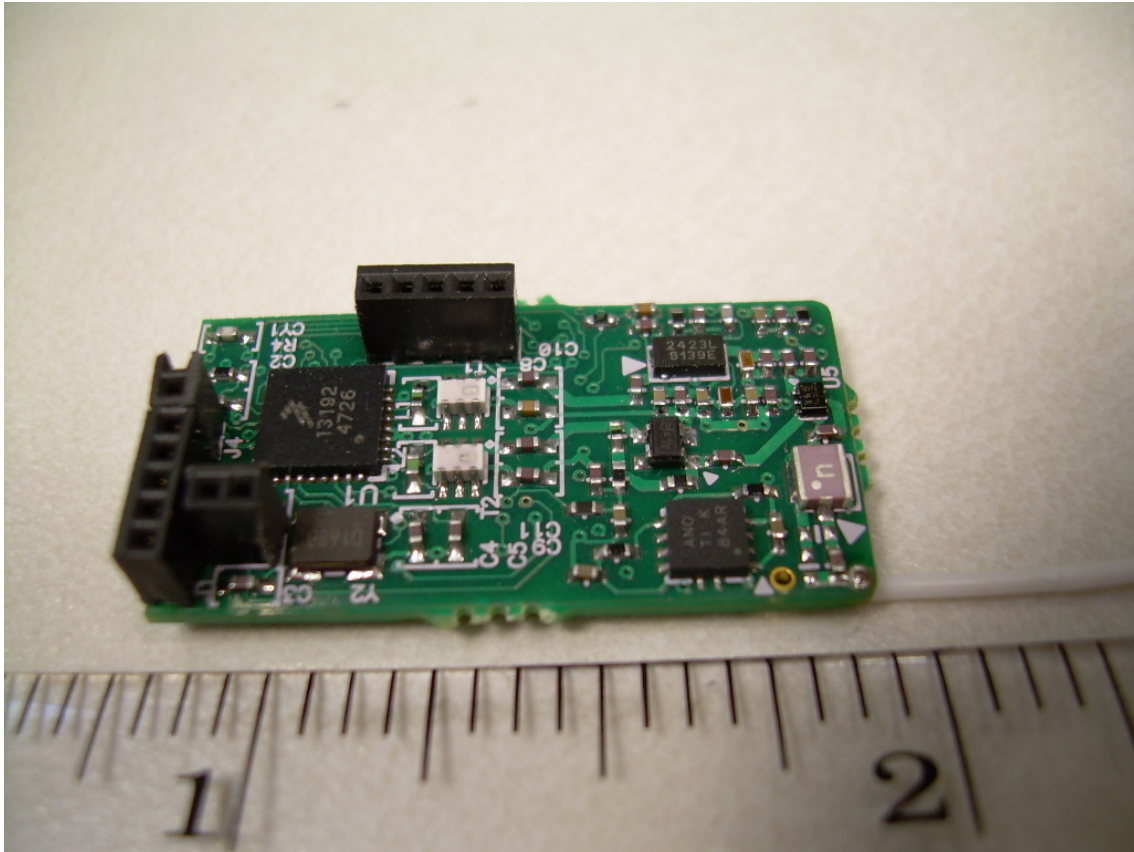

Photograph 16 - Bottom Side of the Transceiver PCB

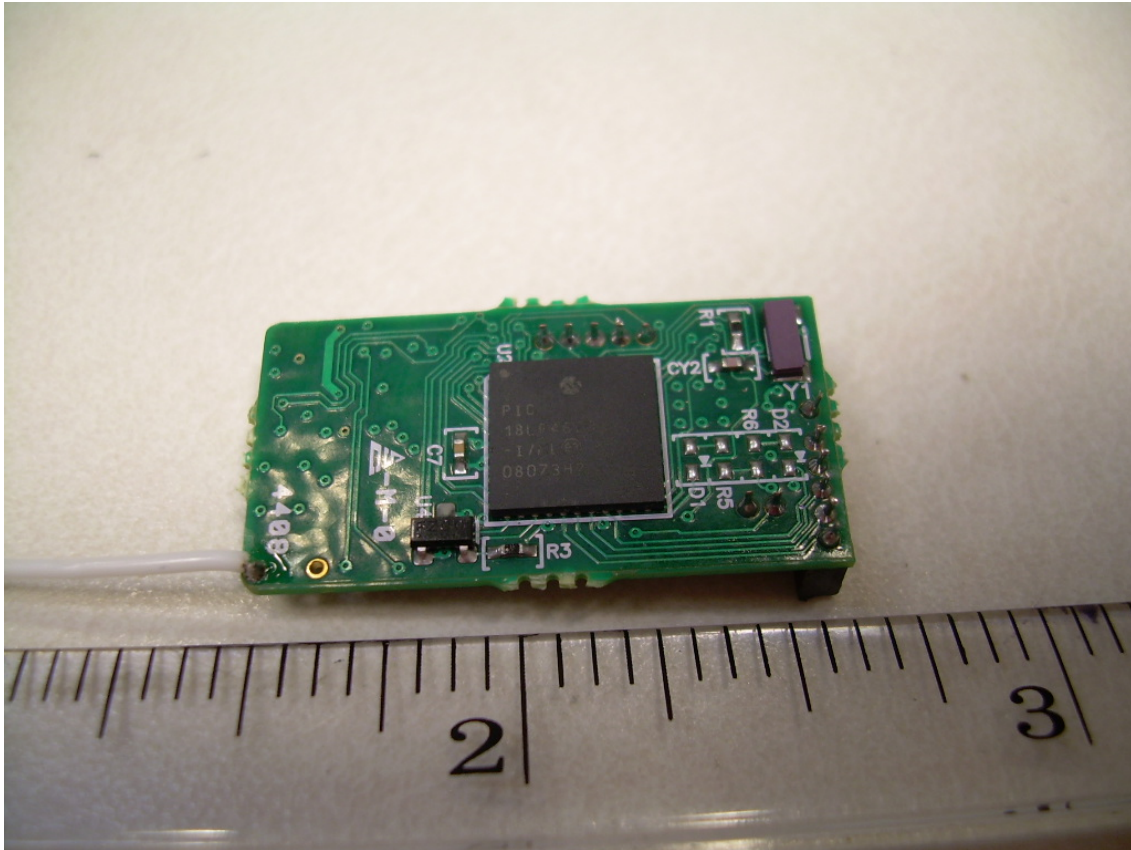

Photograph 17 - Front View of the DTENV-R

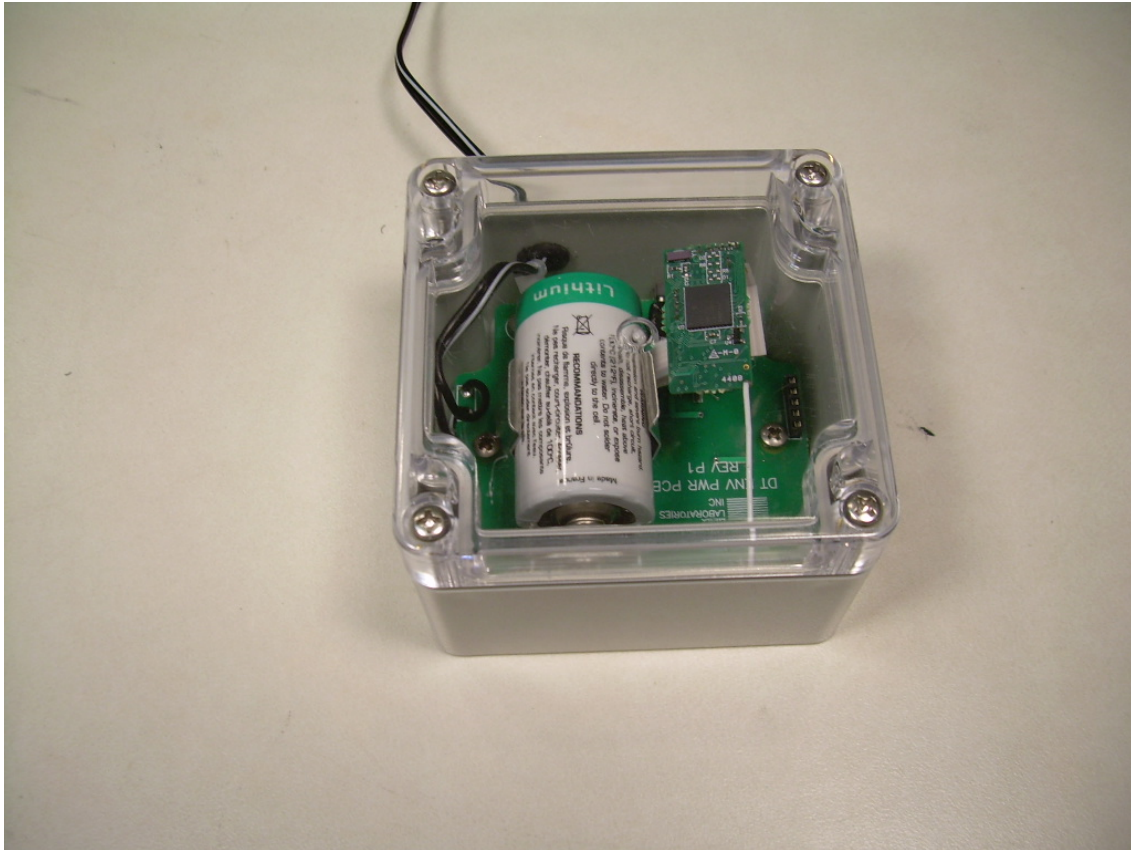

Photograph 18 - View of the DTEVN-R with the Plastic Cover and Battery Removed

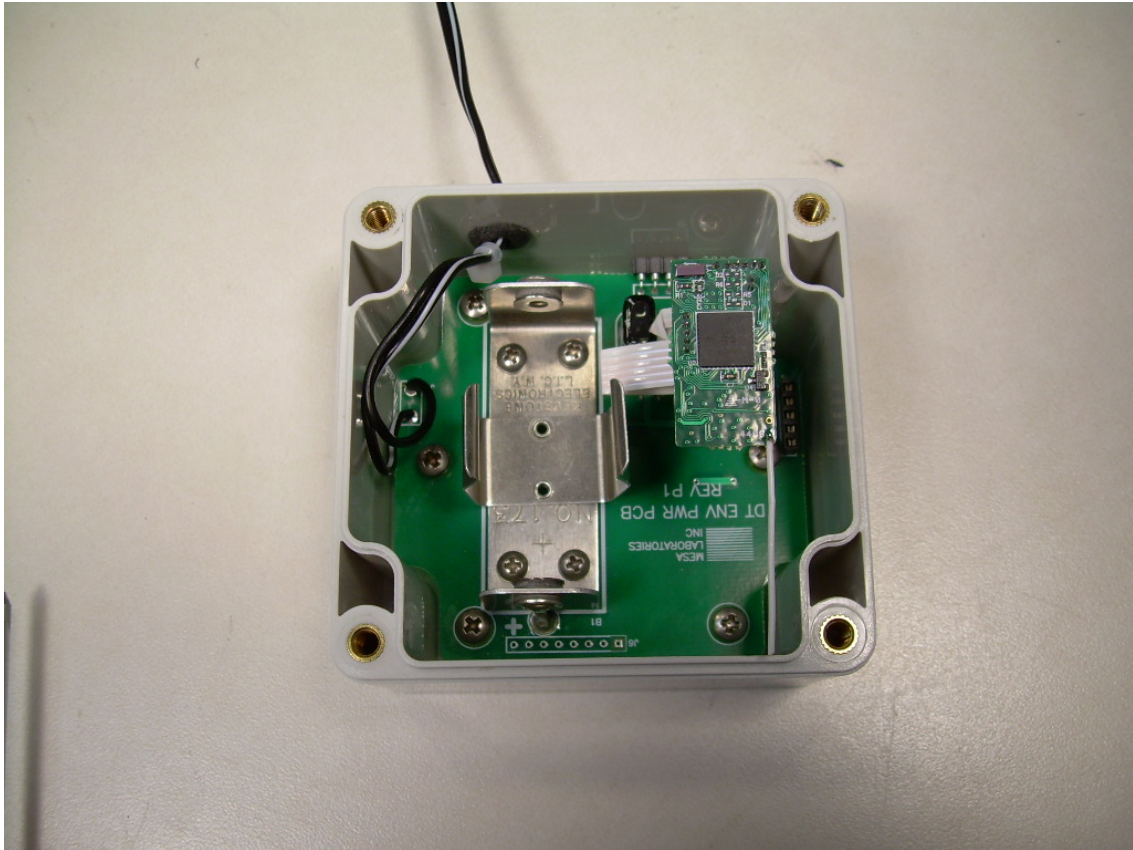

Photograph 19 - Back View of the DTENV-R

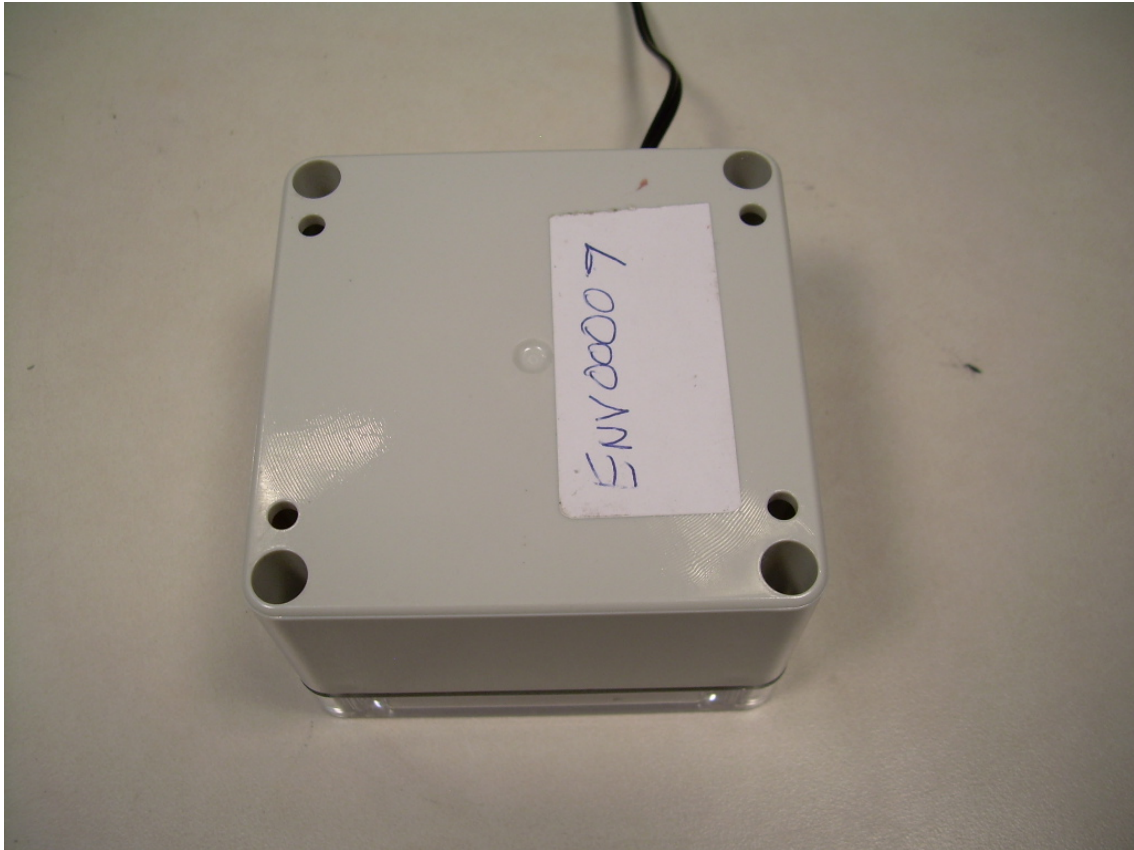

Photograph 20 - Top Side of the Main PCB of the DTENV-R

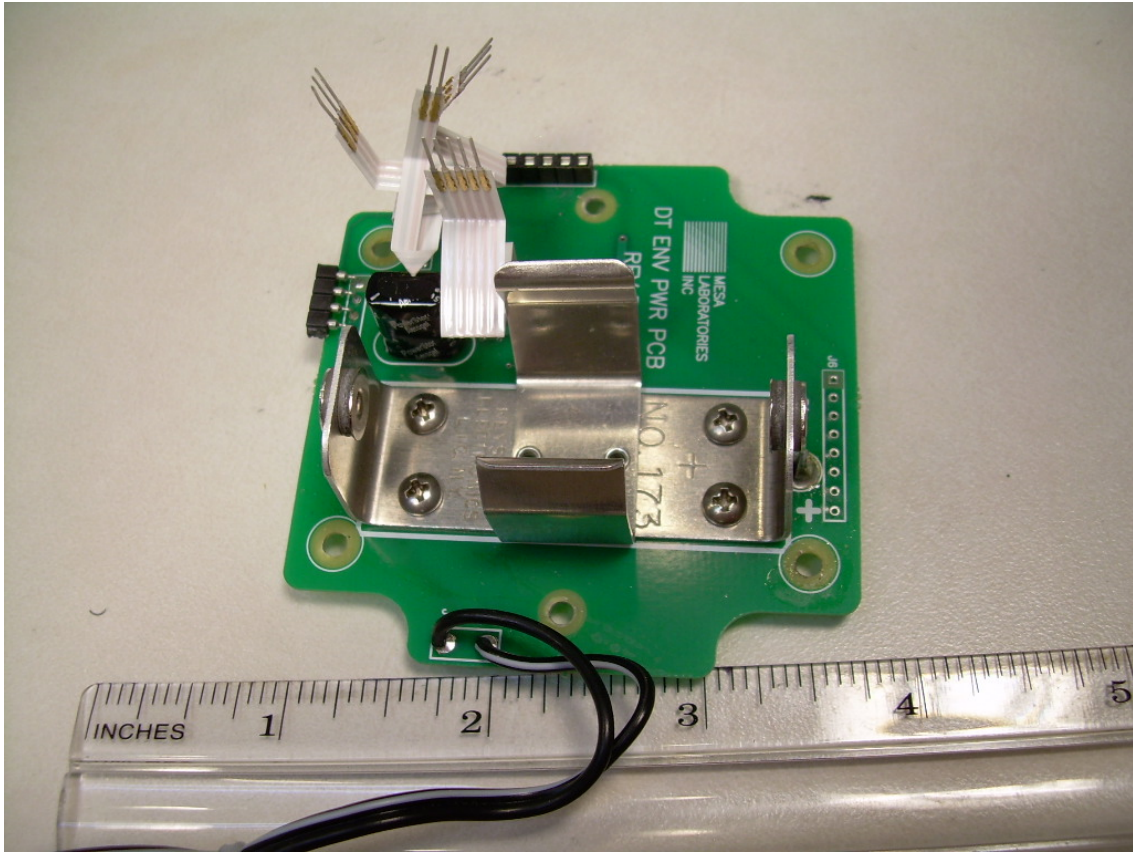

Photograph 21 - Bottom Side of the Main PCB of the DTENV-R

