



# TEST REPORT

Report No. .... : **CHTEW21110111** Report verification: 

Project No..... : **SHT2110065802EW**

FCC ID..... : **UU8-TW25**

Applicant's name ..... : **Lexibook America**

Address..... : **C/O NATXIX PRAMEX INTERNATIONAL-NORTH AMERICA  
1251 Avenue of the Americas 34th Floor, New York, NY 10020  
United States**

Test item description ..... : **Walkie-talkies**

Trade Mark ..... : **LEXIBOOK**

Model/Type reference..... : **TW25UNI**

Listed Model(s) ..... : **TW25, TW25X(X represents different shell colors and markets)**

Standard ..... : **FCC 47 CFR Part2.1093  
IEEE Std C95.1, 1999 Edition  
IEEE 1528: 2013**

Date of receipt of test sample..... : **Oct.26, 2021**

Date of testing..... : **Oct.27, 2021- Nov.08, 2021**

Date of issue..... : **Nov.09, 2021**

Result..... : **PASS**

Compiled by  
 ( Position+Printed name+Signature): File administrator Fanghui Zhu 

Supervised by  
 ( position+printed name+signature)...: Test Engineer: Patrick Qiu 

Approved by  
 ( position+printed name+signature)...: Manager: Hans Hu 

Testing Laboratory Name ..... : **Shenzhen Huatongwei International Inspection Co., Ltd**

Address..... : **1/F, Bldg 3, Hongfa Hi-tech Industrial Park, Genyu Road,  
Tianliao, Gongming, Shenzhen, China**

**Shenzhen Huatongwei International Inspection Co., Ltd. All rights reserved.**

This publication may be reproduced in whole or in part for non-commercial purposes as long as the Shenzhen Huatongwei International Inspection Co., Ltd is acknowledged as copyright owner and source of the material. Shenzhen Huatongwei International Inspection Co., Ltd takes no responsibility for and will not assume liability for damages resulting from the reader's interpretation of the reproduced material due to its placement and context.

*The test report merely correspond to the test sample.*

## Contents

<u>1.</u>	<u>Statement of Compliance</u>	<u>3</u>
<u>2.</u>	<u>Test Standards and Report version</u>	<u>4</u>
2.1.	Test Standards	4
2.2.	Report version	4
<u>3.</u>	<u>Summary</u>	<u>5</u>
3.1.	Client Information	5
3.2.	Product Description	5
3.3.	Radio Specification Description	5
3.4.	Test frequency list	6
3.5.	Testing Laboratory Information	7
3.6.	Environmental conditions	7
<u>4.</u>	<u>Equipments Used during the Test</u>	<u>8</u>
<u>5.</u>	<u>Measurement Uncertainty</u>	<u>9</u>
<u>6.</u>	<u>SAR Measurements System Configuration</u>	<u>10</u>
6.1.	SAR Measurement Set-up	10
6.2.	DASY5 E-field Probe System	11
6.3.	Phantoms	12
6.4.	Device Holder	12
<u>7.</u>	<u>SAR Test Procedure</u>	<u>13</u>
7.1.	Scanning Procedure	13
7.2.	Data Storage and Evaluation	15
<u>8.</u>	<u>Position of the wireless device in relation to the phantom</u>	<u>17</u>
8.1.	Front-of-face	17
8.2.	Body Position	17
<u>9.</u>	<u>Dielectric Property Measurements &amp; System Check</u>	<u>18</u>
9.1.	Tissue Dielectric Parameters	18
9.2.	SAR System Validation	19
9.3.	System Check	20
<u>10.</u>	<u>SAR Exposure Limits</u>	<u>23</u>
<u>11.</u>	<u>Radiated Power Measurement Results and Tune-up</u>	<u>23</u>
<u>12.</u>	<u>SAR Measurement Results</u>	<u>23</u>
<u>13.</u>	<u>Test Setup Photos</u>	<u>24</u>
<u>14.</u>	<u>External and Internal Photos of the EUT</u>	<u>24</u>

## 1. Statement of Compliance

Maximum Reported SAR (W/kg @1g)	
RF Exposure Conditions	FRF
Head(Dist.= 25mm)	0.013
Body-worn(Dist.= 0mm)	0.031

This device is in compliance with Specific Absorption Rate (SAR) for general population/uncontrolled exposure limits (1.6 W/kg) specified in FCC 47 CFR part 2 (2.1093) and ANSI/IEEE C95.1-1992, and had been tested in accordance with the measurement methods and procedures specified in IEEE 1528-2013 and FCC KDB publications.

## 2. Test Standards and Report version

### 2.1. Test Standards

The tests were performed according to following standards:

[FCC 47 Part 2.1093](#): Radiofrequency Radiation Exposure Evaluation:Portable Devices

[IEEE Std C95.1, 1999 Edition](#): IEEE Standard for Safety Levels with Respect to Human Exposure to Radio Frequency Electromagnetic Fields, 3 kHz to 300 GHz

[IEEE Std 1528™-2013](#): IEEE Recommended Practice for Determining the Peak Spatial-Average Specific Absorption Rate (SAR) in the Human Head from Wireless Communications Devices: Measurement Techniques.

FCC published RF exposure KDB procedures:

[KDB 865664 D01 SAR Measurement 100 MHz to 6 GHz v01r04](#): SAR Measurement Requirements for 100 MHz to 6 GHz

[KDB 865664 D02 RF Exposure Reporting v01r02](#): RF Exposure Compliance Reporting and Documentation Considerations

[KDB 447498 D01 General RF Exposure Guidance v06](#): Mobile and Portable Device RF Exposure Procedures and Equipment Authorization Policies

[TCB workshop](#): April, 2019; Page 19, Tissue Simulating Liquids (TSL)

### 2.2. Report version

Revision No.	Date of issue	Description
N/A	2021-11-09	Original

### 3. Summary

#### 3.1. Client Information

Applicant:	Lexibook America
Address:	C/O NATXIX PRAMEX INTERNATIONAL-NORTH AMERICA 1251 Avenue of the Americas 34th Floor, New York, NY 10020 United States
Manufacturer:	LEXBOOK LIMITED
Address:	Unit 8-9,4th Floor,Kenning Industrial Bulding,19 Wang Hol Road,Kowloon Bay,Kowloon,Hong Kong
Factory:	DONNGGUAN NEW RESEARCH INTO ELECTRONIC CO., LTD
Address:	DONGGUAN SHIQIAO TOWN XINCHENG ROAD BUSINESS STREET

#### 3.2. Product Description

Main unit	
Name of EUT:	Walkie-talkies
Trade mark:	LEXIBOOK
Model/Type reference:	TW25UNI
Listed model(s):	TW25, TW25X(X represents different shell colors and markets)
Device Category:	Portable
RF Exposure Environment:	General Population/Uncontrolled
Power supply:	DC 4.5V
HTW test sample No.:	YPHT21100658001
Hardware version:	80-6371A2
Software version:	25_CE7555
Device Dimension:	Overall (Length x Width x Thickness): 105X75X30 mm Antenna(Length): 65mm

#### 3.3. Radio Specification Description

Operation Frequency Range:	462.5625MHz;462.7125MHz	
Rated Output Power:	<input checked="" type="checkbox"/> Power: 17dbm	<input type="checkbox"/>
Modulation Type:	FM	
Channel Bandwidth:	12.5kHz	
Antenna Type:	Helical Antenna	
Remark:	<p>1. The EUT battery must be fully charged and checked periodically during the test to ascertain uniform power.</p> <p>2. The maximum duty cycle supported by the device is 50%.</p>	

### 3.4. Test frequency list

When the frequency channels required for SAR testing are not specified in the published RF exposure KDB procedures, the following should be applied to determine the number of required test channels. The test channels should be evenly spread across the transmission frequency band of each wireless mode:

$$N_c = \text{Round}\left\{\left[100\left(f_{\text{high}} - f_{\text{low}}\right)/f_c\right]^{0.5} \times \left(f_c/100\right)^{0.2}\right\},$$

$N_c$  is the number of test channels, rounded to the nearest integer,  
 $f_{\text{high}}$  and  $f_{\text{low}}$  are the highest and lowest channel frequencies within the transmission band,  
 $f_c$  is the mid-band channel frequency,  
 all frequencies are in MHz.

Modulation Type	Channel Bandwidth	Test Channel	Test Frequency(MHz)
			TX
Analog	12.5kHz	CH1	462.5625
		CH2	462.7125

### 3.5. Testing Laboratory Information

Laboratory Name	Shenzhen Huatongwei International Inspection Co., Ltd.	
Laboratory Location	1/F, Bldg 3, Hongfa Hi-tech Industrial Park, Genyu Road, Tianliao, Gongming, Shenzhen, China	
Connect information:	Tel: 86-755-26715499 E-mail: <a href="mailto:cs@szhtw.com.cn">cs@szhtw.com.cn</a> <a href="http://www.szhtw.com.cn">http://www.szhtw.com.cn</a>	
Qualifications	Type	Accreditation Number
	FCC	762235

### 3.6. Environmental conditions

During the measurement the environmental conditions were within the listed ranges:

Ambient temperature	18 °C to 25 °C
Ambient humidity	30%RH to 70%RH
Air Pressure	950-1050mbar

#### 4. Equipments Used during the Test

Used	Test Equipment	Manufacturer	Model No.	Serial No.	Cal. date (YY-MM-DD)	Due date (YY-MM-DD)
●	Data Acquisition Electronics DAEx	SPEAG	DAE4	1549	2021/03/23	2022/03/22
●	E-field Probe	SPEAG	EX3DV4	3842	2021/01/25	2022/01/24
○	Universal Radio Communication Tester	R&S	CMW500	137681	2021/05/27	2022/05/26
● Tissue-equivalent liquids Validation						
●	Dielectric Assessment Kit	SPEAG	DAK-3.5	1267	N/A	N/A
○	Dielectric Assessment Kit	SPEAG	DAK-12	1130	N/A	N/A
●	Network analyzer	Keysight	E5071C	MY46733048	2021/09/17	2022/09/16
● System Validation						
○	System Validation Antenna	SPEAG	CLA-150	4024	2021/01/25	2024/01/24
●	System Validation Dipole	SPEAG	D450V3	1102	2021/01/20	2024/01/19
○	System Validation Dipole	SPEAG	D750V3	1180	2021/01/22	2024/01/21
○	System Validation Dipole	SPEAG	D835V2	4d238	2021/01/22	2024/01/21
○	System Validation Dipole	SPEAG	D1750V2	1164	2021/01/22	2024/01/21
○	System Validation Dipole	SPEAG	D1900V2	5d226	2021/01/22	2024/01/21
○	System Validation Dipole	SPEAG	D2450V2	1009	2021/01/25	2024/01/24
○	System Validation Dipole	SPEAG	D2600V2	1150	2021/01/25	2024/01/24
○	System Validation Dipole	SPEAG	D5GHzV2	1273	2021/01/25	2024/01/24
●	Signal Generator	R&S	SMB100A	114360	2021/08/05	2022/08/04
●	Power Viewer for Windows	R&S	N/A	N/A	N/A	N/A
●	Power sensor	R&S	NRP18A	101010	2021/08/05	2022/08/04
●	Power sensor	R&S	NRP18A	101386	2021/05/27	2022/05/26
●	Power Amplifier	BONN	BLWA 0160-2M	1811887	2020/11/12	2021/11/11
●	Dual Directional Coupler	Mini-Circuits	ZHDC-10-62-S+	F975001814	2020/11/12	2021/11/11
●	Attenuator	Mini-Circuits	VAT-3W2+	1819	2020/11/12	2021/11/11
●	Attenuator	Mini-Circuits	VAT-10W2+	1741	2020/11/12	2021/11/11

**Note:**

1. The Probe, Dipole and DAE calibration reference to the Appendix B and C.
2. Referring to KDB865664 D01, the dipole calibration interval can be extended to 3 years with justification. The dipole are also not physically damaged or repaired during the interval.



## **5. Measurement Uncertainty**

Per KDB 865664 D01 SAR Measurement 100 MHz to 6 GHz, when the highest measured 1-g SAR within a frequency band is  $< 1.5$  W/kg. The expanded SAR measurement uncertainty must be  $\leq 30\%$ , for a confidence interval of  $k = 2$ . If these conditions are met, extensive SAR measurement uncertainty analysis described in IEEE Std 1528-2013 is not required in SAR reports submitted for equipment approval.

Therefore, the measurement uncertainty is not required.

## 6. SAR Measurements System Configuration

### 6.1. SAR Measurement Set-up

The DASY5 system for performing compliance tests consists of the following items:

A standard high precision 6-axis robot (Stäubli RX family) with controller and software. An arm extension for accommodating the data acquisition electronics (DAE).

A dosimetric probe, i.e. an isotropic E-field probe optimized and calibrated for usage in tissue simulating liquid. The probe is equipped with an optical surface detector system.

A data acquisition electronic (DAE) which performs the signal amplification, signal multiplexing, AD-conversion, offset measurements, mechanical surface detection, collision detection, etc. The unit is battery powered with standard or rechargeable batteries. The signal is optically transmitted to the EOC.

A unit to operate the optical surface detector which is connected to the EOC.

The Electro-Optical Coupler (EOC) performs the conversion from the optical into a digital electric signal of the DAE. The EOC is connected to the DASY5 measurement server.

The DASY5 measurement server, which performs all real-time data evaluation for field measurements and surface detection, controls robot movements and handles safety operation. A computer operating Windows 2003.

DASY5 software and SEMCAD data evaluation software.

Remote control with teach panel and additional circuitry for robot safety such as warning lamps, etc.

The generic twin phantom enabling the testing of left-hand and right-hand usage.

The device holder for handheld Mobile Phones.

Tissue simulating liquid mixed according to the given recipes.

System validation dipoles allowing to validate the proper functioning of the system.

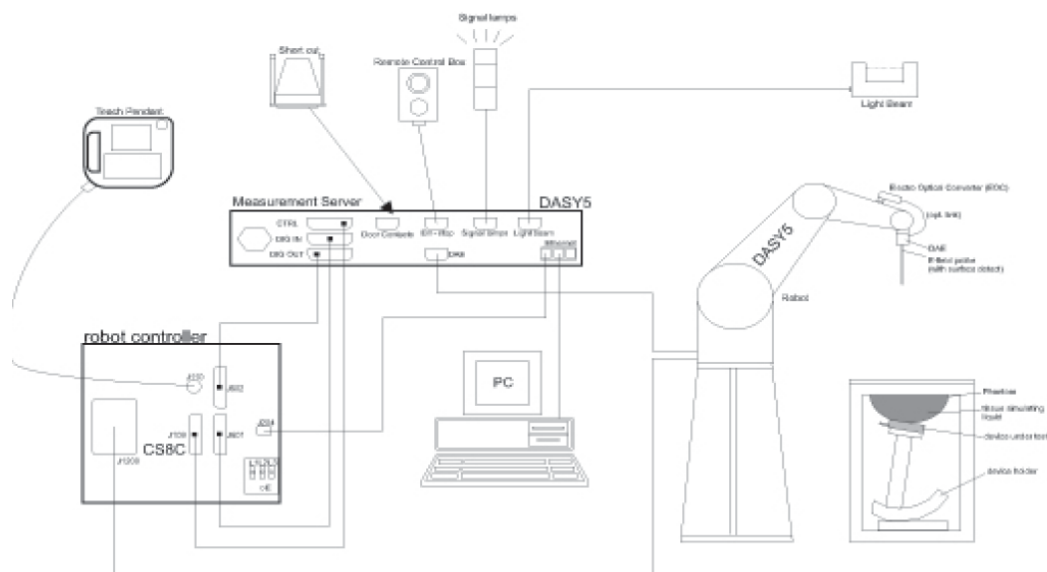

## 6.2. DASY5 E-field Probe System

The SAR measurements were conducted with the dosimetric probe EX3DV4 (manufactured by SPEAG), designed in the classical triangular configuration and optimized for dosimetric evaluation.

### ● Probe Specification

Construction Symmetrical design with triangular core  
 Interleaved sensors  
 Built-in shielding against static charges  
 PEEK enclosure material (resistant to organic solvents, e.g., DGBE)

Calibration ISO/IEC 17025 calibration service available.

Frequency	10 MHz to 10 GHz; Linearity: $\pm 0.2$ dB (30 MHz to 10 GHz)
Directivity	$\pm 0.1$ dB in TSL (rotation around probe axis) $\pm 0.3$ dB in TSL (rotation normal to probe axis)
Dynamic Range	10 $\mu$ W/g to > 100 mW/g; Linearity: $\pm 0.2$ dB
Dimensions	Overall length: 337 mm (Tip: 20 mm) Tip diameter: 2.5 mm (Body: 12 mm) Distance from probe tip to dipole centers: 2.0 mm
Application	General dosimetry up to 10 GHz Dosimetry in strong gradient fields Compliance tests of Mobile Phones
Compatibility	DASY3, DASY4, DASY52 SAR and higher, EASY4/MRI



### ● Isotropic E-Field Probe

The isotropic E-Field probe has been fully calibrated and assessed for isotropicity, and boundary effect within a controlled environment. Depending on the frequency for which the probe is calibrated the method utilized for calibration will change.

The E-Field probe utilizes a triangular sensor arrangement as detailed in the diagram below:

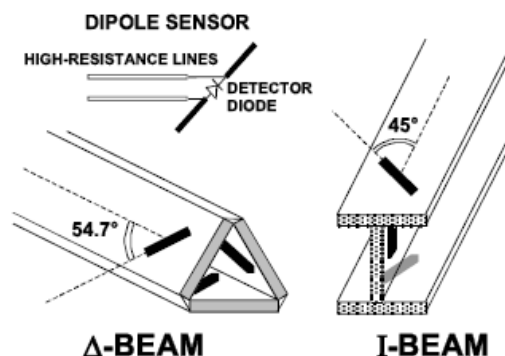

### 6.3. Phantoms

Phantom for compliance testing of handheld and body-mounted wireless devices in the frequency range of 30 MHz to 6 GHz. ELI is fully compatible with standard and all known tissue-simulating liquids. ELI has been optimized regarding its performance and can be integrated into our standard phantom tables. A cover prevents evaporation of the liquid. Reference markings on the phantom allow installation of the complete setup, including all predefined phantom positions and measurement grids, by teaching three points. The phantom is compatible with all SPEAG dosimetric probes and dipoles.



ELI4 Phantom

### 6.4. Device Holder

The device was placed in the device holder (illustrated below) that is supplied by SPEAG as an integral part of the DASY system.

The DASY device holder is designed to cope with the different positions given in the standard. It has two scales for device rotation (with respect to the body axis) and device inclination (with respect to the line between the ear reference points). The rotation centers for both scales is the ear reference point (ERP). Thus the device needs no repositioning when changing the angles.



Device holder supplied by SPEAG

## 7. SAR Test Procedure

### 7.1. Scanning Procedure

#### Step 1: Power Reference Measurement

The Power Reference Measurement and Power Drift Measurements are for monitoring the power drift of the device under test in the batch process. Measure the local SAR at a test point within 8 mm of the phantom inner surface that is closest to the DUT. This distance cannot be smaller than the distance of sensor calibration points to probe tip as defined in the probe properties.

#### Step 2: Area Scan

The Area Scan is used as a fast scan in two dimensions to find the area of high field values, before doing a fine measurement around the hot spot. The sophisticated interpolation routines implemented in DASYS software can find the maximum locations even in relatively coarse grids. When an Area Scan has measured all reachable points, it computes the field maximal found in the scanned area, within a range of the global maximum. The range (in dB) is specified in the standards for compliance testing. For example, a 2 dB range is required in IEEE Standard 1528 and IEC 62209 standards, whereby 3 dB is a requirement when compliance is assessed in accordance with the ARIB standard (Japan). If only one Zoom Scan follows the Area Scan, then only the absolute maximum will be taken as reference. For cases where multiple maximums are detected, the number of Zoom Scans has to be increased accordingly.

#### Area Scan Resolutions per FCC KDB Publication 865664 D01v04

	≤ 3 GHz	> 3 GHz
Maximum distance from closest measurement point (geometric center of probe sensors) to phantom surface	5 mm ± 1 mm	$\frac{1}{2} \cdot \delta \cdot \ln(2)$ mm ± 0.5 mm
Maximum probe angle from probe axis to phantom surface normal at the measurement location	30° ± 1°	20° ± 1°
Maximum area scan spatial resolution: $\Delta x_{Area}$ , $\Delta y_{Area}$	≤ 2 GHz: ≤ 15 mm 2 – 3 GHz: ≤ 12 mm	3 – 4 GHz: ≤ 12 mm 4 – 6 GHz: ≤ 10 mm
	When the x or y dimension of the test device, in the measurement plane orientation, is smaller than the above, the measurement resolution must be ≤ the corresponding x or y dimension of the test device with at least one measurement point on the test device.	

**Step 3: Zoom Scan**

Zoom Scans are used to assess the peak spatial SAR values within a cubic averaging volume containing 1g and 10g of simulated tissue. The Zoom Scan measures points (refer to table below) within a cube whose base faces are centered on the maxima found in a preceding area scan job within the same procedure. When the measurement is done, the Zoom Scan evaluates the averaged SAR for 1 g and 10 g and displays these values next to the job's label.

**Zoom Scan Resolutions per FCC KDB Publication 865664 D01v04**

Maximum zoom scan spatial resolution: $\Delta x_{\text{Zoom}}, \Delta y_{\text{Zoom}}$		$\leq 2$ GHz: $\leq 8$ mm 2 – 3 GHz: $\leq 5$ mm*	3 – 4 GHz: $\leq 5$ mm* 4 – 6 GHz: $\leq 4$ mm*
Maximum zoom scan spatial resolution, normal to phantom surface	uniform grid: $\Delta z_{\text{Zoom}}(n)$	$\leq 5$ mm	3 – 4 GHz: $\leq 4$ mm 4 – 5 GHz: $\leq 3$ mm 5 – 6 GHz: $\leq 2$ mm
	graded grid	$\Delta z_{\text{Zoom}}(1)$ : between 1 <sup>st</sup> two points closest to phantom surface	$\leq 4$ mm
		$\Delta z_{\text{Zoom}}(n>1)$ : between subsequent points	$\leq 1.5 \cdot \Delta z_{\text{Zoom}}(n-1)$ mm
Minimum zoom scan volume	x, y, z	$\geq 30$ mm	3 – 4 GHz: $\geq 28$ mm 4 – 5 GHz: $\geq 25$ mm 5 – 6 GHz: $\geq 22$ mm
<p>Note: <math>\delta</math> is the penetration depth of a plane-wave at normal incidence to the tissue medium; see IEEE Std 1528-2013 for details.</p> <p>* When zoom scan is required and the <i>reported</i> SAR from the <i>area scan based 1-g SAR estimation</i> procedures of KDB Publication 447498 is <math>\leq 1.4</math> W/kg, <math>\leq 8</math> mm, <math>\leq 7</math> mm and <math>\leq 5</math> mm zoom scan resolution may be applied, respectively, for 2 GHz to 3 GHz, 3 GHz to 4 GHz and 4 GHz to 6 GHz.</p>			

**Step 4: Power drift measurement**

The Power Drift Measurement measures the field at the same location as the most recent power reference measurement within the same procedure, and with the same settings. The Power Drift Measurement gives the field difference in dB from the reading conducted within the last Power Reference Measurement. This allows a user to monitor the power drift of the device under test within a batch process. The measurement procedure is the same as Step 1. The SAR drift shall be kept within  $\pm 5$  %.

## 7.2. Data Storage and Evaluation

### Data Storage

The DASY5 software stores the acquired data from the data acquisition electronics as raw data (in microvolt readings from the probe sensors), together with all necessary software parameters for the data evaluation (probe calibration data, liquid parameters and device frequency and modulation data) in measurement files with the extension ".DA4". The software evaluates the desired unit and format for output each time the data is visualized or exported. This allows verification of the complete software setup even after the measurement and allows correction of incorrect parameter settings. For example, if a measurement has been performed with a wrong crest factor parameter in the device setup, the parameter can be corrected afterwards and the data can be re-evaluated.

The measured data can be visualized or exported in different units or formats, depending on the selected probe type ([V/m], [A/m], [°C], [mW/g], [mW/cm<sup>2</sup>], [dBrel], etc.). Some of these units are not available in certain situations or show meaningless results, e.g., a SAR output in a lossless media will always be zero. Raw data can also be exported to perform the evaluation with other software packages.

### Data Evaluation

The SEMCAD software automatically executes the following procedures to calculate the field units from the microvolt readings at the probe connector. The parameters used in the evaluation are stored in the configuration modules of the software:

Probe parameters:	Sensitivity:	Normi, ai0, ai1, ai2
	Conversion factor:	ConvFi
	Diode compression point:	Dcpi
Device parameters:	Frequency:	f
	Crest factor:	cf
Media parameters:	Conductivity:	σ
	Density:	ρ

These parameters must be set correctly in the software. They can be found in the component documents or they can be imported into the software from the configuration files issued for the DASY5 components. In the direct measuring mode of the multimeter option, the parameters of the actual system setup are used. In the scan visualization and export modes, the parameters stored in the corresponding document files are used.

The first step of the evaluation is a linearization of the filtered input signal to account for the compression characteristics of the detector diode. The compensation depends on the input signal, the diode type and the DC-transmission factor from the diode to the evaluation electronics. If the exciting field is pulsed, the crest factor of the signal must be known to correctly compensate for peak power. The formula for each channel can be given as:

$$V_i = U_i + U_i^2 \cdot \frac{cf}{dcp_i}$$

Vi:	compensated signal of channel ( i = x, y, z )
Ui:	input signal of channel ( i = x, y, z )
cf:	crest factor of exciting field (DASY parameter)
dcp <sub>i</sub> :	diode compression point (DASY parameter)

From the compensated input signals the primary field data for each channel can be evaluated:

$$E - \text{fieldprobes} : \quad E_i = \sqrt{\frac{V_i}{Norm_i \cdot ConvF}}$$

$$H - \text{fieldprobes} : \quad H_i = \sqrt{V_i} \cdot \frac{a_{i0} + a_{i1}f + a_{i2}f^2}{f}$$

Vi:	compensated signal of channel ( i = x, y, z )
Norm <sub>i</sub> :	sensor sensitivity of channel ( i = x, y, z ), [mV/(V/m) <sup>2</sup> ] for E-field Probes
ConvF:	sensitivity enhancement in solution
aij:	sensor sensitivity factors for H-field probes
f:	carrier frequency [GHz]
E <sub>i</sub> :	electric field strength of channel i in V/m
H <sub>i</sub> :	magnetic field strength of channel i in A/m

The RSS value of the field components gives the total field strength (Hermitian magnitude):

$$E_{tot} = \sqrt{E_x^2 + E_y^2 + E_z^2}$$

The primary field data are used to calculate the derived field units.

$$SAR = E_{tot}^2 \cdot \frac{\sigma}{\rho \cdot 1'000}$$

SAR: local specific absorption rate in mW/g  
Etot: total field strength in V/m  
 $\sigma$ : conductivity in [mho/m] or [Siemens/m]  
 $\rho$ : equivalent tissue density in g/cm<sup>3</sup>

Note that the density is normally set to 1 (or 1.06), to account for actual brain density rather than the density of the simulation liquid.



## 8. Position of the wireless device in relation to the phantom

### 8.1. Front-of-face

A typical example of a front-of-face device is a two-way radio that is held at a distance from the face of the user when transmitting. In these cases the device under test shall be positioned at the distance to the phantom surface that corresponds to the intended use as specified by the manufacturer in the user instructions. If the intended use is not specified, a separation distance of 25 mm between the phantom surface and the device shall be used.

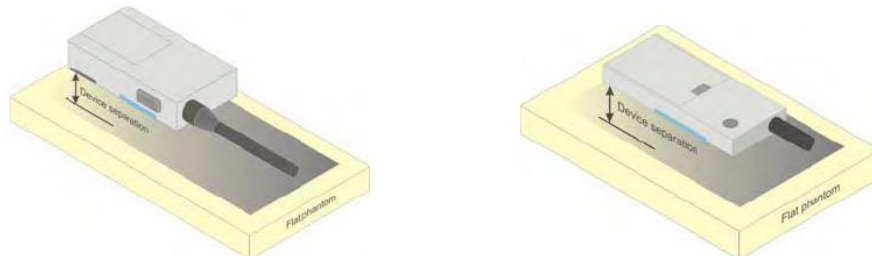

### 8.2. Body Position

A typical example of a body-worn device is a mobile phone, wireless enabled PDA or other battery operated wireless device with the ability to transmit while mounted on a person's body using a carry accessory approved by the wireless device manufacturer.

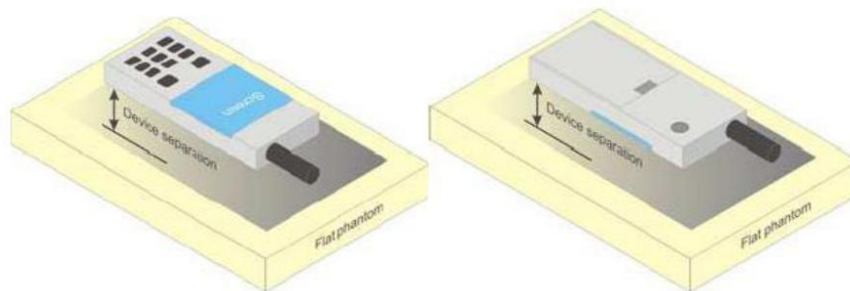

## 9. Dielectric Property Measurements & System Check

### 9.1. Tissue Dielectric Parameters

The temperature of the tissue-equivalent medium used during measurement must also be within 18°C to 25°C and within  $\pm 2^\circ\text{C}$  of the temperature when the tissue parameters are characterized.

The dielectric parameters must be measured before the tissue-equivalent medium is used in a series of SAR measurements. The parameters should be re-measured after each 3-4 days of use; or earlier if the dielectric parameters can become out of tolerance; for example, when the parameters are marginal at the beginning of the measurement series.

The dielectric constant ( $\epsilon_r$ ) and conductivity ( $\sigma$ ) of typical tissue-equivalent media recipes are expected to be within  $\pm 5\%$  of the required target values; but for SAR measurement systems that have implemented the SAR error compensation algorithms documented in IEEE Std 1528-2013, to automatically compensate the measured SAR results for deviations between the measured and required tissue dielectric parameters, the tolerance for  $\epsilon_r$  and  $\sigma$  may be relaxed to  $\pm 10\%$ . This is limited to frequencies  $\leq 3$  GHz.

#### Tissue Dielectric Parameters

FCC KDB 865664 D01 SAR Measurement 100 MHz to 6 GHz

Tissue dielectric parameters for Head and Body				
Target Frequency (MHz)	Head		Body	
	$\epsilon_r$	$\sigma(\text{S/m})$	$\epsilon_r$	$\sigma(\text{S/m})$
450	43.5	0.87	56.7	0.94

#### IEEE Std 1528-2013

Refer to Table 3 within the IEEE Std 1528-2013

#### Dielectric Property Measurements Results:

Dielectric performance of Head tissue simulating liquid									
Frequency (MHz)	$\epsilon_r$		$\sigma(\text{S/m})$		Delta ( $\epsilon_r$ )	Delta ( $\sigma$ )	Limit	Temp ( $^\circ\text{C}$ )	Date
	Target	Measured	Target	Measured					
450	43.50	41.86	0.870	0.892	-3.77%	2.53%	$\pm 5\%$	22.0	2021/11/8

## 9.2. SAR System Validation

Per FCC KDB 865664 D02, SAR system validation status should be documented to confirm measurement accuracy. The SAR systems (including SAR probes, system components and software versions) used for this device were validated against its performance specifications prior to the SAR measurements. Reference dipoles were used with the required tissue-equivalent media for system validation, according to the procedures outlined in FCC KDB 865664 D01 and IEEE 1528-2013. Since SAR probe calibrations are frequency dependent, each probe calibration point, using the system that normally operates with the probe for routine SAR measurements and according to the required tissue-equivalent media.

A tabulated summary of the system validation status including the validation date(s), measurement frequencies, SAR probes and tissue dielectric parameters has been included.

### 9.3. System Check

SAR system verification is required to confirm measurement accuracy, according to the tissue dielectric media, probe calibration points and other system operating parameters required for measuring the SAR of a test device. The system verification must be performed for each frequency band and within the valid range of each probe calibration point required for testing the device. The same SAR probe(s) and tissue-equivalent media combinations used with each specific SAR system for system verification must be used for device testing. When multiple probe calibration points are required to cover substantially large transmission bands, independent system verifications are required for each probe calibration point. A system verification must be performed before each series of SAR measurements using the same probe calibration point and tissue-equivalent medium. Additional system verification should be considered according to the conditions of the tissue-equivalent medium and measured tissue dielectric parameters, typically every three to four days when the liquid parameters are re-measured or sooner when marginal liquid parameters are used at the beginning of a series of measurements.

#### System Performance Check Measurement Conditions:

- The measurements were performed in the flat section of the TWIN SAM or ELI phantom, shell thickness:  $2.0 \pm 0.2$  mm (bottom plate) filled with Body or Head simulating liquid of the following parameters.
- The depth of tissue-equivalent liquid in a phantom must be  $\geq 15.0$  cm for SAR measurements  $\leq 3$  GHz and  $\geq 10.0$  cm for measurements  $> 3$  GHz.
- The DASY system with an E-Field Probe was used for the measurements.
- The dipole was mounted on the small tripod so that the dipole feed point was positioned below the center marking of the flat phantom section and the dipole was oriented parallel to the body axis (the long side of the phantom). The standard measuring distance was 10 mm (above 1 GHz) and 15 mm (below 1 GHz) from dipole center to the simulating liquid surface.
- The coarse grid with a grid spacing of 15 mm was aligned with the dipole.  
For 5 GHz band - The coarse grid with a grid spacing of 10 mm was aligned with the dipole.
- Special 7x7x7 (below 3 GHz) and/or 8x8x7 (above 3 GHz) fine cube was chosen for the cube.
- The results are normalized to 1 W input power.

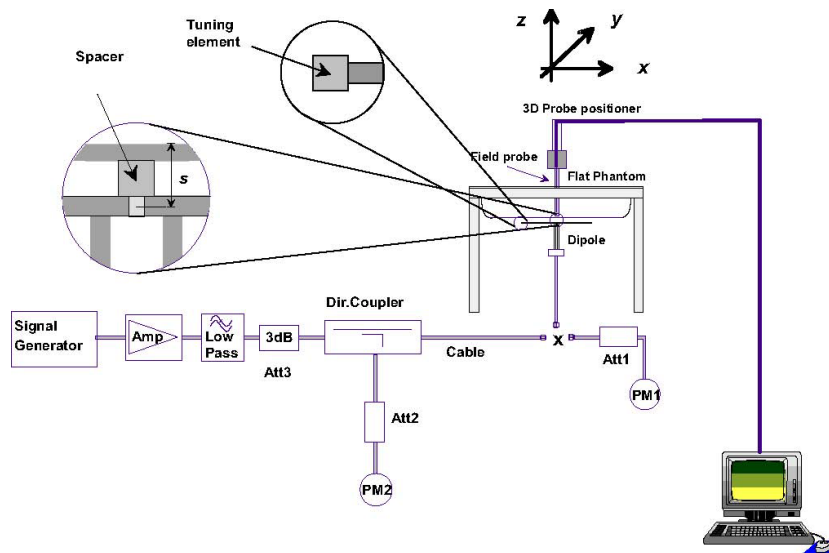

System Performance Check Setup



Photo of Dipole Setup

**Check Result:**

Head											
Frequency (MHz)	1g SAR			10g SAR			Delta (1g)	Delta (10g)	Limit	Temp (°C)	Date
	Target 1W	Normalize to 1W	Measured 250mW	Target 1W	Normalize to 1W	Measured 250mW					
450	4.60	4.96	1.24	3.09	3.32	0.830	7.83%	7.44%	±10%	22.4	2021/11/8

**Note:**

1. the graph results see follow.

## Plots of System Performance Check

### System Performance Check-Head 450MHz

DUT: D450V3; Type: D450V3; Serial: 1102

Date: 2021-11-08

Communication System: UID 0, A-CW (0); Frequency: 450 MHz; Duty Cycle: 1:1

Medium parameters used:  $f = 450$  MHz;  $\sigma = 0.893$  S/m;  $\epsilon_r = 41.786$ ;  $\rho = 1000$  kg/m<sup>3</sup>

Phantom section: Flat Section

Ambient Temperature: 22.4°C; Liquid Temperature: 22.2°C;

#### DASY Configuration:

- Probe: EX3DV4 - SN3842; ConvF(10.09, 10.09, 10.09) @ 450 MHz; Calibrated: 1/25/2021
- Sensor-Surface: 1.4mm (Mechanical Surface Detection)
- Electronics: DAE4 Sn1549; Calibrated: 3/23/2021
- Phantom: ELI V8.0 ; Type: QD OVA 004 AA ; Serial: 2078
- DASY52 52.10.2(1495); SEMCAD X 14.6.12(7450)

#### Head/d=15mm, Pin=250mW, dist=1.4mm/Area Scan (51x101x1): Interpolated grid:

$dx=1.500$  mm,  $dy=1.500$  mm

Maximum value of SAR (interpolated) = 1.67 W/kg

#### Head/d=15mm, Pin=250mW, dist=1.4mm /Zoom Scan (5x5x7)/Cube 0:

Measurement grid:  $dx=8$ mm,  $dy=8$ mm,  $dz=5$ mm

Reference Value = 44.70 V/m; Power Drift = -0.07 dB

Peak SAR (extrapolated) = 1.96 W/kg

**SAR(1 g) = 1.24 W/kg; SAR(10 g) = 0.830 W/kg**

Maximum value of SAR (measured) = 1.69 W/kg

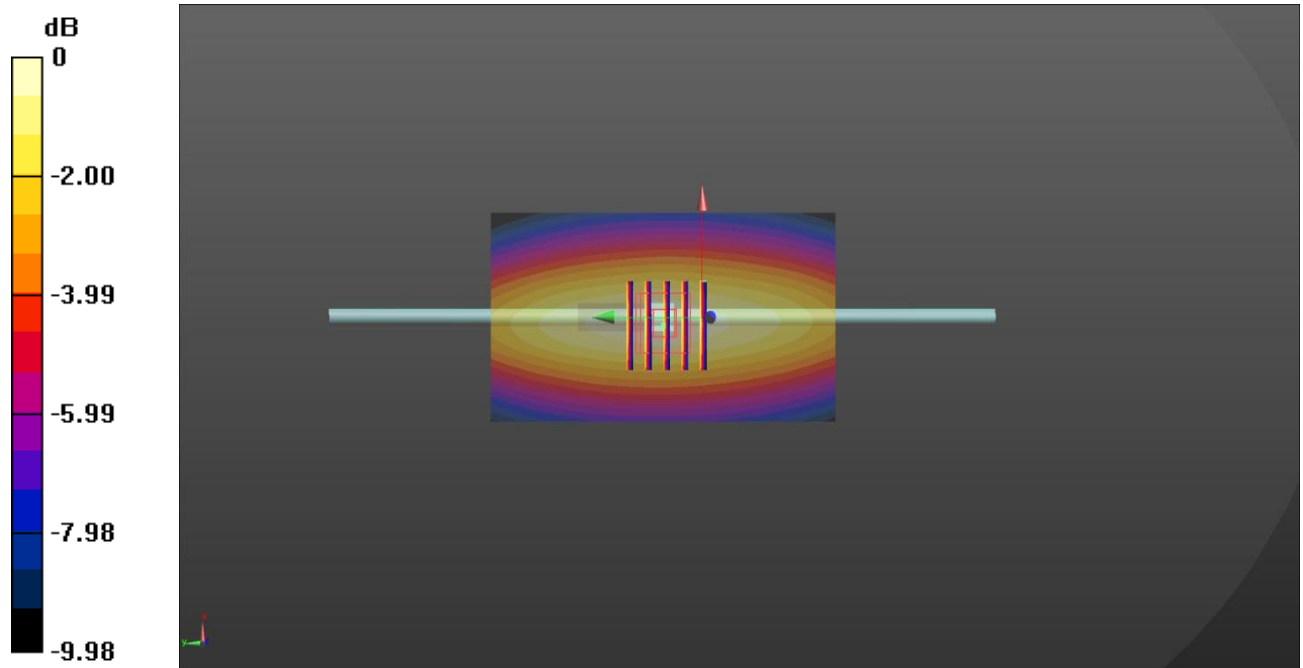

0 dB = 1.69 W/kg = 2.28 dBW/kg

## 10. SAR Exposure Limits

SAR assessments have been made in line with the requirements of FCC 47 CFR § 2.1093.

Type Exposure	Limit (W/kg)	
	General Population / Uncontrolled Exposure Environment	Occupational / Controlled Exposure Environment
Spatial Average SAR (whole body)	0.08	0.4
Spatial Peak SAR (1g cube tissue for head and trunk)	1.6	8.0
Spatial Peak SAR (10g for limb)	4.0	20.0

Population/Uncontrolled Environments: are defined as locations where there is the exposure of individual who have no knowledge or control of their exposure.

Occupational/Controlled Environments: are defined as locations where there is exposure that may be incurred by people who are aware of the potential for exposure (i.e. as a result of employment or occupation).

## 11. Radiated Power Measurement Results and Tune-up

This device operates using the following maximum output power specifications. SAR values were scaled to the maximum allowed power to determine compliance per KDB publication 447498 D01

Please refer to appendix A

## 12. SAR Measurement Results

Please refer to appendix B

SAR Test Data Plots to the Appendix D.

*Note:*

1. The distance of the front-of-face test is 25mm, the distance of the Body-worn test is 0mm.
2. Batteries are fully charged at the beginning of the SAR measurements.
3. The Body-worn SAR evaluation was performed with the Leather Case body-worn accessory attached to the DUT and touching the outer surface of the planar phantom.

### 13. Test Setup Photos

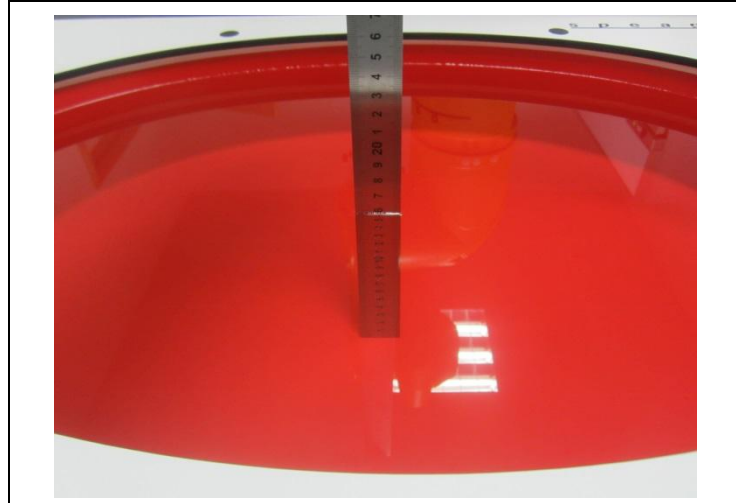

Liquid depth in the ELI Phantom



Front-of-face(25mm)

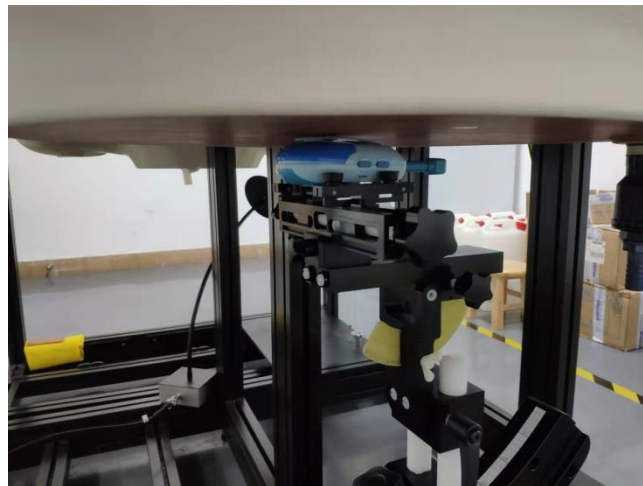

Body-worn(0mm)

### 14. External and Internal Photos of the EUT

Please refer to the test report No.: CHTEW21110026

-----End of Report-----



## Appendix A: Conducted Power Measurement Results

Power					
Mode	Channel Separation	Frequency		Conducted Power (dBm)	Tune up limit (dBm)
		Channel	MHz		
Analog	12.5kHz	CH1	462.5625	16.81	17.00
		CH2	462.7125	16.83	17.00

**Appendix B:SAR Measurement Results**

<b>Front-of-face</b>											
Mode	Channel Separation	Frequency		Conducted Power (dBm)	Tune up limit (dBm)	Tune up scaling factor	Power Drift(dB)	Measured SAR(1g) (W/kg)	Report SAR(1g) (W/kg)	50% Duty SAR(1g) (W/kg)	Plot No.
		CH	MHz								
Analog	12.5kHz	CH1	462.5625	16.81	17.00	1.045	-0.10	0.024	0.025	0.013	1
		CH2	462.7125	16.83	17.00	1.040	-0.12	0.015	0.016	0.008	3

<b>Body-worn</b>											
Mode	Channel Separation	Frequency		Conducted Power (dBm)	Tune up limit (dBm)	Tune up scaling factor	Power Drift(dB)	Measured SAR(1g) (W/kg)	Report SAR(1g) (W/kg)	50% Duty SAR(1g) (W/kg)	Plot No.
		CH	MHz								
Analog	12.5kHz	CH1	462.5625	16.81	17.00	1.045	-0.08	0.059	0.062	0.031	2
		CH2	462.7125	16.83	17.00	1.040	-0.05	0.042	0.044	0.022	4

**Analog CH1-12.5k-Head**

Communication System: UID 0, Analog (0); Frequency: 462.563 MHz; Duty Cycle: 1:1

Medium parameters used:  $f = 463$  MHz;  $\sigma = 0.902$  S/m;  $\epsilon_r = 41.555$ ;  $\rho = 1000$  kg/m<sup>3</sup>

Phantom section: Flat Section

Ambient Temperature: 22.2°C; Liquid Temperature: 22.0°C;

DASY Configuration:

- Probe: EX3DV4 - SN3842; ConvF(10.09, 10.09, 10.09) @ 462.563 MHz; Calibrated: 1/25/2021
- Sensor-Surface: 1.4mm (Mechanical Surface Detection)
- Electronics: DAE4 Sn1549; Calibrated: 3/23/2021
- Phantom: ELI V8.0 ; Type: QD OVA 004 AA ; Serial: 2078
- DASY52 52.10.2(1495); SEMCAD X 14.6.12(7450)

**Front/CH 1/Area Scan (61x121x1):** Interpolated grid: dx=1.500 mm, dy=1.500 mm  
Maximum value of SAR (interpolated) = 0.0480 W/kg

**Front/CH 1/Zoom Scan (5x5x7)/Cube 0:** Measurement grid: dx=8mm, dy=8mm, dz=5mm

Reference Value = 7.553 V/m; Power Drift = -0.10 dB

Peak SAR (extrapolated) = 0.0360 W/kg

**SAR(1 g) = 0.024 W/kg; SAR(10 g) = 0.017 W/kg.**

Maximum value of SAR (measured) = 0.0310 W/kg

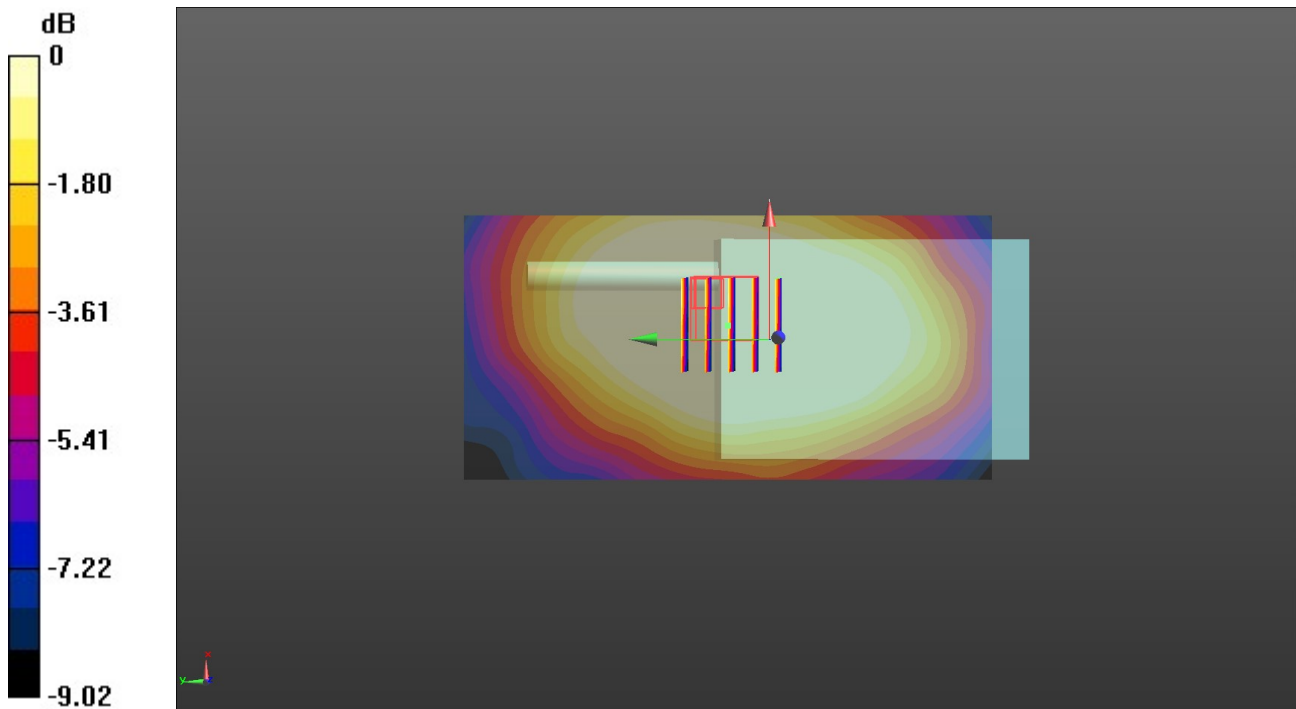

0 dB = 0.0310 W/kg = -15.09 dBW/kg

**Analog CH1-12.5k-Body worn**

Communication System: UID 0, Analog (0); Frequency: 462.563 MHz;Duty Cycle: 1:1

Medium parameters used:  $f = 463$  MHz;  $\sigma = 0.902$  S/m;  $\epsilon_r = 41.555$ ;  $\rho = 1000$  kg/m<sup>3</sup>

Phantom section: Flat Section

Ambient Temperature:22.3°C;Liquid Temperature:22.1°C;

DASY Configuration:

- Probe: EX3DV4 - SN3842; ConvF(10.09, 10.09, 10.09) @ 462.563 MHz; Calibrated: 1/25/2021
- Sensor-Surface: 1.4mm (Mechanical Surface Detection)
- Electronics: DAE4 Sn1549; Calibrated: 3/23/2021
- Phantom: ELI V8.0 ; Type: QD OVA 004 AA ; Serial: 2078
- DASY52 52.10.2(1495); SEMCAD X 14.6.12(7450)

**Rear/CH 1/Area Scan (61x121x1):** Interpolated grid: dx=1.500 mm, dy=1.500 mm

Maximum value of SAR (interpolated) = 0.0827 W/kg

**Rear/CH 1/Zoom Scan (5x5x7)/Cube 0:** Measurement grid: dx=8mm, dy=8mm, dz=5mm

Reference Value = 8.289 V/m; Power Drift = -0.08 dB

Peak SAR (extrapolated) = 0.0970 W/kg

**SAR(1 g) = 0.059 W/kg; SAR(10 g) = 0.040 W/kg**

Maximum value of SAR (measured) = 0.0807 W/kg

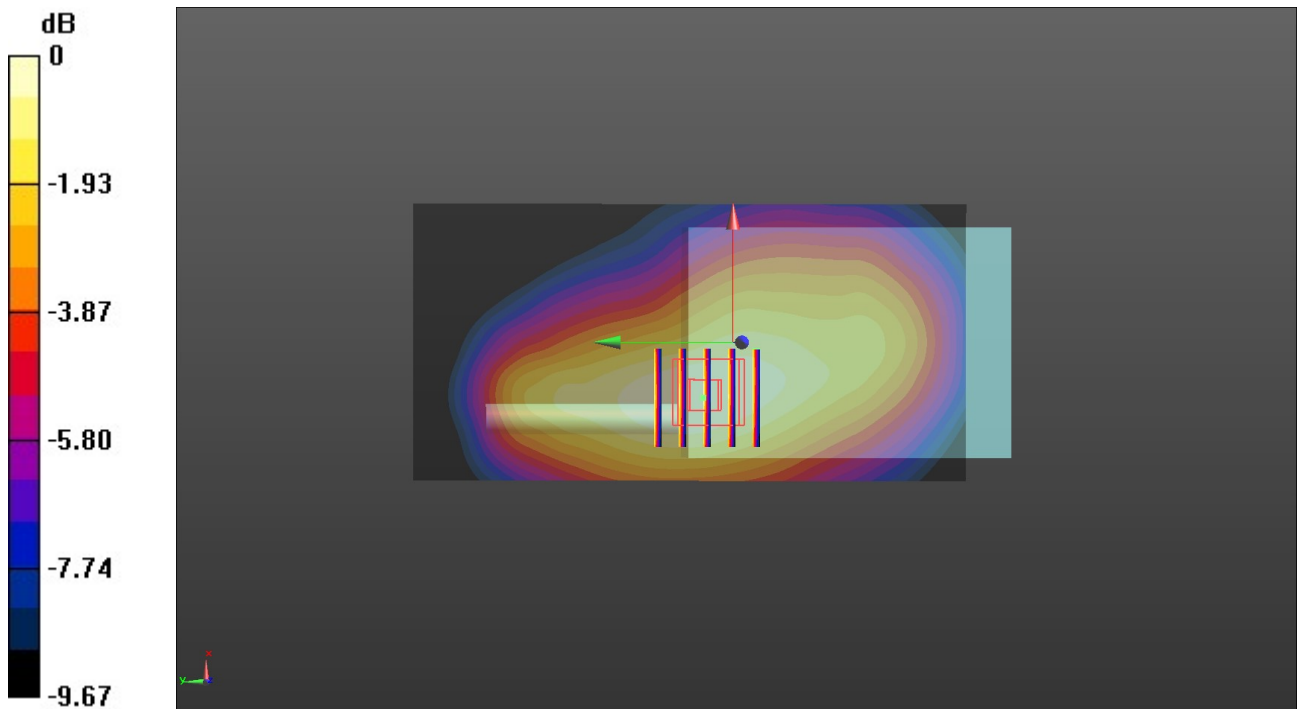

0 dB = 0.0807 W/kg = -10.93 dBW/kg

**Analog CH2-12.5k-Head**

Communication System: UID 0, Analog (0); Frequency: 462.712 MHz;Duty Cycle: 1:1

Medium parameters used:  $f = 463$  MHz;  $\sigma = 0.902$  S/m;  $\epsilon_r = 41.555$ ;  $\rho = 1000$  kg/m<sup>3</sup>

Phantom section: Flat Section

Ambient Temperature:22.2°C;Liquid Temperature:22.0°C;

DASY Configuration:

- Probe: EX3DV4 - SN3842; ConvF(10.09, 10.09, 10.09) @ 462.712 MHz; Calibrated: 1/25/2021
- Sensor-Surface: 1.4mm (Mechanical Surface Detection)
- Electronics: DAE4 Sn1549; Calibrated: 3/23/2021
- Phantom: ELI V8.0 ; Type: QD OVA 004 AA ; Serial: 2078
- DASY52 52.10.2(1495); SEMCAD X 14.6.12(7450)

**Front/CH 2/Area Scan (61x121x1):** Interpolated grid: dx=1.500 mm, dy=1.500 mm

Maximum value of SAR (interpolated) = 0.0239 W/kg

**Front/CH 2/Zoom Scan (5x5x7)/Cube 0:** Measurement grid: dx=8mm, dy=8mm, dz=5mm

Reference Value = 4.935 V/m; Power Drift = -0.12 dB

Peak SAR (extrapolated) = 0.0230 W/kg

**SAR(1 g) = 0.015 W/kg; SAR(10 g) = 0.011 W/kg**

Maximum value of SAR (measured) = 0.0199 W/kg

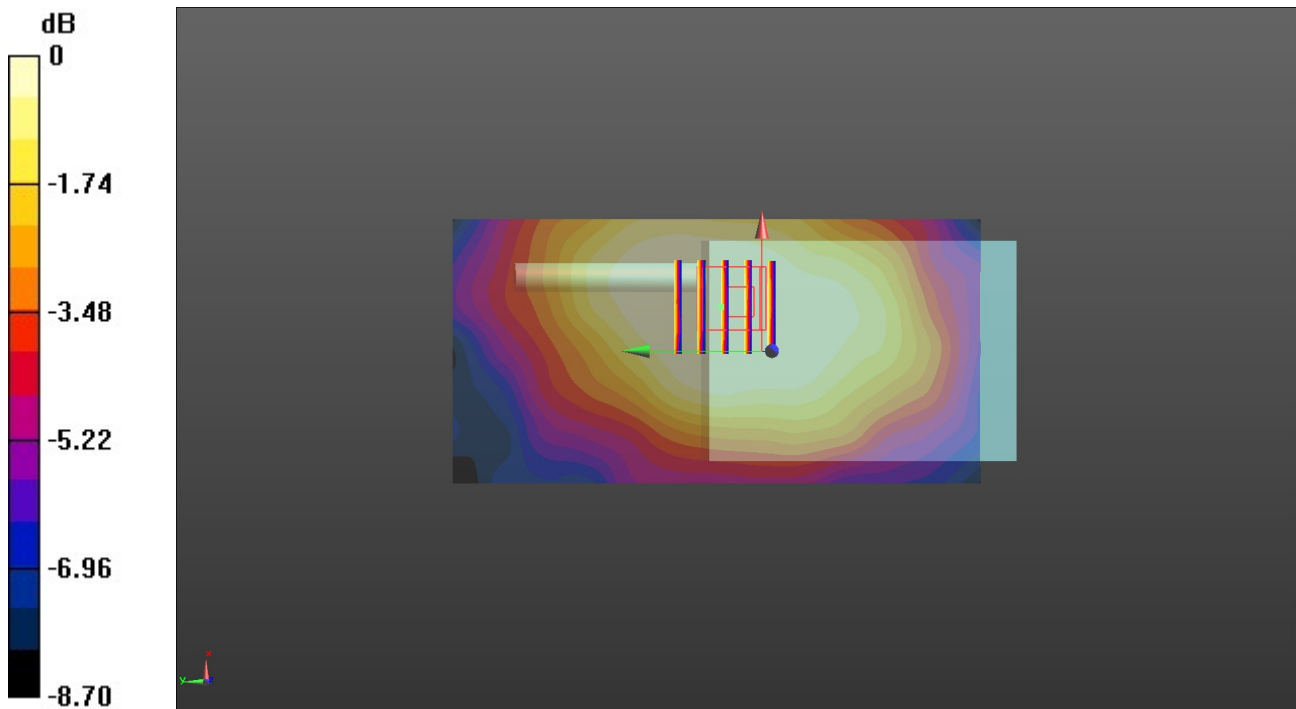

0 dB = 0.0199 W/kg = -17.01 dBW/kg

**Analog CH2-12.5k-Body worn**

Communication System: UID 0, Analog (0); Frequency: 462.712 MHz;Duty Cycle: 1:1

Medium parameters used:  $f = 463$  MHz;  $\sigma = 0.902$  S/m;  $\epsilon_r = 41.555$ ;  $\rho = 1000$  kg/m<sup>3</sup>

Phantom section: Flat Section

Ambient Temperature:22.4°C;Liquid Temperature:22.2°C;

DASY Configuration:

- Probe: EX3DV4 - SN3842; ConvF(10.09, 10.09, 10.09) @ 462.712 MHz; Calibrated: 1/25/2021
- Sensor-Surface: 1.4mm (Mechanical Surface Detection)
- Electronics: DAE4 Sn1549; Calibrated: 3/23/2021
- Phantom: ELI V8.0 ; Type: QD OVA 004 AA ; Serial: 2078
- DASY52 52.10.2(1495); SEMCAD X 14.6.12(7450)

**Rear/CH 2/Area Scan (61x121x1):** Interpolated grid: dx=1.500 mm, dy=1.500 mm

Maximum value of SAR (interpolated) = 0.0787 W/kg

**Rear/CH 2/Zoom Scan (5x5x7)/Cube 0:** Measurement grid: dx=8mm, dy=8mm, dz=5mm

Reference Value = 8.059 V/m; Power Drift = -0.05 dB

Peak SAR (extrapolated) = 0.0920 W/kg

**SAR(1 g) = 0.042 W/kg; SAR(10 g) = 0.036 W/kg**

Maximum value of SAR (measured) = 0.0757 W/kg

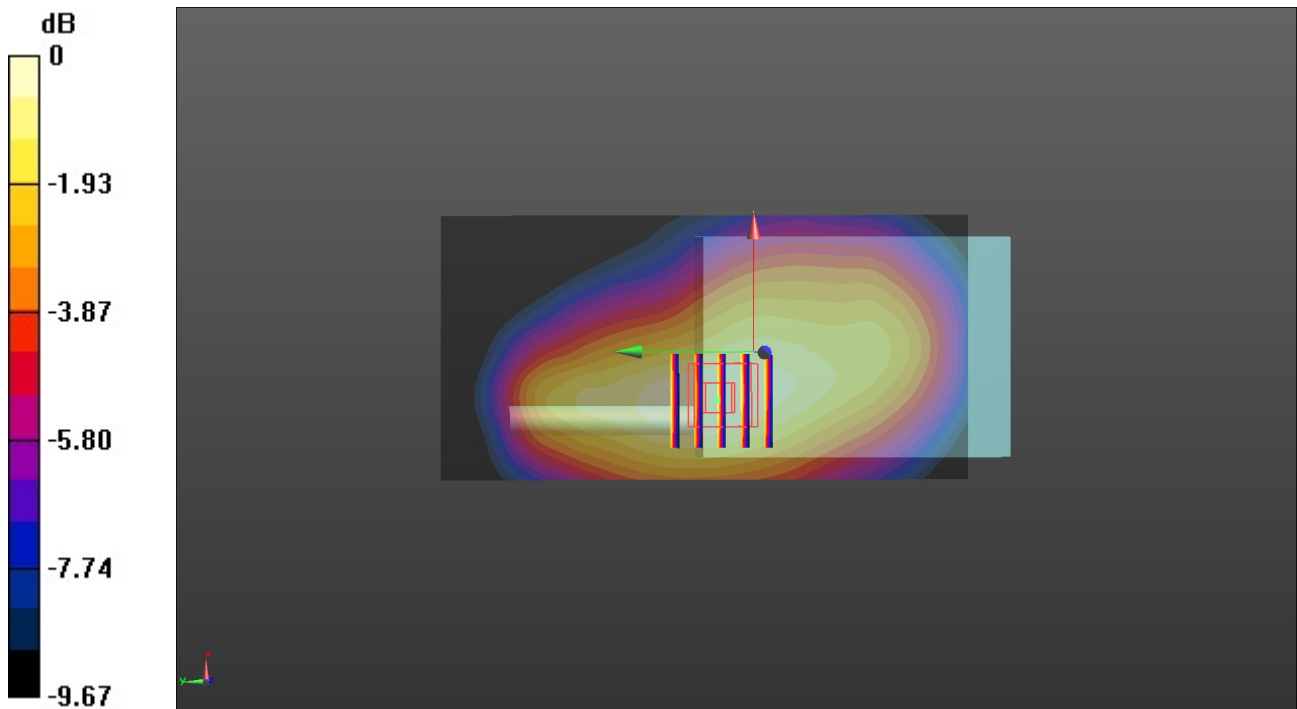

0 dB = 0.0757 W/kg = -10.43 dBW/kg

1.1. DAE4 Calibration Certificate

In Collaboration with



中国认可  
国际互认  
校准  
CALIBRATION  
CNAS L0570

Add: No.52 HuaYuanBei Road, Haidian District, Beijing, 100191, China  
 Tel: +86-10-62304633-2512 Fax: +86-10-62304633-2504  
 E-mail: cttl@chinattl.com [Http://www.chinattl.cn](http://www.chinattl.cn)

Client : **HTW** Certificate No: **Z21-60063**

<b>CALIBRATION CERTIFICATE</b>													
Object	DAE4 - SN: 1549												
Calibration Procedure(s)	FF-Z11-002-01 Calibration Procedure for the Data Acquisition Electronics (DAEx)												
Calibration date:	March 23, 2021												
<p>This calibration Certificate documents the traceability to national standards, which realize the physical units of measurements(SI). The measurements and the uncertainties with confidence probability are given on the following pages and are part of the certificate.</p> <p>All calibrations have been conducted in the closed laboratory facility: environment temperature(22±3)°C and humidity&lt;70%.</p> <p>Calibration Equipment used (M&amp;TE critical for calibration)</p>													
Primary Standards	<table style="width: 100%; border-collapse: collapse;"> <thead> <tr> <th style="width: 30%; border-bottom: 1px solid black;">ID #</th> <th style="width: 40%; border-bottom: 1px solid black;">Cal Date(Calibrated by, Certificate No.)</th> <th style="width: 30%; border-bottom: 1px solid black;">Scheduled Calibration</th> </tr> </thead> <tbody> <tr> <td style="border-right: 1px solid black; padding: 5px;">Process Calibrator 753</td> <td style="padding: 5px;">1971018      16-Jun-20 (CTTL, No.J20X04342)</td> <td style="padding: 5px;">Jun-21</td> </tr> </tbody> </table>	ID #	Cal Date(Calibrated by, Certificate No.)	Scheduled Calibration	Process Calibrator 753	1971018      16-Jun-20 (CTTL, No.J20X04342)	Jun-21						
ID #	Cal Date(Calibrated by, Certificate No.)	Scheduled Calibration											
Process Calibrator 753	1971018      16-Jun-20 (CTTL, No.J20X04342)	Jun-21											
<table style="width: 100%; border-collapse: collapse;"> <tr> <td style="width: 30%; padding: 5px;">Calibrated by:</td> <td style="width: 30%; padding: 5px;">Name Yu Zongying</td> <td style="width: 30%; padding: 5px;">Function SAR Test Engineer</td> <td style="width: 10%; padding: 5px;">Signature </td> </tr> <tr> <td style="padding: 5px;">Reviewed by:</td> <td style="padding: 5px;">Lin Hao</td> <td style="padding: 5px;">SAR Test Engineer</td> <td style="padding: 5px;"></td> </tr> <tr> <td style="padding: 5px;">Approved by:</td> <td style="padding: 5px;">Qi Dianyuan</td> <td style="padding: 5px;">SAR Project Leader</td> <td style="padding: 5px;"></td> </tr> </table>	Calibrated by:	Name Yu Zongying	Function SAR Test Engineer	Signature 	Reviewed by:	Lin Hao	SAR Test Engineer		Approved by:	Qi Dianyuan	SAR Project Leader		<p style="text-align: right;">Issued: March 25, 2021</p> <p style="text-align: center; font-size: small;">This calibration certificate shall not be reproduced except in full without written approval of the laboratory.</p>
Calibrated by:	Name Yu Zongying	Function SAR Test Engineer	Signature 										
Reviewed by:	Lin Hao	SAR Test Engineer											
Approved by:	Qi Dianyuan	SAR Project Leader											





Add: No.52 HuaYuanBei Road, Haidian District, Beijing, 100191, China  
Tel: +86-10-62304633-2512 Fax: +86-10-62304633-2504  
E-mail: cttl@chinattl.com Http://www.chinattl.cn

**Glossary:**

DAE data acquisition electronics  
Connector angle information used in DASY system to align probe sensor X to the robot coordinate system.

**Methods Applied and Interpretation of Parameters:**

- *DC Voltage Measurement:* Calibration Factor assessed for use in DASY system by comparison with a calibrated instrument traceable to national standards. The figure given corresponds to the full scale range of the voltmeter in the respective range.
- *Connector angle:* The angle of the connector is assessed measuring the angle mechanically by a tool inserted. Uncertainty is not required.
- The report provide only calibration results for DAE, it does not contain other performance test results.





Add: No.52 HuaYuanBei Road, Haidian District, Beijing, 100191, China  
 Tel: +86-10-62304633-2512 Fax: +86-10-62304633-2504  
 E-mail: cttl@chinattl.com Http://www.chinattl.cn

**DC Voltage Measurement**

A/D - Converter Resolution nominal

High Range: 1LSB = 6.1μV, full range = -100...+300 mV  
 Low Range: 1LSB = 61nV, full range = -1.....+3mV

DASY measurement parameters: Auto Zero Time: 3 sec; Measuring time: 3 sec

Calibration Factors	X	Y	Z
High Range	406.327 ± 0.15% (k=2)	406.003 ± 0.15% (k=2)	406.159 ± 0.15% (k=2)
Low Range	3.98410 ± 0.7% (k=2)	3.99112 ± 0.7% (k=2)	3.99200 ± 0.7% (k=2)

**Connector Angle**

Connector Angle to be used in DASY system	19° ± 1 °
---	-----------

## 1.2. Probe Calibration Certificate

Calibration Laboratory of  
Schmid & Partner  
Engineering AG  
Zeughausstrasse 43, 8004 Zurich, Switzerland



S Schweizerischer Kalibrierdienst  
C Service suisse d'étalonnage  
S Servizio svizzero di taratura  
S Swiss Calibration Service

Accredited by the Swiss Accreditation Service (SAS)

The Swiss Accreditation Service is one of the signatories to the EA  
Multilateral Agreement for the recognition of calibration certificates

Accreditation No.: SCS 0108

Client **CIQ (Auden)**

Certificate No: **EX3-3842\_Jan21**

## CALIBRATION CERTIFICATE

Object **EX3DV4 - SN:3842**

Calibration procedure(s) **QA CAL-01.v9, QA CAL-12.v9, QA CAL-23.v5, QA CAL-25.v7  
Calibration procedure for dosimetric E-field probes**

Calibration date: **January 25, 2021**

This calibration certificate documents the traceability to national standards, which realize the physical units of measurements (SI).  
The measurements and the uncertainties with confidence probability are given on the following pages and are part of the certificate.

All calibrations have been conducted in the closed laboratory facility: environment temperature ( $22 \pm 3$ )°C and humidity < 70%.

Calibration Equipment used (M&TE critical for calibration)

Primary Standards	ID	Cal Date (Certificate No.)	Scheduled Calibration
Power meter NRP	SN: 104778	01-Apr-20 (No. 217-03100/03101)	Apr-21
Power sensor NRP-Z91	SN: 103244	01-Apr-20 (No. 217-03100)	Apr-21
Power sensor NRP-Z91	SN: 103245	01-Apr-20 (No. 217-03101)	Apr-21
Reference 20 dB Attenuator	SN: CC2552 (20x)	31-Mar-20 (No. 217-03106)	Apr-21
DAE4	SN: 660	23-Dec-20 (No. DAE4-660_Dec20)	Dec-21
Reference Probe ES3DV2	SN: 3013	30-Dec-20 (No. ES3-3013_Dec20)	Dec-21
Secondary Standards	ID	Check Date (in house)	Scheduled Check
Power meter E4419B	SN: GB41293874	06-Apr-16 (in house check Jun-20)	In house check: Jun-22
Power sensor E4412A	SN: MY41498087	06-Apr-16 (in house check Jun-20)	In house check: Jun-22
Power sensor E4412A	SN: 000110210	06-Apr-16 (in house check Jun-20)	In house check: Jun-22
RF generator HP 8648C	SN: US3642U01700	04-Aug-99 (in house check Jun-20)	In house check: Jun-22
Network Analyzer E8358A	SN: US41080477	31-Mar-14 (in house check Oct-20)	In house check: Oct-21

	Name	Function	Signature
Calibrated by:	Jeffrey Katzman	Laboratory Technician	
Approved by:	Kalja Pokovic	Technical Manager	

Issued: January 28, 2021

This calibration certificate shall not be reproduced except in full without written approval of the laboratory.

**Calibration Laboratory of  
Schmid & Partner  
Engineering AG**  
Zeughausstrasse 43, 8004 Zurich, Switzerland



**S** Schweizerischer Kalibrierdienst  
**C** Service suisse d'étalonnage  
**S** Servizio svizzero di taratura  
**S** Swiss Calibration Service

Accredited by the Swiss Accreditation Service (SAS)

Accreditation No.: **SCS 0108**

The Swiss Accreditation Service is one of the signatories to the EA  
Multilateral Agreement for the recognition of calibration certificates

#### Glossary:

TSL	tissue simulating liquid
NORM <sub>x,y,z</sub>	sensitivity in free space
ConvF	sensitivity in TSL / NORM <sub>x,y,z</sub>
DCP	diode compression point
CF	crest factor (1/duty_cycle) of the RF signal
A, B, C, D	modulation dependent linearization parameters
Polarization $\varphi$	$\varphi$ rotation around probe axis
Polarization $\vartheta$	$\vartheta$ rotation around an axis that is in the plane normal to probe axis (at measurement center), i.e., $\vartheta = 0$ is normal to probe axis
Connector Angle	information used in DASY system to align probe sensor X to the robot coordinate system

#### Calibration is Performed According to the Following Standards:

- IEEE Std 1528-2013, "IEEE Recommended Practice for Determining the Peak Spatial-Averaged Specific Absorption Rate (SAR) in the Human Head from Wireless Communications Devices: Measurement Techniques", June 2013
- IEC 62209-1, "Measurement procedure for the assessment of Specific Absorption Rate (SAR) from hand-held and body-mounted devices used next to the ear (frequency range of 300 MHz to 6 GHz)", July 2016
- IEC 62209-2, "Procedure to determine the Specific Absorption Rate (SAR) for wireless communication devices used in close proximity to the human body (frequency range of 30 MHz to 6 GHz)", March 2010
- KDB 865664, "SAR Measurement Requirements for 100 MHz to 6 GHz"

#### Methods Applied and Interpretation of Parameters:

- NORM<sub>x,y,z</sub>**: Assessed for E-field polarization  $\vartheta = 0$  ( $f \leq 900$  MHz in TEM-cell;  $f > 1800$  MHz: R22 waveguide). NORM<sub>x,y,z</sub> are only intermediate values, i.e., the uncertainties of NORM<sub>x,y,z</sub> does not affect the E<sup>2</sup>-field uncertainty inside TSL (see below ConvF).
- NORM(f)<sub>x,y,z</sub>** = NORM<sub>x,y,z</sub> \* frequency\_response (see Frequency Response Chart). This linearization is implemented in DASY4 software versions later than 4.2. The uncertainty of the frequency response is included in the stated uncertainty of ConvF.
- DCP<sub>x,y,z</sub>**: DCP are numerical linearization parameters assessed based on the data of power sweep with CW signal (no uncertainty required). DCP does not depend on frequency nor media.
- PAR**: PAR is the Peak to Average Ratio that is not calibrated but determined based on the signal characteristics
- A<sub>x,y,z</sub>; B<sub>x,y,z</sub>; C<sub>x,y,z</sub>; D<sub>x,y,z</sub>; VR<sub>x,y,z</sub>**: A, B, C, D are numerical linearization parameters assessed based on the data of power sweep for specific modulation signal. The parameters do not depend on frequency nor media. VR is the maximum calibration range expressed in RMS voltage across the diode.
- ConvF and Boundary Effect Parameters**: Assessed in flat phantom using E-field (or Temperature Transfer Standard for  $f \leq 800$  MHz) and inside waveguide using analytical field distributions based on power measurements for  $f > 800$  MHz. The same setups are used for assessment of the parameters applied for boundary compensation (alpha, depth) of which typical uncertainty values are given. These parameters are used in DASY4 software to improve probe accuracy close to the boundary. The sensitivity in TSL corresponds to NORM<sub>x,y,z</sub> \* ConvF whereby the uncertainty corresponds to that given for ConvF. A frequency dependent ConvF is used in DASY version 4.4 and higher which allows extending the validity from  $\pm 50$  MHz to  $\pm 100$  MHz.
- Spherical isotropy (3D deviation from isotropy)**: in a field of low gradients realized using a flat phantom exposed by a patch antenna.
- Sensor Offset**: The sensor offset corresponds to the offset of virtual measurement center from the probe tip (on probe axis). No tolerance required.
- Connector Angle**: The angle is assessed using the information gained by determining the NORM<sub>x</sub> (no uncertainty required).

Certificate No: EX3-3842\_Jan21

Page 2 of 9

EX3DV4 – SN:3842

January 25, 2021

**DASY/EASY - Parameters of Probe: EX3DV4 - SN:3842****Basic Calibration Parameters**

	Sensor X	Sensor Y	Sensor Z	Unc (k=2)
Norm ( $\mu\text{V}/(\text{V}/\text{m})^2$ ) <sup>A</sup>	0.35	0.51	0.40	$\pm 10.1 \%$
DCP (mV) <sup>B</sup>	104.7	100.7	102.2	

**Calibration Results for Modulation Response**

UID	Communication System Name		A dB	B dB $\sqrt{\mu\text{V}}$	C	D dB	VR mV	Max dev.	Unc <sup>E</sup> (k=2)
0	CW	X	0.0	0.0	1.0	0.00	132.1	$\pm 2.2 \%$	$\pm 4.7 \%$
		Y	0.0	0.0	1.0		136.3		
		Z	0.0	0.0	1.0		126.4		

The reported uncertainty of measurement is stated as the standard uncertainty of measurement multiplied by the coverage factor  $k=2$ , which for a normal distribution corresponds to a coverage probability of approximately 95%.

<sup>A</sup> The uncertainties of Norm X,Y,Z do not affect the E<sup>2</sup>-field uncertainty inside TSL (see Page 5).

<sup>B</sup> Numerical linearization parameter: uncertainty not required.

<sup>E</sup> Uncertainty is determined using the max. deviation from linear response applying rectangular distribution and is expressed for the square of the field value.



EX3DV4- SN:3842

January 25, 2021

**DASY/EASY - Parameters of Probe: EX3DV4 - SN:3842****Other Probe Parameters**

Sensor Arrangement	Triangular
Connector Angle (°)	-122.1
Mechanical Surface Detection Mode	enabled
Optical Surface Detection Mode	disabled
Probe Overall Length	337 mm
Probe Body Diameter	10 mm
Tip Length	9 mm
Tip Diameter	2.5 mm
Probe Tip to Sensor X Calibration Point	1 mm
Probe Tip to Sensor Y Calibration Point	1 mm
Probe Tip to Sensor Z Calibration Point	1 mm
Recommended Measurement Distance from Surface	1.4 mm

**Note:** Measurement distance from surface can be increased to 3-4 mm for an *Area Scan* job.

EX3DV4- SN:3842

January 25, 2021

**DASY/EASY - Parameters of Probe: EX3DV4 - SN:3842****Calibration Parameter Determined in Head Tissue Simulating Media**

f (MHz) <sup>c</sup>	Relative Permittivity <sup>f</sup>	Conductivity (S/m) <sup>f</sup>	ConvF X	ConvF Y	ConvF Z	Alpha <sup>g</sup>	Depth <sup>g</sup> (mm)	Unc (k=2)
150	52.3	0.76	11.56	11.56	11.56	0.00	1.00	± 13.3 %
450	43.5	0.87	10.09	10.09	10.09	0.15	1.25	± 13.3 %

<sup>c</sup> Frequency validity above 300 MHz of ± 100 MHz only applies for DASY v4.4 and higher (see Page 2), else it is restricted to ± 50 MHz. The uncertainty is the RSS of the ConvF uncertainty at calibration frequency and the uncertainty for the indicated frequency band. Frequency validity below 300 MHz is ± 10, 25, 40, 50 and 70 MHz for ConvF assessments at 30, 64, 128, 150 and 220 MHz respectively. Validity of ConvF assessed at 6 MHz is 4-9 MHz, and ConvF assessed at 13 MHz is 9-19 MHz. Above 5 GHz frequency validity can be extended to ± 110 MHz.

<sup>f</sup> At frequencies below 3 GHz, the validity of tissue parameters ( $\epsilon$  and  $\sigma$ ) can be relaxed to ± 10% if liquid compensation formula is applied to measured SAR values. At frequencies above 3 GHz, the validity of tissue parameters ( $\epsilon$  and  $\sigma$ ) is restricted to ± 5%. The uncertainty is the RSS of the ConvF uncertainty for indicated target tissue parameters.

<sup>g</sup> Alpha/Depth are determined during calibration. SPEAG warrants that the remaining deviation due to the boundary effect after compensation is always less than ± 1% for frequencies below 3 GHz and below ± 2% for frequencies between 3-6 GHz at any distance larger than half the probe tip diameter from the boundary.

EX3DV4- SN:3842

January 25, 2021

### Frequency Response of E-Field (TEM-Cell:ifi110 EXX, Waveguide: R22)

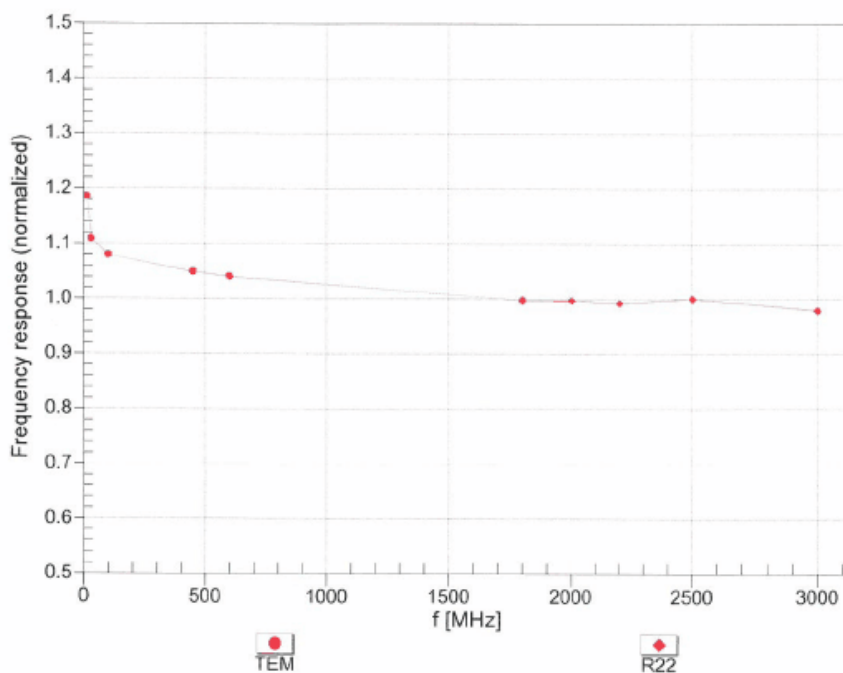

Uncertainty of Frequency Response of E-field:  $\pm 6.3\%$  ( $k=2$ )

EX3DV4- SN:3842

January 25, 2021

### Receiving Pattern ( $\phi$ ), $\theta = 0^\circ$

f=600 MHz,TEM

f=1800 MHz,R22

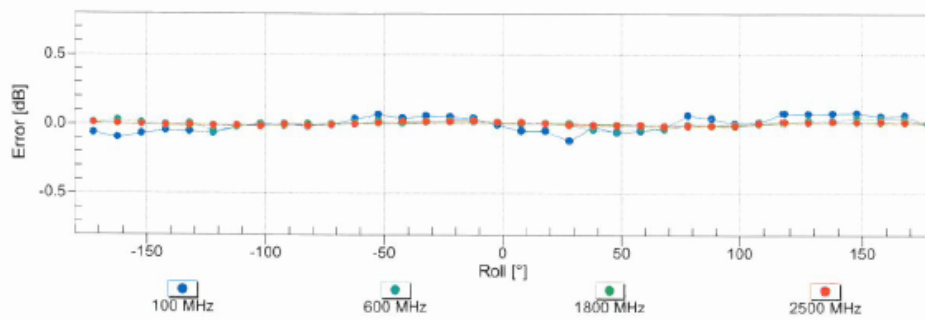
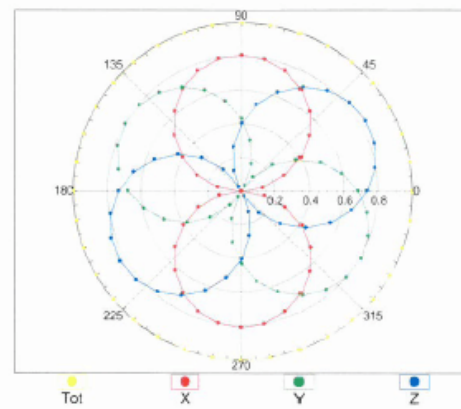
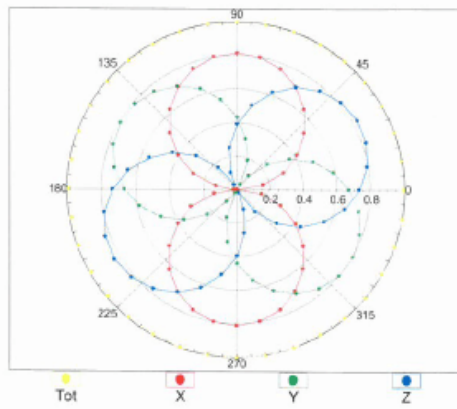

Uncertainty of Axial Isotropy Assessment:  $\pm 0.5\%$  (k=2)



EX3DV4- SN:3842

January 25, 2021

### Dynamic Range $f(SAR_{head})$ (TEM cell , $f_{eval} = 1900$ MHz)

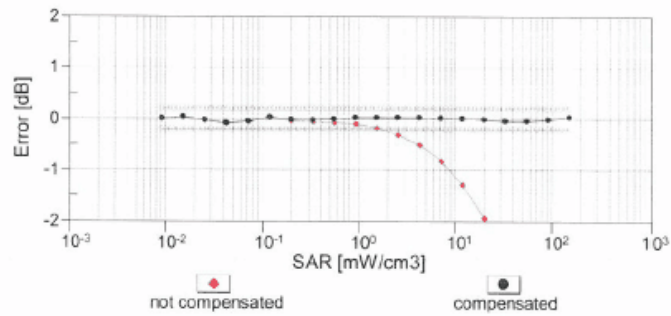
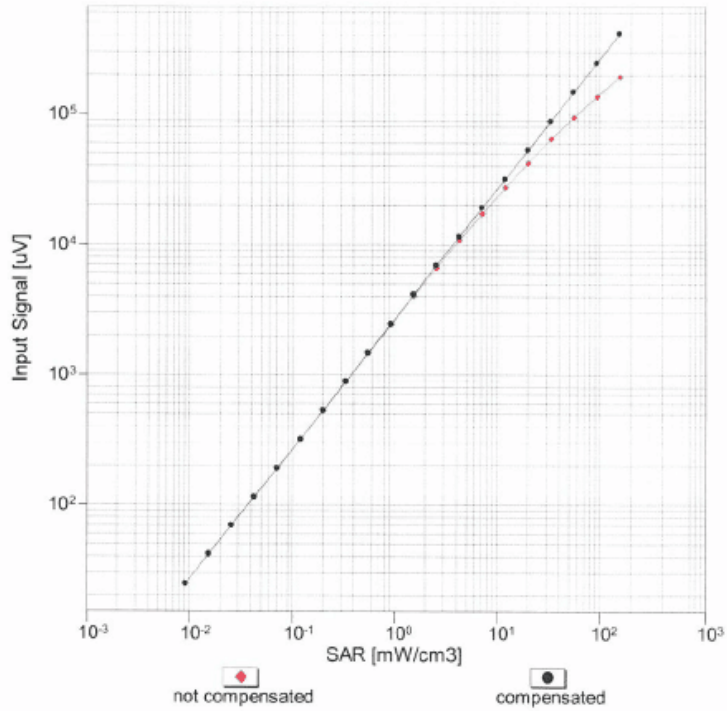

Uncertainty of Linearity Assessment:  $\pm 0.6\%$  (k=2)

EX3DV4- SN:3842

January 25, 2021

### Conversion Factor Assessment

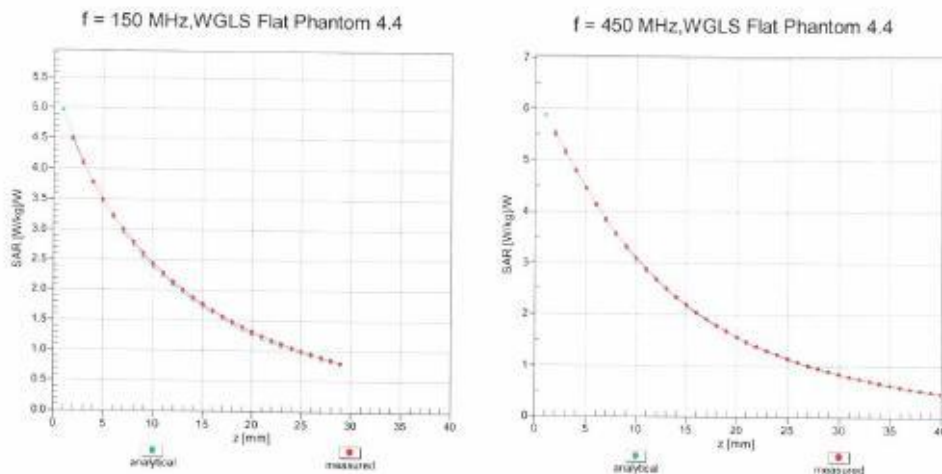

### Deviation from Isotropy in Liquid Error ( $\phi, \theta$ ), $f = 900$ MHz

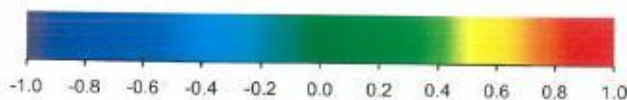
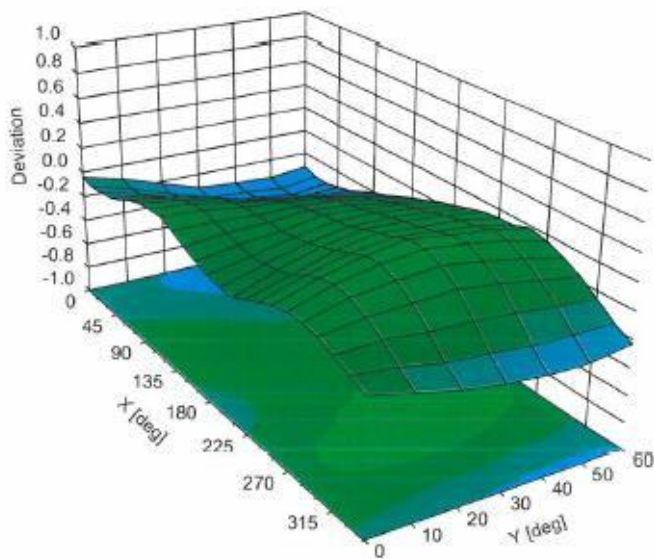

Uncertainty of Spherical Isotropy Assessment:  $\pm 2.6\%$  ( $k=2$ )

### 1.1. D450V3 Dipole Calibration Certificate

**Calibration Laboratory of  
Schmid & Partner  
Engineering AG**  
Zeughausstrasse 43, 8004 Zurich, Switzerland



**S** Schweizerischer Kalibrierdienst  
**C** Service suisse d'étalonnage  
**S** Servizio svizzero di taratura  
**S** Swiss Calibration Service

Accredited by the Swiss Accreditation Service (SAS)  
The Swiss Accreditation Service is one of the signatories to the EA  
Multilateral Agreement for the recognition of calibration certificates

Accreditation No.: **SCS 0108**

Client **HTW (Auden)**

Certificate No: **D450V3-1102\_Jan21**

CALIBRATION CERTIFICATE			
Object	D450V3 - SN:1102		
Calibration procedure(s)	QA CAL-15.v9 Calibration Procedure for SAR Validation Sources below 700 MHz		
Calibration date:	January 20, 2021		
This calibration certificate documents the traceability to national standards, which realize the physical units of measurements (SI). The measurements and the uncertainties with confidence probability are given on the following pages and are part of the certificate.			
All calibrations have been conducted in the closed laboratory facility; environment temperature (22 ± 3)°C and humidity < 70%.			
Calibration Equipment used (M&TE critical for calibration)			
Primary Standards	ID #	Cal Date (Certificate No.)	Scheduled Calibration
Power meter NRP	SN: 104778	01-Apr-20 (No. 217-03100/03101)	Apr-21
Power sensor NRP-Z91	SN: 103244	01-Apr-20 (No. 217-03100)	Apr-21
Power sensor NRP-Z91	SN: 103245	01-Apr-20 (No. 217-03101)	Apr-21
Reference 20 dB Attenuator	SN: CC2552 (20x)	31-Mar-20 (No. 217-03106)	Apr-21
Type-N mismatch combination	SN: 310982 / 06327	31-Mar-20 (No. 217-03104)	Apr-21
Reference Probe EX3DV4	SN: 3877	30-Dec-20 (No. EX3-3877_Dec20)	Dec-21
DAE4	SN: 654	26-Jun-20 (No. DAE4-654_Jun20)	Jun-21
Secondary Standards	ID #	Check Date (in house)	Scheduled Check
Power meter E4419B	SN: GB41293874	06-Apr-16 (in house check Jun-20)	In house check: Jun-22
Power sensor E4412A	SN: MY41498087	06-Apr-16 (in house check Jun-20)	In house check: Jun-22
Power sensor E4412A	SN: 000110210	06-Apr-16 (in house check Jun-20)	In house check: Jun-22
RF generator HP 8648C	SN: US3642U01700	04-Aug-99 (in house check Jun-20)	In house check: Jun-22
Network Analyzer Agilent E8358A	SN: US41080477	31-Mar-14 (in house check Oct-20)	In house check: Oct-21
Calibrated by:	Name Michael Weber	Function Laboratory Technician	Signature 
Approved by:	Katja Pokovic	Technical Manager	
			Issued: January 21, 2021
This calibration certificate shall not be reproduced except in full without written approval of the laboratory.			

**Calibration Laboratory of**  
 Schmid & Partner  
 Engineering AG  
 Zeughausstrasse 43, 8004 Zurich, Switzerland



**S** Schweizerischer Kalibrierdienst  
**C** Service suisse d'étalonnage  
**S** Servizio svizzero di taratura  
**S** Swiss Calibration Service

Accredited by the Swiss Accreditation Service (SAS)  
 The Swiss Accreditation Service is one of the signatories to the EA  
 Multilateral Agreement for the recognition of calibration certificates

Accreditation No.: **SCS 0108**

**Glossary:**

TSL tissue simulating liquid  
 ConvF sensitivity in TSL / NORM x,y,z  
 N/A not applicable or not measured

**Calibration is Performed According to the Following Standards:**

- a) IEEE Std 1528-2013, "IEEE Recommended Practice for Determining the Peak Spatial-Averaged Specific Absorption Rate (SAR) in the Human Head from Wireless Communications Devices: Measurement Techniques", June 2013
- b) IEC 62209-1, "Measurement procedure for the assessment of Specific Absorption Rate (SAR) from hand-held and body-mounted devices used next to the ear (frequency range of 300 MHz to 6 GHz)", July 2016
- c) IEC 62209-2, "Procedure to determine the Specific Absorption Rate (SAR) for wireless communication devices used in close proximity to the human body (frequency range of 30 MHz to 6 GHz)", March 2010
- d) KDB 865664, "SAR Measurement Requirements for 100 MHz to 6 GHz"

**Additional Documentation:**

- e) DASY4/5 System Handbook

**Methods Applied and Interpretation of Parameters:**

- *Measurement Conditions:* Further details are available from the Validation Report at the end of the certificate. All figures stated in the certificate are valid at the frequency indicated.
- *Antenna Parameters with TSL:* The dipole is mounted with the spacer to position its feed point exactly below the center marking of the flat phantom section, with the arms oriented parallel to the body axis.
- *Feed Point Impedance and Return Loss:* These parameters are measured with the dipole positioned under the liquid filled phantom. The impedance stated is transformed from the measurement at the SMA connector to the feed point. The Return Loss ensures low reflected power. No uncertainty required.
- *Electrical Delay:* One-way delay between the SMA connector and the antenna feed point. No uncertainty required.
- *SAR measured:* SAR measured at the stated antenna input power.
- *SAR normalized:* SAR as measured, normalized to an input power of 1 W at the antenna connector.
- *SAR for nominal TSL parameters:* The measured TSL parameters are used to calculate the nominal SAR result.

The reported uncertainty of measurement is stated as the standard uncertainty of measurement multiplied by the coverage factor k=2, which for a normal distribution corresponds to a coverage probability of approximately 95%.

## Appendix F: Dipole Calibration Certificate

### Measurement Conditions

DASY system configuration, as far as not given on page 1.

<b>DASY Version</b>	DASY5	V52.10.4
<b>Extrapolation</b>	Advanced Extrapolation	
<b>Phantom</b>	ELI4 Flat Phantom	Shell thickness: $2 \pm 0.2$ mm
<b>Distance Dipole Center - TSL</b>	15 mm	with Spacer
<b>Zoom Scan Resolution</b>	dx, dy, dz = 5 mm	
<b>Frequency</b>	450 MHz $\pm$ 1 MHz	

### Head TSL parameters

The following parameters and calculations were applied.

	Temperature	Permittivity	Conductivity
<b>Nominal Head TSL parameters</b>	22.0 °C	43.5	0.87 mho/m
<b>Measured Head TSL parameters</b>	(22.0 $\pm$ 0.2) °C	43.7 $\pm$ 6 %	0.87 mho/m $\pm$ 6 %
<b>Head TSL temperature change during test</b>	< 0.5 °C	----	----

### SAR result with Head TSL

<b>SAR averaged over 1 cm<sup>3</sup> (1 g) of Head TSL</b>	Condition	
SAR measured	250 mW input power	1.15 W/kg
SAR for nominal Head TSL parameters	normalized to 1W	<b>4.60 W/kg <math>\pm</math> 18.1 % (k=2)</b>

<b>SAR averaged over 10 cm<sup>3</sup> (10 g) of Head TSL</b>	condition	
SAR measured	250 mW input power	0.771 W/kg
SAR for nominal Head TSL parameters	normalized to 1W	<b>3.09 W/kg <math>\pm</math> 17.6 % (k=2)</b>

**Appendix (Additional assessments outside the scope of SCS 0108)**

**Antenna Parameters with Head TSL**

Impedance, transformed to feed point	57.4 $\Omega$ - 3.8 j $\Omega$
Return Loss	- 22.2 dB

**General Antenna Parameters and Design**

Electrical Delay (one direction)	1.346 ns
----------------------------------	----------

After long term use with 100W radiated power, only a slight warming of the dipole near the feedpoint can be measured.

The dipole is made of standard semirigid coaxial cable. The center conductor of the feeding line is directly connected to the second arm of the dipole. The antenna is therefore short-circuited for DC-signals. On some of the dipoles, small end caps are added to the dipole arms in order to improve matching when loaded according to the position as explained in the "Measurement Conditions" paragraph. The SAR data are not affected by this change. The overall dipole length is still according to the Standard.

No excessive force must be applied to the dipole arms, because they might bend or the soldered connections near the feedpoint may be damaged.

**Additional EUT Data**

Manufactured by	SPEAG
-----------------	-------



**DASY5 Validation Report for Head TSL**

Date: 20.01.2021

Test Laboratory: SPEAG, Zurich, Switzerland

**DUT: Dipole 450 MHz; Type: D450V3; Serial: D450V3 - SN:1102**

Communication System: UID 0 - CW; Frequency: 450 MHz  
Medium parameters used:  $f = 450$  MHz;  $\sigma = 0.87$  S/m;  $\epsilon_r = 43.7$ ;  $\rho = 1000$  kg/m<sup>3</sup>  
Phantom section: Flat Section  
Measurement Standard: DASY5 (IEEE/IEC/ANSI C63.19-2011)

DASY52 Configuration:

- Probe: EX3DV4 - SN3877; ConvF(10.64, 10.64, 10.64) @ 450 MHz; Calibrated: 30.12.2020
- Sensor-Surface: 1.4mm (Mechanical Surface Detection)
- Electronics: DAE4 Sn654; Calibrated: 26.06.2020
- Phantom: ELI v4.0; Type: QDOVA001BB; Serial: TP:1003
- DASY52 52.10.4(1527); SEMCAD X 14.6.14(7483)

**Dipole Calibration for Head Tissue/d=15mm, Pin=250mW/Zoom Scan (7x7x7)/Cube 0:**

Measurement grid: dx=5mm, dy=5mm, dz=5mm  
Reference Value = 39.07 V/m; Power Drift = -0.00 dB  
Peak SAR (extrapolated) = 1.78 W/kg  
**SAR(1 g) = 1.15 W/kg; SAR(10 g) = 0.771 W/kg**  
Smallest distance from peaks to all points 3 dB below: Larger than measurement grid (> 30mm)  
Ratio of SAR at M2 to SAR at M1 = 64.6%  
Maximum value of SAR (measured) = 1.55 W/kg

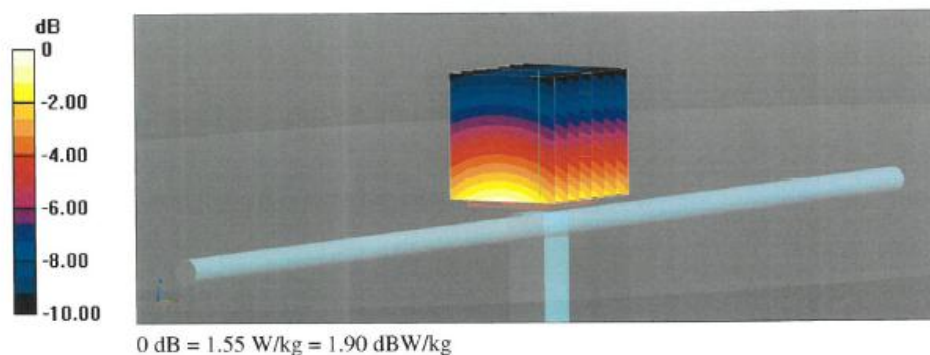

# Appendix F: Dipole Calibration Certificate

## Impedance Measurement Plot for Head TSL

