

No. 1 Workshop, M-10, Middle section, Science & Technology Park,  
Nanshan District, Shenzhen, Guangdong, China 518057

Telephone: +86 (0) 755 2601 2053  
Fax: +86 (0) 755 2671 0594  
Email: ee.shenzhen@sgs.com

Report No.: SZEM130800479403  
Page : 1 of 34

# FCC SAR TEST REPORT

**Application No.:** SZEM1308004794RF  
**Applicant:** Lexibook America  
**Manufacturer:** Jungle Tac Interactive Co., Ltd  
**Factory:** ATS ELECTRONICS (SHENZHEN) CO., LTD  
**Product Name:** 8inch Tablet  
**Model No.(EUT):** MFC181  
**Trade mark:** Lexibook  
**FCC ID:** UU8-MFC09  
**Standards:** IEEE Std C95(1991)  
IEEE1528(2003)  
OET Bulletin No. 65, Supplement C (2001)  
**Date of Receipt:** 2013-09-03  
**Date of Test:** 2013-09-04 to 2013-09-04  
**Date of Issue:** 2013-11-29  
**Test Result :** **PASS \***

\* In the configuration tested, the EUT detailed in this report complied with the standards specified above.

Authorized Signature:



Jack Zhang  
EMC Laboratory Manager

The manufacturer should ensure that all products in series production are in conformity with the product sample detailed in this report. If the product in this report is used in any configuration other than that detailed in the report, the manufacturer must ensure the new system complies with all relevant standards. Any mention of SGS International Electrical Approvals or testing done by SGS International Electrical Approvals in connection with, distribution or use of the product described in this report must be approved by SGS International Electrical Approvals in writing.

The report must not be used by the client to claim product certification, approval, or endorsement by NVLAP, NIST, or any agency of the federal government. All test results in this report can be traceable to National or International Standards.

"This document is issued by the Company subject to its General Conditions of Service printed overleaf, available on request or accessible at [www.sgs.com/terms\\_and\\_conditions.htm](http://www.sgs.com/terms_and_conditions.htm) and, for electronic format documents, subject to Terms and Conditions for Electronic Documents at [www.sgs.com/terms\\_e-document.htm](http://www.sgs.com/terms_e-document.htm). Attention is drawn to the limitation of liability, indemnification and jurisdiction issues defined therein. Any holder of this document is advised that information contained hereon reflects the Company's findings at the time of its intervention only and within the limits of Client's instructions, if any. The Company's sole responsibility is to its Client and this document does not exonerate parties to a transaction from exercising all their rights and obligations under the transaction documents. This document cannot be reproduced except in full, without prior written approval of the Company. Any unauthorized alteration, forgery or falsification of the content or appearance of this document is unlawful and offenders may be prosecuted to the fullest extent of the law. Unless otherwise stated the results shown in this test report refer only to the sample(s) tested and such sample(s) are retained for 90 days only."



## 2 Test Summary

Frequency Band	Test position	Test Ch. /Freq.	Max average SAR1-g(W/kg)	Conducted power (dBm)	Tune up Limit (dBm)	Scaling Factor	Scaled SAR (W/kg)	SAR limit (W/kg)	verdict
WIFI (2.4GHz)	Body	11/2462	0.583	16.68	17.50	1.208	<b>0.704</b>	1.6	PASS

Remark: The maximum Scaled SAR value of **Body** is **0.704** W/kg.



### 3 Contents

	Page
1 COVER PAGE.....	1
2 TEST SUMMARY.....	2
3 CONTENTS.....	3
4 GENERAL INFORMATION.....	5
4.1 DETAILS OF APPLICANT.....	5
4.2 DETAILS OF MANUFACTURER.....	5
4.3 DETAILS OF MANUFACTURER.....	5
4.4 GENERAL DESCRIPTION OF EUT.....	6
4.5 DESCRIPTION OF SUPPORT UNITS.....	7
4.6 TEST LOCATION.....	7
4.7 TEST FACILITY.....	7
4.8 DEVIATION FROM STANDARDS.....	7
4.9 ABNORMALITIES FROM STANDARD CONDITIONS.....	7
4.10 OTHER INFORMATION REQUESTED BY THE CUSTOMER.....	7
4.11 TEST STANDARDS.....	8
4.12 RF EXPOSURE LIMITS.....	8
4.13 MEASUREMENT UNCERTAINTY.....	9
5 EQUIPMENTS USED DURING TEST.....	11
5.1 SPEAG DASY4.....	11
5.2 THE SAR MEASUREMENT SYSTEM.....	12
5.3 ISOTROPIC E-FIELD PROBE ES3DV3.....	13
5.4 DATA ACQUISITION ELECTRONICS (DAE).....	14
5.5 SAM TWIN PHANTOM.....	14
5.6 ELI PHANTOM.....	15
5.7 DEVICE HOLDER FOR TRANSMITTERS.....	16
6 DESCRIPTION OF TEST POSITION.....	17
6.1 THE BODY TEST POSITION.....	17
7 SAR SYSTEM VERIFICATION PROCEDURE.....	18
7.1 TISSUE SIMULATE LIQUID.....	18
7.1.1 Recipes for Tissue Simulate Liquid.....	18
7.1.2 Measurement for Tissue Simulate Liquid.....	19
7.2 SAR SYSTEM VALIDATION.....	20
7.2.1 Summary System Validation Result(s).....	21
7.2.2 Detailed System Validation Results.....	22
8 TEST RESULTS AND MEASUREMENT DATA.....	23
8.1 OPERATION CONFIGURATIONS.....	23
8.1.1 WiFi Test Configuration.....	23
8.2 MEASUREMENT PROCEDURE.....	23
8.2.1 Scanning procedure.....	23
8.2.2 Data Storage.....	24
8.2.3 Data Evaluation by SEMCAD.....	24
8.3 MEASUREMENT OF RF CONDUCTED POWER.....	26
8.3.1 Conducted Power Of WIFI.....	26
8.3.2 Conducted Power Of BT.....	26
8.4 MEASUREMENT OF SAR AVERAGE VALUE.....	27

"This document is issued by the Company subject to its General Conditions of Service printed overleaf, available on request or accessible at [www.sgs.com/terms\\_and\\_conditions.htm](http://www.sgs.com/terms_and_conditions.htm) and, for electronic format documents, subject to Terms and Conditions for Electronic Documents at [www.sgs.com/terms\\_e-document.htm](http://www.sgs.com/terms_e-document.htm). Attention is drawn to the limitation of liability, indemnification and jurisdiction issues defined therein. Any holder of this document is advised that information contained hereon reflects the Company's findings at the time of its intervention only and within the limits of Client's instructions, if any. The Company's sole responsibility is to its Client and this document does not exonerate parties to a transaction from exercising all their rights and obligations under the transaction documents. This document cannot be reproduced except in full, without prior written approval of the Company. Any unauthorized alteration, forgery or falsification of the content or appearance of this document is unlawful and offenders may be prosecuted to the fullest extent of the law. Unless otherwise stated the results shown in this test report refer only to the sample(s) tested and such sample(s) are retained for 90 days only."



---

8.4.1	SAR Result Of WIFI.....	27
<b>8.5</b>	<b>MULTIPLE (SINGLE) TRANSMITTER EVALUATION.....</b>	<b>28</b>
8.5.1	DUT Antenna Locations.....	28
8.5.2	EUT side for SAR Testing.....	28
8.5.3	Stand-alone SAR.....	29
8.5.4	Simultaneous SAR.....	29
<b>8.6</b>	<b>DETAILED TEST RESULTS.....</b>	<b>30</b>
<b>9</b>	<b>PHOTOGRAPHS.....</b>	<b>31</b>
9.1	EUT TEST SETUP.....	31
9.2	PHOTOGRAPHS OF EUT.....	31
9.3	PHOTOGRAPHS OF EUT TEST POSITION.....	32
9.4	PHOTOGRAPHS OF TISSUE SIMULATE LIQUID.....	33
9.5	EUT CONSTRUCTIONAL DETAILS.....	33
<b>10</b>	<b>CALIBRATION CERTIFICATE.....</b>	<b>33</b>
	<b>APPENDIX A : DETAILED SYSTEM VALIDATION RESULTS.....</b>	<b>34</b>
	<b>APPENDIX B: DETAILED TEST RESULTS.....</b>	<b>34</b>
	<b>APPENDIX C: CALIBRATION CERTIFICATE.....</b>	<b>34</b>



## 4 General Information

### 4.1 Details of Applicant

Name:	Lexibook America
Address:	C/O NATXIS PRAMEX INTERNATIONAL – NORTH AMERICA 1251 avenue of the Americas 34 <sup>th</sup> floor
Telephone:	212 583 4920
Contact:	Justin
Email:	justintan@lexibook.com

### 4.2 Details of Manufacturer

Name:	Jungle Tac Interactive Co., Ltd
Address:	A/F, Shanshui Building, Nanshan Yungu No.1183, Liuxian Road, Xili Town, Nanshan District, Shenzhen

### 4.3 Details of Manufacturer

Name:	ATS ELECTRONICS (SHENZHEN) CO., LTD
Address:	4/F, Block C, Xufa Science & Technology park, No.2 Industrial Zone, Fenghuang, Fuyong. Shenzhen, China 518103

#### 4.4 General Description of EUT

Product Name:	8inch Tablet		
Model No.:	MFC181		
Trade mark:	Lexibook		
Device Type :	portable device		
Product Phase:	production unit		
Exposure Category:	uncontrolled environment / general population		
Hardware Version:	k8-130601		
Software Version:	Android 4.2.2		
FC ID:	UU8-MFC09		
Battery Information	Normal Voltage :3.7V		
	Charging Voltage :5V		
	Rated capacity :5000mAh		
	Battery Type :Rechargeable Li-ion Battery		
	Model: N/A		
Antenna Type:	Inner Antenna		
Frequency Bands:	Band	Tx (MHz)	Rx (MHz)
	WIFI	2412-2462	2412-2462
	BT	2402-2480	2402-2480
Modulation Mode:	<b>WIFI:</b> IEEE for 802.11b: DSSS(CCK,DQPSK,DBPSK) IEEE for 802.11g: OFDM(64QAM, 16QAM, QPSK, BPSK) IEEE for 802.11n(T20 and T40) : OFDM (64QAM, 16QAM, QPSK,BPSK) <b>BT:</b> GFSK, $\pi/4$ DQPSK,8DPSK		
Serial Number:	NA		
IMEI:	NA		

## 4.5 Description of Support Units

The EUT has been tested independently.

## 4.6 Test Location

All tests were performed at:

SGS-CSTC Standards Technical Services Co., Ltd. Shenzhen Branch E&E Lab  
No. 1 Workshop, M-10, Middle section, Science & Technology Park, Shenzhen, Guangdong, China  
518057  
Telephone: +86 (0) 755 2601 2053 Fax: +86 (0) 755 2671 0594

No tests were sub-contracted.

## 4.7 Test Facility

The test facility is recognized, certified, or accredited by the following organizations:

- **CNAS (No. CNAS L2929)**

CNAS has accredited SGS-CSTC Standards Technical Services Co., Ltd. Shenzhen Branch EMC Lab to ISO/IEC 17025:2005 General Requirements for the Competence of Testing and Calibration Laboratories (CNAS-CL01 Accreditation Criteria for the Competence of Testing and Calibration Laboratories) for the competence in the field of testing.

- **VCCI**

The 3m Semi-anechoic chamber, Full-anechoic Chamber and Shielded Room (7.5m x 4.0m x 3.0m) of SGS-CSTC Standards Technical Services Co., Ltd. have been registered in accordance with the Regulations for Voluntary Control Measures with Registration No.: R-2197, G-416, T-1153 and C-2383 respectively.

- **FCC – Registration No.: 556682**

SGS-CSTC Standards Technical Services Co., Ltd., Shenzhen EMC Laboratory has been registered and fully described in a report filed with the (FCC) Federal Communications Commission. The acceptance letter from the FCC is maintained in our files. Registration No.: 556682.

- **Industry Canada (IC)**

Two 3m Semi-anechoic chambers of SGS-CSTC Standards Technical Services Co., Ltd. have been registered by Certification and Engineering Bureau of Industry Canada for radio equipment testing with Registration No.: 4620C-1 & 4620C-2.

## 4.8 Deviation from Standards

None

## 4.9 Abnormalities from Standard Conditions

None

## 4.10 Other Information Requested by the Customer

None



### 4.11 Test Standards

Identity	Document Title
IEEE Std C95.1 – 1991	IEEE Standard for Safety Levels with Respect to Human Exposure to Radio Frequency Electromagnetic Fields, 3 kHz – 300 GHz.
IEEE 1528-2003	Recommended Practice for Determining the Peak Spatial-Average Specific Absorption Rate (SAR) in the Human Head from Wireless Communications Devices: Measurement Techniques
OET Bulletin No. 65, Supplement C– 2001	Evaluating Compliance with FCC Guidelines for Human Exposure to Radiofrequency Electromagnetic Fields---Additional Information for Evaluating Compliance of Mobile and Portable Devices with FCC Limits for Human Exposure to Radiofrequency Emissions
Canada’s Safety Code 6	Limits of Human Exposure to Radiofrequency Electromagnetic Fields in the Frequency Range from 3 kHz to 300 GHz (99-EHD-237)
RSS-102	Radio Frequency Exposure Compliance of Radio communication Apparatus (All Frequency Bands (Issue 4 of March 2010)
KDB447498 D01	General RF Exposure Guidance v05r01
KDB616217 D04	SAR for laptop and tablets v01r01
KDB 248227 D01	SAR meas for 802 11 a b g v01r02
KDB 865664 D01	SAR Measurement 100 MHz to 6 GHz v01r01

### 4.12 RF exposure limits

Human Exposure	Uncontrolled Environment General Population	Controlled Environment Occupational
<b>Spatial Peak SAR*</b> (Brain)	1.60 mW/g	8.00 mW/g
<b>Spatial Average SAR**</b> (Whole Body)	0.08 mW/g	0.40 mW/g
<b>Spatial Peak SAR***</b> (Hands/Feet/Ankle/Wrist)	4.00 mW/g	20.00 mW/g

**Notes:**

\* The Spatial Peak value of the SAR averaged over any 1 gram of tissue (defined as a tissue volume in the shape of a cube) and over the appropriate averaging time

\*\* The Spatial Average value of the SAR averaged over the whole body.

\*\*\* The Spatial Peak value of the SAR averaged over any 10 grams of tissue (defined as a tissue volume in the shape of a cube) and over the appropriate averaging time.

**Uncontrolled Environments** are defined as locations where there is the exposure of individuals who have no knowledge or control of their exposure.

**Controlled Environments** are defined as locations where there is exposure that may be incurred by persons who are aware of the potential for exposure, (i.e. as a result of employment or occupation.)

“This document is issued by the Company subject to its General Conditions of Service printed overleaf, available on request or accessible at [www.sgs.com/terms\\_and\\_conditions.htm](http://www.sgs.com/terms_and_conditions.htm) and, for electronic format documents, subject to Terms and Conditions for Electronic Documents at [www.sgs.com/terms\\_e-document.htm](http://www.sgs.com/terms_e-document.htm). Attention is drawn to the limitation of liability, indemnification and jurisdiction issues defined therein. Any holder of this document is advised that information contained hereon reflects the Company’s findings at the time of its intervention only and within the limits of Client’s instructions, if any. The Company’s sole responsibility is to its Client and this document does not exonerate parties to a transaction from exercising all their rights and obligations under the transaction documents. This document cannot be reproduced except in full, without prior written approval of the Company. Any unauthorized alteration, forgery or falsification of the content or appearance of this document is unlawful and offenders may be prosecuted to the fullest extent of the law. Unless otherwise stated the results shown in this test report refer only to the sample(s) tested and such sample(s) are retained for 90 days only.”





### 4.13 Measurement Uncertainty

Measurements and results are all in compliance with the standards listed in section 12 of this report. All measurements and results are recorded and maintained at the laboratory performing the tests and measurement uncertainties are taken into account when comparing measurements to pass/ fail criteria. The Expanded uncertainty(95% CONFIDENCE INTERVAL) is **20.86%**.

A	b1	c	d	e = f(d,k)	g	i = C*g/e	k
Uncertainty Component	Section in P1528	Tol (%)	Prob . Dist.	Div.	Ci (1g)	1g ui (%)	Vi (Veff)
Probe calibration	E.2.1	6.3	N	1	1	6.3	∞
Axial isotropy	E.2.2	0.5	R	$\sqrt{3}$	$(1 - c_p)^{1/2}$	0.20	∞
hemispherical isotropy	E.2.2	2.6	R	$\sqrt{3}$	$\sqrt{c_p}$	1.06	∞
Boundary effect	E.2.3	0.8	R	$\sqrt{3}$	1	0.46	∞
Linearity	E.2.4	0.6	R	$\sqrt{3}$	1	0.35	∞
System detection limit	E.2.5	0.25	R	$\sqrt{3}$	1	0.15	∞
Readout electronics	E.2.6	0.3	N	1	1	0.3	∞
Response time	E.2.7	0	R	$\sqrt{3}$	1	0	∞
Integration time	E.2.8	2.6	R	$\sqrt{3}$	1	1.5	∞
RF ambient Condition –Noise	E.6.1	3	R	$\sqrt{3}$	1	1.73	∞
RF ambient Condition - reflections	E.6.1	3	R	$\sqrt{3}$	1	1.73	∞
Probe positioning- mechanical tolerance	E.6.2	1.5	R	$\sqrt{3}$	1	0.87	∞
Probe positioning- with respect to phantom	E.6.3	2.9	R	$\sqrt{3}$	1	1.67	∞
Max. SAR evaluation	E.5.2	1	R	$\sqrt{3}$	1	0.58	∞
Test sample positioning	E.4.2	4	N	1	1	3.7	9
Device holder uncertainty	E.4.1	3.6	N	1	1	3.6	∞
Output power variation –SAR drift measurement	6.62	5	R	$\sqrt{3}$	1	2.89	∞
Phantom uncertainty (shape and thickness tolerances)	E.3.1	4	R	$\sqrt{3}$	1	2.31	∞
Liquid conductivity - deviation from target values	E.3.2	5	R	$\sqrt{3}$	0.64	1.85	∞
Liquid conductivity	E.3.2	4	N	1	0.64	2.56	5

"This document is issued by the Company subject to its General Conditions of Service printed overleaf, available on request or accessible at [www.sgs.com/terms\\_and\\_conditions.htm](http://www.sgs.com/terms_and_conditions.htm) and, for electronic format documents, subject to Terms and Conditions for Electronic Documents at [www.sgs.com/terms\\_e-document.htm](http://www.sgs.com/terms_e-document.htm). Attention is drawn to the limitation of liability, indemnification and jurisdiction issues defined therein. Any holder of this document is advised that information contained hereon reflects the Company's findings at the time of its intervention only and within the limits of Client's instructions, if any. The Company's sole responsibility is to its Client and this document does not exonerate parties to a transaction from exercising all their rights and obligations under the transaction documents. This document cannot be reproduced except in full, without prior written approval of the Company. Any unauthorized alteration, forgery or falsification of the content or appearance of this document is unlawful and offenders may be prosecuted to the fullest extent of the law. Unless otherwise stated the results shown in this test report refer only to the sample(s) tested and such sample(s) are retained for 90 days only."



- measurement uncertainty							
Liquid permittivity - deviation from target values	E.3.3	5	R	$\sqrt{3}$	0.6	1.73	$\infty$
Liquid permittivity - measurement uncertainty	E.3.3	4	N	1	0.6	2.40	5
Combined standard uncertainty				RSS		10.43	430
Expanded uncertainty (95% CONFIDENCE INTERVAL)				K=2		<b>20.86</b>	

Table 1 : Measurement Uncertainty

## 5 Equipments Used during Test

### 5.1 SPEAG DASY4

Test Platform		SPEAG DASY4 Professional			
Location		SGS-CSTC Standards Technical Services Co., Ltd. Shenzhen Branch E&E Lab			
Description		SAR Test System (Frequency range 300MHz-3GHz) 835, 900, 1800, 1900, 2000, 2450 frequency band			
Software Reference		DASY4: V4.7 Build 80 SEMCAD: V1.8 Build 186			
<b>Hardware Reference</b>					
	Model	Equipment	Serial Number	Calibration Date	Due date of calibration
<input checked="" type="checkbox"/>	Robot	RX90L	F03/5V32A1/A01	NA	NA
<input checked="" type="checkbox"/>	Twin Phantom	SAM 1	TP-1283	NA	NA
<input type="checkbox"/>	Flat Phantom	ELI 5.0	1128	NA	NA
<input checked="" type="checkbox"/>	DAE	DAE3	569	2012-11-27	2013-11-26
<input checked="" type="checkbox"/>	E-Field Probe	ES3DV3	3088	2012-11-26	2013-11-25
<input type="checkbox"/>	Validation Kits	D835V2	4d015	2012-11-26	2013-11-25
<input type="checkbox"/>	Validation Kits	D1900V2	184	2012-11-26	2013-11-25
<input checked="" type="checkbox"/>	Validation Kits	D2450V2	733	2012-11-26	2013-11-25
<input checked="" type="checkbox"/>	Agilent Network Analyzer	E5071B	MY42100549	2013-04-16	2014-04-15
<input checked="" type="checkbox"/>	Dielectric Probe Kit	85070D	US01440210	NA	NA
<input checked="" type="checkbox"/>	R&S Universal Radio Communication Tester	CMU200	103633	2013-04-05	2014-04-04
<input checked="" type="checkbox"/>	RF Bi-Directional Coupler	ZABDC20-252H-N+	NA	2013-04-16	2014-04-15
<input checked="" type="checkbox"/>	Agilent Signal Generator	E4438C	MY42082326	2013-04-03	2014-04-02
<input checked="" type="checkbox"/>	Mini-Circuits Preamplifier	ZHL-42	D041905	2013-04-12	2014-04-11
<input checked="" type="checkbox"/>	Agilent Power Meter	E4416A	GB41292095	2013-04-16	2014-04-15
<input checked="" type="checkbox"/>	Agilent Power Sensor	8481H	MY41091234	2013-04-16	2014-04-15
<input checked="" type="checkbox"/>	R&S Power Sensor	NRP-Z92	100025	2013-04-16	2014-04-15
<input checked="" type="checkbox"/>	Attenuator	TS2-3dB	30704	2013-04-08	2014-04-07
<input checked="" type="checkbox"/>	Coaxial low pass filter	VLF-2500(+)	NA	2013-04-08	2014-04-07
<input checked="" type="checkbox"/>	50 Ω coaxial load	KARN-50+	00850	2013-04-15	2014-04-14
<input checked="" type="checkbox"/>	DC POWER SUPPLY	SK1730SL5A	NA	2013-04-07	2014-04-06

Note: All the test equipments are calibrated once a year.

## 5.2 The SAR Measurement System

A photograph of the SAR measurement System is given in F-1.

This SAR Measurement System uses a Computer-controlled 3-D stepper motor system (Speag Dasy 4 professional system). A Model ES3DV3 3088 E-field probe is used to determine the internal electric fields. The SAR can be obtained from the equation  $SAR = \sigma (|E|^2) / \rho$  where  $\sigma$  and  $\rho$  are the conductivity and mass density of the tissue-Simulate.

The DASY4 system for performing compliance tests consists of the following items:

A standard high precision 6-axis robot (Stabile RX family) with controller, teach pendant and software. An arm extension for accommodation the data acquisition electronics (DAE).

A dosimetric probe, i.e., an isotropic E-field probe optimized and calibrated for usage in tissue simulating liquid. The probe is equipped with an optical surface detector system.

A data acquisition electronics (DAE) which performs the signal amplification, signal multiplexing, AD-conversion, offset measurements, mechanical surface detection, collision detection, etc. The unit is battery powered with standard or rechargeable batteries. The signal is optically transmitted to the EOC.

The Electro-optical converter (EOC) performs the conversion between optical and electrical of the signals for the digital communication to DAE and for the analog signal from the optical surface detection. The EOC is connected to the measurement server.

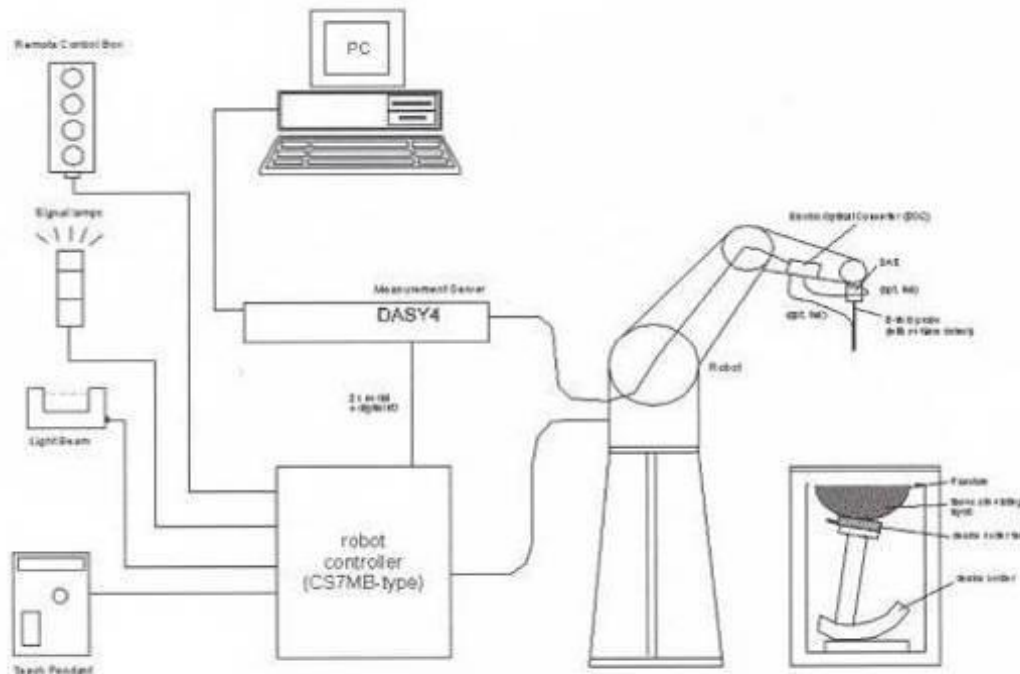

F-1. SAR System Configuration

- The function of the measurement server is to perform the time critical tasks such as signal filtering, control of the robot operation and fast movement interrupts.
- A probe alignment unit which improves the (absolute) accuracy of the probe positioning.
- A computer operating Windows XP.
- DASY4 software.
- Remote control with teach pendant and additional circuitry for robot safety such as warning lamps, etc.
- The SAM twin phantom enabling testing left-hand, right-hand and Body Worn usage.
- The device holder for handheld mobile phones.
- Tissue simulating liquid mixed according to the given recipes.
- Validation dipole kits allowing to validating the proper functioning of the system.

### 5.3 Isotropic E-field Probe ES3DV3

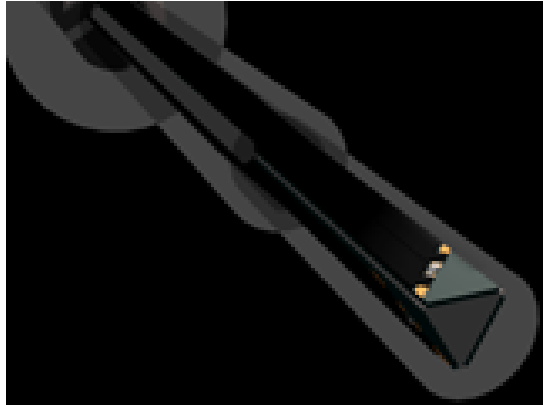
	<p>Symmetrical design with triangular core          Interleaved sensors          Built-in shielding against static charges          PEEK enclosure material (resistant to organic solvents, e.g., DGBE)</p>
<p><b>Calibration</b></p>	<p>ISO/IEC 17025 <a href="#">calibration service</a> available.</p>
<p><b>Frequency</b></p>	<p>10 MHz to 4 GHz;          Linearity: <math>\pm 0.2</math> dB (30 MHz to 4 GHz)</p>
<p><b>Directivity</b></p>	<p><math>\pm 0.2</math> dB in HSL (rotation around probe axis)  <math>\pm 0.3</math> dB in tissue material (rotation normal to probe axis)</p>
<p><b>Dynamic Range</b></p>	<p>5 <math>\mu</math>W/g to &gt; 100 mW/g;          Linearity: <math>\pm 0.2</math> dB</p>
<p><b>Dimensions</b></p>	<p>Overall length: 337 mm (Tip: 20 mm)          Tip diameter: 3.9 mm (Body: 12 mm)          Distance from probe tip to dipole centers: 2.0 mm</p>
<p><b>Application</b></p>	<p>General dosimetry up to 4 GHz          Dosimetry in strong gradient fields          Compliance tests of mobile phones</p>
<p><b>Compatibility</b></p>	<p>DASY3, DASY4, DASY52 SAR and higher, EASY4/MRI</p>

### 5.4 Data Acquisition Electronics (DAE)

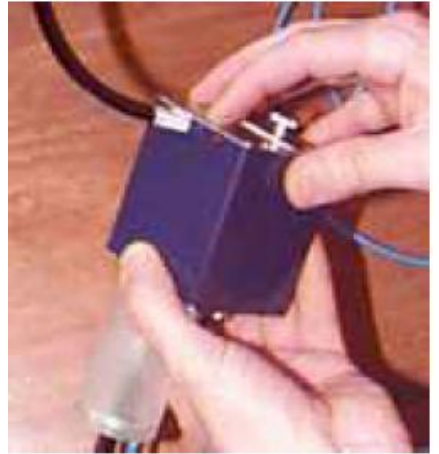
<b>Model</b>	DAE3,DAE4	
<b>Construction</b>	Signal amplifier, multiplexer, A/D converter and control logic. Serial optical link for communication with DASY4/5 embedded system (fully remote controlled). Two step probe touch detector for mechanical surface detection and emergency robot stop.	
<b>Measurement Range</b>	-100 to +300 mV (16 bit resolution and two range settings: 4mV,400mV)	
<b>Input Offset Voltage</b>	< 5µV (with auto zero)	
<b>Input Bias Current</b>	< 50 f A	
<b>Dimensions</b>	60 x 60 x 68 mm	

### 5.5 SAM Twin Phantom

<b>Material</b>	Vinylester, glass fiber reinforced (VE-GF)	
<b>Liquid Compatibility</b>	Compatible with all SPEAG tissue simulating liquids (incl. DGBE type)	
<b>Shell Thickness</b>	2 ± 0.2 mm (6 ± 0.2 mm at ear point)	
<b>Dimensions (incl. Wooden Support)</b>	Length: 1000 mm Width: 500 mm Height: adjustable feet	
<b>Filling Volume</b>	approx. 25 liters	
<b>Wooden Support</b>	SPEAG standard phantom table	

The shell corresponds to the specifications of the Specific Anthropomorphic Mannequin (SAM) phantom defined in IEEE 1528 and IEC 62209-1. It enables the dosimetric evaluation of left and right hand phone usage as well as body mounted usage at the flat phantom region. A cover prevents evaporation of the liquid. Reference markings on the phantom allow the complete setup of all predefined phantom positions and measurement grids by teaching three points with the robot.

Twin SAM V5.0 has the same shell geometry and is manufactured from the same material as Twin SAM V4.0, but has reinforced top structure.

## 5.6 ELI Phantom

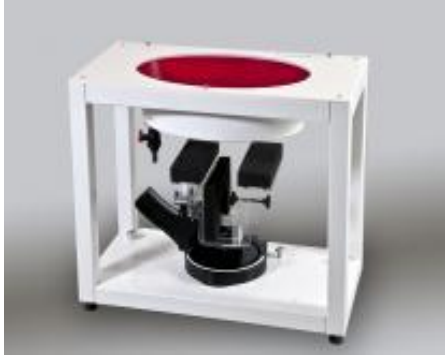
<b>Material</b>	Vinylester, glass fiber reinforced (VE-GF)	
<b>Liquid Compatibility</b>	Compatible with all SPEAG tissue simulating liquids (incl. DGBE type)	
<b>Shell Thickness</b>	2.0 ± 0.2 mm (bottom plate)	
<b>Dimensions</b>	Major axis: 600 mm Minor axis: 400 mm	
<b>Filling Volume</b>	approx. 30 liters	
<b>Wooden Support</b>	SPEAG standard phantom table	
<p>Phantom for compliance testing of handheld and body-mounted wireless devices in the frequency range of 30 MHz to 6 GHz. ELI is fully compatible with the IEC 62209-2 standard and all known tissue simulating liquids. ELI has been optimized regarding its performance and can be integrated into our standard phantom tables. A cover prevents evaporation of the liquid. Reference markings on the phantom allow installation of the complete setup, including all predefined phantom positions and measurement grids, by teaching three points. The phantom is compatible with all SPEAG dosimetric probes and dipoles.</p> <p>ELI V5.0 has the same shell geometry and is manufactured from the same material as ELI4, but has reinforced top structure.</p>		

## 5.7 Device Holder for Transmitters



F-2. Device Holder for Transmitters

- The SAR in the phantom is approximately inversely proportional to the square of the distance between the source and the liquid surface. For a source in 5mm distance, a positioning uncertainty of  $\pm 0.5\text{mm}$  would produce a SAR uncertainty of  $\pm 20\%$ . An accurate device positioning is therefore crucial for accurate and repeatable measurements. The positions, in which the devices must be measured, are defined by the standards.
- The DASY device holder is designed to cope with different positions given in the standard. It has two scales for the device rotation (with respect to the body axis) and the device inclination (with respect to the line between the ear reference points). The rotation centres for both scales are the ear reference point (ERP). Thus the device needs no repositioning when changing the angles.
- The DASY device holder has been made out of low-loss POM material having the following dielectric parameters: relative permittivity  $\epsilon = 3$  and loss tangent  $\delta = 0.02$ . The amount of dielectric material has been reduced in the closest vicinity of the device, since measurements have suggested that the influence of the clamp on the test results could thus be lowered.



## 6 Description of Test Position

### 6.1 The Body Test Position

The SAR evaluation shall be performed for all surfaces of the DUT that are accessible during intended use, as indicated in Figure 3. The separation distance in testing shall correspond to the intended use distance as specified in the user instructions provided by the manufacturer. If the intended use is not specified, all surfaces of the DUT shall be tested directly against the flat phantom.

The surface of the generic device (or the surface of the carry accessory holding the DUT) pointing towards the flat phantom shall be parallel to the surface of the phantom.

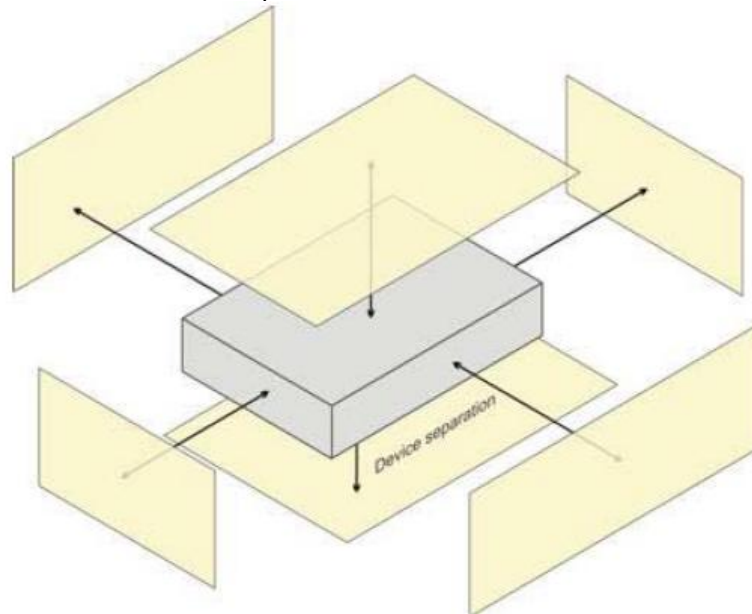

F-3. Test positions for a generic device

## 7 SAR System Verification Procedure

### 7.1 Tissue Simulate Liquid

#### 7.1.1 Recipes for Tissue Simulate Liquid

The following tables give the recipes for tissue simulating liquids to be used in different frequency bands:

Ingredients (% by weight)	Frequency (MHz)									
	450		835		900		1800-2000		2450	
Tissue Type	Head	Body	Head	Body	Head	Body	Head	Body	Head	Body
Water	38.56	51.16	40.30	50.75	40.30	50.75	55.24	70.17	55.00	68.53
Salt (NaCl)	3.95	1.49	1.38	0.94	1.38	0.94	0.31	0.39	0.2	0.1
Sucrose	56.32	46.78	57.90	48.21	57.90	48.21	0	0	0	0
HEC	0.98	0.52	0.24	0	0.24	0	0	0	0	0
Bactericide	0.19	0.05	0.18	0.10	0.18	0.10	0	0	0	0
DGBE	0	0	0	0	0	0	44.45	29.44	44.80	31.37
Salt: 99+% Pure Sodium Chloride					Sucrose: 98+% Pure Sucrose					
Water: De-ionized, 16 MΩ <sup>+</sup> resistivity					HEC: Hydroxyethyl Cellulose					
DGBE: 99+% Di(ethylene glycol) butyl ether, [2-(2-butoxyethoxy)ethanol]										

Table 2 : Recipe of Tissue Simulate Liquid

### 7.1.2 Measurement for Tissue Simulate Liquid

The dielectric properties for this Tissue Simulate Liquids were measured by using the Agilent Model 85070D Dielectric Probe (rates frequency band 200 MHz to 20 GHz) in conjunction with Agilent E5071B Network Analyzer (300 KHz-8500 MHz). The Conductivity ( $\sigma$ ) and Permittivity ( $\rho$ ) are listed in Table 1. For the SAR measurement given in this report. The temperature variation of the Tissue Simulate Liquids was  $22 \pm 2^\circ\text{C}$ .

Tissue Type	Measured Frequency (MHz)	Target Tissue Body( $\pm 5\%$ )		Measured Tissue Body		Liquid Temp. ( $^\circ\text{C}$ )	Measured Date
		$\epsilon_r$	$\sigma(\text{S/m})$	$\epsilon_r$	$\sigma(\text{S/m})$		
2450	2450	52.70 (50.07~55.34)	1.95 (1.85~2.05)	51.81	1.975	22.3	2013-9-4

Table 3 : Measurement result of Tissue electric parameters

Channel	Measured Frequency (MHz)	Target Tissue Body( $\pm 5\%$ )		Measured Tissue Body		Liquid Temp. ( $^\circ\text{C}$ )	Measured Date
		$\epsilon_r$	$\sigma(\text{S/m})$	$\epsilon_r$	$\sigma(\text{S/m})$		
1	2412	52.75 (50.11~55.39)	1.91 (1.81~2.01)	51.96	1.929	22.3	2013-9-4
6	2437	52.72 (50.08~55.35)	1.94 (1.84~2.04)	51.88	1.959		
11	2462	52.68 (50.05~55.31)	1.97 (1.87~2.07)	51.73	1.99		

Table 4 : Measurement result of Tissue electric parameters for Low/Mid/High Channel.

## 7.2 SAR System Validation

The microwave circuit arrangement for system verification is sketched in F-4. The daily system accuracy verification occurs within the flat section of the SAM phantom. A SAR measurement was performed to see if the measured SAR was within +/- 10% from the target SAR values. The tests were conducted on the same days as the measurement of the EUT. The obtained results from the system accuracy verification are displayed in the table 5 (A power level of 250mw was input to the dipole antenna). During the tests, the ambient temperature of the laboratory was in the range 22°C, the relative humidity was in the range 60% and the liquid depth above the ear reference points was above 15 cm in all the cases. It is seen that the system is operating within its specification, as the results are within acceptable tolerance of the reference values.

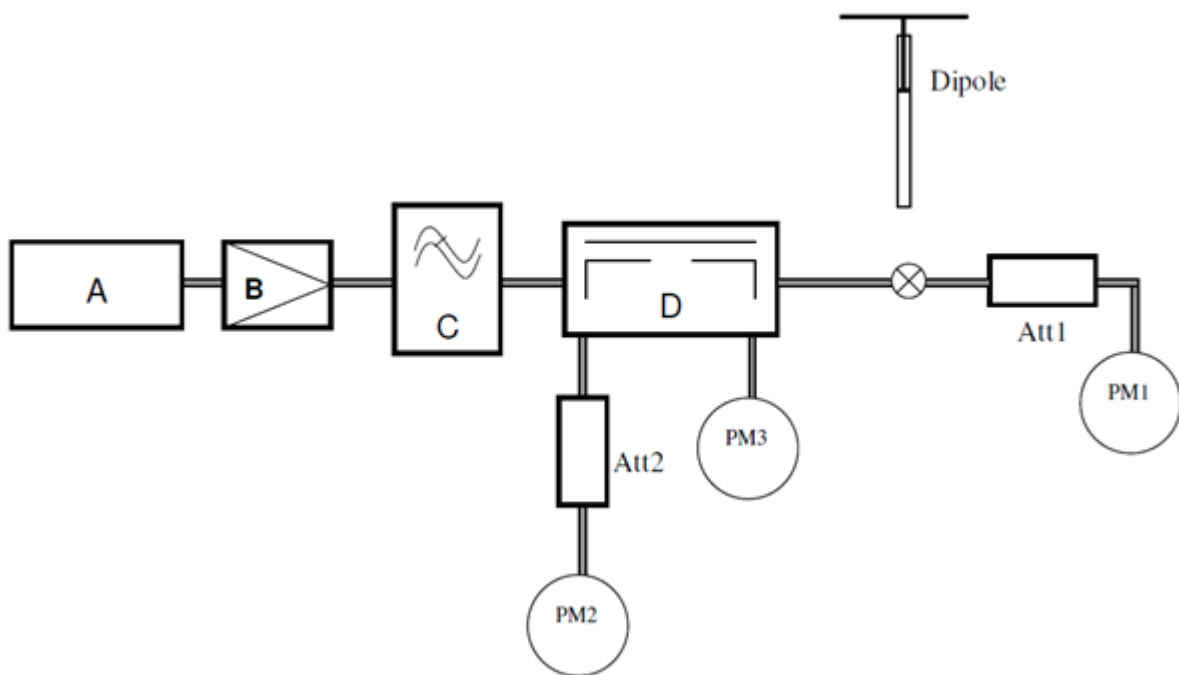

F-4. the microwave circuit arrangement used for SAR system verification

- A. Agilent E4438C Signal Generator
- B. Mini-Circuit ZHL-42 Preamplifier
- C. Mini-Circuit VLF-2500+ Low Pass Filter
- D. Mini-Circuits ZABDC20-252H-N+ Bi-DIR Coupling
- PM1. Power Sensor NRP-Z92
- PM2. Agilent Model E4416A Power Meter
- PM3. Power Sensor NRP-Z92

**7.2.1 Summary System Validation Result(s)**

Validation Kit		Target SAR (normalized to 1w) (±10%)		Measured SAR (normalized to 1w)		Liquid Temp. (°C)	Measured date
		1-g(W/kg)	10-g(W/kg)	1-g(W/kg)	10-g(W/kg)		
D2450V2	Body	51.3 (46.17~56.43)	24.1 (21.69~26.51)	53.6	23.8	22.3	2013-9-4

Table 5 : SAR System Validation Result





## 7.2.2 Detailed System Validation Results

Please see the Appendix A

## 8 Test results and Measurement Data

### 8.1 Operation Configurations

#### 8.1.1 WiFi Test Configuration

For the 802.11b/g/n SAR tests, a communication link is set up with the test mode software for Wi-Fi mode test. The Absolute Radio Frequency Channel Number (ARFCN) is allocated to 1, 6 and 11 respectively in the case of 2450 MHz during the test at the each test frequency channel .the EUT is operated at the RF continuous emission mode. Each channel should be tested at the lowest data rate. 802.11b/g/n operating modes are tested independently according to the service requirements in each frequency band. 802.11b/g modes are tested on channel 1, 6, 11; however if output power reduction is necessary for channels 1 and/or 11 to meet restricted band requirements the highest output channel closest to each of these channels must be tested instead.

SAR is not required for 802.11g/n channels when the maximum average output power is less than 0.25dB higher than that measured on the corresponding 802.11b channels.

Mode	GHz	Channel	Turbo Channel	“Default Test Channels”		UNII	
				§15.247			
				802.11b	802.11g		
802.11 b/g	2.412	1 <sup>#</sup>		√	∇		
	2.437	6	6	√	∇		
	2.462	11 <sup>#</sup>		√	∇		

### 8.2 Measurement procedure

#### 8.2.1 Scanning procedure

##### Step 1: Power reference measurement

The SAR measurement was taken at a selected spatial reference point to monitor power variations during testing. This fixed location point was measured and used as a reference value.

##### Step 2: Area scan

The SAR distribution at the exposed side of the head was measured at a distance of 4mm from the inner surface of the shell. The area covered the entire dimension of the head and the horizontal grid spacing was 15mm\*15mm or 10mm\*10mm. Based on the area scan data, the area of the maximum absorption was determined by spline interpolation.

##### Step 3: Zoom scan

Around this point, a volume of 30mm\*30mm\*30mm (fine resolution volume scan, zoom scan) was assessed by measuring 7\*7\*7 points. On this basis of this data set, the spatial peak SAR value was evaluated with the following procedure:

The data at the surface was extrapolated, since the centre of the dipoles is 2.0mm away from the tip of the probe and the distance between the surface and the lowest measuring point is 1.2mm. (This can be variable. Refer to the probe specification). The extrapolation was based on a least square algorithm. A polynomial of the fourth order was calculated through the points in z-axes. This polynomial was then used to evaluate the points between the surface and the probe tip. The maximum interpolated value was searched with a straight-forward algorithm. Around this maximum the SAR values averaged over the spatial volumes (1g or 10g) were computed using the 3D-Spline interpolation algorithm. The volume was integrated with the trapezoidal algorithm. One

thousand points (10\*10\*10) were interpolated to calculate the average. All neighbouring volumes were evaluated until no neighboring volume with a higher average value was found.

#### Step 4: Power reference measurement (drift)

The SAR value at the same location as in step 1 was again measured. (If the value changed by more than 5%, the evaluation should be done repeatedly)

### 8.2.2 Data Storage

The DASY4 software stores the acquired data from the data acquisition electronics as raw data (in microvolt readings from the probe sensors), together with all necessary software parameters for the data evaluation (probe calibration data, liquid parameters and device frequency and modulation data) in measurement files with the extension “.DAE3”. The software evaluates the desired unit and format for output each time the data is visualized or exported. This allows verification of the complete software setup even after the measurement and allows correction of incorrect parameter settings. For example, if a measurement has been performed with a wrong crest factor parameter in the device setup, the parameter can be corrected afterwards and the data can be re-evaluated. The measured data can be visualized or exported in different units or formats, depending on the selected probe type ([V/m], [A/m], [°C], [m W/g], [m W/cm²], [dBrel], etc.). Some of these units are not available in certain situations or show meaningless results, e.g., a SAR output in a lossless media will always be zero. Raw data can also be exported to perform the evaluation with other software packages.

### 8.2.3 Data Evaluation by SEMCAD

The SEMCAD software automatically executes the following procedures to calculate the field units from the microvolt readings at the probe connector. The parameters used in the evaluation are stored in the configuration modules of the software:

Probe parameters:	- Sensitivity	Normi, ai0, ai1, ai2
	- Conversion factor	ConvFi
	- Diode compression point	Dcpi
Device parameters:	- Frequency	f
	- Crest factor	cf
Media parameters:	- Conductivity	ε
	- Density	ρ

These parameters must be set correctly in the software. They can be found in the component documents or they can be imported into the software from the configuration files issued for the DASY4 components. In the direct measuring mode of the multimeter option, the parameters of the actual system setup are used. In the scan visualization and export modes, the parameters stored in the corresponding document files are used.

The first step of the evaluation is a linearization of the filtered input signal to account for the compression characteristics of the detector diode. The compensation depends on the input signal, the diode type and the DC-transmission factor from the diode to the evaluation electronics.

If the exciting field is pulsed, the crest factor of the signal must be known to correctly compensate for peak power. The formula for each channel can be given as:

$$V_i = U_i + U_i^2 \cdot cf / dcpi$$



With  $V_i$  = compensated signal of channel  $i$  ( $i = x, y, z$ )

$U_i$  = input signal of channel  $i$  ( $i = x, y, z$ )

$cf$  = crest factor of exciting field (DASY parameter)

$dcp_i$  = diode compression point (DASY parameter)

From the compensated input signals the primary field data for each channel can be evaluated:

E-field probes:  $E_i = (V_i / Norm_i \cdot ConvF)^{1/2}$

H-field probes:  $H_i = (V_i)^{1/2} \cdot (a_{i0} + a_{i1}f + a_{i2}f^2) / f$

With  $V_i$  = compensated signal of channel  $i$  ( $i = x, y, z$ )

$Norm_i$  = sensor sensitivity of channel  $i$  ( $i = x, y, z$ )  
[mV/(V/m)<sup>2</sup>] for E-field Probes

$ConvF$  = sensitivity enhancement in solution

$a_{ij}$  = sensor sensitivity factors for H-field probes

$f$  = carrier frequency [GHz]

$E_i$  = electric field strength of channel  $i$  in V/m

$H_i$  = magnetic field strength of channel  $i$  in A/m

The RSS value of the field components gives the total field strength (Hermitian magnitude):

$$E_{tot} = (E_x^2 + E_y^2 + E_z^2)^{1/2}$$

The primary field data are used to calculate the derived field units.

$$SAR = (E_{tot}^2 \cdot \sigma) / (\epsilon \cdot 1000)$$

with  $SAR$  = local specific absorption rate in mW/g

$E_{tot}$  = total field strength in V/m

$\sigma$  = conductivity in [mho/m] or [Siemens/m]

$\epsilon$  = equivalent tissue density in g/cm<sup>3</sup>

Note that the density is normally set to 1 (or 1.06), to account for actual brain density rather than the density of the simulation liquid. The power flow density is calculated assuming the excitation field to be a free space field.

$$P_{pwe} = E_{tot}^2 / 3770 \quad \text{or} \quad P_{pwe} = H_{tot}^2 \cdot 37.7$$

with  $P_{pwe}$  = equivalent power density of a plane wave in mW/cm<sup>2</sup>

$E_{tot}$  = total electric field strength in V/m

$H_{tot}$  = total magnetic field strength in A/m

### 8.3 Measurement of RF conducted Power

#### 8.3.1 Conducted Power Of WIFI

Wi-Fi 2450MHz	Average Power (dBm) for Data Rates (Mbps)								
	Channel	1	2	5.5	11	/	/	/	/
802.11b	1	16.15	16.26	16.28	16.22	/	/	/	/
	6	16.32	16.21	16.36	16.47	/	/	/	/
	11	16.68	16.64	16.65	<b>16.72</b>	/	/	/	/
802.11g	Channel	6	9	12	18	24	36	48	54
	1	15.42	15.26	15.32	15.45	15.46	15.38	15.12	15.51
	6	15.46	15.23	15.45	15.64	15.38	15.69	15.49	15.74
	11	15.82	15.95	15.69	15.78	15.64	15.87	15.69	16.03
802.11n HT20	Channel	6.5	13	19.5	26	39	52	58.5	65
	1	14.32	14.65	14.32	14.42	14.32	14.23	14.45	14.56
	6	14.52	14.56	14.39	14.49	14.29	14.38	14.59	14.69
	11	14.59	14.58	14.29	14.39	14.68	14.58	14.71	14.72

Table 6: Conducted Power Of WIFI

Note:

- 1) Indicates default channels per KDB Publication 248227 D01v01r02. When the adjacent channels are higher in power than the default channels, these “required channels” are considered for SAR testing instead of the default channels.
- 2) For each frequency band, testing at higher data rates and higher order modulations is not required when the maximum average output power for each of these configurations is less than 0.25dB higher than those measured at the lowest data rate.
- 3) SAR is not required for 802.11g/n channels when the maximum average output power is less than 0.25dB higher than that measured on the corresponding 802.11b channels.

#### 8.3.2 Conducted Power Of BT

➤ Bluetooth 4.0 BLE mode

Mode		Average Conducted Power(dBm)		
Band	Channel	0	39	78
BT	GFSK	<b>5.32</b>	5.24	4.76

## 8.4 Measurement of SAR average value

### 8.4.1 SAR Result Of WIFI

Test position	Test mode	Test Ch./Fre q	SAR (W/kg)		Power drift (dB)	Scaled SAR (1-g)	SAR limit (W/kg)	Liquid Temp. (°C)	
			1-g	10-g					
Body	Back side 0mm	802.11b	11/2462	0.583	0.228	0.006	<b>0.704</b>	1.6	22
	Left side 0mm	802.11b	11/2462	0.042	0.024	-0.144	0.051	1.6	22
	Bottom side 0mm	802.11b	11/2462	0.314	0.142	-0.169	0.379	1.6	22

Table 7: SAR of WIFI for Body

Note:

- 1) Test positions of EUT(the distance between the EUT and the phantom is 0mm for all sides)
- 2) The maximum Scaled SAR value is marked in **bold**
- 3) Per FCC KDB Publication 447498 D01v05r01, if the reported (scaled) SAR measured at the middle channel or highest output power channel for each test configuration is  $\leq 0.8$  W/kg then testing at the other channels is not required for such test configuration(s).
- 4) Each channel was tested at the lowest data rate.

## 8.5 Multiple (single) Transmitter Evaluation

### 8.5.1 EUT Antenna Locations

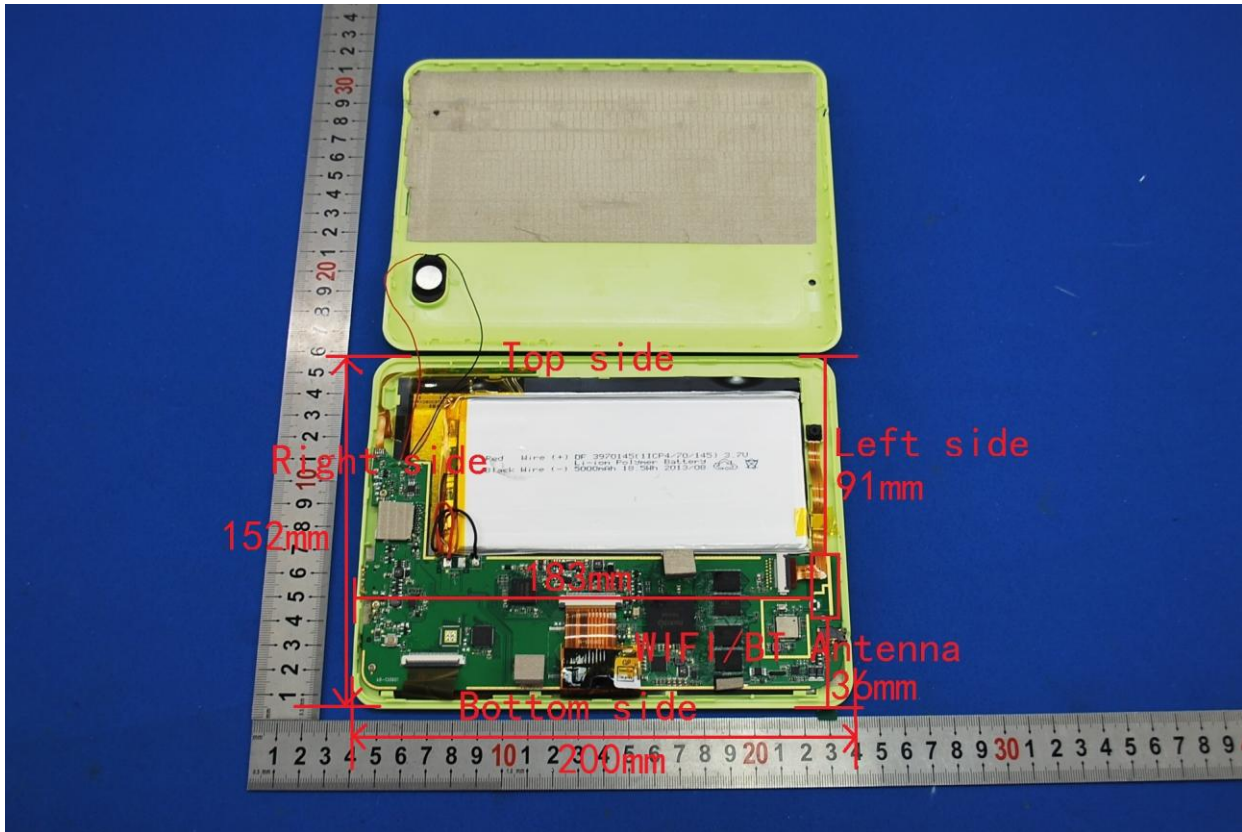

The location of the antennas inside MFC181 is shown as above picture, for it we can have some Conclusion(s):

### 8.5.2 EUT side for SAR Testing

Per KDB 447498 D01v05r01, According to the distance between Wi-Fi /BT antenna and the sides of MFC181 we can draw the conclusion that:

EUT Sides for SAR Testing						
Mode	Front	Back	Left	Right	Top	Bottom
Wi-Fi (2.4GHz)	No	Yes	Yes	No	No	Yes

Table 8: EUT Sides for SAR Testing

Note: Per FCC KDB 616217, the back surface and edges of the tablet should be tested for SAR compliance with the tablet touching the phantom. The SAR Exclusion Threshold in KDB 447498D01 v05r01 can be applied to determine SAR test exclusion for adjacent edge configurations. The closest distance from the antenna to an adjacent tablet edge is used to determine if SAR testing is required for the adjacent edges, with the adjacent edge positioned against the phantom and the edge containing the antenna positioned perpendicular to the phantom.

### 8.5.3 Stand-alone SAR

Per FCC KDB 447498 D01 v05r01, the SAR exclusion threshold for distances <50mm is defined by the following equation:

$$\frac{\text{Max Power of Channel(mW)}}{\text{Test Separation Dist(mm)}} * \sqrt{\text{Frequency(GHz)}} \leq 3.0$$

Note:

When the minimum *test separation distance* is < 5 mm, a distance of 5 mm is applied to determine SAR test exclusion.

- 1) Based on the maximum conducted power of Wi-Fi and the antenna to use separation distance, Stand-alone SAR evaluation is required for Wi-Fi;  $[(56.23/5) * \sqrt{2.462}] = 17.7 > 3.0$ .
- 2) Based on the maximum conducted power of BT and the antenna to use separation distance, Stand-alone SAR evaluation is not required for BT;  $[(3.98/5) * \sqrt{2.480}] = 1.3 < 3.0$ .

### 8.5.4 Simultaneous SAR

Simultaneous Transmission SAR evaluation is not required for BT and Wi-Fi, because they share the same antenna and cannot transmit at the same time by design.



## 8.6 Detailed Test Results

Please see the Appendix B

## 9 Photographs

### 9.1 EUT Test Setup

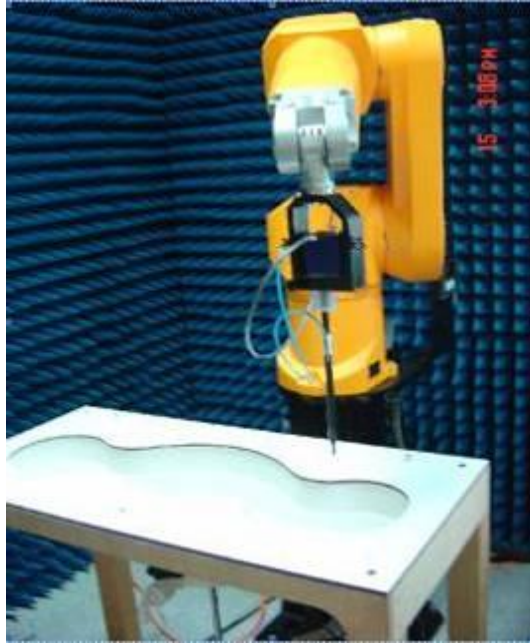
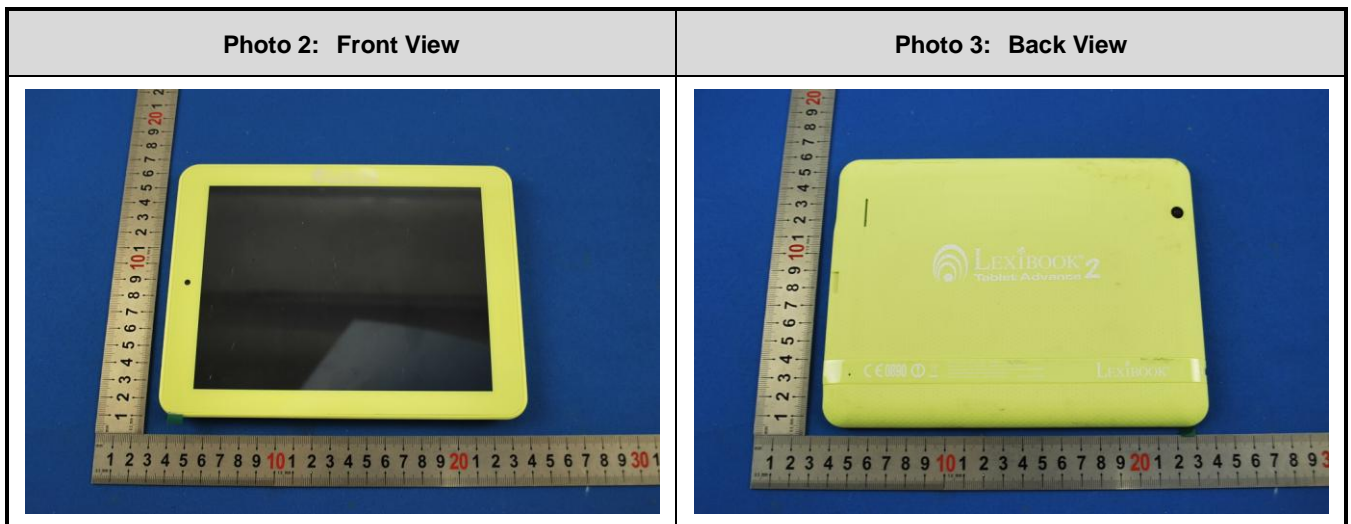





Photo 1: SAR measurement System

### 9.2 Photographs of EUT



<p>Photo 4: Accessory</p>	<p>NA</p>
	<p>NA</p>

### 9.3 Photographs of EUT test position

<p>Photo 5: Left t side 0mm</p>	<p>Photo 6: Back side 0mm</p>
	



<p>Photo 7: Bottom side 0mm</p>	<p>NA</p>
	<p>NA</p>

#### 9.4 Photographs of Tissue Simulate Liquid

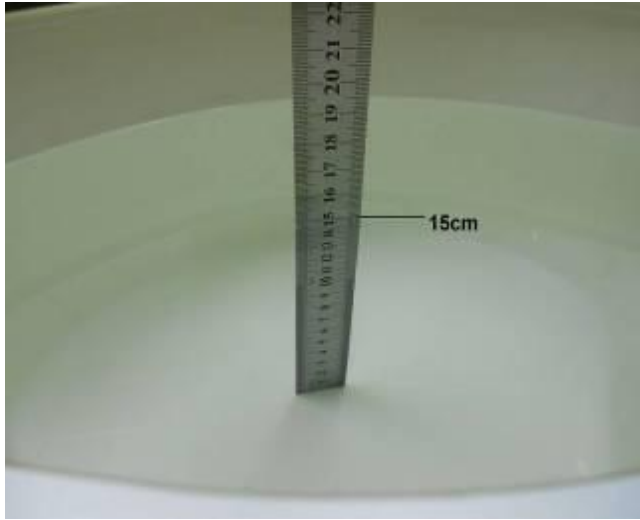
<p>Photo 8: Tissue Simulate Liquid for Body 2450 (15cm)</p>	<p>NA</p>
	<p>NA</p>

#### 9.5 EUT Constructional Details

Refer to Report No. SZEM130800479401 for EUT external and internal photos.

### 10 Calibration certificate

Please see the Appendix C



## Appendix A : Detailed System Validation Results

## Appendix B: Detailed Test Results

## Appendix C: Calibration certificate

---END---

---