



FCC TEST REPORT

REPORT NO.: RF130403C25-2

MODEL NO.: XT85

FCC ID: UTWXT85WA

RECEIVED: Apr. 03, 2013

TESTED: Apr. 13 ~ May 13, 2013

ISSUED: May 14, 2013

APPLICANT: Janam Technologies LLC

ADDRESS: 100 Crossways Park West, Suite 105, Woodbury,
NY 11797

ISSUED BY: Bureau Veritas Consumer Products Services (H.K.)
Ltd., Taoyuan Branch

LAB ADDRESS: No. 47, 14th Ling, Chia Pau Vil., Lin Kou Dist.,
New Taipei City, Taiwan, R.O.C.

TEST LOCATION: No. 19, Hwa Ya 2nd Rd, Wen Hwa Tsuen, Kwei
Shan Hsiang, Taoyuan Hsien 333, Taiwan, R.O.C.

This report should not be used by the client to claim product certification, approval, or endorsement by TAF or any government agencies.



This report is for your exclusive use. Any copying or replication of this report to or for any other person or entity, or use of our name or trademark, is permitted only with our prior written permission. This report sets forth our findings solely with respect to the test samples identified herein. The results set forth in this report are not indicative or representative of the quality or characteristics of the lot from which a test sample was taken or any similar or identical product unless specifically and expressly noted. Our report includes all of the tests requested by you and the results thereof based upon the information that you provided to us. You have 60 days from date of issuance of this report to notify us of any material error or omission caused by our negligence, provided, however, that such notice shall be in writing and shall specifically address the issue you wish to raise. A failure to raise such issue within the prescribed time shall constitute your unqualified acceptance of the completeness of this report, the tests conducted and the correctness of the report contents. Unless specific mention, the uncertainty of measurement has been explicitly taken into account to declare the compliance or non-compliance to the specification.



Table of Contents

RELEASE CONTROL RECORD	4
1. CERTIFICATION.....	5
2. SUMMARY OF TEST RESULTS	6
2.1 MEASUREMENT UNCERTAINTY	6
3. GENERAL INFORMATION.....	7
3.1 GENERAL DESCRIPTION OF EUT.....	7
3.2 DESCRIPTION OF TEST MODES.....	8
3.2.1 TEST MODE APPLICABILITY AND TESTED CHANNEL DETAIL	9
3.3 DESCRIPTION OF SUPPORT UNITS.....	11
3.3.1 CONFIGURATION OF SYSTEM UNDER TEST.....	11
3.4 GENERAL DESCRIPTION OF APPLIED STANDARDS.....	12
4. TEST TYPES AND RESULTS	13
4.1 RADIATED EMISSION AND BANDEDGE MEASUREMENT.....	13
4.1.1 LIMITS OF RADIATED EMISSION AND BANDEDGE MEASUREMENT	13
4.1.2 TEST INSTRUMENTS	14
4.1.3 TEST PROCEDURES.....	15
4.1.4 DEVIATION FROM TEST STANDARD	15
4.1.5 TEST SETUP	16
4.1.6 EUT OPERATING CONDITIONS.....	16
4.1.7 TEST RESULTS	17
4.2 CONDUCTED EMISSION MEASUREMENT.....	24
4.2.1 LIMITS OF CONDUCTED EMISSION MEASUREMENT	24
4.2.2 TEST INSTRUMENTS	24
4.2.3 TEST PROCEDURES.....	25
4.2.4 DEVIATION FROM TEST STANDARD	25
4.2.5 TEST SETUP	26
4.2.6 EUT OPERATING CONDITIONS.....	26
4.2.7 TEST RESULTS	27
4.3 NUMBER OF HOPPING FREQUENCY USED.....	31
4.3.1 LIMIT OF HOPPING FREQUENCY USED	31
4.3.2 TEST SETUP	31
4.3.3 TEST INSTRUMENTS	31
4.3.4 TEST PROCEDURES.....	31
4.3.5 DEVIATION FROM TEST STANDARD	31
4.3.6 TEST RESULTS	31
4.4 DWELL TIME ON EACH CHANNEL.....	33
4.4.1 LIMIT OF DWELL TIME USED.....	33
4.4.2 TEST SETUP	33
4.4.3 TEST INSTRUMENTS	33
4.4.4 TEST PROCEDURES.....	33
4.4.5 DEVIATION FROM TEST STANDARD	33
4.4.6 TEST RESULTS	34
4.5 CHANNEL BANDWIDTH.....	38
4.5.1 LIMITS OF CHANNEL BANDWIDTH	38
4.5.2 TEST SETUP	38
4.5.3 TEST INSTRUMENTS	38
4.5.4 TEST PROCEDURE	38
4.5.5 DEVIATION FROM TEST STANDARD	38
4.5.6 EUT OPERATING CONDITION	38
4.5.7 TEST RESULTS	39
4.6 HOPPING CHANNEL SEPARATION	40
4.6.1 LIMIT OF HOPPING CHANNEL SEPARATION.....	40
4.6.2 TEST SETUP	40



A D T

4.6.3	TEST INSTRUMENTS	40
4.6.4	TEST PROCEDURES	40
4.6.5	DEVIATION FROM TEST STANDARD	40
4.6.6	TEST RESULTS	41
4.7	MAXIMUM OUTPUT POWER.....	42
4.7.1	LIMITS OF MAXIMUM OUTPUT POWER MEASUREMENT	42
4.7.2	TEST SETUP	42
4.7.3	TEST INSTRUMENTS	42
4.7.4	TEST PROCEDURES	42
4.7.5	DEVIATION FROM TEST STANDARD	42
4.7.6	EUT OPERATING CONDITION	42
4.7.7	TEST RESULTS	43
4.8	CONDUCTED OUT OF BAND EMISSION MEASUREMENT	44
4.8.1	LIMITS OF CONDUCTED OUT OF BAND EMISSION MEASUREMENT	44
4.8.2	TEST INSTRUMENTS	44
4.8.3	TEST PROCEDURE	44
4.8.4	DEVIATION FROM TEST STANDARD	44
4.8.5	EUT OPERATING CONDITION	44
4.8.6	TEST RESULTS	44
5.	PHOTOGRAPHS OF THE TEST CONFIGURATION.....	47
6.	INFORMATION ON THE TESTING LABORATORIES	48
7.	APPENDIX A - MODIFICATIONS RECORDERS FOR ENGINEERING CHANGES TO THE EUT BY THE LAB	49



A D T

RELEASE CONTROL RECORD

ISSUE NO.	REASON FOR CHANGE	DATE ISSUED
RF130403C25-2	Original release	May 14, 2013





A D T

1. CERTIFICATION

PRODUCT: Portable Data Terminal
MODEL NO.: XT85
BRAND: JANAM
APPLICANT: Janam Technologies LLC
TESTED: Apr. 13 ~ May 13, 2013
TEST SAMPLE: Production Unit
STANDARDS: **FCC Part 15, Subpart C (Section 15.247)**
ANSI C63.10-2009

The above equipment (model: XT85) has been tested by **Bureau Veritas Consumer Products Services (H.K.) Ltd., Taoyuan Branch**, and found compliance with the requirement of the above standards. The test record, data evaluation & Equipment Under Test (EUT) configurations represented herein are true and accurate accounts of the measurements of the sample's EMC characteristics under the conditions specified in this report.

PREPARED BY :  , **DATE** : May 14, 2013
Pettie Chen / Senior Specialist

APPROVED BY :  , **DATE** : May 14, 2013
Ken Liu / Senior Manager



A D T

2. SUMMARY OF TEST RESULTS

The EUT has been tested according to the following specifications:

APPLIED STANDARD: FCC Part 15, Subpart C			
STANDARD SECTION	TEST TYPE AND LIMIT	RESULT	REMARK
15.207	AC Power Conducted Emission	PASS	Meet the requirement of limit. Minimum passing margin is -2.19dB at 0.47031MHz.
15.247(a)(1) (iii)	Number of Hopping Frequency Used	PASS	Meet the requirement of limit.
15.247(a)(1) (iii)	Dwell Time on Each Channel	PASS	Meet the requirement of limit.
15.247(a)(1)	1. Hopping Channel Separation 2. Spectrum Bandwidth of a Frequency Hopping Sequence Spread Spectrum System	PASS	Meet the requirement of limit.
15.247(b)	Maximum Peak Output Power	PASS	Meet the requirement of limit.
15.247(d)	Transmitter Radiated Emissions	PASS	Meet the requirement of limit. Minimum passing margin is -6.5dB at 300.16MHz.
15.247(d)	Band Edge Measurement	PASS	Meet the requirement of limit.
15.203	Antenna Requirement	PASS	No antenna connector is used.

NOTE: If The Frequency Hopping System operating in 2400-2483.5MHz band and the output power less than 125mW. The hopping channel carrier frequencies separated by a minimum of 25kHz or two-thirds of the 20dB bandwidth of hopping channel whichever is greater.

2.1 MEASUREMENT UNCERTAINTY

Where relevant, the following measurement uncertainty levels have been estimated for tests performed on the EUT as specified in CISPR 16-4-2:

MEASUREMENT	FREQUENCY	UNCERTAINTY
Conducted emission	150kHz ~ 30MHz	2.44 dB
Radiated emissions	30MHz ~ 200MHz	3.34 dB
	200MHz ~1000MHz	3.35 dB
	1GHz ~ 18GHz	2.26 dB
	18GHz ~ 40GHz	1.94 dB

This uncertainty represents an expanded uncertainty expressed at approximately the 95% confidence level using a coverage factor of k=2.



3. GENERAL INFORMATION

3.1 GENERAL DESCRIPTION OF EUT

EUT	Portable Data Terminal
MODEL NO.	XT85
POWER SUPPLY	3.7Vdc (Battery) 5.0Vdc (Adapter or host equipment)
MODULATION TYPE	GFSK, $\pi/4$ -DQPSK, 8DPSK
MODULATION TECHNOLOGY	FHSS
TRANSFER RATE	1/2/3Mbps
OPERATING FREQUENCY	2402 ~ 2480MHz
NUMBER OF CHANNEL	79
MAX. OUTPUT POWER	1.368mW
ANTENNA TYPE	PIFA antenna with 1.68dBi gain
ANTENNA CONNECTOR	N/A
I/O PORTS	Refer to Note
DATA CABLE	Refer to user's manual
ACCESSORY DEVICES	Refer to Note

NOTE:

- There are two types of barcode scanners for the EUT: 1D & 2D. After pretesting, 2D is the worst for the final test.
- The EUT contains following accessory devices.

ITEM	BRAND	MODEL	SPECIFICATION
AC Adapter	Sunny	SYS1460-1005	I/P: 100-240Vac, 1.0A, 50-60Hz O/P: 5.0Vdc, 2.0A
Battery 1	JANAM	BAT-T1-001	Rating: 3.7Vdc, 2400mAh
Battery 2	JANAM	BAT-T21-001	Rating: 3.7Vdc, 3600mAh
USB cable	JANAM	NA	1.2m non-shielded cable without core

*After pretesting, Battery 1 was the worst case for the final test.

- The following support units provided by client.

ITEM	BRAND	MODEL	SPECIFICATION
AC Adapter	EDAC	EA10302	I/P: 100-240Vac, 1.0A, 50-60Hz O/P: 9.0Vdc, 3.0A 1.2m non-shielded cable with one core
USB Host Cable	JANAM	NA	1.2m non-shielded cable with one core
USB Client Cable	JANAM	NA	1.2m non-shielded cable with one core
Power cord	JANAM	NA	2.0m non-shielded cable without core

- The above EUT information is declared by manufacturer and for more detailed features description, please refer to the manufacturer's specifications or user's manual.



3.2 DESCRIPTION OF TEST MODES

79 channels are provided to this EUT:

CHANNEL	FREQ. (MHz)	CHANNEL	FREQ. (MHz)	CHANNEL	FREQ. (MHz)	CHANNEL	FREQ. (MHz)
0	2402	20	2422	40	2442	60	2462
1	2403	21	2423	41	2443	61	2463
2	2404	22	2424	42	2444	62	2464
3	2405	23	2425	43	2445	63	2465
4	2406	24	2426	44	2446	64	2466
5	2407	25	2427	45	2447	65	2467
6	2408	26	2428	46	2448	66	2468
7	2409	27	2429	47	2449	67	2469
8	2410	28	2430	48	2450	68	2470
9	2411	29	2431	49	2451	69	2471
10	2412	30	2432	50	2452	70	2472
11	2413	31	2433	51	2453	71	2473
12	2414	32	2434	52	2454	72	2474
13	2415	33	2435	53	2455	73	2475
14	2416	34	2436	54	2456	74	2476
15	2417	35	2437	55	2457	75	2477
16	2418	36	2438	56	2458	76	2478
17	2419	37	2439	57	2459	77	2479
18	2420	38	2440	58	2460	78	2480
19	2421	39	2441	59	2461		



3.2.1 TEST MODE APPLICABILITY AND TESTED CHANNEL DETAIL

EUT CONFIGURE MODE	APPLICABLE TO				DESCRIPTION
	RE \geq 1G	RE<1G	PLC	APCM	
A	√	√	√	√	Power from adapter model: EA10302
B	-	-	√	-	Power from adapter model: SYS1460-1005

Where **RE \geq 1G**: Radiated Emission above 1GHz **RE<1G**: Radiated Emission below 1GHz
PLC: Power Line Conducted Emission **APCM**: Antenna Port Conducted Measurement

NOTE:
The EUT had been pre-tested on the positioned of each 3 axis. The worst case was found when positioned on **Y-plane**.

RADIATED EMISSION TEST (ABOVE 1 GHz):

- Pre-Scan has been conducted to determine the worst-case mode from all possible combinations between available modulations, antenna ports (if EUT with antenna diversity architecture) and packet type.
- Following channel(s) was (were) selected for the final test as listed below.

EUT CONFIGURE MODE	AVAILABLE CHANNEL	TESTED CHANNEL	MODULATION TECHNOLOGY	MODULATION TYPE	PACKET TYPE
A	0 to 78	0, 39, 78	FHSS	GFSK	DH5
A	0 to 78	0, 39, 78	FHSS	8DPSK	DH5

RADIATED EMISSION TEST (BELOW 1 GHz):

- Pre-Scan has been conducted to determine the worst-case mode from all possible combinations between available modulations, antenna ports (if EUT with antenna diversity architecture) and packet type.
- Following channel(s) was (were) selected for the final test as listed below.

EUT CONFIGURE MODE	AVAILABLE CHANNEL	TESTED CHANNEL	MODULATION TECHNOLOGY	MODULATION TYPE	PACKET TYPE
A	0 to 78	78	FHSS	8DPSK	DH5

POWER LINE CONDUCTED EMISSION:

- Pre-Scan has been conducted to determine the worst-case mode from all possible combinations between available modulations, antenna ports (if EUT with antenna diversity architecture) and packet type.
- Following channel(s) was (were) selected for the final test as listed below.

EUT CONFIGURE MODE	AVAILABLE CHANNEL	TESTED CHANNEL	MODULATION TECHNOLOGY	MODULATION TYPE	PACKET TYPE
A, B	0 to 78	78	FHSS	8DPSK	DH5



BANDEDGE MEASUREMENT:

- Pre-Scan has been conducted to determine the worst-case mode from all possible combinations between available modulations, antenna ports (if EUT with antenna diversity architecture), and packet types.
- Following channel(s) was (were) selected for the final test as listed below.

EUT CONFIGURE MODE	AVAILABLE CHANNEL	TESTED CHANNEL	MODULATION TECHNOLOGY	MODULATION TYPE	PACKET TYPE
A	0 to 78	0, 78	FHSS	GFSK	DH5
A	0 to 78	0, 78	FHSS	8DPSK	DH5

ANTENNA PORT CONDUCTED MEASUREMENT:

- This item includes all test value of each mode, but only includes spectrum plot of worst value of each mode.
- Pre-Scan has been conducted to determine the worst-case mode from all possible combinations between available modulations, antenna ports (if EUT with antenna diversity architecture), and packet types.
- Following channel(s) was (were) selected for the final test as listed below.

EUT CONFIGURE MODE	AVAILABLE CHANNEL	TESTED CHANNEL	MODULATION TECHNOLOGY	MODULATION TYPE	PACKET TYPE
A	0 to 78	0, 39, 78	FHSS	GFSK	DH5
A	0 to 78	0, 39, 78	FHSS	8DPSK	DH5

TEST CONDITION:

APPLICABLE TO	ENVIRONMENTAL CONDITIONS	INPUT POWER	TESTED BY
RE≥1G	25deg. C, 65%RH	120Vac, 60Hz	Brad Tung
RE<1G	25deg. C, 69%RH	120Vac, 60Hz	Brad Tung
PLC	24deg. C, 64%RH	120Vac, 60Hz	Match Tsui
APCM	25deg. C, 60%RH	120Vac, 60Hz	Jun Wu



3.3 DESCRIPTION OF SUPPORT UNITS

The EUT has been tested as an independent unit together with other necessary accessories or support units. The following support units or accessories were used to form a representative test configuration during the tests.

NO.	PRODUCT	BRAND	MODEL NO.	SERIAL NO.	FCC ID
1	NOTEBOOK	DELL	E5420	33MLMQ1	FCC DoC Approved

NO.	SIGNAL CABLE DESCRIPTION OF THE ABOVE SUPPORT UNITS
1	1.2m USB host cable with one core (Provided by client)

NOTE: All power cords of the above support units are non shielded (1.8m).

3.3.1 CONFIGURATION OF SYSTEM UNDER TEST

Test Mode A

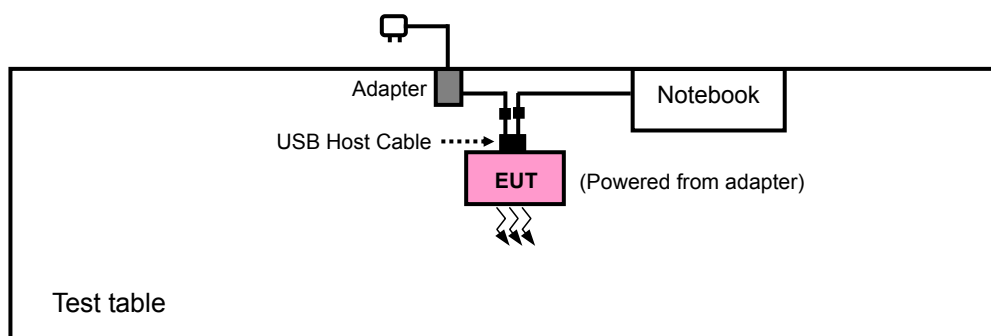

Test Mode B

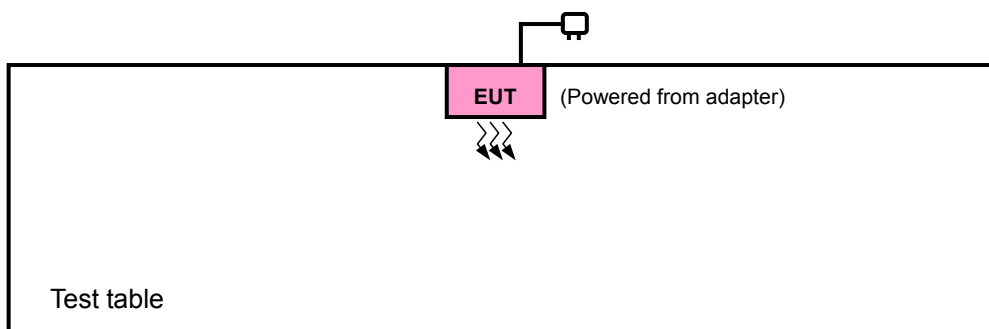

3.4 GENERAL DESCRIPTION OF APPLIED STANDARDS

The EUT is a RF Product. According to the specifications of the manufacturer, it must comply with the requirements of the following standards:

FCC Part 15, Subpart C. (15.247)

558074 D01 DTS Meas Guidance v02

FCC Public Notice DA 00-705

ANSI C63.10-2009

All test items have been performed and recorded as per the above standards.

NOTE: The EUT is also considered as a kind of computer peripheral, because the connection to computer is necessary for typical use. It has been verified to comply with the requirements of FCC Part 15, Subpart B, Class B (DoC). The test report has been issued separately.

4. TEST TYPES AND RESULTS

4.1 RADIATED EMISSION AND BANDEGE MEASUREMENT

4.1.1 LIMITS OF RADIATED EMISSION AND BANDEGE MEASUREMENT

Radiated emissions which fall in the restricted bands must comply with the radiated emission limits specified as below table. Other emissions shall be at least 20dB below the highest level of the desired power:

FREQUENCIES (MHz)	FIELD STRENGTH (microvolts/meter)	MEASUREMENT DISTANCE (meters)
0.009 ~ 0.490	2400/F(kHz)	300
0.490 ~ 1.705	24000/F(kHz)	30
1.705 ~ 30.0	30	30
30 ~ 88	100	3
88 ~ 216	150	3
216 ~ 960	200	3
Above 960	500	3

NOTE:

1. The lower limit shall apply at the transition frequencies.
2. Emission level (dBuV/m) = 20 log Emission level (uV/m).
3. For frequencies above 1000MHz, the field strength limits are based on average detector, however, the peak field strength of any emission shall not exceed the maximum permitted average limits, specified above by more than 20dB under any condition of modulation.



A D T

4.1.2 TEST INSTRUMENTS

DESCRIPTION & MANUFACTURER	MODEL NO.	SERIAL NO.	DATE OF CALIBRATION	DUE DATE OF CALIBRATION
Test Receiver ROHDE & SCHWARZ	ESIB7	100212	Aug. 06, 2012	Aug. 05, 2013
Spectrum Analyzer ROHDE & SCHWARZ	FSP40	100039	Jan. 31, 2013	Jan. 30, 2014
BILOG Antenna SCHWARZBECK	VULB9168	9168-160	Mar. 20, 2013	Mar. 19, 2014
HORN Antenna SCHWARZBECK	9120D	209	Sep. 03, 2012	Sep. 02, 2013
HORN Antenna SCHWARZBECK	BBHA 9170	148	Jul. 11, 2012	Jul. 10, 2013
Preamplifier Agilent	8447D	2944A10633	Oct. 25, 2012	Oct. 24, 2013
Preamplifier Agilent	8449B	3008A01964	Oct. 25, 2012	Oct. 24, 2013
RF signal cable HUBER+SUHNNER	SUCOFLEX 104	250723/4	Aug. 28, 2012	Aug. 27, 2013
RF signal cable HUBER+SUHNNER	SUCOFLEX 106	12738/6+309224/ 4	Aug. 28, 2012	Aug. 27, 2013
Software BV ADT	ADT_Radiated_ V7.6.15.9.2	NA	NA	NA
Antenna Tower inn-co GmbH	MA 4000	013303	NA	NA
Antenna Tower Controller inn-co GmbH	CO2000	017303	NA	NA
Turn Table BV ADT	TT100	TT93021703	NA	NA
Turn Table Controller BV ADT	SC100	SC93021703	NA	NA
26GHz ~ 40GHz Amplifier	EM26400	815221	Oct. 25, 2012	Oct. 24, 2013
High Speed Peak Power Meter	ML2495A	0824012	Aug. 22, 2012	Aug. 21, 2013
Power Sensor	MA2411B	0738171	Jul. 30, 2012	Jul. 29, 2013

- NOTE:**
1. The calibration interval of the above test instruments is 12 months and the calibrations are traceable to NML/ROC and NIST/USA.
 2. The test was performed in HwaYa Chamber 3.
 3. The horn antenna and HP preamplifier (model: 8449B) are used only for the measurement of emission frequency above 1GHz if tested.
 4. The FCC Site Registration No. is 988962.
 5. The IC Site Registration No. is IC 7450F-3.

4.1.3 TEST PROCEDURES

- a. The EUT was placed on the top of a rotating table 0.8 meters above the ground at a 3 meter semi-anechoic chamber. The table was rotated 360 degrees to determine the position of the highest radiation.
- b. The EUT was set 3 meters away from the interference-receiving antenna, which was mounted on the top of a variable-height antenna tower.
- c. The antenna is a broadband antenna, and its height is varied from one meter to four meters above the ground to determine the maximum value of the field strength. Both horizontal and vertical polarizations of the antenna are set to make the measurement.
- d. For each suspected emission, the EUT was arranged to its worst case and then the antenna was tuned to heights from 1 meter to 4 meters and the rotatable table was turned from 0 degrees to 360 degrees to find the maximum reading.
- e. The test-receiver system was set to Peak Detect Function and Specified Bandwidth with Maximum Hold Mode.
- f. If the emission level of the EUT in peak mode was lower than the limit specified, then testing could be stopped and the peak values of the EUT would be reported. Otherwise the emissions would be re-tested one by one using peak, quasi-peak or average method as specified and then reported in a data sheet.

NOTE:

1. The resolution bandwidth and video bandwidth of test receiver/spectrum analyzer is 120kHz for Quasi-peak detection at frequency below 1GHz.
2. The resolution bandwidth of test receiver/spectrum analyzer is 1 MHz and video bandwidth is 3MHz for Peak detection at frequency above 1GHz.
3. All modes of operation were investigated and the worst-case emissions are reported.

4.1.4 DEVIATION FROM TEST STANDARD

No deviation.

4.1.5 TEST SETUP

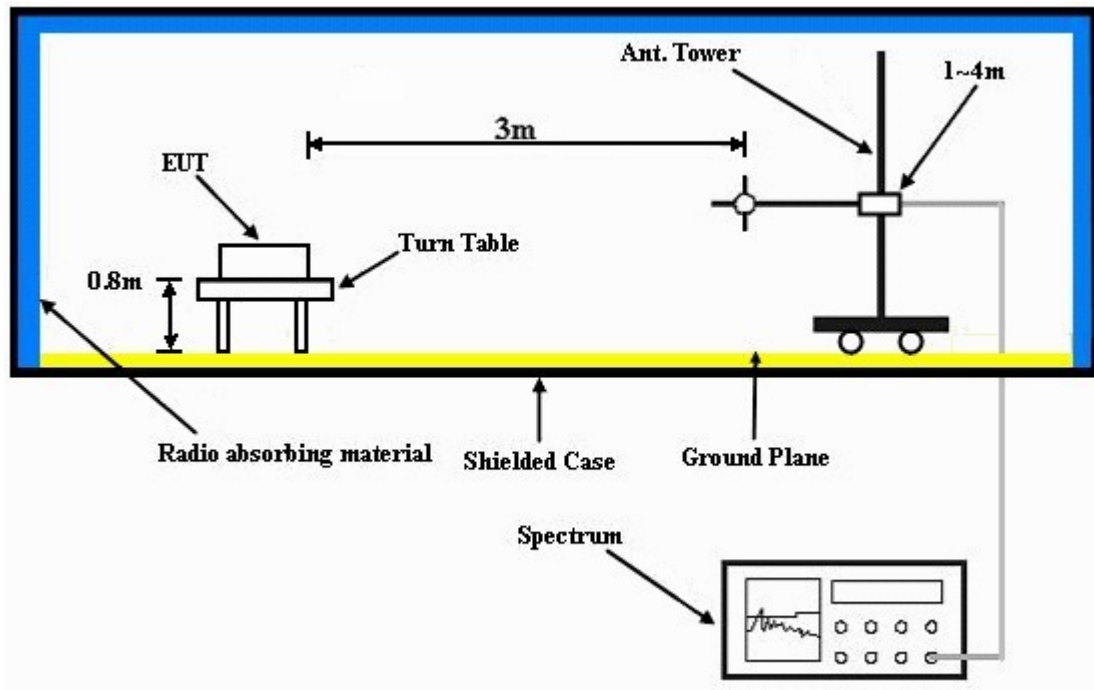

For the actual test configuration, please refer to the attached file (Test Setup Photo).

4.1.6 EUT OPERATING CONDITIONS

- a. Connected EUT with a notebook system via USB cable and placed on a testing table.
- b. The notebook system ran a test program (provided by manufacturer) to enable EUT under transmission condition continuously at specific channel frequency.



A D T

4.1.7 TEST RESULTS

ABOVE 1GHz DATA :

GFSK

EUT TEST CONDITION		MEASUREMENT DETAIL	
CHANNEL	Channel 0	FREQUENCY RANGE	1 ~ 25GHz
INPUT POWER (SYSTEM)	120Vac, 60 Hz	DETECTOR FUNCTION	Peak (PK) Average (AV)
ENVIRONMENTAL CONDITIONS	25deg. C, 65%RH	TESTED BY	Brad Tung

ANTENNA POLARITY & TEST DISTANCE: HORIZONTAL AT 3 M								
NO.	FREQ. (MHz)	EMISSION LEVEL (dBuV/m)	LIMIT (dBuV/m)	MARGIN (dB)	ANTENNA HEIGHT (m)	TABLE ANGLE (Degree)	RAW VALUE (dBuV)	CORRECTION FACTOR (dB/m)
1	2390.00	47.0 PK	74.0	-27.0	1.33 H	300	16.20	30.80
2	2390.00	36.9 AV	54.0	-17.1	1.33 H	300	6.10	30.80
3	#2400.00	52.5 PK	81.5	-29.0	1.30 H	305	21.60	30.90
4	#2400.00	22.4 AV	51.4	-29.0	1.30 H	305	-8.50	30.90
5	*2402.00	101.5 PK			1.30 H	305	70.60	30.90
6	*2402.00	71.4 AV			1.30 H	305	40.50	30.90
7	4804.00	51.0 PK	74.0	-23.0	1.17 H	227	14.10	36.90
8	4804.00	20.9 AV	54.0	-33.1	1.17 H	227	-16.00	36.90
ANTENNA POLARITY & TEST DISTANCE: VERTICAL AT 3 M								
NO.	FREQ. (MHz)	EMISSION LEVEL (dBuV/m)	LIMIT (dBuV/m)	MARGIN (dB)	ANTENNA HEIGHT (m)	TABLE ANGLE (Degree)	RAW VALUE (dBuV)	CORRECTION FACTOR (dB/m)
1	2390.00	46.2 PK	74.0	-27.8	1.00 V	90	15.40	30.80
2	2390.00	36.5 AV	54.0	-17.5	1.00 V	90	5.70	30.80
3	#2400.00	46.1 PK	75.1	-29.0	1.00 V	88	15.20	30.90
4	#2400.00	16.0 AV	45.0	-29.0	1.00 V	88	-14.90	30.90
5	*2402.00	95.1 PK			1.00 V	83	64.20	30.90
6	*2402.00	65.0 AV			1.00 V	83	34.10	30.90
7	4804.00	49.3 PK	74.0	-24.7	1.42 V	197	12.40	36.90
8	4804.00	19.2 AV	54.0	-34.8	1.42 V	197	-17.70	36.90

REMARKS:

- Emission level (dBuV/m) = Raw Value (dBuV) + Correction Factor (dB/m).
- Correction Factor (dB/m) = Antenna Factor (dB/m) + Cable Factor (dB).
- The other emission levels were very low against the limit.
- Margin value = Emission level – Limit value.
- " * ": Fundamental frequency.
- The DH5 packet was the worse case duty cycle for a transmit dwell time on a channel, based upon bluetooth theory the transmitter is on 0.625 * 5 per 296.25 ms per channel. Therefore, the duty cycle correlation factor be equal to: 20log(3.125 / 100)= -30.1 dB.
- Average value = peak reading + 20log(duty cycle).
- "#":The radiated frequency is out the restricted band.



A D T

EUT TEST CONDITION		MEASUREMENT DETAIL	
CHANNEL	Channel 39	FREQUENCY RANGE	1 ~ 25GHz
INPUT POWER (SYSTEM)	120Vac, 60 Hz	DETECTOR FUNCTION	Peak (PK) Average (AV)
ENVIRONMENTAL CONDITIONS	25deg. C, 65%RH	TESTED BY	Brad Tung

ANTENNA POLARITY & TEST DISTANCE: HORIZONTAL AT 3 M								
NO.	FREQ. (MHz)	EMISSION LEVEL (dBuV/m)	LIMIT (dBuV/m)	MARGIN (dB)	ANTENNA HEIGHT (m)	TABLE ANGLE (Degree)	RAW VALUE (dBuV)	CORRECTION FACTOR (dB/m)
1	*2441.00	102.2 PK			1.27 H	296	71.20	31.00
2	*2441.00	72.1 AV			1.27 H	296	41.10	31.00
3	4884.00	51.1 PK	74.0	-22.9	1.21 H	268	14.00	37.10
4	4884.00	21.0 AV	54.0	-33.0	1.21 H	268	-16.10	37.10
ANTENNA POLARITY & TEST DISTANCE: VERTICAL AT 3 M								
NO.	FREQ. (MHz)	EMISSION LEVEL (dBuV/m)	LIMIT (dBuV/m)	MARGIN (dB)	ANTENNA HEIGHT (m)	TABLE ANGLE (Degree)	RAW VALUE (dBuV)	CORRECTION FACTOR (dB/m)
1	*2441.00	96.1 PK			1.00 V	100	65.10	31.00
2	*2441.00	66.0 AV			1.00 V	100	35.00	31.00
3	4884.00	50.1 PK	74.0	-23.9	1.38 V	201	13.00	37.10
4	4884.00	20.0 AV	54.0	-34.0	1.38 V	201	-17.10	37.10

REMARKS:

1. Emission level (dBuV/m) = Raw Value (dBuV) + Correction Factor (dB/m).
2. Correction Factor (dB/m) = Antenna Factor (dB/m) + Cable Factor (dB).
3. The other emission levels were very low against the limit.
4. Margin value = Emission level – Limit value.
5. “ * “: Fundamental frequency.
6. The DH5 packet was the worse case duty cycle for a transmit dwell time on a channel, based upon bluetooth theory the transmitter is on 0.625 * 5 per 296.25 ms per channel. Therefore, the duty cycle correlation factor be equal to: $20\log(3.125 / 100) = -30.1$ dB.
7. Average value = peak reading + $20\log(\text{duty cycle})$.



EUT TEST CONDITION		MEASUREMENT DETAIL	
CHANNEL	Channel 78	FREQUENCY RANGE	1 ~ 25GHz
INPUT POWER (SYSTEM)	120Vac, 60 Hz	DETECTOR FUNCTION	Peak (PK) Average (AV)
ENVIRONMENTAL CONDITIONS	25deg. C, 65%RH	TESTED BY	Brad Tung

ANTENNA POLARITY & TEST DISTANCE: HORIZONTAL AT 3 M								
NO.	FREQ. (MHz)	EMISSION LEVEL (dBuV/m)	LIMIT (dBuV/m)	MARGIN (dB)	ANTENNA HEIGHT (m)	TABLE ANGLE (Degree)	RAW VALUE (dBuV)	CORRECTION FACTOR (dB/m)
1	*2480.00	102.6 PK			1.30 H	303	71.40	31.20
2	*2480.00	72.5 AV			1.30 H	303	41.30	31.20
3	2483.50	50.6 PK	74.0	-23.4	1.30 H	303	19.40	31.20
4	2483.50	20.5 AV	54.0	-33.5	1.30 H	303	-10.70	31.20
5	4960.00	51.7 PK	74.0	-22.3	1.24 H	233	14.40	37.30
6	4960.00	21.6 AV	54.0	-32.4	1.24 H	233	-15.70	37.30
ANTENNA POLARITY & TEST DISTANCE: VERTICAL AT 3 M								
NO.	FREQ. (MHz)	EMISSION LEVEL (dBuV/m)	LIMIT (dBuV/m)	MARGIN (dB)	ANTENNA HEIGHT (m)	TABLE ANGLE (Degree)	RAW VALUE (dBuV)	CORRECTION FACTOR (dB/m)
1	*2480.00	96.2 PK			1.00 V	85	65.00	31.20
2	*2480.00	66.1 AV			1.00 V	85	34.90	31.20
3	2483.50	44.2 PK	74.0	-29.8	1.00 V	85	13.00	31.20
4	2483.50	14.1 AV	54.0	-39.9	1.00 V	85	-17.10	31.20
5	4960.00	50.2 PK	74.0	-23.8	1.39 V	195	12.90	37.30
6	4960.00	20.1 AV	54.0	-33.9	1.39 V	195	-17.20	37.30

REMARKS:

1. Emission level (dBuV/m) = Raw Value (dBuV) + Correction Factor (dB/m).
2. Correction Factor (dB/m) = Antenna Factor (dB/m) + Cable Factor (dB).
3. The other emission levels were very low against the limit.
4. Margin value = Emission level – Limit value.
5. “ * “: Fundamental frequency.
6. The DH5 packet was the worse case duty cycle for a transmit dwell time on a channel, based upon bluetooth theory the transmitter is on 0.625 * 5 per 296.25 ms per channel. Therefore, the duty cycle correlation factor be equal to: $20\log(3.125 / 100) = -30.1$ dB.
7. Average value = peak reading + $20\log(\text{duty cycle})$.



8DPSK

EUT TEST CONDITION		MEASUREMENT DETAIL	
CHANNEL	Channel 0	FREQUENCY RANGE	1 ~ 25GHz
INPUT POWER (SYSTEM)	120Vac, 60 Hz	DETECTOR FUNCTION	Peak (PK) Average (AV)
ENVIRONMENTAL CONDITIONS	25deg. C, 65%RH	TESTED BY	Brad Tung

ANTENNA POLARITY & TEST DISTANCE: HORIZONTAL AT 3 M								
NO.	FREQ. (MHz)	EMISSION LEVEL (dBuV/m)	LIMIT (dBuV/m)	MARGIN (dB)	ANTENNA HEIGHT (m)	TABLE ANGLE (Degree)	RAW VALUE (dBuV)	CORRECTION FACTOR (dB/m)
1	2390.00	48.2 PK	74.0	-25.8	1.34 H	302	17.40	30.80
2	2390.00	37.3 AV	54.0	-16.7	1.34 H	302	6.50	30.80
3	#2400.00	47.6 PK	80.6	-33.0	1.34 H	302	16.70	30.90
4	#2400.00	17.5 AV	50.5	-33.0	1.34 H	302	-13.40	30.90
5	*2402.00	100.6 PK			1.34 H	302	69.70	30.90
6	*2402.00	70.5 AV			1.34 H	302	39.60	30.90
7	4804.00	51.6 PK	74.0	-22.4	1.17 H	223	14.70	36.90
8	4804.00	21.5 AV	54.0	-32.5	1.17 H	223	-15.40	36.90
ANTENNA POLARITY & TEST DISTANCE: VERTICAL AT 3 M								
NO.	FREQ. (MHz)	EMISSION LEVEL (dBuV/m)	LIMIT (dBuV/m)	MARGIN (dB)	ANTENNA HEIGHT (m)	TABLE ANGLE (Degree)	RAW VALUE (dBuV)	CORRECTION FACTOR (dB/m)
1	2390.00	46.0 PK	74.0	-28.0	1.00 V	103	15.20	30.80
2	2390.00	36.7 AV	54.0	-17.3	1.00 V	103	5.90	30.80
3	#2400.00	42.5 PK	75.5	-33.0	1.00 V	103	11.60	30.90
4	#2400.00	12.4 AV	45.4	-33.0	1.00 V	103	-18.50	30.90
5	*2402.00	95.5 PK			1.00 V	103	64.60	30.90
6	*2402.00	65.4 AV			1.00 V	103	34.50	30.90
7	4804.00	50.1 PK	74.0	-23.9	1.38 V	192	13.20	36.90
8	4804.00	20.0 AV	54.0	-34.0	1.38 V	192	-16.90	36.90

REMARKS:

1. Emission level (dBuV/m) = Raw Value (dBuV) + Correction Factor (dB/m).
2. Correction Factor (dB/m) = Antenna Factor (dB/m) + Cable Factor (dB).
3. The other emission levels were very low against the limit.
4. Margin value = Emission level – Limit value.
5. “ * “: Fundamental frequency.
6. The DH5 packet was the worse case duty cycle for a transmit dwell time on a channel, based upon bluetooth theory the transmitter is on 0.625 * 5 per 296.25 ms per channel. Therefore, the duty cycle correlation factor be equal to: $20\log(3.125 / 100) = -30.1 \text{ dB}$.
7. Average value = peak reading + $20\log(\text{duty cycle})$.
8. "#":The radiated frequency is out the restricted band.



A D T

EUT TEST CONDITION		MEASUREMENT DETAIL	
CHANNEL	Channel 39	FREQUENCY RANGE	1 ~ 25GHz
INPUT POWER (SYSTEM)	120Vac, 60 Hz	DETECTOR FUNCTION	Peak (PK) Average (AV)
ENVIRONMENTAL CONDITIONS	25deg. C, 65%RH	TESTED BY	Brad Tung

ANTENNA POLARITY & TEST DISTANCE: HORIZONTAL AT 3 M								
NO.	FREQ. (MHz)	EMISSION LEVEL (dBuV/m)	LIMIT (dBuV/m)	MARGIN (dB)	ANTENNA HEIGHT (m)	TABLE ANGLE (Degree)	RAW VALUE (dBuV)	CORRECTION FACTOR (dB/m)
1	*2441.00	102.1 PK			1.32 H	300	71.10	31.00
2	*2441.00	72.0 AV			1.32 H	300	41.00	31.00
3	4884.00	51.4 PK	74.0	-22.6	1.22 H	270	14.30	37.10
4	4884.00	21.3 AV	54.0	-32.7	1.22 H	270	-15.80	37.10
ANTENNA POLARITY & TEST DISTANCE: VERTICAL AT 3 M								
NO.	FREQ. (MHz)	EMISSION LEVEL (dBuV/m)	LIMIT (dBuV/m)	MARGIN (dB)	ANTENNA HEIGHT (m)	TABLE ANGLE (Degree)	RAW VALUE (dBuV)	CORRECTION FACTOR (dB/m)
1	*2441.00	96.3 PK			1.00 V	105	65.30	31.00
2	*2441.00	66.2 AV			1.00 V	105	35.20	31.00
3	4884.00	50.2 PK	74.0	-23.8	1.42 V	196	13.10	37.10
4	4884.00	20.1 AV	54.0	-33.9	1.42 V	196	-17.00	37.10

REMARKS:

1. Emission level (dBuV/m) = Raw Value (dBuV) + Correction Factor (dB/m).
2. Correction Factor (dB/m) = Antenna Factor (dB/m) + Cable Factor (dB).
3. The other emission levels were very low against the limit.
4. Margin value = Emission level – Limit value.
5. “ * “: Fundamental frequency.
6. The DH5 packet was the worse case duty cycle for a transmit dwell time on a channel, based upon bluetooth theory the transmitter is on 0.625 * 5 per 296.25 ms per channel. Therefore, the duty cycle correlation factor be equal to: $20\log(3.125 / 100) = -30.1$ dB.
7. Average value = peak reading + $20\log(\text{duty cycle})$.



A D T

EUT TEST CONDITION		MEASUREMENT DETAIL	
CHANNEL	Channel 78	FREQUENCY RANGE	1 ~ 25GHz
INPUT POWER (SYSTEM)	120Vac, 60 Hz	DETECTOR FUNCTION	Peak (PK) Average (AV)
ENVIRONMENTAL CONDITIONS	25deg. C, 65%RH	TESTED BY	Brad Tung

ANTENNA POLARITY & TEST DISTANCE: HORIZONTAL AT 3 M								
NO.	FREQ. (MHz)	EMISSION LEVEL (dBuV/m)	LIMIT (dBuV/m)	MARGIN (dB)	ANTENNA HEIGHT (m)	TABLE ANGLE (Degree)	RAW VALUE (dBuV)	CORRECTION FACTOR (dB/m)
1	*2480.00	102.4 PK			1.31 H	299	71.20	31.20
2	*2480.00	72.3 AV			1.31 H	299	41.10	31.20
3	2483.50	50.4 PK	74.0	-23.6	1.31 H	299	19.20	31.20
4	2483.50	20.3 AV	54.0	-33.7	1.31 H	299	-10.90	31.20
5	4960.00	51.2 PK	74.0	-22.8	1.25 H	253	13.90	37.30
6	4960.00	21.1 AV	54.0	-32.9	1.25 H	253	-16.20	37.30
ANTENNA POLARITY & TEST DISTANCE: VERTICAL AT 3 M								
NO.	FREQ. (MHz)	EMISSION LEVEL (dBuV/m)	LIMIT (dBuV/m)	MARGIN (dB)	ANTENNA HEIGHT (m)	TABLE ANGLE (Degree)	RAW VALUE (dBuV)	CORRECTION FACTOR (dB/m)
1	*2480.00	97.1 PK			1.00 V	92	65.90	31.20
2	*2480.00	67.0 AV			1.00 V	92	35.80	31.20
3	2483.50	45.1 PK	74.0	-28.9	1.00 V	92	13.90	31.20
4	2483.50	15.0 AV	54.0	-39.0	1.00 V	92	-16.20	31.20
5	4960.00	51.1 PK	74.0	-22.9	1.44 V	200	13.80	37.30
6	4960.00	21.0 AV	54.0	-33.0	1.44 V	200	-16.30	37.30

REMARKS:

1. Emission level (dBuV/m) = Raw Value (dBuV) + Correction Factor (dB/m).
2. Correction Factor (dB/m) = Antenna Factor (dB/m) + Cable Factor (dB).
3. The other emission levels were very low against the limit.
4. Margin value = Emission level – Limit value.
5. “ * “: Fundamental frequency.
6. The DH5 packet was the worse case duty cycle for a transmit dwell time on a channel, based upon bluetooth theory the transmitter is on 0.625 * 5 per 296.25 ms per channel. Therefore, the duty cycle correlation factor be equal to: $20\log(3.125 / 100) = -30.1$ dB.
7. Average value = peak reading + $20\log(\text{duty cycle})$.



A D T

BELOW 1GHz WORST-CASE DATA : 8DPSK

EUT TEST CONDITION		MEASUREMENT DETAIL	
CHANNEL	Channel 78	FREQUENCY RANGE	Below 1000MHz
INPUT POWER (SYSTEM)	120Vac, 60 Hz	DETECTOR FUNCTION	Quasi-Peak
ENVIRONMENTAL CONDITIONS	25deg. C, 65%RH	TESTED BY	Brad Tung

ANTENNA POLARITY & TEST DISTANCE: HORIZONTAL AT 3 M								
NO.	FREQ. (MHz)	EMISSION LEVEL (dBuV/m)	LIMIT (dBuV/m)	MARGIN (dB)	ANTENNA HEIGHT (m)	TABLE ANGLE (Degree)	RAW VALUE (dBuV)	CORRECTION FACTOR (dB/m)
1	300.16	39.5 QP	46.0	-6.5	2.00 H	346	24.80	14.70
2	360.43	35.2 QP	46.0	-10.8	2.00 H	15	18.80	16.40
3	420.70	38.5 QP	46.0	-7.5	1.50 H	118	20.50	18.00
4	539.30	27.6 QP	46.0	-18.4	1.00 H	15	6.70	20.90
5	599.58	31.4 QP	46.0	-14.6	1.00 H	43	8.90	22.50
6	720.12	33.6 QP	46.0	-12.4	1.00 H	39	9.20	24.40

ANTENNA POLARITY & TEST DISTANCE: VERTICAL AT 3 M								
NO.	FREQ. (MHz)	EMISSION LEVEL (dBuV/m)	LIMIT (dBuV/m)	MARGIN (dB)	ANTENNA HEIGHT (m)	TABLE ANGLE (Degree)	RAW VALUE (dBuV)	CORRECTION FACTOR (dB/m)
1	136.84	29.3 QP	43.5	-14.2	1.50 V	210	16.00	13.30
2	179.61	25.8 QP	43.5	-17.7	1.00 V	21	13.70	12.10
3	360.43	35.0 QP	46.0	-11.0	1.25 V	319	18.60	16.40
4	420.70	33.4 QP	46.0	-12.6	1.00 V	147	15.40	18.00
5	479.03	31.0 QP	46.0	-15.0	1.25 V	168	11.60	19.40
6	539.30	36.2 QP	46.0	-9.8	1.00 V	193	15.30	20.90

REMARKS:

1. Emission level (dBuV/m) = Raw Value (dBuV) + Correction Factor (dB/m).
2. Correction Factor (dB/m) = Antenna Factor (dB/m) + Cable Factor (dB).
3. The other emission levels were very low against the limit.
4. Margin value = Emission level – Limit value.



4.2 CONDUCTED EMISSION MEASUREMENT

4.2.1 LIMITS OF CONDUCTED EMISSION MEASUREMENT

FREQUENCY OF EMISSION (MHz)	CONDUCTED LIMIT (dBµV)	
	Quasi-peak	Average
0.15 ~ 0.5	66 to 56	56 to 46
0.5 ~ 5	56	46
5 ~ 30	60	50

- NOTE:**
1. The lower limit shall apply at the transition frequencies.
 2. The limit decreases in line with the logarithm of the frequency in the range of 0.15 to 0.50MHz.
 3. All emanations from a class A/B digital device or system, including any network of conductors and apparatus connected thereto, shall not exceed the level of field strengths specified above.

4.2.2 TEST INSTRUMENTS

DESCRIPTION & MANUFACTURER	MODEL NO.	SERIAL NO.	DATE OF CALIBRATION	DUE DATE OF CALIBRATION
Test Receiver ROHDE & SCHWARZ	ESCS30	100288	Nov. 09, 2012	Nov. 08, 2013
RF signal cable Woken	5D-FB	Cable-HYCO2-01	Dec. 28, 2012	Dec. 27, 2013
LISN ROHDE & SCHWARZ (EUT)	ESH2-Z5	100100	Dec. 21, 2012	Dec. 20, 2013
LISN ROHDE & SCHWARZ (Peripheral)	ESH3-Z5	100311	Jul. 06, 2012	Jul. 05, 2013
Software ADT	BV ADT_Cond_ V7.3.7.3	NA	NA	NA

- NOTE:**
1. The calibration interval of the above test instruments is 12 months and the calibrations are traceable to NML/ROC and NIST/USA.
 2. The test was performed in HwaYa Shielded Room 2.
 3. The VCCI Site Registration No. is C-2047.

4.2.3 TEST PROCEDURES

- a. The EUT was placed 0.4 meters from the conducting wall of the shielded room with EUT being connected to the power mains through a line impedance stabilization network (LISN). Other support units were connected to the power mains through another LISN. The two LISNs provide 50 ohm/ 50uH of coupling impedance for the measuring instrument.
- b. Both lines of the power mains connected to the EUT were checked for maximum conducted interference.
- c. The frequency range from 150kHz to 30MHz was searched. Emission levels under (Limit - 20dB) was not recorded.

NOTE: All modes of operation were investigated and the worst-case emissions are reported.

4.2.4 DEVIATION FROM TEST STANDARD

No deviation.

4.2.5 TEST SETUP

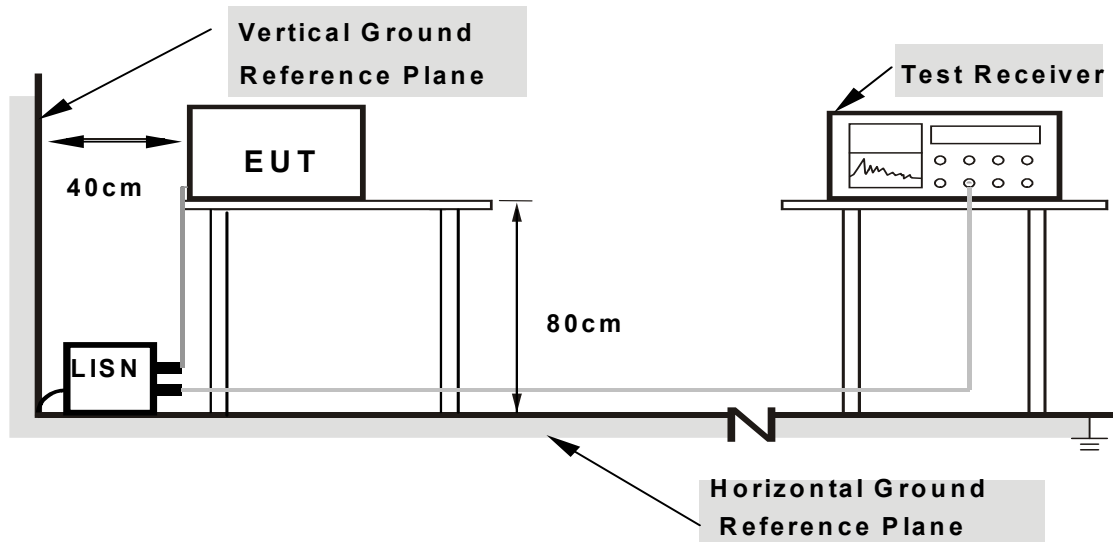

- Note:**
1. Support units were connected to second LISN.
 2. Both of LISNs (AMN) are 80 cm from EUT and at least 80 from other units and other metal planes

For the actual test configuration, please refer to the attached file (Test Setup Photo).

4.2.6 EUT OPERATING CONDITIONS

Test Mode A

- a. Connected EUT with a notebook system via USB cable and placed on a testing table.
- b. The notebook system ran a test program (provided by manufacturer) to enable EUT under transmission condition continuously at specific channel frequency.

Test Mode B

Set the EUT under transmission condition continuously at specific channel frequency.



A D T

4.2.7 TEST RESULTS

CONDUCTED WORST-CASE DATA : 8DPSK

PHASE	Line 1	6dB BANDWIDTH	9kHz
TEST MODE	A		

No	Freq. [MHz]	Corr. Factor (dB)	Reading Value		Emission Level		Limit		Margin	
			[dB (uV)]		[dB (uV)]		[dB (uV)]		(dB)	
			Q.P.	AV.	Q.P.	AV.	Q.P.	AV.	Q.P.	AV.
1	0.20078	0.12	49.83	42.39	49.95	42.51	63.58	53.58	-13.63	-11.07
2	0.33750	0.14	44.40	42.90	44.54	43.04	59.26	49.26	-14.72	-6.22
3	0.40391	0.15	43.99	43.99	44.14	44.14	57.77	47.77	-13.63	-3.63
4	0.47031	0.16	45.73	44.16	45.89	44.32	56.51	46.51	-10.62	-2.19
5	1.81641	0.23	42.69	42.32	42.92	42.55	56.00	46.00	-13.08	-3.45
6	6.45703	0.47	38.26	37.80	38.73	38.27	60.00	50.00	-21.27	-11.73

- REMARKS:**
1. Q.P. and AV. are abbreviations of quasi-peak and average individually.
 2. The emission levels of other frequencies were very low against the limit.
 3. Margin value = Emission level - Limit value
 4. Correction factor = Insertion loss + Cable loss
 5. Emission Level = Correction Factor + Reading Value.

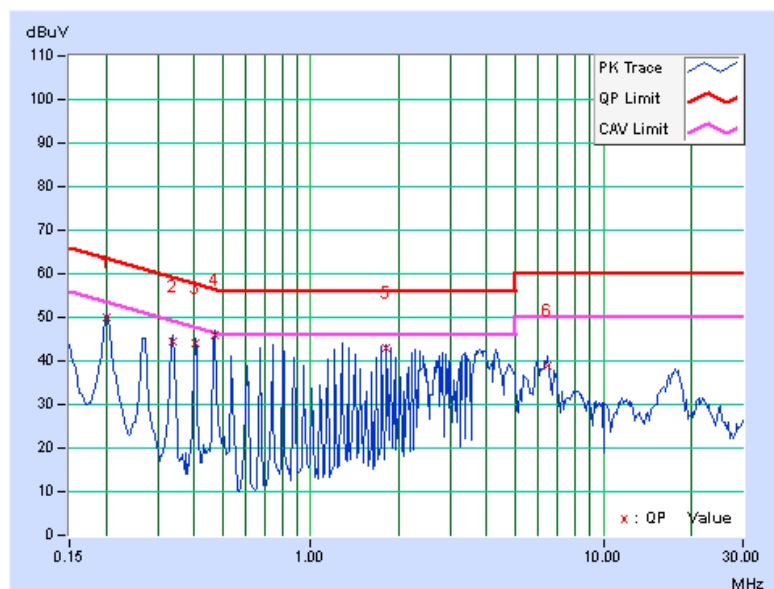



A D T

PHASE	Line 2	6dB BANDWIDTH	9kHz
TEST MODE	A		

No	Freq. [MHz]	Corr. Factor (dB)	Reading Value		Emission Level		Limit		Margin	
			[dB (uV)]		[dB (uV)]		[dB (uV)]		(dB)	
			Q.P.	AV.	Q.P.	AV.	Q.P.	AV.	Q.P.	AV.
1	0.20078	0.17	46.79	39.76	46.96	39.93	63.58	53.58	-16.62	-13.65
2	0.40391	0.21	43.94	43.11	44.15	43.32	57.77	47.77	-13.62	-4.45
3	0.47031	0.21	41.97	40.49	42.18	40.70	56.51	46.51	-14.32	-5.80
4	0.53672	0.22	41.96	41.35	42.18	41.57	56.00	46.00	-13.82	-4.43
5	1.75000	0.27	42.39	41.90	42.66	42.17	56.00	46.00	-13.34	-3.83
6	5.85156	0.44	38.51	38.45	38.95	38.89	60.00	50.00	-21.05	-11.11

- REMARKS:**
1. Q.P. and AV. are abbreviations of quasi-peak and average individually.
 2. The emission levels of other frequencies were very low against the limit.
 3. Margin value = Emission level - Limit value
 4. Correction factor = Insertion loss + Cable loss
 5. Emission Level = Correction Factor + Reading Value.

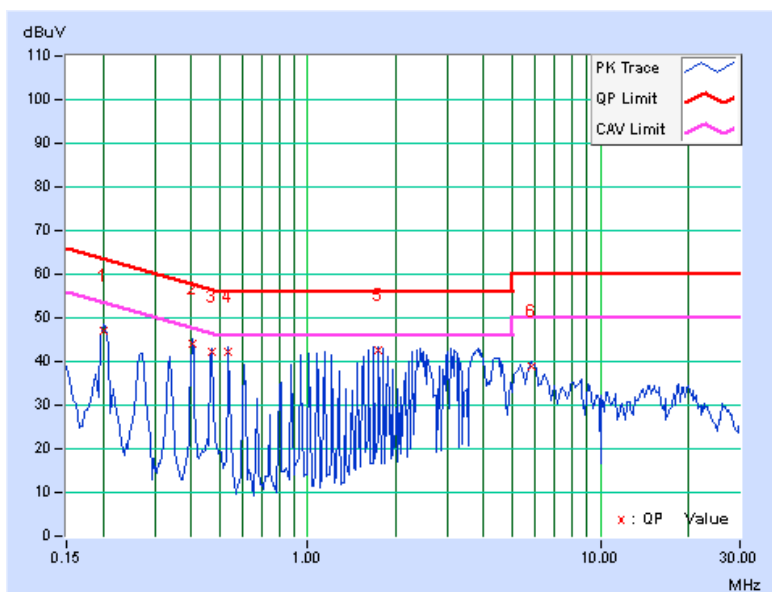



PHASE	Line 1	6dB BANDWIDTH	9kHz
TEST MODE	B		

No	Freq. [MHz]	Corr. Factor (dB)	Reading Value		Emission Level		Limit		Margin	
			[dB (uV)]		[dB (uV)]		[dB (uV)]		(dB)	
			Q.P.	AV.	Q.P.	AV.	Q.P.	AV.	Q.P.	AV.
1	0.15781	0.12	34.51	19.60	34.63	19.72	65.58	55.58	-30.94	-35.85
2	0.18125	0.12	36.55	27.95	36.67	28.07	64.43	54.43	-27.76	-26.36
3	0.34531	0.14	35.91	22.73	36.05	22.87	59.07	49.07	-23.02	-26.20
4	1.30078	0.22	26.32	12.06	26.54	12.28	56.00	46.00	-29.46	-33.72
5	2.67969	0.27	31.93	17.06	32.20	17.33	56.00	46.00	-23.80	-28.67
6	4.17578	0.36	32.92	17.93	33.28	18.29	56.00	46.00	-22.72	-27.71

- REMARKS:**
1. Q.P. and AV. are abbreviations of quasi-peak and average individually.
 2. The emission levels of other frequencies were very low against the limit.
 3. Margin value = Emission level - Limit value
 4. Correction factor = Insertion loss + Cable loss
 5. Emission Level = Correction Factor + Reading Value.

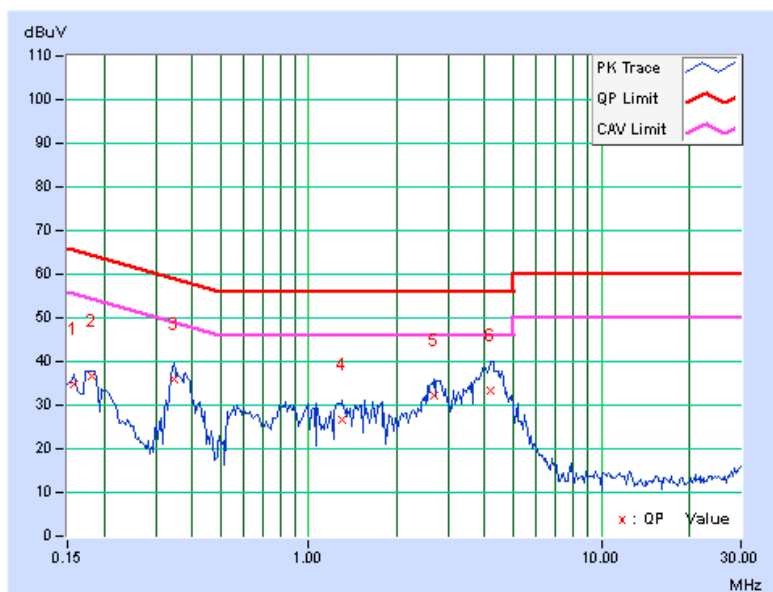



A D T

PHASE	Line 2	6dB BANDWIDTH	9kHz
TEST MODE	B		

No	Freq. [MHz]	Corr. Factor (dB)	Reading Value		Emission Level		Limit		Margin	
			[dB (uV)]		[dB (uV)]		[dB (uV)]		(dB)	
			Q.P.	AV.	Q.P.	AV.	Q.P.	AV.	Q.P.	AV.
1	0.15000	0.18	29.65	20.37	29.83	20.55	66.00	56.00	-36.17	-35.45
2	0.18906	0.17	30.28	15.68	30.45	15.85	64.08	54.08	-33.63	-38.23
3	0.34659	0.20	38.79	27.92	38.99	28.12	59.04	49.04	-20.05	-20.92
4	0.84531	0.24	28.54	17.57	28.78	17.81	56.00	46.00	-27.22	-28.19
5	2.66797	0.31	32.11	20.58	32.42	20.89	56.00	46.00	-23.58	-25.11
6	4.29688	0.39	31.07	17.93	31.46	18.32	56.00	46.00	-24.54	-27.68

- REMARKS:**
1. Q.P. and AV. are abbreviations of quasi-peak and average individually.
 2. The emission levels of other frequencies were very low against the limit.
 3. Margin value = Emission level - Limit value
 4. Correction factor = Insertion loss + Cable loss
 5. Emission Level = Correction Factor + Reading Value.

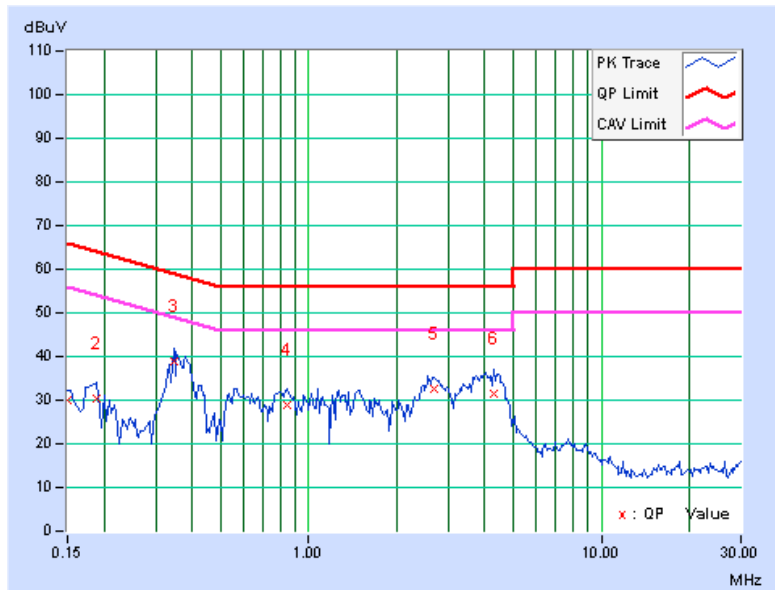

4.3 NUMBER OF HOPPING FREQUENCY USED

4.3.1 LIMIT OF HOPPING FREQUENCY USED

At least 15 channels frequencies, and should be equally spaced.

4.3.2 TEST SETUP

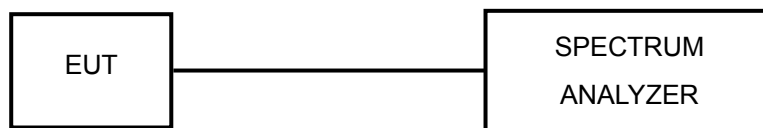

4.3.3 TEST INSTRUMENTS

Refer to section 4.1.2 to get information of above instrument.

4.3.4 TEST PROCEDURES

- a. Check the calibration of the measuring instrument (SA) using either an internal calibrator or a known signal from an external generator.
- b. Turn on the EUT and connect its antenna terminal to measurement via a low loss cable. Then set it to any one measured frequency within its operating range and make sure the instrument is operated in its linear range.
- c. Set the SA on MaxHold Mode, and then keep the EUT in hopping mode. Record all the signals from each channel until each one has been recorded.
- d. Set the SA on View mode and then plot the result on SA screen.
- e. Repeat above procedures until all frequencies measured were complete.

4.3.5 DEVIATION FROM TEST STANDARD

No deviation.

4.3.6 TEST RESULTS

There are 79 hopping frequencies in the hopping mode. Please refer to next page for the test result. On the plots, it shows that the hopping frequencies are equally spaced.



A D T

GFSK

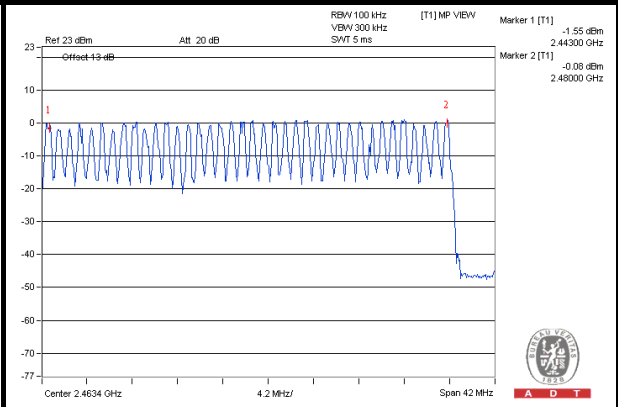
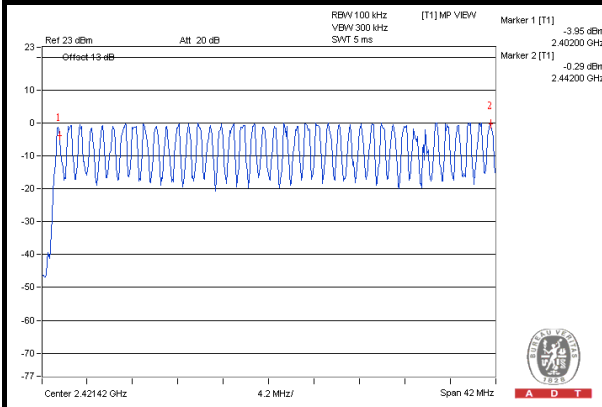

8DPSK

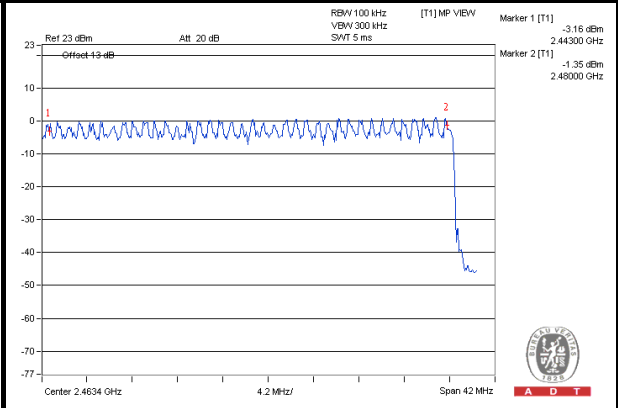
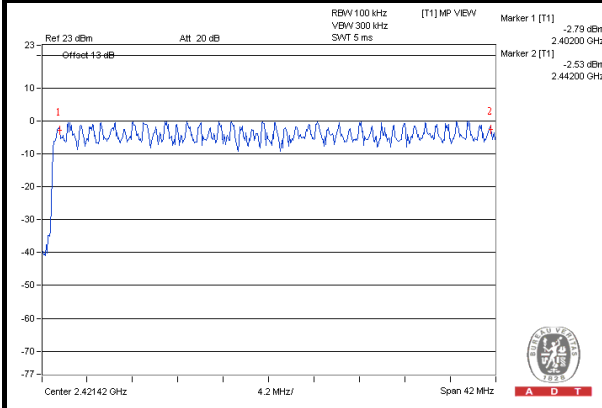

4.4 DWELL TIME ON EACH CHANNEL

4.4.1 LIMIT OF DWELL TIME USED

The average time of occupancy on any channel shall not be greater than 0.4 seconds within a period of 0.4 seconds multiplied by the number of hopping channels employed.

4.4.2 TEST SETUP

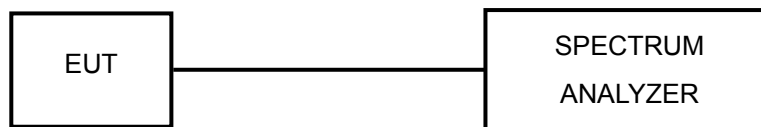

4.4.3 TEST INSTRUMENTS

Refer to section 4.1.2 to get information of above instrument.

4.4.4 TEST PROCEDURES

- Check the calibration of the measuring instrument (SA) using either an internal calibrator or a known signal from an external generator.
- Turn on the EUT and connect its antenna terminal to measurement via a low loss cable. Then set it to any one measured frequency within its operating range and make sure the instrument is operated in its linear range.
- Adjust the center frequency of SA on any frequency be measured and set SA to zero span mode. And then, set RBW and VBW of spectrum analyzer to proper value.
- Measure the time duration of one transmission on the measured frequency. And then plot the result with time difference of this time duration.
- Repeat above procedures until all different time-slot modes have been completed.

4.4.5 DEVIATION FROM TEST STANDARD

No deviation.



A D T

4.4.6 TEST RESULTS

GFSK

Mode	Number of transmission in a 31.6 (79Hopping*0.4)	Length of transmission time (msec)	Result (msec)	Limit (msec)
DH1	$50 \text{ (times / 5 sec)} * 6.32 = 316.00 \text{ times}$	0.480	151.680	400
DH3	$26 \text{ (times / 5 sec)} * 6.32 = 164.32 \text{ times}$	1.770	290.846	400
DH5	$17 \text{ (times / 5 sec)} * 6.32 = 107.44 \text{ times}$	2.990	321.246	400

NOTE: Test plots of the transmitting time slot are shown on next page.



A D T





A D T

8DPSK

Mode	Number of transmission in a 31.6 (79Hopping*0.4)	Length of transmission time (msec)	Result (msec)	Limit (msec)
DH1	$50 \text{ (times / 5 sec)} * 6.32 = 316.00 \text{ times}$	0.492	155.472	400
DH3	$25 \text{ (times / 5 sec)} * 6.32 = 158.00 \text{ times}$	1.770	279.660	400
DH5	$17 \text{ (times / 5 sec)} * 6.32 = 107.44 \text{ times}$	3.050	327.692	400

NOTE: Test plots of the transmitting time slot are shown on next page.



A D T

DH1

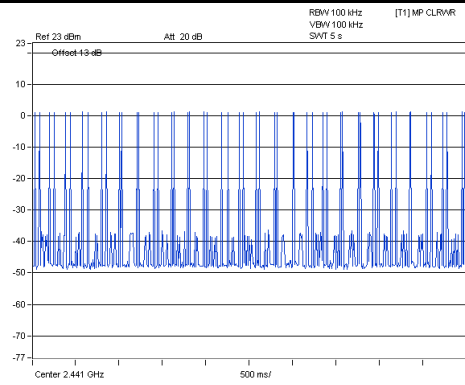

A D T

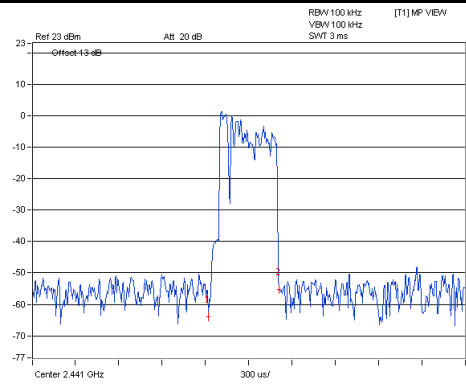

A D T

DH3

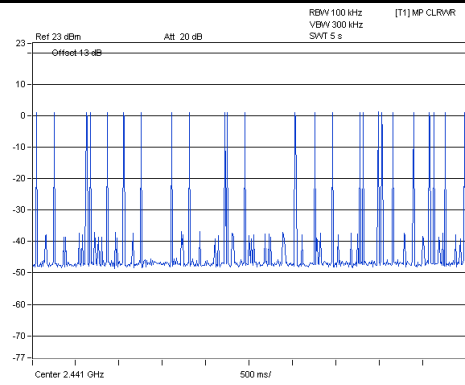

A D T

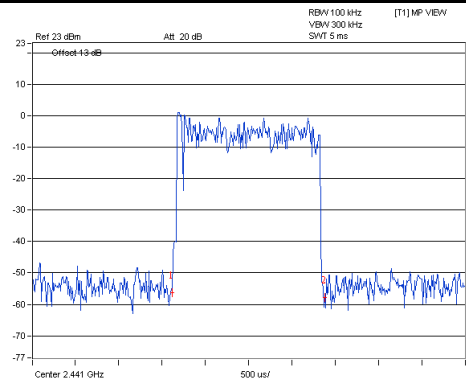

A D T

DH5

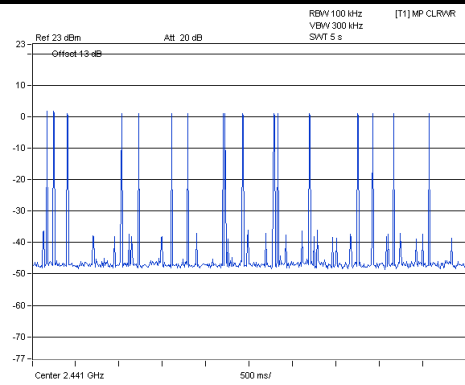

A D T

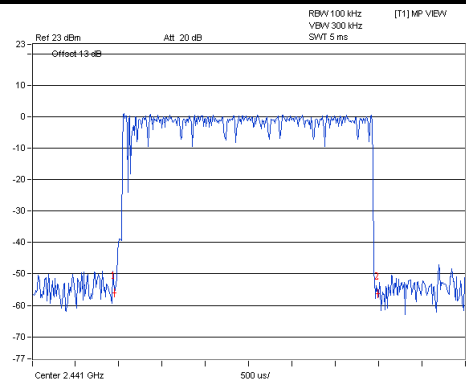

A D T

4.5 CHANNEL BANDWIDTH

4.5.1 LIMITS OF CHANNEL BANDWIDTH

For frequency hopping system operating in the 2400-2483.5MHz, If the 20dB bandwidth of hopping channel is greater than 25kHz, two-thirds 20dB bandwidth of hopping channel shall be a minimum limit for the hopping channel separation.

4.5.2 TEST SETUP

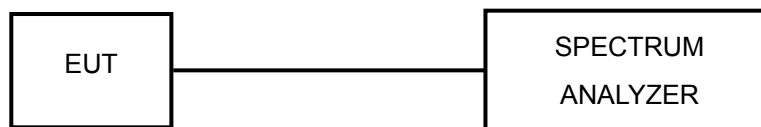

4.5.3 TEST INSTRUMENTS

Refer to section 4.1.2 to get information of above instrument.

4.5.4 TEST PROCEDURE

- a. Check the calibration of the measuring instrument using either an internal calibrator or a known signal from an external generator.
- b. Turn on the EUT and connect it to measurement instrument. Then set it to any one convenient frequency within its operating range. Set a reference level on the measuring instrument equal to the highest peak value.
- c. Measure the frequency difference of two frequencies that were attenuated 20dB from the reference level. Record the frequency difference as the emission bandwidth.
- d. Repeat above procedures until all frequencies measured were complete.

4.5.5 DEVIATION FROM TEST STANDARD

No deviation.

4.5.6 EUT OPERATING CONDITION

The software provided by client enabled the EUT to transmit and receive data at lowest, middle and highest channel frequencies individually.



A D T

4.5.7 TEST RESULTS

CHANNEL	FREQUENCY (MHz)	20dB BANDWIDTH (MHz)	
		GFSK	8DPSK
0	2402	1.00	1.28
39	2441	1.02	1.28
78	2480	1.02	1.27

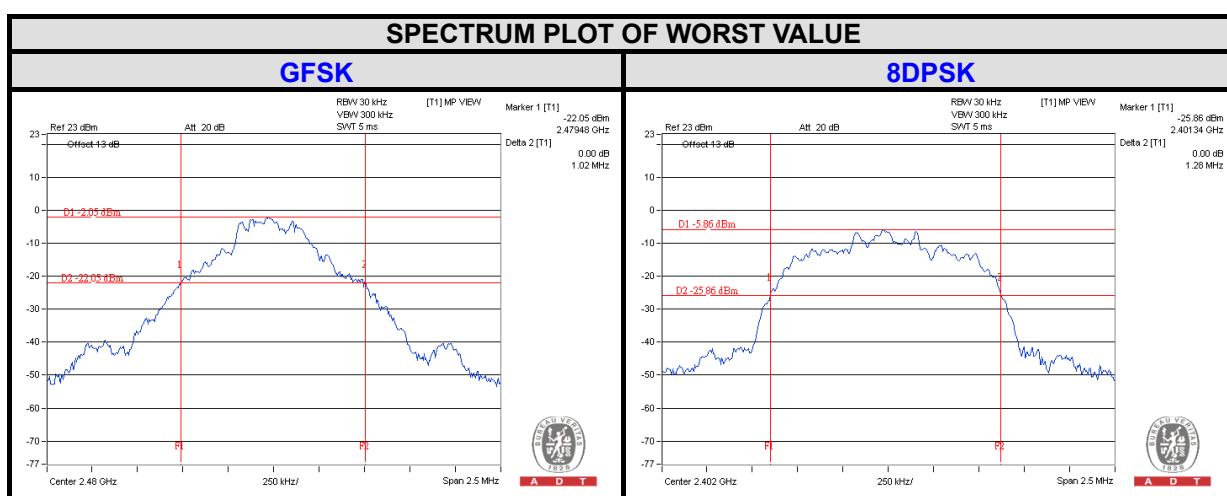

4.6 HOPPING CHANNEL SEPARATION

4.6.1 LIMIT OF HOPPING CHANNEL SEPARATION

At least 25kHz or two-third of 20dB hopping channel bandwidth (whichever is greater).

4.6.2 TEST SETUP

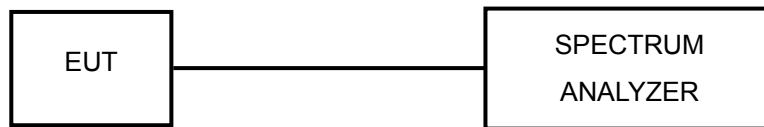

4.6.3 TEST INSTRUMENTS

Refer to section 4.1.2 to get information of above instrument.

4.6.4 TEST PROCEDURES

- a. Check the calibration of the measuring instrument using either an internal calibrator or a known signal from an external generator.
- b. Turn on the EUT and connect it to measurement instrument. Then set it to any one convenient frequency within its operating range.
- c. By using the MaxHold function record the separation of two adjacent channels.
- d. Measure the frequency difference of these two adjacent channels by SA MARK function. And then plot the result on SA screen.
- e. Repeat above procedures until all frequencies measured were complete.

4.6.5 DEVIATION FROM TEST STANDARD

No deviation.



A D T

4.6.6 TEST RESULTS

CHANNEL	FREQUENCY (MHz)	ADJACENT CHANNEL SEPARATION (MHz)		20dB BANDWIDTH (MHz)		MINIMUM LIMIT (MHz)		PASS / FAIL
		GFSK	8DPSK	GFSK	8DPSK	GFSK	8DPSK	
0	2402	1.000	1.000	1.00	1.28	0.667	0.853	PASS
39	2441	1.000	1.010	1.02	1.28	0.680	0.853	PASS
78	2480	1.000	1.000	1.02	1.27	0.680	0.847	PASS

NOTE: The minimum limit is two-third 20dB bandwidth.

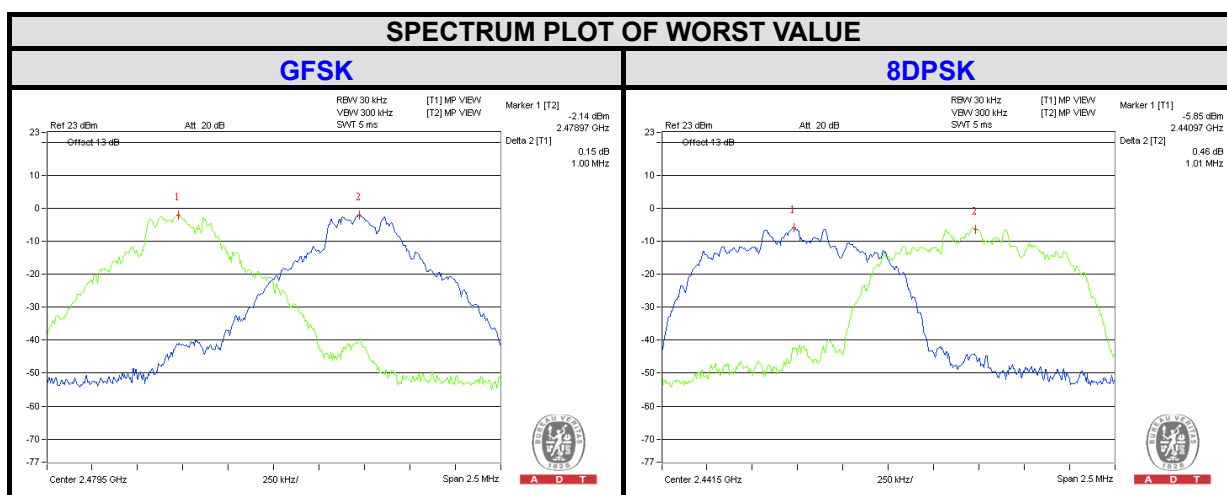

4.7 MAXIMUM OUTPUT POWER

4.7.1 LIMITS OF MAXIMUM OUTPUT POWER MEASUREMENT

The Maximum Output Power Measurement is 125mW.

4.7.2 TEST SETUP

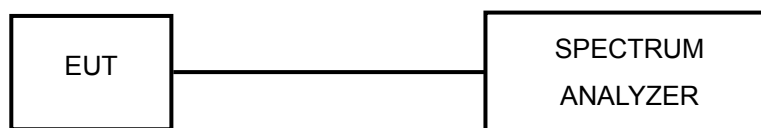

4.7.3 TEST INSTRUMENTS

Refer to section 4.1.2 to get information of above instrument.

4.7.4 TEST PROCEDURES

- a. Check the calibration of the measuring instrument using either an internal calibrator or a known signal from an external generator.
- b. Turn on the EUT and connect it to measurement instrument. Then set it to any one convenient frequency within its operating range. Set a reference level on the measuring instrument equal to the highest peak value.
- c. The center frequency of the spectrum analyzer is set to the fundamental frequency and using 3MHz RBW and 10 MHz VBW.
- d. Measure the captured power within the band and recording the plot.
- e. Repeat above procedures until all frequencies required were complete.

4.7.5 DEVIATION FROM TEST STANDARD

No deviation.

4.7.6 EUT OPERATING CONDITION

The software provided by client enabled the EUT to transmit and receive data at lowest, middle and highest channel frequencies individually.



A D T

4.7.7 TEST RESULTS

CHANNEL	FREQUENCY (MHz)	OUTPUT POWER (mW)		OUTPUT POWER (dBm)		POWER LIMIT (mW)	PASS / FAIL
		GFSK	8DPSK	GFSK	8DPSK		
0	2402	1.084	1.084	0.35	0.35	125	PASS
39	2441	1.132	1.156	0.54	0.63	125	PASS
78	2480	1.368	1.368	1.36	1.36	125	PASS

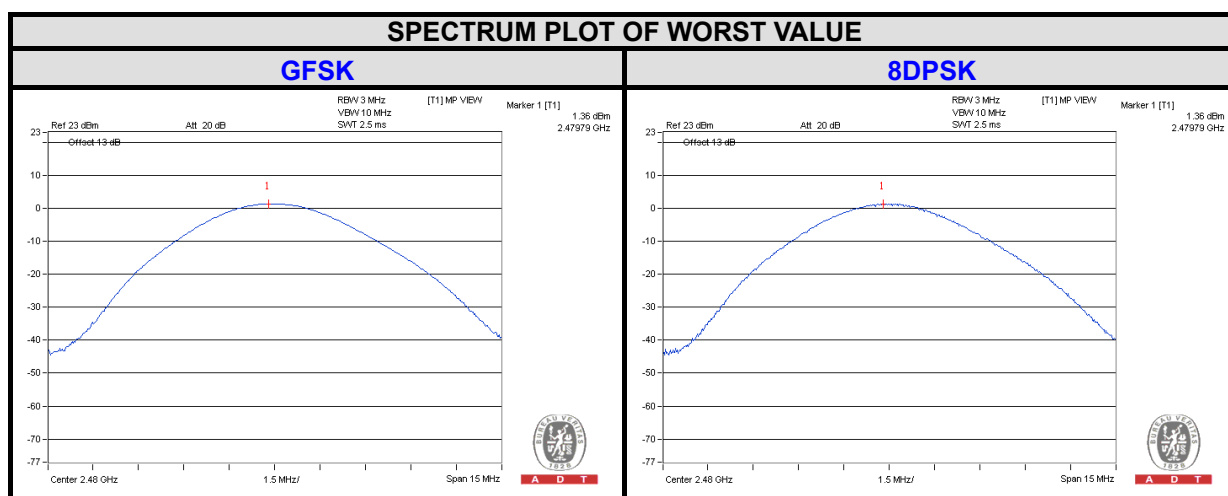

4.8 CONDUCTED OUT OF BAND EMISSION MEASUREMENT

4.8.1 LIMITS OF CONDUCTED OUT OF BAND EMISSION MEASUREMENT

Below -20dB of the highest emission level of operating band (in 100KHz RBW).

4.8.2 TEST INSTRUMENTS

Refer to section 4.1.2 to get information of above instrument.

4.8.3 TEST PROCEDURE

The transmitter output was connected to the spectrum analyzer via a low lose cable. Set both RBW and VBW of spectrum analyzer to 100 kHz with suitable frequency span including 100 MHz bandwidth from band edge. The band edges was measured and recorded.

4.8.4 DEVIATION FROM TEST STANDARD

No deviation.

4.8.5 EUT OPERATING CONDITION

The software provided by client enabled the EUT to transmit and receive data at lowest, middle and highest channel frequencies individually.

4.8.6 TEST RESULTS

The spectrum plots are attached on the following images. D1 line indicates the highest level, D2 line indicates the 20dB offset below D1. It shows compliance with the requirement.



A D T

GFSK

Hopping disabled_Low Channel

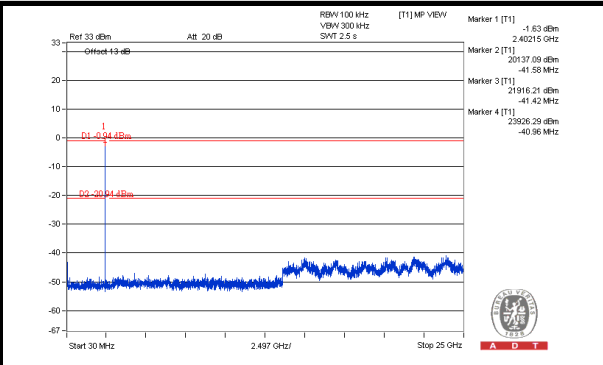
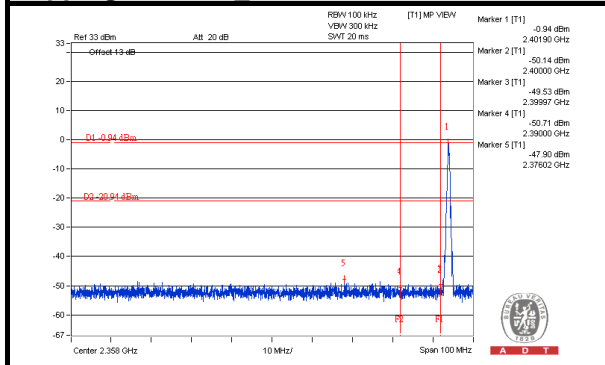

Hopping disabled_High Channel

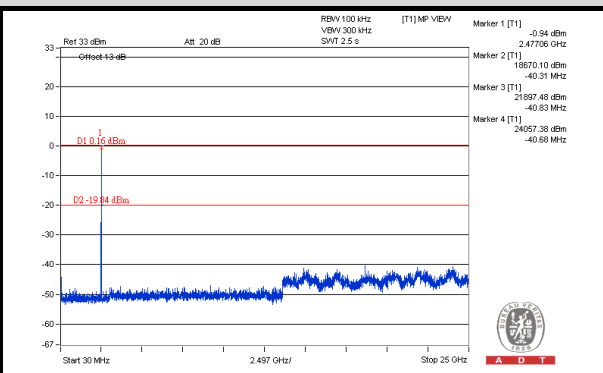
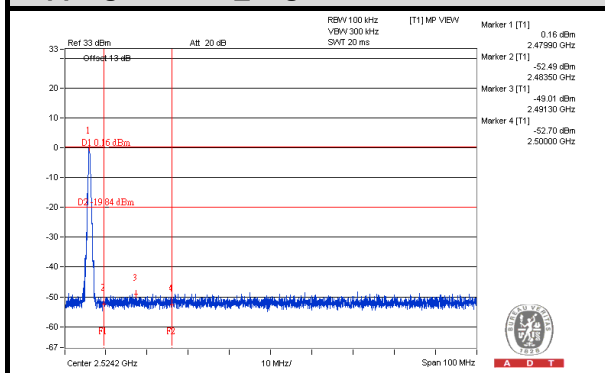

Hopping enabled_Low Channel

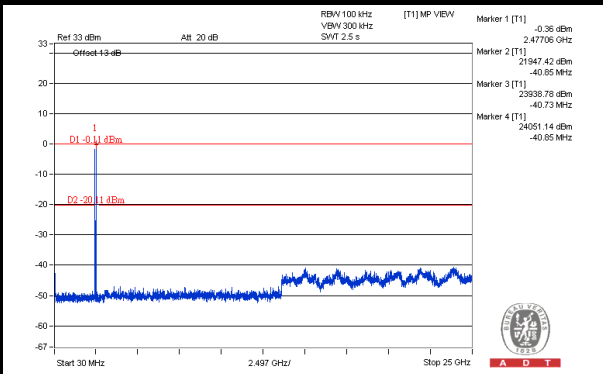
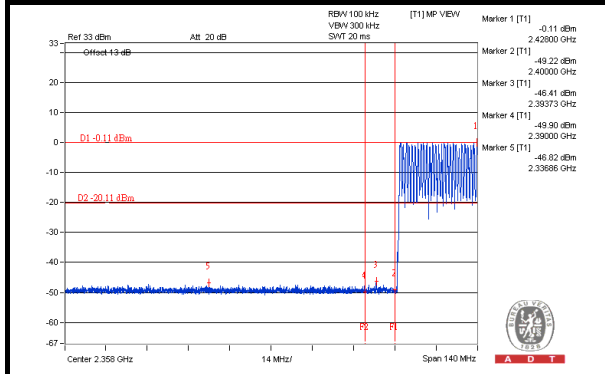

Hopping enabled_High Channel

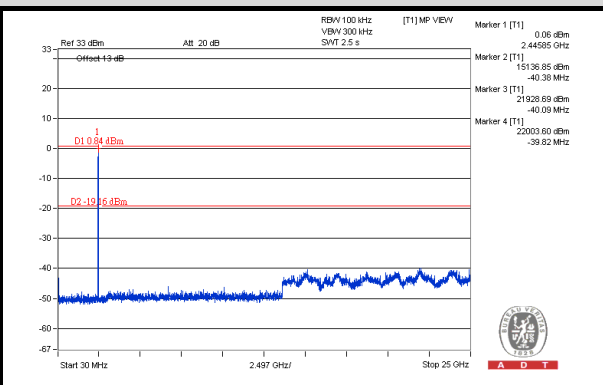
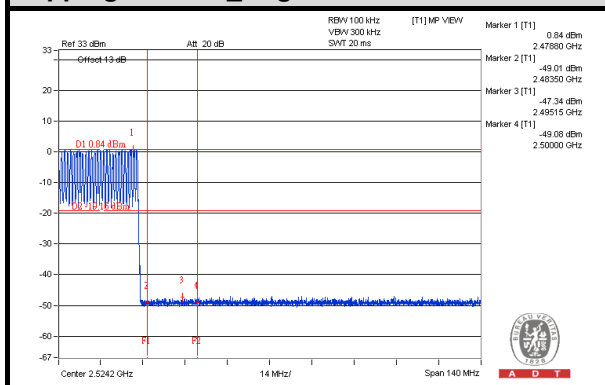



A D T

8DPSK

Hopping disabled_Low Channel

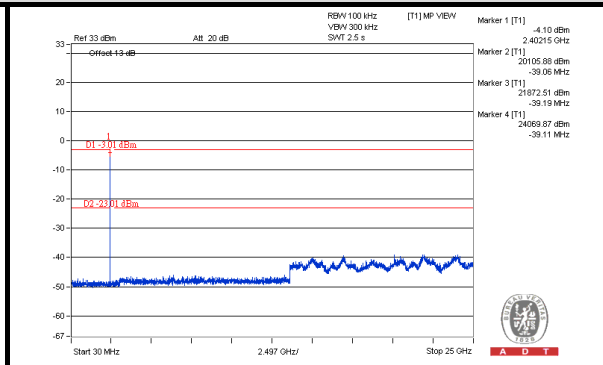
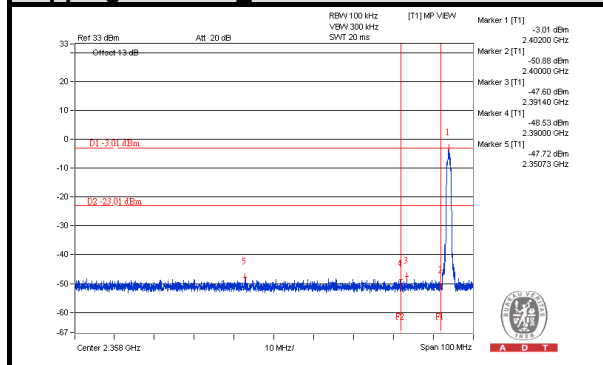

Hopping disabled_High Channel

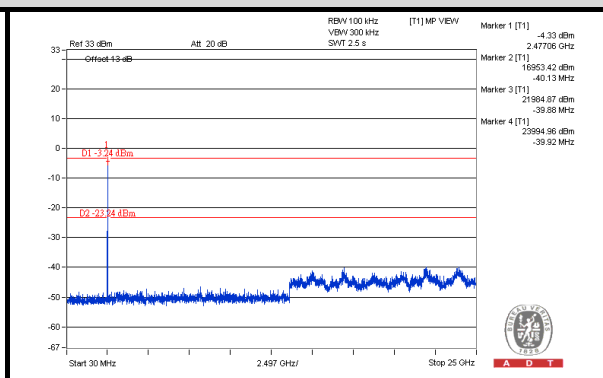
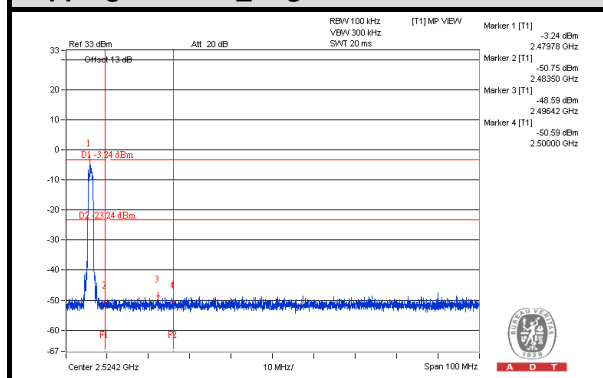

Hopping enabled_Low Channel

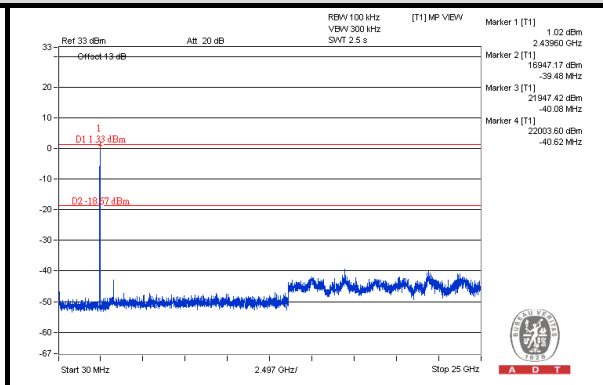
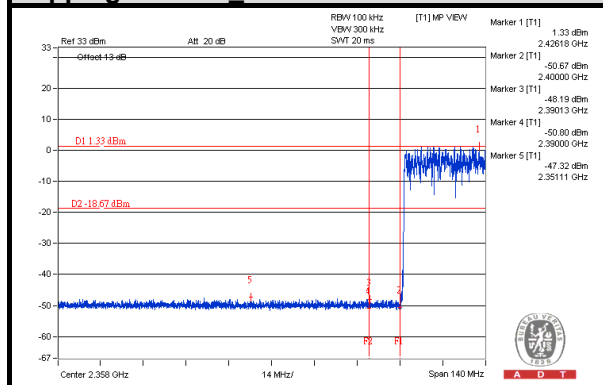

Hopping enabled_High Channel

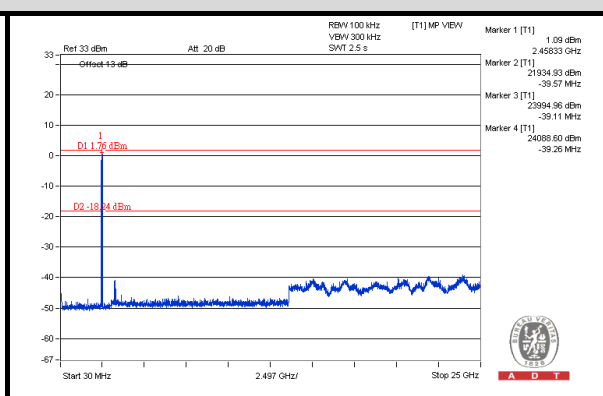
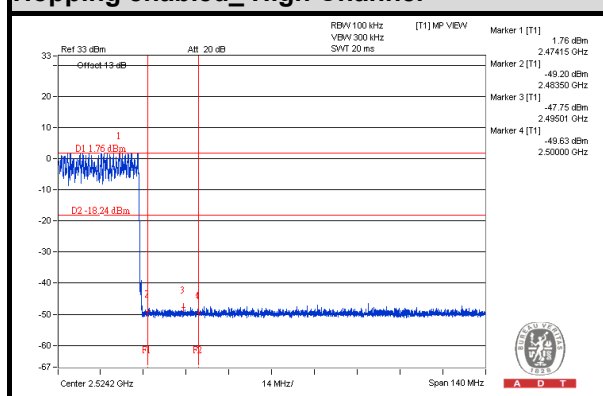



A D T

5. PHOTOGRAPHS OF THE TEST CONFIGURATION

Please refer to the attached file (Test Setup Photo).



6. INFORMATION ON THE TESTING LABORATORIES

We, Bureau Veritas Consumer Products Services (H.K.) Ltd., Taoyuan Branch, were founded in 1988 to provide our best service in EMC, Radio, Telecom and Safety consultation. Our laboratories are accredited and approved according to ISO/IEC 17025.

If you have any comments, please feel free to contact us at the following:

Linko EMC/RF Lab:

Tel: 886-2-26052180

Fax: 886-2-26051924

Hsin Chu EMC/RF Lab:

Tel: 886-3-5935343

Fax: 886-3-5935342

Hwa Ya EMC/RF/Safety Telecom Lab:

Tel: 886-3-3183232

Fax: 886-3-3270892

Email: service.adt@tw.bureauveritas.com

Web Site: www.bureauveritas-adt.com

The address and road map of all our labs can be found in our web site also.



A D T

7. APPENDIX A - MODIFICATIONS RECORDERS FOR ENGINEERING CHANGES TO THE EUT BY THE LAB

No any modifications are made to the EUT by the lab during the test.

--- END ---