

TEST REPORT



DT&C Co., Ltd.

42, Yurim-ro, 154Beon-gil, Cheoin-gu, Yongin-si, Gyeonggi-do, Korea, 17042
Tel : 031-321-2664, Fax : 031-321-1664

1. Report No : DRTFCC2201-0039(1)

2. Customer

- Name (FCC) : Janam Technologies LLC / Name (IC) : JANAM TECHNOLOGIES LLC
- Address (FCC) : 100 Crossways Park West Suite 105, Woodbury New York United States 11797
Address (IC) : 100 Crossways Park West Suite 105 Woodbury NY 11797 United States Of America
(Excluding The States Of Alaska)

3. Use of Report : FCC & IC Certification

4. Product Name / Model Name : Mobile Computer / XM75P
FCC ID : UTWXM75P
IC : 6914A-XM75P

5. FCC Regulation(s) : Part 2, 22, 24, 27

IC Standard(s) : RSS-Gen Issue 5, 130 Issue 2, 132 Issue 3, 133 Issue 6, 199 Issue 3
Test Method Used : KDB971168 D01v03, ANSI/TIA-603-E-2016, ANSI C63.26-2015

6. Date of Test : 2021.12.13 ~ 2022.01.07

7. Location of Test : Permanent Testing Lab On Site Testing

8. Testing Environment : See appended test report.

9. Test Result : Refer to the attached test result.

The results shown in this test report refer only to the sample(s) tested unless otherwise stated.

This test report is not related to KOLAS accreditation.

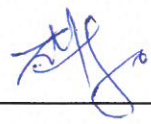
Affirmation	Tested by	Reviewed by
	Name : JaeHyeok Bang  (Signature)	Name : JaeJin Lee  (Signature)

2022 . 02 . 08 .

DT&C Co., Ltd.

If this report is required to confirmation of authenticity, please contact to report@dtnc.net

Test Report Version

Test Report No.	Date	Description	Revised by	Reviewed by
DRTFCC2201-0039	Jan. 27, 2022	Initial issue	JaeHyeok Bang	JaeJin Lee
DRTFCC2201-0039(1)	Feb. 08, 2022	Revised section 1	JaeHyeok Bang	JaeJin Lee

Table of Contents

1. GENERAL INFORMATION	5
2. INTRODUCTION	7
2.1. EUT DESCRIPTION	7
2.2. TESTING ENVIRONMENT	7
2.3. MEASURING INSTRUMENT CALIBRATION.....	7
2.4. MEASUREMENT UNCERTAINTY	7
2.5. TEST FACILITY	7
3. DESCRIPTION OF TESTS.....	8
3.1. ERP & EIRP (Effective Radiated Power & Equivalent Isotropic Radiated Power)	8
3.2. PEAK TO AVERAGE RATIO	10
3.3. OCCUPIED BANDWIDTH.....	11
3.4. BAND EDGE EMISSIONS AT ANTENNA TERMINAL	12
3.5. SPURIOUS AND HARMONIC EMISSIONS AT ANTENNA TERMINAL	13
3.6. UNDESIRABLE EMISSIONS	14
3.7. FREQUENCY STABILITY	15
4. LIST OF TEST EQUIPMENT	16
5. SUMMARY OF TEST RESULTS.....	17
6. SAMPLE CALCULATION	18
7. TEST DATA.....	20
7.1. OCCUPIED BANDWIDTH.....	20
7.2. PEAK TO AVERAGE RATIO	20
7.3. BAND EDEG EMISSIONS (Conducted).....	20
7.4. SPURIOUS AND HARMONICS EMISSIONS (Conducted)	20
7.5. ERP & EIRP	21
7.5.1. LTE Band 12.....	21
7.5.2. LTE Band 17.....	22
7.5.3. LTE Band 5.....	23
7.5.4. LTE Band 25(2)	24
7.5.5. LTE Band 41.....	25
7.5.6. LTE Band 7.....	26
7.6. UNDESIRABLE EMISSIONS (Radiated).....	27
7.6.1. LTE Band 12.....	27
7.6.2. LTE Band 17.....	28
7.6.3. LTE Band 25(2)	29
7.6.4. LTE Band 5.....	30
7.6.5. LTE Band 41.....	31
7.6.6. LTE Band 7.....	32
7.7. FREQUENCY STABILITY	33
7.7.1. LTE Band 12.....	33
7.7.2. LTE Band 17.....	34
7.7.3. LTE Band 5.....	35
7.7.4. LTE Band 25(2)	36

7.7.5. LTE Band 41.....	37
7.7.6. LTE Band 7.....	38
8. TEST PLOTS	39
8.1. OCCUPIED BANDWIDTH.....	39
8.1.1. LTE Band 12.....	39
8.1.2. LTE Band 17.....	43
8.1.3. LTE Band 5.....	45
8.1.4. LTE Band 25(2)	49
8.1.5. LTE Band 41.....	55
8.1.6. LTE Band 7.....	59
8.2. PEAK TO AVERAGE RATIO.....	63
8.2.1. LTE Band 12.....	63
8.2.2. LTE Band 17.....	67
8.2.3. LTE Band 5.....	69
8.2.4. LTE Band 25(2)	73
8.2.5. LTE Band 41.....	79
8.2.6. LTE Band 7.....	83
8.3. BAND EDGE EMISSIONS(Conducted).....	87
8.3.1. LTE Band 12.....	87
8.3.2. LTE Band 17.....	95
8.3.3. LTE Band 5.....	99
8.3.4. LTE Band 25(2)	107
8.3.5. LTE Band 41.....	119
8.3.6. LTE Band 7.....	125
8.4. SPURIOUS AND HARMONICS EMISSIONS(Conducted)	131
8.4.1. LTE Band 12.....	131
8.4.2. LTE Band 17.....	138
8.4.3. LTE Band 5.....	141
8.4.4. LTE Band 25(2)	147
8.4.5. LTE Band 41.....	165
8.4.6. LTE Band 7.....	177

1. GENERAL INFORMATION

FCC Classification	PCS Licensed Transmitter held to ear (PCE)
FCC ID	UTWXM75P
IC	6914A-XM75P
Product Name	Mobile Computer
Model Name	XM75P
Add Model Name	-
FVIN(Firmware Version Identification Number)	67.00xx
EUT Serial Number	2129310621 (Radiated), 2114810652 (Conducted)
Supplying power	DC 3.85 V
Antenna Information	Antenna Type: LDS Antenna Gain: 0.12 dBi (Band 12,17), -0.84 dBi (Band 5), 1.97 dBi (Band 25, 2), 1.21 dBi (Band 7, 41)

Mode	TX Frequency (MHz)	Emission Designator	Modulation	ERP(FCC&IC)		EIRP	
				Max power (dBm)	Max power (W)	Max power (dBm)	Max power (W)
LTE Band 12	704 ~ 711	8M92G7D	QPSK	19.18	0.083	-	-
LTE Band 12	704 ~ 711	8M90W7D	16QAM	18.15	0.065	-	-
LTE Band 12	701.5 ~ 713.5	4M47G7D	QPSK	19.62	0.092	-	-
LTE Band 12	701.5 ~ 713.5	4M47W7D	16QAM	17.98	0.063	-	-
LTE Band 12	700.5 ~ 714.5	2M69G7D	QPSK	19.43	0.088	-	-
LTE Band 12	700.5 ~ 714.5	2M68W7D	16QAM	18.08	0.064	-	-
LTE Band 12	699.7 ~ 715.3	1M08G7D	QPSK	19.21	0.083	-	-
LTE Band 12	699.7 ~ 715.3	1M08W7D	16QAM	18.38	0.069	-	-

Mode	TX Frequency (MHz)	Emission Designator	Modulation	ERP(FCC&IC)		EIRP	
				Max power (dBm)	Max power (W)	Max power (dBm)	Max power (W)
LTE Band 17	709 ~ 711	8M93G7D	QPSK	21.10	0.129	-	-
LTE Band 17	709 ~ 711	8M92W7D	16QAM	20.25	0.106	-	-
LTE Band 17	706.5 ~ 713.5	4M46G7D	QPSK	21.84	0.153	-	-
LTE Band 17	706.5 ~ 713.5	4M47W7D	16QAM	19.93	0.098	-	-

Mode	TX Frequency (MHz)	Emission Designator	Modulation	ERP(For FCC)		EIRP(For IC)	
				Max power (dBm)	Max power (W)	Max power (dBm)	Max power (W)
LTE Band 5	829 ~ 844	8M92G7D	QPSK	19.94	0.099	22.09	0.162
LTE Band 5	829 ~ 844	8M93W7D	16QAM	18.43	0.070	20.58	0.114
LTE Band 5	826.5 ~ 846.5	4M47G7D	QPSK	19.74	0.094	21.89	0.155
LTE Band 5	826.5 ~ 846.5	4M47W7D	16QAM	18.63	0.073	20.78	0.120
LTE Band 5	825.5 ~ 847.5	2M69G7D	QPSK	19.68	0.093	21.83	0.152
LTE Band 5	825.5 ~ 847.5	2M69W7D	16QAM	18.26	0.067	20.41	0.110
LTE Band 5	824.7 ~ 848.3	1M08G7D	QPSK	19.86	0.097	22.01	0.159
LTE Band 5	824.7 ~ 848.3	1M08W7D	16QAM	18.33	0.068	20.48	0.112

Mode	TX Frequency (MHz)	Emission Designator	Modulation	EIRP(FCC & IC)	
				Max power(dBm)	Max power(W)
LTE Band 25(2)	1 860 ~ 1 905	17M9G7D	QPSK	27.37	0.546
LTE Band 25(2)	1 860 ~ 1 905	17M8W7D	16QAM	25.81	0.381
LTE Band 25(2)	1 857.5 ~ 1 907.5	13M4G7D	QPSK	27.56	0.570
LTE Band 25(2)	1 857.5 ~ 1 907.5	13M4W7D	16QAM	26.32	0.429
LTE Band 25(2)	1 855 ~ 1 910	8M93G7D	QPSK	27.26	0.532
LTE Band 25(2)	1 855 ~ 1 910	8M93W7D	16QAM	26.16	0.413
LTE Band 25(2)	1 852.5 ~ 1 912.5	4M48G7D	QPSK	27.74	0.594
LTE Band 25(2)	1 852.5 ~ 1 912.5	4M47W7D	16QAM	26.42	0.439
LTE Band 25(2)	1 851.5 ~ 1 913.5	2M69G7D	QPSK	27.80	0.603
LTE Band 25(2)	1 851.5 ~ 1 913.5	2M68W7D	16QAM	26.69	0.467
LTE Band 25(2)	1 850.7 ~ 1 914.3	1M08G7D	QPSK	27.47	0.558
LTE Band 25(2)	1 850.7 ~ 1 914.3	1M08W7D	16QAM	25.94	0.393

Mode	TX Frequency (MHz)	Emission Designator	Modulation	EIRP(FCC & IC)	
				Max power(dBm)	Max power(W)
LTE Band 7	2 510 ~ 2 560	17M8G7D	QPSK	22.95	0.197
LTE Band 7	2 510 ~ 2 560	17M8W7D	16QAM	21.82	0.152
LTE Band 7	2 507.5 ~ 2 562.5	13M4G7D	QPSK	23.04	0.201
LTE Band 7	2 507.5 ~ 2 562.5	13M4W7D	16QAM	21.69	0.148
LTE Band 7	2 505 ~ 2 565	8M92G7D	QPSK	23.17	0.207
LTE Band 7	2 505 ~ 2 565	8M91W7D	16QAM	21.10	0.129
LTE Band 7	2 502.5 ~ 2 567.5	4M47G7D	QPSK	23.15	0.207
LTE Band 7	2 502.5 ~ 2 567.5	4M46W7D	16QAM	21.43	0.139

Mode	TX Frequency (MHz)	Emission Designator	Modulation	EIRP(FCC & IC)	
				Max power(dBm)	Max power(W)
LTE Band 41	2 506 ~ 2 680	17M8G7D	QPSK	22.86	0.193
LTE Band 41	2 506 ~ 2 680	17M8W7D	16QAM	21.98	0.158
LTE Band 41	2 503.5 ~ 2 682.5	13M4G7D	QPSK	23.29	0.213
LTE Band 41	2 503.5 ~ 2 682.5	13M4W7D	16QAM	22.34	0.171
LTE Band 41	2 501 ~ 2 685	8M91G7D	QPSK	23.54	0.226
LTE Band 41	2 501 ~ 2 685	8M93W7D	16QAM	22.47	0.177
LTE Band 41	2 498.5 ~ 2 687.5	4M47G7D	QPSK	23.21	0.209
LTE Band 41	2 498.5 ~ 2 687.5	4M47W7D	16QAM	22.23	0.167

2. INTRODUCTION

2.1. EUT DESCRIPTION

The Equipment Under Test (EUT) supports 850/1900 WCDMA, Multi-band LTE, 802.11b/g/n/ac WLAN(2.4GHz), 802.11a/n/ac WLAN(5GHz), Bluetooth(BDR, EDR, LE) and NFC.

2.2. TESTING ENVIRONMENT

Ambient Condition	
▪ Temperature	+21 °C ~ +25 °C
▪ Relative Humidity	42 % ~ 45 %

2.3. MEASURING INSTRUMENT CALIBRATION

The measuring equipment, which was utilized in performing the tests documented herein, has been calibrated in accordance with the manufacturer's recommendations for utilizing calibration equipment, which is traceable to recognized national standards.

2.4. MEASUREMENT UNCERTAINTY

The measurement uncertainties shown below were calculated in accordance with requirements of ANSI C 63.4-2014. All measurement uncertainty values are shown with a coverage factor of $k = 2$ to indicate a 95 % level of confidence.

Parameter	Measurement uncertainty
Radiated Disturbance (Below 1 GHz)	4.9 dB (The confidence level is about 95 %, $k = 2$)
Radiated Disturbance (1 GHz ~ 18 GHz)	5.0 dB (The confidence level is about 95 %, $k = 2$)
Radiated Disturbance (Above 18 GHz)	5.3 dB (The confidence level is about 95 %, $k = 2$)

2.5. TEST FACILITY

DT&C Co., Ltd.		
The 3 m test site and conducted measurement facility used to collect the radiated data are located at the 42, Yurim-ro, 154beon-gil, Cheoin-gu, Yongin-si, Gyeonggi-do, Korea 17042.		
The test site complies with the requirements of Part 2.948 according to ANSI C63.4-2014.		
- FCC & IC MRA Designation No. : KR0034		
- ISED#: 5740A		
www.dtnet.net		
Telephone	:	+ 82-31-321-2664
FAX	:	+ 82-31-321-1664

3. DESCRIPTION OF TESTS

3.1. ERP & EIRP (Effective Radiated Power & Equivalent Isotropic Radiated Power)

Test Set-up

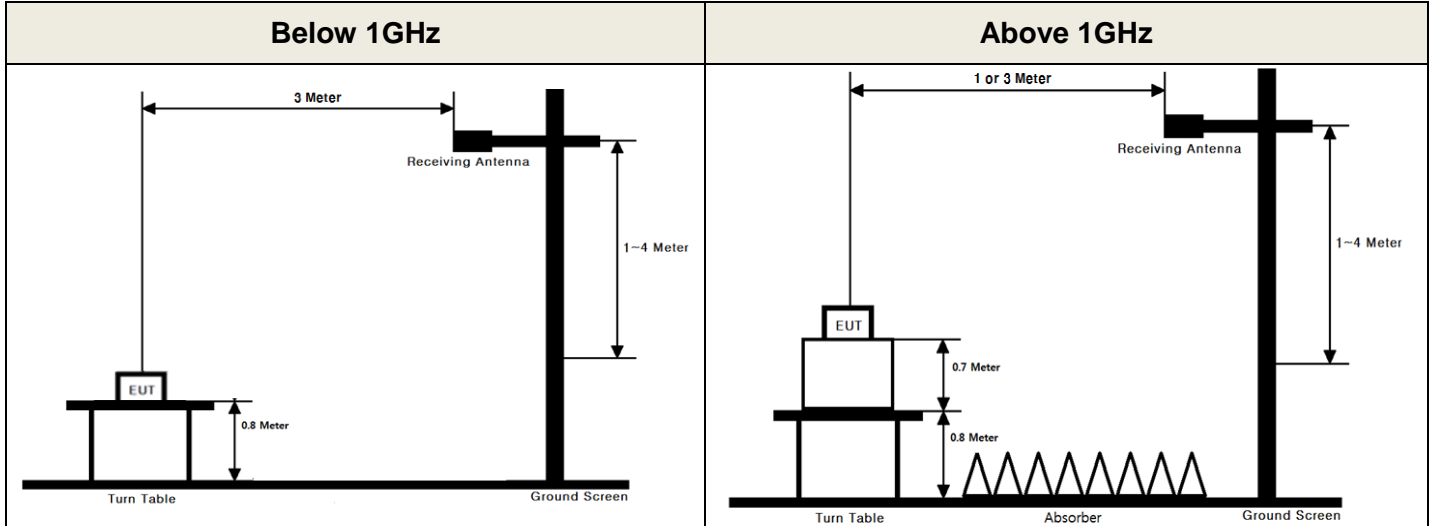

These measurements were performed at 3 m test site. The equipment under test is placed on a non-conductive table 0.8 or 1.5-meters above a turntable which is flush with the ground plane and 3 meters from the receive antenna. For measurements above 1GHz absorbers are placed on the floor between the turn table and the antenna mast in such a way so as to maximize the reduction of reflections. For measurements below 1 GHz, the absorbers are removed.

Test Procedure

- ANSI/TIA-603-E-2016 - Section 2.2.17
- KDB971168 D01v03 - Section 5.2.2
- ANSI C63.26-2015 – Section 5.2.4.4.1

Test setting

1. Set span to 2 x to 3 x the OBW.
2. Set RBW = 1 % to 5 % of the OBW.
3. Set VBW \geq 3 x RBW.
4. Set number of points in sweep \geq 2 x span / RBW.
5. Sweep time:
 - 1) Set = auto-couple, or
 - 2) Set \geq [10 \times (number of points in sweep) \times (transmission period)] for single sweep (automation-compatible) measurement. Transmission period is the on and off time of the transmitter.
6. Detector = power averaging (rms).
7. If the EUT can be configured to transmit continuously, then set the trigger to free run.
8. If the EUT cannot be configured to transmit continuously, then use a sweep trigger with the level set to enable triggering only on full power bursts and configure the EUT to transmit at full power for the entire duration of each sweep. Verify that the sweep time is less than or equal to the transmission burst duration. Time gating can also be used under similar constraints (i.e., configured such that measurement data is collected only during active full-power transmissions).
9. Trace average at least 100 traces in power averaging (rms) mode if sweep is set to auto-couple. To accurately determine the average power over multiple symbols, it can be necessary to increase the number of traces to be averaged above 100 or, if using a manually configured sweep time, increase the sweep time.

10. Compute the power by integrating the spectrum across the OBW of the signal using the instrument's band or channel power measurement function, with the band/channel limits set equal to the OBW band edges. If the instrument does not have a band or channel power function, then sum the spectrum levels (in linear power units) at intervals equal to the RBW extending across the entire OBW of the spectrum.

The receiver antenna height and turntable rotations were adjusted for the highest reading on the receive spectrum analyzer.

A half-wave dipole was substituted in place of the EUT. This dipole antenna was driven by a signal generator and the level of the signal generator was adjusted to obtain the same receive spectrum analyzer reading. The conducted power at the terminal of the substitute antenna is measured.

The ERP/EIRP is calculated using the following formula:

ERP/EIRP = The conducted power at the substitute antenna's terminal [dBm] + Substitute Antenna gain [dBd for ERP , dBi for EIRP]

For readings above 1 GHz, the above procedure is repeated using horn antennas and the difference between the gain of the horn antenna and an isotropic antenna are taken into consideration.

3.2. PEAK TO AVERAGE RATIO

Test set-up

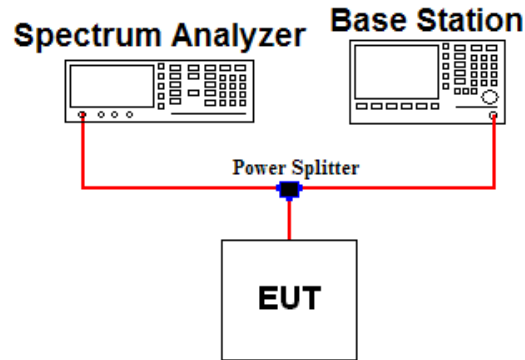

Test Procedure

- KDB971168 D01v03 - Section 5.7.2
- ANSI C63.26-2015 – Section 5.2.3.4

A peak to average ratio measurement is performed at the conducted port of the EUT.

The spectrum analyzers Complementary Cumulative Distribution Function (CCDF) measurement profile is used to determine the largest deviation between the average and the peak power of the EUT in a given bandwidth. The CCDF curve shows how much time the peak waveform spends at or above a given average power level. The present of time the signal spends at or above the level defines the probability for that particular power level.

Test setting

The spectrum Analyzer`s CCDF measurement function is enabled.

1. Set resolution/measurement bandwidth \geq OBW or specified reference bandwidth.
2. Set the number of counts to a value that stabilizes the measured CCDF curve.
3. Set the measurement interval as follows:
 - 1) For continuous transmissions, set to the greater of $[10 \times (\text{number of points in sweep}) \times (\text{transmission symbol period})]$ or 1 ms.
 - 2) For burst transmissions, employ an external trigger that is synchronized with the EUT burst timing sequence, or use the internal burst trigger with a trigger level that allows the burst to stabilize. Set the measurement interval to a time that is less than or equal to the burst duration.
 - 3) If there are several carriers in a single antenna port, the peak power shall be determined for each individual carrier (by disabling the other carriers while measuring the required carrier) and the total peak power calculated from the sum of the individual carrier peak powers.
4. Record the maximum PAPR level associated with a probability of 0.1 %.
5. The peak power level is calculated form the sum of the PAPR value from step d) to the measured average power.

3.3. OCCUPIED BANDWIDTH.

Test set-up

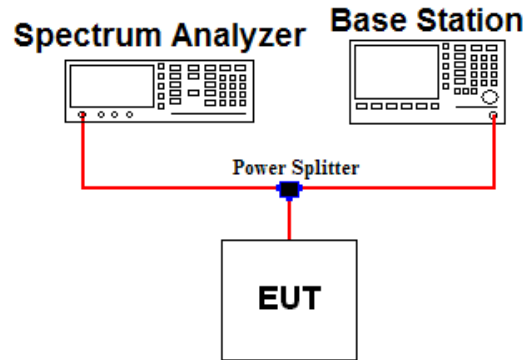

Test Procedure

- KDB971168 D01v03 - Section 4.3
- ANSI C63.26-2015 – Section 5.4.4

The occupied bandwidth, that is the frequency bandwidth such that, below its lower and above its upper frequency limits, the mean powers radiated are each equal to 0.5 percent of the total mean power of a given emission.

Test setting

1. The signal analyzer's automatic bandwidth measurement capability was used to perform the 99 % occupied bandwidth and the 26 dB bandwidth. The bandwidth measurement was not influenced by any intermediate power nulls in the fundamental emission.
2. $RBW = 1 \% \sim 5 \%$ of the expected OBW & $VBW \geq 3 \times RBW$
3. Detector = Peak
4. Trance mode = Max hold
5. Sweep = Auto couple
6. The trace was allowed to stabilize
7. If necessary, step 2 ~ 6 were repeated after changing the RBW such that it would be within 1 % ~ 5 % of the 99 % occupied bandwidth observed in step 6.

3.4. BAND EDGE EMISSIONS AT ANTENNA TERMINAL

Test set-up

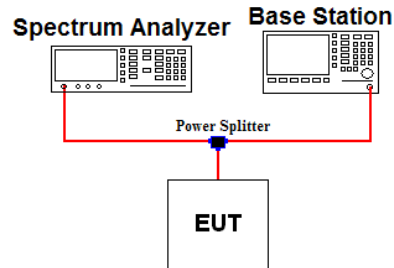

Test Procedure

- KDB971168 D01v03 - Section 6
- ANSI C63.26-2015 – Section 5.7

All out of band emissions are measured by means of a calibrated spectrum analyzer. The EUT was setup to maximum output power at its lowest and highest channel with all bandwidths, modulations and RB configurations.

The power of any spurious emission shall be attenuated below the transmitter power (P) by at least $43 + 10 \log(P)$ dB.

Test setting

1. Start and stop frequency were set such that the band edge would be placed in the center of the plot
2. Span was set large enough so as to capture all out of band emissions near the band edge
3. RBW ≥ 1 % of the emission bandwidth
4. VBW $\geq 3 \times$ RBW
5. Detector = RMS & Trace mode = Max hold
6. Sweep time = Auto couple or 1 s for band edge
7. Number of sweep point $\geq 2 \times$ span / RBW
8. The trace was allowed to stabilize

Note 1: Per Part 22.917(b)(1) / 24.238(b) / in the 1 MHz bands immediately outside and adjacent to the frequency block a resolution bandwidth of at least one percent of the emission bandwidth of the fundamental emission of the transmitter may be employed to demonstrate compliance with the out-of-band emissions limit.

The emission bandwidth is defined as the width of the signal between two points, one below the carrier center frequency and one above the carrier center frequency, outside of which all emission are attenuated at least 26 dB below the transmitter power.

Note 2: Per Part 27.53(g) for operations in the 600 MHz band and the 698-746 MHz band, compliance with this provision is based on the use of measurement instrumentation employing a resolution bandwidth of 100 kilohertz or greater. However, in the 100 kilohertz bands immediately outside and adjacent to a licensee's frequency block, a resolution bandwidth of at least 30 kHz may be employed.

Note 3: For part 27.53(m)(4) the attenuation factor shall be not less than $40 + 10 \log(P)$ dB on all frequencies between the channel edge and 5 megahertz from the channel edge, $43 + 10 \log(P)$ dB on all frequencies between 5 megahertz and X megahertz from the channel edge, and $55 + 10 \log(P)$ dB on all frequencies more than X megahertz from the channel edge, where X is the greater of 6 megahertz or the actual emission bandwidth as defined in paragraph (m)(6) of this section. In addition, the attenuation factor shall not be less than $43 + 10 \log(P)$ dB on all frequencies between 2 490.5 MHz and 2 496 MHz and $55 + 10 \log(P)$ dB at or below 2 490.5 MHz.

Note 4: Per part 27.53(m)(6) in the 1 MHz bands immediately outside and adjacent to the frequency block a resolution bandwidth of at least two percent may be employed, except when the 1 MHz band is 2 495 MHz - 2 496 MHz, in which case a resolution bandwidth of at least one percent may be employed.

3.5. SPURIOUS AND HARMONIC EMISSIONS AT ANTENNA TERMINAL

Test set-up

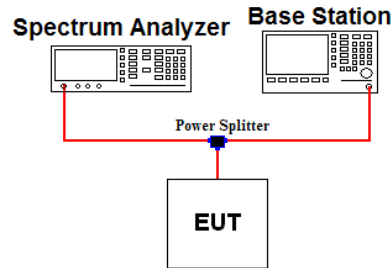

Test Procedure

- KDB971168 D01v03 - Section 6
- ANSI C63.26-2015 – Section 5.7

The level of the carrier and the various conducted spurious and harmonic frequencies is measured by means of a calibrated spectrum analyzer. The EUT was setup to maximum output power at its low, middle, high channel with all bandwidths, modulations and RB configurations. The spectrum is scanned from 9 kHz up to a frequency including its 10th harmonic.

The power of any spurious emission shall be attenuated below the transmitter power (P) by at least $43 + 10 \log(P)$ dB.

Test setting

1. RBW = 100 kHz(Below 1 GHz) or 1 MHz(Above 1 GHz) & VBW $\geq 3 \times$ RBW (Refer to Note 1)
2. Detector = RMS & Trace mode = Max hold
3. Sweep time = Auto couple
4. Number of sweep point $\geq 2 \times$ span / RBW
5. The trace was allowed to stabilize

Note 1: Compliance with these provisions is based on the use of measurement instrumentation employing a resolution bandwidth of 100 kHz or greater for frequencies less than 1 GHz and 1 MHz or greater for frequencies greater than 1GHz.

3.6. UNDESIRABLE EMISSIONS

Test Set-up

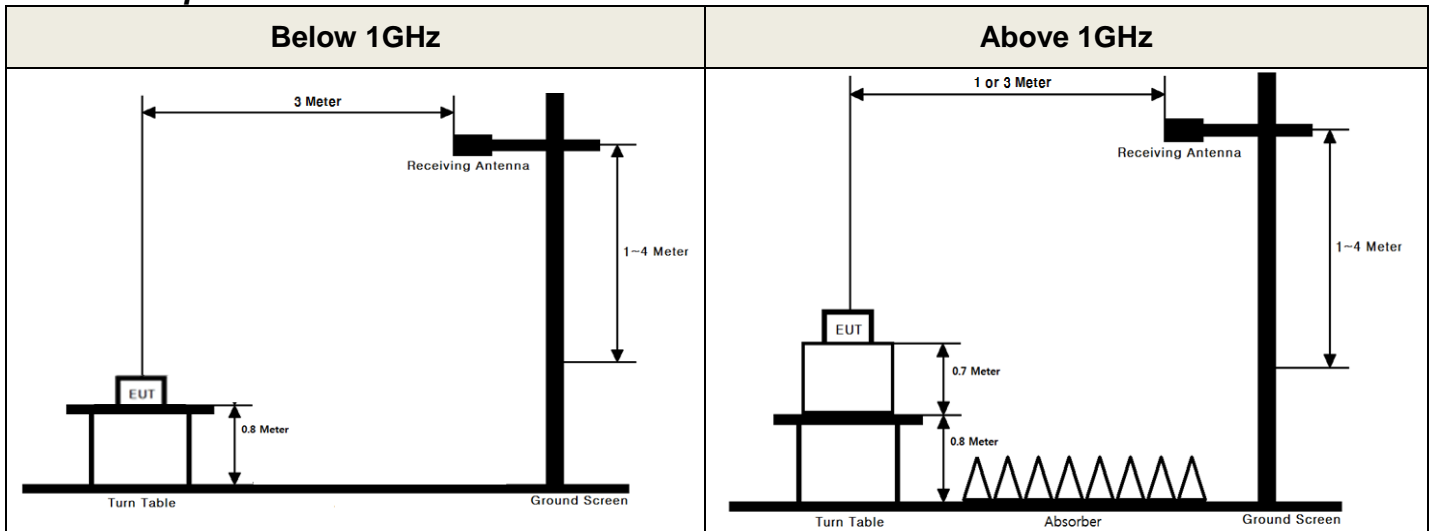

These measurements were performed at 3 test site. The equipment under test is placed on a non-conductive table 0.8 or 1.5 meters above a turntable which is flush with the ground plane and 3 meters from the receive antenna. For measurements above 1 GHz absorbers are placed on the floor between the turn table and the antenna mast in such a way so as to maximize the reduction of reflections. For measurements below 1 GHz, the absorbers are removed.

Test Procedure

- ANSI/TIA-603-E-2016 - Section 2.2.12
- KDB971168 D01v03 - Section 5.8
- ANSI C63.26-2015 – Section 5.5

Test setting

1. RBW = 100 kHz for below 1 GHz and 1 MHz for above 1 GHz / VBW \geq 3 X RBW
2. Detector = RMS & Trace mode = Max hold
3. Sweep time = Auto couple
4. Number of sweep point \geq 2 X span / RBW
5. The trace was allowed to stabilize

The receive antenna height and turntable rotations were adjusted for the highest reading on the receive spectrum analyzer. For radiated power measurements below 1 GHz, a half-wave dipole was substituted in place of the EUT. This dipole antenna was driven by a signal generator and the level of the signal generator was adjusted to obtain the same spectrum analyzer reading.

For radiated power measurements above 1 GHz, a Horn antenna was substituted in place of the EUT. This Horn antenna was driven by a signal generator and the level of the signal generator was adjusted to obtain the same spectrum analyzer reading. The difference between the gain of the horn and an isotropic antenna are taken into consideration.

This measurement was performed with the EUT oriented in 3 orthogonal axis.

3.7. FREQUENCY STABILITY

Test Set-up

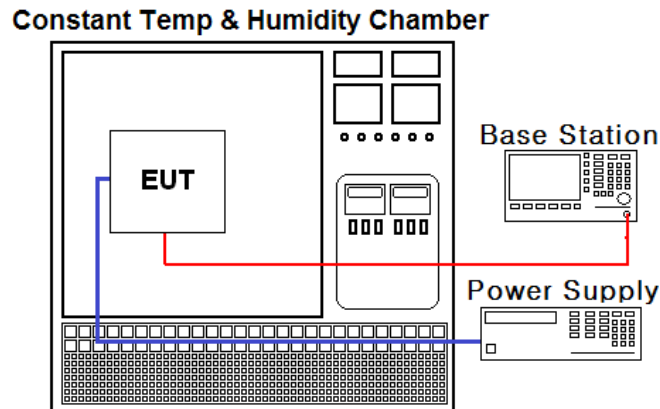

Test Procedure

- ANSI/TIA-603-E-2016
- KDB971168 D01v03 - Section 9

The frequency stability of the transmitter is measured by:

a.) **Temperature:**

The temperature is varied from -30 °C to +50 °C using an environmental chamber.

b.) **Primary Supply Voltage:**

The primary supply voltage is varied from 85 % to 115 % of the nominal value for non hand-carried battery and AC powered equipment. For hand-carried, battery-powered equipment, primary supply voltage is reduced to the battery operating end point which shall be specified by the manufacturer.

Specification:

The frequency stability shall be sufficient to ensure that the fundamental emission stays within the authorized frequency block for Part 24, 27, 90. The frequency stability of the transmitter shall be maintained within $\pm 0.00025\%$ (± 2.5 ppm) of the center frequency for Part 22.

Time Period and Procedure:

1. The carrier frequency of the transmitter is measured at room temperature.
(20 °C to provide a reference)
2. The equipment is turned on in a "standby" condition for one minute before applying power to the transmitter. Measurement of the carrier frequency of the transmitter is made within one minute after applying power to the transmitter.
3. Frequency measurements are made at 10 °C intervals ranging from -30 °C to +50 °C.
A period of at least one half-hour is provided to allow stabilization of the equipment at each temperature level.

4. LIST OF TEST EQUIPMENT

Type	Manufacturer	Model	Cal.Date (yy/mm/dd)	Next.Cal. Date (yy/mm/dd)	S/N
Spectrum Analyzer	Agilent Technologies	N9020A	21/06/24	22/06/24	MY50200867
Spectrum Analyzer	Agilent Technologies	N9030A	20/12/16 21/12/16	21/12/16 22/12/16	MY53310140
Spectrum Analyzer	Agilent Technologies	N9020A	21/06/24	22/06/24	US47360812
DC power supply	Agilent Technologies	66332A	21/06/24	22/06/24	US37474125
Multimeter	FLUKE	17B+	20/12/16 21/12/16	21/12/16 22/12/16	36390701WS
Power Splitter	Anritsu	K241B	21/06/24	22/06/24	1701102
Temp & Humi	SJ Science	SJ-TH-S50	21/06/22	22/06/22	SJ-TH-S50-130930
Radio Communication Analyzer	Anritsu	MT8820C	21/06/24	22/06/24	6200951873
Thermohygrometer	BODYCOM	BJ5478	20/12/16 21/12/16	21/12/16 22/12/16	120612-2
Thermohygrometer	XIAOMI	MHO-C201	20/12/16 21/12/16	21/12/16 22/12/16	00089675
Signal Generator	Rohde Schwarz	SMBV100A	20/12/16 21/12/16	21/12/16 22/12/16	255571
Signal Generator	ANRITSU	MG3695C	20/12/16 21/12/16	21/12/16 22/12/16	173501
Loop Antenna	ETS-Lindgren	6502	21/01/28	23/01/28	00226186
Bilog Antenna	Schwarzbeck	VULB 9160	20/12/16 21/12/16	21/12/16 22/12/16	3362
Dipole Antenna	A.H.Systems Inc.	FCC-4	20/12/16	22/12/16	710A
Dipole Antenna	Schwarzbeck	UHA9105	20/04/10	22/04/10	2262
HORN ANT	ETS	3117	20/12/16 21/12/16	21/12/16 22/12/16	00140394
HORN ANT	ETS	3117	21/06/24	22/06/24	00143278
HORN ANT	A.H.Systems	SAS-574	21/06/24	22/06/24	154
HORN ANT	A.H.Systems	SAS-574	21/06/24	22/06/24	155
Amplifier	EMPOWER	BBS3Q7ELU	21/06/24	22/06/24	1020
PreAmplifier	H.P	8447D	20/12/16 21/12/16	21/12/16 22/12/16	2944A07774
PreAmplifier	Agilent	8449B	21/06/24	22/06/24	3008A02108
PreAmplifier	A.H.Systems Inc.	PAM-1840VH	21/06/24	22/06/24	163
High-pass filter	Wainwright	WHKX12-935-1000-15000-40SS	21/06/24	22/06/24	7
High-pass filter	Wainwright	WHKX10-2838-3300-18000-60SS	21/06/24	22/06/24	2
High-pass filter	Wainwright	WHKX6-6320-8000-26500-40CC	21/06/24	22/06/24	2
Cable	HUBER+SUHNER	SUCOFLEX100	21/01/08 22/01/04	22/01/08 23/01/04	M-1
Cable	HUBER+SUHNER	SUCOFLEX100	21/01/08 22/01/04	22/01/08 23/01/04	M-2
Cable	JUNFLON	MWX241/B	21/01/08 22/01/04	22/01/08 23/01/04	M-3
Cable	JUNFLON	MWX221	21/01/08 22/01/04	22/01/08 23/01/04	M-4
Cable	JUNFLON	MWX221	21/01/08 22/01/04	22/01/08 23/01/04	M-5
Cable	DTNC	Cable	21/01/08 22/01/04	22/01/08 23/01/04	M-6
Cable	JUNFLON	J12J101757-00	21/01/08 22/01/04	22/01/08 23/01/04	M-7
Cable	HUBER+SUHNER	SUCOFLEX104	21/01/08 22/01/04	22/01/08 23/01/04	M-8
Cable	HUBER+SUHNER	SUCOFLEX106	21/01/08 22/01/04	22/01/08 23/01/04	M-9

Note1: The measurement antennas were calibrated in accordance to the requirements of ANSI C63.5-2017.

Note2: The cable is not a regular calibration item, so it has been calibrated by DT & C itself.

This test report is prohibited to copy or reissue in whole or in part without the approval of DT&C Co., Ltd.

5. SUMMARY OF TEST RESULTS

FCC Part Section(s)	RSS Section(s)	Test Description	Test Limit	Test Condition	Status Note 1
2.1046	-	Conducted Output Power	N/A	Conducted	C ^{Note2}
2.1049	RSS-GEN[6.7]	Occupied Bandwidth	N/A		C
24.232(d)	RSS-130 [4.6] RSS-132 [5.4] RSS-133 [6.4] RSS-199 [4.4]	Peak to Average Ratio	< 13 dB		C
2.1051 22.917(a) 24.238(a) 27.53(g)	RSS-130 [4.7] RSS-132 [5.5] RSS-133 [6.5]	Band Edge / Conducted Spurious Emissions	> 43 + 10log ₁₀ (P) dB at Band edge and for all out-of-band emissions		C
27.53(m)	RSS-199 [4.5]	Band Edge / Conducted Spurious Emissions	> 40 + 10log ₁₀ (P) dB at channel edge and 5 MHz from the channel edge > 43 + 10log ₁₀ (P) dB at 5 MHz and X MHz from the channel edge > 55 + 10log ₁₀ (P) dB at all frequencies more than X MHz from the channel edge		C
2.1055 22.355 24.235 27.54	RSS-130 [4.5] RSS-132 [5.3] RSS-133 [6.3] RSS-199 [4.3]	Frequency Stability	< 2.5 ppm (Part 22) or Fundamental emissions must stay within Authorized frequency block (Part 24, 27)		C
27.50(c.10)	RSS-130 [4.6]	Radiated Output Power (B12, 17)	< 3 Watts max. ERP (FCC & IC)	Radiated	C ^{Note3}
22.913(a.5)	RSS-132 [5.4]	Radiated Output Power (B5)	< 7 Watts max. ERP (FCC) < 11.5 Watts max. EIRP (IC)		C ^{Note3}
24.232(c) 27.50(h.2)	RSS-133 [6.4] RSS-199 [4.4]	Radiated Output Power (B25, 2, 7, 41)	< 2 Watts max. EIRP (FCC & IC)		C ^{Note3}
2.1053 22.917(a) 24.238(a) 27.53(g)	RSS-130 [4.7] RSS-132 [5.5] RSS-133 [6.5]	Undesirable Emissions	> 43 + 10log ₁₀ (P) dB for all out-of-band emissions		C ^{Note3}
27.53(m)	RSS-199 [4.5]	Undesirable Emissions (B7, 41)	> 55 + 10log ₁₀ (P) dB for all out-of-band emissions		C ^{Note3}
Note 1: C=Comply NC=Not Comply NT=Not Tested NA=Not Applicable Note 2: Refer to RF Exposure Report (Test Report SAR) Note 3: This test item was performed in three orthogonal EUT positions and the worst case data was reported.					

6. SAMPLE CALCULATION

A. Emission Designator

LTE Band 12(QPSK)

Emission Designator = **8M92G7D**
LTE OBW = 8.916 MHz
G = Phase Modulation
7 = Quantized/Digital Info
D = Data Transmission

LTE Band 17(QPSK)

Emission Designator = **8M93G7D**
LTE OBW = 8.933 MHz
G = Phase Modulation
7 = Quantized/Digital Info
D = Data Transmission

LTE Band 5(QPSK)

Emission Designator = **8M93G7D**
LTE OBW = 8.925 MHz
G = Phase Modulation
7 = Quantized/Digital Info
D = Data Transmission

LTE Band 25(2)(QPSK)

Emission Designator = **17M9G7D**
LTE OBW = 17.852 MHz
G = Phase Modulation
7 = Quantized/Digital Info
D = Data Transmission

LTE Band 41(QPSK)

Emission Designator = **17M8G7D**
LTE OBW = 17.841 MHz
G = Phase Modulation
7 = Quantized/Digital Info
D = Data Transmission

LTE Band 7(QPSK)

Emission Designator = **17M8G7D**
LTE OBW = 17.809 MHz
G = Phase Modulation
7 = Quantized/Digital Info
D = Data Transmission

LTE Band 12(16QAM)

Emission Designator = **8M90W7D**
LTE OBW = 8.903 MHz
W = Amplitude/Angle Modulated
7 = Quantized/Digital Info
D = Data Transmission

LTE Band 17(16QAM)

Emission Designator = **8M92W7D**
LTE OBW = 8.917 MHz
W = Amplitude/Angle Modulated
7 = Quantized/Digital Info
D = Data Transmission

LTE Band 5(16QAM)

Emission Designator = **8M93W7D**
LTE OBW = 8.930 MHz
W = Amplitude/Angle Modulated
7 = Quantized/Digital Info
D = Data Transmission

LTE Band 25(2)(16QAM)

Emission Designator = **17M8W7D**
LTE OBW = 17.830 MHz
W = Amplitude/Angle Modulated
7 = Quantized/Digital Info
D = Data Transmission

LTE Band 41(16QAM)

Emission Designator = **17M8W7D**
LTE OBW = 17.829 MHz
W = Amplitude/Angle Modulated
7 = Quantized/Digital Info
D = Data Transmission

LTE Band 7(16QAM)

Emission Designator = **17M8W7D**
LTE OBW = 17.795 MHz
W = Amplitude/Angle Modulated
7 = Quantized/Digital Info
D = Data Transmission

B. For substitution method

- 1) The EUT was placed on a turntable with 0.8 meter height for frequency below 1GHz and 1.5 meter height for frequency above 1 GHz respectively above ground.
- 2) The EUT was set 3 meters from the receiving antenna mounted on the antenna tower.
- 3) During the test, the turn table is rotated until the maximum signal is found.
- 4) Record the field strength meter's level. (ex. Spectrum reading level is -8.5 dBm)
- 5) Replace the EUT with dipole/Horn antenna that is connected to a calibrated signal generator.
- 6) Increase the signal generator output till the field strength meter's level is equal to the item (4).
(ex. Signal generator level is -18.04 dBm)
- 7) The gain of the cable and amplifier between the signal generator and terminals of substituted antenna is 46.92 dB at test frequency.
- 8) Record the level at substituted antenna terminal. (ex. 28.88dBm)
- 9) The result is calculated as below;

$$\text{EIRP(dBm)} = \text{LEVLE@ANTENNA TERMINAL} + \text{TX Antenna Gain (dBi)}$$

$$\text{ERP(dBm)} = \text{LEVLE@ANTENNA TERMINAL} + \text{TX Antenna Gain (dBd)}$$

$$\text{Where, TX Antenna Gain (dBd)} = \text{TX Antenna Gain (dBi)} - 2.15 \text{ dB}$$

7. TEST DATA

7.1. OCCUPIED BANDWIDTH

- Plots of the EUT's Occupied Bandwidth are shown in Clause 8.1

7.2. PEAK TO AVERAGE RATIO

- Plots of the EUT's Peak- to- Average Ratio are shown in Clause 8.2

7.3. BAND EDGE EMISSIONS (Conducted)

- Plots of the EUT's Band Edge Emissions are shown in Clause 8.3

7.4. SPURIOUS AND HARMONICS EMISSIONS (Conducted)

- Plots of the EUT's Spurious Emissions are shown in Clause 8.4

7.5. ERP & EIRP

- Test Notes

- 1) This device was tested under all bandwidths, modulations and RB configurations and the worst case data are reported in the below table.

7.5.1. LTE Band 12

Channel Bandwidth (MHz)	Test Frequency (MHz)	Test Mode	RB Size/ Offset	Ant Pol (H/V)	Level(dBm) @ Ant Terminal	TX Ant Gain (dBd)	ERP (dBm)	ERP (W)
10	704	QPSK	1/25	H	19.70	-0.63	19.07	0.081
		16QAM	1/25	H	18.78	-0.63	18.15	0.065
	711	QPSK	1/25	H	19.80	-0.62	19.18	0.083
		16QAM	1/25	H	18.21	-0.62	17.59	0.057
5	701.5	QPSK	1/12	H	20.25	-0.63	19.62	0.092
		16QAM	1/12	H	18.44	-0.63	17.81	0.060
	707.5	QPSK	1/12	H	19.83	-0.62	19.21	0.083
		16QAM	1/12	H	18.49	-0.62	17.87	0.061
	713.5	QPSK	1/12	H	20.12	-0.62	19.50	0.089
		16QAM	1/12	H	18.60	-0.62	17.98	0.063
3	700.5	QPSK	1/14	H	19.70	-0.63	19.07	0.081
		16QAM	1/14	H	18.22	-0.63	17.59	0.057
	707.5	QPSK	1/7	H	19.78	-0.62	19.16	0.082
		16QAM	1/7	H	18.43	-0.62	17.81	0.060
	714.5	QPSK	1/7	H	20.05	-0.62	19.43	0.088
		16QAM	1/7	H	18.70	-0.62	18.08	0.064
1.4	699.7	QPSK	1/2	H	19.62	-0.63	18.99	0.079
		16QAM	1/2	H	17.97	-0.63	17.34	0.054
	707.5	QPSK	1/5	H	19.65	-0.62	19.03	0.080
		16QAM	1/5	H	19.00	-0.62	18.38	0.069
	715.3	QPSK	1/2	H	19.83	-0.62	19.21	0.083
		16QAM	1/2	H	18.78	-0.62	18.16	0.065

7.5.2. LTE Band 17

Channel Bandwidth (MHz)	Test Frequency (MHz)	Test Mode	RB Size/ Offset	Ant Pol (H/V)	Level(dBm) @ Ant Terminal	TX Ant Gain (dBd)	ERP (dBm)	ERP (W)
10	709	QPSK	1/25	H	21.72	-0.62	21.10	0.129
		16QAM	1/25	H	20.44	-0.62	19.82	0.096
	711	QPSK	1/0	H	21.55	-0.62	20.93	0.124
		16QAM	1/0	H	20.87	-0.62	20.25	0.106
5	706.5	QPSK	1/12	H	22.46	-0.62	21.84	0.153
		16QAM	1/12	H	20.24	-0.62	19.62	0.092
	710	QPSK	1/12	H	21.51	-0.62	20.89	0.123
		16QAM	1/12	H	20.55	-0.62	19.93	0.098
	713.5	QPSK	1/12	H	21.65	-0.62	21.03	0.127
		16QAM	1/12	H	20.13	-0.62	19.51	0.089

7.5.3. LTE Band 5

Channel Bandwidth (MHz)	Test Frequency (MHz)	Test Mode	RB Size/ Offset	Ant Pol (H/V)	Level(dBm) @ Ant Terminal	TX Ant Gain (dBd)	ERP (dBm)	ERP (W)
10	829	QPSK	1/25	H	20.73	-0.79	19.94	0.099
		16QAM	1/25	H	19.22	-0.79	18.43	0.070
	836.5	QPSK	1/0	H	20.01	-0.85	19.16	0.082
		16QAM	1/0	H	19.11	-0.85	18.26	0.067
	844	QPSK	1/25	H	20.17	-0.91	19.26	0.084
		16QAM	1/25	H	19.13	-0.91	18.22	0.066
5	826.5	QPSK	1/12	H	20.52	-0.78	19.74	0.094
		16QAM	1/12	H	19.41	-0.78	18.63	0.073
	836.5	QPSK	1/0	H	19.74	-0.85	18.89	0.077
		16QAM	1/0	H	18.57	-0.85	17.72	0.059
	846.5	QPSK	1/0	H	20.20	-0.93	19.27	0.085
		16QAM	1/0	H	18.79	-0.93	17.86	0.061
3	825.5	QPSK	1/7	H	20.45	-0.77	19.68	0.093
		16QAM	1/7	H	19.03	-0.77	18.26	0.067
	836.5	QPSK	1/0	H	19.56	-0.85	18.71	0.074
		16QAM	1/0	H	18.82	-0.85	17.97	0.063
	847.5	QPSK	1/0	H	20.05	-0.94	19.11	0.081
		16QAM	1/0	H	18.81	-0.94	17.87	0.061
1.4	824.7	QPSK	1/2	H	20.62	-0.76	19.86	0.097
		16QAM	1/2	H	19.09	-0.76	18.33	0.068
	836.5	QPSK	1/0	H	19.41	-0.85	18.56	0.072
		16QAM	1/0	H	18.78	-0.85	17.93	0.062
	848.3	QPSK	1/0	H	19.75	-0.95	18.80	0.076
		16QAM	1/0	H	18.72	-0.95	17.77	0.060

7.5.4. LTE Band 25(2)

Channel Bandwidth (MHz)	Test Frequency (MHz)	Test Mode	RB Size/ Offset	Ant Pol (H/V)	Level(dBm) @ Ant Terminal	TX Ant Gain (dBi)	EIRP (dBm)	EIRP (W)
20	1 860	QPSK	1/0	V	21.95	5.02	26.97	0.498
		16QAM	1/0	V	20.79	5.02	25.81	0.381
	1 882.5	QPSK	1/0	V	21.84	4.81	26.65	0.462
		16QAM	1/0	V	20.29	4.81	25.10	0.324
	1 905	QPSK	1/0	V	22.71	4.66	27.37	0.546
		16QAM	1/0	V	21.07	4.66	25.73	0.374
15	1 857.5	QPSK	1/36	V	21.80	5.05	26.85	0.484
		16QAM	1/36	V	20.50	5.05	25.55	0.359
	1 882.5	QPSK	1/0	V	22.33	4.81	27.14	0.518
		16QAM	1/0	V	20.99	4.81	25.80	0.380
	1 907.5	QPSK	1/0	V	22.89	4.67	27.56	0.570
		16QAM	1/0	V	21.65	4.67	26.32	0.429
10	1 855	QPSK	1/0	V	21.39	5.07	26.46	0.443
		16QAM	1/0	V	20.69	5.07	25.76	0.377
	1 882.5	QPSK	1/25	V	22.45	4.81	27.26	0.532
		16QAM	1/25	V	21.19	4.81	26.00	0.398
	1 910	QPSK	1/49	V	22.55	4.68	27.23	0.528
		16QAM	1/49	V	21.48	4.68	26.16	0.413
5	1 852.5	QPSK	1/24	V	21.35	5.10	26.45	0.442
		16QAM	1/24	V	20.35	5.10	25.45	0.351
	1 882.5	QPSK	1/12	V	22.18	4.81	26.99	0.500
		16QAM	1/12	V	21.61	4.81	26.42	0.439
	1 912.5	QPSK	1/0	V	23.05	4.69	27.74	0.594
		16QAM	1/0	V	21.60	4.69	26.29	0.426
3	1 851.5	QPSK	1/14	V	21.16	5.11	26.27	0.424
		16QAM	1/14	V	19.87	5.11	24.98	0.315
	1 882.5	QPSK	1/7	V	21.60	4.81	26.41	0.438
		16QAM	1/7	V	20.78	4.81	25.59	0.362
	1 913.5	QPSK	1/0	V	23.11	4.69	27.80	0.603
		16QAM	1/0	V	22.00	4.69	26.69	0.467
1.4	1 850.7	QPSK	1/2	V	20.83	5.11	25.94	0.393
		16QAM	1/2	V	19.67	5.11	24.78	0.301
	1 882.5	QPSK	1/2	V	22.18	4.81	26.99	0.500
		16QAM	1/2	V	20.76	4.81	25.57	0.361
	1 914.3	QPSK	1/2	V	22.77	4.70	27.47	0.558
		16QAM	1/2	V	21.24	4.70	25.94	0.393

7.5.5. LTE Band 41

Channel Bandwidth (MHz)	Test Frequency (MHz)	Test Mode	RB Size/Offset	Ant Pol (H/V)	Level(dBm) @ Ant Terminal	TX Ant Gain (dBi)	EIRP (dBm)	EIRP (W)
20	2 506	QPSK	1/99	V	17.06	5.80	22.86	0.193
		16QAM	1/99	V	16.18	5.80	21.98	0.158
	2 593	QPSK	1/99	V	14.85	5.85	20.70	0.117
		16QAM	1/99	V	13.76	5.85	19.61	0.091
	2 680	QPSK	1/99	V	11.45	6.19	17.64	0.058
		16QAM	1/99	V	9.53	6.19	15.72	0.037
15	2 503.5	QPSK	1/74	V	17.49	5.80	23.29	0.213
		16QAM	1/74	V	16.54	5.80	22.34	0.171
	2 593	QPSK	1/74	V	14.48	5.85	20.33	0.108
		16QAM	1/74	V	13.66	5.85	19.51	0.089
	2 682.5	QPSK	1/74	V	11.23	6.20	17.43	0.055
		16QAM	1/74	V	10.40	6.20	16.60	0.046
10	2 501	QPSK	1/49	V	17.73	5.81	23.54	0.226
		16QAM	1/49	V	16.66	5.81	22.47	0.177
	2 593	QPSK	1/49	V	14.40	5.85	20.25	0.106
		16QAM	1/49	V	13.54	5.85	19.39	0.087
	2 685	QPSK	1/49	V	10.75	6.21	16.96	0.050
		16QAM	1/49	V	9.82	6.21	16.03	0.040
5	2 498.5	QPSK	1/24	V	17.40	5.81	23.21	0.209
		16QAM	1/24	V	16.42	5.81	22.23	0.167
	2 593	QPSK	1/24	V	14.15	5.85	20.00	0.100
		16QAM	1/24	V	13.43	5.85	19.28	0.085
	2 687.5	QPSK	1/24	V	11.16	6.21	17.37	0.055
		16QAM	1/24	V	10.21	6.21	16.42	0.044

7.5.6. LTE Band 7

Channel Bandwidth (MHz)	Test Frequency (MHz)	Test Mode	RB Size/ Offset	Ant Pol (H/V)	Level(dBm) @ Ant Terminal	TX Ant Gain (dBi)	EIRP (dBm)	EIRP (W)
20	2 510	QPSK	1/0	V	17.16	5.79	22.95	0.197
		16QAM	1/0	V	16.03	5.79	21.82	0.152
	2 535	QPSK	1/50	V	16.19	5.75	21.94	0.156
		16QAM	1/50	V	15.13	5.75	20.88	0.122
	2 560	QPSK	1/0	V	15.21	5.75	20.96	0.125
		16QAM	1/0	V	13.76	5.75	19.51	0.089
15	2 507.5	QPSK	1/0	V	17.24	5.80	23.04	0.201
		16QAM	1/0	V	15.89	5.80	21.69	0.148
	2 535	QPSK	1/36	V	16.64	5.75	22.39	0.173
		16QAM	1/36	V	15.36	5.75	21.11	0.129
	2 562.5	QPSK	1/0	V	15.21	5.76	20.97	0.125
		16QAM	1/0	V	13.79	5.76	19.55	0.090
10	2 505	QPSK	1/0	V	17.37	5.80	23.17	0.207
		16QAM	1/0	V	15.30	5.80	21.10	0.129
	2 535	QPSK	1/0	V	16.40	5.75	22.15	0.164
		16QAM	1/0	V	15.19	5.75	20.94	0.124
	2 565	QPSK	1/49	V	15.12	5.77	20.89	0.123
		16QAM	1/49	V	13.72	5.77	19.49	0.089
5	2 502.5	QPSK	1/12	V	17.34	5.81	23.15	0.207
		16QAM	1/12	V	15.62	5.81	21.43	0.139
	2 535	QPSK	1/12	V	16.83	5.75	22.58	0.181
		16QAM	1/12	V	15.34	5.75	21.09	0.129
	2 567.5	QPSK	1/24	V	15.14	5.77	20.91	0.123
		16QAM	1/24	V	13.76	5.77	19.53	0.090

7.6. UNDESIRABLE EMISSIONS (Radiated)

- Test Notes

- 1) This device was tested under all bandwidths, modulations and RB configurations and the worst case data are reported.
- 2) The frequency spectrum is examined from 9 kHz to the 10th harmonic of the fundamental frequency of the transmitter.
No other spurious and harmonic emissions were reported greater than listed emissions.
- 3) Limit Calculation for Band 25(2)/12(17)/5 = $43 + 10 \log_{10} (P[\text{Watts}])$
- 4) Limit Calculation for Band 7/41 = $55 + 10 \log_{10} (P[\text{Watts}])$

7.6.1. LTE Band 12

B.W (MHz)	Test Freq. (MHz)	RB Size/ Offset	Test Mode	Freq.(MHz)	Ant Pol (H/V)	Level(dBm) @ Ant Terminal	TX Ant Gain(dBd)	Result		Limit (dBc)
								(dBm)	(dBc)	
10	704	1/25	QPSK	1 408.01	H	-58.69	2.83	-55.86	74.93	32.07
				2 112.36	H	-37.24	2.99	-34.25	53.32	
			16QAM	1 409.32	H	-58.37	2.84	-55.53	73.68	31.15
				2 112.26	H	-36.99	2.99	-34.00	52.15	
	711	1/25	QPSK	1 425.78	H	-58.88	3.01	-55.87	75.05	32.18
				2 133.33	H	-34.74	3.03	-31.71	50.89	
			16QAM	1 428.38	H	-58.59	3.03	-55.56	73.15	30.59
				2 133.38	H	-34.79	3.03	-31.76	49.35	

7.6.2. LTE Band 17

B.W (MHz)	Test Freq. (MHz)	RB Size/ Offset	Test Mode	Freq.(MHz)	Ant Pol (H/V)	Level(dBm) @ Ant Terminal	TX Ant Gain(dBd)	Result		Limit (dBc)
								(dBm)	(dBc)	
10	709	1/25	QPSK	1 410.82	H	-58.65	2.86	-55.79	76.89	34.10
				2 127.29	V	-34.31	3.02	-31.29	52.39	
			16QAM	1 407.35	H	-57.90	2.82	-55.08	74.90	32.82
				2 127.32	V	-36.52	3.02	-33.50	53.32	
	711	1/0	QPSK	1 421.83	H	-58.44	2.97	-55.47	76.40	33.93
				2 119.81	V	-36.17	3.00	-33.17	54.10	
			16QAM	1 410.43	H	-58.32	2.85	-55.47	75.72	33.25
				2 119.87	V	-35.79	3.00	-32.79	53.04	
5	706.5	1/12	QPSK	1 413.07	H	-57.40	2.88	-54.52	76.36	34.84
				2 119.43	V	-36.42	3.00	-33.42	55.26	
			16QAM	1 412.98	H	-58.08	2.88	-55.20	74.82	32.62
				2 119.50	V	-36.33	3.00	-33.33	52.95	

7.6.3. LTE Band 25(2)

B.W (MHz)	Test Freq. (MHz)	RB Size/Offset	Test Mode	Freq.(MHz)	Ant Pol (H/V)	Level(dBm) @ Ant Terminal	TX Ant Gain(dBi)	Result		Limit (dBc)
								(dBm)	(dBc)	
20	1 860	1/0	QPSK	3 683.47	V	-56.58	8.14	-48.44	75.41	39.97
				5 553.17	H	-55.63	10.79	-44.84	71.81	
			16QAM	3 702.88	V	-55.68	8.07	-47.61	73.42	38.81
				5 553.58	H	-55.59	10.79	-44.80	70.61	
	1 882.5	1/0	QPSK	3 747.48	V	-55.59	8.16	-47.43	74.08	39.65
				5 621.18	H	-55.06	11.00	-44.06	70.71	
			16QAM	3 759.37	V	-56.50	8.24	-48.26	73.36	38.10
				5 620.80	H	-56.66	11.00	-45.66	70.76	
	1 905	1/0	QPSK	3 808.73	V	-55.21	8.58	-46.63	74.00	40.37
				5 688.75	H	-53.07	11.10	-41.97	69.34	
			16QAM	3 808.54	V	-55.89	8.58	-47.31	73.04	38.73
				5 688.35	H	-55.11	11.10	-44.01	69.74	
3	1 913.5	1/0	QPSK	3 824.58	V	-54.80	8.66	-46.14	73.94	40.80
				5 735.31	H	-56.22	11.03	-45.19	72.99	
			16QAM	3 824.08	V	-54.84	8.66	-46.18	72.87	39.69
				5 736.61	H	-56.12	11.02	-45.10	71.79	

7.6.4. LTE Band 5

B.W (MHz)	Test Freq. (MHz)	RB Size/ Offset	Test Mode	Freq.(MHz)	Ant Pol (H/V)	Level(dBm) @ Ant Terminal	TX Ant Gain(dBd)	Result		Limit (dBc)
								(dBm)	(dBc)	
10	829	1/25	QPSK	1 661.86	V	-58.66	3.87	-54.79	74.73	32.94
				2 487.17	H	-31.27	3.72	-27.55	47.49	
			16QAM	1 658.24	V	-58.77	3.85	-54.92	73.35	31.43
				2 487.28	H	-31.29	3.72	-27.57	46.00	
	836.5	1/0	QPSK	1 655.84	V	-58.34	3.84	-54.50	73.66	32.16
				2 496.31	H	-31.45	3.68	-27.77	46.93	
			16QAM	1 663.98	V	-58.41	3.88	-54.53	72.79	31.26
				2 496.24	H	-31.74	3.68	-28.06	46.32	
	844	1/25	QPSK	1 688.26	V	-55.33	3.97	-51.36	70.62	32.26
				2 532.37	H	-31.90	3.60	-28.30	47.56	
			16QAM	1 688.24	V	-57.15	3.97	-53.18	71.40	31.22
				2 532.34	H	-32.00	3.60	-28.40	46.62	

7.6.5. LTE Band 41

B.W (MHz)	Test Freq. (MHz)	RB Size/ Offset	Test Mode	Freq.(MHz)	Ant Pol (H/V)	Level(dBm) @ Ant Terminal	TX Ant Gain(dBi)	Result		Limit (dBc)
								(dBm)	(dBc)	
20	2 506	1/99	QPSK	5 007.04	H	-56.71	10.39	-46.32	69.18	47.86
				7 549.44	V	-55.65	12.22	-43.43	66.29	
			16QAM	5 028.40	H	-57.09	10.49	-46.60	68.58	46.98
				7 553.31	V	-55.91	12.23	-43.68	65.66	
	2 593	1/99	QPSK	5 212.57	H	-57.12	10.49	-46.63	67.33	45.70
				7 818.48	V	-54.89	12.72	-42.17	62.87	
			16QAM	5 187.62	H	-56.54	10.54	-46.00	65.61	44.61
				7 824.92	V	-54.70	12.73	-41.97	61.58	
	2 680	1/99	QPSK	5 368.26	H	-56.99	10.20	-46.79	64.43	42.64
				8 057.91	V	-54.62	12.65	-41.97	59.61	
			16QAM	5 370.83	H	-55.84	10.20	-45.64	61.36	40.72
				8 087.82	V	-54.30	12.62	-41.68	57.40	
10	2 501	1/49	QPSK	5 007.20	H	-57.00	10.39	-46.61	70.15	48.54
				7 529.16	V	-55.10	12.19	-42.91	66.45	
			16QAM	5 001.28	H	-57.11	10.37	-46.74	69.21	47.47
				7 526.88	V	-55.78	12.19	-43.59	66.06	

7.6.6. LTE Band 7

B.W (MHz)	Test Freq. (MHz)	RB Size/ Offset	Test Mode	Freq.(MHz)	Ant Pol (H/V)	Level(dBm) @ Ant Terminal	TX Ant Gain(dBi)	Result		Limit (dBc)
								(dBm)	(dBc)	
20	2 510	1/0	QPSK	4 984.84	V	-56.72	10.28	-46.44	69.39	47.95
				7 497.28	V	-55.98	12.16	-43.82	66.77	
			16QAM	4 993.36	V	-57.23	10.33	-46.90	68.72	46.82
				7 496.97	V	-55.04	12.16	-42.88	64.70	
	2 535	1/50	QPSK	5 061.26	V	-56.75	10.59	-46.16	68.10	46.94
				7 586.69	V	-55.58	12.28	-43.30	65.24	
			16QAM	5 090.95	V	-56.69	10.57	-46.12	67.00	45.88
				7 590.16	V	-56.00	12.28	-43.72	64.60	
	2 560	1/0	QPSK	5 087.96	V	-57.08	10.57	-46.51	67.47	45.96
				7 661.82	V	-55.61	12.41	-43.20	64.16	
			16QAM	5 123.46	V	-56.44	10.54	-45.90	65.41	44.51
				7 640.48	V	-55.64	12.37	-43.27	62.78	
10	2 505	1/0	QPSK	4 988.91	V	-57.54	10.30	-47.24	70.41	48.17
				7 498.52	V	-55.71	12.16	-43.55	66.72	
			16QAM	4 992.22	V	-57.46	10.32	-47.14	68.24	46.10
				7 490.25	V	-55.42	12.17	-43.25	64.35	

7.7. FREQUENCY STABILITY

- Test Notes

Based on the results of the frequency stability test at the center channel the frequency deviation results measured are very small. As such it is determined that the channels at the band edge would remain in-band when the maximum measured frequency deviation noted during the frequency stability tests is applied. Therefore the device is determined to remain operating in band over the temperature and voltage range as tested.

7.7.1. LTE Band 12

OPERATING FREQUENCY : 707.5 MHz
 REFERENCE VOLTAGE : 3.85 VDC
 LIMIT(FCC&IC) : The frequency stability shall be sufficient to ensure that the fundamental emission stays within the authorized frequency block.

VOLTAGE (%)	POWER (V DC)	TEMP (°C)	FREQUENCY (Hz)	FREQ.Dev (Hz)	Deviation	
					(ppm)	(%)
100 %	3.85	+20(Ref)	707,500,013	+13	+0.018 4	+0.000 001 837
100 %		-30	707,500,001	+1	+0.001 4	+0.000 000 141
100 %		-20	707,499,989	-11	-0.015 5	-0.000 001 555
100 %		-10	707,500,006	+6	+0.008 5	+0.000 000 848
100 %		0	707,499,998	-2	-0.002 8	-0.000 000 283
100 %		+10	707,500,007	+7	+0.009 9	+0.000 000 989
100 %		+20	707,500,013	+13	+0.018 4	+0.000 001 837
100 %		+30	707,499,994	-6	-0.008 5	-0.000 000 848
100 %		+40	707,500,003	+3	+0.004 2	+0.000 000 424
100 %		+50	707,500,007	+7	+0.009 9	+0.000 000 989
115 %		4.43	+20	707,499,998	-2	-0.002 8
BATT.ENDPOINT	3.10	+20	707,499,991	-9	-0.012 7	-0.000 001 272

7.7.2. LTE Band 17

OPERATING FREQUENCY : 710 MHz
 REFERENCE VOLTAGE : 3.85 VDC
 LIMIT(FCC&IC) : The frequency stability shall be sufficient to ensure that the fundamental emission stays within the authorized frequency block.

VOLTAGE (%)	POWER (V DC)	TEMP (°C)	FREQUENCY (Hz)	FREQ.Dev (Hz)	Deviation	
					(ppm)	(%)
100 %	3.85	+20(Ref)	710,000,007	+7	+0.009 9	+0.000 000 986
100 %		-30	709,999,998	-2	-0.002 8	-0.000 000 282
100 %		-20	709,999,987	-13	-0.018 3	-0.000 001 831
100 %		-10	710,000,006	+6	+0.008 5	+0.000 000 845
100 %		0	709,999,999	-1	-0.001 4	-0.000 000 141
100 %		+10	710,000,009	+9	+0.012 7	+0.000 001 268
100 %		+20	710,000,007	+7	+0.009 9	+0.000 000 986
100 %		+30	710,000,003	+3	+0.004 2	+0.000 000 423
100 %		+40	710,000,011	+11	+0.015 5	+0.000 001 549
100 %		+50	709,999,997	-3	-0.004 2	-0.000 000 423
115 %	4.43	+20	709,999,991	-9	-0.012 7	-0.000 001 268
BATT.ENDPOINT	3.10	+20	710,000,006	+6	+0.008 5	+0.000 000 845

7.7.3. LTE Band 5

OPERATING FREQUENCY : 836.5 MHz
 REFERENCE VOLTAGE : 3.85 VDC
 DEVIATION LIMIT(FCC&IC) : $\pm 0.00025\%$ or 2.5 ppm

VOLTAGE (%)	POWER (V DC)	TEMP (°C)	FREQUENCY (Hz)	FREQ.Dev (Hz)	Deviation	
					(ppm)	(%)
100 %	3.85	+20(Ref)	836,500,016	+16	+0.019 1	+0.000 001 913
100 %		-30	836,499,998	-2	-0.002 4	-0.000 000 239
100 %		-20	836,500,007	+7	+0.008 4	+0.000 000 837
100 %		-10	836,500,009	+9	+0.010 8	+0.000 001 076
100 %		0	836,499,992	-8	-0.009 6	-0.000 000 956
100 %		+10	836,499,989	-11	-0.013 2	-0.000 001 315
100 %		+20	836,500,016	+16	+0.019 1	+0.000 001 913
100 %		+30	836,500,002	+2	+0.002 4	+0.000 000 239
100 %		+40	836,499,994	-6	-0.007 2	-0.000 000 717
100 %		+50	836,500,011	+11	+0.013 2	+0.000 001 315
115 %	4.43	+20	836,499,999	-1	-0.001 2	-0.000 000 120
BATT.ENDPOINT	3.10	+20	836,500,006	+6	+0.007 2	+0.000 000 717

7.7.4. LTE Band 25(2)

OPERATING FREQUENCY : 1 882.5 MHz
 REFERENCE VOLTAGE : 3.85 VDC
 LIMIT(FCC) : The frequency stability shall be sufficient to ensure that the fundamental emission stays within the authorized frequency block.
 LIMIT(IC) : ± 0.000 25 % or 2.5 ppm

VOLTAGE (%)	POWER (V DC)	TEMP (°C)	FREQUENCY (Hz)	FREQ.Dev (Hz)	Deviation	
					(ppm)	(%)
100 %	3.85	+20(Ref)	1,882,499,994	-6	-0.003 2	-0.000 000 319
100 %		-30	1,882,500,013	+13	+0.006 9	+0.000 000 691
100 %		-20	1,882,500,006	+6	+0.003 2	+0.000 000 319
100 %		-10	1,882,499,993	-7	-0.003 7	-0.000 000 372
100 %		0	1,882,500,002	+2	+0.001 1	+0.000 000 106
100 %		+10	1,882,499,984	-16	-0.008 5	-0.000 000 850
100 %		+20	1,882,499,994	-6	-0.003 2	-0.000 000 319
100 %		+30	1,882,500,006	+6	+0.003 2	+0.000 000 319
100 %		+40	1,882,499,995	-5	-0.002 7	-0.000 000 266
100 %		+50	1,882,500,002	+2	+0.001 1	+0.000 000 106
115 %	4.43	+20	1,882,500,007	+7	+0.003 7	+0.000 000 372
BATT.ENDPOINT	3.10	+20	1,882,499,997	-3	-0.001 6	-0.000 000 159

7.7.5. LTE Band 41

OPERATING FREQUENCY : 2 593 MHz
 REFERENCE VOLTAGE : 3.85_VDC
 LIMIT(FCC&IC) : The frequency stability shall be sufficient to ensure that the fundamental emission stays within the authorized frequency block.

VOLTAGE (%)	POWER (V DC)	TEMP (°C)	FREQUENCY (Hz)	FREQ.Dev (Hz)	Deviation	
					(ppm)	(%)
100 %	3.85	+20(Ref)	2,592,999,999	-1	-0.000 4	-0.000 000 039
100 %		-30	2,593,000,009	+9	+0.003 5	+0.000 000 347
100 %		-20	2,593,000,016	+16	+0.006 2	+0.000 000 617
100 %		-10	2,593,000,012	+12	+0.004 6	+0.000 000 463
100 %		0	2,592,999,993	-7	-0.002 7	-0.000 000 270
100 %		+10	2,593,000,006	+6	+0.002 3	+0.000 000 231
100 %		+20	2,592,999,999	-1	-0.000 4	-0.000 000 039
100 %		+30	2,592,999,991	-9	-0.003 5	-0.000 000 347
100 %		+40	2,592,999,987	-13	-0.005 0	-0.000 000 501
100 %		+50	2,593,000,006	+6	+0.002 3	+0.000 000 231
115 %		4.43	+20	2,592,999,995	-5	-0.001 9
BATT.ENDPOINT	3.10	+20	2,593,000,007	7	+0.002 7	+0.000 000 270

7.7.6. LTE Band 7

OPERATING FREQUENCY : 2 535 MHz
 REFERENCE VOLTAGE : 3.85 VDC
 LIMIT(FCC&IC) : The frequency stability shall be sufficient to ensure that the fundamental emission stays within the authorized frequency block.

VOLTAGE (%)	POWER (V DC)	TEMP (°C)	FREQUENCY (Hz)	FREQ.Dev (Hz)	Deviation	
					(ppm)	(%)
100 %	3.85	+20(Ref)	2,534,999,989	-11	-0.004 3	-0.000 000 434
100 %		-30	2,534,999,994	-6	-0.002 4	-0.000 000 237
100 %		-20	2,534,999,984	-16	-0.006 3	-0.000 000 631
100 %		-10	2,535,000,002	+2	+0.000 8	+0.000 000 079
100 %		0	2,535,000,006	+6	+0.002 4	+0.000 000 237
100 %		+10	2,534,999,999	-1	-0.000 4	-0.000 000 039
100 %		+20	2,534,999,989	-11	-0.004 3	-0.000 000 434
100 %		+30	2,535,000,007	+7	+0.002 8	+0.000 000 276
100 %		+40	2,534,999,991	-9	-0.003 6	-0.000 000 355
100 %		+50	2,534,999,998	-2	-0.000 8	-0.000 000 079
115 %		4.43	+20	2,535,000,016	+16	+0.006 3
BATT.ENDPOINT	3.10	+20	2,535,000,012	+12	+0.004 7	+0.000 000 473

8. TEST PLOTS

- Test Notes:

All bandwidths, RB configurations, and modulations were investigated. The worst case test results are reported.

8.1. OCCUPIED BANDWIDTH

8.1.1. LTE Band 12

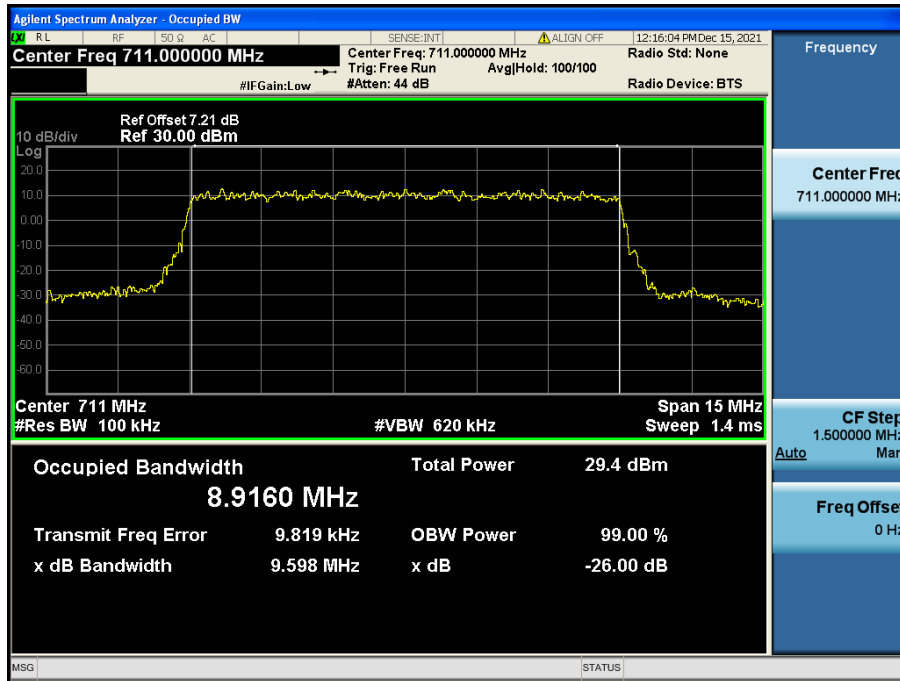

LTE Band 12 / 10 MHz / QPSK - RB Size 50



LTE Band 12 / 10 MHz / 16QAM - RB Size 50

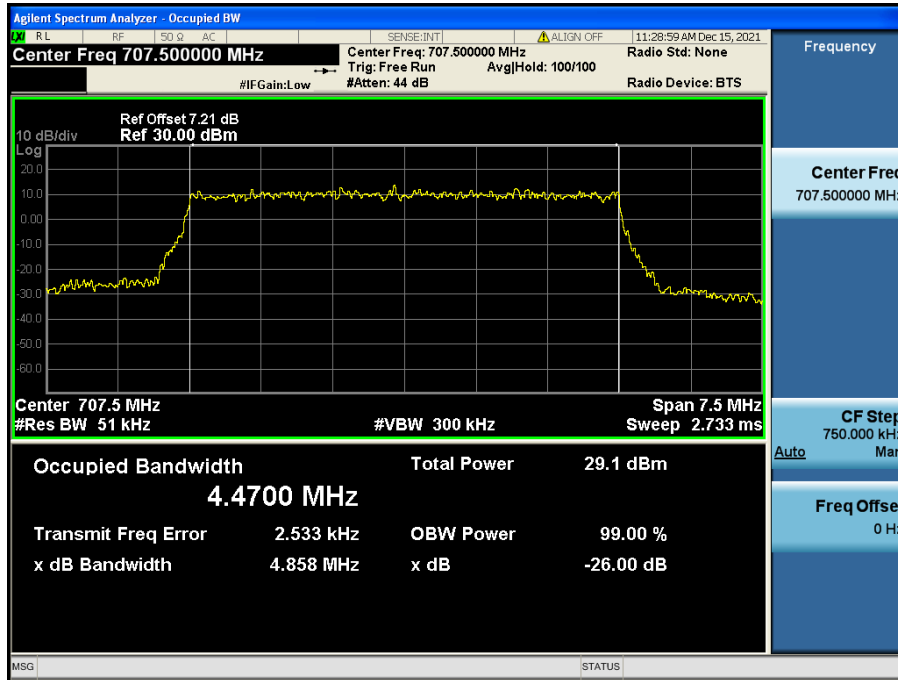

LTE Band 12 / 5 MHz / QPSK - RB Size 25

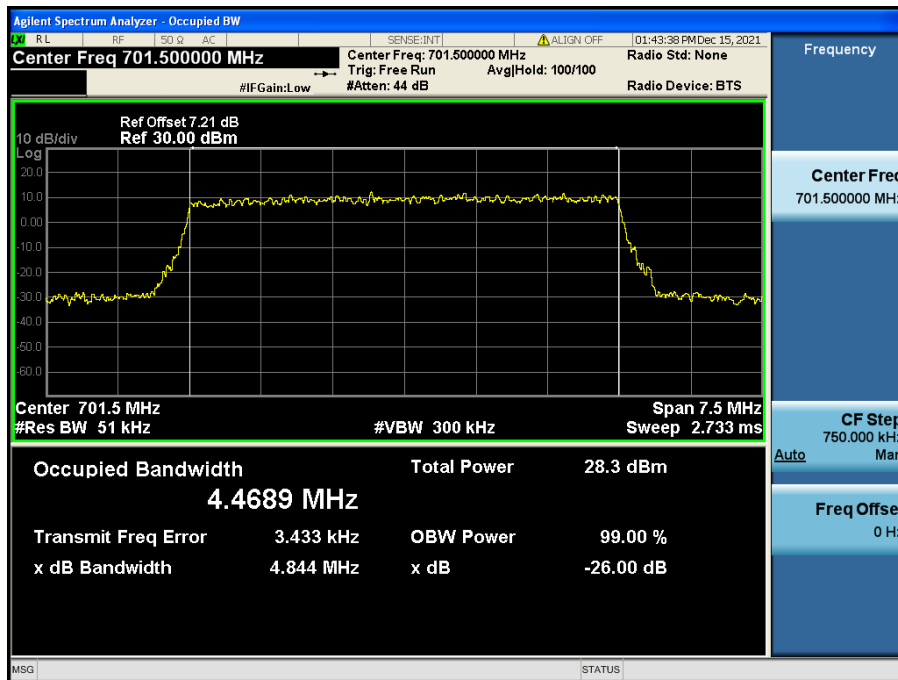

LTE Band 12 / 5 MHz / 16QAM - RB Size 25

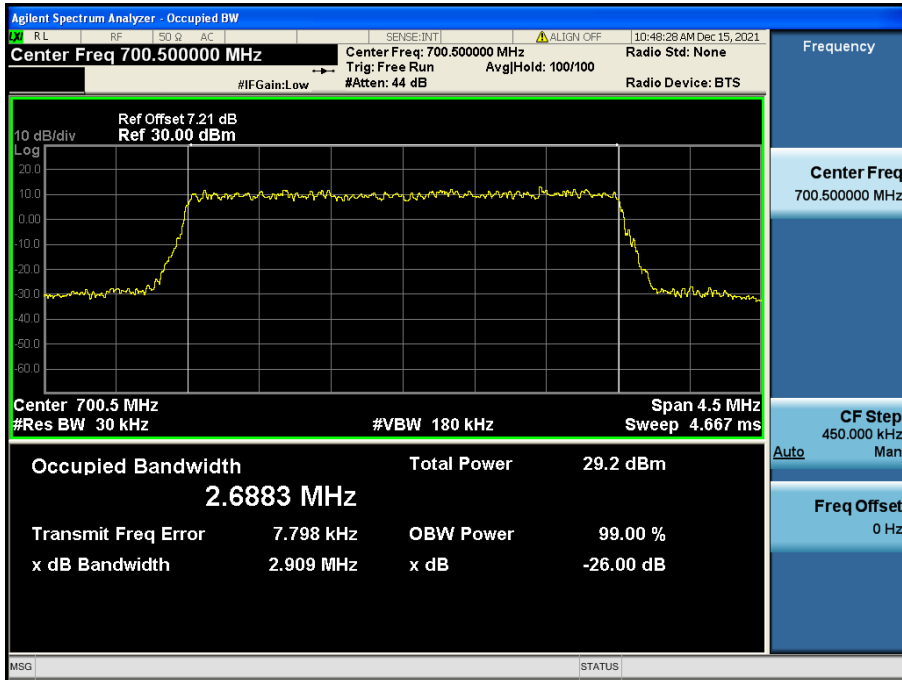

LTE Band 12 / 3 MHz / QPSK - RB Size 15

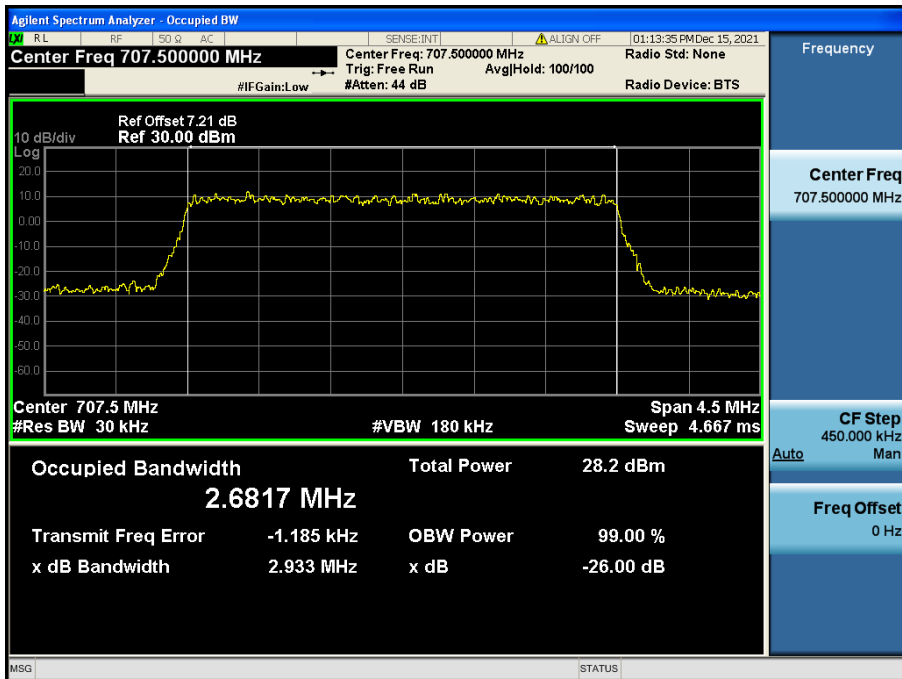

LTE Band 12 / 3 MHz / 16QAM - RB Size 15

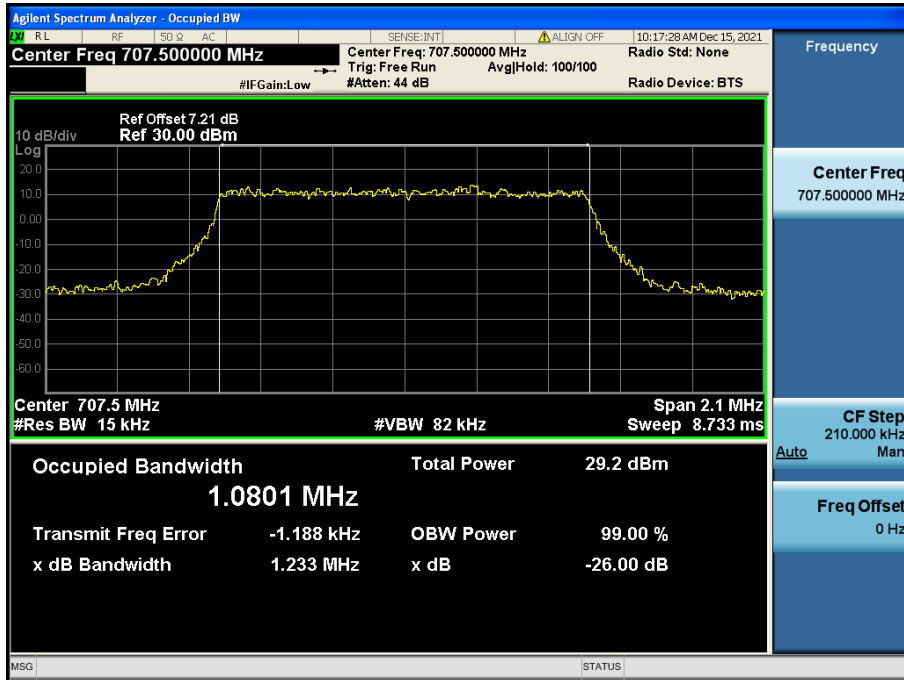

LTE Band 12 / 1.4 MHz / QPSK - RB Size 6

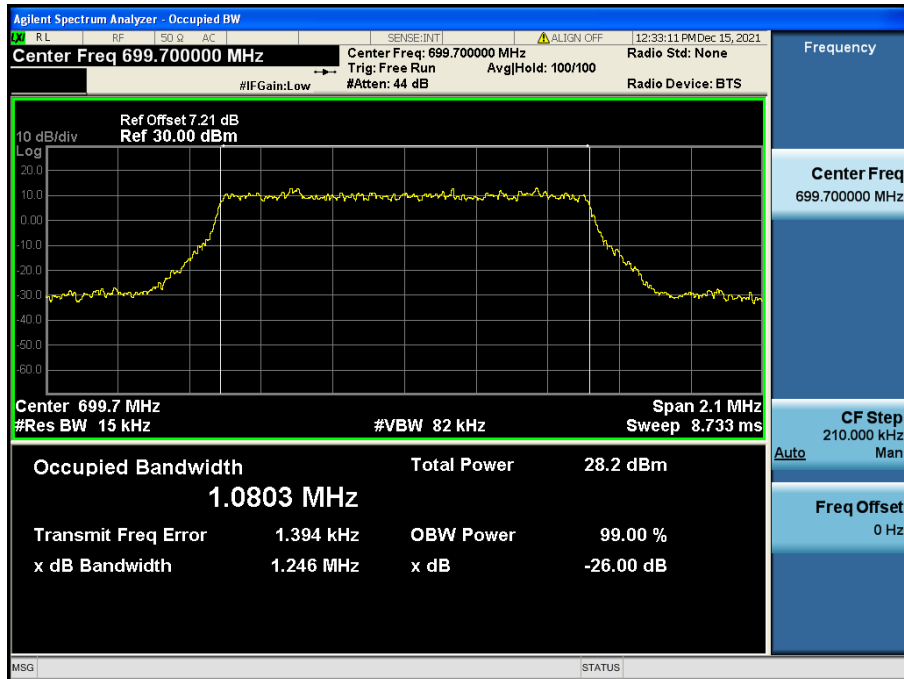

LTE Band 12 / 1.4 MHz / 16QAM - RB Size 6

8.1.2. LTE Band 17

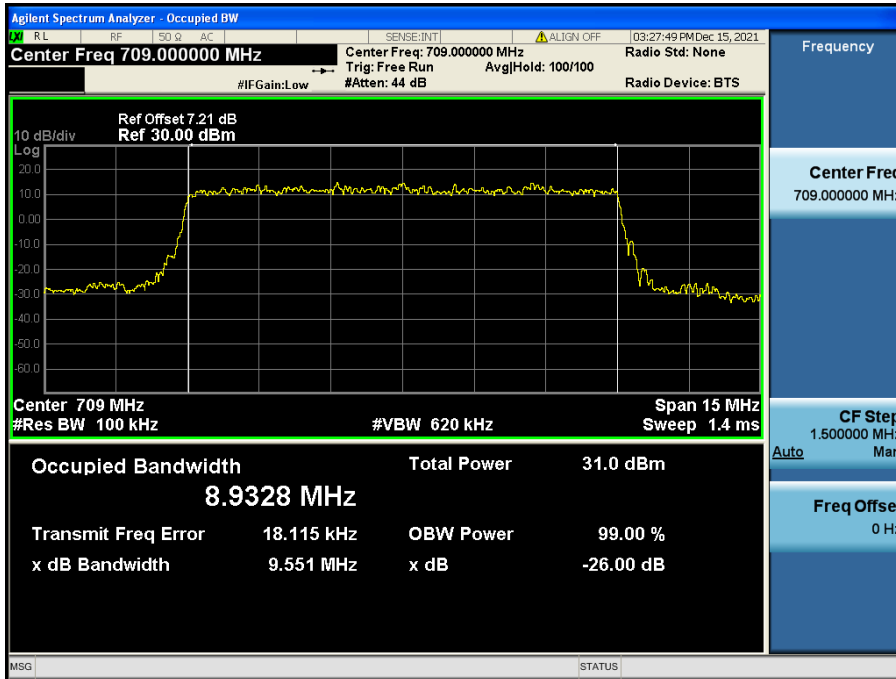

LTE Band 17 / 10 MHz / QPSK - RB Size 15

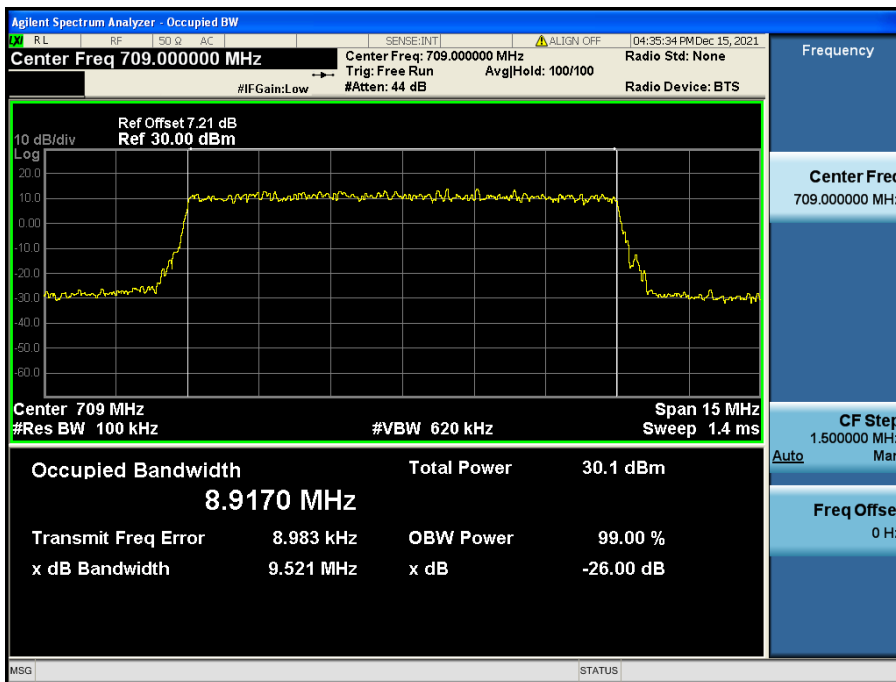

LTE Band 17 / 10 MHz / 16QAM - RB Size 15

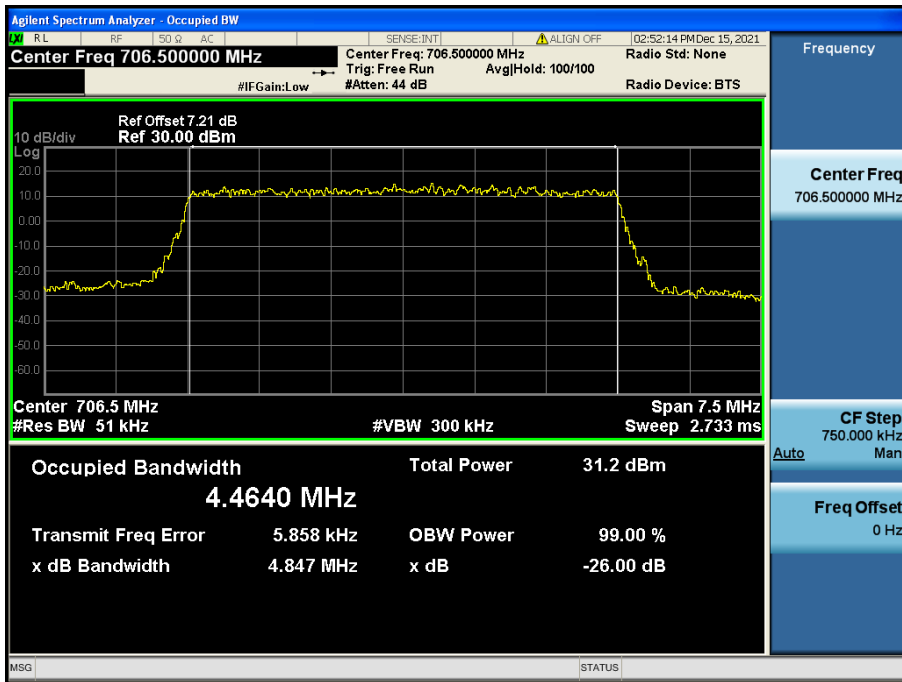

LTE Band 17 / 5 MHz / QPSK - RB Size 25

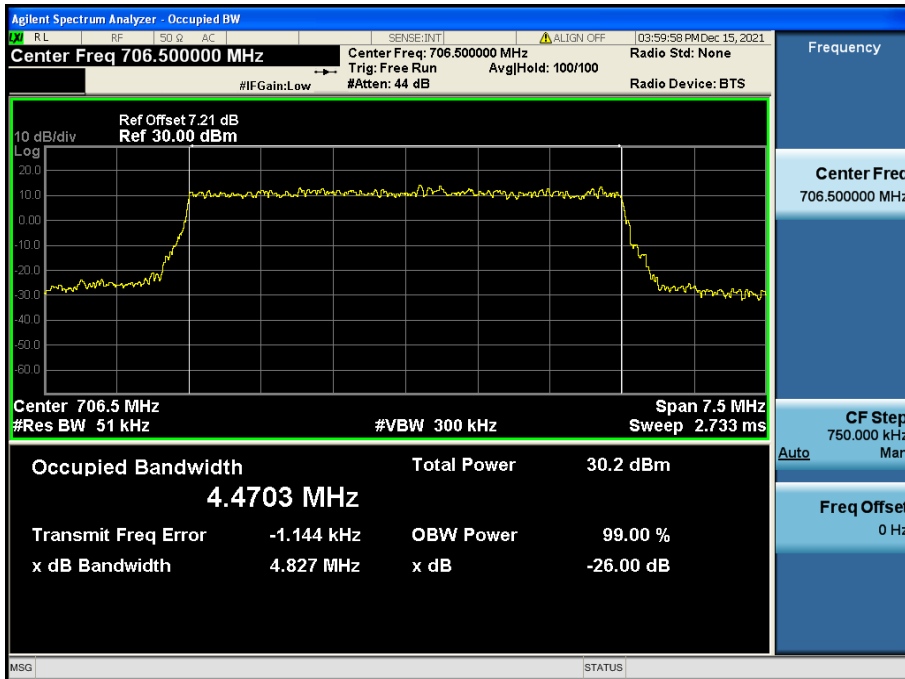

LTE Band 17 / 5 MHz / 16QAM - RB Size 25

8.1.3. LTE Band 5

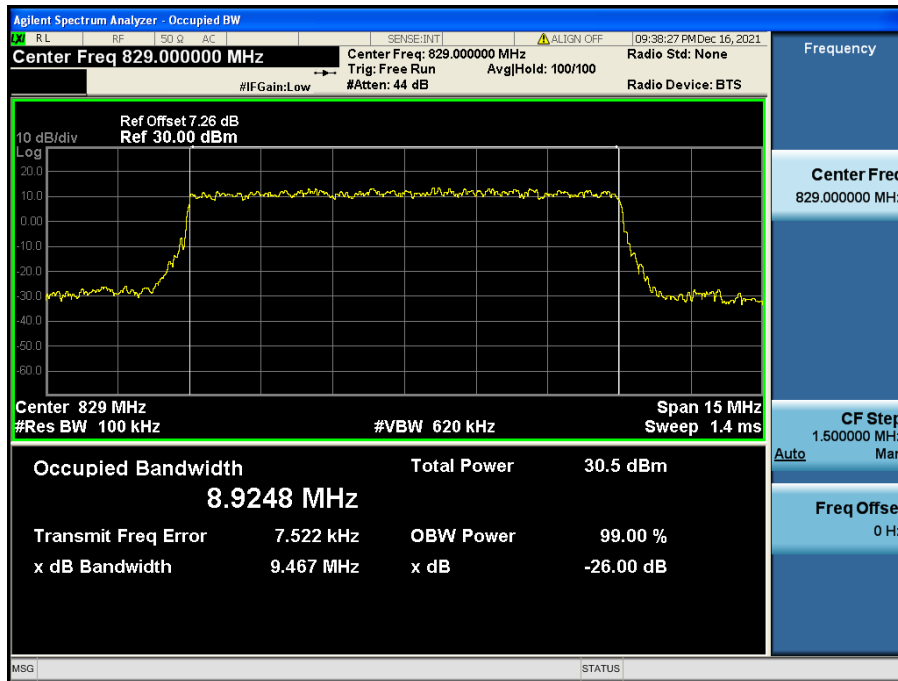

LTE Band 5 / 10 MHz / QPSK - RB Size 50



LTE Band 5 / 10 MHz / 16QAM - RB Size 50

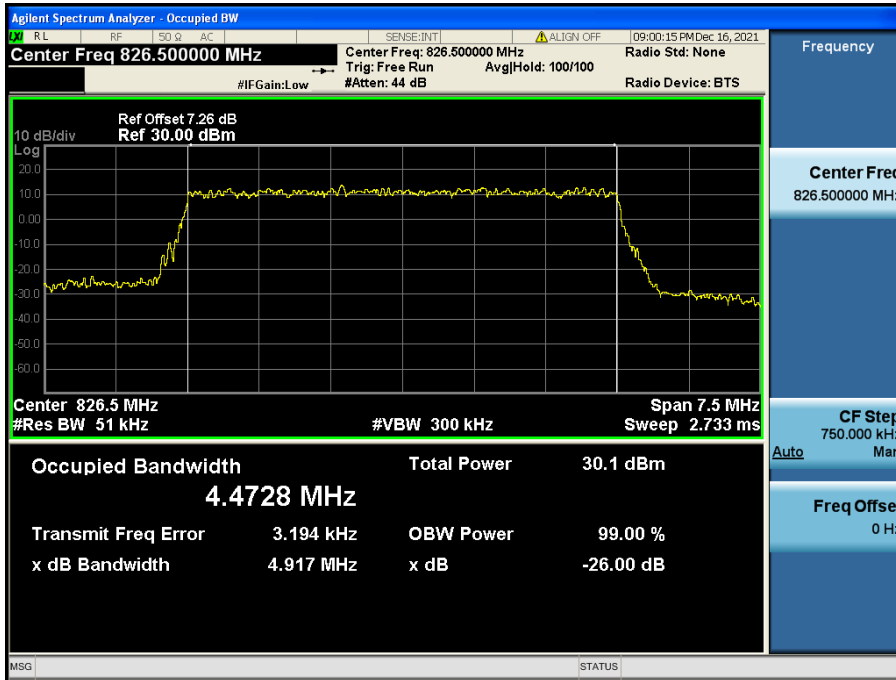

LTE Band 5 / 5 MHz / QPSK - RB Size 25

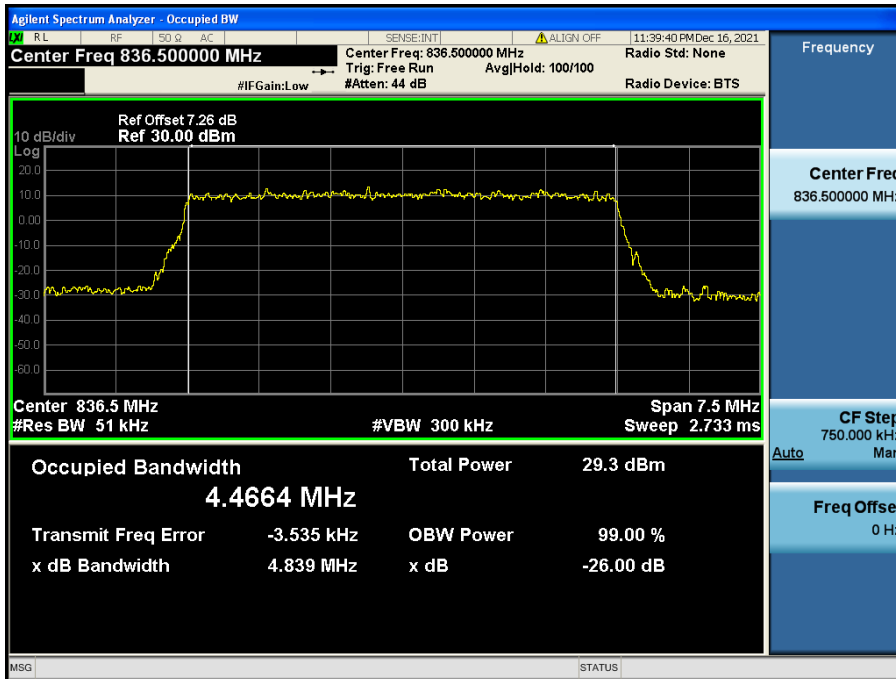

LTE Band 5 / 5 MHz / 16QAM - RB Size 25

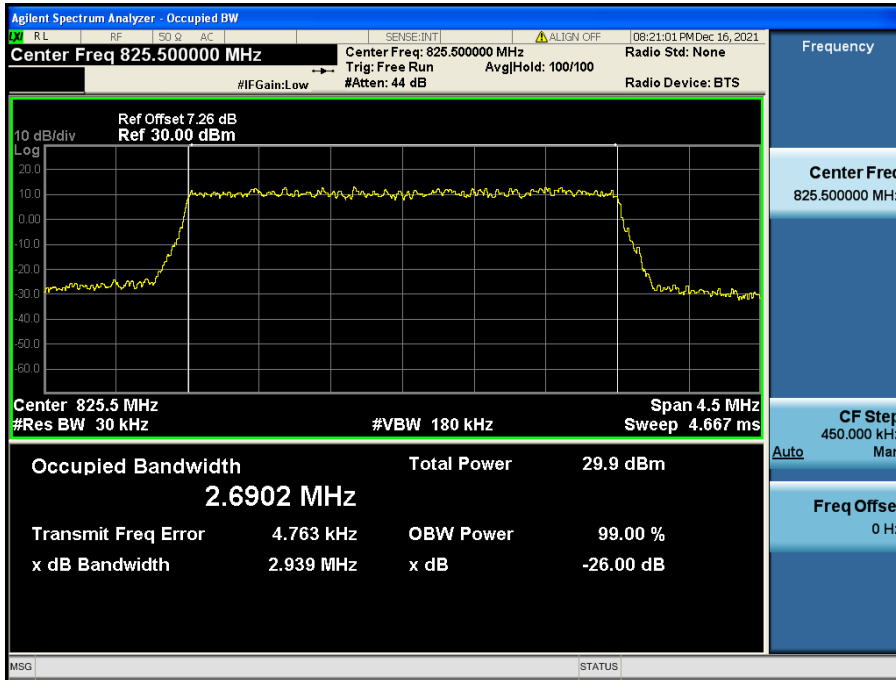

LTE Band 5 / 3 MHz / QPSK - RB Size 15

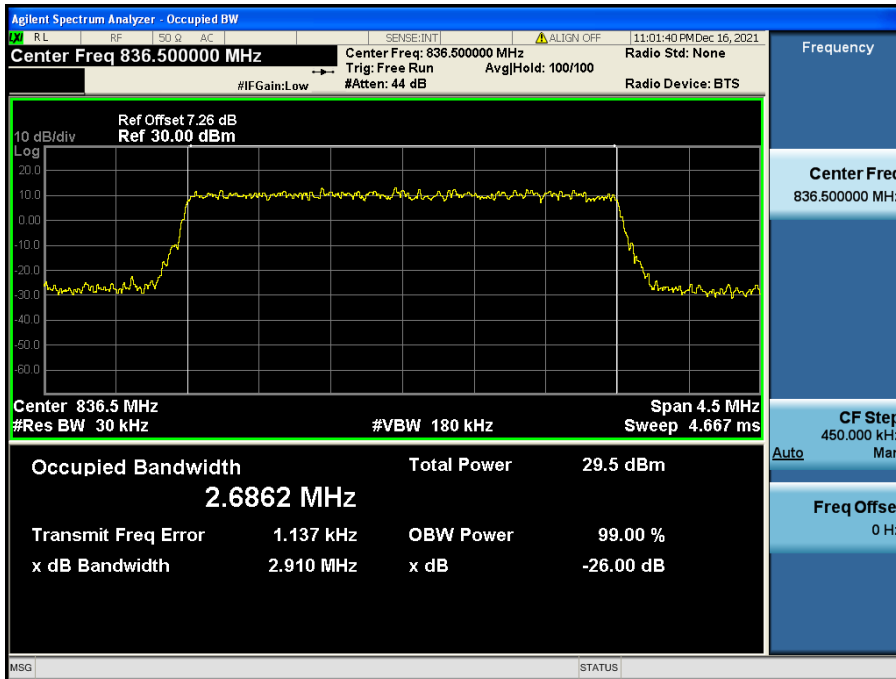

LTE Band 5 / 3 MHz / 16QAM - RB Size 15

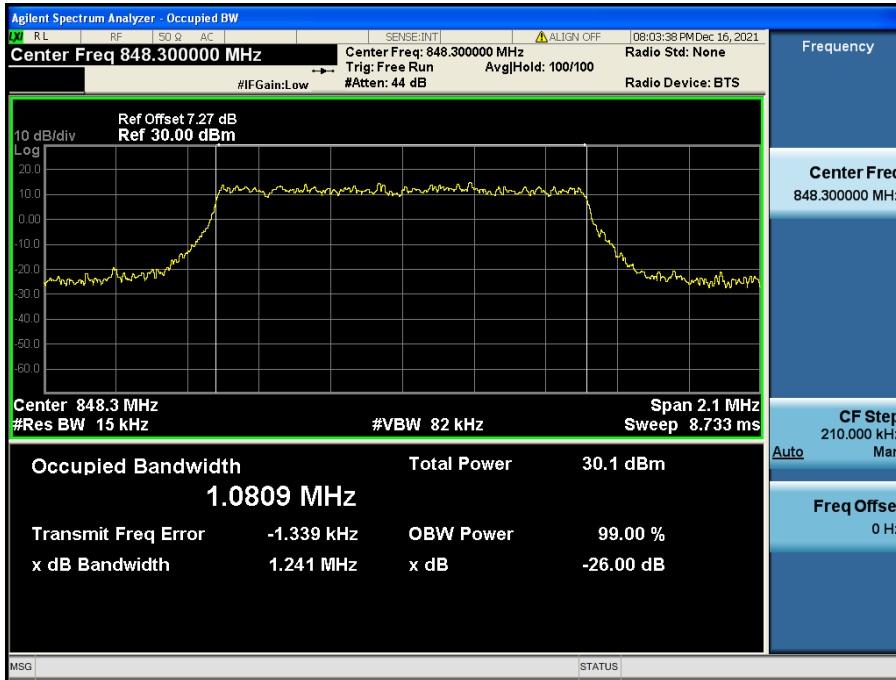

LTE Band 5 / 1.4 MHz / QPSK - RB Size 6

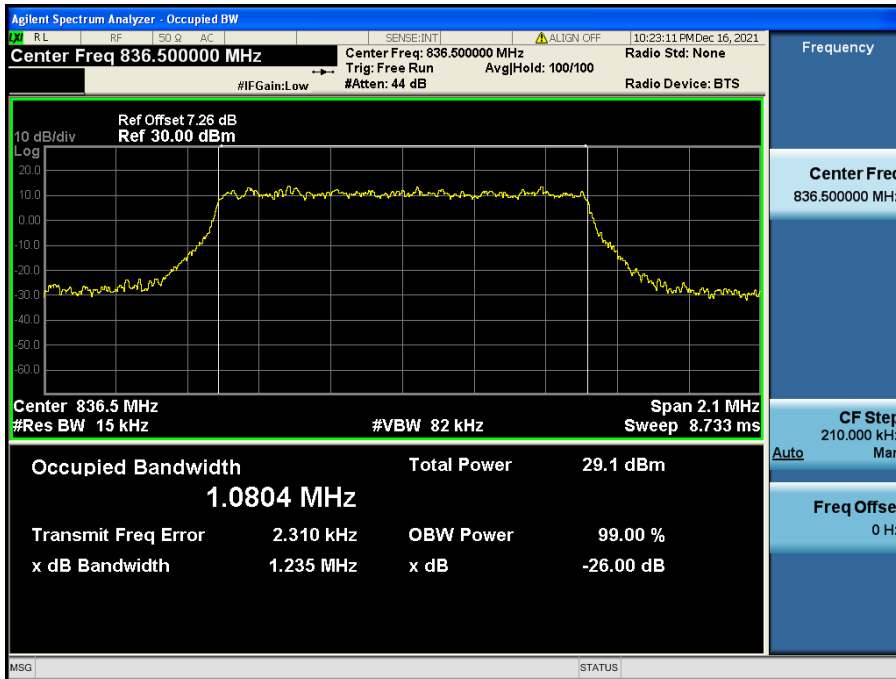

LTE Band 5 / 1.4 MHz / 16QAM - RB Size 6

8.1.4. LTE Band 25(2)

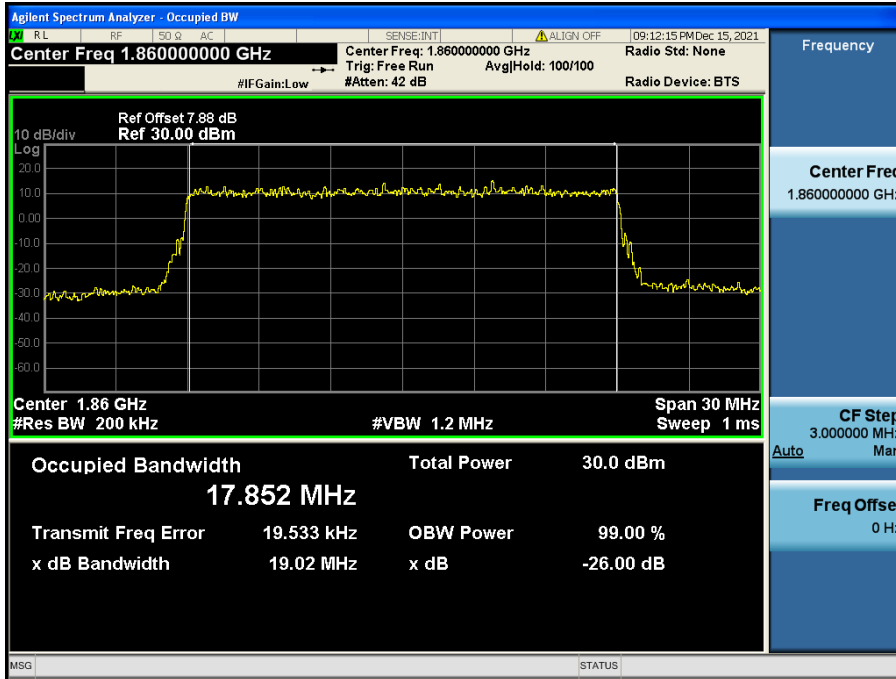

LTE Band 25(2) / 20 MHz / QPSK - RB Size 100

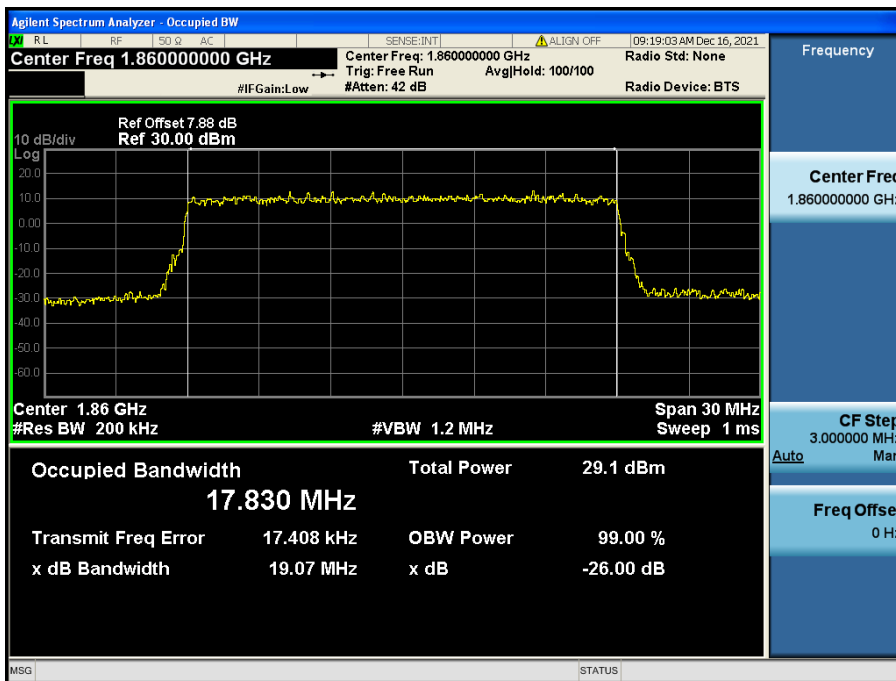

LTE Band 25(2) / 20 MHz / 16QAM - RB Size 100

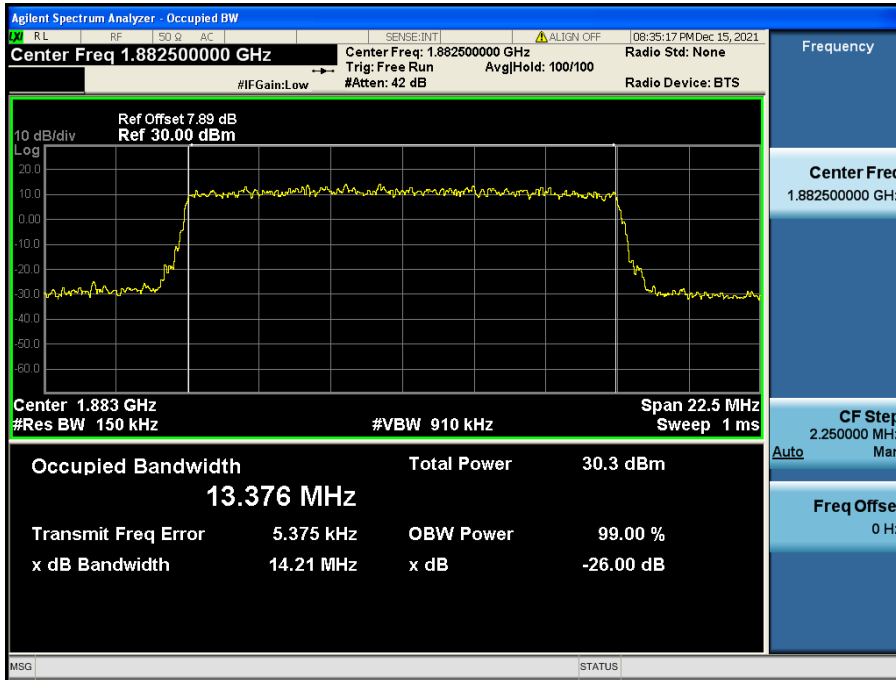

LTE Band 25(2) / 15 MHz / QPSK - RB Size 75

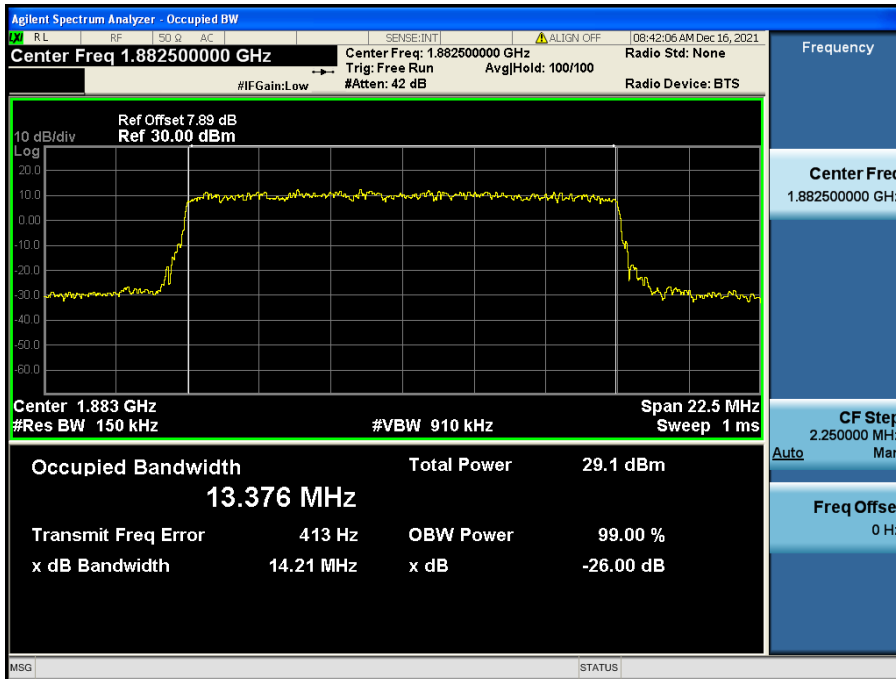

LTE Band 25(2) / 15 MHz / 16QAM - RB Size 75

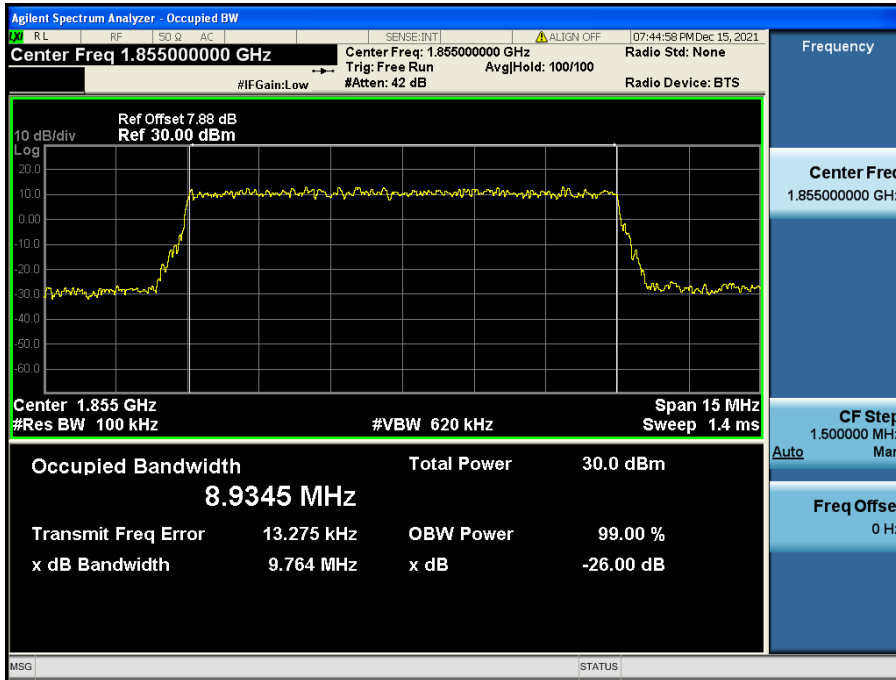

LTE Band 25(2) / 10 MHz / QPSK - RB Size 50

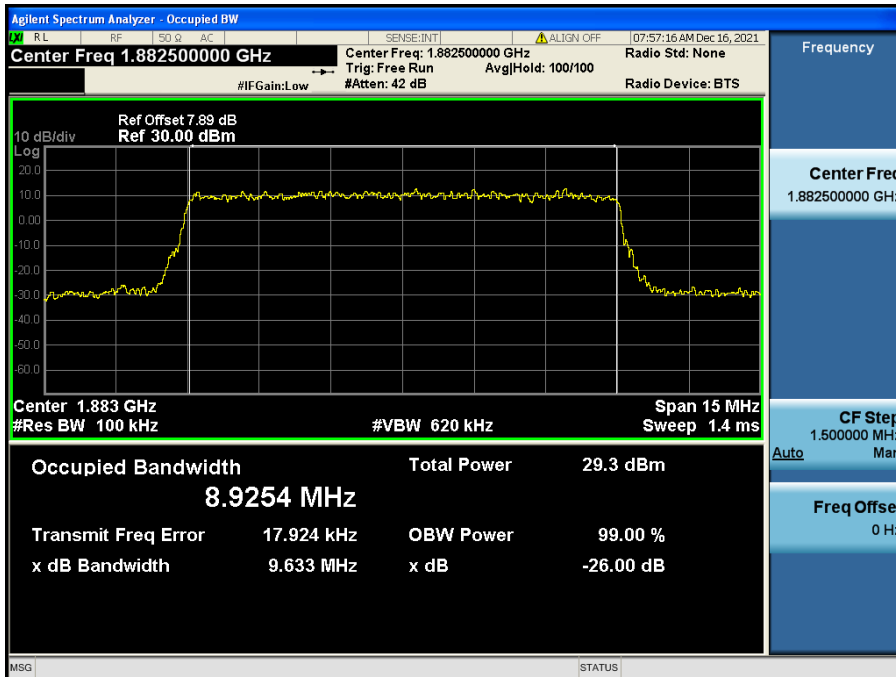

LTE Band 25(2) / 10 MHz / 16QAM - RB Size 50

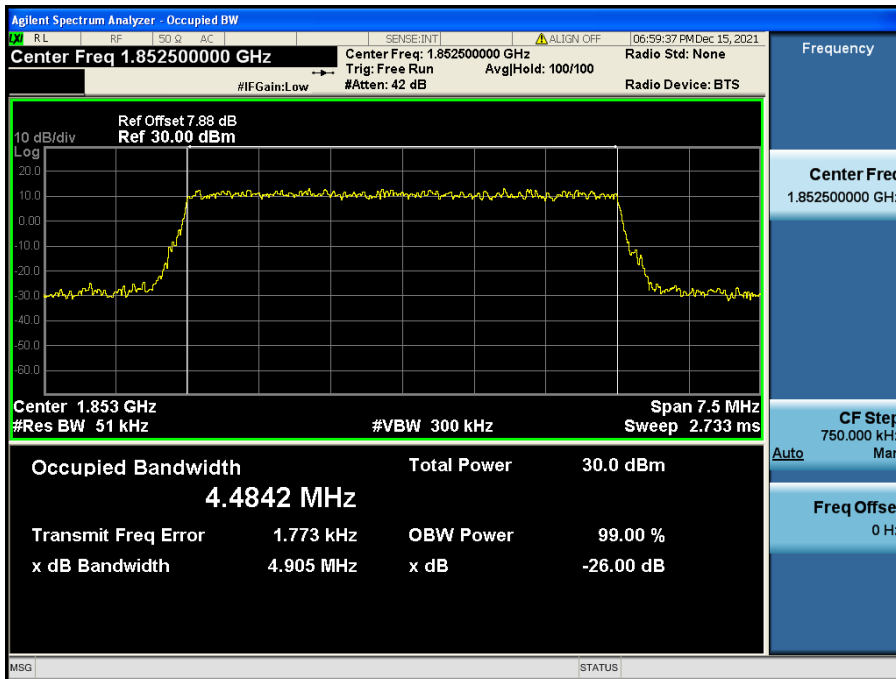

LTE Band 25(2) / 5 MHz / QPSK - RB Size 25

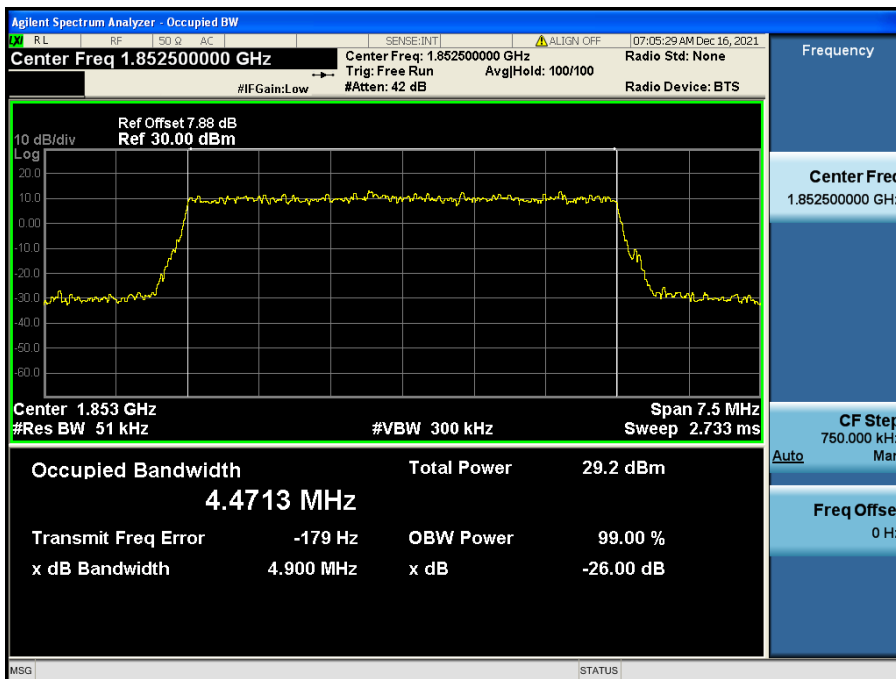

LTE Band 25(2) / 5 MHz / 16QAM - RB Size 25

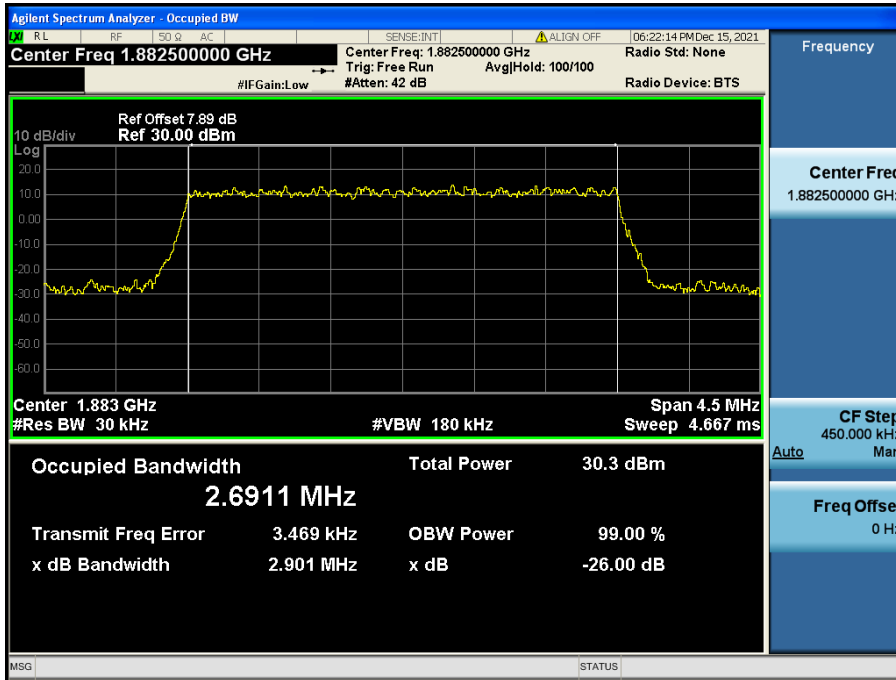

LTE Band 25(2) / 3 MHz / QPSK - RB Size 15

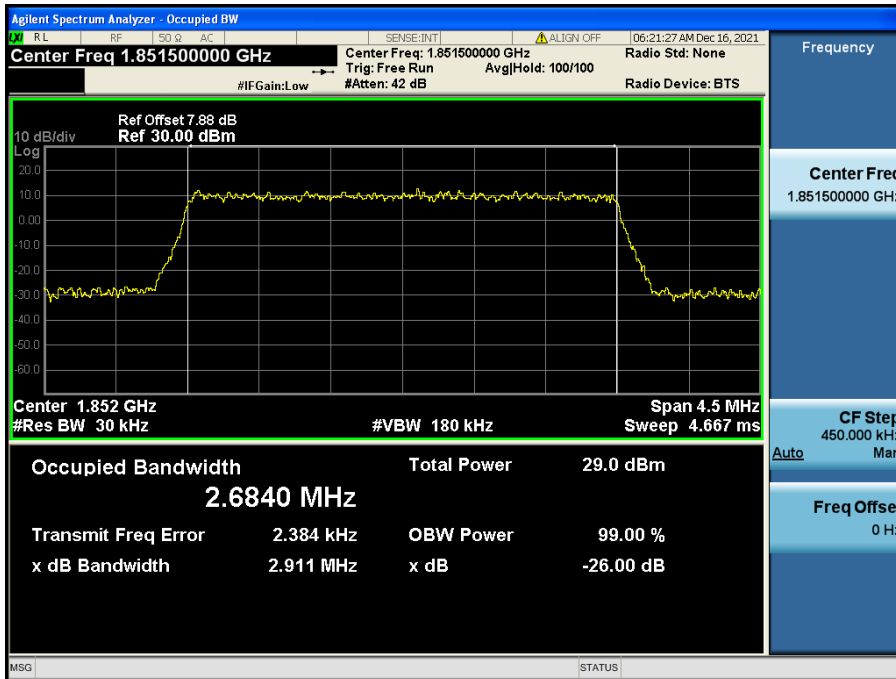

LTE Band 25(2) / 3 MHz / 16QAM - RB Size 15

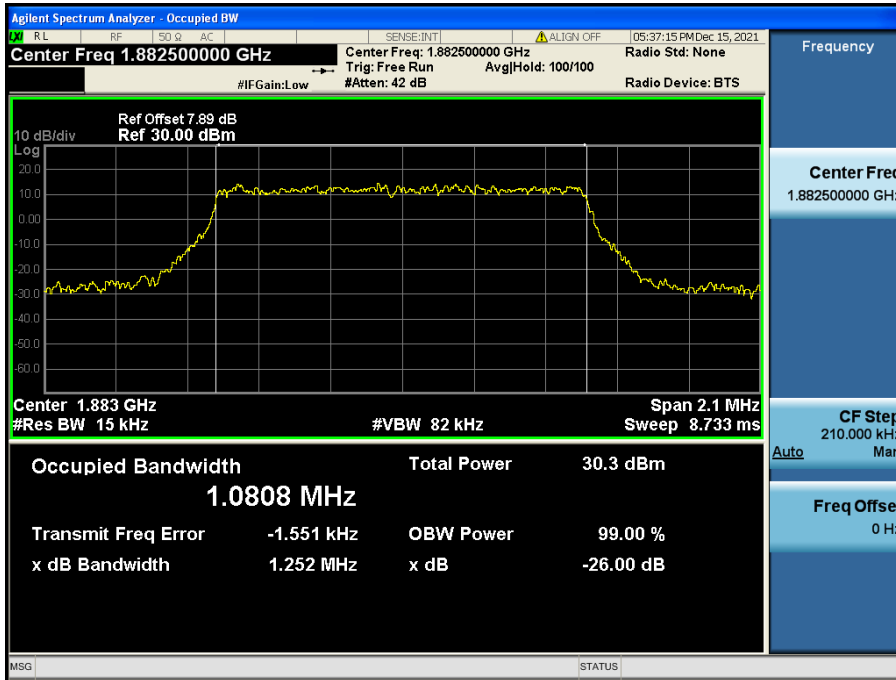

LTE Band 25(2) / 1.4 MHz / QPSK - RB Size 6

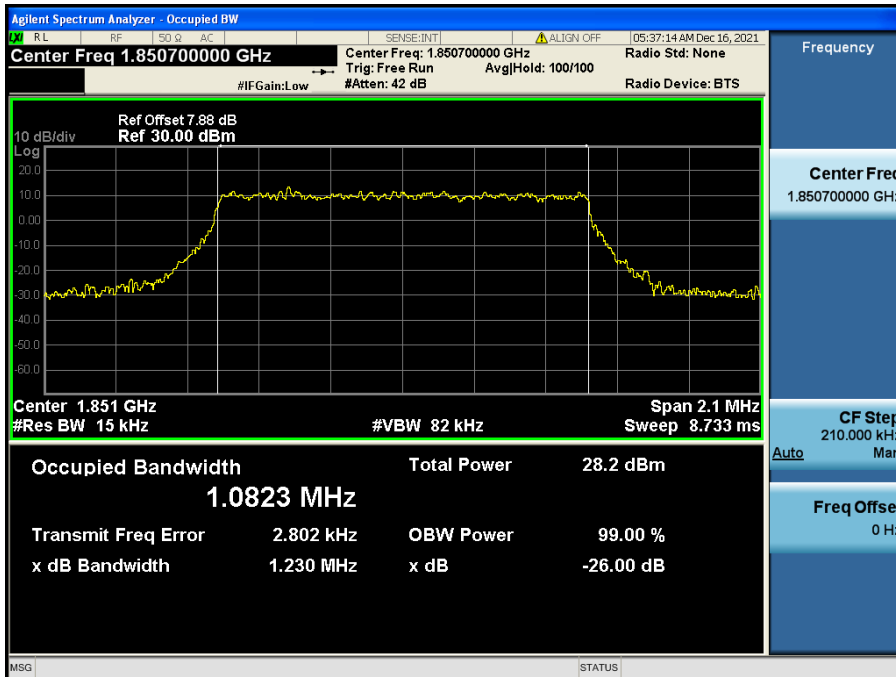

LTE Band 25(2) / 1.4 MHz / 16QAM - RB Size 6

8.1.5. LTE Band 41

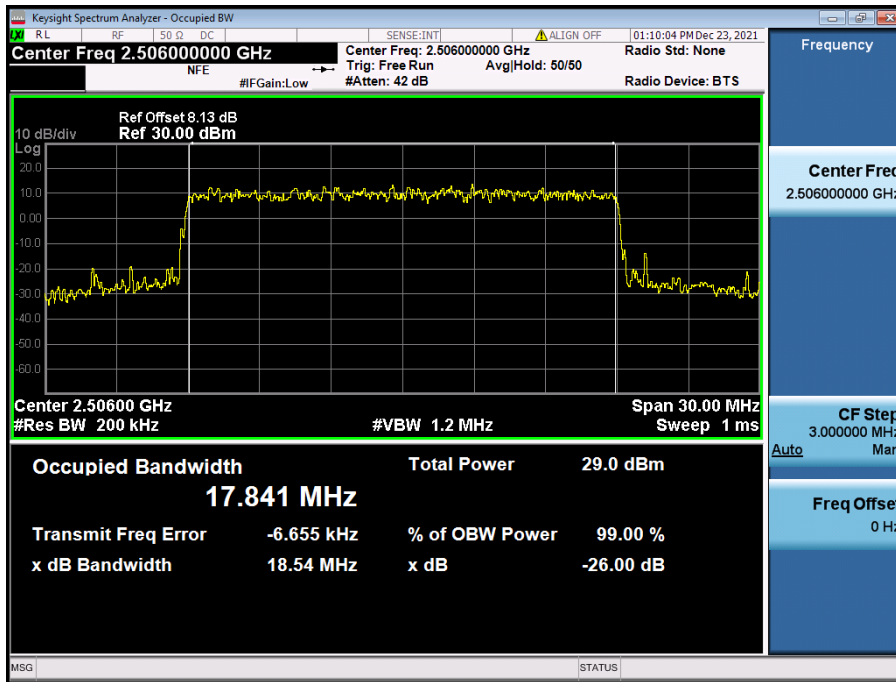

LTE Band 41 / 20 MHz / QPSK - RB Size 100

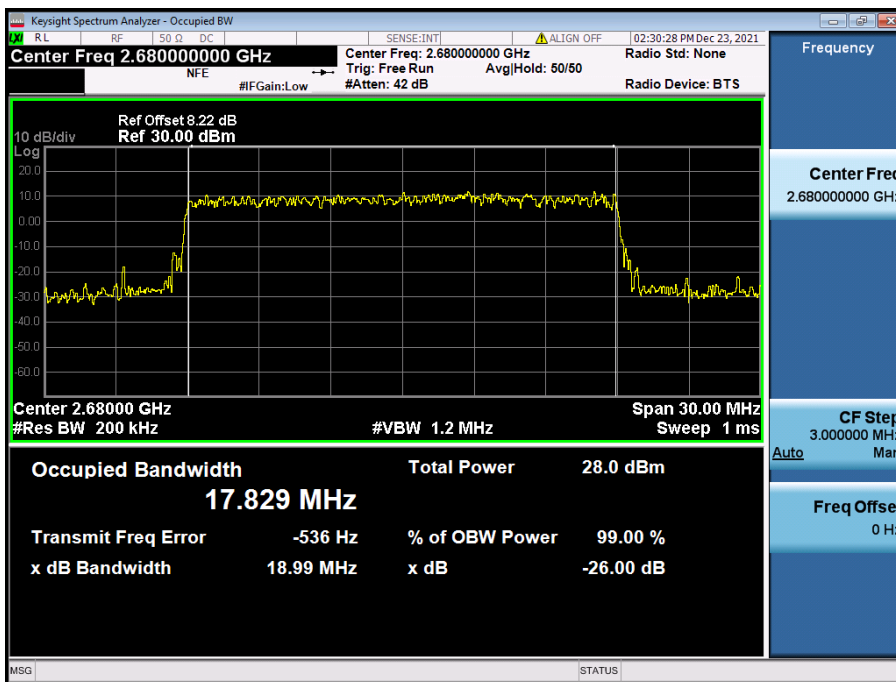

LTE Band 41 / 20 MHz / 16QAM - RB Size 100

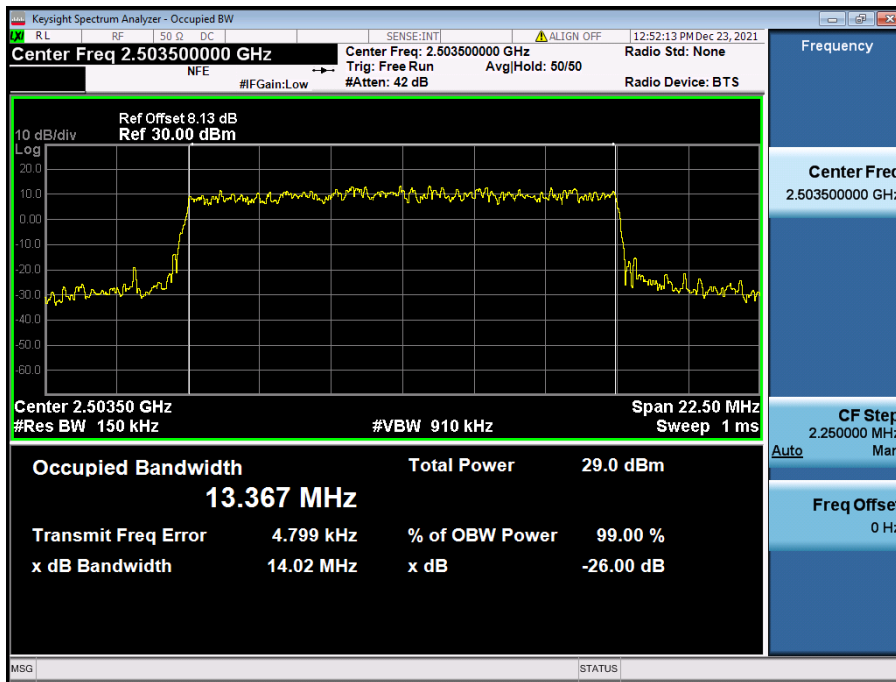

LTE Band 41 / 15 MHz / QPSK - RB Size 75

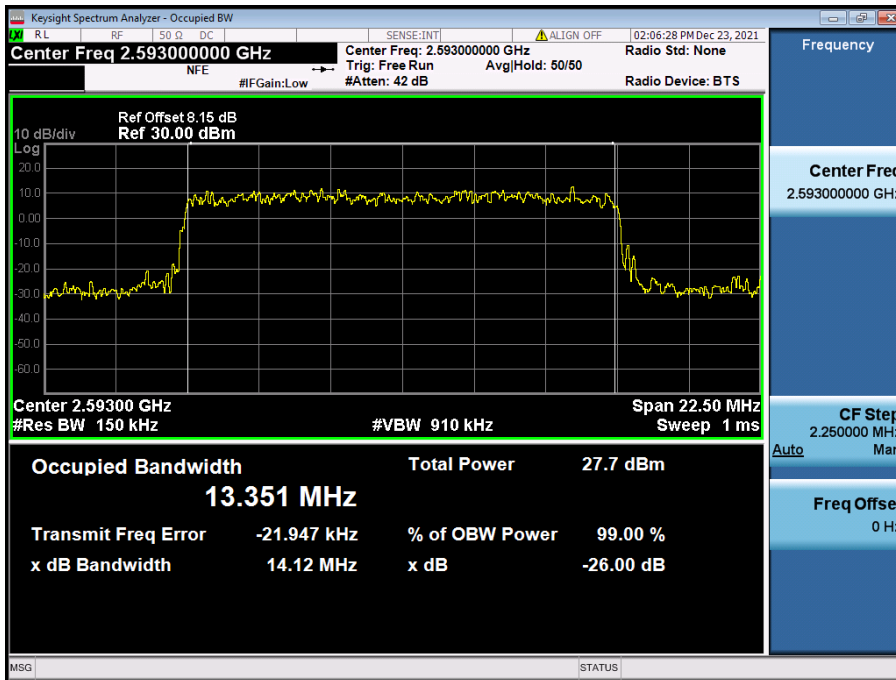

LTE Band 41 / 15 MHz / 16QAM - RB Size 75

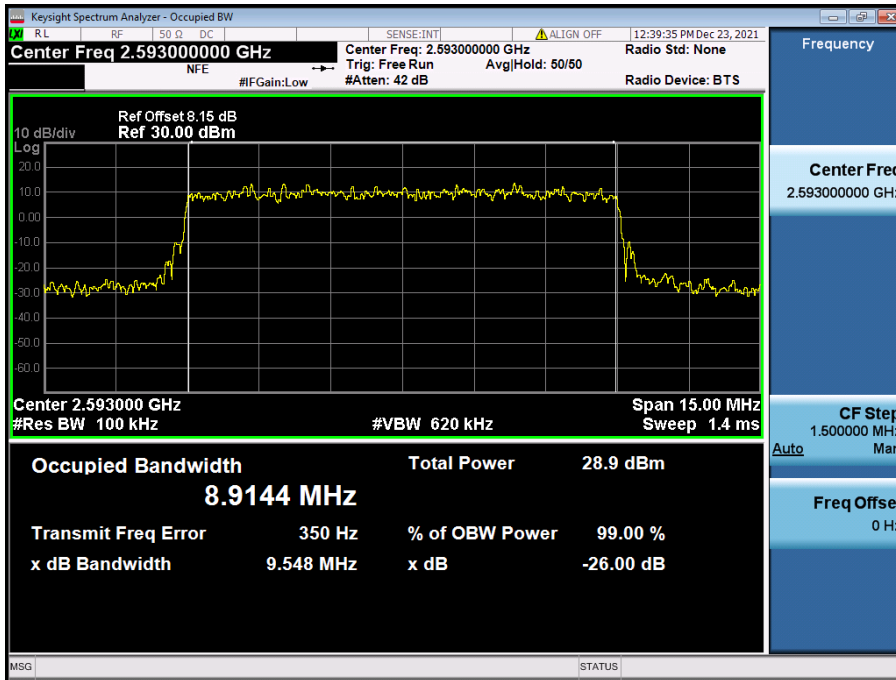

LTE Band 41 / 10 MHz / QPSK - RB Size 50

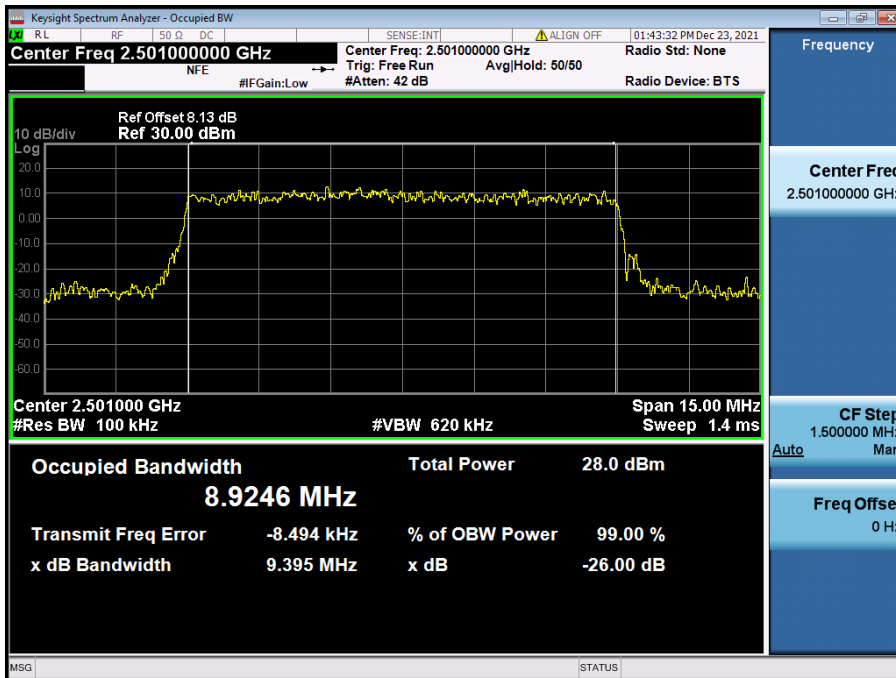

LTE Band 41 / 10 MHz / 16QAM - RB Size 50

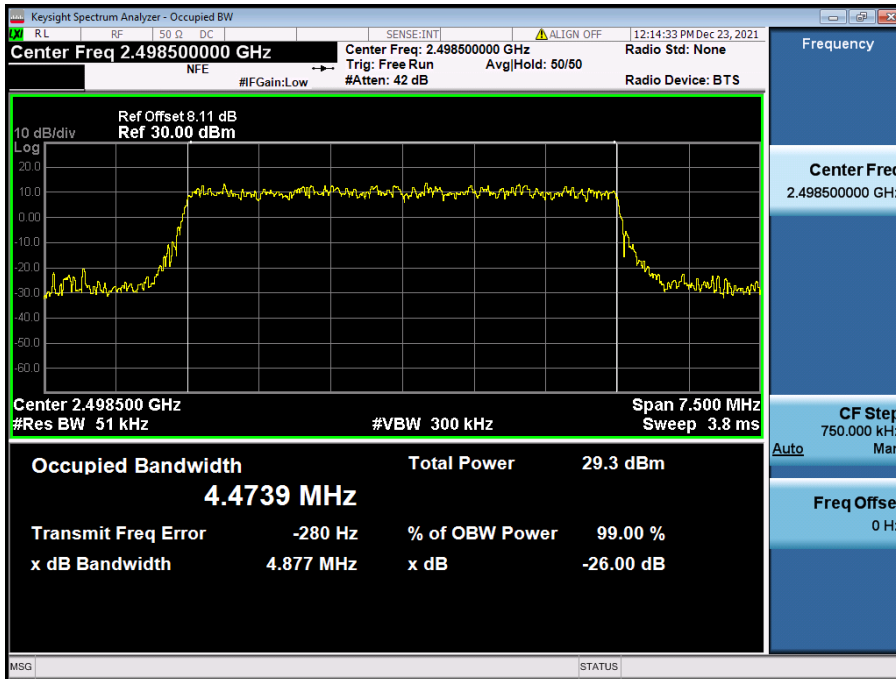

LTE Band 41 / 5 MHz / QPSK - RB Size 25

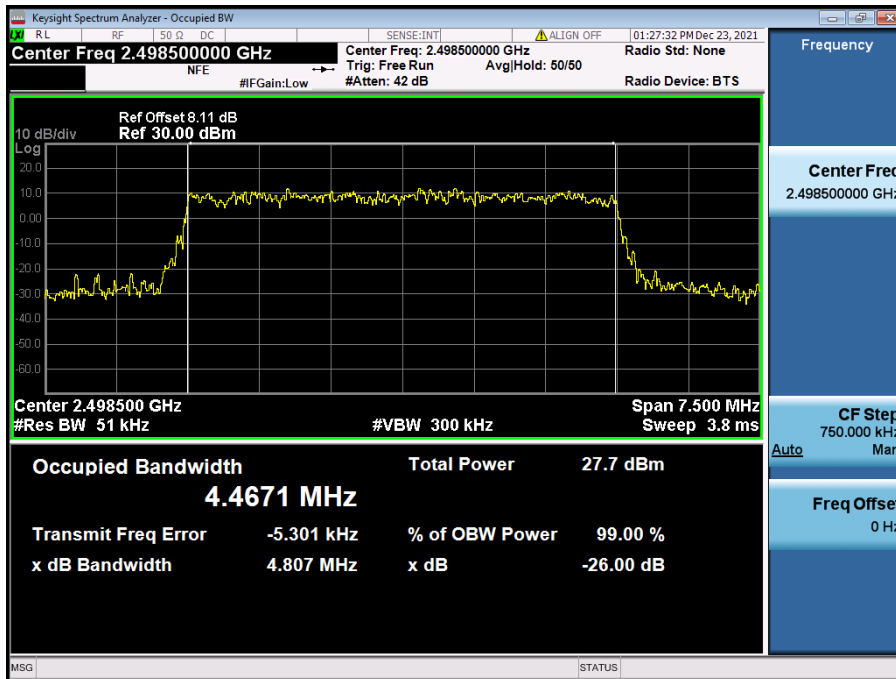

LTE Band 41 / 5 MHz / 16QAM - RB Size 25

8.1.6. LTE Band 7

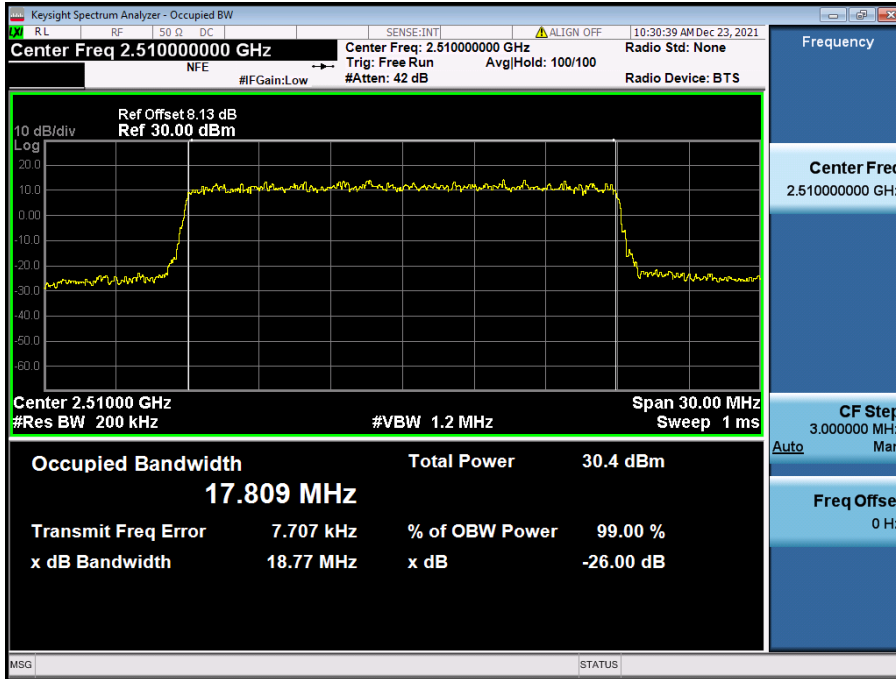

LTE Band 7 / 20 MHz / QPSK - RB Size 100

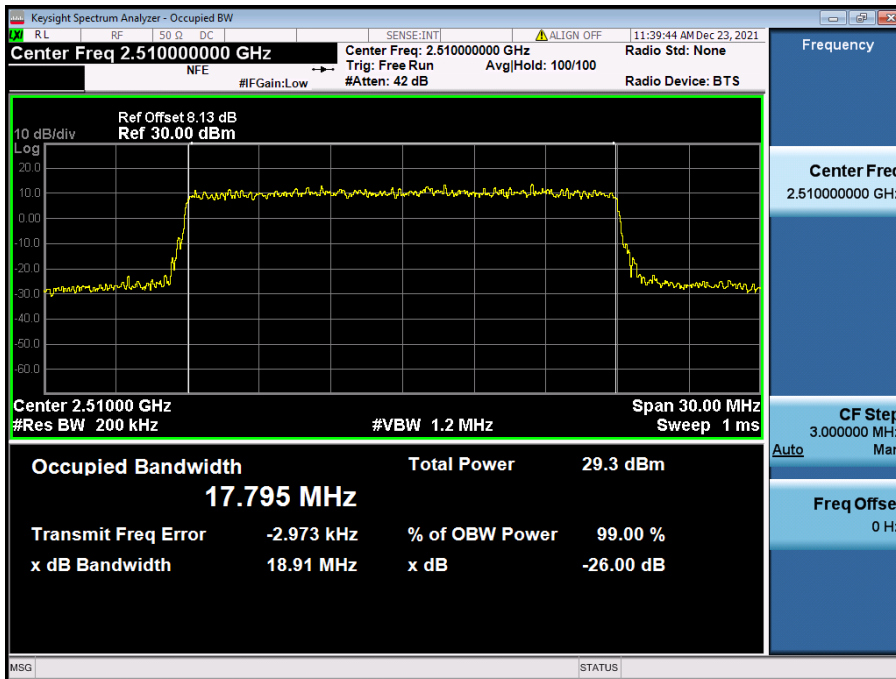

LTE Band 7 / 20 MHz / 16QAM - RB Size 100

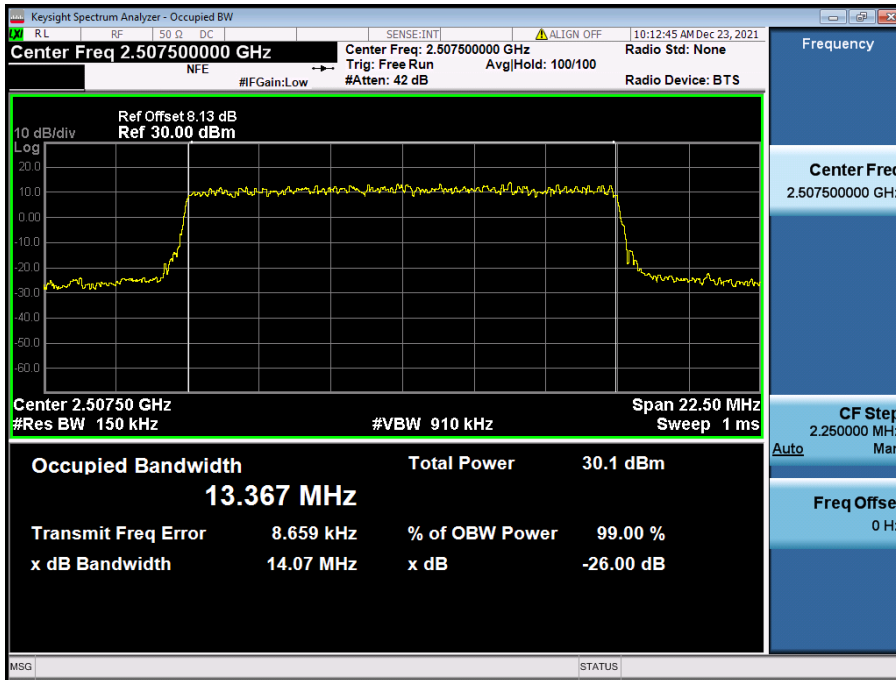

LTE Band 7 / 15 MHz / QPSK - RB Size 75

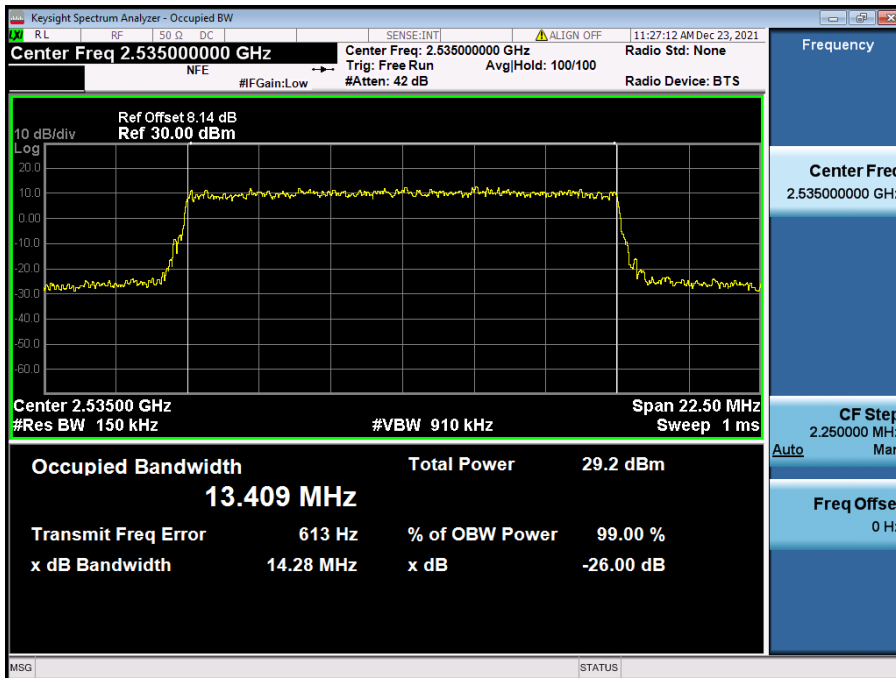

LTE Band 7 / 15 MHz / 16QAM - RB Size 75

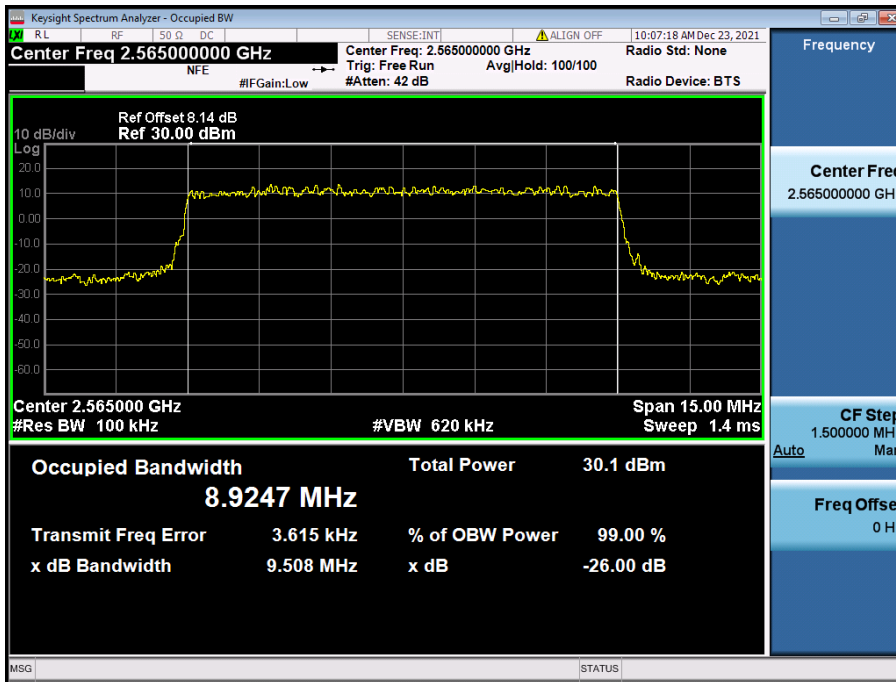

LTE Band 7 / 10 MHz / QPSK - RB Size 50

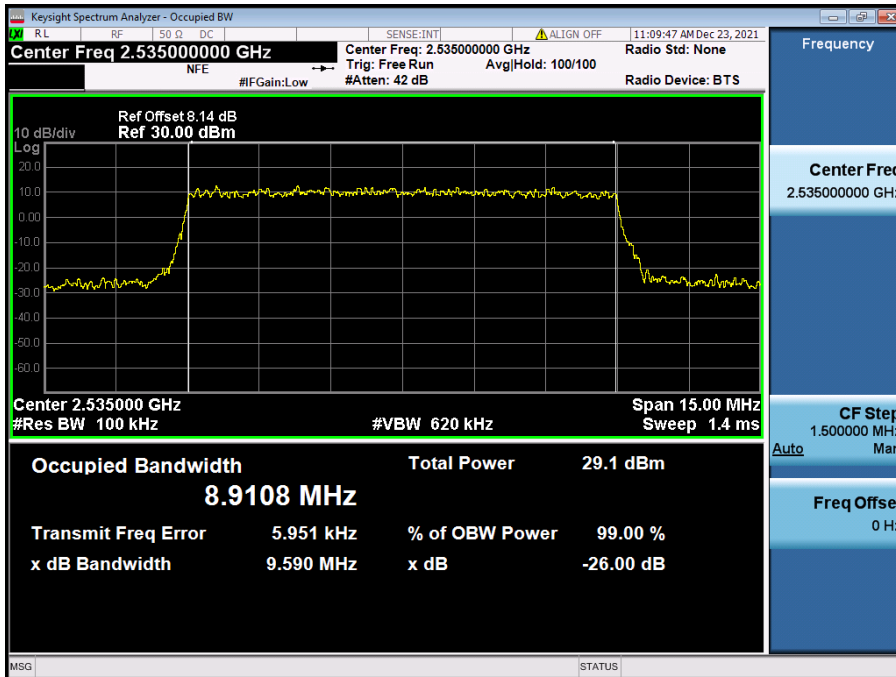

LTE Band 7 / 10 MHz / 16QAM - RB Size 50

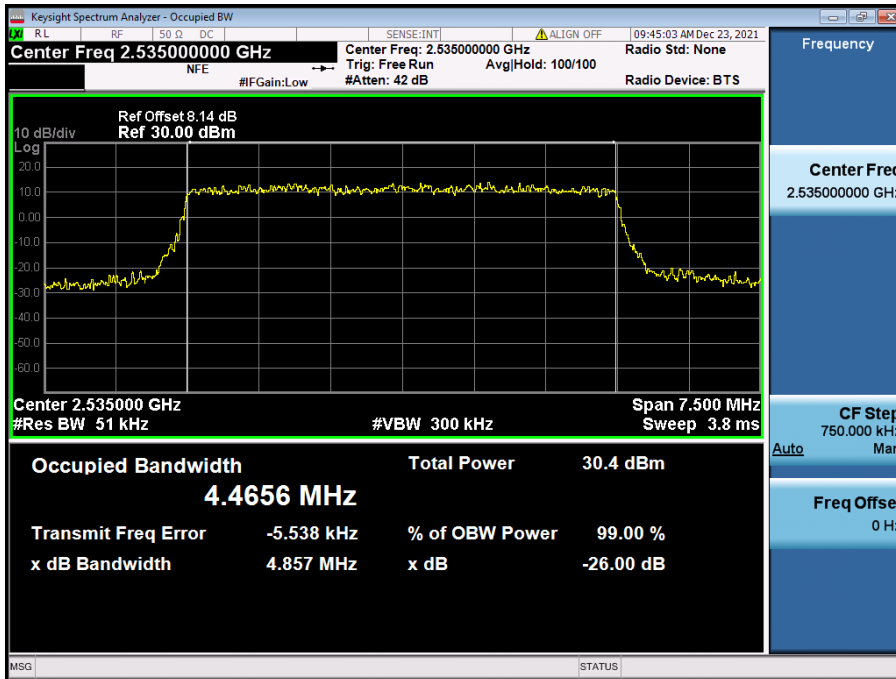

LTE Band 7 / 5 MHz / QPSK - RB Size 25

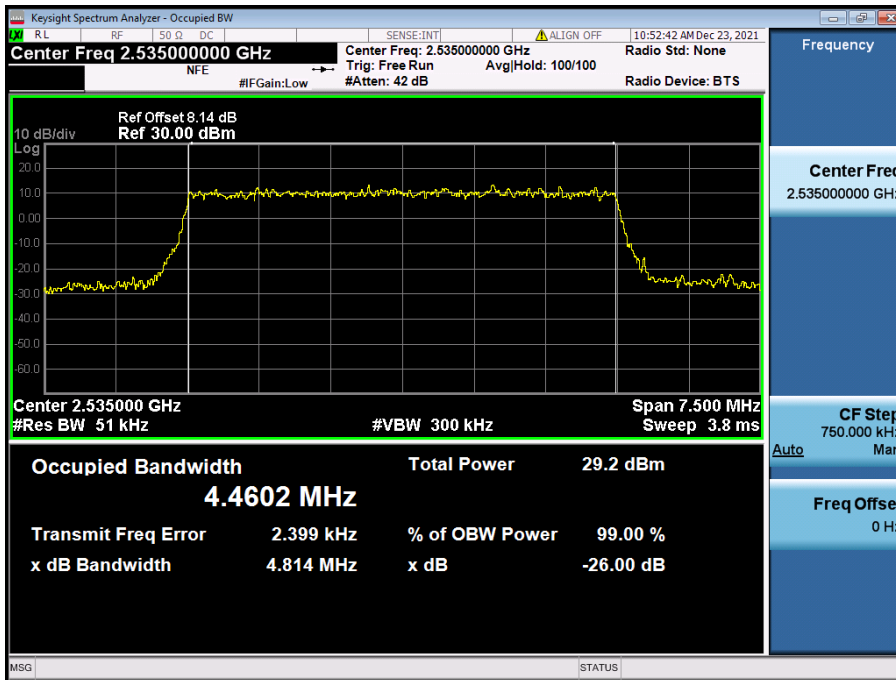

LTE Band 7 / 5 MHz / 16QAM - RB Size 25

8.2. PEAK TO AVERAGE RATIO

8.2.1. LTE Band 12

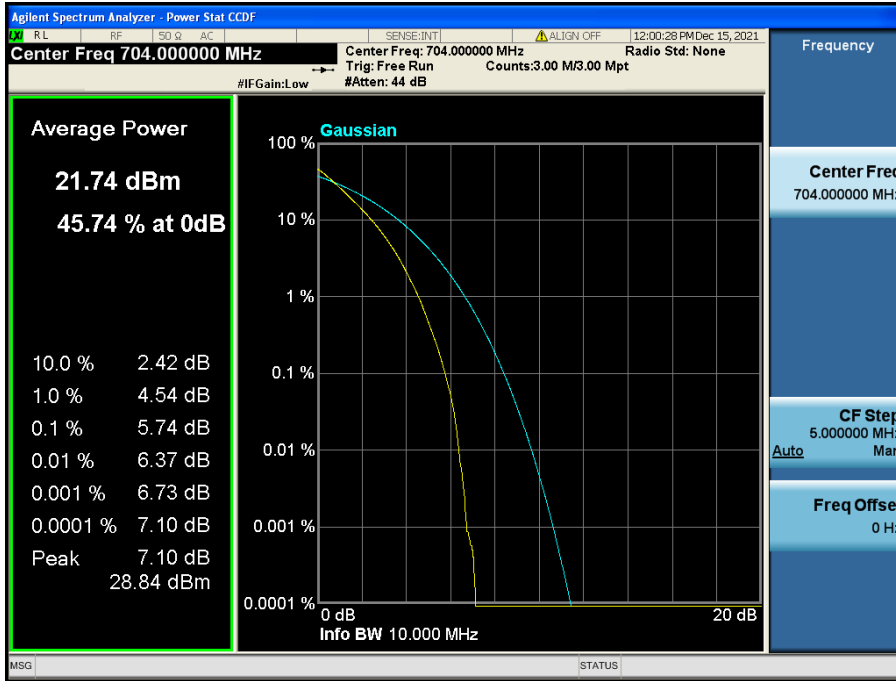

LTE Band 12 / 10 MHz / QPSK - RB Size 50

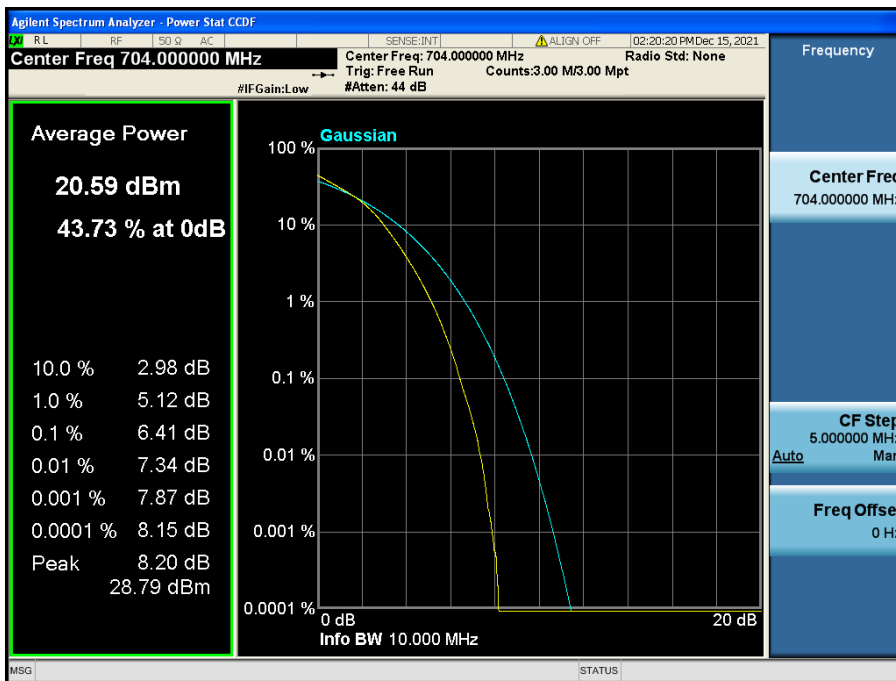

LTE Band 12 / 10 MHz / 16QAM - RB Size 50

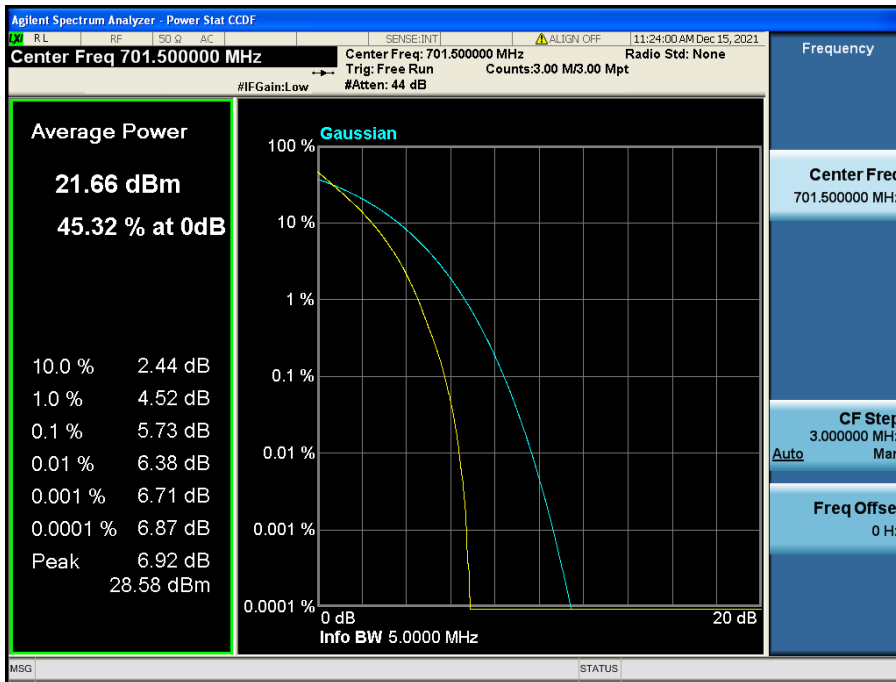

LTE Band 12 / 5 MHz / QPSK - RB Size 25

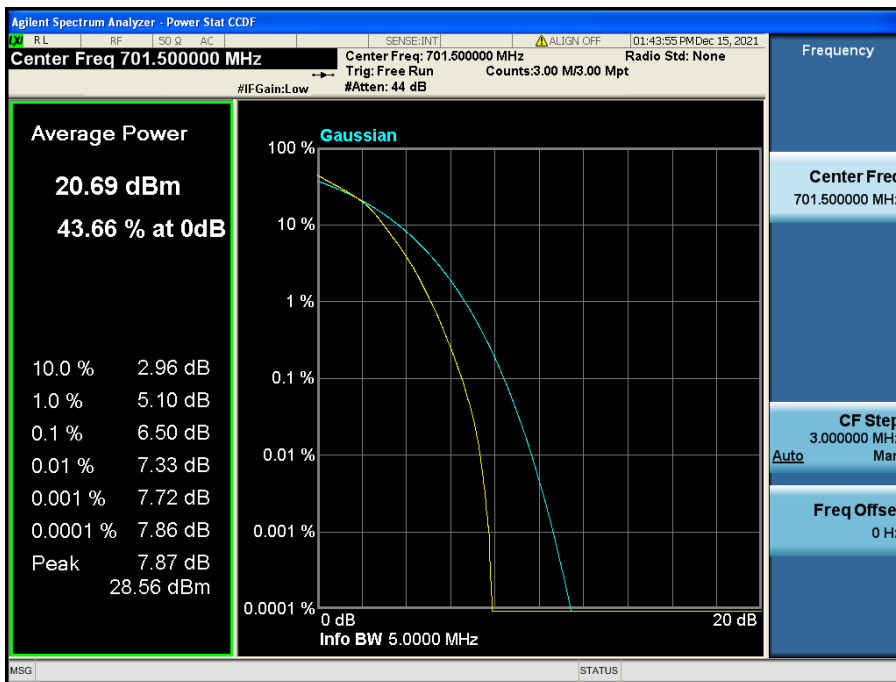

LTE Band 12 / 5 MHz / 16QAM - RB Size 25

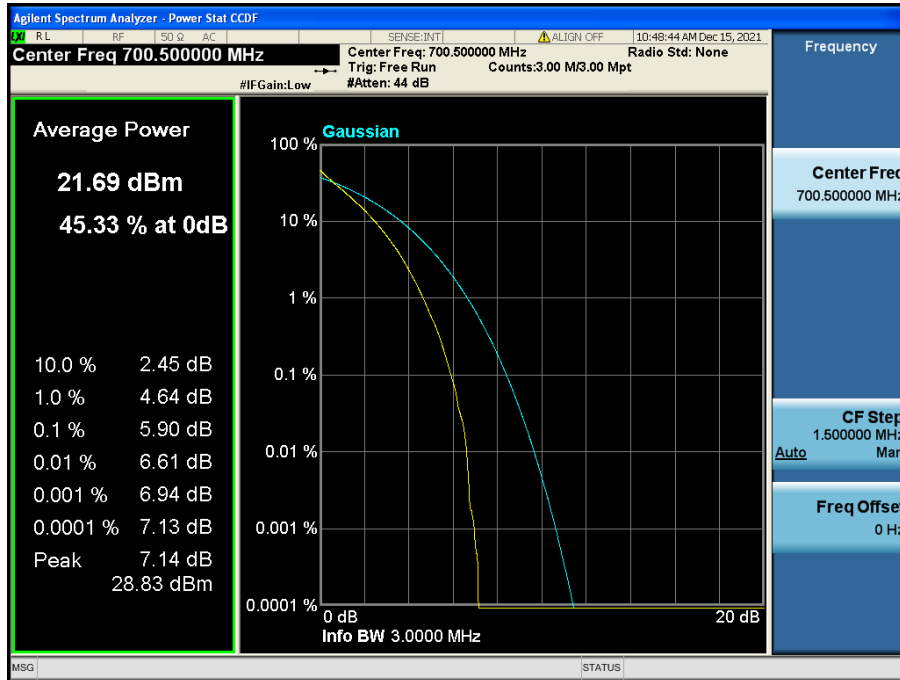

LTE Band 12 / 3 MHz / QPSK - RB Size 15

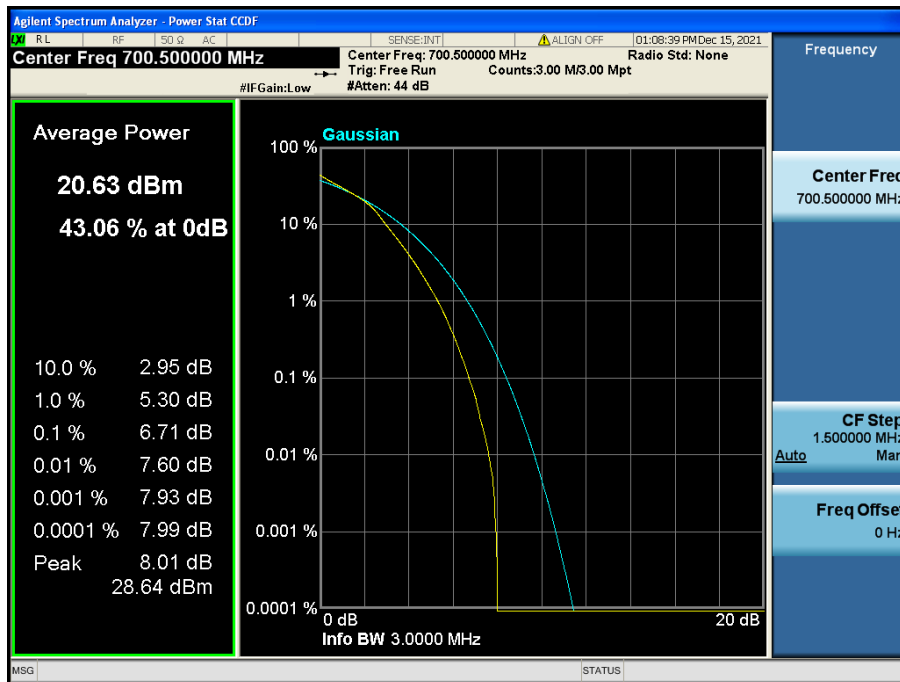

LTE Band 12 / 3 MHz / 16QAM - RB Size 15

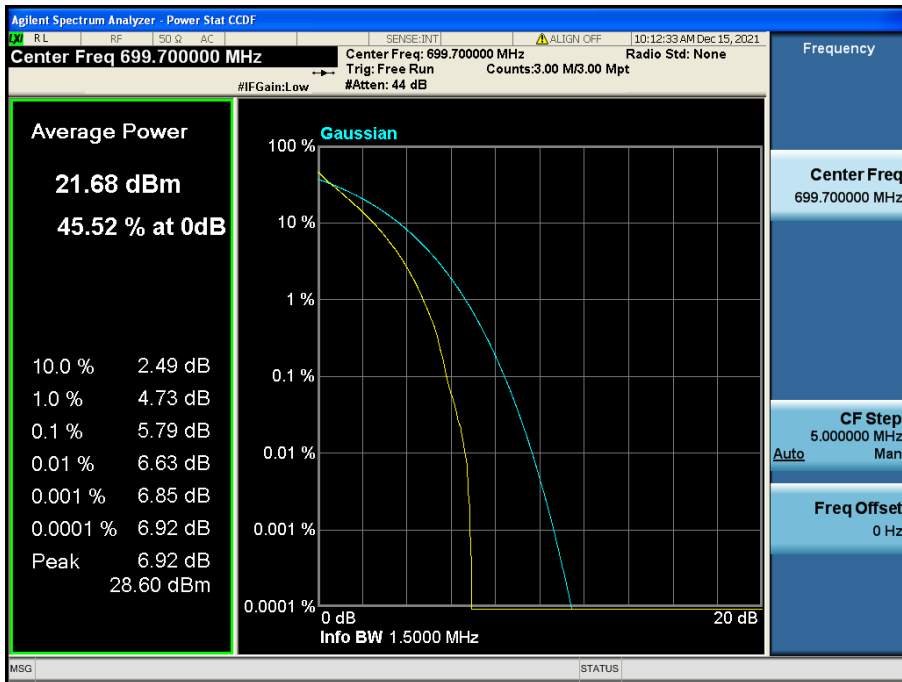

LTE Band 12 / 1.4 MHz / QPSK - RB Size 6

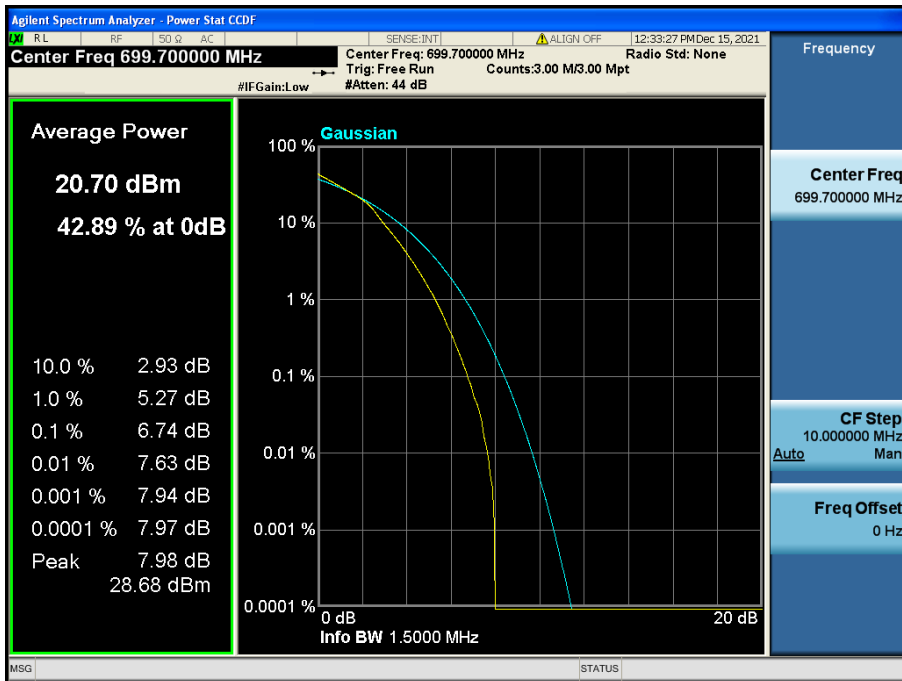

LTE Band 12 / 1.4 MHz / 16QAM - RB Size 6

8.2.2. LTE Band 17

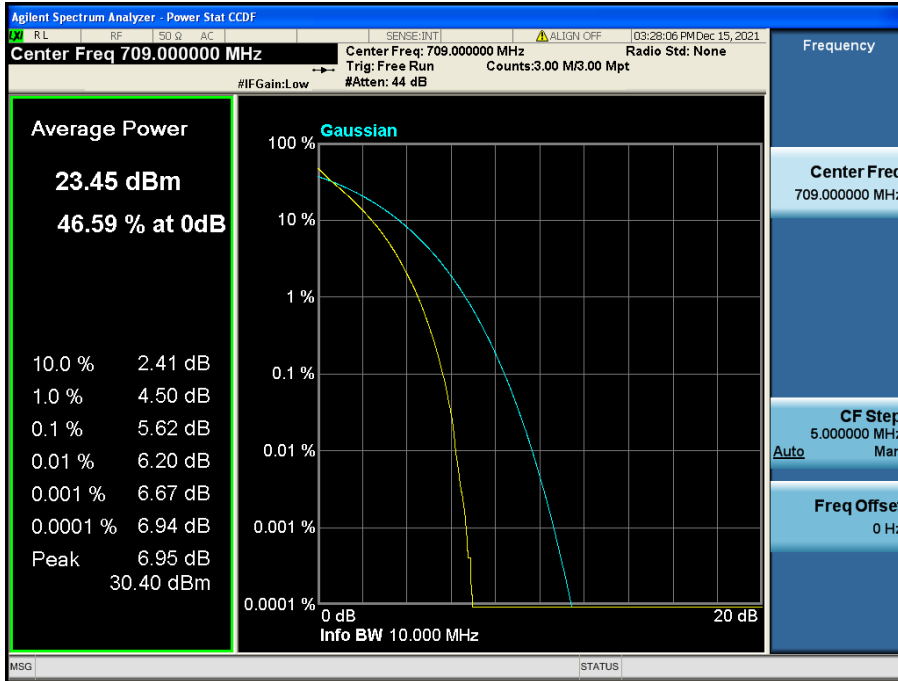

LTE Band 17 / 10 MHz / QPSK - RB Size 50

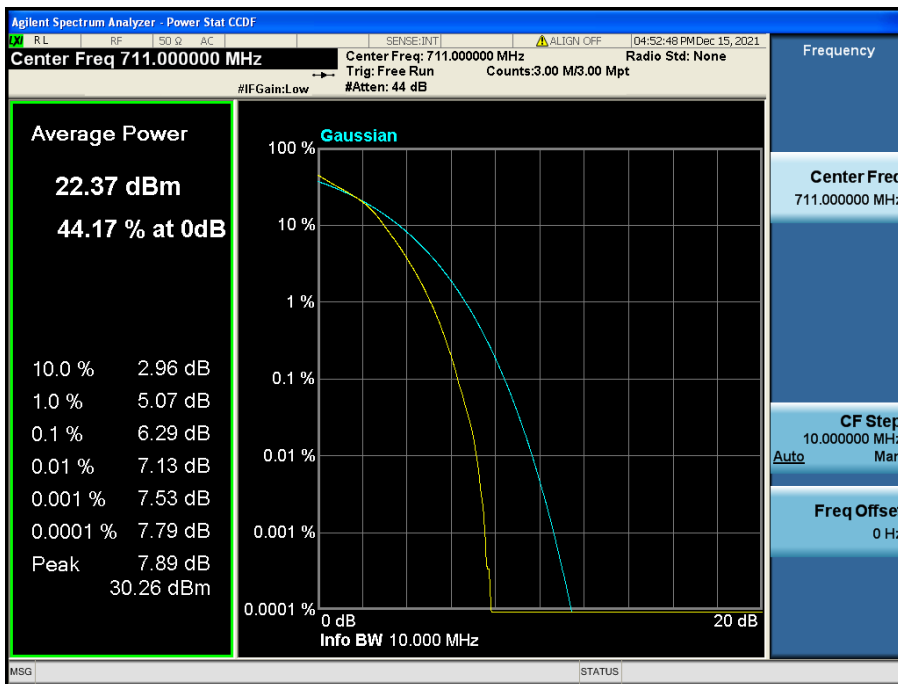

LTE Band 17 / 10 MHz / 16QAM - RB Size 50

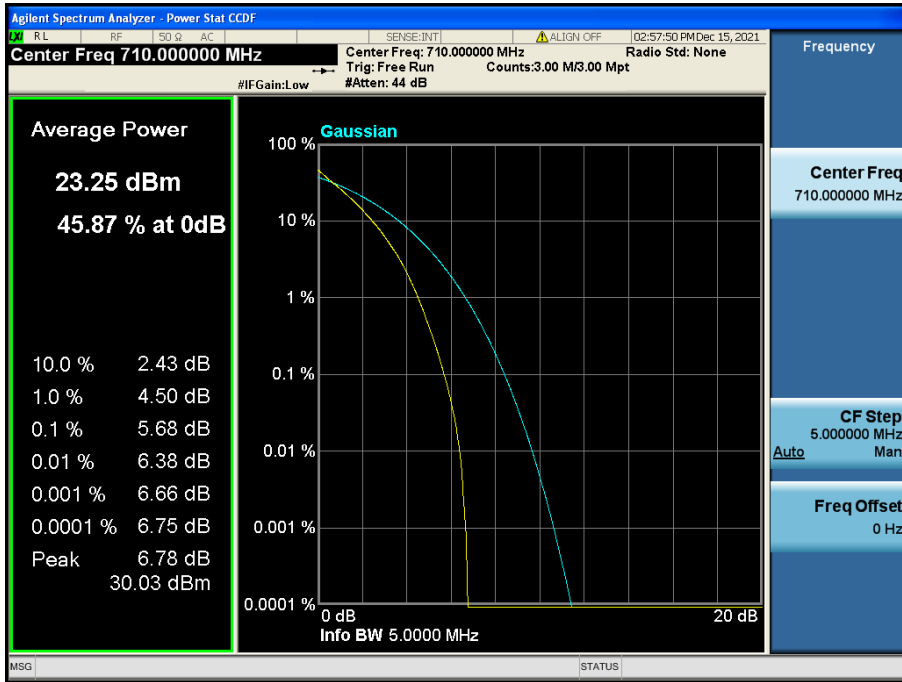

LTE Band 17 / 5 MHz / QPSK - RB Size 25

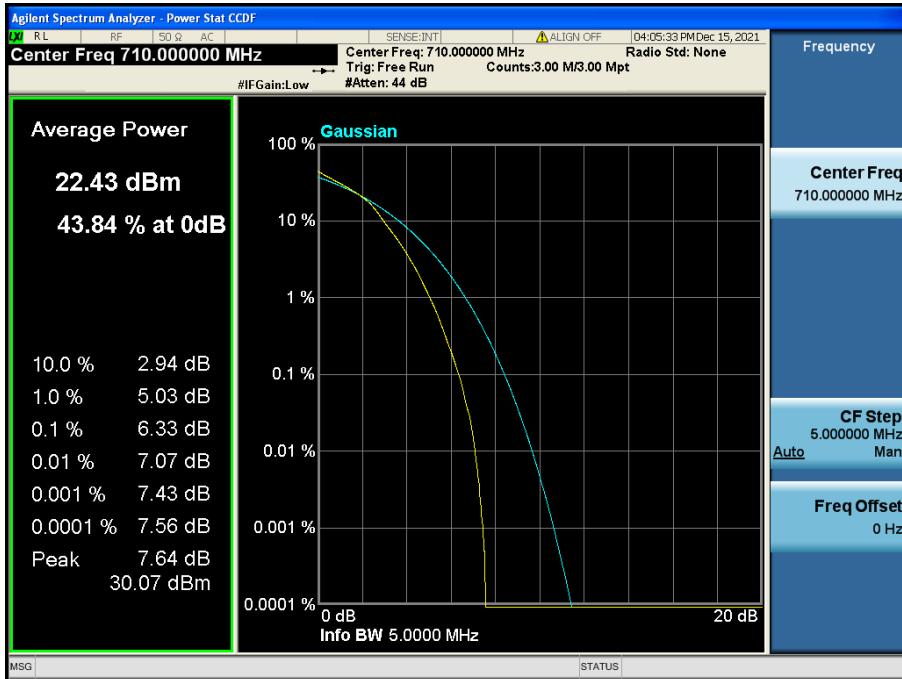

LTE Band 17 / 5 MHz / 16QAM - RB Size 25

8.2.3. LTE Band 5

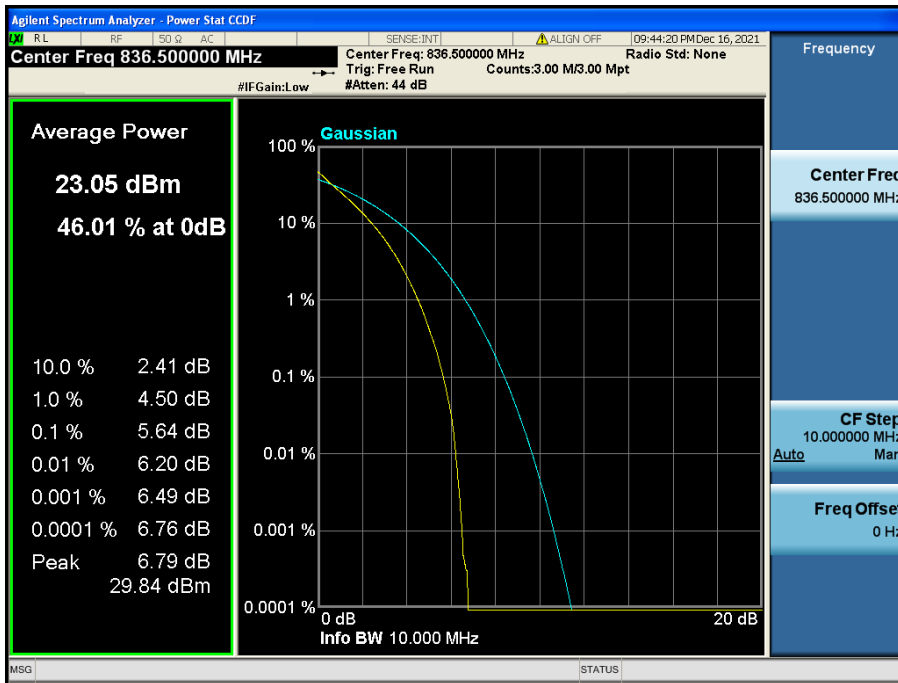

LTE Band 5 / 10 MHz / QPSK - RB Size 50

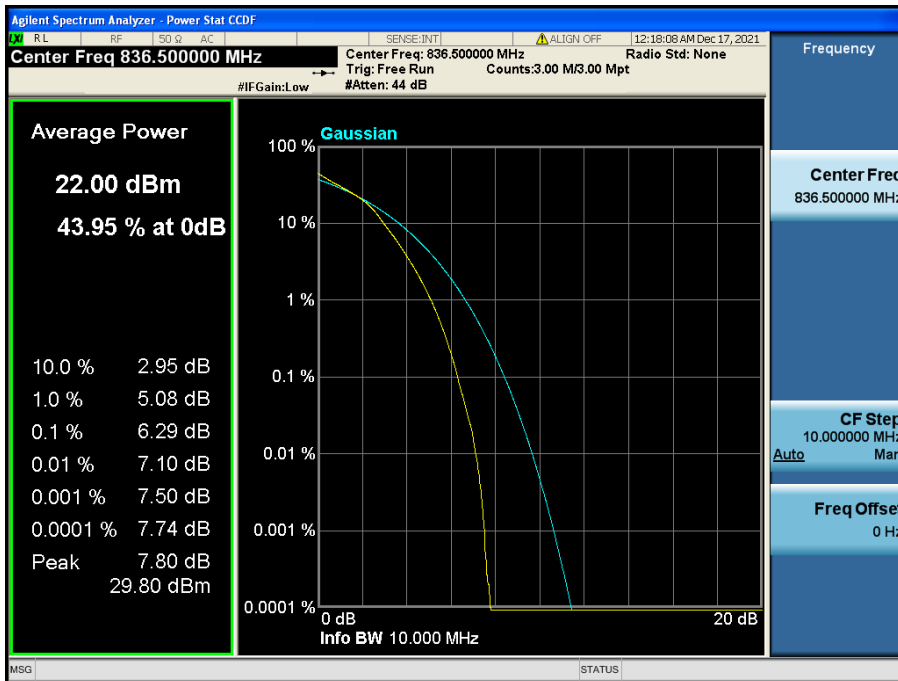

LTE Band 5 / 10 MHz / 16QAM - RB Size 50

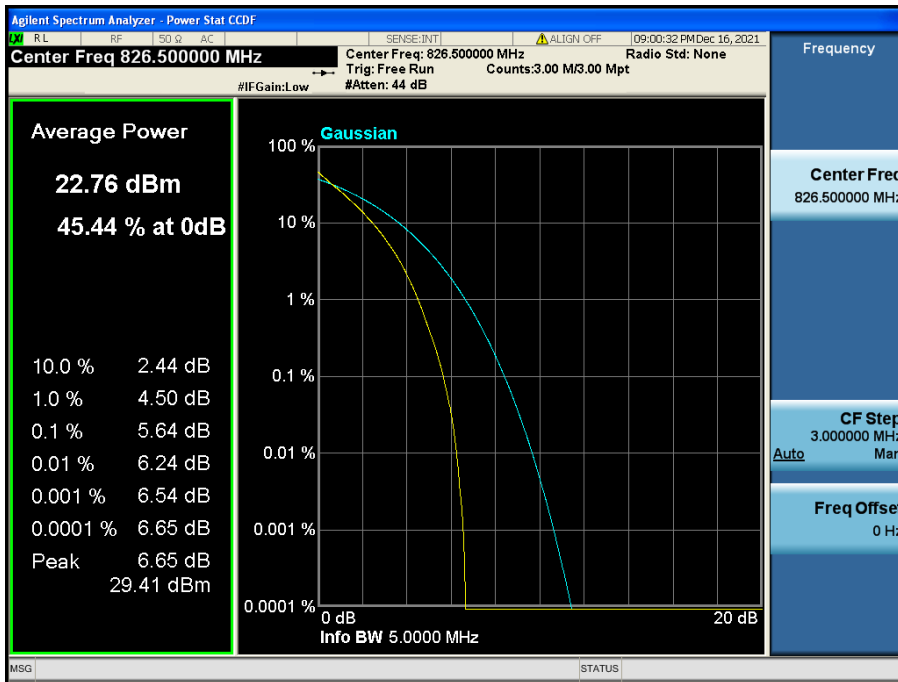

LTE Band 5 / 5 MHz / QPSK - RB Size 25

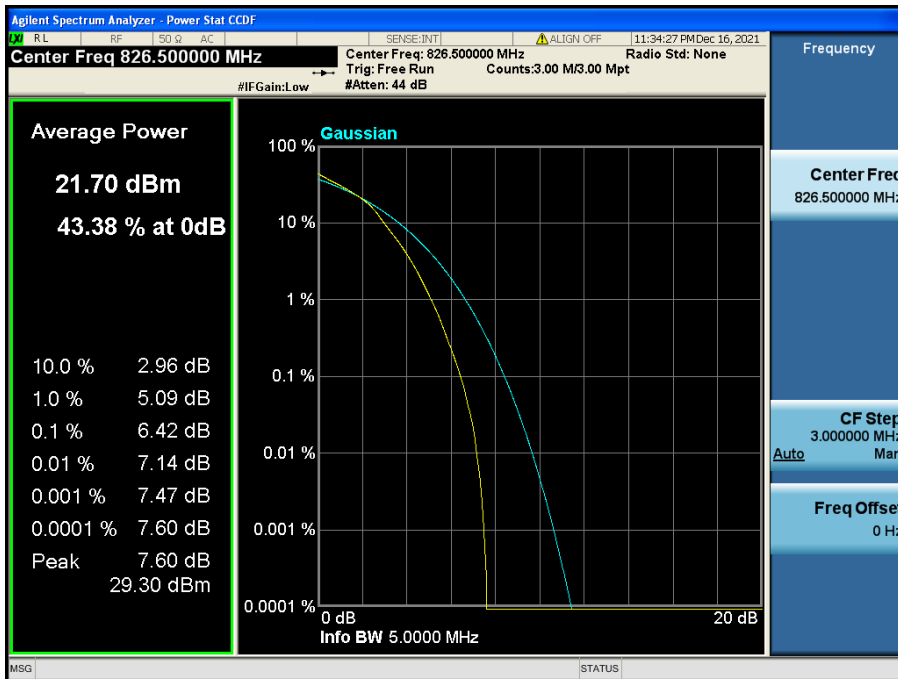

LTE Band 5 / 5 MHz / 16QAM - RB Size 25

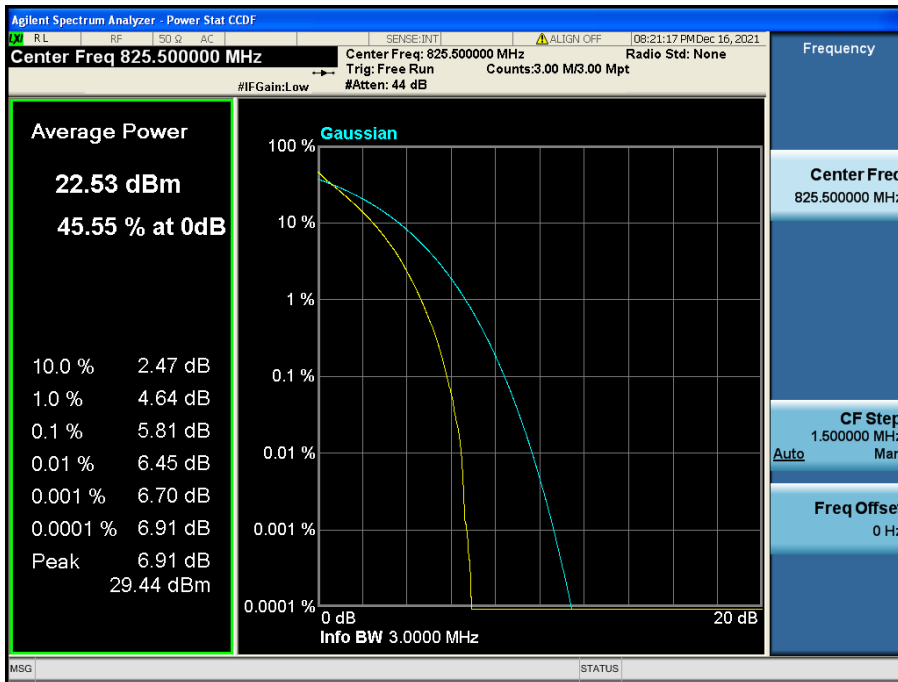

LTE Band 5 / 3 MHz / QPSK - RB Size 15

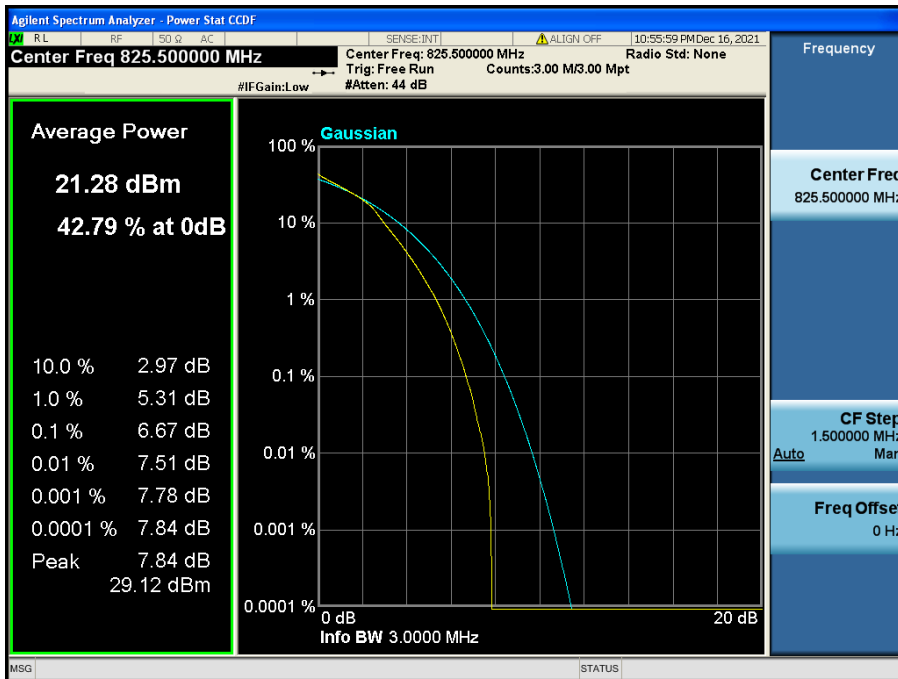

LTE Band 5 / 3 MHz / 16QAM - RB Size 15

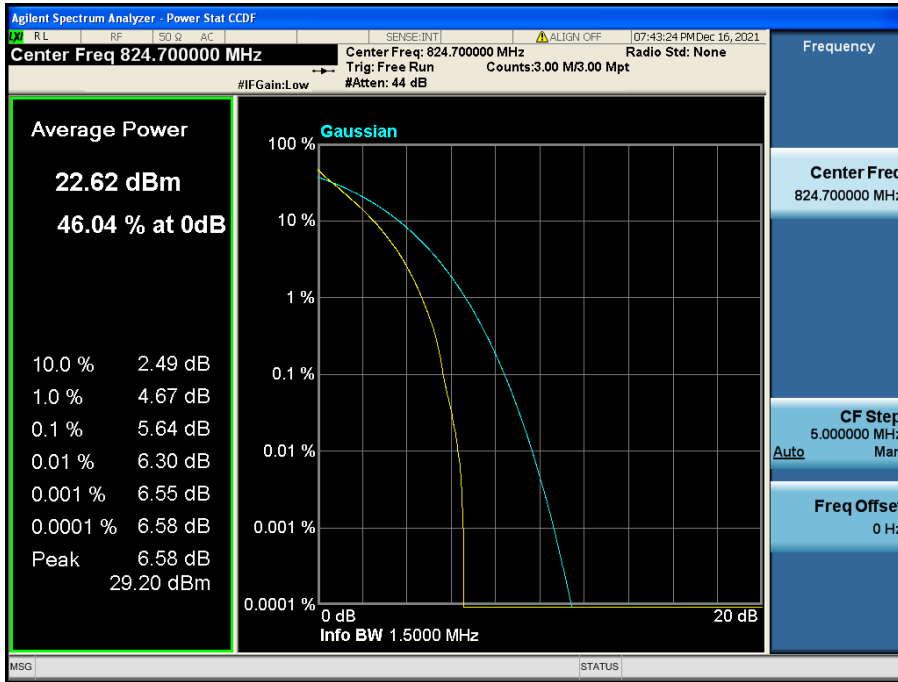

LTE Band 5 / 1.4 MHz / QPSK - RB Size 6

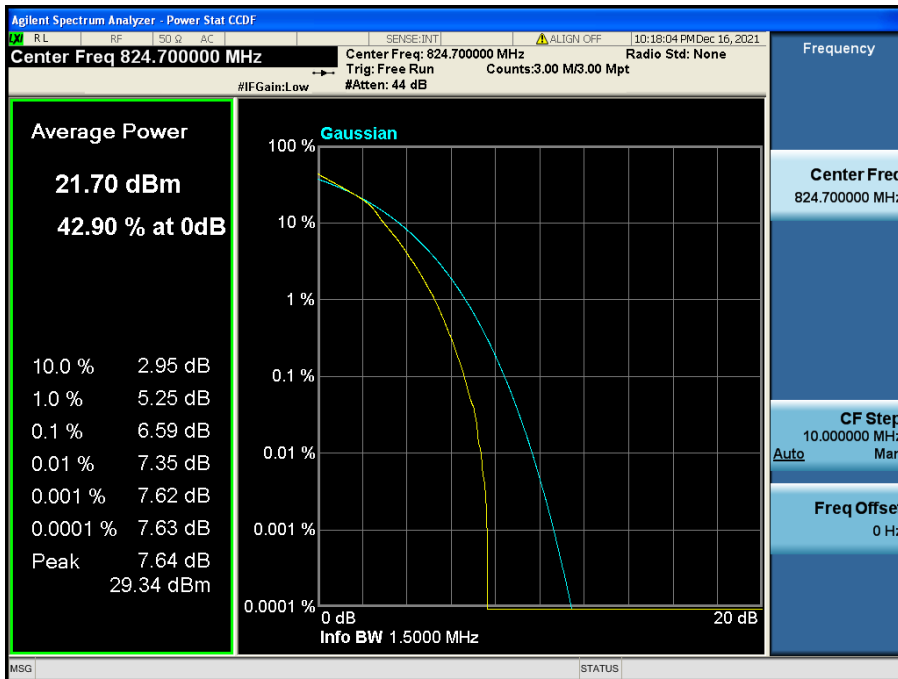

LTE Band 5 / 1.4 MHz / 16QAM - RB Size 6

8.2.4. LTE Band 25(2)

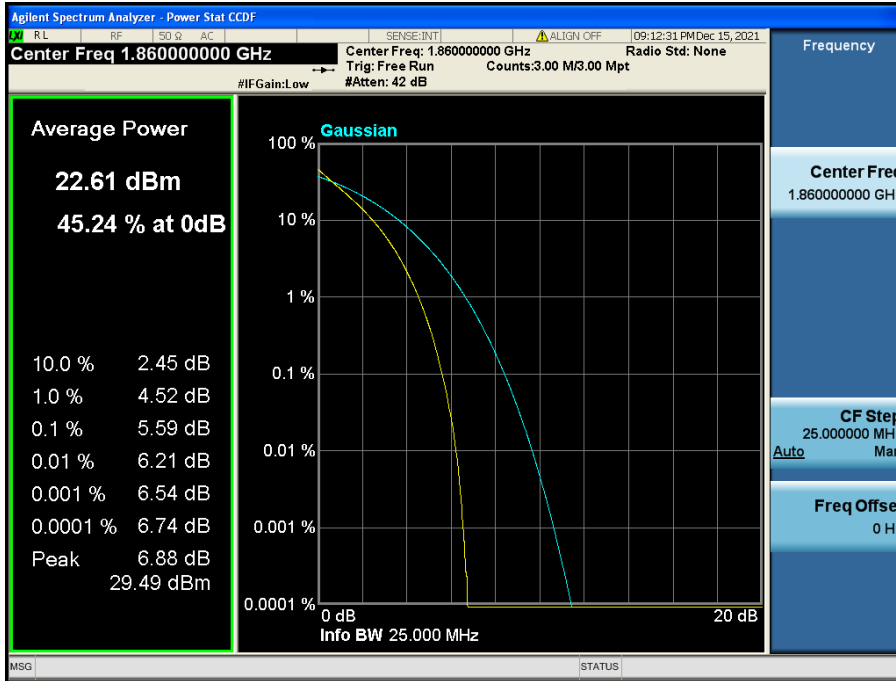

LTE Band 25(2) / 20 MHz / QPSK - RB Size 100

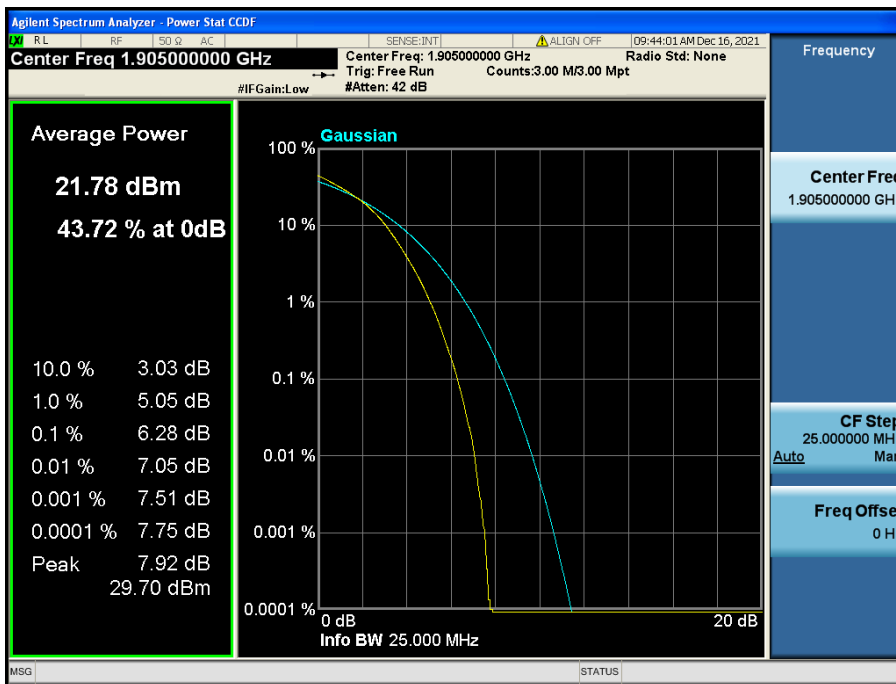

LTE Band 25(2) / 20 MHz / 16QAM - RB Size 100

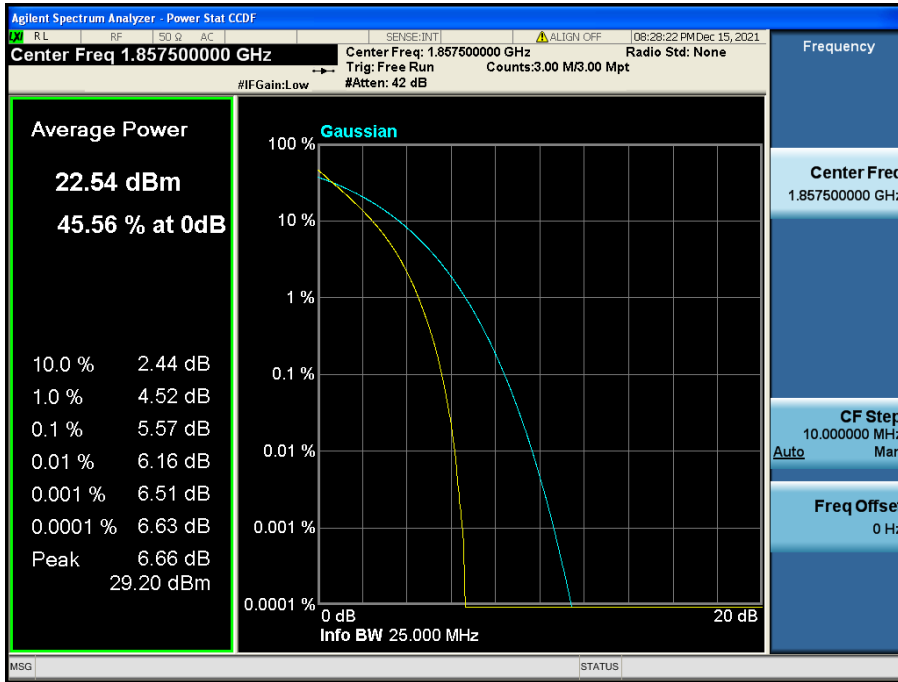

LTE Band 25(2) / 15 MHz / QPSK - RB Size 75

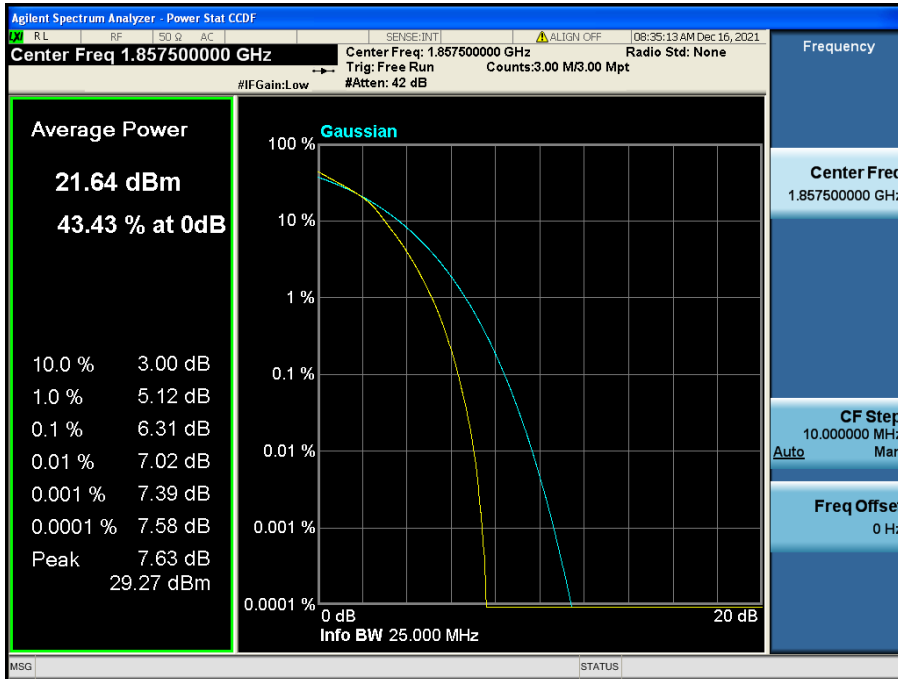

LTE Band 25(2) / 15 MHz / 16QAM - RB Size 75

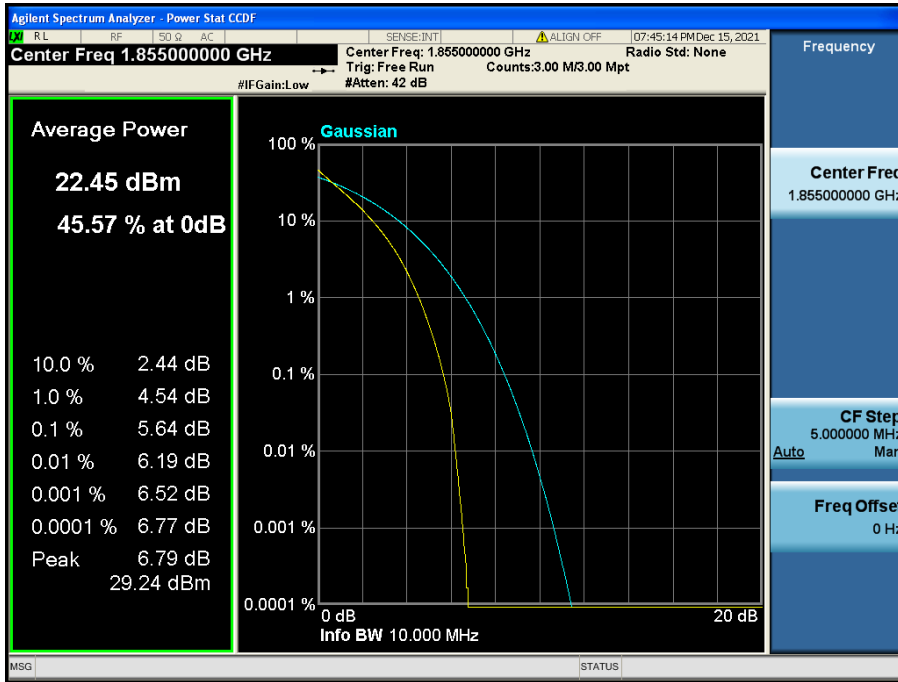

LTE Band 25(2) / 10 MHz / QPSK - RB Size 50

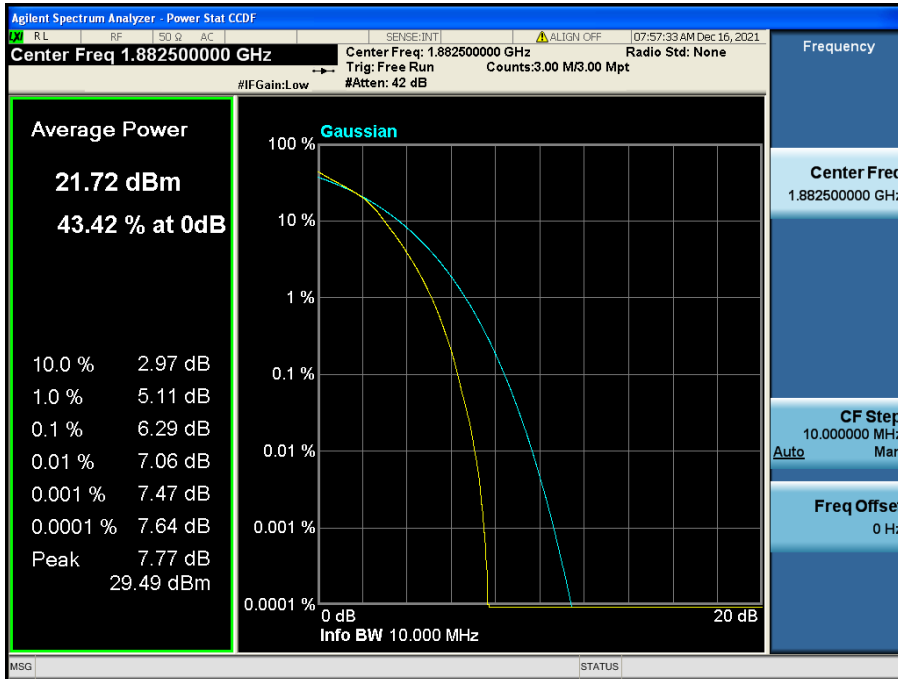

LTE Band 25(2) / 10 MHz / 16QAM - RB Size 50

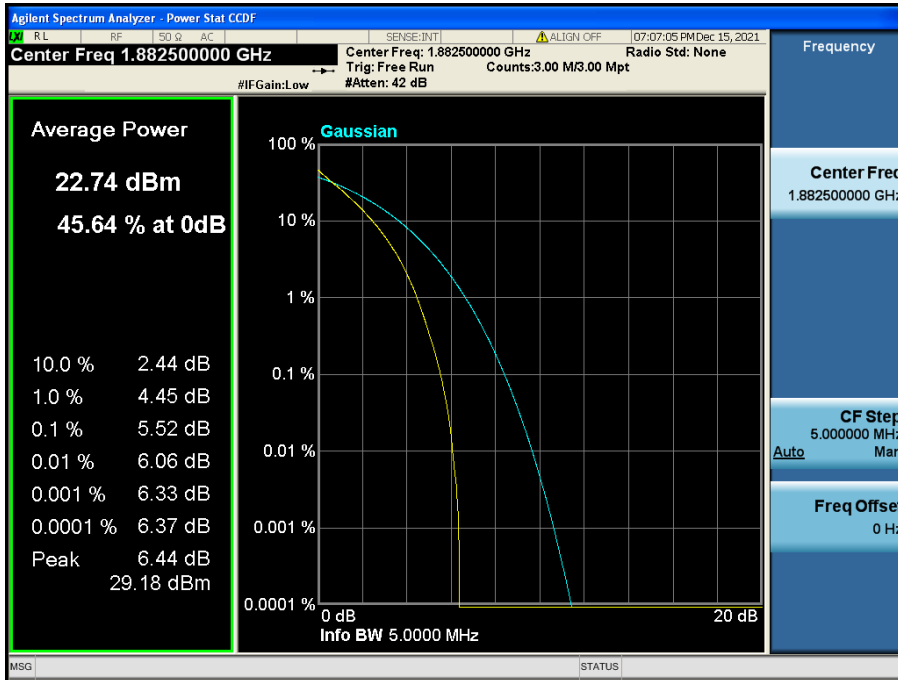

LTE Band 25(2) / 5 MHz / QPSK - RB Size 25

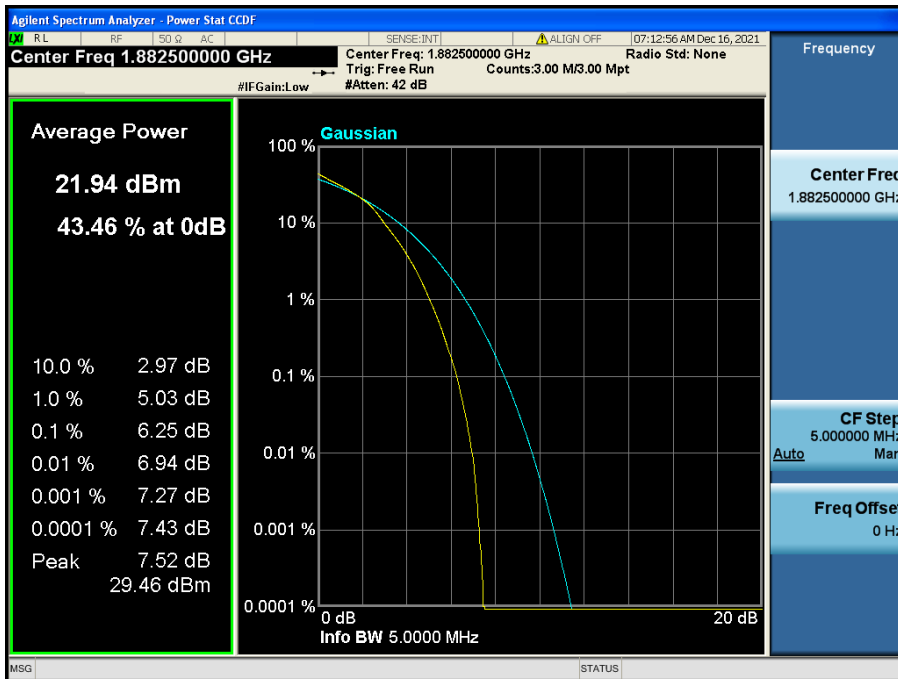

LTE Band 25(2) / 5 MHz / 16QAM - RB Size 25

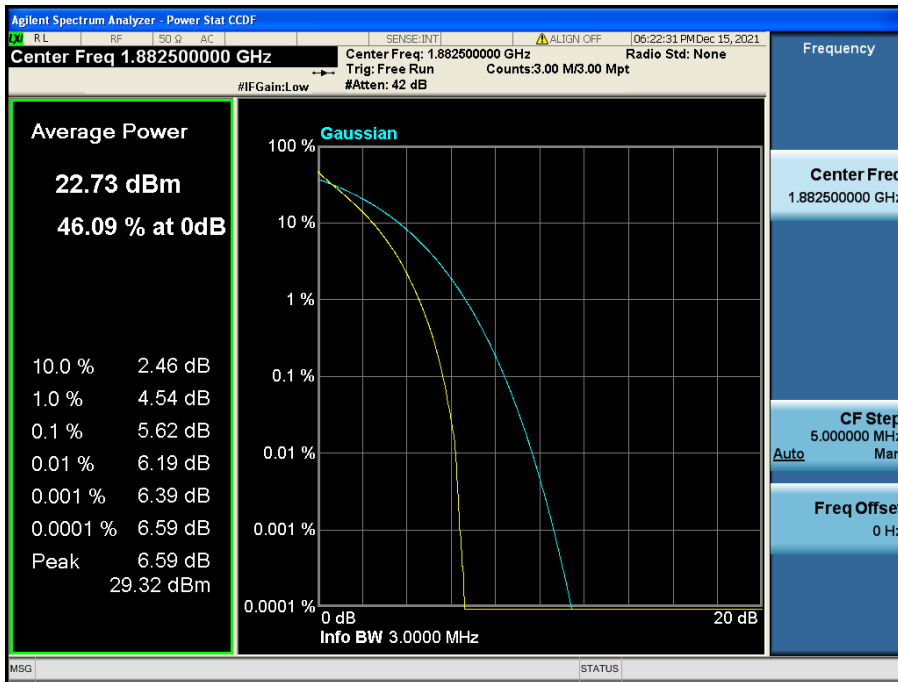

LTE Band 25(2) / 3 MHz / QPSK - RB Size 15

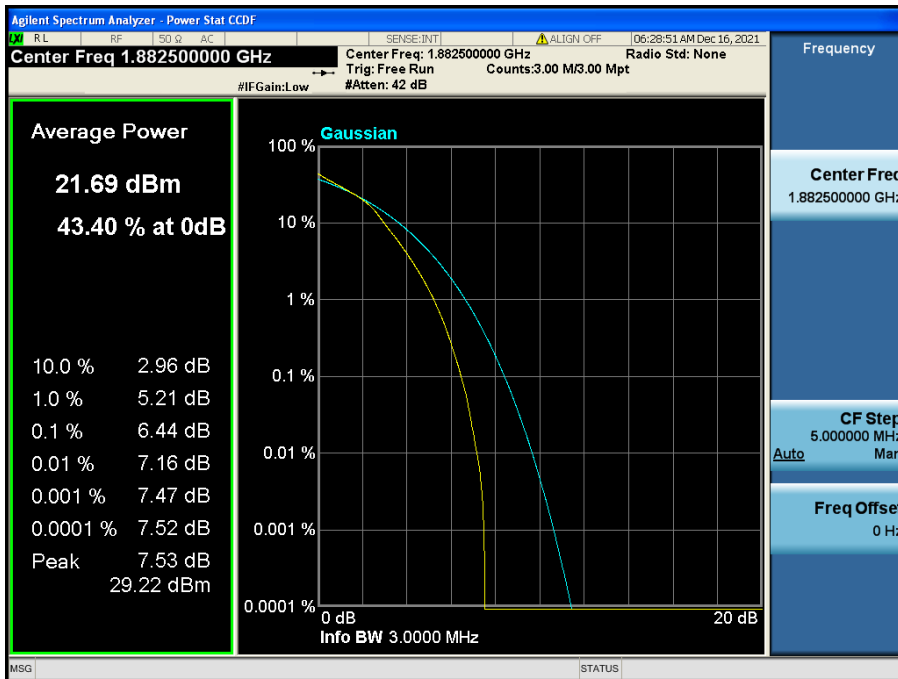

LTE Band 25(2) / 3 MHz / 16QAM - RB Size 15

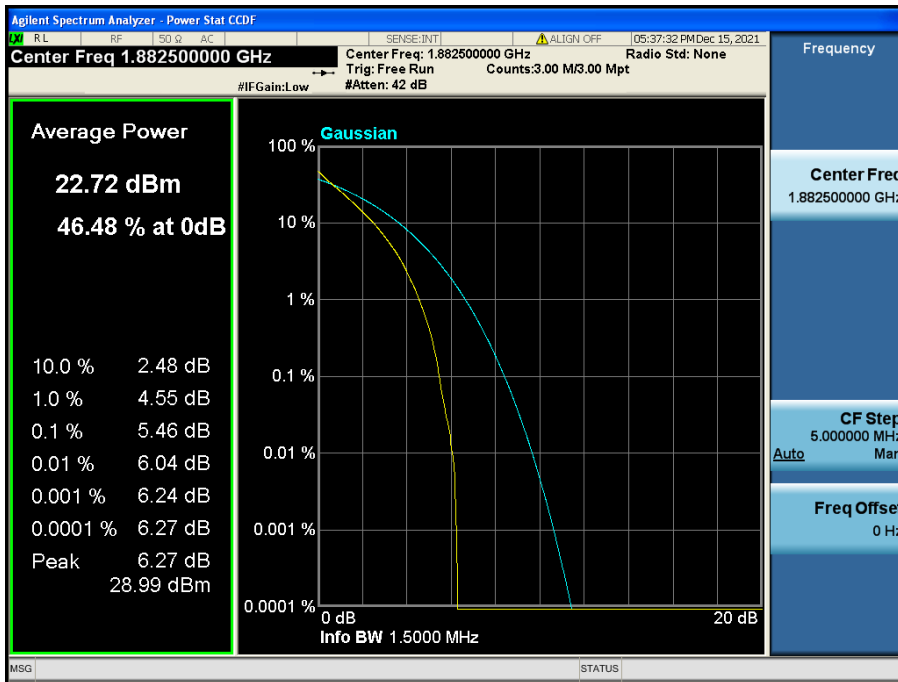

LTE Band 25(2) / 1.4 MHz / QPSK - RB Size 6

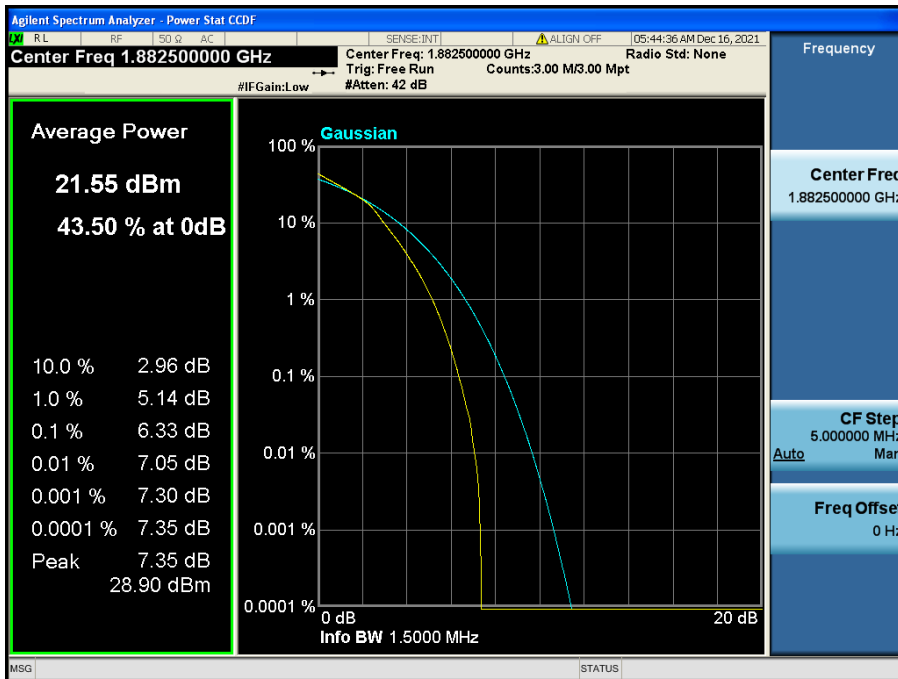

LTE Band 25(2) / 1.4 MHz / 16QAM - RB Size 6

8.2.5. LTE Band 41

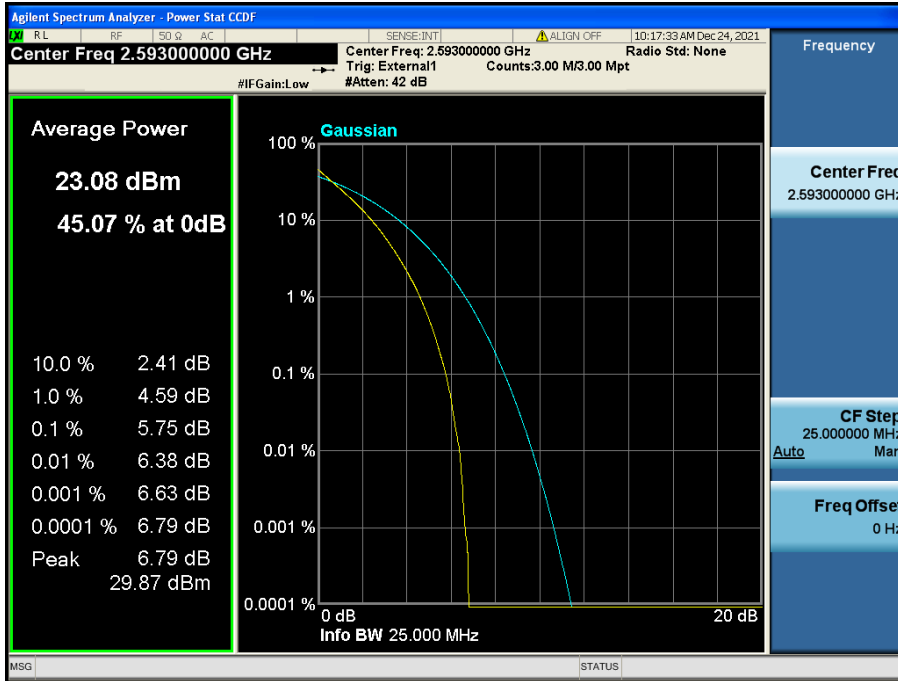

LTE Band 41 / 20 MHz / QPSK - RB Size 100

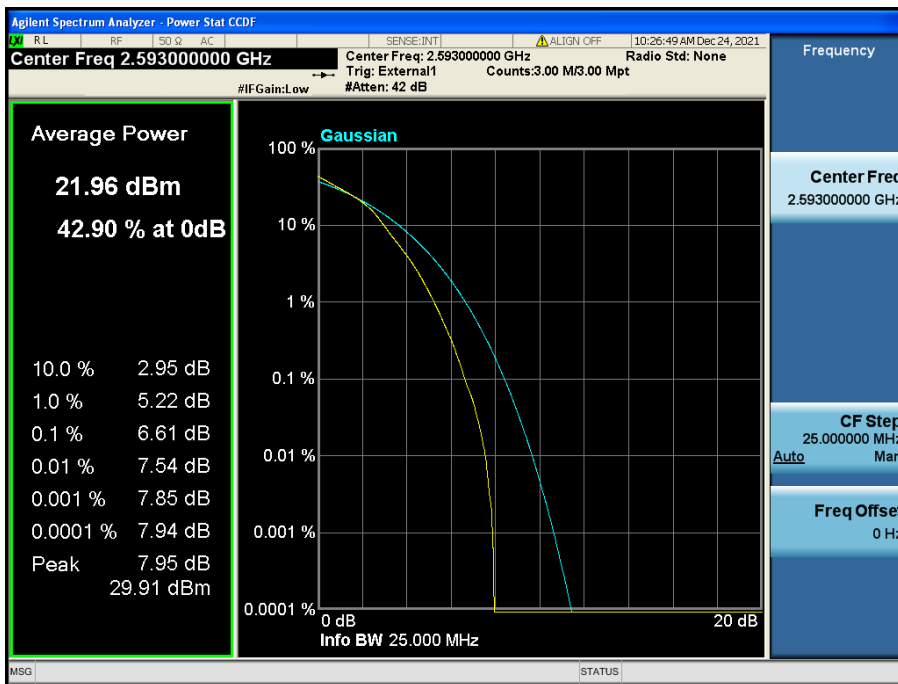

LTE Band 41 / 20 MHz / 16QAM - RB Size 100

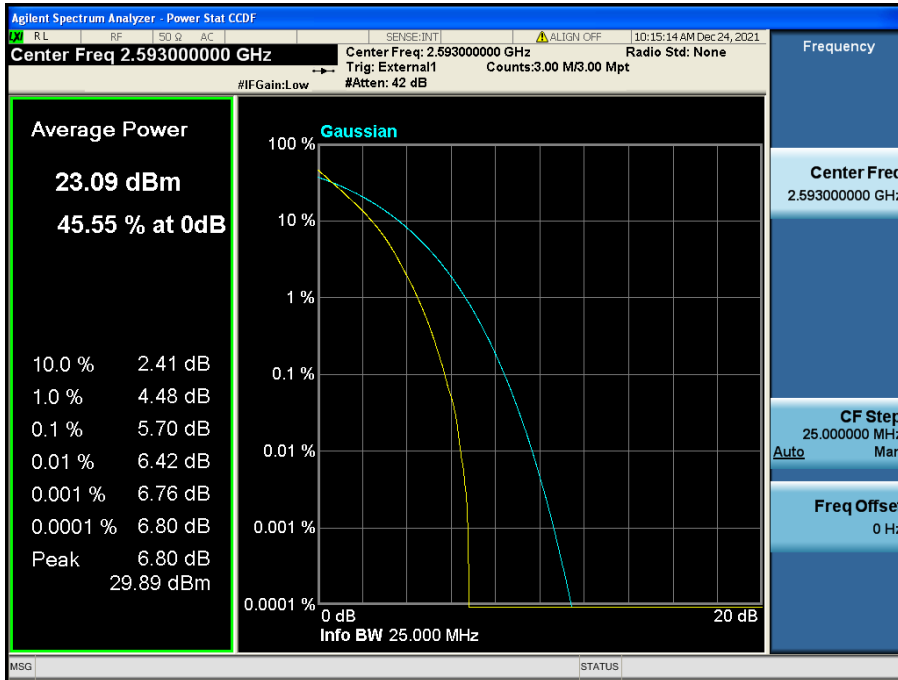

LTE Band 41 / 15 MHz / QPSK - RB Size 75

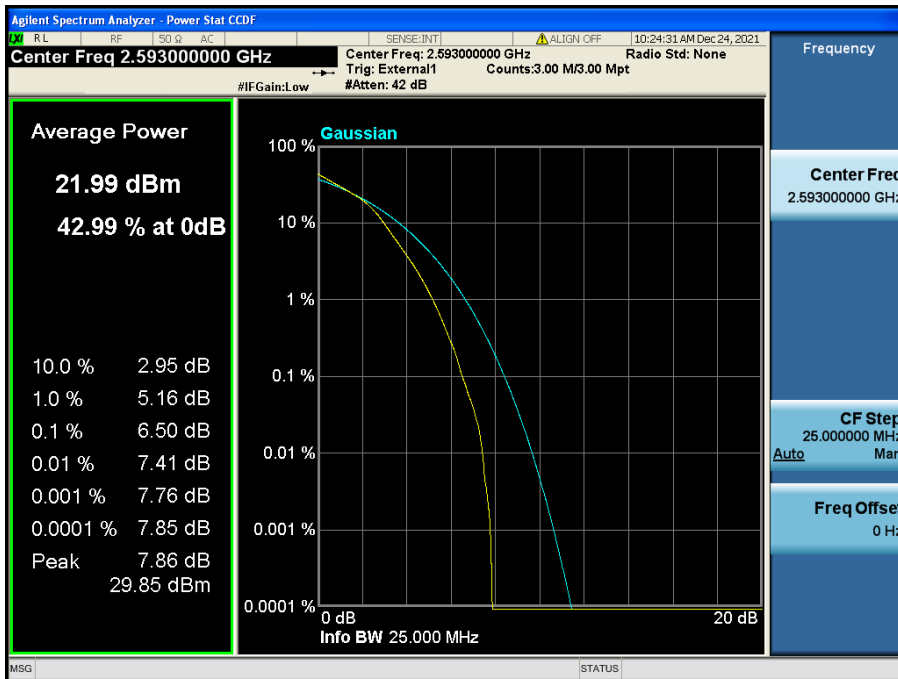

LTE Band 41 / 15 MHz / 16QAM - RB Size 75

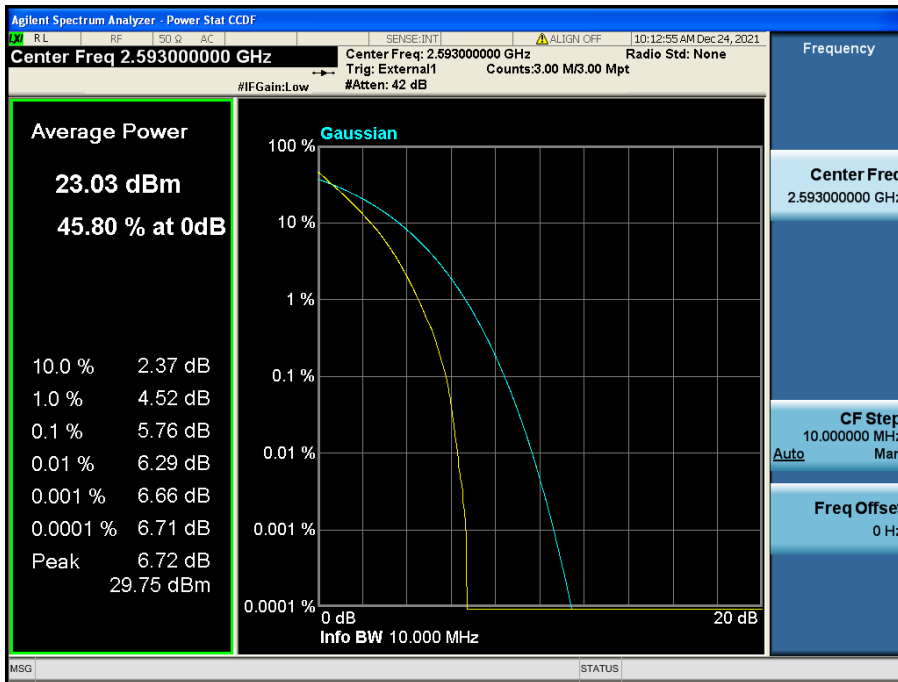

LTE Band 41 / 10 MHz / QPSK - RB Size 50

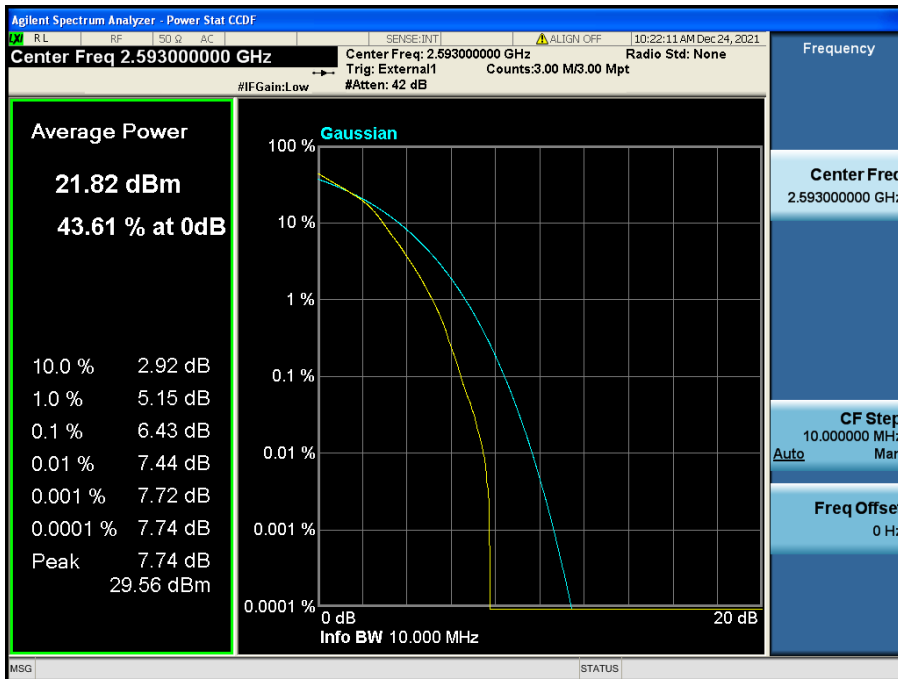

LTE Band 41 / 10 MHz / 16QAM - RB Size 50

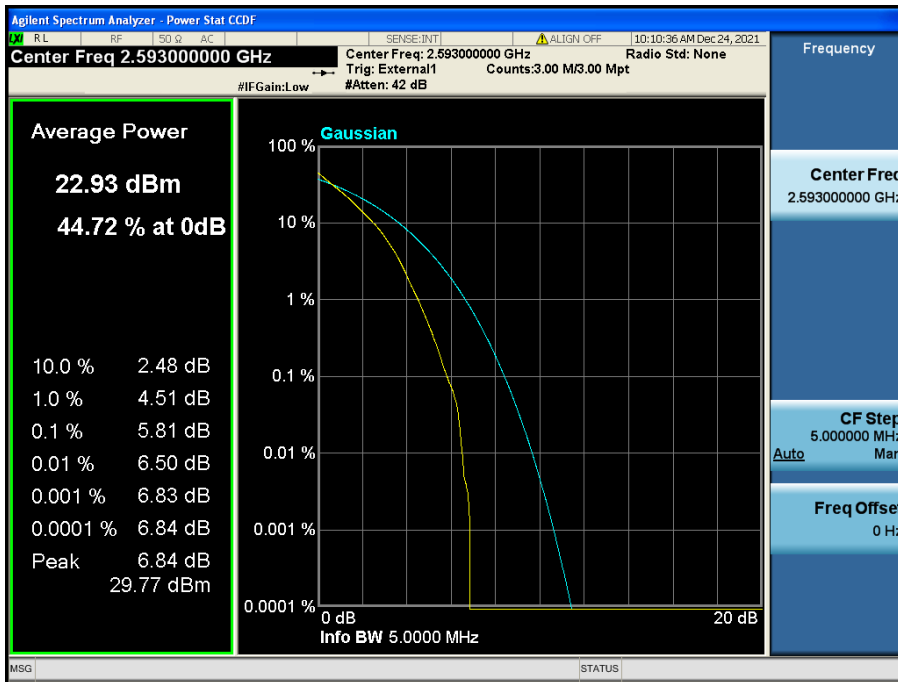

LTE Band 41 / 5 MHz / QPSK - RB Size 25

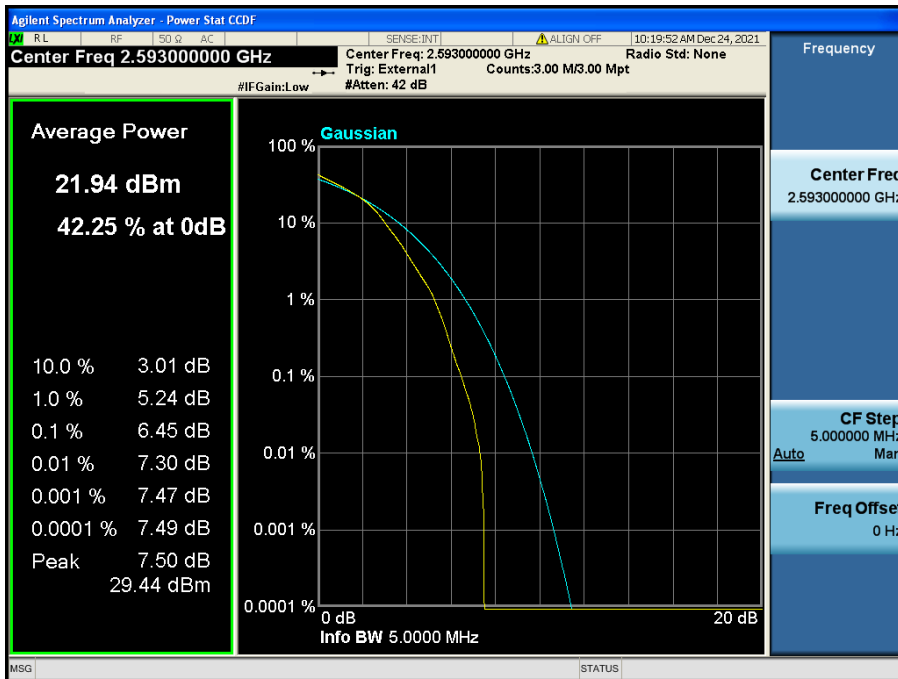

LTE Band 41 / 5 MHz / 16QAM - RB Size 25

8.2.6. LTE Band 7

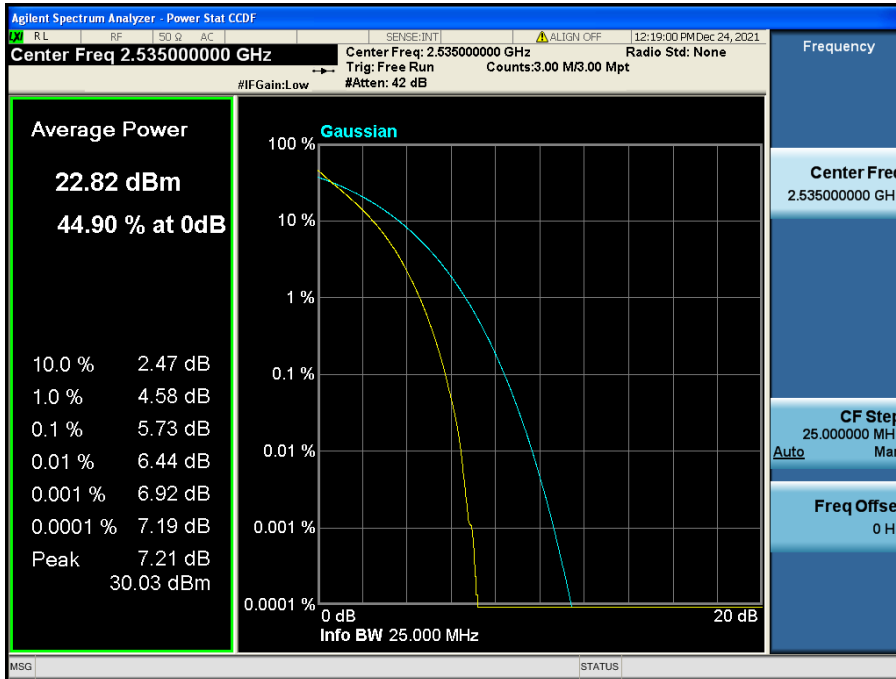

LTE Band 7 / 20 MHz / QPSK - RB Size 100

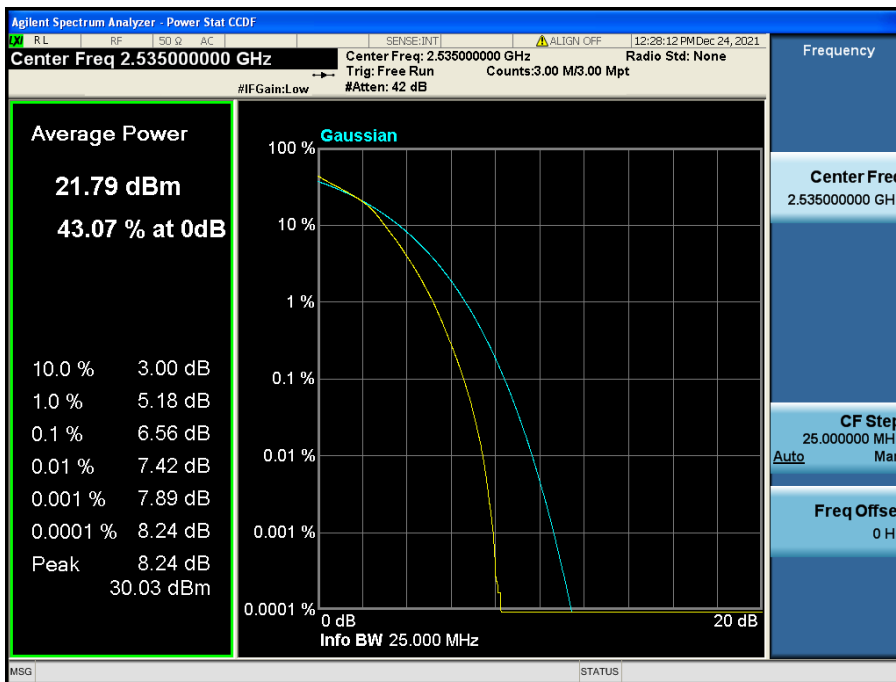

LTE Band 7 / 20 MHz / 16QAM - RB Size 100

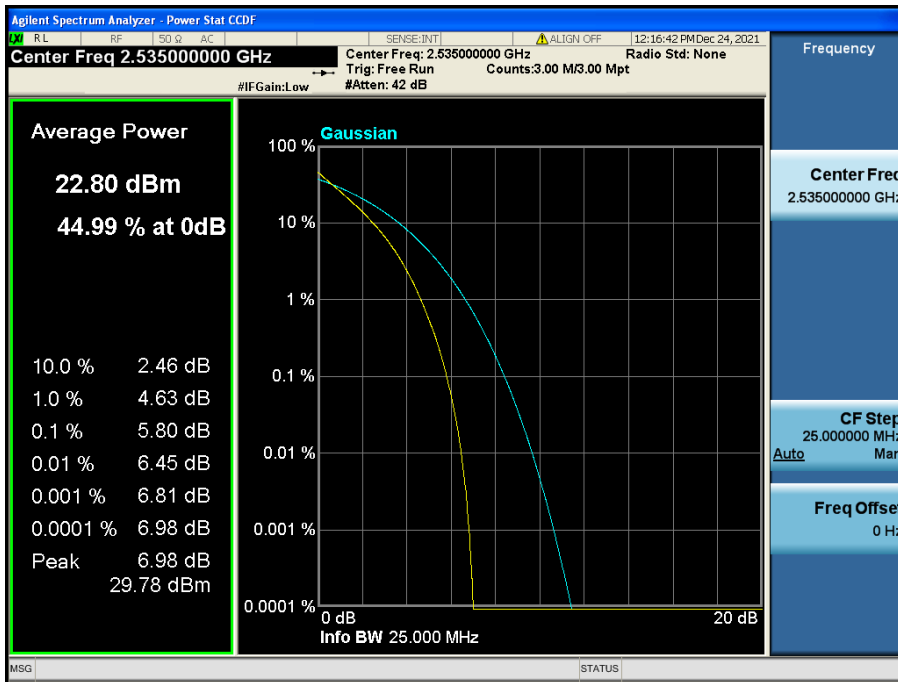

LTE Band 7 / 15 MHz / QPSK - RB Size 75

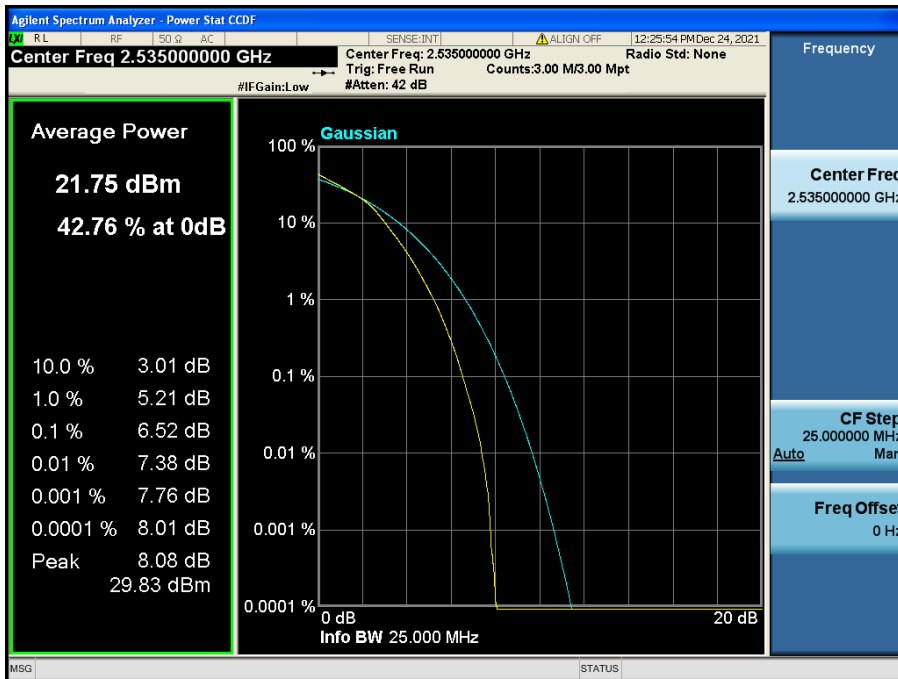

LTE Band 7 / 15 MHz / 16QAM - RB Size 75

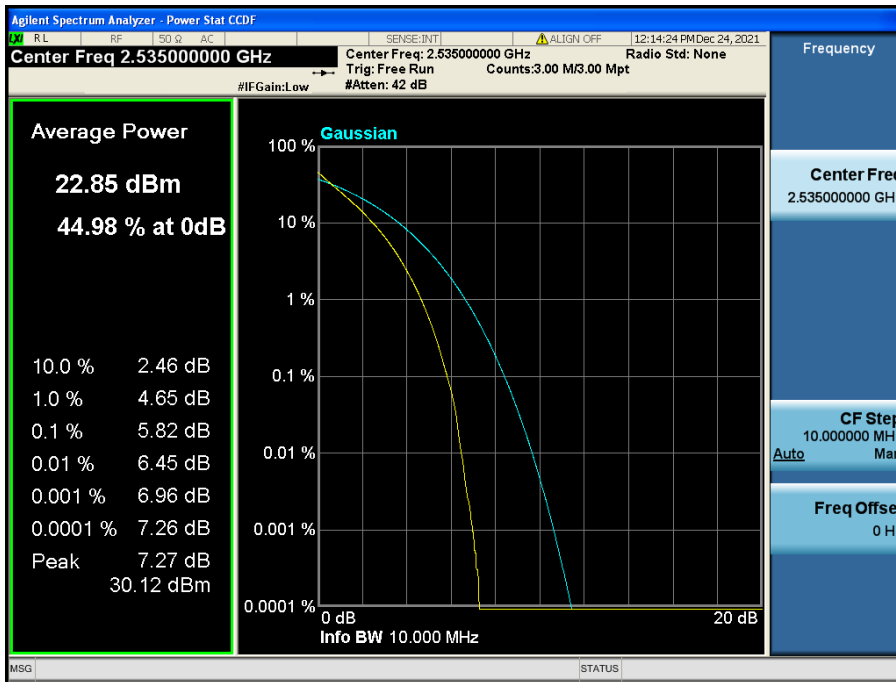

LTE Band 7 / 10 MHz / QPSK - RB Size 50

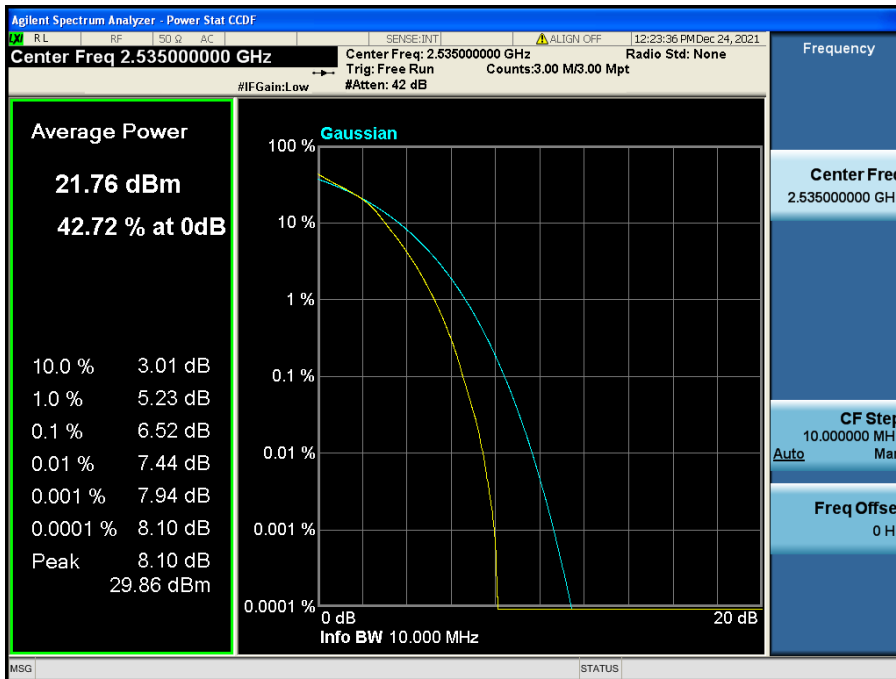

LTE Band 7 / 10 MHz / 16QAM - RB Size 50

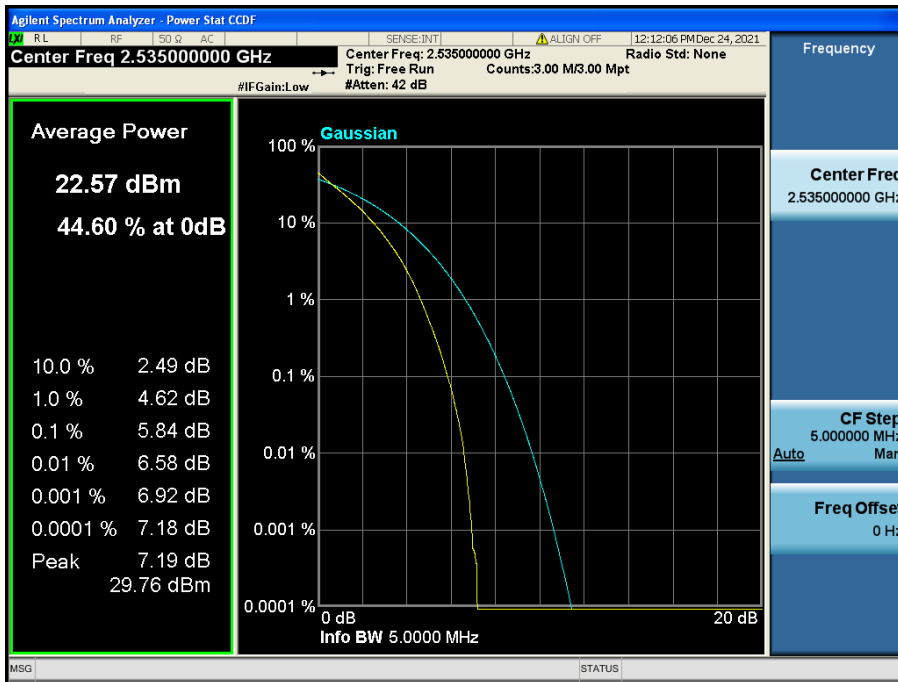

LTE Band 7 / 5 MHz / QPSK - RB Size 25

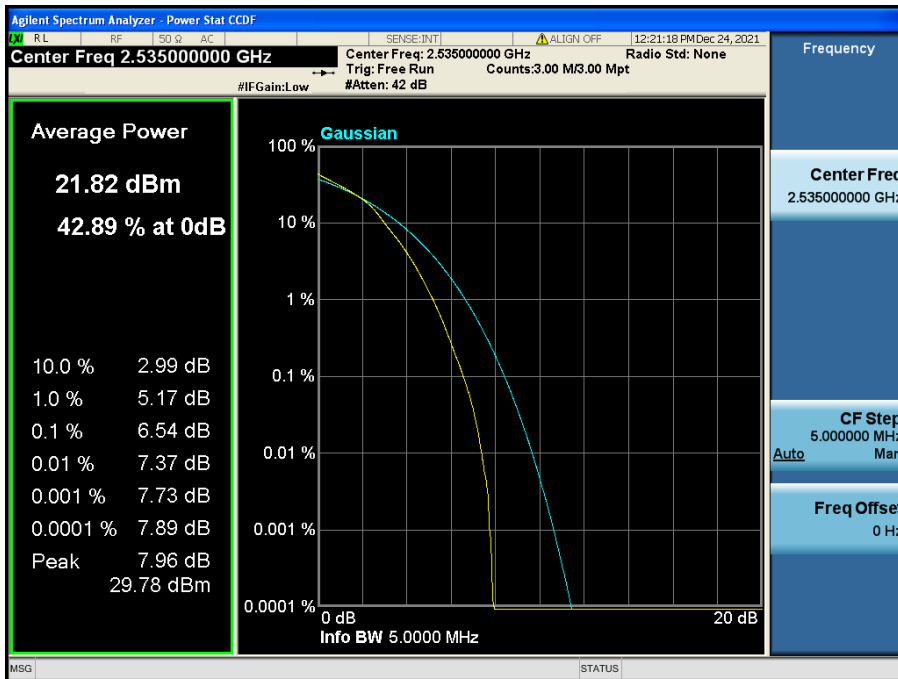

LTE Band 7 / 5 MHz / 16QAM - RB Size 25

8.3. BAND EDGE EMISSIONS(Conducted)

8.3.1. LTE Band 12

- Lower Band Edge



LTE Band 12 / 10 MHz / 16QAM - RB Size/Offset (25/0)

- Lower Extended Band Edge

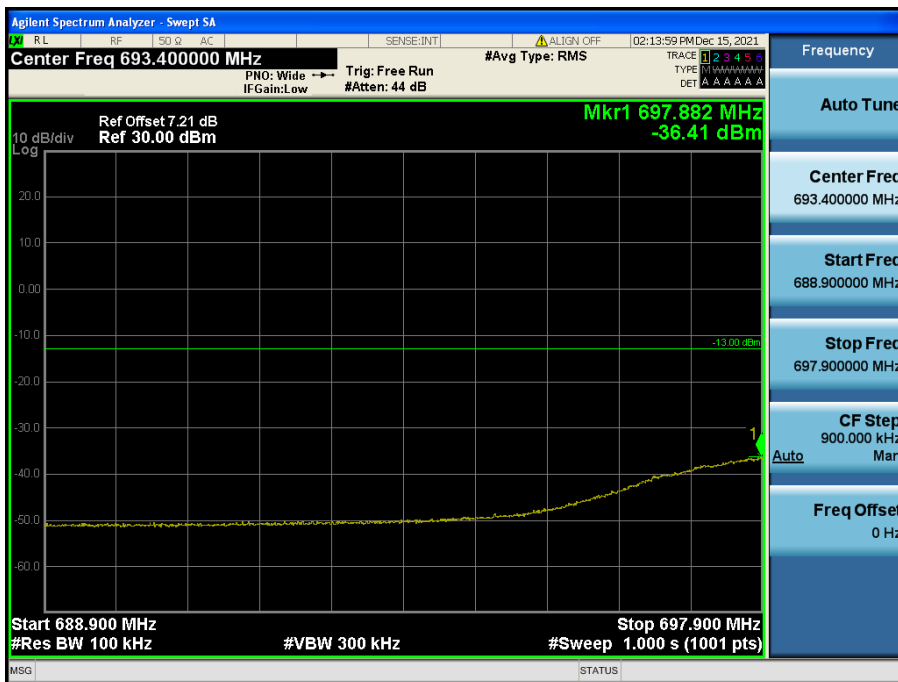

LTE Band 12 / 10 MHz / 16QAM - RB Size/Offset (25/0)

- Upper Band Edge



LTE Band 12 / 10 MHz / QPSK - RB Size/Offset (25/25)

- Upper Extended Band Edge



LTE Band 12 / 10 MHz / QPSK - RB Size/Offset (25/25)