

SAR TEST REPORT

Test item : Mobile Computer
Model No. : FCC: XM5
IC: XM5WA
Order No. : DTNC1410-04626, DTNC1410-04629
Date of receipt : 2014-10-23
Test duration : 2014-11-05 ~ 2014-11-15
Date of issue : 2014-12-01
Use of report : FCC & IC Original Grant

Applicant : Janam Technologies LLC
100 Crossways Park West Suite 105, Woodbury, New York 11797 USA

Test laboratory : DT&C Co., Ltd.
42, Yurim-ro, 154beon-gil, Cheoin-gu, Yongin-si, Gyeonggi-do, Korea 449-935

Test rule part : CFR §2.1093 & RSS-102
Test environment : See appended test report
Test result : Pass Fail

The test results presented in this test report are limited only to the sample supplied by applicant and the use of this test report is inhibited other than its purpose. This test report shall not be reproduced except in full, without the written approval of DT&C Co., Ltd.

Tested by:



Engineer
Bumjun, Park

Witnessed by:



Engineer
N/A

Reviewed by:



Technical Director
Harvey Sung

Table of Contents

| | |
|---|-----------|
| 1. DESCRIPTION OF DEVICE | 5 |
| 1.1 Guidance Applied | 6 |
| 1.2 Device Overview..... | 6 |
| 1.3 Nominal and Maximum Output Power Specifications..... | 6 |
| 1.4 DUT Antenna Locations | 8 |
| 1.5 SAR Test Exclusions Applied | 9 |
| 1.6 Power Reduction for SAR..... | 9 |
| 1.7 Device Serial Numbers | 9 |
| 2. INTROCUCTION | 10 |
| 3. DESCRIPTION OF TEST EQUIPMENT | 11 |
| 3.1 SAR MEASUREMENT SETUP | 11 |
| 3.2 EX3DV4 Probe Specification..... | 12 |
| 3.3 Probe Calibration Process..... | 13 |
| 3.3.1 E-Probe Calibration..... | 13 |
| 3.4 Data Extrapolation | 14 |
| 3.5 SAM Twin PHANTOM | 15 |
| 3.6 Device Holder for Transmitters..... | 15 |
| 3.7 Brain & Muscle Simulation Mixture Characterization..... | 16 |
| 3.8 SAR TEST EQUIPMENT..... | 17 |
| 4. TEST SYSTEM SPECIFICATIONS | 18 |
| 5. SAR MEASUREMENT PROCEDURE | 19 |
| 5.1 Measurement Procedure | 19 |
| 6. DEFINITION OF REFERENCE POINTS | 20 |
| 6.1 Ear Reference Point | 20 |
| 6.2 Handset Reference Points..... | 20 |
| 7. TEST CONFIGURATION POSITIONS FOR HANDSETS | 21 |
| 7.1 Device Holder | 21 |
| 7.2 Positioning for Cheek/Touch | 21 |
| 7.3 Positioning for Ear / 15 ° Tilt..... | 21 |
| 7.4 Body-Worn Accessory Configurations | 22 |
| 7.5 Extremity Exposure Configurations | 23 |
| 8. RF EXPOSURE LIMITS | 24 |
| 9. FCC MEASUREMENT PROCEDURES | 25 |
| 9.1 Measured and Reported SAR | 25 |
| 9.2 Procedures Used to Establish RF Signal for SAR..... | 25 |
| 9.3 SAR Measurement Conditions for WCDMA (UMTS)..... | 25 |
| 9.3.1 Output Power Verification | 25 |
| 9.3.2 Head SAR Measurements for Handsets..... | 25 |
| 9.3.3 Body SAR Measurements..... | 26 |
| 9.3.4 SAR Measurements for Handsets with Rel 5 HSDPA..... | 26 |
| 9.3.5 SAR Measurements for Handsets with Rel 6 HSUPA..... | 26 |
| 9.4 SAR Testing with 802.11 Transmitters | 27 |
| 9.4.1 General Device Setup..... | 27 |

| | |
|---|------------|
| 9.4.2 Frequency Channel Configurations | 28 |
| 10. RF CONDUCTED POWERS | 29 |
| 10.1 GSM Conducted Powers | 29 |
| 10.2 WCDMA Conducted Powers | 30 |
| 10.3 WLAN Conducted Powers | 31 |
| 10.4 Bluetooth Conducted Powers | 33 |
| 11. SYSTEM VERIFICATION | 34 |
| 11.1 Tissue Verification | 34 |
| 11.2 Test System Verification | 36 |
| 12. SAR TEST RESULTS..... | 38 |
| 12.1 Head SAR Results..... | 38 |
| 12.2 Standalone Body-Worn SAR Results | 41 |
| 12.3 Hand SAR Results..... | 43 |
| 12.4 SAR Test Notes | 46 |
| 13. SAR MEASUREMENT VARIABILITY..... | 48 |
| 13.1 Measurement Variability | 48 |
| 13.2 Measurement Uncertainty | 48 |
| 14. IEEE P1528 –MEASUREMENT UNCERTAINTIES..... | 49 |
| 15. CONCLUSION..... | 63 |
| 16. REFERENCES | 64 |
| Attachment 1. – Probe Calibration Data..... | 66 |
| Attachment 2. – Dipole Calibration Data..... | 78 |
| Attachment 3. – SAR SYSTEM VALIDATION..... | 121 |

Test Report Version

| Test Report No. | Date | Description |
|-----------------|---------------|----------------------------|
| DRTFCC1412-1538 | Dec. 01, 2014 | Final version for approval |
| | | |
| | | |
| | | |
| | | |
| | | |
| | | |
| | | |
| | | |
| | | |

1. DESCRIPTION OF DEVICE

Environmental evaluation measurements of specific absorption rate (SAR) distributions in emulated human head and body tissues exposed to radio frequency (RF) radiation from wireless portable devices for compliance with the rules and regulations of the U.S. Federal Communications Commission (FCC).

General Information:

| EUT type | Mobile Computer | | | | |
|----------------------|--|--------------------------------|---------------|-----------|--------------------------|
| FCC ID | UTWXM5WA | | | | |
| IC ID | 6914A-XM5WA | | | | |
| Equipment model name | FCC: XM5 IC: XM5WA | | | | |
| Equipment serial no. | Identical prototype | | | | |
| Mode(s) of Operation | GSM 850, PCS 1900, WCDMA 850, WCDMA 1900, 2.4 G W-LAN (802.11b/g/n HT20), 5G W-LAN(802.11a/n HT20) | | | | |
| TX Frequency Range | 824.2 ~ 848.8 MHz (Cellular Band) / 1850.2 ~ 1909.8 MHz (PCS Band) 826.4 ~ 846.6 MHz (WCDMA FDD V) / 1852.4 ~ 1907.6 MHz (WCDMA FDD II) 2412 ~ 2462 MHz (802.11b/g/n HT20) 5180 ~ 5240 MHz (802.11a/n HT20) / 5260 ~ 5320 MHz (802.11a/n HT20) 5500 ~ 5700 MHz (802.11a/n HT20) / 5745 ~ 5825 MHz (802.11a/n HT20) | | | | |
| RX Frequency Range | 869.2 ~ 893.8 MHz (Cellular Band) / 1930.2 ~ 1989.8 MHz (PCS Band) 871.4 ~ 891.6 MHz (WCDMA FDD V) / 1932.4 ~ 1987.6 MHz (WCDMA FDD II) 2412 ~ 2462 MHz (802.11b/g/n HT20) 5180 ~ 5240 MHz (802.11a/n HT20) / 5260 ~ 5320 MHz (802.11a/n HT20) 5500 ~ 5700 MHz (802.11a/n HT20) / 5745 ~ 5825 MHz (802.11a/n HT20) | | | | |
| Equipment Class | Band | Measured Conducted Power [dBm] | Reported SAR | | |
| | | | 1g SAR (W/kg) | | 10g Extremity SAR (W/kg) |
| | | | Head | Body-worn | Hand |
| PCE | GSM/GPRS 850 | 33.10 | 0.392 | 0.591 | 1.012 |
| PCE | GSM/GPRS 1900 | 29.70 | 0.053 | 0.321 | 0.955 |
| PCE | WCDMA 850 | 23.96 | 0.451 | 0.306 | 0.980 |
| PCE | WCDMA 1900 | 24.20 | 0.149 | 0.788 | 1.995 |
| DTS | 2.4 GHz W-LAN | 16.19 | 0.375 | 0.062 | 0.172 |
| NII | 5.2 GHz W-LAN | 11.51 | 0.365 | 0.079 | 0.261 |
| NII | 5.3 GHz W-LAN | 12.76 | 0.205 | 0.041 | 0.138 |
| NII | 5.6 GHz W-LAN | 12.83 | 0.085 | 0.038 | 0.068 |
| NII | 5.8 GHz W-LAN | 10.45 | 0.185 | 0.095 | 0.140 |
| DSS | Bluetooth | 2.81 | N/A | | |
| FCC Equipment Class | Licensed Portable Transmitter Held to Ear (PCE) | | | | |
| Date(s) of Tests | 2014-11-05 ~ 2014-11-15 | | | | |
| Antenna Type | Internal Type Antenna | | | | |
| Functions | <ul style="list-style-type: none"> ● GPRS (GPRS Class: 12) / EDGE (EDGE Class: 12) supported * DTM not supported ● BT (2.4 GHz) / W-LAN (2.4 GHz 802.11b/g/n(HT20)) supported W-LAN (5 GHz 802.11a/n(HT20)) supported * No simultaneous transmission between BT & WLAN ● GPRS, WCDMA, W-LAN VoIP supported. ● Mobile Hotspot not supported. ● Industrial PDA OS doesn't support any simultaneous transmission between transmitters. | | | | |

1.1 Guidance Applied

- IEEE 1528-2003
- FCC KDB Publication 941225 D01 3G SAR Procedures v03
- FCC KDB Publication 248227 D01v01r02 (SAR Considerations for 802.11 Devices)
- FCC KDB Publication 447498 D01v05r02 (General SAR Guidance)
- FCC KDB Publication 648474 D04 Handset SAR v01r02
- FCC KDB Publication 690783 D01 SAR Listings on Grants v01r03
- FCC KDB Publication 865664 D01 SAR Measurement 100 MHz to 6 GHz v01r03
- FCC KDB Publication 865664 D02 RF Exposure Reporting v01r01
- October 2013 TCB Workshop Notes (GPRS testing criteria)

1.2 Device Overview

| Band & Mode | Operating Modes | Tx Frequency |
|--------------------|-----------------|---------------------|
| GSM/GPRS/EDGE 850 | Voice/Data | 824.2 ~ 848.8 MHz |
| GSM/GPRS/EDGE 1900 | Voice/Data | 1850.2 ~ 1909.8 MHz |
| WCDMA 850 | Voice/Data | 826.4 ~ 846.6 MHz |
| WCDMA 1900 | Voice/Data | 1852.4 ~ 1907.6 MHz |
| 2.4 GHz WLAN | Data | 2412 ~ 2462 MHz |
| 5.8 GHz WLAN | Data | 5745 ~ 5825 MHz |
| 5.2 GHz WLAN | Data | 5180 ~ 5240 MHz |
| 5.3 GHz WLAN | Data | 5260 ~ 5320 MHz |
| 5.6 GHz WLAN | Data | 5500 ~ 5700 MHz |
| Bluetooth | Data | 2402 ~ 2480 MHz |

1.3 Nominal and Maximum Output Power Specifications

This device operates using the following maximum and nominal output power specifications. SAR values were scaled to the maximum allowed power to determine compliance per KDB Publication 447498 D01v05r02.

| Band & Mode | | Voice [dBm] | Burst Average GMSK [dBm] | | | | Burst Average 8-PSK [dBm] | | | |
|----------------|---------|-------------|--------------------------|-----------|-----------|-----------|---------------------------|-----------|-----------|-----------|
| | | 1Tx Slot | 1 TX Slot | 2 TX Slot | 3 TX Slot | 4 TX Slot | 1 TX Slot | 2 TX Slot | 3 TX Slot | 4 TX Slot |
| GPRS/EDGE 850 | Maximum | 33.2 | 33.2 | 29.8 | 28.0 | 26.8 | 27.5 | 24.3 | 22.5 | 21.5 |
| | Nominal | 32.7 | 32.7 | 29.3 | 27.5 | 26.3 | 27.0 | 23.8 | 22.0 | 21.0 |
| GPRS/EDGE 1900 | Maximum | 30.0 | 30.0 | 26.5 | 24.6 | 23.3 | 26.1 | 22.9 | 21.5 | 20.0 |
| | Nominal | 29.5 | 29.5 | 26.0 | 24.1 | 22.8 | 25.6 | 22.4 | 21.0 | 19.5 |

| Band & Mode | | Modulated Average [dBm] | | |
|-------------|---------|-------------------------|------------|------------|
| | | 3GPP RMC | 3GPP HSDPA | 3GPP HSUPA |
| WCDMA 850 | Maximum | 24.0 | 24.0 | 24.0 |
| | Nominal | 23.5 | 23.5 | 23.5 |
| WCDMA 1900 | Maximum | 24.3 | 24.3 | 24.3 |
| | Nominal | 23.8 | 23.8 | 23.8 |

| Band & Mode | | Modulated Average [dBm] |
|---------------------------|---------|----------------------------|
| IEEE 802.11b (2.4 GHz) | Maximum | 16.5 |
| | Nominal | 15.5 |
| IEEE 802.11g (2.4 GHz) | Maximum | 14.5 |
| | Nominal | 13.5 |
| IEEE 802.11n (2.4 GHz) | Maximum | 12.5 |
| | Nominal | 11.5 |
| IEEE 802.11a (5 GHz) | Maximum | 13.0 |
| | Nominal | 11.0 |
| IEEE 802.11n (5 GHz HT20) | Maximum | 12.0 |
| | Nominal | 10.0 |
| Bluetooth 1 Mbps | Maximum | 3.0 |
| | Nominal | 2.0 |
| Bluetooth 2 Mbps | Maximum | -3.0 |
| | Nominal | -4.0 |
| Bluetooth 3 Mbps | Maximum | -3.0 |
| | Nominal | -4.0 |

1.4 DUT Antenna Locations

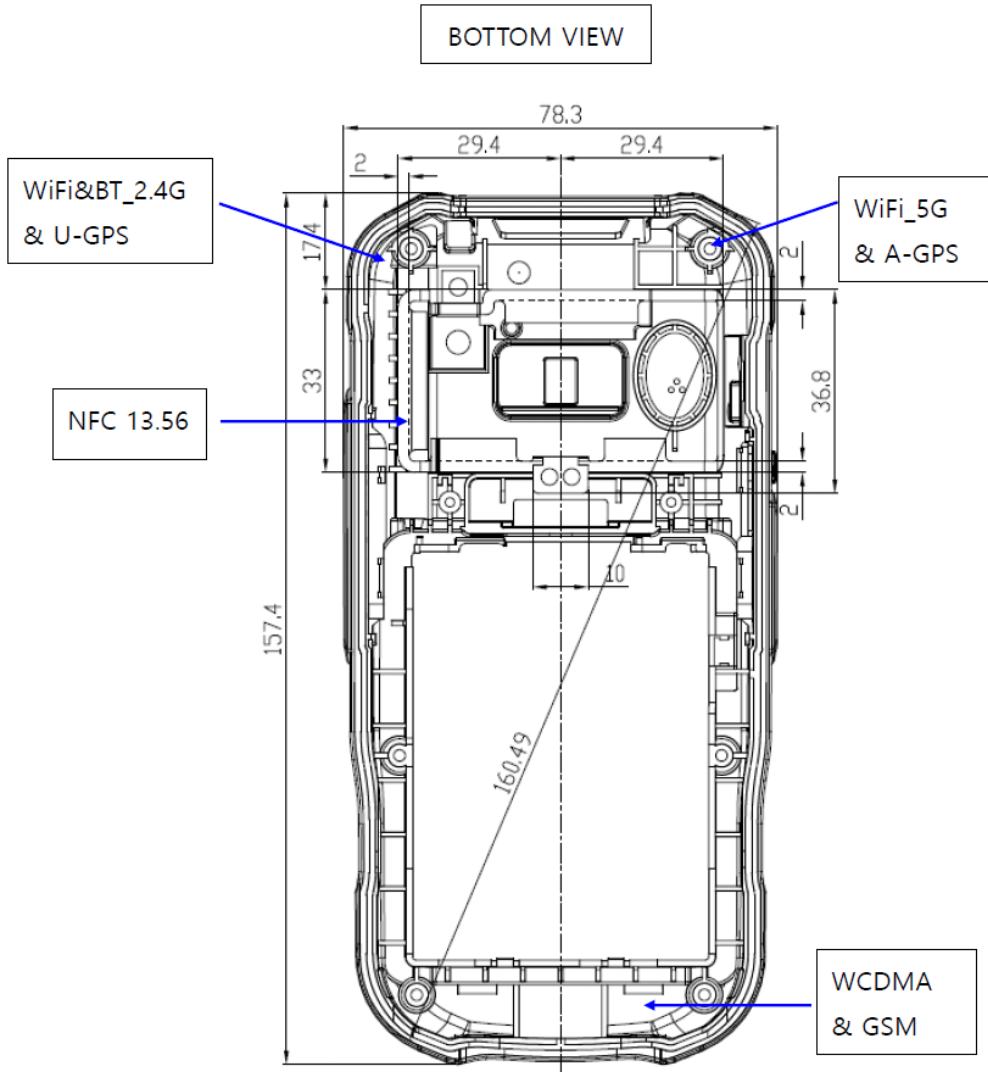

Note 1: Exact antenna dimensions and separation distances are shown in the “Antenna Location_UTWXM5WA” in the FCC Filing.
 Note 2: Since the diagonal dimension of this device is > 160 mm and < 200 mm, it is considered a “Phablet”

| Mode | Phablet Sides for SAR Testing | | | | | |
|--------------------------|-------------------------------|--------|-------|------|-------|------|
| | Top | Bottom | Front | Rear | Right | Left |
| GSM 850 | X | O | O | O | O | O |
| GSM 1900 | X | O | O | O | O | O |
| GPRS 850 | X | O | O | O | O | O |
| GPRS 1900 | X | O | O | O | O | O |
| WCDMA 850 | X | O | O | O | O | O |
| WCDMA 1900 | X | O | O | O | O | O |
| 2.4G W-LAN (802.11b/g/n) | O | X | O | O | O | O |
| 5G W-LAN (802.11a/n) | O | X | O | O | O | O |

Table 1.1 Phablet Sides for SAR Testing

Note:

- Particular DUT edges were not required to be evaluated for Phablet SAR if the edges were greater than 2.5 cm from the transmitting antenna according to FCC KDB Publication 648474 D04v01r02. The antenna document shows the distances between the transmit antennas and the edges of the device.

1.5 SAR Test Exclusions Applied

(A) WIFI & BT

Per FCC KDB 447498 D01v05r02, the 1g SAR exclusion threshold for distances < 50 mm is defined by the following equation:

$$\frac{\text{Max Power of Channel (mW)}}{\text{Test Separation Dist (mm)}} * \sqrt{\text{Frequency(GHz)}} \leq 3.0$$

Based on the maximum conducted power of **Bluetooth** (rounded to the nearest mW) and the antenna to user separation distance, **Bluetooth SAR was not required**; $[(2/10) * \sqrt{2.480}] = \underline{0.3} < 3.0$.

Based on the maximum conducted power of **2.4 GHz WIFI** (rounded to the nearest mW) and the antenna to user separation distance, **2.4 GHz WIFI SAR was required**; $[(42/10) * \sqrt{2.462}] = \underline{6.5} > 3.0$.

Based on the maximum conducted power of **5 GHz WIFI** (rounded to the nearest mW) and the antenna to user separation distance, **5 GHz WIFI SAR was required**; $[(20/10) * \sqrt{5.825}] = \underline{4.8} > 3.0$.

Per FCC KDB 447498 D01v05r02, the 10g SAR exclusion threshold for distances < 50 mm is defined by the following equation:

$$\frac{\text{Max Power of Channel (mW)}}{\text{Test Separation Dist (mm)}} * \sqrt{\text{Frequency(GHz)}} \leq 7.5$$

Based on the maximum conducted power of **Bluetooth** (rounded to the nearest mW) and the antenna to user separation distance, **Bluetooth SAR was not required**; $[(2/5) * \sqrt{2.480}] = \underline{0.6} < 7.5$.

Based on the maximum conducted power of **2.4 GHz WIFI** (rounded to the nearest mW) and the antenna to user separation distance, **2.4 GHz WIFI SAR was required**; $[(42/5) * \sqrt{2.462}] = \underline{13.1} > 7.5$.

Based on the maximum conducted power of **5 GHz WIFI** (rounded to the nearest mW) and the antenna to user separation distance, **5 GHz WIFI SAR was required**; $[(20/5) * \sqrt{5.825}] = \underline{9.6} > 7.5$.

Per FCC KDB Publication 648474 D04v01r02, this device is considered a "Phablet" since the diagonal dimension is greater than 200 mm. However, when next to the ear voice mode is supported, regardless of the overall dimension, phablets must be tested according to the requirements described in KDB 648474. Extremity SAR tests are required when wireless router mode does not apply or if wireless router 1 g SAR > 1.2 W/Kg. Because wireless router mode does not supported, extremity SAR tests were required.

Per KDB Publication 447498 D01v05r02, the maximum power of the channel was rounded to the nearest mW before calculation.

(B) Licensed Transmitter(s)

GSM/GPRS DTM is not supported. Therefore, the GSM Voice modes in this report do not transmit simultaneously with GPRS/EDGE Data.

1.6 Power Reduction for SAR

There is no power reduction used for any band/mode implemented in this device for SAR purposes.

1.7 Device Serial Numbers

| Band & Mode | Head Serial Number | Body-Worn Serial Number |
|---------------|--------------------|-------------------------|
| GSM/GPRS 850 | FCC #1 | FCC #1 |
| GSM/GPRS 1900 | FCC #1 | FCC #1 |
| WCDMA 850 | FCC #1 | FCC #1 |
| WCDMA 1900 | FCC #1 | FCC #1 |
| 2.4 GHz WLAN | FCC #1 | FCC #1 |
| 5 GHz WLAN | FCC #1 | FCC #1 |

2. INTROCUCTION

The FCC and Industry Canada have adopted the guidelines for evaluating the environmental effects of radio frequency (RF) radiation in ET Docket 93-62 on Aug. 6, 1996 and Health Canada Safety Code 6 to protect the public and workers from the potential hazards of RF emissions due to FCC-regulated portable devices.

The FCC has adopted the guidelines for evaluating the environmental effects of radio frequency radiation in ET Docket 93-62 on Aug. 6, 1996 to protect the public and workers from the potential hazards of RF emissions due to FCC-regulated portable devices. The safety limits used for the environmental evaluation measurements are based on the criteria published by the American National Standards Institute (ANSI) for localized specific absorption rate (SAR) in IEEE/ANSI C95*.1-2005 Standard for Safety Levels with Respect to Human Exposure to Radio Frequency Electromagnetic Fields, 3 kHz to 300 GHz. 1992 by the Institute of Electrical and Electronics Engineers, Inc., New York, New York 10017. The measurement procedure described in IEEE/ANSI C95.3-1992 Recommended Practice for the Measurement of Potentially Hazardous Electromagnetic Fields - RF and Microwave is used for guidance in measuring SAR due to the RF radiation exposure from the Equipment Under Test (EUT). These criteria for SAR evaluation are similar to those recommended by the National Council on Radiation Protection and Measurements (NCRP) in Biological Effects and Exposure Criteria for Radio frequency Electromagnetic Fields," NCRP Report No. 86 NCRP, 1986, Bethesda, MD 20814. SAR is a measure of the rate of energy absorption due to exposure to an RF transmitting source. SAR values have been related to threshold levels for potential biological hazards.

SAR Definition

Specific Absorption Rate (SAR) is defined as the time derivative (rate) of the incremental energy (dU) absorbed by (dissipated in) an incremental mass (dm) contained in a volume element (dV) of a given density (ρ) It is also defined as the rate of RF energy absorption per unit mass at a point in an absorbing body (see Fig. 2.1)

$$SAR = \frac{d}{dt} \left(\frac{dU}{dm} \right) = \frac{d}{dt} \left(\frac{dU}{\rho dv} \right)$$

Fig. 2.1 SAR Mathematical Equation

SAR is expressed in units of Watts per Kilogram (W/kg).

$$SAR = \frac{\sigma \cdot E^2}{\rho}$$

where:

- σ = conductivity of the tissue-simulating material (S/m)
- ρ = mass density of the tissue-simulating material (kg/m^3)
- E = Total RMS electric field strength (V/m)

NOTE: The primary factors that control rate of energy absorption were found to be the wavelength of the incident field in relations to the dimensions and geometry of the irradiated organism, the orientation of the organism in relation to the polarity of field vectors, the presence of reflecting surfaces, and whether conductive contact is made by the organism with a ground plane.

3. DESCRIPTION OF TEST EQUIPMENT

3.1 SAR MEASUREMENT SETUP

Measurements are performed using the DASY5 automated dosimetric assessment system. The DASY5 is made by Schmid & Partner Engineering AG (SPEAG) in Zurich, Switzerland and consists of high precision robotics system (Staubli), robot controller, desktop computer, near-field probe, probe alignment sensor, and the generic twin phantom containing the brain equivalent material. The robot is a six-axis industrial robot performing precise movements to position the probe to the location (points) of maximum electromagnetic field (EMF) (see Fig. 3.1).

A cell controller system contains the power supply, robot controller teach pendant (Joystick), and a remote control used to drive the robot motors. The PC consists of the Intel Core i7-2600 3.40 GHz desktop computer with Windows NT system and SAR Measurement Software DASY5, A/D interface card, monitor, mouse, and keyboard. The Staubli Robot is connected to the cell controller to allow software manipulation of the robot. A data acquisition electronic (DAE) circuit that performs the signal amplification, signal multiplexing, AD-conversion, offset measurements, mechanical surface detection, collision detection, etc. is connected to the Electro-optical coupler (EOC). The EOC performs the conversion from the optical into digital electric signal of the DAE and transfers data to the PC plug-in card.

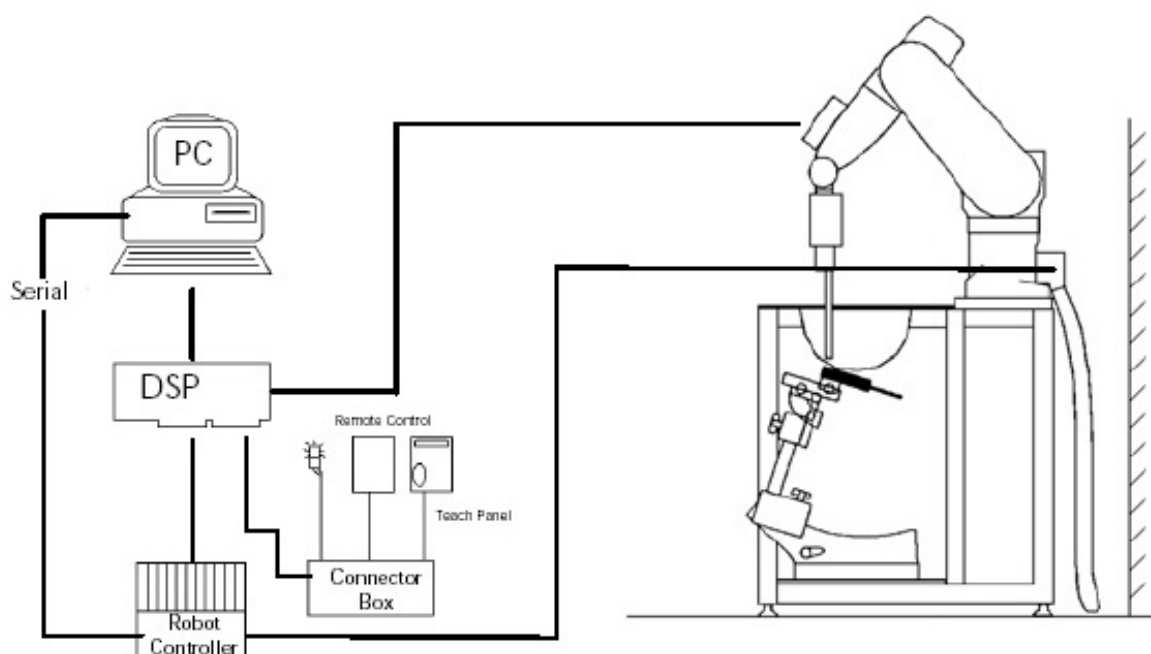

Figure 3.1 SAR Measurement System Setup

The DAE4 consists of a highly sensitive electrometer-grade preamplifier with auto-zeroing, a channel and gain-switching multiplexer, a fast 16 bit AD-converter and a command decoder and control logic unit. Transmission to the PC-card is accomplished through an optical downlink for data and status information and an optical uplink for commands and clock lines. The mechanical probe mounting device includes two different sensor systems for frontal and sidewise probe contacts. They are also used for mechanical surface detection and probe collision detection. The robot uses its own controller with a built in VME-bus computer. The system is described in detail.

3.2 EX3DV4 Probe Specification

| | |
|---|--|
| Calibration | In air from 10 MHz to 6 GHz In brain and muscle simulating tissue at Frequencies of 450 MHz, 600 MHz, 750 MHz, 835 MHz, 900 MHz, 1750 MHz, 1900 MHz, 2300 MHz, 2450 MHz, 2600 MHz, 3500 MHz, 5200 MHz, 5300 MHz, 5500 MHz, 5600 MHz, 5800 MHz |
| Frequency | 10 MHz to 6 GHz |
| Linearity | ± 0.2 dB (30 MHz to 6 GHz) |
| Dynamic | 10 μ W/g to > 100 mW/g |
| Range | Linearity : ± 0.2 dB |
| Dimensions | Overall length : 337 mm |
| Tip length | 20 mm |
| Body diameter | 12 mm |
| Tip diameter | 2.5 mm |
| Distance from probe tip to sensor center | 1.0 mm |
| Application | SAR Dosimetry Testing Compliance tests of mobile phones |

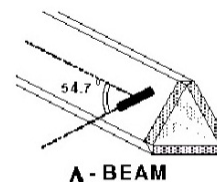

Figure 3.2 Triangular Probe Configurations



Figure 3.3 Probe Thick-Film Technique



DAE System

The SAR measurements were conducted with the dosimetric probe EX3DV4, designed in the classical triangular configuration (see Fig. 3.2) and optimized for dosimetric evaluation. The probe is constructed using the thick film technique; with printed resistive lines on ceramic substrates. The probe is equipped with an optical multitier line ending at the front of the probe tip. It is connected to the EOC box on the robot arm and provides an automatic detection of the phantom surface. Half of the fibers are connected to a pulsed infrared transmitter, the other half to a synchronized receiver. As the probe approaches the surface, the reflection from the surface produces a coupling from the transmitting to the receiving fibers. This reflection increases first during the approach, reaches maximum and then decreases. If the probe is flatly touching the surface, the coupling is zero. The distance of the coupling maximum to the surface is independent of the surface reflectivity and largely independent of the surface to probe angle. The DASY5 software reads the reflection during a software approach and looks for the maximum using a 2nd order fitting. The approach is stopped at reaching the maximum.

3.3 Probe Calibration Process

3.3.1 E-Probe Calibration

Dosimetric Assessment Procedure

Each probe is calibrated according to a dosimetric assessment procedure with accuracy better than +/- 10%. The spherical isotropy was evaluated with the procedure and found to be better than +/-0.25dB. The sensitivity parameters (NormX, NormY, NormZ), the diode compression parameter (DCP) and the conversion factor (ConvF) of the probe is tested.

Free Space Assessment

The free space E-field from amplified probe outputs is determined in a test chamber. This is performed in a TEM cell for frequencies below 1 GHz, and in a waveguide above 1GHz for free space. For the free space calibration, the probe is placed in the volumetric center of the cavity at the proper orientation with the field. The probe is then rotated 360 degrees.

Temperature Assessment *

E-field temperature correlation calibration is performed in a flat phantom filled with the appropriate simulated brain tissue. The measured free space E-field in the medium, correlates to temperature rise in a dielectric medium. For temperature correlation calibration a RF transparent the remits or based temperature probe is used in conjunction with the E-field probe.

$$SAR = C \frac{\Delta T}{\Delta t}$$

where:

Δt = exposure time (30 seconds),

C = heat capacity of tissue (brain or muscle),

ΔT = temperature increase due to RF exposure.

$$SAR = \frac{|E|^2 \cdot \sigma}{\rho}$$

where:

σ = simulated tissue conductivity,

ρ = Tissue density (1.25 g/cm³ for brain tissue)

SAR is proportional to $\Delta T / \Delta t$, the initial rate of tissue heating, before thermal diffusion takes place. Now it's possible to quantify the electric field in the simulated tissue by equating the thermally derived SAR to the E- field;

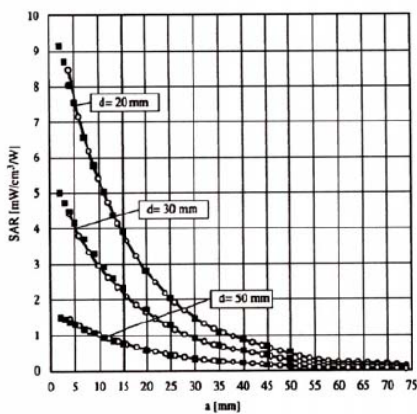

Figure 3.4 E-Field and Temperature Measurements at 900MHz

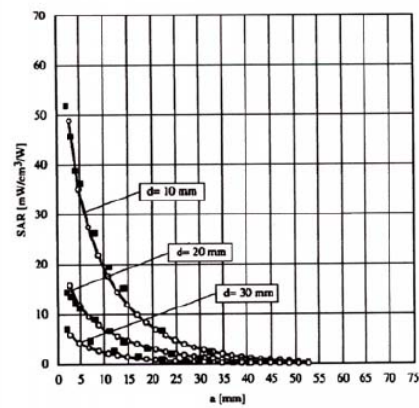

Figure 3.5 E-Field and Temperature Measurements at 1800MHz

3.4 Data Extrapolation

The DASYS5 software automatically executes the following procedures to calculate the field units from the microvolt readings at the probe connector. The first step of the evaluation is a linearization of the filtered input signal to account for the compression characteristics of the detector diode. The compensation depends on the input signal, the diode type and the DC-transmission factor from the diode to the evaluation electronics. If the exciting field is pulsed, the crest factor of the signal must be known to correctly compensate for peak power. The formula for each channel can be given like below;

$$V_i = U_i + U_i^2 \cdot \frac{cf}{dcp_i}$$

with V_i = compensated signal of channel i (i=x,y,z)
 U_i = input signal of channel i (i=x,y,z)
 cf = crest factor of exciting field (DASY parameter)
 dcp_i = diode compression point (DASY parameter)

From the compensated input signals the primary field data for each channel can be evaluated:

E-field probes: with V_i = compensated signal of channel i (i = x,y,z)
 $Norm_i$ = sensor sensitivity of channel i (i = x,y,z)
 $\mu V/(V/m)^2$ for E-field probes
 $ConvF$ = sensitivity of enhancement in solution
 E_i = electric field strength of channel i in V/m

$$E_i = \sqrt{\frac{V_i}{Norm_i \cdot ConvF}}$$

The RSS value of the field components gives the total field strength (Hermetian magnitude):

$$E_{tot} = \sqrt{E_x^2 + E_y^2 + E_z^2}$$

The primary field data are used to calculate the derived field units.

$$SAR = E_{tot}^2 \cdot \frac{\sigma}{\rho \cdot 1000}$$

with SAR = local specific absorption rate in W/g
 E_{tot} = total field strength in V/m
 σ = conductivity in [mho/m] or [Siemens/m]
 ρ = equivalent tissue density in g/cm³

The power flow density is calculated assuming the excitation field to be a free space field.

$$P_{free} = \frac{E_{tot}^2}{3770}$$

with P_{pwe} = equivalent power density of a plane wave in W/cm²
 E_{tot} = total electric field strength in V/m

3.5 SAM Twin PHANTOM

The SAM Twin Phantom V5.0 is constructed of a fiberglass shell integrated in a wooden table. The shape of the shell is based on data from an anatomical study designed to determine the maximum exposure in at least 90% of all users. It enables the dosimetric evaluation of left and right hand phone usage as well as body mounted usage at the flat phantom region. A cover prevents the evaporation of the liquid.

Reference markings on the Phantom allow the complete setup of all predefined phantom positions and measurement grids by manually teaching three points in the robot. (see Fig. 3.6)



Figure 3.6 SAM Twin Phantom

SAM Twin Phantom Specification:

| | |
|------------------------|---|
| Construction | The shell corresponds to the specifications of the Specific Anthropomorphic Mannequin (SAM) phantom defined in IEEE 1528 and IEC 62209-1. It enables the dosimetric evaluation of left and right hand phone usage as well as body mounted usage at the flat phantom region. A cover prevents evaporation of the liquid. Reference markings on the phantom allow the complete setup of all predefined phantom positions and measurement grids by teaching three points with the robot. Twin SAM V5.0 has the same shell geometry and is manufactured from the same material as Twin SAM V4.0, but has reinforced top structure. |
| Shell Thickness | 2 ± 0.2 mm |
| Filling Volume | Approx. 25 liters |
| Dimensions | Length: 1000 mm Width: 500 mm Height: adjustable feet |

Specific Anthropomorphic Mannequin (SAM) Specifications:

The phantom for handset SAR assessment testing is a low-loss dielectric shell, with shape and dimensions derived from the anthropometric data of the 90th percentile adult male head dimensions as tabulated by the US Army. The SAM Twin Phantom shell is bisected along the mid-sagittal plane into right and left halves (see Fig. 3.7). The perimeter sidewalls of each phantom halves are extended to allow filling with liquid to a depth that is sufficient to minimize reflections from the upper surface. The liquid depth is maintained at a minimum depth of 15cm to minimize reflections from the upper surface.



Figure 3.7 Sam Twin Phantom shell

3.6 Device Holder for Transmitters

In combination with the Twin SAM Phantom V4.0/V4.0c, V5.0 or ELI4, the Mounting Device enables the rotation of the mounted transmitter device in spherical coordinates. Rotation point is the ear opening point. Transmitter devices can be easily and accurately positioned according to IEC, IEEE, FCC or other specifications. The device holder can be locked for positioning at different phantom sections (left head, right head, flat).

Note: A simulating human hand is not used due to the complex anatomical and geometrical structure of the hand that may produce infinite number of configurations. To produce the worst-case condition (the hand absorbs antenna output power), the hand is omitted during the tests.



Figure 3.8 Mounting Device

3.7 Brain & Muscle Simulation Mixture Characterization

The brain and muscle mixtures consist of a viscous gel using hydrox-ethylcellulose (HEC) gelling agent and saline solution (see Table 3.1). Preservation with a bactericide is added and visual inspection is made to make sure air bubbles are not trapped during the mixing process. The mixture is calibrated to obtain proper dielectric constant (permittivity) and conductivity of the desired tissue. The mixture characterizations used for the brain and muscle tissue simulating liquids are according to the data by C. Gabriel and G. Harts grove.



Figure 3.9 Simulated Tissue

Table 3.1 Composition of the Tissue Equivalent Matter

| Ingredients (% by weight) | Frequency (MHz) | | | | | | | |
|--------------------------------|-----------------|-------|-------|-------|-------|-------|-------------|-------|
| | 835 | | 1900 | | 2450 | | 5200 ~ 5800 | |
| Tissue Type | Head | Body | Head | Body | Head | Body | Head | Body |
| Water | 40.19 | 50.75 | 55.24 | 70.23 | 71.88 | 73.40 | 65.52 | 80.00 |
| Salt (NaCl) | 1.480 | 0.940 | 0.310 | 0.290 | 0.160 | 0.060 | - | - |
| Sugar | 57.90 | 48.21 | - | - | - | - | - | - |
| HEC | 0.250 | - | - | - | - | - | - | - |
| Bactericide | 0.180 | 0.100 | - | - | - | - | - | - |
| Triton X-100 | - | - | - | - | 19.97 | - | 17.24 | - |
| DGBE | - | - | 44.45 | 29.48 | 7.990 | 26.54 | - | - |
| Diethylene glycol hexyl ether | - | - | - | - | - | - | 17.24 | - |
| Polysorbate (Tween) 80 | - | - | - | - | - | - | - | 20.00 |
| Target for Dielectric Constant | 41.5 | 55.2 | 40.0 | 53.3 | 39.2 | 52.7 | - | - |
| Target for Conductivity (S/m) | 0.90 | 0.97 | 1.40 | 1.52 | 1.80 | 1.95 | - | - |

Salt: 99 % Pure Sodium Chloride Sugar: 98 % Pure Sucrose
Water: De-ionized, 16M resistivity HEC: Hydroxyethyl Cellulose
DGBE: 99 % Di(ethylene glycol) butyl ether,[2-(2-butoxyethoxy) ethanol]
Triton X-100(ultra pure): Polyethylene glycol mono[4-(1,1,3,3-tetramethylbutyl)phenyl] ether

3.8 SAR TEST EQUIPMENT

Table 3.2 Test Equipment Calibration

| | Type | Manufacturer | Model | Cal.Date | Next.Cal.Date | S/N |
|-------------------------------------|---|--------------|------------|------------|---------------|-----------------|
| <input checked="" type="checkbox"/> | SEMITEC Engineering | SEMITEC | N/A | N/A | N/A | Shield Room |
| <input checked="" type="checkbox"/> | Robot | SCHMID | TX60L | N/A | N/A | F14/5VR2A1/A/01 |
| <input checked="" type="checkbox"/> | Robot Controller | SCHMID | C58C | N/A | N/A | F14/5VR2A1/C/01 |
| <input checked="" type="checkbox"/> | Joystick | SCHMID | N/A | N/A | N/A | D21142605A |
| <input checked="" type="checkbox"/> | Intel Core i7-2600 3.40 GHz Windows 7 Professional | N/A | N/A | N/A | N/A | N/A |
| <input checked="" type="checkbox"/> | Probe Alignment Unit LB | N/A | N/A | N/A | N/A | SE UKS 030 AA |
| <input checked="" type="checkbox"/> | Mounting Device | SCHMID | Holder | N/A | N/A | SD000H01KA |
| <input checked="" type="checkbox"/> | Twin SAM Phantom | SCHMID | QD000P40CD | N/A | N/A | 1220 |
| <input type="checkbox"/> | 2mm Oval Phantom ELI5 | SCHMID | QDOVA002AA | N/A | N/A | 1166 |
| <input checked="" type="checkbox"/> | Data Acquisition Electronics | SCHMID | DAE4 | 2014-03-27 | 2015-03-27 | 1335 |
| <input checked="" type="checkbox"/> | Dosimetric E-Field Probe | SCHMID | EX3DV4 | 2014-05-20 | 2015-05-20 | 3866 |
| <input checked="" type="checkbox"/> | 835 MHz SAR Dipole | SCHMID | D835V2 | 2014-01-22 | 2016-01-22 | 464 |
| <input checked="" type="checkbox"/> | 1900 MHz SAR Dipole | SCHMID | D1900V2 | 2014-01-29 | 2016-01-29 | 5d029 |
| <input checked="" type="checkbox"/> | 2450 MHz SAR Dipole | SCHMID | D2450V2 | 2014-01-21 | 2016-01-21 | 726 |
| <input checked="" type="checkbox"/> | 5 GHz SAR Dipole | SCHMID | D5GHzV2 | 2014-03-26 | 2016-03-26 | 1103 |
| <input checked="" type="checkbox"/> | Network Analyzer | Agilent | E5071C | 2014-10-21 | 2015-10-21 | MY46106970 |
| <input checked="" type="checkbox"/> | Signal Generator | Agilent | E4438C | 2014-09-12 | 2015-09-12 | US41461520 |
| <input checked="" type="checkbox"/> | Amplifier | EMPOWER | BBS3Q7ELU | 2014-09-12 | 2015-09-12 | 1020 |
| <input checked="" type="checkbox"/> | High Power RF Amplifier | EMPOWER | BBS3Q8CCJ | 2014-10-20 | 2015-10-20 | 1005 |
| <input checked="" type="checkbox"/> | Power Meter | HP | EPM-442A | 2014-02-28 | 2015-02-28 | GB37170267 |
| <input checked="" type="checkbox"/> | Power Meter | Anritsu | ML2495A | 2014-10-07 | 2015-10-07 | 1435003 |
| <input checked="" type="checkbox"/> | Wide Bandwidth Power Sensor | Anritsu | MA2490A | 2014-10-07 | 2015-10-07 | 1409034 |
| <input checked="" type="checkbox"/> | Power Sensor | HP | 8481A | 2014-02-28 | 2015-02-28 | 3318A96566 |
| <input checked="" type="checkbox"/> | Power Sensor | HP | 8481A | 2014-01-07 | 2015-01-07 | 3318A96030 |
| <input checked="" type="checkbox"/> | Dual Directional Coupler | Agilent | 778D-012 | 2014-01-07 | 2015-01-07 | 50228 |
| <input checked="" type="checkbox"/> | Directional Coupler | HP | 773D | 2014-06-27 | 2015-06-27 | 2389A00640 |
| <input checked="" type="checkbox"/> | Low Pass Filter 1.5 GHz | Micro LAB | LA-15N | 2014-01-07 | 2015-01-07 | N/A |
| <input checked="" type="checkbox"/> | Low Pass Filter 3.0 GHz | Micro LAB | LA-30N | 2014-09-11 | 2015-09-11 | N/A |
| <input checked="" type="checkbox"/> | Low Pass Filter 6.0 GHz | Micro LAB | LA-60N | 2014-02-27 | 2015-02-27 | 03942 |
| <input checked="" type="checkbox"/> | Attenuators (3 dB) | Agilent | 8491B | 2014-06-27 | 2015-06-27 | MY39260700 |
| <input checked="" type="checkbox"/> | Attenuators (10 dB) | WEINSCHEL | 23-10-34 | 2014-01-07 | 2015-01-07 | BP4387 |
| <input type="checkbox"/> | Step Attenuator | HP | 8494A | 2014-09-11 | 2015-09-11 | 3308A33341 |
| <input checked="" type="checkbox"/> | Dielectric Probe kit | SCHMID | DAK-3.5 | 2014-01-07 | 2015-01-07 | 1092 |
| <input checked="" type="checkbox"/> | 8960 Series 10 Wireless Comms. Test Set | Agilent | E5515C | 2014-09-12 | 2015-09-12 | GB41321164 |
| <input checked="" type="checkbox"/> | Power Splitter | Anritsu | K241B | 2014-02-28 | 2015-02-28 | 1701102 |
| <input checked="" type="checkbox"/> | Bluetooth Tester | TESCOM | TC-3000B | 2014-06-26 | 2015-06-26 | 3000B640046 |

NOTE: The E-field probe was calibrated by SPEAG, by temperature measurement procedure. Dipole Verification measurement is performed by DT&C before each test. The brain and muscle simulating material are calibrated by DT&C using the dielectric probe system and network analyzer to determine the conductivity and permittivity (dielectric constant) of the brain-equivalent material. Each equipment item was used solely within its respective calibration period.

4. TEST SYSTEM SPECIFICATIONS

Automated TEST SYSTEM SPECIFICATIONS:

Positioner

| | |
|----------------------|--|
| Robot | Stäubli Unimation Corp. Robot Model: TX60L |
| Repeatability | 0.02 mm |
| No. of axis | 6 |

Data Acquisition Electronic (DAE) System

Cell Controller

| | |
|-------------------------|------------------------|
| Processor | Intel Core i7-2600 |
| Clock Speed | 3.40 GHz |
| Operating System | Windows 7 Professional |
| Data Card | DASY5 PC-Board |

Data Converter

| | |
|-------------------------|--|
| Features | Signal, multiplexer, A/D converter. & control logic |
| Software | DASY5 |
| Connecting Lines | Optical downlink for data and status info Optical uplink for commands and clock |

PC Interface Card

| | |
|-----------------|--|
| Function | 24 bit (64 MHz) DSP for real time processing Link to DAE 4 16 bit A/D converter for surface detection system serial link to robot direct emergency stop output for robot |
|-----------------|--|

E-Field Probes

| | |
|---------------------|--|
| Model | EX3DV4 S/N: 3866 |
| Construction | Triangular core fiber optic detection system |
| Frequency | 10 MHz to 6 GHz |
| Linearity | ± 0.2 dB (30 MHz to 6 GHz) |

Phantom

| | |
|-----------------------|-------------------------|
| Phantom | SAM Twin Phantom (V5.0) |
| Shell Material | Composite |
| Thickness | 2.0 ± 0.2 mm |

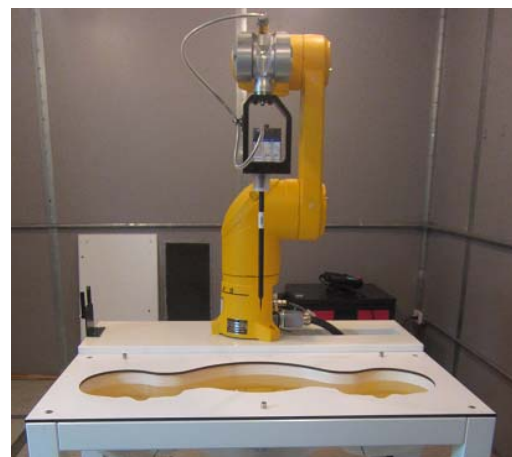

Figure 2.2 DASY5 Test System

5. SAR MEASUREMENT PROCEDURE

5.1 Measurement Procedure

The evaluation was performed using the following procedure compliant to FCC KDB Publication 865664 D01v01r03 and IEEE 1528-2013:

1. The SAR distribution at the exposed side of the head or body was measured at a distance no greater than 5.0 mm from the inner surface of the shell. The area covered the entire dimension of the device-head and body interface and the horizontal grid resolution was determined per FCC KDB Publication 865664 D01v01r03 (See Table 5-1) and IEEE 1528-2013.
2. The point SAR measurement was taken at the maximum SAR region determined from Step 1 to enable the monitoring of SAR fluctuations/drifts during the 1g/10g cube evaluation. SAR at this fixed point was measured and used as a reference value.
3. Based on the area scan data, the peak of the region with maximum SAR was determined by spline interpolation. Around this point, a volume was assessed according to the measurement resolution and volume size requirements of FCC KDB Publication 865664 D01v01r03 (See Table 5-1) and IEEE 1528-2013. On the basis of this data set, the spatial peak SAR value was evaluated with the following procedure (see references or the DASY manual online for more details):
 - a. SAR values at the inner surface of the phantom are extrapolated from the measured values along the line away from the surface with spacing no greater than that in Table 3-1. The extrapolation was based on a least-squares algorithm. A polynomial of the fourth order was calculated through the points in the z-axis (normal to the phantom shell).
 - b. After the maximum interpolated values were calculated between the points in the cube, the SAR was averaged over the spatial volume (1g or 10g) using a 3D-Spline interpolation algorithm. The 3D-spline is composed of three one-dimensional splines with the "Not a knot" condition (in x, y, and z directions). The volume was then integrated with the trapezoidal algorithm. One thousand points (10 x 10 x 10) were obtained through interpolation, in order to calculate the averaged SAR.
 - c. All neighboring volumes were evaluated until no neighboring volume with a higher average value was found.
4. The SAR reference value, at the same location as step 2, was re-measured after the zoom scan was complete to calculate the SAR drift. If the drift deviated by more than 5%, the SAR test and drift measurements were repeated.

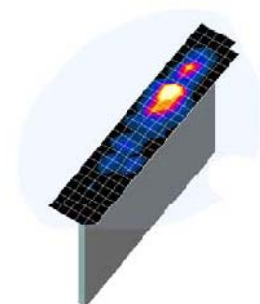

Figure 5.1
Sample SAR Area Scan

| Frequency | Maximum Area Scan Resolution (mm) ($\Delta x_{area}, \Delta y_{area}$) | Maximum Zoom Scan Resolution (mm) ($\Delta x_{zoom}, \Delta y_{zoom}$) | Maximum Zoom Scan Spatial Resolution (mm) | | | Minimum Zoom Scan Volume (mm) (x,y,z) |
|--------------|---|---|---|----------------------|-----------------------------------|--|
| | | | Uniform Grid | Graded Grid | | |
| | | | | $\Delta z_{zoom}(n)$ | $\Delta z_{zoom}(1)^*$ | |
| ≤ 2 GHz | ≤ 15 | ≤ 8 | ≤ 5 | ≤ 4 | $\leq 1.5 * \Delta z_{zoom}(n-1)$ | ≥ 30 |
| 2-3 GHz | ≤ 12 | ≤ 5 | ≤ 5 | ≤ 4 | $\leq 1.5 * \Delta z_{zoom}(n-1)$ | ≥ 30 |
| 3-4 GHz | ≤ 12 | ≤ 5 | ≤ 4 | ≤ 3 | $\leq 1.5 * \Delta z_{zoom}(n-1)$ | ≥ 28 |
| 4-5 GHz | ≤ 10 | ≤ 4 | ≤ 3 | ≤ 2.5 | $\leq 1.5 * \Delta z_{zoom}(n-1)$ | ≥ 25 |
| 5-6 GHz | ≤ 10 | ≤ 4 | ≤ 2 | ≤ 2 | $\leq 1.5 * \Delta z_{zoom}(n-1)$ | ≥ 22 |

Table 5.1 Area and Zoom Scan Resolutions per FCC KDB Publication 865664 D01v01r03*

*Also compliant to IEEE 1528-2013 Table 6

6. DEFINITION OF REFERENCE POINTS

6.1 Ear Reference Point

Figure 6.1 shows the front, back and side views of the SAM Twin Phantom. The point “M” is the reference point for the center of the mouth, “LE” is the left ear reference point(ERP), and “RE” is the right ERP. The ERPs are 15mm posterior to the entrance to the Ear canal (EEC) along the B-M line (Back-Mouth), as shown in Figure 6.5. The plane Passing, through the two ear canals and M is defined as the Reference Plane. The line N-F (Neck- Front) is perpendicular to the reference plane and passing through the RE (or LE) is called the Reference Pivoting Line (see Figure 6.1). Line B-M is perpendicular to the N-F line. Both N-F and B-M lines are marked on the external phantom shell to facilitate handset positioning.

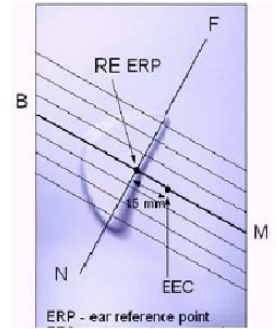

Figure 6.1
Close-up side view of ERP

6.2 Handset Reference Points

Two imaginary lines on the handset were established: the vertical centerline and the horizontal line. The test device was placed in a normal operating position with the “test device reference point” located along the “vertical centerline” on the front of the device aligned to the “ear reference point” (See Fig. 6.3). The “test device reference point” was then located at the same level as the center of the ear reference point. The test device was positioned so that the “vertical centerline” was bisecting the front surface of the handset at its top and bottom edges, positioning the “ear reference point” on the outer surface of the both the left and right head phantoms on the ear reference point.



Figure 6.2 Front, back and side view SAM Twin Phantom

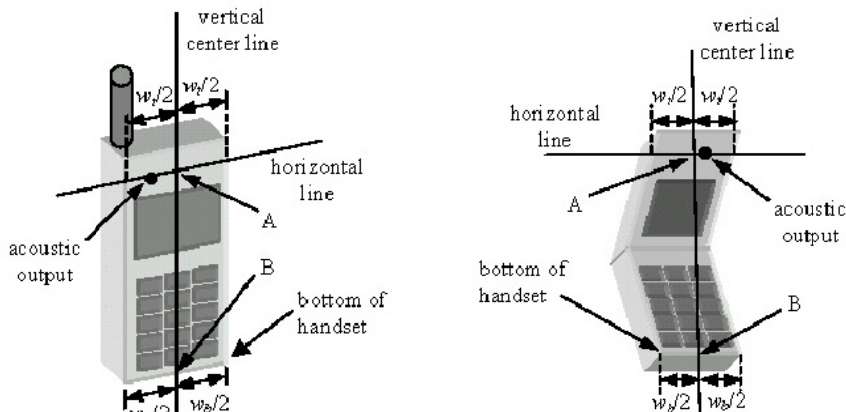

Figure 6.3 Handset Vertical Center & Horizontal Line Reference Points

7. TEST CONFIGURATION POSITIONS FOR HANDSETS

7.1 Device Holder

The device holder is made out of low-loss POM material having the following dielectric parameters: relative permittivity $\epsilon = 3$ and loss tangent $\delta = 0.02$.

7.2 Positioning for Cheek/Touch

1. The test device was positioned with the handset close to the surface of the phantom such that point A is on the (virtual) extension of the line passing through points RE and LE on the phantom (see Figure 7.1), such that the plane defined by the vertical center line and the horizontal line of the phone is approximately parallel to the sagittal plane of the phantom.



Figure 7.1 Front, Side and Top View of Cheek/Touch Position

2. The handset was translated towards the phantom along the line passing through RE & LE until the handset touches the ear.
3. While maintaining the handset in this plane, the handset was rotated around the LE-RE line until the vertical centerline was in the plane normal to MB-NF including the line MB (reference plane).
4. The phone was then rotated around the vertical centerline until the phone (horizontal line) was symmetrical with respect to the line NF.
5. While maintaining the vertical centerline in the reference plane, keeping point A on the line passing through RE and LE, and maintaining the phone contact with the ear, the handset was rotated about the line NF until any point on the handset made contact with a phantom point below the ear (cheek). (See Figure 7.2)

7.3 Positioning for Ear / 15 ° Tilt

With the test device aligned in the “Cheek/Touch Position”:

1. While maintaining the orientation of the phone, the phone was retracted parallel to the reference plane far enough to enable a rotation of the phone by 15 degree.
2. The phone was then rotated around the horizontal line by 15 degree.
3. While maintaining the orientation of the phone, the phone was moved parallel to the reference plane until any part of the phone touches the head. (In this position, point A was located on the line RE-LE). The tilted position is obtained when the contact is on the pinna. If the contact was at any location other than the pinna, the angle of the phone would then be reduced. The tilted position was obtained when any part of the phone was in contact of the ear as well as a second part of the phone was in contact with the head (see Figure 7.3).

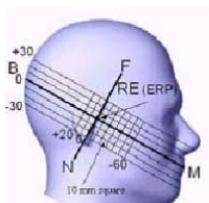

Figure 7.2 Side view w/relevant markings

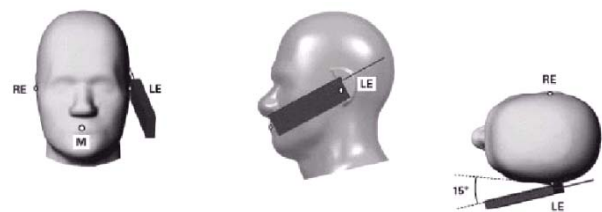

Figure 7.3 Front, Side and Top View of Ear/15° Position

7.4 Body-Worn Accessory Configurations

Body-worn operating configurations are tested with the belt-clips and holsters attached to the device and positioned against a flat phantom in a normal use configuration (see Figure 6.7). Per FCC KDB Publication 648474 D04v01r02, Body-worn accessory exposure is typically related to voice mode operations when handsets are carried in body-worn accessories. The body-worn accessory procedures in FCC KDB Publication 447498 D01v05r02 should be used to test for body-worn accessory SAR compliance, without a headset connected to it. This enables the test results for such configuration to be compatible with that required for hotspot mode when the body-worn accessory test separation distance is greater than or equal to that required for hotspot mode, when applicable. When the reported SAR for a body-worn accessory, measured without a headset connected to the handset, is > 1.2 W/kg, the highest reported SAR configuration for that wireless mode and frequency band should be repeated for that body-worn accessory with a headset attached to the handset.

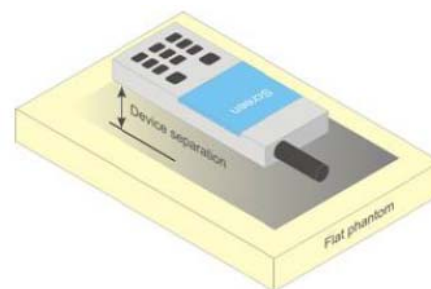

Figure 6.7 Sample Body-Worn Diagram

Accessories for Body-worn operation configurations are divided into two categories: those that do not contain metallic components and those that do contain metallic components. When multiple accessories that do not contain metallic components are supplied with the device, the device is tested with only the accessory that dictates the closest spacing to the body. Then multiple accessories that contain metallic components are tested with the device with each accessory. If multiple accessories share an identical metallic component (i.e. the same metallic belt-clip used with different holsters with no other metallic components) only the accessory that dictates the closest spacing to the body is tested.

Body-worn accessories may not always be supplied or available as options for some devices intended to be authorized for body-worn use. In this case, a test configuration with a separation distance between the back of the device and the flat phantom is used. Test position spacing was documented.

Transmitters that are designed to operate in front of a person's face, as in push-to-talk configurations, are tested for SAR compliance with the front of the device positioned to face the flat phantom in head fluid. For devices that are carried next to the body such as a shoulder, waist or chest-worn transmitters, SAR compliance is tested with the accessories, including headsets and microphones, attached to the device and positioned against a flat phantom in a normal use configuration.

7.5 Extremity Exposure Configurations

Devices that are designed or intended for use on extremities or mainly operated in extremity only exposure conditions; i.e., hands, wrists, feet and ankles, may require extremity SAR evaluation. When the device also operates in close proximity to the user's body, SAR compliance for the body is also required. The 1-g body and 10-g extremity SAR Exclusion Thresholds found in KDB Publication 447498 D01v05r02 should be applied to determine SAR test requirements.

For smart phones with a display diagonal dimension > 15.0 cm or an overall diagonal dimension > 16.0 cm that provide similar mobile web access and multimedia support found in mini-tablets or UMPC mini-tablets that support voice calls next to the ear, unless it is confirmed otherwise through KDB inquiries, the following phablet procedures should be applied to evaluate SAR compliance for each applicable wireless modes and frequency band. Devices marketed as phablets, regardless of form factors and operating characteristics must be tested as a phablet to determine SAR compliance.

1. The normally required head and body-worn accessory SAR test procedures for handsets, including hotspot mode, must be applied.
2. The UMPC mini-tablet procedures must also be applied to test the SAR of all surfaces and edges with an antenna located at ≤ 25 mm from that surface or edge, in direct contact with a flat phantom, for 10-g extremity SAR according to the body-equivalent tissue dielectric parameters in KDB 865664 to address interactive hand use exposure conditions. The UMPC mini-tablet 1-g SAR at 5 mm is not required. When hotspot mode applies, 10-g extremity SAR is required only for the surfaces and edges with hotspot mode 1-g reported SAR > 1.2 W/kg; however, when power reduction applies to hotspot mode the measured SAR must be scaled to the maximum output power, including tolerance, allowed for phablet modes to compare with the 1.2 W/kg SAR test reduction threshold. The normal tablet procedures in KDB 616217 are required when the over diagonal dimension of the device is > 20.0 cm. Hotspot mode SAR is not required when normal tablet procedures are applied. Extremity 10-g SAR is also not required for the front (top) surface of large form factor full size tablets. The more conservative tablet SAR results can be used to support the 10-g extremity SAR for phablet mode.
3. The simultaneous transmission operating configurations applicable to voice and data transmissions for both phone and mini-tablet modes must be taken into consideration separately for 1-g and 10-g SAR to determine the simultaneous transmission SAR test exclusion and measurement requirements for the relevant wireless modes and exposure conditions.

8. RF EXPOSURE LIMITS

Uncontrolled Environment:

UNCONTROLLED ENVIRONMENTS are defined as locations where there is the exposure of individuals who have no knowledge or control of their exposure. The general population/uncontrolled exposure limits are applicable to situations in which the general public may be exposed or in which persons who are exposed as a consequence of their employment may not be made fully aware of the potential for exposure or cannot exercise control over their exposure. Members of the general public would come under this category when exposure is not employment-related; for example, in the case of a wireless transmitter that exposes persons in its vicinity.

Controlled Environment:

CONTROLLED ENVIRONMENTS are defined as locations where there is exposure that may be incurred by persons who are aware of the potential for exposure, (i.e. as a result of employment or occupation). In general, occupational/controlled exposure limits are employment, who have been made fully aware of the potential for exposure and can exercise control over their exposure. This exposure category is also applicable when the exposure is of a transient nature due to incidental passage through a location where the exposure levels may be higher than the general population/uncontrolled limits, but the exposed person is fully aware of the potential for exposure and can exercise control over his or her exposure by leaving the area or by some other appropriate means.

Table 8.1.SAR Human Exposure Specified in ANSI/IEEE C95.1-2005

| | HUMAN EXPOSURE LIMITS | |
|--|---|---|
| | General Public Exposure (W/kg) or (mW/g) | Occupational Exposure (W/kg) or (mW/g) |
| SPATIAL PEAK SAR * (Brain) | 1.60 | 8.00 |
| SPATIAL AVERAGE SAR ** (Whole Body) | 0.08 | 0.40 |
| SPATIAL PEAK SAR *** (Hands / Feet / Ankle / Wrist) | 4.00 | 20.0 |

1. The Spatial Peak value of the SAR averaged over any 1 gram of tissue (defined as a tissue volume in the shape of a cube) and over the appropriate averaging time.
2. The Spatial Average value of the SAR averaged over the whole body.
3. The Spatial Peak value of the SAR averaged over any 10 grams of tissue (defined as a tissue volume in the shape of a cube) and over the appropriate averaging time.

Uncontrolled Environments are defined as locations where there is the exposure of individuals who have no knowledge or control of their exposure.

Controlled Environments are defined as locations where there is exposure that may be incurred by persons who are aware of the potential for exposure, (i.e.as a result of employment or occupation).

9. FCC MEASUREMENT PROCEDURES

Power measurements were performed using a base station simulator under digital average power.

9.1 Measured and Reported SAR

Per FCC KDB Publication 447498 D01v05r02, When SAR is not measured at the maximum power level allowed for production units, the results must be scaled to the maximum tune-up tolerance limit according to the power applied to the individual channels tested to determine compliance. For simultaneous transmission, the measured aggregate SAR must be scaled according to the sum of the differences between the maximum tune-up tolerance and actual power used to test each transmitter. When SAR is measured at or scaled to the maximum tune-up tolerance limit, the results are referred to as reported SAR. The highest reported SAR results are identified on the grant of equipment authorization according to procedures in KDB 690783 D01v01r03.

9.2 Procedures Used to Establish RF Signal for SAR

The following procedures are according to FCC KDB Publication 941225 D01 "3G SAR Procedures" v03, October 16, 2014.

The device was placed into a simulated call using a base station simulator in a RF shielded chamber. Establishing connections in this manner ensure a consistent means for testing SAR and are recommended for evaluating SAR [4]. Devices under test were evaluated prior to testing, with a fully charged battery and were configured to operate at maximum output power. In order to verify that the device was tested throughout the SAR test at maximum output power, the SAR measurement system measures a "point SAR" at an arbitrary reference point at the start and end of the 1 gram SAR evaluation, to assess for any power drifts during the evaluation. If the power drift deviated by more than 5%, the SAR test and drift measurements were repeated.

9.3 SAR Measurement Conditions for WCDMA (UMTS)

9.3.1 Output Power Verification

Maximum output power is measured on the High, Middle and Low channels for each applicable transmission band according to the general descriptions in section 5.2 of 3GPP TS 34.121, using the appropriate RMC or AMR with TPC (transmit power control) set to all "1s".

Maximum output power is verified on the High, Middle and Low channels according to the general, descriptions in section 5.2 of 3GPP TS 34.121 (release 5), using the appropriate RMC with TPC,(transmit power control) set to all "1s" or applying the required inner loop power control procedures to maintain maximum output power while HSUPA is active. Results for all applicable physical channel configurations (DPCCH, DPDCHn and spreading codes, HS-DPCCH etc) are tabulated in this test report. All configurations that are not supported by the DUT or cannot be measured due to technical or equipment limitations are identified.

9.3.2 Head SAR Measurements for Handsets

SAR for head exposure configurations is measured using the 12.2 kbps RMC with TPC bits configured to all "1s". SAR in AMR configurations is not required when the maximum average output of each RF channel for 12.2 kbps AMR is less than 0.25 dB higher than that measured in 12.2 kbps RMC. Otherwise, SAR is measured on the maximum output channel in 12.2 AMR with a 3.4 kbps SRB (signaling radio bearer) using the exposure configuration that resulted in the highest SAR for that RF channel in the 12.2 kbps RMC mode.

9.3.3 Body SAR Measurements

SAR for body exposure configurations is measured using the 12.2 kbps RMC with the TPC bits all “1s”.

9.3.4 SAR Measurements for Handsets with Rel 5 HSDPA

Body SAR for HSDPA is not required for handsets with HSDPA capabilities when the maximum average output power of each RF channel with HSDPA active is less than 0.25 dB higher than that measured without HSDPA using 12.2 kbps RMC and the maximum SAR for 12.2 kbps RMC is $\leq 75\%$ of the SAR limit. Otherwise, SAR is measured for HSDPA, using an FRC with H-Set 1 in Sub-test 1 and a 12.2 kbps RMC configured in Test Loop Mode 1, using the highest body SAR configuration measured in 12.2 kbps RMC without HSDPA, on the maximum output channel with the body exposure configuration that resulted in the highest SAR in 12.2 kbps RMC mode for that RF channel.

The H-set used in FRC for HSDPA should be configured according to the UE category of a test device. The number of HS-DSCH/HSPDSCHs, HARQ processes, minimum inter-TTI interval, transport block sizes and RV coding sequence are defined by the applicable H-set. To maintain a consistent test configuration and stable transmission conditions, QPSK is used in the FRC for SAR testing. HS-DPCCH should be configured with a CQI feedback cycle of 2 ms to maintain a constant rate of active CQI slots. DPCCH and DPDCH gain factors of $\beta_c=9$ and $\beta_d=15$, and power offset parameters of $\Delta_{ACK} = \Delta_{NACK} = 5$ and $\Delta_{CQI}=2$ is used. The CQI value is determined by the UE category, transport block size, number of HS-PDSCHs and modulation used in the FRC.

| Sub-test | β_c (Note 5) | β_d | β_d (SF) | β_c/β_d | β_{HS} (Note 1, Note 2) | CM (dB) (Note 3) | MPR (dB) (Note 3) |
|----------|-----------------------|-------------------|-------------------|-------------------|-------------------------------------|---------------------|----------------------|
| 1 | 2/15 | 15/15 | 64 | 2/15 | 4/15 | 0.0 | 0.0 |
| 2 | 12/15 (Note 4) | 15/15 (Note 4) | 64 | 12/15 (Note 4) | 24/15 | 1.0 | 0.0 |
| 3 | 15/15 | 8/15 | 64 | 15/8 | 30/15 | 1.5 | 0.5 |
| 4 | 15/15 | 4/15 | 64 | 15/4 | 30/15 | 1.5 | 0.5 |

Note 1: Δ_{ACK} , Δ_{NACK} and $\Delta_{CQI} = 30/15$ with $\beta_{hs} = 30/15 * \beta_c$.

Note 2: For the HS-DPCCH power mask requirement test in clause 5.2C, 5.7A, and the Error Vector Magnitude (EVM) with HS-DPCCH test in clause 5.13.1A, and HSDPA EVM with phase discontinuity in clause 5.13.1AA, Δ_{ACK} and $\Delta_{NACK} = 30/15$ with $\beta_{hs} = 30/15 * \beta_c$, and $\Delta_{CQI} = 24/15$ with $\beta_{hs} = 24/15 * \beta_c$.

Note 3: CM = 1 for $\beta_c/\beta_d = 12/15$, $\beta_{HS}/\beta_c = 24/15$. For all other combinations of DPDCH, DPCCH and HS-DPCCH the MPR is based on the relative CM difference. This is applicable for only UEs that support HSDPA in release 6 and later releases.

Note 4: For subtest 2 the β_c/β_d ratio of 12/15 for the TFC during the measurement period (TF1, TF0) is achieved by setting the signalled gain factors for the reference TFC (TF1, TF1) to $\beta_c = 11/15$ and $\beta_d = 15/15$.

Figure 9.1 Table C.10.1.4 of TS 234.121-1

9.3.5 SAR Measurements for Handsets with Rel 6 HSUPA

Body SAR for HSUPA is not required when the maximum average output of each RF channel with HSUPA/HSDPA active is less than 0.25 dB higher than as measured without HSUPA/HSDPA using 12.2 kbps RMC and maximum SAR for 12.2 kbps RMC is $\leq 75\%$ of the SAR limit. Otherwise SAR is measured on the maximum output channel for the body exposure configuration produced highest SAR in 12.2 kbps RMC for that RF channel, using the additional procedures under “Release 6 HSPA data devices”

Head SAR for VOIP operations under HSPA is not required when maximum average output of each RF channel with HSPA is less than 0.25 dB higher than as measured using 12.2 kbps RMC. Otherwise SAR is measured using same HSPA configuration as used for body SAR.

| Sub-test | β_c (Note 7) | β_d | β_d (SF) | β_c/β_d | β_{HS} (Note 1) | β_{ec} | β_{ed} (Note 4) (Note 5) | β_{ed} (SF) | β_{ed} (Codes) | CM (dB) (Note 2) | MPR (dB) (Note 2) (Note 6) | AG Index (Note 5) | E- TFCI |
|----------|-----------------------|-------------------|-------------------|-------------------|--------------------------|--------------|--|----------------------|-------------------------|------------------------|-------------------------------------|-------------------------|------------|
| 1 | 11/15 (Note 3) | 15/15 (Note 3) | 64 | 11/15 (Note 3) | 22/15 | 209/25 | 1309/225 | 4 | 1 | 1.0 | 0.0 | 20 | 75 |
| 2 | 6/15 | 15/15 | 64 | 6/15 | 12/15 | 12/15 | 94/75 | 4 | 1 | 3.0 | 2.0 | 12 | 67 |
| 3 | 15/15 | 9/15 | 64 | 15/9 | 30/15 | 30/15 | β_{ed1} : 47/15 β_{ed2} : 47/15 | 4 4 | 2 | 2.0 | 1.0 | 15 | 92 |
| 4 | 2/15 | 15/15 | 64 | 2/15 | 4/15 | 2/15 | 56/75 | 4 | 1 | 3.0 | 2.0 | 17 | 71 |
| 5 | 15/15 | 0 | - | - | 5/15 | 5/15 | 47/15 | 4 | 1 | 1.0 | 0.0 | 12 | 67 |

Note 1: For sub-test 1 to 4, Δ_{ACK} , Δ_{NACK} and $\Delta_{CQI} = 30/15$ with $\beta_{HS} = 30/15 * \beta_c$. For sub-test 5, Δ_{ACK} , Δ_{NACK} and $\Delta_{CQI} = 5/15$ with $\beta_{HS} = 5/15 * \beta_c$.

Note 2: CM = 1 for $\beta_c/\beta_d = 12/15$, $\beta_{HS}/\beta_c = 24/15$. For all other combinations of DPDCH, DPCCCH, HS- DPCCCH, E-DPDCH and E-DPCCCH the MPR is based on the relative CM difference.

Note 3: For subtest 1 the β_c/β_d ratio of 11/15 for the TFC during the measurement period (TF1, TF0) is achieved by setting the signalled gain factors for the reference TFC (TF1, TF0) to $\beta_c = 10/15$ and $\beta_d = 15/15$.

Note 4: In case of testing by UE using E-DPDCH Physical Layer category 1, Sub-test 3 is omitted according to TS25.306 Table 5.1g.

Note 5: β_{ed} can not be set directly; it is set by Absolute Grant Value.

Note 6: For subtests 2, 3 and 4, UE may perform E-DPDCH power scaling at max power which could results in slightly smaller MPR values.

Note 7: For CLTD Mode 1 test cases power is equally distributed between both the antenna ports.

Figure 9.2 Table C.10.1.4 of TS 134 121-1

9.4 SAR Testing with 802.11 Transmitters

Normal network operating configurations are not suitable for measuring the SAR of 802.11 b/g/n transmitters. Unpredictable fluctuations in network traffic and antenna diversity conditions can introduce undesirable variations in SAR results. The SAR for these devices should be measured using chipset based test mode software to ensure the results are consistent and reliable. See KDB Publication 248227 D01v01r02 for more details.

9.4.1 General Device Setup

Chipset based test mode software is hardware dependent and generally varies among manufacturers. The device operating parameters established in test mode for SAR measurements must be identical to those programmed in production units, including output power levels, amplifier gain settings and other RF performance tuning parameters. The test frequencies should correspond to actual channel frequencies defined for domestic use. SAR for devices with switched diversity should be measured with only one antenna transmitting at a time during each SAR measurement, according to a fixed modulation and data rate. The same data pattern should be used for all measurements.

9.4.2 Frequency Channel Configurations

802.11 a/b/g/n operating modes are tested independently according to the service requirements in each frequency band. 802.11 b/g/n modes are tested on channels 1, 6 and 11. 802.11 a is tested for UNII operations on channels 36 and 48 in the 5.15-5.25 GHz band; channels 52 and 64 in the 5.25-5.35 GHz band; channels 104, 116 and 136 in the 5.470-5.725 GHz band; and channels 149 and 161 in the 5.8 GHz. When 5.8 GHz §15.247 is also available, channels 149, 157 and 165 should be tested instead of the UNII channels. These are referred to as the “default test channels”. For 2.4 GHz, 802.11g/n modes were evaluated only if the output power was 0.25 dB higher than the 802.11 mode. For 5 GHz, 802.11n modes were evaluated only if the output power was 0.25 dB higher than the 802.11a mode. When the maximum extrapolated peak SAR of the zoom scan for the maximum output channel is < 1.6 W/kg and the 1g averaged SAR is < 0.8 W/kg, SAR testing in other channels is not required. Otherwise, the other default (or corresponding required) test channels were additionally tested using the lowest data rate.

| Mode | GHz | Channel | Turbo Channel | “Default Test Channels” | | | | |
|------------|---------|---------|----------------|-------------------------|---------|------|---|---|
| | | | | §15.247 | | UNII | | |
| | | | | 802.11b | 802.11g | | | |
| 802.11 b/g | 2.412 | 1* | | √ | ∇ | | | |
| | 2.437 | 6 | 6 | √ | ∇ | | | |
| | 2.462 | 11* | | √ | ∇ | | | |
| 802.11a | 5.18 | 36 | | | | √ | | |
| | 5.20 | 40 | 42 (5.21 GHz) | | | | * | |
| | 5.22 | 44 | | | | | * | |
| | 5.24 | 48 | 50 (5.25 GHz) | | | √ | | |
| | 5.26 | 52 | | | | √ | | |
| | 5.28 | 56 | 58 (5.29 GHz) | | | | * | |
| | 5.30 | 60 | | | | | * | |
| | 5.32 | 64 | | | | √ | | |
| | | 5.500 | 100 | Unknown | | | | * |
| | | 5.520 | 104 | | | | √ | * |
| | | 5.540 | 108 | | | | | * |
| | | 5.560 | 112 | | | | | * |
| | | 5.580 | 116 | | | | √ | * |
| | | 5.600 | 120 | | | | | * |
| | | 5.620 | 124 | | | | √ | * |
| | | 5.640 | 128 | | | | | * |
| | | 5.660 | 132 | | | | | * |
| | | 5.680 | 136 | | | | √ | * |
| | | 5.700 | 140 | | | | * | |
| | | 5.745 | 149 | | √ | | √ | |
| | 5.765 | 153 | 152 (5.76 GHz) | | * | | * | |
| | 5.785 | 157 | | √ | | | * | |
| | 5.805 | 161 | 160 (5.80 GHz) | | * | √ | | |
| | §15.247 | 5.825 | 165 | √ | | | | |

Table 9.1 802.11 Test channels per FCC Requirements

10. RF CONDUCTED POWERS

10.1 GSM Conducted Powers

Table 10.1 The power was measured by E5515C

| Band | Channel | Maximum Burst-Averaged Output Power (dBm) | | | | | | | | |
|-----------------|---------------------|--|-----------------------|----------------|----------------|----------------|-------------------|----------------|----------------|----------------|
| | | Voice | GPRS/EDGE Data (GMSK) | | | | EDGE Data (8-PSK) | | | |
| | | GSM CS 1 Slot | GPRS 1 TX Slot | GPRS 2 TX Slot | GPRS 3 TX Slot | GPRS 4 TX Slot | EDGE 1 TX Slot | EDGE 2 TX Slot | EDGE 3 TX Slot | EDGE 4 TX Slot |
| GSM 850 | 128 | 33.1 | 33.1 | 29.8 | 28.0 | 26.8 | 27.3 | 24.2 | 22.4 | 21.4 |
| | 190 | 33.1 | 33.1 | 29.7 | 28.0 | 26.8 | 27.2 | 24.1 | 22.4 | 21.3 |
| | 251 | 33.1 | 33.1 | 29.7 | 27.9 | 26.7 | 27.2 | 24.1 | 22.2 | 21.2 |
| PCS 1900 | 512 | 29.9 | 29.9 | 26.5 | 24.6 | 23.3 | 26.1 | 22.9 | 21.4 | 20.0 |
| | 661 | 29.7 | 29.7 | 26.4 | 24.5 | 23.2 | 25.8 | 22.7 | 21.2 | 19.8 |
| | 810 | 29.7 | 29.7 | 26.3 | 24.4 | 23.1 | 25.7 | 22.5 | 21.0 | 19.7 |
| Band | Channel | Calculated Maximum Frame-Averaged Output Power (dBm) | | | | | | | | |
| | | Voice | GPRS/EDGE Data (GMSK) | | | | EDGE Data (8-PSK) | | | |
| | | GSM CS 1 Slot | GPRS 1 TX Slot | GPRS 2 TX Slot | GPRS 3 TX Slot | GPRS 4 TX Slot | EDGE 1 TX Slot | EDGE 2 TX Slot | EDGE 3 TX Slot | EDGE 4 TX Slot |
| GSM 850 | 128 | 24.07 | 24.07 | 23.78 | 23.74 | 23.79 | 18.27 | 18.18 | 18.14 | 18.39 |
| | 190 | 24.07 | 24.07 | 23.68 | 23.74 | 23.79 | 18.17 | 18.08 | 18.14 | 18.29 |
| | 251 | 24.07 | 24.07 | 23.68 | 23.64 | 23.69 | 18.17 | 18.08 | 17.94 | 18.19 |
| PCS 1900 | 512 | 20.87 | 20.87 | 20.48 | 20.34 | 20.29 | 17.07 | 16.88 | 17.14 | 16.99 |
| | 661 | 20.67 | 20.67 | 20.38 | 20.24 | 20.19 | 16.77 | 16.68 | 16.94 | 16.79 |
| | 810 | 20.67 | 20.67 | 20.28 | 20.14 | 20.09 | 16.67 | 16.48 | 16.74 | 16.69 |
| GSM 850 | Frame Avg. Targets: | 23.67 | 23.67 | 23.28 | 23.24 | 23.29 | 17.97 | 17.78 | 17.74 | 17.99 |
| PCS 1900 | | 20.47 | 20.47 | 19.98 | 19.84 | 19.79 | 16.57 | 16.38 | 16.74 | 16.49 |

Note:

- Both burst-averaged and calculated frame-averaged powers are included. Frame-averaged power was calculated from the measured burst-averaged power by converting the slot powers into linear units and calculating the energy over 8 timeslots.
- The source-based frame-averaged output power was evaluated for all GPRS slot configurations. The configuration with the highest target frame averaged output power was evaluated for hotspot SAR. When the maximum frame-averaged powers are equivalent across two or more slots (within 0.25 dB), the configuration with the most number of time slots was tested.
- GPRS (GMSK) output powers were measured with coding scheme setting of 1 (CS1) on the base station simulator. CS1 was configured to measure GPRS output power measurements and SAR to ensure GMSK modulation in the signal. Our investigation has shown that CS1 - CS4 settings do not have any impact on the output levels or modulation in the GPRS modes.

GPRS Multislot class: 12 (max 4 TX Uplink slots)
 EDGE Multislot class: 12 (max 4 TX Uplink slots)
 DTM Multislot Class: N/A



Figure 10.1 Power Measurement Setup

10.2 WCDMA Conducted Powers

| 3GPP Release Version | Mode | 3GPP 34.121 Subtest | Cellular Band (dBm) | | | PCS Band (dBm) | | | 3GPP MPR (dB) |
|----------------------|-------|---------------------|---------------------|-------|-------|----------------|-------|-------|---------------|
| | | | 4132 | 4183 | 4233 | 9262 | 9400 | 9538 | |
| 99 | WCDMA | 12.2 kbps RMC | 23.97 | 23.96 | 23.97 | 24.30 | 24.20 | 23.97 | - |
| 99 | | 12.2 kbps AMR | 23.85 | 23.92 | 23.87 | 24.10 | 23.92 | 23.96 | - |
| 5 | HSDPA | Subtest 1 | 23.85 | 23.96 | 23.88 | 24.20 | 23.91 | 23.96 | 0 |
| 5 | | Subtest 2 | 23.88 | 23.94 | 23.90 | 23.90 | 23.93 | 23.96 | 0 |
| 5 | | Subtest 3 | 23.49 | 23.52 | 23.47 | 23.60 | 23.55 | 23.42 | 0.5 |
| 5 | | Subtest 4 | 23.50 | 23.53 | 23.48 | 23.50 | 23.56 | 23.39 | 0.5 |
| 6 | HSUPA | Subtest 1 | 23.80 | 23.88 | 23.85 | 23.70 | 23.85 | 23.90 | 0 |
| 6 | | Subtest 2 | 21.55 | 21.90 | 21.68 | 22.10 | 21.87 | 22.05 | 2 |
| 6 | | Subtest 3 | 22.48 | 22.52 | 22.51 | 22.80 | 22.53 | 22.67 | 1 |
| 6 | | Subtest 4 | 21.68 | 21.82 | 21.77 | 22.19 | 22.07 | 22.15 | 2 |
| 6 | | Subtest 5 | 23.81 | 23.89 | 23.86 | 23.67 | 23.81 | 23.85 | 0 |

Table 10.2 The power was measured by E5515C

WCDMA SAR was tested under RMC 12.2 kbps with HSPA Inactive per KDB Publication 941225 D01v03. HSPA SAR was not required since the average output power of the HSPA subtests was not more than 0.25 dB higher than the RMC level and SAR was less than 1.2 W/kg.



Figure 10.2 Power Measurement Setup

10.3 WLAN Conducted Powers

| Mode | Freq. | Channel | 802.11b (2.4 GHz) Conducted Power (dBm) | | | |
|---------|-------|---------|---|-------|-------|-------|
| | | | Data Rate (Mbps) | | | |
| | (MHz) | | 1 | 2 | 5.5 | 11 |
| 802.11b | 2412 | 1 | 15.93 | 15.86 | 15.77 | 15.87 |
| | 2437 | 6 | 16.13 | 16.08 | 15.99 | 15.85 |
| | 2462 | 11 | <u>16.19</u> | 16.07 | 16.01 | 16.14 |

Table 10.3 IEEE 802.11b Average RF Power

| Mode | Freq. | Channel | 802.11g (2.4 GHz) Conducted Power (dBm) | | | | | | | |
|---------|-------|---------|---|-------|-------|-------|-------|-------|-------|-------|
| | | | Data Rate (Mbps) | | | | | | | |
| | (MHz) | | 6 | 9 | 12 | 18 | 24 | 36 | 48 | 54 |
| 802.11g | 2412 | 1 | 12.35 | 12.27 | 12.18 | 12.19 | 12.26 | 12.16 | 12.19 | 12.33 |
| | 2437 | 6 | 14.04 | 13.78 | 13.97 | 12.98 | 13.86 | 13.95 | 13.95 | 14.01 |
| | 2462 | 11 | 12.65 | 12.49 | 12.61 | 12.51 | 12.55 | 12.58 | 12.47 | 12.62 |

Table 10.4 IEEE 802.11g Average RF Power

| Mode | Freq. | Channel | 802.11n HT20 (2.4 GHz) Conducted Power (dBm) | | | | | | | |
|--------------------|-------|---------|--|-------|-------|-------|-------|-------|-------|-------|
| | | | Data Rate (Mbps) | | | | | | | |
| | (MHz) | | 6.5 | 13 | 19.5 | 26 | 39 | 52 | 58.5 | 65 |
| 802.11n (HT-20) | 2412 | 1 | 11.86 | 11.79 | 11.71 | 11.82 | 11.77 | 11.68 | 11.81 | 11.73 |
| | 2437 | 6 | 12.11 | 11.97 | 12.05 | 11.94 | 11.92 | 11.95 | 11.99 | 11.89 |
| | 2462 | 11 | 12.17 | 12.14 | 12.11 | 12.15 | 12.09 | 11.98 | 11.95 | 12.04 |

Table 10.5 IEEE 802.11n HT20 Average RF Power

| Mode | Freq. | Channel | 802.11a (5 GHz) Conducted Power (dBm) | | | | | | | |
|---------|-------|---------|---------------------------------------|-------|-------|-------|-------|-------|-------|-------|
| | | | Data Rate (Mbps) | | | | | | | |
| | (MHz) | | 6 | 9 | 12 | 18 | 24 | 36 | 48 | 54 |
| 802.11a | 5180 | 36 | 10.97 | 10.76 | 10.91 | 10.89 | 10.90 | 10.71 | 10.78 | 10.73 |
| | 5200 | 40 | 11.15 | 10.93 | 11.08 | 11.01 | 11.07 | 11.02 | 10.97 | 10.90 |
| | 5240 | 48 | <u>11.51</u> | 11.35 | 11.48 | 11.25 | 11.37 | 11.35 | 11.22 | 11.37 |
| | 5260 | 52 | 11.95 | 11.76 | 11.90 | 11.82 | 11.69 | 11.80 | 11.81 | 11.91 |
| | 5300 | 60 | 12.45 | 12.21 | 12.33 | 12.29 | 12.32 | 12.32 | 12.33 | 12.34 |
| | 5320 | 64 | <u>12.76</u> | 12.51 | 12.64 | 12.61 | 12.60 | 12.58 | 12.72 | 12.68 |
| | 5500 | 100 | 12.8 | 12.66 | 12.52 | 12.67 | 12.65 | 12.64 | 12.64 | 12.67 |
| | 5580 | 116 | <u>12.83</u> | 12.79 | 12.76 | 12.65 | 12.70 | 12.71 | 12.66 | 12.77 |
| | 5700 | 140 | 10.85 | 10.74 | 10.81 | 10.69 | 10.67 | 10.60 | 10.79 | 10.8 |
| | 5745 | 149 | <u>10.45</u> | 10.37 | 10.40 | 10.21 | 10.29 | 10.36 | 10.38 | 10.43 |
| | 5785 | 157 | 10.20 | 10.07 | 10.13 | 9.95 | 10.08 | 10.01 | 10.06 | 10.06 |
| | 5825 | 165 | 9.96 | 9.90 | 9.88 | 9.82 | 9.87 | 9.78 | 9.84 | 9.80 |

Table 10.6 IEEE 802.11a Average RF Power

| Mode | Freq. (MHz) | Channel | 802.11n HT20 (5 GHz) Conducted Power (dBm) | | | | | | | |
|--------------------|----------------|---------|--|-------|-------|-------|-------|-------|-------|-------|
| | | | Data Rate (Mbps) | | | | | | | |
| | | | 6.5 | 13 | 19.5 | 26 | 39 | 52 | 58.5 | 65 |
| 802.11n (HT-20) | 5180 | 36 | 9.91 | 9.77 | 9.78 | 9.83 | 9.89 | 9.79 | 9.77 | 9.65 |
| | 5200 | 40 | 10.12 | 10.00 | 9.96 | 9.99 | 9.98 | 9.88 | 9.97 | 9.99 |
| | 5240 | 48 | 10.44 | 10.40 | 10.29 | 10.38 | 10.22 | 10.19 | 10.31 | 10.28 |
| | 5260 | 52 | 10.95 | 10.79 | 10.82 | 10.90 | 10.91 | 10.81 | 10.77 | 10.80 |
| | 5300 | 60 | 11.42 | 11.25 | 11.14 | 11.4 | 11.26 | 11.38 | 11.26 | 11.29 |
| | 5320 | 64 | 11.70 | 11.64 | 11.54 | 11.56 | 11.53 | 11.59 | 11.46 | 11.52 |
| | 5500 | 100 | 11.81 | 11.74 | 11.69 | 11.65 | 11.75 | 11.73 | 11.56 | 11.65 |
| | 5580 | 116 | 11.83 | 11.8 | 11.69 | 11.71 | 11.76 | 11.70 | 11.69 | 11.59 |
| | 5700 | 140 | 9.86 | 9.81 | 9.77 | 9.72 | 9.58 | 9.80 | 9.82 | 9.61 |
| | 5745 | 149 | 9.42 | 9.30 | 9.23 | 9.33 | 9.37 | 9.37 | 9.31 | 9.28 |
| | 5785 | 157 | 9.10 | 8.98 | 8.92 | 8.91 | 9.05 | 9.08 | 9.02 | 9.06 |
| | 5825 | 165 | 8.85 | 8.57 | 8.83 | 8.67 | 8.83 | 8.71 | 8.72 | 8.74 |

Table 10.7 IEEE 802.11n HT20 Average RF Power

Justification for reduced test configurations for WIFI channels per KDB Publication 248227 D01v01r02 and October 2012 / April 2013 FCC/TCB Meeting Notes:

- For 2.4 GHz, highest average RF output power channel for the lowest data rate for IEEE 802.11b were selected for SAR evaluation. Other IEEE 802.11 modes (including 802.11g/n) were not investigated since the average output powers over all channels and data rates were not more than 0.25 dB higher than the tested channel in the lowest data rate of IEEE 802.11b mode.
- For 5 GHz, highest average RF output channel for the lowest data for IEEE 802.11a were selected for SAR evaluation. Other IEEE 802.11 modes (including 802.11n) were not investigated since the average output powers over all channels and data rates were not more than 0.25 dB higher than the tested channel in the lowest data rate of IEEE 802.11a mode.
- When the maximum extrapolated peak SAR of the zoom scan for the maximum output channel is <math>< 1.6 \text{ W/kg}</math> and the reported 1g averaged SAR is <math>< 0.8 \text{ W/kg}</math>, SAR testing on other channels is not required. Otherwise, the other default (or corresponding required) test channels were additionally tested using the lowest data rate.
- The underlined data rate and channel above were tested for SAR.

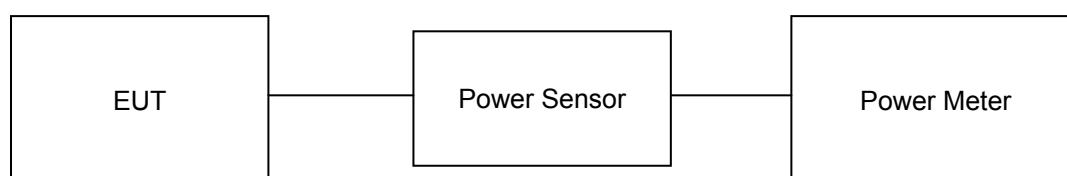

Figure 10.3 Power Measurement Setup

10.4 Bluetooth Conducted Powers

| Channel | Frequency | Frame AVG Output Power (1Mbps) | | Frame AVG Output Power (2Mbps) | | Frame AVG Output Power (3Mbps) | |
|---------|-----------|--------------------------------|--------------|--------------------------------|-------|--------------------------------|-------|
| | (MHz) | (dBm) | (mW) | (dBm) | (mW) | (dBm) | (mW) |
| Low | 2402 | 1.95 | 1.567 | -4.74 | 0.336 | -4.73 | 0.337 |
| Mid | 2441 | 2.81 | 1.910 | -3.69 | 0.428 | -3.67 | 0.430 |
| High | 2480 | 2.60 | 1.820 | -3.82 | 0.415 | -3.79 | 0.418 |

Table 10.8 Bluetooth Frame Average RF Power

Note:

The average conducted output powers of Bluetooth were measured using following test setup and a wideband gated RF power meter when the EUT is transmitting at its maximum power level.

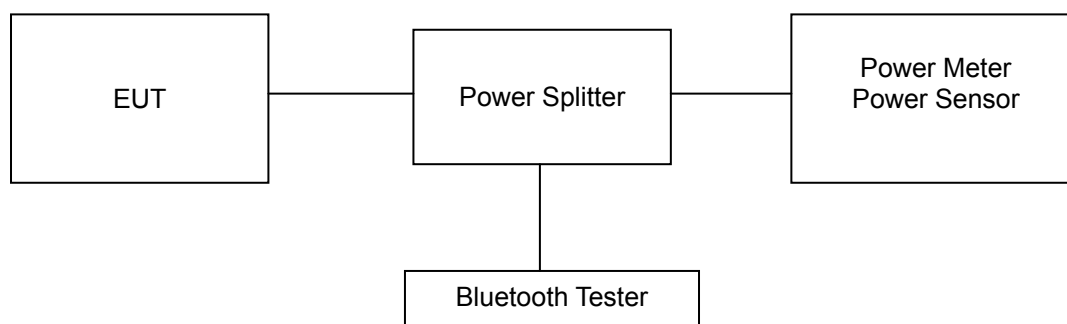

Figure 10.4 Power Measurement Setup

11. SYSTEM VERIFICATION

11.1 Tissue Verification

| MEASURED TISSUE PARAMETERS | | | | | | | | | | |
|----------------------------|-------------|-------------------|------------------|--------------------------|--|-------------------------------------|--|---------------------------------------|------------------|------------------------|
| Date(s) | Tissue Type | Ambient Temp.[°C] | Liquid Temp.[°C] | Measured Frequency [MHz] | Target Dielectric Constant, ϵ_r | Target Conductivity, σ (S/m) | Measured Dielectric Constant, ϵ_r | Measured Conductivity, σ (S/m) | Er Deviation [%] | σ Deviation [%] |
| Nov.05. 2014 | 835 Head | 21.2 | 21.6 | 824.2 | 41.540 | 0.899 | 40.94 | 0.8891 | -1.44 | -1.10 |
| | | | | 835.0 | 41.500 | 0.900 | 40.85 | 0.8998 | -1.57 | -0.02 |
| | | | | 836.6 | 41.500 | 0.902 | 40.84 | 0.9012 | -1.59 | -0.09 |
| | | | | 848.8 | 41.500 | 0.912 | 40.74 | 0.9124 | -1.83 | 0.04 |
| Nov.05. 2014 | 835 Body | 21.2 | 21.6 | 824.2 | 55.230 | 0.969 | 53.9 | 0.9656 | -2.41 | -0.35 |
| | | | | 835.0 | 55.200 | 0.970 | 54.26 | 0.9782 | -1.70 | 0.85 |
| | | | | 836.6 | 55.195 | 0.972 | 54.30 | 0.9799 | -1.62 | 0.81 |
| | | | | 848.8 | 55.160 | 0.984 | 54.54 | 0.9932 | -1.12 | 0.93 |
| Nov.06. 2014 | 1900 Head | 21.4 | 21.8 | 1850.2 | 40.000 | 1.400 | 38.86 | 1.380 | -2.85 | -1.43 |
| | | | | 1880.0 | 40.000 | 1.400 | 38.78 | 1.408 | -3.05 | 0.57 |
| | | | | 1900.0 | 40.000 | 1.400 | 38.71 | 1.428 | -3.23 | 2.00 |
| | | | | 1909.8 | 40.000 | 1.400 | 38.68 | 1.438 | -3.30 | 2.71 |
| Nov.06. 2014 | 1900 Body | 21.4 | 21.8 | 1850.2 | 53.300 | 1.520 | 53.07 | 1.504 | -0.43 | -1.05 |
| | | | | 1880.0 | 53.300 | 1.520 | 53.03 | 1.533 | -0.51 | 0.86 |
| | | | | 1900.0 | 53.300 | 1.520 | 52.99 | 1.552 | -0.58 | 2.11 |
| | | | | 1909.8 | 53.300 | 1.520 | 52.97 | 1.562 | -0.62 | 2.76 |
| Nov.07. 2014 | 835 Head | 21.7 | 22.1 | 826.4 | 41.540 | 0.899 | 41.10 | 0.8929 | -1.06 | -0.68 |
| | | | | 835.0 | 41.500 | 0.900 | 41.02 | 0.9009 | -1.16 | 0.10 |
| | | | | 836.6 | 41.500 | 0.902 | 41.00 | 0.9025 | -1.20 | 0.06 |
| | | | | 846.6 | 41.500 | 0.912 | 40.91 | 0.9118 | -1.42 | -0.02 |
| Nov.07. 2014 | 835 Body | 21.7 | 22.1 | 826.4 | 55.230 | 0.969 | 53.59 | 0.9673 | -2.97 | -0.18 |
| | | | | 835.0 | 55.200 | 0.970 | 53.54 | 0.9751 | -3.01 | 0.53 |
| | | | | 836.6 | 55.195 | 0.972 | 53.53 | 0.9763 | -3.02 | 0.44 |
| | | | | 846.6 | 55.160 | 0.984 | 53.47 | 0.9851 | -3.06 | 0.11 |
| Nov.10. 2014 | 1900 Head | 21.3 | 21.7 | 1852.4 | 40.000 | 1.400 | 39.49 | 1.380 | -1.28 | -1.43 |
| | | | | 1880.0 | 40.000 | 1.400 | 39.36 | 1.407 | -1.60 | 0.50 |
| | | | | 1900.0 | 40.000 | 1.400 | 39.26 | 1.426 | -1.85 | 1.86 |
| | | | | 1907.6 | 40.000 | 1.400 | 39.22 | 1.434 | -1.95 | 2.43 |
| Nov.10. 2014 | 1900 Body | 21.3 | 21.7 | 1852.4 | 53.300 | 1.520 | 51.68 | 1.508 | -3.04 | -0.79 |
| | | | | 1880.0 | 53.300 | 1.520 | 51.80 | 1.532 | -2.81 | 0.79 |
| | | | | 1900.0 | 53.300 | 1.520 | 51.85 | 1.551 | -2.72 | 2.04 |
| | | | | 1907.6 | 53.300 | 1.520 | 51.87 | 1.559 | -2.68 | 2.57 |
| Nov.11. 2014 | 2450 Head | 21.5 | 21.9 | 2412 | 39.268 | 1.766 | 38.13 | 1.752 | -2.90 | -0.79 |
| | | | | 2437 | 39.223 | 1.788 | 38.05 | 1.778 | -2.99 | -0.56 |
| | | | | 2450 | 39.200 | 1.800 | 38.00 | 1.791 | -3.06 | -0.50 |
| | | | | 2462 | 39.184 | 1.813 | 37.76 | 1.802 | -3.63 | -0.61 |
| Nov.11. 2014 | 2450 Body | 21.5 | 21.9 | 2412 | 52.751 | 1.914 | 52.99 | 1.920 | 0.45 | 0.31 |
| | | | | 2437 | 52.717 | 1.938 | 52.9 | 1.947 | 0.35 | 0.46 |
| | | | | 2450 | 52.700 | 1.950 | 52.85 | 1.960 | 0.28 | 0.51 |
| | | | | 2462 | 52.685 | 1.967 | 52.81 | 1.972 | 0.24 | 0.25 |
| Nov.12. 2014 | 5200 Head | 21.9 | 22.3 | 5200 | 36.000 | 4.660 | 35.40 | 4.694 | -1.67 | 0.73 |
| | | | | 5210 | 35.980 | 4.670 | 35.38 | 4.708 | -1.67 | 0.81 |
| | | | | 5240 | 35.960 | 4.700 | 35.33 | 4.739 | -1.75 | 0.83 |
| Nov.12. 2014 | 5200 Body | 21.9 | 22.3 | 5200 | 49.01 | 5.300 | 48.68 | 5.192 | -0.67 | -2.04 |
| | | | | 5210 | 49.00 | 5.310 | 48.66 | 5.205 | -0.69 | -1.98 |
| | | | | 5240 | 48.96 | 5.350 | 48.60 | 5.249 | -0.74 | -1.89 |

| MEASURED TISSUE PARAMETERS | | | | | | | | | | |
|----------------------------|-------------|-------------------|------------------|--------------------------|--|-------------------------------------|--|---------------------------------------|------------------|------------------------|
| Date(s) | Tissue Type | Ambient Temp.[°C] | Liquid Temp.[°C] | Measured Frequency [MHz] | Target Dielectric Constant, ϵ_r | Target Conductivity, σ (S/m) | Measured Dielectric Constant, ϵ_r | Measured Conductivity, σ (S/m) | Er Deviation [%] | σ Deviation [%] |
| Nov.13. 2014 | 5300 Head | 21.4 | 21.8 | 5290 | 35.910 | 4.750 | 34.99 | 4.763 | -2.56 | 0.27 |
| | | | | 5300 | 35.900 | 4.760 | 34.97 | 4.771 | -2.59 | 0.23 |
| | | | | 5320 | 35.880 | 4.780 | 34.93 | 4.797 | -2.65 | 0.36 |
| Nov.13. 2014 | 5300 Body | 21.4 | 21.8 | 5290 | 48.890 | 5.400 | 48.44 | 5.295 | -0.92 | -1.94 |
| | | | | 5300 | 48.880 | 5.420 | 48.41 | 5.304 | -0.96 | -2.14 |
| | | | | 5320 | 48.850 | 5.440 | 48.36 | 5.330 | -1.00 | -2.02 |
| Nov.14. 2014 | 5600 Head | 21.7 | 22.1 | 5500 | 35.650 | 4.970 | 35.04 | 5.086 | -1.71 | 2.33 |
| | | | | 5530 | 35.610 | 5.000 | 34.98 | 5.118 | -1.77 | 2.36 |
| | | | | 5580 | 35.530 | 5.050 | 34.89 | 5.179 | -1.80 | 2.55 |
| | | | | 5600 | 35.500 | 5.070 | 34.86 | 5.209 | -1.80 | 2.74 |
| Nov.14. 2014 | 5600 Body | 21.7 | 22.1 | 5500 | 48.610 | 5.650 | 47.37 | 5.614 | -2.55 | -0.64 |
| | | | | 5530 | 48.570 | 5.680 | 47.31 | 5.650 | -2.59 | -0.53 |
| | | | | 5580 | 48.500 | 5.740 | 47.23 | 5.716 | -2.62 | -0.42 |
| | | | | 5600 | 48.470 | 5.770 | 47.20 | 5.747 | -2.62 | -0.40 |
| Nov.15. 2014 | 5800 Head | 21.6 | 22.0 | 5745 | 35.360 | 5.220 | 34.59 | 5.365 | -2.18 | 2.78 |
| | | | | 5775 | 35.330 | 5.250 | 34.54 | 5.400 | -2.24 | 2.86 |
| | | | | 5800 | 35.300 | 5.270 | 34.48 | 5.430 | -2.32 | 3.04 |
| Nov.15. 2014 | 5800 Body | 21.6 | 22.0 | 5745 | 48.270 | 5.940 | 47.20 | 5.930 | -2.22 | -0.17 |
| | | | | 5775 | 48.230 | 5.970 | 47.15 | 5.972 | -2.24 | 0.03 |
| | | | | 5800 | 48.200 | 6.000 | 47.10 | 6.008 | -2.28 | 0.13 |

The above measured tissue parameters were used in the DASY software. The DASY software was used to perform interpolation to determine the dielectric parameters at the SAR test device frequencies (per KDB 865664 and IEEE 1528-2013 6.6.1.2). The tissue parameters listed in the SAR test plots may slightly differ from the table above due to significant digit rounding in the software.

Measurement Procedure for Tissue verification:

- 1) The network analyzer and probe system was configured and calibrated.
- 2) The probe was immersed in the sample which was placed in a nonmetallic container. Trapped air bubbles beneath the flange were minimized by placing the probe at a slight angle.
- 3) The complex admittance with respect to the probe aperture was measured
- 4) The complex relative permittivity, for example from the below equation (Pournaropoulos and Misra):

$$Y = \frac{j2\omega\epsilon_r\epsilon_0}{[\ln(b/a)]^2} \int_a^b \int_a^b \int_0^\pi \cos\phi' \frac{\exp[-j\omega r(\mu_0\epsilon_r\epsilon_0)^{1/2}]}{r} d\phi' d\rho' d\rho$$

where Y is the admittance of the probe in contact with the sample, the primed and unprimed coordinates refer to source and observation points, respectively, $r^2 = \rho^2 + \rho'^2 - 2\rho\rho'\cos\phi'$, ω is the angular frequency, and $j = \sqrt{-1}$.

11.2 Test System Verification

Prior to assessment, the system is verified to the $\pm 10\%$ of the specifications at 835 MHz, 1900 MHz, 2450 MHz and 5000 MHz by using the SAR Dipole kit(s). (Graphic Plots Attached)

Table 11.1 System Verification Results

| SYSTEM DIPOLE VERIFICATION TARGET & MEASURED | | | | | | | | | | | | |
|--|-------------|--------------------|---------------|-------------|-------------------|------------------|-----------|------------------|-------------------------------------|-----------------------------------|---|---------------|
| SAR System # | Freq. [MHz] | SAR Dipole kits | Date(s) | Tissue Type | Ambient Temp.[°C] | Liquid Temp.[°C] | Probe S/N | Input Power (mW) | 1 W Target SAR _{1g} (W/kg) | Measured SAR _{1g} (W/kg) | 1 W Normalized SAR _{1g} (W/kg) | Deviation [%] |
| B | 835 | D835V2, SN:464 | Nov. 05. 2014 | Head | 21.2 | 21.6 | 3866 | 250 | 9.28 | 2.3 | 9.2 | -0.86 |
| B | 835 | D835V2, SN: 464 | Nov. 05. 2014 | Body | 21.2 | 21.6 | 3866 | 250 | 9.35 | 2.51 | 10.04 | 7.38 |
| B | 1900 | D1900V2, SN:5d029 | Nov. 06. 2014 | Head | 21.4 | 21.8 | 3866 | 250 | 38.50 | 9.33 | 37.32 | -3.06 |
| B | 1900 | D1900V2, SN: 5d029 | Nov. 06. 2014 | Body | 21.4 | 21.8 | 3866 | 250 | 38.30 | 10.3 | 41.2 | 7.57 |
| B | 835 | D835V2, SN:464 | Nov. 07. 2014 | Head | 21.7 | 22.1 | 3866 | 250 | 9.28 | 2.31 | 9.24 | -0.43 |
| B | 835 | D835V2, SN: 464 | Nov. 07. 2014 | Body | 21.7 | 22.1 | 3866 | 250 | 9.35 | 2.5 | 10.0 | 6.95 |
| B | 1900 | D1900V2, SN:5d029 | Nov. 10. 2014 | Head | 21.3 | 21.7 | 3866 | 250 | 38.50 | 9.61 | 38.44 | -0.16 |
| B | 1900 | D1900V2, SN: 5d029 | Nov. 10. 2014 | Body | 21.3 | 21.7 | 3866 | 250 | 38.30 | 10.2 | 40.8 | 6.53 |
| B | 2450 | D2450V2, SN:726 | Nov. 11. 2014 | Head | 21.5 | 21.9 | 3866 | 250 | 52.2 | 13.3 | 53.2 | 1.92 |
| B | 2450 | D2450V2, SN: 726 | Nov. 11. 2014 | Body | 21.5 | 21.9 | 3866 | 250 | 48.6 | 12.9 | 51.6 | 6.17 |
| B | 5200 | D5GV2, SN:1103 | Nov. 12. 2014 | Head | 21.9 | 22.3 | 3866 | 100 | 79.4 | 7.89 | 78.9 | -0.63 |
| B | 5200 | D5GV2, SN:1103 | Nov. 12. 2014 | Body | 21.9 | 22.3 | 3866 | 100 | 75.5 | 7.12 | 71.2 | -5.70 |
| B | 5300 | D5GV2, SN:1103 | Nov. 13. 2014 | Head | 21.4 | 21.8 | 3866 | 100 | 85.1 | 8.35 | 83.5 | -1.88 |
| B | 5300 | D5GV2, SN:1103 | Nov. 13. 2014 | Body | 21.4 | 21.8 | 3866 | 100 | 78.6 | 7.31 | 73.1 | -6.99 |
| B | 5600 | D5GV2, SN:1103 | Nov. 14. 2014 | Head | 21.7 | 22.1 | 3866 | 100 | 83.6 | 8.49 | 84.9 | 1.56 |
| B | 5600 | D5GV2, SN:1103 | Nov. 14. 2014 | Body | 21.7 | 22.1 | 3866 | 100 | 82.0 | 7.98 | 79.8 | -2.68 |
| B | 5800 | D5GV2, SN:1103 | Nov. 15. 2014 | Head | 21.6 | 22.0 | 3866 | 100 | 80.8 | 8.47 | 84.7 | 4.83 |
| B | 5800 | D5GV2, SN:1103 | Nov. 15. 2014 | Body | 21.6 | 22.0 | 3866 | 100 | 77.2 | 7.54 | 75.4 | -2.33 |

Table 11.2 System Verification Results – Extremity SAR

| SYSTEM DIPOLE VERIFICATION TARGET & MEASURED | | | | | | | | | | | | |
|--|-------------|--------------------|---------------|-------------|--------------------|-------------------|-----------|------------------|-------------------------------------|------------------------------------|--|---------------|
| SAR System # | Freq. [MHz] | SAR Dipole kits | Date(s) | Tissue Type | Ambient Temp. [°C] | Liquid Temp. [°C] | Probe S/N | Input Power (mW) | 1W Target SAR _{10g} (W/kg) | Measured SAR _{10g} (W/kg) | 1 W Normalized SAR _{10g} (W/kg) | Deviation [%] |
| B | 835 | D835V2, SN:464 | Nov. 05. 2014 | Head | 21.2 | 21.6 | 3866 | 250 | 6.02 | 1.52 | 6.08 | 1.00 |
| B | 835 | D835V2, SN: 464 | Nov. 05. 2014 | Body | 21.2 | 21.6 | 3866 | 250 | 6.12 | 1.65 | 6.6 | 7.84 |
| B | 1900 | D1900V2, SN:5d029 | Nov. 06. 2014 | Head | 21.4 | 21.8 | 3866 | 250 | 20.1 | 4.82 | 19.28 | -4.08 |
| B | 1900 | D1900V2, SN: 5d029 | Nov. 06. 2014 | Body | 21.4 | 21.8 | 3866 | 250 | 20.3 | 5.33 | 21.32 | 5.02 |
| B | 835 | D835V2, SN:464 | Nov. 07. 2014 | Head | 21.7 | 22.1 | 3866 | 250 | 6.02 | 1.54 | 6.16 | 2.33 |
| B | 835 | D835V2, SN: 464 | Nov. 07. 2014 | Body | 21.7 | 22.1 | 3866 | 250 | 6.12 | 1.63 | 6.52 | 6.54 |
| B | 1900 | D1900V2, SN:5d029 | Nov. 10. 2014 | Head | 21.3 | 21.7 | 3866 | 250 | 20.1 | 4.96 | 19.84 | -1.29 |
| B | 1900 | D1900V2, SN: 5d029 | Nov. 10. 2014 | Body | 21.3 | 21.7 | 3866 | 250 | 20.3 | 5.42 | 21.68 | 6.79 |
| B | 2450 | D2450V2, SN:726 | Nov. 11. 2014 | Head | 21.5 | 21.9 | 3866 | 250 | 24.3 | 5.97 | 23.88 | -1.73 |
| B | 2450 | D2450V2, SN: 726 | Nov. 11. 2014 | Body | 21.5 | 21.9 | 3866 | 250 | 22.8 | 6.18 | 24.72 | 8.42 |
| B | 5200 | D5GV2, SN:1103 | Nov. 12. 2014 | Head | 21.9 | 22.3 | 3866 | 100 | 22.8 | 2.23 | 22.3 | -2.19 |
| B | 5200 | D5GV2, SN:1103 | Nov. 12. 2014 | Body | 21.9 | 22.3 | 3866 | 100 | 21.0 | 1.96 | 19.6 | -6.67 |
| B | 5300 | D5GV2, SN:1103 | Nov. 13. 2014 | Head | 21.4 | 21.8 | 3866 | 100 | 24.4 | 2.38 | 23.8 | -2.46 |
| B | 5300 | D5GV2, SN:1103 | Nov. 13. 2014 | Body | 21.4 | 21.8 | 3866 | 100 | 21.8 | 2.02 | 20.2 | -7.34 |
| B | 5600 | D5GV2, SN:1103 | Nov. 14. 2014 | Head | 21.7 | 22.1 | 3866 | 100 | 23.8 | 2.39 | 23.9 | 0.42 |
| B | 5600 | D5GV2, SN:1103 | Nov. 14. 2014 | Body | 21.7 | 22.1 | 3866 | 100 | 22.6 | 2.23 | 22.3 | -1.33 |
| B | 5800 | D5GV2, SN:1103 | Nov. 15. 2014 | Head | 21.6 | 22.0 | 3866 | 100 | 23.0 | 2.39 | 23.9 | 3.91 |
| B | 5800 | D5GV2, SN:1103 | Nov. 15. 2014 | Body | 21.6 | 22.0 | 3866 | 100 | 21.1 | 2.14 | 21.4 | 1.42 |

Note1 : System Verification was measured with input 250 mW and normalized to 1W.

Note2 : To confirm the proper SAR liquid depth, the z-axis plots from the system verifications were included since the system verifications were performed using the same liquid, probe and DAE as the SAR tests in the same time period.

Note3: Full system validation status and results can be found in Attachment 3.

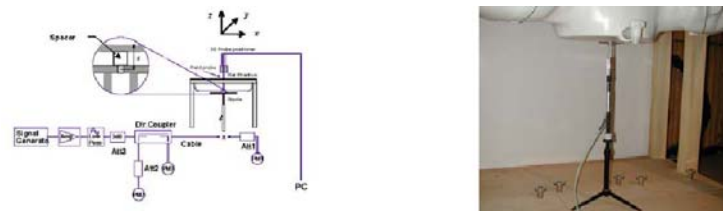

Figure 11.1 Dipole Verification Test Setup Diagram & Photo

12. SAR TEST RESULTS

12.1 Head SAR Results

Table 12.1 GSM/GPRS 850 Head SAR

| MEASUREMENT RESULTS | | | | | | | | | | | | | | |
|---|-----|---------------|---------|--------------------------------------|-----------------------------|------------------------|---------------------|---|-----------------------|---------------|---------------------|-------------------|-------------------------------|------------|
| FREQUENCY | | Mode/ Band | Service | Maximum Allowed Power [dBm] | Conducted Power [dBm] | Drift Power [dB] | Phantom Position | Device Serial Number | # of Time Slots | Duty Cycle | 1g SAR (W/kg) | Scaling Factor | 1g Scaled SAR (W/kg) | Plots # |
| MHz | Ch | | | | | | | | | | | | | |
| 836.6 | 190 | GSM850 | GSM | 33.2 | 33.1 | -0.150 | Left Touch | FCC #1 | 1 | 1:8.3 | 0.364 | 1.023 | 0.372 | |
| 836.6 | 190 | GSM850 | GSM | 33.2 | 33.1 | -0.140 | Right Touch | FCC #1 | 1 | 1:8.3 | 0.317 | 1.023 | 0.324 | |
| 836.6 | 190 | GSM850 | GSM | 33.2 | 33.1 | -0.050 | Left Tilt | FCC #1 | 1 | 1:8.3 | 0.223 | 1.023 | 0.228 | |
| 836.6 | 190 | GSM850 | GSM | 33.2 | 33.1 | -0.170 | Right Tilt | FCC #1 | 1 | 1:8.3 | 0.185 | 1.023 | 0.189 | |
| 836.6 | 190 | GSM850 | GPRS | 33.2 | 33.1 | 0.180 | Left Touch | FCC #1 | 1 | 1:8.3 | 0.383 | 1.023 | 0.392 | A1 |
| 836.6 | 190 | GSM850 | GPRS | 29.8 | 29.7 | -0.180 | Left Touch | FCC #1 | 2 | 1:4.15 | 0.321 | 1.023 | 0.328 | |
| 836.6 | 190 | GSM850 | GPRS | 28.0 | 28.0 | -0.050 | Left Touch | FCC #1 | 3 | 1:2.77 | 0.296 | 1.000 | 0.296 | |
| 836.6 | 190 | GSM850 | GPRS | 26.8 | 26.8 | 0.090 | Left Touch | FCC #1 | 4 | 1:2.075 | 0.302 | 1.000 | 0.302 | |
| 836.6 | 190 | GSM850 | GPRS | 33.2 | 33.1 | -0.190 | Right Touch | FCC #1 | 1 | 1:8.3 | 0.320 | 1.023 | 0.327 | |
| 836.6 | 190 | GSM850 | GPRS | 33.2 | 33.1 | 0.050 | Left Tilt | FCC #1 | 1 | 1:8.3 | 0.228 | 1.023 | 0.233 | |
| 836.6 | 190 | GSM850 | GPRS | 33.2 | 33.1 | -0.030 | Right Tilt | FCC #1 | 1 | 1:8.3 | 0.195 | 1.023 | 0.199 | |
| ANSI / IEEE C95.1-2005- SAFETY LIMIT Spatial Peak Uncontrolled Exposure/General Population Exposure | | | | | | | | Head 1.6 W/kg (mW/g) averaged over 1 gram | | | | | | |

Table 12.2 GSM/GPRS 1900 Head SAR

| MEASUREMENT RESULTS | | | | | | | | | | | | | | |
|---|-----|---------------|---------|--------------------------------------|-----------------------------|------------------------|---------------------|---|-----------------------|---------------|---------------------|-------------------|-------------------------------|------------|
| FREQUENCY | | Mode/ Band | Service | Maximum Allowed Power [dBm] | Conducted Power [dBm] | Drift Power [dB] | Phantom Position | Device Serial Number | # of Time Slots | Duty Cycle | 1g SAR (W/kg) | Scaling Factor | 1g Scaled SAR (W/kg) | Plots # |
| MHz | Ch | | | | | | | | | | | | | |
| 1880.0 | 661 | PCS1900 | GSM | 30.0 | 29.7 | 0.170 | Left Touch | FCC #1 | 1 | 1:8.3 | 0.0472 | 1.072 | 0.051 | |
| 1880.0 | 661 | PCS1900 | GSM | 30.0 | 29.7 | 0.170 | Right Touch | FCC #1 | 1 | 1:8.3 | 0.0485 | 1.072 | 0.052 | |
| 1880.0 | 661 | PCS1900 | GSM | 30.0 | 29.7 | 0.190 | Left Tilt | FCC #1 | 1 | 1:8.3 | 0.0166 | 1.072 | 0.018 | |
| 1880.0 | 661 | PCS1900 | GSM | 30.0 | 29.7 | -0.110 | Right Tilt | FCC #1 | 1 | 1:8.3 | 0.0157 | 1.072 | 0.017 | |
| 1880.0 | 661 | PCS1900 | GPRS | 30.0 | 29.7 | 0.130 | Left Touch | FCC #1 | 1 | 1:8.3 | 0.0474 | 1.072 | 0.051 | |
| 1880.0 | 661 | PCS1900 | GPRS | 30.0 | 29.7 | -0.040 | Right Touch | FCC #1 | 1 | 1:8.3 | 0.0490 | 1.072 | 0.053 | A2 |
| 1880.0 | 661 | PCS1900 | GPRS | 26.5 | 26.4 | 0.080 | Right Touch | FCC #1 | 2 | 1:4.15 | 0.0475 | 1.023 | 0.049 | |
| 1880.0 | 661 | PCS1900 | GPRS | 24.6 | 24.5 | 0.190 | Right Touch | FCC #1 | 3 | 1:2.77 | 0.0360 | 1.023 | 0.037 | |
| 1880.0 | 661 | PCS1900 | GPRS | 23.3 | 23.2 | 0.150 | Right Touch | FCC #1 | 4 | 1:2.075 | 0.0393 | 1.023 | 0.040 | |
| 1880.0 | 661 | PCS1900 | GPRS | 30.0 | 29.7 | 0.060 | Left Tilt | FCC #1 | 1 | 1:8.3 | 0.0200 | 1.072 | 0.021 | |
| 1880.0 | 661 | PCS1900 | GPRS | 30.0 | 29.7 | 0.150 | Right Tilt | FCC #1 | 1 | 1:8.3 | 0.0199 | 1.072 | 0.021 | |
| ANSI / IEEE C95.1-2005- SAFETY LIMIT Spatial Peak Uncontrolled Exposure/General Population Exposure | | | | | | | | Head 1.6 W/kg (mW/g) averaged over 1 gram | | | | | | |

Table 12.3 WCDMA 850 Head SAR

| MEASUREMENT RESULTS | | | | | | | | | | | | | |
|---|------|---------------|---------|--------------------------------------|-----------------------------|------------------------|---------------------|----------------------------|---|---------------------|-------------------|-------------------------------|------------|
| FREQUENCY | | Mode/ Band | Service | Maximum Allowed Power [dBm] | Conducted Power [dBm] | Drift Power [dB] | Phantom Position | Device Serial Number | Duty Cycle | 1g SAR (W/kg) | Scaling Factor | 1g Scaled SAR (W/kg) | Plots # |
| MHz | Ch | | | | | | | | | | | | |
| 836.6 | 4183 | WCDMA 850 | RMC | 24.0 | 23.96 | 0.020 | Left Touch | FCC #1 | 1:1 | 0.447 | 1.009 | 0.451 | A3 |
| 836.6 | 4183 | WCDMA 850 | RMC | 24.0 | 23.96 | 0.050 | Right Touch | FCC #1 | 1:1 | 0.418 | 1.009 | 0.422 | |
| 836.6 | 4183 | WCDMA 850 | RMC | 24.0 | 23.96 | -0.010 | Left Tilt | FCC #1 | 1:1 | 0.280 | 1.009 | 0.283 | |
| 836.6 | 4183 | WCDMA 850 | RMC | 24.0 | 23.96 | 0.190 | Right Tilt | FCC #1 | 1:1 | 0.268 | 1.009 | 0.270 | |
| ANSI / IEEE C95.1-2005- SAFETY LIMIT Spatial Peak Uncontrolled Exposure/General Population Exposure | | | | | | | | | Head 1.6 W/kg (mW/g) averaged over 1 gram | | | | |

Table 12.4 WCDMA 1900 Head SAR

| MEASUREMENT RESULTS | | | | | | | | | | | | | |
|---|------|---------------|---------|--------------------------------------|-----------------------------|------------------------|---------------------|----------------------------|---|---------------------|-------------------|-------------------------------|------------|
| FREQUENCY | | Mode/ Band | Service | Maximum Allowed Power [dBm] | Conducted Power [dBm] | Drift Power [dB] | Phantom Position | Device Serial Number | Duty Cycle | 1g SAR (W/kg) | Scaling Factor | 1g Scaled SAR (W/kg) | Plots # |
| MHz | Ch | | | | | | | | | | | | |
| 1880.0 | 9400 | WCDMA 1900 | RMC | 24.3 | 24.2 | 0.150 | Left Touch | FCC #1 | 1:1 | 0.134 | 1.023 | 0.137 | |
| 1880.0 | 9400 | WCDMA 1900 | RMC | 24.3 | 24.2 | 0.080 | Right Touch | FCC #1 | 1:1 | 0.146 | 1.023 | 0.149 | A4 |
| 1880.0 | 9400 | WCDMA 1900 | RMC | 24.3 | 24.2 | 0.140 | Left Tilt | FCC #1 | 1:1 | 0.0536 | 1.023 | 0.055 | |
| 1880.0 | 9400 | WCDMA 1900 | RMC | 24.3 | 24.2 | 0.130 | Right Tilt | FCC #1 | 1:1 | 0.031 | 1.023 | 0.032 | |
| ANSI / IEEE C95.1-2005- SAFETY LIMIT Spatial Peak Uncontrolled Exposure/General Population Exposure | | | | | | | | | Head 1.6 W/kg (mW/g) averaged over 1 gram | | | | |

Table 12.5 DTS(2.4G)/NII(5.8G) Head SAR

| MEASUREMENT RESULTS | | | | | | | | | | | | | | |
|---|-----|---------|---------|--------------------------------------|-----------------------------|------------------------|---------------------|----------------------------|---|---------------|---------------------|-------------------|-------------------------------|------------|
| FREQUENCY | | Mode | Service | Maximum Allowed Power [dBm] | Conducted Power [dBm] | Drift Power [dB] | Phantom Position | Device Serial Number | Data Rate [Mbps] | Duty Cycle | 1g SAR (W/kg) | Scaling Factor | 1g Scaled SAR (W/kg) | Plots # |
| MHz | Ch | | | | | | | | | | | | | |
| 2462 | 11 | 802.11b | DSSS | 16.5 | 16.19 | 0.020 | Left Touch | FCC #1 | 1 | 1:1 | 0.349 | 1.074 | 0.375 | A5 |
| 2462 | 11 | 802.11b | DSSS | 16.5 | 16.19 | 0.050 | Right Touch | FCC #1 | 1 | 1:1 | 0.172 | 1.074 | 0.185 | |
| 2462 | 11 | 802.11b | DSSS | 16.5 | 16.19 | -0.130 | Left Tilt | FCC #1 | 1 | 1:1 | 0.215 | 1.074 | 0.231 | |
| 2462 | 11 | 802.11b | DSSS | 16.5 | 16.19 | -0.180 | Right Tilt | FCC #1 | 1 | 1:1 | 0.201 | 1.074 | 0.216 | |
| 5745 | 149 | 802.11a | OFDM | 13.0 | 10.45 | -0.070 | Left Touch | FCC #1 | 6 | 1:1 | 0.0769 | 1.799 | 0.138 | |
| 5745 | 149 | 802.11a | OFDM | 13.0 | 10.45 | 0.000 | Right Touch | FCC #1 | 6 | 1:1 | 0.0512 | 1.799 | 0.092 | |
| 5745 | 149 | 802.11a | OFDM | 13.0 | 10.45 | 0.020 | Left Tilt | FCC #1 | 6 | 1:1 | 0.103 | 1.799 | 0.185 | A6 |
| 5745 | 149 | 802.11a | OFDM | 13.0 | 10.45 | 0.000 | Right Tilt | FCC #1 | 6 | 1:1 | 0.0702 | 1.799 | 0.126 | |
| ANSI / IEEE C95.1-2005- SAFETY LIMIT Spatial Peak Uncontrolled Exposure/General Population Exposure | | | | | | | | | Head 1.6 W/kg (mW/g) averaged over 1 gram | | | | | |

Table 12.6 NII Head SAR

MEASUREMENT RESULTS

| FREQUENCY | | Mode | Service | Maximum Allowed Power [dBm] | Conducted Power [dBm] | Drift Power [dB] | Phantom Position | Device Serial Number | Data Rate [Mbps] | Duty Cycle | 1g SAR (W/kg) | Scaling Factor | 1g Scaled SAR (W/kg) | Plots # |
|---|-----|---------|---------|-----------------------------|-----------------------|------------------|------------------|---|------------------|------------|---------------|----------------|----------------------|---------|
| MHz | Ch | | | | | | | | | | | | | |
| 5240 | 48 | 802.11a | OFDM | 13.0 | 11.51 | -0.070 | Left Touch | FCC #1 | 6 | 1:1 | 0.236 | 1.409 | 0.333 | |
| 5240 | 48 | 802.11a | OFDM | 13.0 | 11.51 | -0.160 | Right Touch | FCC #1 | 6 | 1:1 | 0.207 | 1.409 | 0.292 | |
| 5240 | 48 | 802.11a | OFDM | 13.0 | 11.51 | 0.010 | Left Tilt | FCC #1 | 6 | 1:1 | 0.259 | 1.409 | 0.365 | A7 |
| 5240 | 48 | 802.11a | OFDM | 13.0 | 11.51 | 0.090 | Right Tilt | FCC #1 | 6 | 1:1 | 0.233 | 1.409 | 0.328 | |
| 5320 | 64 | 802.11a | OFDM | 13.0 | 12.76 | 0.030 | Left Touch | FCC #1 | 6 | 1:1 | 0.165 | 1.057 | 0.174 | |
| 5320 | 64 | 802.11a | OFDM | 13.0 | 12.76 | 0.060 | Right Touch | FCC #1 | 6 | 1:1 | 0.111 | 1.057 | 0.117 | |
| 5320 | 64 | 802.11a | OFDM | 13.0 | 12.76 | 0.190 | Left Tilt | FCC #1 | 6 | 1:1 | 0.194 | 1.057 | 0.205 | A8 |
| 5320 | 64 | 802.11a | OFDM | 13.0 | 12.76 | 0.030 | Right Tilt | FCC #1 | 6 | 1:1 | 0.135 | 1.057 | 0.143 | |
| 5580 | 116 | 802.11a | OFDM | 13.0 | 12.83 | 0.080 | Left Touch | FCC #1 | 6 | 1:1 | 0.0734 | 1.040 | 0.076 | |
| 5580 | 116 | 802.11a | OFDM | 13.0 | 12.83 | 0.000 | Right Touch | FCC #1 | 6 | 1:1 | 0.0487 | 1.040 | 0.051 | |
| 5580 | 116 | 802.11a | OFDM | 13.0 | 12.83 | 0.050 | Left Tilt | FCC #1 | 6 | 1:1 | 0.082 | 1.040 | 0.085 | A9 |
| 5580 | 116 | 802.11a | OFDM | 13.0 | 12.83 | 0.140 | Right Tilt | FCC #1 | 6 | 1:1 | 0.0537 | 1.040 | 0.056 | |
| ANSI / IEEE C95.1-2005- SAFETY LIMIT Spatial Peak Uncontrolled Exposure/General Population Exposure | | | | | | | | Head 1.6 W/kg (mW/g) averaged over 1 gram | | | | | | |

12.2 Standalone Body-Worn SAR Results

Table 12.7 GSM/GPRS/WCDMA Body-Worn SAR

| MEASUREMENT RESULTS | | | | | | | | | | | | | | |
|---|------|---------------|---------|--------------------------------------|-----------------------------|------------------------|-------------------|---|---------------------------|---------------|---------------------|-------------------|-------------------------------|------------|
| FREQUENCY | | Mode/ Band | Service | Maximum Allowed Power [dBm] | Conducted Power [dBm] | Drift Power [dB] | Spacing [Side] | Device Serial Number | # of Time Slot s | Duty Cycle | 1g SAR (W/kg) | Scaling Factor | 1g Scaled SAR (W/kg) | Plots # |
| MHz | Ch | | | | | | | | | | | | | |
| 836.6 | 190 | GSM 850 | GSM | 33.2 | 33.1 | 0.100 | 10 mm [Rear] | FCC #1 | 1 | 1:8.3 | 0.575 | 1.023 | 0.588 | |
| 836.6 | 190 | GSM 850 | GPRS | 33.2 | 33.1 | 0.010 | 10 mm [Rear] | FCC #1 | 1 | 1:8.3 | 0.578 | 1.023 | 0.591 | A10 |
| 836.6 | 190 | GSM 850 | GPRS | 29.8 | 29.7 | -0.110 | 10 mm [Rear] | FCC #1 | 2 | 1:4.15 | 0.572 | 1.023 | 0.585 | |
| 836.6 | 190 | GSM 850 | GPRS | 28.0 | 28.0 | -0.120 | 10 mm [Rear] | FCC #1 | 3 | 1:2.77 | 0.501 | 1.000 | 0.501 | |
| 836.6 | 190 | GSM 850 | GPRS | 26.8 | 26.8 | -0.000 | 10 mm [Rear] | FCC #1 | 4 | 1:2.075 | 0.571 | 1.000 | 0.571 | |
| 836.6 | 190 | GSM 850 | GPRS | 33.2 | 33.1 | 0.020 | 10 mm [Front] | FCC #1 | 1 | 1:8.3 | 0.318 | 1.023 | 0.325 | |
| 1880.0 | 661 | PCS1900 | GSM | 30.0 | 29.7 | -0.010 | 10 mm [Rear] | FCC #1 | 1 | 1:8.3 | 0.297 | 1.072 | 0.318 | |
| 1880.0 | 661 | PCS1900 | GPRS | 30.0 | 29.7 | 0.020 | 10 mm [Rear] | FCC #1 | 1 | 1:8.3 | 0.299 | 1.072 | 0.321 | A11 |
| 1880.0 | 661 | PCS1900 | GPRS | 26.5 | 26.4 | -0.100 | 10 mm [Rear] | FCC #1 | 2 | 1:4.15 | 0.296 | 1.023 | 0.303 | |
| 1880.0 | 661 | PCS1900 | GPRS | 24.6 | 24.5 | -0.010 | 10 mm [Rear] | FCC #1 | 3 | 1:2.77 | 0.268 | 1.023 | 0.274 | |
| 1880.0 | 661 | PCS1900 | GPRS | 23.3 | 23.2 | 0.030 | 10 mm [Rear] | FCC #1 | 4 | 1:2.075 | 0.266 | 1.023 | 0.272 | |
| 1880.0 | 661 | PCS1900 | GPRS | 30.0 | 29.7 | -0.090 | 10 mm [Front] | FCC #1 | 1 | 1:8.3 | 0.170 | 1.072 | 0.182 | |
| 836.6 | 4183 | WCDMA 850 | RMC | 24.0 | 23.96 | -0.090 | 10 mm [Rear] | FCC #1 | N/A | 1:1 | 0.303 | 1.009 | 0.306 | A12 |
| 836.6 | 4183 | WCDMA 850 | RMC | 24.0 | 23.96 | -0.140 | 10 mm [Front] | FCC #1 | N/A | 1:1 | 0.166 | 1.009 | 0.167 | |
| 1880.0 | 9400 | WCDMA 1900 | RMC | 24.3 | 24.2 | 0.020 | 10 mm [Rear] | FCC #1 | N/A | 1:1 | 0.770 | 1.023 | 0.788 | A13 |
| 1880.0 | 9400 | WCDMA 1900 | RMC | 24.3 | 24.2 | 0.180 | 10 mm [Front] | FCC #1 | N/A | 1:1 | 0.399 | 1.023 | 0.408 | |
| ANSI / IEEE C95.1-2005- SAFETY LIMIT Spatial Peak Uncontrolled Exposure/General Population Exposure | | | | | | | | Body 1.6 W/kg (mW/g) averaged over 1 gram | | | | | | |

Table 12.8 DTS(2.4G)/NII(5.8G) Body-Worn SAR

| MEASUREMENT RESULTS | | | | | | | | | | | | | | |
|---|-----|---------------|---------|--------------------------------------|-----------------------------|------------------------|-------------------|---|------------------------|---------------|---------------------|-------------------|-------------------------------|------------|
| FREQUENCY | | Mode/ Band | Service | Maximum Allowed Power [dBm] | Conducted Power [dBm] | Drift Power [dB] | Spacing [Side] | Device Serial Number | Data Rate [Mbps] | Duty Cycle | 1g SAR (W/kg) | Scaling Factor | 1g Scaled SAR (W/kg) | Plots # |
| MHz | Ch | | | | | | | | | | | | | |
| 2462 | 11 | 802.11b | DSSS | 16.5 | 16.19 | -0.110 | 10 mm [Rear] | FCC #1 | 1 | 1:1 | 0.0416 | 1.074 | 0.045 | |
| 2462 | 11 | 802.11b | DSSS | 16.5 | 16.19 | 0.040 | 10 mm [Front] | FCC #1 | 1 | 1:1 | 0.0573 | 1.074 | 0.062 | A14 |
| 5745 | 149 | 802.11a | OFDM | 13.0 | 10.45 | -0.040 | 10 mm [Rear] | FCC #1 | 1 | 1:1 | 0.052 | 1.799 | 0.095 | A15 |
| 5745 | 149 | 802.11a | OFDM | 13.0 | 10.45 | 0.030 | 10 mm [Front] | FCC #1 | 1 | 1:1 | 0.0173 | 1.799 | 0.031 | |
| ANSI / IEEE C95.1-2005- SAFETY LIMIT Spatial Peak Uncontrolled Exposure/General Population Exposure | | | | | | | | Body 1.6 W/kg (mW/g) averaged over 1 gram | | | | | | |

Table 12.9 NII Body-Worn SAR

| MEASUREMENT RESULTS | | | | | | | | | | | | | | |
|---|-----|---------------|---------|--------------------------------------|-----------------------------|------------------------|-------------------|---|------------------------|---------------|---------------------|-------------------|-------------------------------|------------|
| FREQUENCY | | Mode/ Band | Service | Maximum Allowed Power [dBm] | Conducted Power [dBm] | Drift Power [dB] | Spacing [Side] | Device Serial Number | Data Rate [Mbps] | Duty Cycle | 1g SAR (W/kg) | Scaling Factor | 1g Scaled SAR (W/kg) | Plots # |
| MHz | Ch | | | | | | | | | | | | | |
| 5240 | 48 | 802.11a | OFDM | 13.0 | 11.51 | 0.000 | 10 mm [Rear] | FCC #1 | 1 | 1:1 | 0.0558 | 1.409 | 0.079 | A16 |
| 5240 | 48 | 802.11a | OFDM | 13.0 | 11.51 | 0.010 | 10 mm [Front] | FCC #1 | 1 | 1:1 | 0.0417 | 1.409 | 0.059 | |
| 5320 | 64 | 802.11a | OFDM | 13.0 | 12.76 | 0.000 | 10 mm [Rear] | FCC #1 | 1 | 1:1 | 0.0391 | 1.057 | 0.041 | A17 |
| 5320 | 64 | 802.11a | OFDM | 13.0 | 12.76 | -0.090 | 10 mm [Front] | FCC #1 | 1 | 1:1 | 0.0345 | 1.057 | 0.036 | |
| 5580 | 116 | 802.11a | OFDM | 13.0 | 12.83 | 0.120 | 10 mm [Rear] | FCC #1 | 1 | 1:1 | 0.037 | 1.040 | 0.038 | A18 |
| 5580 | 116 | 802.11a | OFDM | 13.0 | 12.83 | -0.090 | 10 mm [Front] | FCC #1 | 1 | 1:1 | 0.00109 | 1.040 | 0.001 | |
| ANSI / IEEE C95.1-2005- SAFETY LIMIT Spatial Peak Uncontrolled Exposure/General Population Exposure | | | | | | | | Body 1.6 W/kg (mW/g) averaged over 1 gram | | | | | | |

12.3 Hand SAR Results

Table 12.10 GSM/GPRS Hand SAR

| MEASUREMENT RESULTS | | | | | | | | | | | | | | |
|---|-----|---------------|---------|--------------------------------------|-----------------------------|------------------------|-------------------|--|-----------------------|---------------|----------------------|-------------------|--------------------------------|------------|
| FREQUENCY | | Mode/ Band | Service | Maximum Allowed Power [dBm] | Conducted Power [dBm] | Drift Power [dB] | Spacing [Side] | Device Serial Number | # of Time Slots | Duty Cycle | 10g SAR (W/kg) | Scaling Factor | 10g Scaled SAR (W/kg) | Plots # |
| MHz | Ch | | | | | | | | | | | | | |
| 836.6 | 190 | GSM 850 | GPRS | 33.2 | 33.1 | -0.130 | 0 mm [Bottom] | FCC #1 | 1 | 1:8.3 | 0.748 | 1.023 | 0.765 | |
| 836.6 | 190 | GSM 850 | GPRS | 33.2 | 33.1 | 0.070 | 0 mm [Front] | FCC #1 | 1 | 1:8.3 | 0.307 | 1.023 | 0.314 | |
| 836.6 | 190 | GSM 850 | GSM | 33.2 | 33.1 | 0.070 | 0 mm [Rear] | FCC #1 | 1 | 1:8.3 | 0.987 | 1.023 | 1.010 | |
| 836.6 | 190 | GSM 850 | GPRS | 33.2 | 33.1 | -0.110 | 0 mm [Rear] | FCC #1 | 1 | 1:8.3 | 0.989 | 1.023 | 1.012 | A19 |
| 836.6 | 190 | GSM 850 | GPRS | 33.2 | 33.1 | 0.030 | 0 mm [Rear] | FCC #1 | 2 | 1:4.15 | 0.776 | 1.023 | 0.794 | |
| 836.6 | 190 | GSM 850 | GPRS | 29.8 | 29.8 | 0.110 | 0 mm [Rear] | FCC #1 | 3 | 1:2.77 | 0.876 | 1.000 | 0.876 | |
| 836.6 | 190 | GSM 850 | GPRS | 28.0 | 28.0 | -0.040 | 0 mm [Rear] | FCC #1 | 4 | 1:2.075 | 0.904 | 1.000 | 0.904 | |
| 836.6 | 190 | GSM 850 | GPRS | 33.2 | 33.1 | -0.080 | 0 mm [Right] | FCC #1 | 1 | 1:8.3 | 0.620 | 1.023 | 0.634 | |
| 836.6 | 190 | GSM 850 | GPRS | 33.2 | 33.1 | 0.040 | 0 mm [Left] | FCC #1 | 1 | 1:8.3 | 0.352 | 1.023 | 0.360 | |
| 1880.0 | 661 | PCS1900 | GPRS | 30.0 | 29.7 | 0.090 | 0 mm [Bottom] | FCC #1 | 1 | 1:8.3 | 0.759 | 1.072 | 0.814 | |
| 1880.0 | 661 | PCS1900 | GPRS | 30.0 | 29.7 | -0.040 | 0 mm [Front] | FCC #1 | 1 | 1:8.3 | 0.366 | 1.072 | 0.392 | |
| 1880.0 | 661 | PCS1900 | GSM | 30.0 | 29.7 | 0.170 | 0 mm [Rear] | FCC #1 | 1 | 1:8.3 | 0.843 | 1.072 | 0.904 | |
| 1880.0 | 661 | PCS1900 | GPRS | 30.0 | 29.7 | -0.160 | 0 mm [Rear] | FCC #1 | 1 | 1:8.3 | 0.891 | 1.072 | 0.955 | A20 |
| 1880.0 | 661 | PCS1900 | GPRS | 26.5 | 26.4 | -0.130 | 0 mm [Rear] | FCC #1 | 2 | 1:4.15 | 0.757 | 1.023 | 0.774 | |
| 1880.0 | 661 | PCS1900 | GPRS | 24.6 | 24.5 | -0.090 | 0 mm [Rear] | FCC #1 | 3 | 1:2.77 | 0.755 | 1.023 | 0.772 | |
| 1880.0 | 661 | PCS1900 | GPRS | 23.3 | 23.2 | -0.070 | 0 mm [Rear] | FCC #1 | 4 | 1:2.075 | 0.726 | 1.023 | 0.743 | |
| 1880.0 | 661 | PCS1900 | GPRS | 30.0 | 29.7 | 0.050 | 0 mm [Rear] | FCC #1 | 1 | 1:8.3 | 0.0786 | 1.072 | 0.084 | |
| 1880.0 | 661 | PCS1900 | GPRS | 30.0 | 29.7 | 0.020 | 0 mm [Left] | FCC #1 | 1 | 1:8.3 | 0.372 | 1.072 | 0.399 | |
| ANSI / IEEE C95.1-2005- SAFETY LIMIT Spatial Peak Uncontrolled Exposure/General Population Exposure | | | | | | | | Body 4.0 W/kg (mW/g) averaged over 10 gram | | | | | | |

Table 12.11 WCDMA Hand SAR

| MEASUREMENT RESULTS | | | | | | | | | | | | | | |
|---|------|---------------|---------|--------------------------------------|-----------------------------|------------------------|-------------------|--|-----------------------|-------------------|----------------------|-------------------|--------------------------------|------------|
| FREQUENCY | | Mode/ Band | Service | Maximum Allowed Power [dBm] | Conducted Power [dBm] | Drift Power [dB] | Spacing [Side] | Device Serial Number | # of Time Slots | Duty Cycl e | 10g SAR (W/kg) | Scaling Factor | 10g Scaled SAR (W/kg) | Plots # |
| MHz | Ch | | | | | | | | | | | | | |
| 836.6 | 4183 | WCDMA 850 | RMC | 24.0 | 23.96 | -0.010 | 0 mm [Bottom] | FCC #1 | N/A | 1:1 | 0.852 | 1.009 | 0.860 | |
| 836.6 | 4183 | WCDMA 850 | RMC | 24.0 | 23.96 | 0.050 | 0 mm [Front] | FCC #1 | N/A | 1:1 | 0.371 | 1.009 | 0.374 | |
| 836.6 | 4183 | WCDMA 850 | RMC | 24.0 | 23.96 | 0.000 | 0 mm [Rear] | FCC #1 | N/A | 1:1 | 0.971 | 1.009 | 0.980 | A21 |
| 836.6 | 4183 | WCDMA 850 | RMC | 24.0 | 23.96 | -0.090 | 0 mm [Right] | FCC #1 | N/A | 1:1 | 0.0489 | 1.009 | 0.049 | |
| 836.6 | 4183 | WCDMA 850 | RMC | 24.0 | 23.96 | 0.030 | 0 mm [Left] | FCC #1 | N/A | 1:1 | 0.393 | 1.009 | 0.397 | |
| 1880.0 | 9400 | WCDMA 1900 | RMC | 24.3 | 24.2 | 0.060 | 0 mm [Bottom] | FCC #1 | N/A | 1:1 | 1.85 | 1.023 | 1.893 | |
| 1880.0 | 9400 | WCDMA 1900 | RMC | 24.3 | 24.2 | -0.160 | 0 mm [Front] | FCC #1 | N/A | 1:1 | 1.00 | 1.023 | 1.023 | |
| 1880.0 | 9400 | WCDMA 1900 | RMC | 24.3 | 24.2 | 0.060 | 0 mm [Rear] | FCC #1 | N/A | 1:1 | 1.95 | 1.023 | 1.995 | A22 |
| 1880.0 | 9400 | WCDMA 1900 | RMC | 24.3 | 24.2 | 0.020 | 0 mm [Right] | FCC #1 | N/A | 1:1 | 0.207 | 1.023 | 0.212 | |
| 1880.0 | 9400 | WCDMA 1900 | RMC | 24.3 | 24.2 | -0.080 | 0 mm [Left] | FCC #1 | N/A | 1:1 | 0.849 | 1.023 | 0.869 | |
| ANSI / IEEE C95.1-2005- SAFETY LIMIT Spatial Peak Uncontrolled Exposure/General Population Exposure | | | | | | | | Body 4.0 W/kg (mW/g) averaged over 10 gram | | | | | | |

Table 12.12 DTS(2.4G)/NII(5.8G) Hand SAR

| MEASUREMENT RESULTS | | | | | | | | | | | | | | |
|---|-----|---------------|---------|--------------------------------------|-----------------------------|------------------------|-------------------|--|------------------------|---------------|----------------------|-----------------------|--------------------------------|------------|
| FREQUENCY | | Mode/ Band | Service | Maximum Allowed Power [dBm] | Conducted Power [dBm] | Drift Power [dB] | Spacing [Side] | Device Serial Number | Data Rate [Mbps] | Duty Cycle | 10g SAR (W/kg) | Scalin g Factor | 10g Scaled SAR (W/kg) | Plots # |
| MHz | Ch | | | | | | | | | | | | | |
| 2462 | 11 | 802.11b | DSSS | 16.5 | 16.19 | -0.040 | 0 mm [Top] | FCC #1 | 1 | 1:1 | 0.145 | 1.074 | 0.156 | |
| 2462 | 11 | 802.11b | DSSS | 16.5 | 16.19 | 0.080 | 0 mm [Front] | FCC #1 | 1 | 1:1 | 0.160 | 1.074 | 0.172 | A23 |
| 2462 | 11 | 802.11b | DSSS | 16.5 | 16.19 | 0.030 | 0 mm [Rear] | FCC #1 | 1 | 1:1 | 0.104 | 1.074 | 0.112 | |
| 2462 | 11 | 802.11b | DSSS | 16.5 | 16.19 | 0.140 | 0 mm [Right] | FCC #1 | 1 | 1:1 | 0.100 | 1.074 | 0.107 | |
| 2462 | 11 | 802.11b | DSSS | 16.5 | 16.19 | -0.010 | 0 mm [Left] | FCC #1 | 1 | 1:1 | 0.00523 | 1.074 | 0.006 | |
| 5745 | 149 | 802.11a | OFDM | 13.0 | 10.45 | 0.120 | 0 mm [Top] | FCC #1 | 1 | 1:1 | 0.0779 | 1.799 | 0.140 | A24 |
| 5745 | 149 | 802.11a | OFDM | 13.0 | 10.45 | 0.000 | 0 mm [Front] | FCC #1 | 1 | 1:1 | 0.0117 | 1.799 | 0.021 | |
| 5745 | 149 | 802.11a | OFDM | 13.0 | 10.45 | 0.000 | 0 mm [Rear] | FCC #1 | 1 | 1:1 | 0.0168 | 1.799 | 0.030 | |
| 5745 | 149 | 802.11a | OFDM | 13.0 | 10.45 | 0.000 | 0 mm [Right] | FCC #1 | 1 | 1:1 | 0.0064 | 1.799 | 0.012 | |
| 5745 | 149 | 802.11a | OFDM | 13.0 | 10.45 | 0.120 | 0 mm [Left] | FCC #1 | 1 | 1:1 | 0.00398 | 1.799 | 0.007 | |
| ANSI / IEEE C95.1-2005- SAFETY LIMIT Spatial Peak Uncontrolled Exposure/General Population Exposure | | | | | | | | Body 4.0 W/kg (mW/g) averaged over 10 gram | | | | | | |

Table 12.13 NII Hand SAR

MEASUREMENT RESULTS

| FREQUENCY | | Mode/ Band | Service | Maximum Allowed Power [dBm] | Conducted Power [dBm] | Drift Power [dB] | Spacing [Side] | Device Serial Number | Data Rate [Mbps] | Duty Cycle | 10g SAR (W/kg) | Scalin g Factor | 10g Scaled SAR (W/kg) | Plots # |
|---|-----|---------------|---------|--------------------------------------|-----------------------------|------------------------|-------------------|--|------------------------|---------------|----------------------|-----------------------|--------------------------------|------------|
| MHz | Ch | | | | | | | | | | | | | |
| 5240 | 48 | 802.11a | OFDM | 13.0 | 11.51 | -0.180 | 0 mm [Top] | FCC #1 | 1 | 1:1 | 0.185 | 1.409 | 0.261 | A25 |
| 5240 | 48 | 802.11a | OFDM | 13.0 | 11.51 | 0.090 | 0 mm [Front] | FCC #1 | 1 | 1:1 | 0.0525 | 1.409 | 0.074 | |
| 5240 | 48 | 802.11a | OFDM | 13.0 | 11.51 | 0.000 | 0 mm [Rear] | FCC #1 | 1 | 1:1 | 0.053 | 1.409 | 0.075 | |
| 5240 | 48 | 802.11a | OFDM | 13.0 | 11.51 | 0.100 | 0 mm [Right] | FCC #1 | 1 | 1:1 | 0.003 | 1.409 | 0.004 | |
| 5240 | 48 | 802.11a | OFDM | 13.0 | 11.51 | 0.150 | 0 mm [Left] | FCC #1 | 1 | 1:1 | 0.0174 | 1.409 | 0.025 | |
| 5320 | 64 | 802.11a | OFDM | 13.0 | 12.76 | -0.180 | 0 mm [Top] | FCC #1 | 1 | 1:1 | 0.131 | 1.057 | 0.138 | A26 |
| 5320 | 64 | 802.11a | OFDM | 13.0 | 12.76 | 0.000 | 0 mm [Front] | FCC #1 | 1 | 1:1 | 0.032 | 1.057 | 0.034 | |
| 5320 | 64 | 802.11a | OFDM | 13.0 | 12.76 | 0.000 | 0 mm [Rear] | FCC #1 | 1 | 1:1 | 0.0338 | 1.057 | 0.036 | |
| 5320 | 64 | 802.11a | OFDM | 13.0 | 12.76 | 0.000 | 0 mm [Right] | FCC #1 | 1 | 1:1 | 0.0033 | 1.057 | 0.003 | |
| 5320 | 64 | 802.11a | OFDM | 13.0 | 12.76 | -0.120 | 0 mm [Left] | FCC #1 | 1 | 1:1 | 0.0104 | 1.057 | 0.011 | |
| 5580 | 116 | 802.11a | OFDM | 13.0 | 12.83 | -0.060 | 0 mm [Top] | FCC #1 | 1 | 1:1 | 0.0651 | 1.040 | 0.068 | A27 |
| 5580 | 116 | 802.11a | OFDM | 13.0 | 12.83 | -0.060 | 0 mm [Front] | FCC #1 | 1 | 1:1 | 0.0105 | 1.040 | 0.011 | |
| 5580 | 116 | 802.11a | OFDM | 13.0 | 12.83 | 0.000 | 0 mm [Rear] | FCC #1 | 1 | 1:1 | 0.0211 | 1.040 | 0.022 | |
| 5580 | 116 | 802.11a | OFDM | 13.0 | 12.83 | 0.000 | 0 mm [Right] | FCC #1 | 1 | 1:1 | 0.0039 | 1.040 | 0.004 | |
| 5580 | 116 | 802.11a | OFDM | 13.0 | 12.83 | 0.000 | 0 mm [Left] | FCC #1 | 1 | 1:1 | 0.000515 | 1.040 | 0.001 | |
| ANSI / IEEE C95.1-2005– SAFETY LIMIT Spatial Peak Uncontrolled Exposure/General Population Exposure | | | | | | | | Body 4.0 W/kg (mW/g) averaged over 10 gram | | | | | | |

12.4 SAR Test Notes

General Notes:

1. The test data reported are the worst-case SAR values according to test procedures specified in IEEE 1528-2003, and FCC KDB Publication 447498 D01v05r02.
2. Batteries are fully charged at the beginning of the SAR measurements. A standard battery was used for all SAR measurements.
3. Liquid tissue depth was at least 15.0 cm for all frequencies.
4. The manufacturer has confirmed that the device(s) tested have the same physical, mechanical and thermal characteristics and are within operational tolerances expected for production units.
5. SAR results were scaled to the maximum allowed power to demonstrate compliance per FCC KDB Publication 447498 D01v05r02.
6. Device was tested using a fixed spacing for body-worn accessory testing. A separation distance of 10 mm was considered because the manufacturer has determined that there will be body-worn accessories available in the marketplace for users to support this separation distance.
7. Per FCC KDB Publication 648474 D04v01r02, SAR was evaluated without a headset connected to the device. Since the standalone reported SAR was not > 1.2 W/kg, no additional SAR evaluations using a headset cable were performed.
8. Per FCC KDB 865664 D01v01r03, variability SAR tests were performed when the measured SAR results for a frequency band were greater than 0.8 W/kg. Repeated SAR measurements are highlighted in the tables above for clarity. Please see Section 14 for variability analysis.

GSM Notes:

1. Body-Worn accessory testing is typically associated with voice operations. Therefore, GSM voice was evaluated for body-worn SAR.
2. This device supports GSM VOIP in the head and body-worn configurations; therefore GPRS was additionally evaluated for head and body-worn compliance.
3. Justification for reduced test configurations per KDB Publication 941225 D01v03 and October 2013 TCB Workshop Notes: The source-based frame-averaged output power was evaluated for all GPRS/EDGE slot configurations. The configuration with the highest target frame averaged output power was evaluated for hotspot SAR. When the maximum frame-averaged powers are equivalent across two or more slots (within 0.25 dB), the configuration with the most number of time slots was tested.
4. Per FCC KDB Publication 447498 D01v05r02, if the reported (scaled) SAR measured at the middle channel or highest output power channel for each test configuration is ≤ 0.8 W/kg then testing at the other channels is not required for such test configuration(s). Since the maximum output power variation across the required test channels is not > $\frac{1}{2}$ dB, the middle channel was used for testing.

WCDMA (UMTS) Notes:

1. WCDMA (UMTS) mode in was tested under RMC 12.2 kbps with HSPA Inactive per KDB Publication 941225 D01v03. HSPA SAR was not required since the average output power of the HSPA subtests was not more than 0.25 dB higher than the RMC level and SAR was less than 1.2 W/kg.
2. Per FCC KDB Publication 447498 D01v05r02, if the reported (scaled) SAR measured at the middle channel or highest output power channel for each test configuration is ≤ 0.8 W/kg then testing at the other channels is not required for such test configuration(s). When the maximum output power variation across the required test channels is $> \frac{1}{2}$ dB, instead of the middle channel, the highest output power channel was used.

WLAN Notes:

1. Justification for reduced test configurations for WIFI channels per KDB Publication 248227 D01v01r02 and October 2012 FCC/TCB Meeting Notes for 2.4 GHz WIFI: Highest average RF output power channel for the lowest data rate was selected for SAR evaluation in 802.11b. Other IEEE 802.11 modes (including 802.11g/n) were not investigated since the average output powers over all channels and data rates were not more than 0.25 dB higher than the tested channel in the lowest data rate of IEEE 802.11b mode.
2. Justification for reduced test configurations for WIFI channels per KDB Publication 248227 D01v01r02 and October 2012 FCC/TCB Meeting Notes for 5 GHz WIFI: Highest average RF output power channel for the lowest data rate was selected for SAR evaluation in 802.11a. Other IEEE 802.11 modes (including 802.11n 20MHz and 40 MHz bandwidths) were not investigated since the average output powers over all channels and data rates were not more than 0.25 dB higher than the tested channel in the lowest data rate of IEEE 802.11a mode.
3. WIFI transmission was verified using a spectrum analyzer.
4. Since the maximum extrapolated peak SAR of the zoom scan for the maximum output channel is < 1.6 W/kg and the reported 1g averaged SAR is < 0.8 W/kg, SAR testing on other default channels was not required.

13. SAR MEASUREMENT VARIABILITY

13.1 Measurement Variability

Per FCC KDB Publication 865664 D01v01r03, SAR measurement variability was assessed for each frequency band, which was determined by the SAR probe calibration point and tissue-equivalent medium used for the device measurements. When both head and body tissue-equivalent media were required for SAR measurements in a frequency band, the variability measurement procedures were applied to the tissue medium with the highest measured SAR, using the highest measured SAR configuration for that tissue-equivalent medium. These additional measurements were repeated after the completion of all measurements requiring the same head or body tissue-equivalent medium in a frequency band. The test device was returned to ambient conditions (normal room temperature) with the battery fully charged before it was re-mounted on the device holder for the repeated measurement(s) to minimize any unexpected variations in the repeated results.

SAR Measurement Variability was assessed using the following procedures for each frequency band:

1. When the original highest measured SAR is ≥ 0.80 W/kg, the measurement was repeated once.
2. A second repeated measurement was performed only if the ratio of largest to smallest SAR for the original and first repeated measurements was > 1.20 or when the original or repeated measurement was ≥ 1.45 W/kg (~ 10% from the 1-g SAR limit).
3. A third repeated measurement was performed only if the original, first or second repeated measurement was ≥ 1.5 W/kg and the ratio of largest to smallest SAR for the original, first and second repeated measurements is > 1.20 .
4. Repeated measurements are not required when the original highest measured SAR is < 0.80 W/kg

13.2 Measurement Uncertainty

The measured SAR was < 1.5 W/kg for all frequency bands. Therefore, per KDB Publication 865664 D01v01r03, the standard measurement uncertainty analysis per IEEE 1528-2003 was not required.

14. IEEE P1528 –MEASUREMENT UNCERTAINTIES

835 MHz Head

| Error Description | Uncertainty value $\pm\%$ | Probability Distribution | Divisor | (Ci) 1g | Standard (1g) | vi 2 or Veff |
|--------------------------------------|---------------------------|--------------------------|------------|---------|---------------------------------|--------------|
| Measurement System | | | | | | |
| Probe calibration | ± 6.0 | Normal | 1 | 1 | $\pm 6.0 \%$ | ∞ |
| Axial isotropy | ± 4.7 | Rectangular | $\sqrt{3}$ | 1 | $\pm 2.714 \%$ | ∞ |
| Hemispherical isotropy | ± 9.6 | Rectangular | $\sqrt{3}$ | 1 | $\pm 5.543 \%$ | ∞ |
| Boundary Effects | ± 0.8 | Rectangular | $\sqrt{3}$ | 1 | $\pm 0.462 \%$ | ∞ |
| Probe Linearity | ± 4.7 | Rectangular | $\sqrt{3}$ | 1 | $\pm 2.714 \%$ | ∞ |
| Detection limits | ± 0.25 | Rectangular | $\sqrt{3}$ | 1 | $\pm 0.144 \%$ | ∞ |
| Readout Electronics | ± 1.0 | Normal | 1 | 1 | $\pm 1.0 \%$ | ∞ |
| Response time | ± 0.8 | Rectangular | $\sqrt{3}$ | 1 | $\pm 0.462 \%$ | ∞ |
| Integration time | ± 2.6 | Rectangular | $\sqrt{3}$ | 1 | $\pm 1.501 \%$ | ∞ |
| RF Ambient Conditions | ± 3.0 | Rectangular | $\sqrt{3}$ | 1 | $\pm 1.732 \%$ | ∞ |
| Probe Positioner | ± 0.4 | Rectangular | $\sqrt{3}$ | 1 | $\pm 0.231 \%$ | ∞ |
| Probe Positioning | ± 2.9 | Rectangular | $\sqrt{3}$ | 1 | $\pm 1.674 \%$ | ∞ |
| Algorithms for Max. SAR Eval. | ± 1.0 | Rectangular | $\sqrt{3}$ | 1 | $\pm 0.577 \%$ | ∞ |
| Test Sample Related | | | | | | |
| Device Positioning | ± 2.9 | Normal | 1 | 1 | $\pm 2.9 \%$ | 145 |
| Device Holder | ± 3.6 | Normal | 1 | 1 | $\pm 3.6 \%$ | 5 |
| Power Drift | ± 5.0 | Rectangular | $\sqrt{3}$ | 1 | $\pm 2.887 \%$ | ∞ |
| Physical Parameters | | | | | | |
| Phantom Shell | ± 4.0 | Rectangular | $\sqrt{3}$ | 1 | $\pm 2.31 \%$ | ∞ |
| Liquid conductivity (Target) | ± 5.0 | Rectangular | $\sqrt{3}$ | 0.64 | $\pm 2.887 \%$ | ∞ |
| Liquid conductivity (Meas.) | ± 4.6 | Normal | 1 | 0.64 | $\pm 4.6 \%$ | ∞ |
| Liquid permittivity (Target) | ± 5.0 | Rectangular | $\sqrt{3}$ | 0.6 | $\pm 2.887 \%$ | ∞ |
| Liquid permittivity (Meas.) | ± 4.3 | Normal | 1 | 0.6 | $\pm 4.3 \%$ | ∞ |
| Combined Standard Uncertainty | | RSS | | | $\pm 12.2 \%$ | 330 |
| Expanded Uncertainty (k=2) | | | | | $\pm 24.4 \%$ | |

The above measurement uncertainties are according to IEEE P1528 (2003)

835 MHz Body

| Error Description | Uncertainty value $\pm\%$ | Probability Distribution | Divisor | (Ci) 1g | Standard (1g) | vi 2 or Veff |
|--------------------------------------|---------------------------|--------------------------|------------|---------|---------------------------------|--------------|
| Measurement System | | | | | | |
| Probe calibration | ± 6.0 | Normal | 1 | 1 | $\pm 6.0 \%$ | ∞ |
| Axial isotropy | ± 4.7 | Rectangular | $\sqrt{3}$ | 1 | $\pm 2.714 \%$ | ∞ |
| Hemispherical isotropy | ± 9.6 | Rectangular | $\sqrt{3}$ | 1 | $\pm 5.543 \%$ | ∞ |
| Boundary Effects | ± 0.8 | Rectangular | $\sqrt{3}$ | 1 | $\pm 0.462 \%$ | ∞ |
| Probe Linearity | ± 4.7 | Rectangular | $\sqrt{3}$ | 1 | $\pm 2.714 \%$ | ∞ |
| Detection limits | ± 0.25 | Rectangular | $\sqrt{3}$ | 1 | $\pm 0.144 \%$ | ∞ |
| Readout Electronics | ± 1.0 | Normal | 1 | 1 | $\pm 1.0 \%$ | ∞ |
| Response time | ± 0.8 | Rectangular | $\sqrt{3}$ | 1 | $\pm 0.462 \%$ | ∞ |
| Integration time | ± 2.6 | Rectangular | $\sqrt{3}$ | 1 | $\pm 1.501 \%$ | ∞ |
| RF Ambient Conditions | ± 3.0 | Rectangular | $\sqrt{3}$ | 1 | $\pm 1.732 \%$ | ∞ |
| Probe Positioner | ± 0.4 | Rectangular | $\sqrt{3}$ | 1 | $\pm 0.231 \%$ | ∞ |
| Probe Positioning | ± 2.9 | Rectangular | $\sqrt{3}$ | 1 | $\pm 1.674 \%$ | ∞ |
| Algorithms for Max. SAR Eval. | ± 1.0 | Rectangular | $\sqrt{3}$ | 1 | $\pm 0.577 \%$ | ∞ |
| Test Sample Related | | | | | | |
| Device Positioning | ± 2.9 | Normal | 1 | 1 | $\pm 2.9 \%$ | 145 |
| Device Holder | ± 3.6 | Normal | 1 | 1 | $\pm 3.6 \%$ | 5 |
| Power Drift | ± 5.0 | Rectangular | $\sqrt{3}$ | 1 | $\pm 2.887 \%$ | ∞ |
| Physical Parameters | | | | | | |
| Phantom Shell | ± 4.0 | Rectangular | $\sqrt{3}$ | 1 | $\pm 2.31 \%$ | ∞ |
| Liquid conductivity (Target) | ± 5.0 | Rectangular | $\sqrt{3}$ | 0.64 | $\pm 2.887 \%$ | ∞ |
| Liquid conductivity (Meas.) | ± 4.1 | Normal | 1 | 0.64 | $\pm 4.1 \%$ | ∞ |
| Liquid permittivity (Target) | ± 5.0 | Rectangular | $\sqrt{3}$ | 0.6 | $\pm 2.887 \%$ | ∞ |
| Liquid permittivity (Meas.) | ± 4.5 | Normal | 1 | 0.6 | $\pm 4.5 \%$ | ∞ |
| Combined Standard Uncertainty | | RSS | | | $\pm 12.1 \%$ | 330 |
| Expanded Uncertainty (k=2) | | | | | $\pm 24.2 \%$ | |

The above measurement uncertainties are according to IEEE P1528 (2003)

1900 MHz Head

| Error Description | Uncertainty value $\pm\%$ | Probability Distribution | Divisor | (Ci) 1g | Standard (1g) | vi 2 or Veff |
|--------------------------------------|---------------------------|--------------------------|------------|---------|---------------------------------|--------------|
| Measurement System | | | | | | |
| Probe calibration | ± 6.0 | Normal | 1 | 1 | $\pm 6.0 \%$ | ∞ |
| Axial isotropy | ± 4.7 | Rectangular | $\sqrt{3}$ | 1 | $\pm 2.714 \%$ | ∞ |
| Hemispherical isotropy | ± 9.6 | Rectangular | $\sqrt{3}$ | 1 | $\pm 5.543 \%$ | ∞ |
| Boundary Effects | ± 0.8 | Rectangular | $\sqrt{3}$ | 1 | $\pm 0.462 \%$ | ∞ |
| Probe Linearity | ± 4.7 | Rectangular | $\sqrt{3}$ | 1 | $\pm 2.714 \%$ | ∞ |
| Detection limits | ± 0.25 | Rectangular | $\sqrt{3}$ | 1 | $\pm 0.145 \%$ | ∞ |
| Readout Electronics | ± 1.0 | Normal | 1 | 1 | $\pm 1.0 \%$ | ∞ |
| Response time | ± 0.8 | Rectangular | $\sqrt{3}$ | 1 | $\pm 0.462 \%$ | ∞ |
| Integration time | ± 2.6 | Rectangular | $\sqrt{3}$ | 1 | $\pm 1.501 \%$ | ∞ |
| RF Ambient Conditions | ± 3.0 | Rectangular | $\sqrt{3}$ | 1 | $\pm 1.732 \%$ | ∞ |
| Probe Positioner | ± 0.4 | Rectangular | $\sqrt{3}$ | 1 | $\pm 0.231 \%$ | ∞ |
| Probe Positioning | ± 2.9 | Rectangular | $\sqrt{3}$ | 1 | $\pm 1.674 \%$ | ∞ |
| Algorithms for Max. SAR Eval. | ± 1.0 | Rectangular | $\sqrt{3}$ | 1 | $\pm 0.577 \%$ | ∞ |
| Test Sample Related | | | | | | |
| Device Positioning | ± 2.9 | Normal | 1 | 1 | $\pm 2.9 \%$ | 145 |
| Device Holder | ± 3.6 | Normal | 1 | 1 | $\pm 3.6 \%$ | 5 |
| Power Drift | ± 5.0 | Rectangular | $\sqrt{3}$ | 1 | $\pm 2.887 \%$ | ∞ |
| Physical Parameters | | | | | | |
| Phantom Shell | ± 4.0 | Rectangular | $\sqrt{3}$ | 1 | $\pm 2.31 \%$ | ∞ |
| Liquid conductivity (Target) | ± 5.0 | Rectangular | $\sqrt{3}$ | 0.64 | $\pm 2.887 \%$ | ∞ |
| Liquid conductivity (Meas.) | ± 4.3 | Normal | 1 | 0.64 | $\pm 4.3 \%$ | ∞ |
| Liquid permittivity (Target) | ± 5.0 | Rectangular | $\sqrt{3}$ | 0.6 | $\pm 2.887 \%$ | ∞ |
| Liquid permittivity (Meas.) | ± 4.7 | Normal | 1 | 0.6 | $\pm 4.7 \%$ | ∞ |
| Combined Standard Uncertainty | | RSS | | | $\pm 12.2 \%$ | 330 |
| Expanded Uncertainty (k=2) | | | | | $\pm 24.4 \%$ | |

The above measurement uncertainties are according to IEEE P1528 (2003)

1900 MHz Body

| Error Description | Uncertainty value $\pm\%$ | Probability Distribution | Divisor | (Ci) 1g | Standard (1g) | vi 2 or Veff |
|--------------------------------------|---------------------------|--------------------------|------------|---------|---------------------------------|--------------|
| Measurement System | | | | | | |
| Probe calibration | ± 6.0 | Normal | 1 | 1 | $\pm 6.0 \%$ | ∞ |
| Axial isotropy | ± 4.7 | Rectangular | $\sqrt{3}$ | 1 | $\pm 2.714 \%$ | ∞ |
| Hemispherical isotropy | ± 9.6 | Rectangular | $\sqrt{3}$ | 1 | $\pm 5.543 \%$ | ∞ |
| Boundary Effects | ± 0.8 | Rectangular | $\sqrt{3}$ | 1 | $\pm 0.462 \%$ | ∞ |
| Probe Linearity | ± 4.7 | Rectangular | $\sqrt{3}$ | 1 | $\pm 2.714 \%$ | ∞ |
| Detection limits | ± 0.25 | Rectangular | $\sqrt{3}$ | 1 | $\pm 0.145 \%$ | ∞ |
| Readout Electronics | ± 1.0 | Normal | 1 | 1 | $\pm 1.0 \%$ | ∞ |
| Response time | ± 0.8 | Rectangular | $\sqrt{3}$ | 1 | $\pm 0.462 \%$ | ∞ |
| Integration time | ± 2.6 | Rectangular | $\sqrt{3}$ | 1 | $\pm 1.501 \%$ | ∞ |
| RF Ambient Conditions | ± 3.0 | Rectangular | $\sqrt{3}$ | 1 | $\pm 1.732 \%$ | ∞ |
| Probe Positioner | ± 0.4 | Rectangular | $\sqrt{3}$ | 1 | $\pm 0.231 \%$ | ∞ |
| Probe Positioning | ± 2.9 | Rectangular | $\sqrt{3}$ | 1 | $\pm 1.674 \%$ | ∞ |
| Algorithms for Max. SAR Eval. | ± 1.0 | Rectangular | $\sqrt{3}$ | 1 | $\pm 0.577 \%$ | ∞ |
| Test Sample Related | | | | | | |
| Device Positioning | ± 2.9 | Normal | 1 | 1 | $\pm 2.9 \%$ | 145 |
| Device Holder | ± 3.6 | Normal | 1 | 1 | $\pm 3.6 \%$ | 5 |
| Power Drift | ± 5.0 | Rectangular | $\sqrt{3}$ | 1 | $\pm 2.887 \%$ | ∞ |
| Physical Parameters | | | | | | |
| Phantom Shell | ± 4.0 | Rectangular | $\sqrt{3}$ | 1 | $\pm 2.31 \%$ | ∞ |
| Liquid conductivity (Target) | ± 5.0 | Rectangular | $\sqrt{3}$ | 0.64 | $\pm 2.887 \%$ | ∞ |
| Liquid conductivity (Meas.) | ± 4.2 | Normal | 1 | 0.64 | $\pm 4.2 \%$ | ∞ |
| Liquid permittivity (Target) | ± 5.0 | Rectangular | $\sqrt{3}$ | 0.6 | $\pm 2.887 \%$ | ∞ |
| Liquid permittivity (Meas.) | ± 4.1 | Normal | 1 | 0.6 | $\pm 4.1 \%$ | ∞ |
| Combined Standard Uncertainty | | RSS | | | $\pm 12.1 \%$ | 330 |
| Expanded Uncertainty (k=2) | | | | | $\pm 24.2 \%$ | |

The above measurement uncertainties are according to IEEE P1528 (2003)

2450 MHz Head

| Error Description | Uncertainty value $\pm\%$ | Probability Distribution | Divisor | (Ci) 1g | Standard (1g) | vi 2 or Veff |
|--------------------------------------|---------------------------|--------------------------|------------|---------|---------------------------------|--------------|
| Measurement System | | | | | | |
| Probe calibration | ± 6.0 | Normal | 1 | 1 | $\pm 6.0 \%$ | ∞ |
| Axial isotropy | ± 4.7 | Rectangular | $\sqrt{3}$ | 1 | $\pm 2.714 \%$ | ∞ |
| Hemispherical isotropy | ± 9.6 | Rectangular | $\sqrt{3}$ | 1 | $\pm 5.543 \%$ | ∞ |
| Boundary Effects | ± 0.8 | Rectangular | $\sqrt{3}$ | 1 | $\pm 0.462 \%$ | ∞ |
| Probe Linearity | ± 4.7 | Rectangular | $\sqrt{3}$ | 1 | $\pm 2.714 \%$ | ∞ |
| Detection limits | ± 0.25 | Rectangular | $\sqrt{3}$ | 1 | $\pm 0.144 \%$ | ∞ |
| Readout Electronics | ± 1.0 | Normal | 1 | 1 | $\pm 1.0 \%$ | ∞ |
| Response time | ± 0.8 | Rectangular | $\sqrt{3}$ | 1 | $\pm 0.462 \%$ | ∞ |
| Integration time | ± 2.6 | Rectangular | $\sqrt{3}$ | 1 | $\pm 1.501 \%$ | ∞ |
| RF Ambient Conditions | ± 3.0 | Rectangular | $\sqrt{3}$ | 1 | $\pm 1.732 \%$ | ∞ |
| Probe Positioner | ± 0.4 | Rectangular | $\sqrt{3}$ | 1 | $\pm 0.231 \%$ | ∞ |
| Probe Positioning | ± 2.9 | Rectangular | $\sqrt{3}$ | 1 | $\pm 1.674 \%$ | ∞ |
| Algorithms for Max. SAR Eval. | ± 1.0 | Rectangular | $\sqrt{3}$ | 1 | $\pm 0.577 \%$ | ∞ |
| Test Sample Related | | | | | | |
| Device Positioning | ± 2.9 | Normal | 1 | 1 | $\pm 2.9 \%$ | 145 |
| Device Holder | ± 3.6 | Normal | 1 | 1 | $\pm 3.6 \%$ | 5 |
| Power Drift | ± 5.0 | Rectangular | $\sqrt{3}$ | 1 | $\pm 2.887 \%$ | ∞ |
| Physical Parameters | | | | | | |
| Phantom Shell | ± 4.0 | Rectangular | $\sqrt{3}$ | 1 | $\pm 2.31 \%$ | ∞ |
| Liquid conductivity (Target) | ± 5.0 | Rectangular | $\sqrt{3}$ | 0.64 | $\pm 2.887 \%$ | ∞ |
| Liquid conductivity (Meas.) | ± 4.7 | Normal | 1 | 0.64 | $\pm 4.7 \%$ | ∞ |
| Liquid permittivity (Target) | ± 5.0 | Rectangular | $\sqrt{3}$ | 0.6 | $\pm 2.887 \%$ | ∞ |
| Liquid permittivity (Meas.) | ± 4.8 | Normal | 1 | 0.6 | $\pm 4.8 \%$ | ∞ |
| Combined Standard Uncertainty | | RSS | | | $\pm 12.3 \%$ | 330 |
| Expanded Uncertainty (k=2) | | | | | $\pm 24.6 \%$ | |

The above measurement uncertainties are according to IEEE P1528 (2003)

2450 MHz Body

| Error Description | Uncertainty value $\pm\%$ | Probability Distribution | Divisor | (Ci) 1g | Standard (1g) | vi 2 or Veff |
|--------------------------------------|---------------------------|--------------------------|------------|---------|---------------------------------|--------------|
| Measurement System | | | | | | |
| Probe calibration | ± 6.0 | Normal | 1 | 1 | $\pm 6.0 \%$ | ∞ |
| Axial isotropy | ± 4.7 | Rectangular | $\sqrt{3}$ | 1 | $\pm 2.714 \%$ | ∞ |
| Hemispherical isotropy | ± 9.6 | Rectangular | $\sqrt{3}$ | 1 | $\pm 5.543 \%$ | ∞ |
| Boundary Effects | ± 0.8 | Rectangular | $\sqrt{3}$ | 1 | $\pm 0.462 \%$ | ∞ |
| Probe Linearity | ± 4.7 | Rectangular | $\sqrt{3}$ | 1 | $\pm 2.714 \%$ | ∞ |
| Detection limits | ± 0.25 | Rectangular | $\sqrt{3}$ | 1 | $\pm 0.144 \%$ | ∞ |
| Readout Electronics | ± 1.0 | Normal | 1 | 1 | $\pm 1.0 \%$ | ∞ |
| Response time | ± 0.8 | Rectangular | $\sqrt{3}$ | 1 | $\pm 0.462 \%$ | ∞ |
| Integration time | ± 2.6 | Rectangular | $\sqrt{3}$ | 1 | $\pm 1.501 \%$ | ∞ |
| RF Ambient Conditions | ± 3.0 | Rectangular | $\sqrt{3}$ | 1 | $\pm 1.732 \%$ | ∞ |
| Probe Positioner | ± 0.4 | Rectangular | $\sqrt{3}$ | 1 | $\pm 0.231 \%$ | ∞ |
| Probe Positioning | ± 2.9 | Rectangular | $\sqrt{3}$ | 1 | $\pm 1.674 \%$ | ∞ |
| Algorithms for Max. SAR Eval. | ± 1.0 | Rectangular | $\sqrt{3}$ | 1 | $\pm 0.577 \%$ | ∞ |
| Test Sample Related | | | | | | |
| Device Positioning | ± 2.9 | Normal | 1 | 1 | $\pm 2.9 \%$ | 145 |
| Device Holder | ± 3.6 | Normal | 1 | 1 | $\pm 3.6 \%$ | 5 |
| Power Drift | ± 5.0 | Rectangular | $\sqrt{3}$ | 1 | $\pm 2.887 \%$ | ∞ |
| Physical Parameters | | | | | | |
| Phantom Shell | ± 4.0 | Rectangular | $\sqrt{3}$ | 1 | $\pm 2.31 \%$ | ∞ |
| Liquid conductivity (Target) | ± 5.0 | Rectangular | $\sqrt{3}$ | 0.64 | $\pm 2.887 \%$ | ∞ |
| Liquid conductivity (Meas.) | ± 4.2 | Normal | 1 | 0.64 | $\pm 4.2 \%$ | ∞ |
| Liquid permittivity (Target) | ± 5.0 | Rectangular | $\sqrt{3}$ | 0.6 | $\pm 2.887 \%$ | ∞ |
| Liquid permittivity (Meas.) | ± 4.5 | Normal | 1 | 0.6 | $\pm 4.5 \%$ | ∞ |
| Combined Standard Uncertainty | | RSS | | | $\pm 12.1 \%$ | 330 |
| Expanded Uncertainty (k=2) | | | | | $\pm 24.2 \%$ | |

The above measurement uncertainties are according to IEEE P1528 (2003)

5200 MHz Head

| Error Description | Uncertainty value $\pm\%$ | Probability Distribution | Divisor | (Ci) 1g | Standard (1g) | vi 2 or Veff |
|--------------------------------------|---------------------------|--------------------------|------------|---------|---------------------------------|--------------|
| Measurement System | | | | | | |
| Probe calibration | ± 6.55 | Normal | 1 | 1 | $\pm 6.55 \%$ | ∞ |
| Axial isotropy | ± 4.7 | Rectangular | $\sqrt{3}$ | 1 | $\pm 2.714 \%$ | ∞ |
| Hemispherical isotropy | ± 9.6 | Rectangular | $\sqrt{3}$ | 1 | $\pm 5.543 \%$ | ∞ |
| Boundary Effects | ± 0.8 | Rectangular | $\sqrt{3}$ | 1 | $\pm 0.462 \%$ | ∞ |
| Probe Linearity | ± 4.7 | Rectangular | $\sqrt{3}$ | 1 | $\pm 2.714 \%$ | ∞ |
| Detection limits | ± 0.25 | Rectangular | $\sqrt{3}$ | 1 | $\pm 0.144 \%$ | ∞ |
| Readout Electronics | ± 1.0 | Normal | 1 | 1 | $\pm 1.0 \%$ | ∞ |
| Response time | ± 0.8 | Rectangular | $\sqrt{3}$ | 1 | $\pm 0.462 \%$ | ∞ |
| Integration time | ± 2.6 | Rectangular | $\sqrt{3}$ | 1 | $\pm 1.501 \%$ | ∞ |
| RF Ambient Conditions | ± 3.0 | Rectangular | $\sqrt{3}$ | 1 | $\pm 1.732 \%$ | ∞ |
| Probe Positioner | ± 0.4 | Rectangular | $\sqrt{3}$ | 1 | $\pm 0.231 \%$ | ∞ |
| Probe Positioning | ± 2.9 | Rectangular | $\sqrt{3}$ | 1 | $\pm 1.674 \%$ | ∞ |
| Algorithms for Max. SAR Eval. | ± 1.0 | Rectangular | $\sqrt{3}$ | 1 | $\pm 0.577 \%$ | ∞ |
| Test Sample Related | | | | | | |
| Device Positioning | ± 2.9 | Normal | 1 | 1 | $\pm 2.9 \%$ | 145 |
| Device Holder | ± 3.6 | Normal | 1 | 1 | $\pm 3.6 \%$ | 5 |
| Power Drift | ± 5.0 | Rectangular | $\sqrt{3}$ | 1 | $\pm 2.887 \%$ | ∞ |
| Physical Parameters | | | | | | |
| Phantom Shell | ± 4.0 | Rectangular | $\sqrt{3}$ | 1 | $\pm 2.31 \%$ | ∞ |
| Liquid conductivity (Target) | ± 5.0 | Rectangular | $\sqrt{3}$ | 0.64 | $\pm 2.887 \%$ | ∞ |
| Liquid conductivity (Meas.) | ± 4.3 | Normal | 1 | 0.64 | $\pm 4.3 \%$ | ∞ |
| Liquid permittivity (Target) | ± 5.0 | Rectangular | $\sqrt{3}$ | 0.6 | $\pm 2.887 \%$ | ∞ |
| Liquid permittivity (Meas.) | ± 4.4 | Normal | 1 | 0.6 | $\pm 4.4 \%$ | ∞ |
| Combined Standard Uncertainty | | RSS | | | $\pm 12.4 \%$ | 330 |
| Expanded Uncertainty (k=2) | | | | | $\pm 24.8 \%$ | |

The above measurement uncertainties are according to IEEE P1528 (2003)

5200 MHz Body

| Error Description | Uncertainty value $\pm\%$ | Probability Distribution | Divisor | (Ci) 1g | Standard (1g) | vi 2 or Veff |
|--------------------------------------|---------------------------|--------------------------|------------|---------|---------------------------------|--------------|
| Measurement System | | | | | | |
| Probe calibration | ± 6.55 | Normal | 1 | 1 | $\pm 6.55 \%$ | ∞ |
| Axial isotropy | ± 4.7 | Rectangular | $\sqrt{3}$ | 1 | $\pm 2.714 \%$ | ∞ |
| Hemispherical isotropy | ± 9.6 | Rectangular | $\sqrt{3}$ | 1 | $\pm 5.543 \%$ | ∞ |
| Boundary Effects | ± 0.8 | Rectangular | $\sqrt{3}$ | 1 | $\pm 0.462 \%$ | ∞ |
| Probe Linearity | ± 4.7 | Rectangular | $\sqrt{3}$ | 1 | $\pm 2.714 \%$ | ∞ |
| Detection limits | ± 0.25 | Rectangular | $\sqrt{3}$ | 1 | $\pm 0.144 \%$ | ∞ |
| Readout Electronics | ± 1.0 | Normal | 1 | 1 | $\pm 1.0 \%$ | ∞ |
| Response time | ± 0.8 | Rectangular | $\sqrt{3}$ | 1 | $\pm 0.462 \%$ | ∞ |
| Integration time | ± 2.6 | Rectangular | $\sqrt{3}$ | 1 | $\pm 1.501 \%$ | ∞ |
| RF Ambient Conditions | ± 3.0 | Rectangular | $\sqrt{3}$ | 1 | $\pm 1.732 \%$ | ∞ |
| Probe Positioner | ± 0.4 | Rectangular | $\sqrt{3}$ | 1 | $\pm 0.231 \%$ | ∞ |
| Probe Positioning | ± 2.9 | Rectangular | $\sqrt{3}$ | 1 | $\pm 1.674 \%$ | ∞ |
| Algorithms for Max. SAR Eval. | ± 1.0 | Rectangular | $\sqrt{3}$ | 1 | $\pm 0.577 \%$ | ∞ |
| Test Sample Related | | | | | | |
| Device Positioning | ± 2.9 | Normal | 1 | 1 | $\pm 2.9 \%$ | 145 |
| Device Holder | ± 3.6 | Normal | 1 | 1 | $\pm 3.6 \%$ | 5 |
| Power Drift | ± 5.0 | Rectangular | $\sqrt{3}$ | 1 | $\pm 2.887 \%$ | ∞ |
| Physical Parameters | | | | | | |
| Phantom Shell | ± 4.0 | Rectangular | $\sqrt{3}$ | 1 | $\pm 2.31 \%$ | ∞ |
| Liquid conductivity (Target) | ± 5.0 | Rectangular | $\sqrt{3}$ | 0.64 | $\pm 2.887 \%$ | ∞ |
| Liquid conductivity (Meas.) | ± 4.5 | Normal | 1 | 0.64 | $\pm 4.5 \%$ | ∞ |
| Liquid permittivity (Target) | ± 5.0 | Rectangular | $\sqrt{3}$ | 0.6 | $\pm 2.887 \%$ | ∞ |
| Liquid permittivity (Meas.) | ± 4.2 | Normal | 1 | 0.6 | $\pm 4.2 \%$ | ∞ |
| Combined Standard Uncertainty | | RSS | | | $\pm 12.4 \%$ | 330 |
| Expanded Uncertainty (k=2) | | | | | $\pm 24.8 \%$ | |

The above measurement uncertainties are according to IEEE P1528 (2003)

5300 MHz Head

| Error Description | Uncertainty value $\pm\%$ | Probability Distribution | Divisor | (Ci) 1g | Standard (1g) | vi 2 or Veff |
|--------------------------------------|---------------------------|--------------------------|------------|---------|---------------------------------|--------------|
| Measurement System | | | | | | |
| Probe calibration | ± 6.55 | Normal | 1 | 1 | $\pm 6.55 \%$ | ∞ |
| Axial isotropy | ± 4.7 | Rectangular | $\sqrt{3}$ | 1 | $\pm 2.714 \%$ | ∞ |
| Hemispherical isotropy | ± 9.6 | Rectangular | $\sqrt{3}$ | 1 | $\pm 5.543 \%$ | ∞ |
| Boundary Effects | ± 0.8 | Rectangular | $\sqrt{3}$ | 1 | $\pm 0.462 \%$ | ∞ |
| Probe Linearity | ± 4.7 | Rectangular | $\sqrt{3}$ | 1 | $\pm 2.714 \%$ | ∞ |
| Detection limits | ± 0.25 | Rectangular | $\sqrt{3}$ | 1 | $\pm 0.144 \%$ | ∞ |
| Readout Electronics | ± 1.0 | Normal | 1 | 1 | $\pm 1.0 \%$ | ∞ |
| Response time | ± 0.8 | Rectangular | $\sqrt{3}$ | 1 | $\pm 0.462 \%$ | ∞ |
| Integration time | ± 2.6 | Rectangular | $\sqrt{3}$ | 1 | $\pm 1.501 \%$ | ∞ |
| RF Ambient Conditions | ± 3.0 | Rectangular | $\sqrt{3}$ | 1 | $\pm 1.732 \%$ | ∞ |
| Probe Positioner | ± 0.4 | Rectangular | $\sqrt{3}$ | 1 | $\pm 0.231 \%$ | ∞ |
| Probe Positioning | ± 2.9 | Rectangular | $\sqrt{3}$ | 1 | $\pm 1.674 \%$ | ∞ |
| Algorithms for Max. SAR Eval. | ± 1.0 | Rectangular | $\sqrt{3}$ | 1 | $\pm 0.577 \%$ | ∞ |
| Test Sample Related | | | | | | |
| Device Positioning | ± 2.9 | Normal | 1 | 1 | $\pm 2.9 \%$ | 145 |
| Device Holder | ± 3.6 | Normal | 1 | 1 | $\pm 3.6 \%$ | 5 |
| Power Drift | ± 5.0 | Rectangular | $\sqrt{3}$ | 1 | $\pm 2.887 \%$ | ∞ |
| Physical Parameters | | | | | | |
| Phantom Shell | ± 4.0 | Rectangular | $\sqrt{3}$ | 1 | $\pm 2.31 \%$ | ∞ |
| Liquid conductivity (Target) | ± 5.0 | Rectangular | $\sqrt{3}$ | 0.64 | $\pm 2.887 \%$ | ∞ |
| Liquid conductivity (Meas.) | ± 4.3 | Normal | 1 | 0.64 | $\pm 4.3 \%$ | ∞ |
| Liquid permittivity (Target) | ± 5.0 | Rectangular | $\sqrt{3}$ | 0.6 | $\pm 2.887 \%$ | ∞ |
| Liquid permittivity (Meas.) | ± 3.9 | Normal | 1 | 0.6 | $\pm 3.9 \%$ | ∞ |
| Combined Standard Uncertainty | | RSS | | | $\pm 12.4 \%$ | 330 |
| Expanded Uncertainty (k=2) | | | | | $\pm 24.8 \%$ | |

The above measurement uncertainties are according to IEEE P1528 (2003)

5300 MHz Body

| Error Description | Uncertainty value $\pm\%$ | Probability Distribution | Divisor | (Ci) 1g | Standard (1g) | vi 2 or Veff |
|--------------------------------------|---------------------------|--------------------------|------------|---------|---------------------------------|--------------|
| Measurement System | | | | | | |
| Probe calibration | ± 6.55 | Normal | 1 | 1 | $\pm 6.55 \%$ | ∞ |
| Axial isotropy | ± 4.7 | Rectangular | $\sqrt{3}$ | 1 | $\pm 2.714 \%$ | ∞ |
| Hemispherical isotropy | ± 9.6 | Rectangular | $\sqrt{3}$ | 1 | $\pm 5.543 \%$ | ∞ |
| Boundary Effects | ± 0.8 | Rectangular | $\sqrt{3}$ | 1 | $\pm 0.462 \%$ | ∞ |
| Probe Linearity | ± 4.7 | Rectangular | $\sqrt{3}$ | 1 | $\pm 2.714 \%$ | ∞ |
| Detection limits | ± 0.25 | Rectangular | $\sqrt{3}$ | 1 | $\pm 0.144 \%$ | ∞ |
| Readout Electronics | ± 1.0 | Normal | 1 | 1 | $\pm 1.0 \%$ | ∞ |
| Response time | ± 0.8 | Rectangular | $\sqrt{3}$ | 1 | $\pm 0.462 \%$ | ∞ |
| Integration time | ± 2.6 | Rectangular | $\sqrt{3}$ | 1 | $\pm 1.501 \%$ | ∞ |
| RF Ambient Conditions | ± 3.0 | Rectangular | $\sqrt{3}$ | 1 | $\pm 1.732 \%$ | ∞ |
| Probe Positioner | ± 0.4 | Rectangular | $\sqrt{3}$ | 1 | $\pm 0.231 \%$ | ∞ |
| Probe Positioning | ± 2.9 | Rectangular | $\sqrt{3}$ | 1 | $\pm 1.674 \%$ | ∞ |
| Algorithms for Max. SAR Eval. | ± 1.0 | Rectangular | $\sqrt{3}$ | 1 | $\pm 0.577 \%$ | ∞ |
| Test Sample Related | | | | | | |
| Device Positioning | ± 2.9 | Normal | 1 | 1 | $\pm 2.9 \%$ | 145 |
| Device Holder | ± 3.6 | Normal | 1 | 1 | $\pm 3.6 \%$ | 5 |
| Power Drift | ± 5.0 | Rectangular | $\sqrt{3}$ | 1 | $\pm 2.887 \%$ | ∞ |
| Physical Parameters | | | | | | |
| Phantom Shell | ± 4.0 | Rectangular | $\sqrt{3}$ | 1 | $\pm 2.31 \%$ | ∞ |
| Liquid conductivity (Target) | ± 5.0 | Rectangular | $\sqrt{3}$ | 0.64 | $\pm 2.887 \%$ | ∞ |
| Liquid conductivity (Meas.) | ± 4.5 | Normal | 1 | 0.64 | $\pm 4.5 \%$ | ∞ |
| Liquid permittivity (Target) | ± 5.0 | Rectangular | $\sqrt{3}$ | 0.6 | $\pm 2.887 \%$ | ∞ |
| Liquid permittivity (Meas.) | ± 4.1 | Normal | 1 | 0.6 | $\pm 4.1 \%$ | ∞ |
| Combined Standard Uncertainty | | RSS | | | $\pm 12.4 \%$ | 330 |
| Expanded Uncertainty (k=2) | | | | | $\pm 24.8 \%$ | |

The above measurement uncertainties are according to IEEE P1528 (2003)

5600 MHz Head

| Error Description | Uncertainty value $\pm\%$ | Probability Distribution | Divisor | (Ci) 1g | Standard (1g) | vi 2 or Veff |
|--------------------------------------|---------------------------|--------------------------|------------|---------|---------------------------------|--------------|
| Measurement System | | | | | | |
| Probe calibration | ± 6.55 | Normal | 1 | 1 | $\pm 6.55 \%$ | ∞ |
| Axial isotropy | ± 4.7 | Rectangular | $\sqrt{3}$ | 1 | $\pm 2.714 \%$ | ∞ |
| Hemispherical isotropy | ± 9.6 | Rectangular | $\sqrt{3}$ | 1 | $\pm 5.543 \%$ | ∞ |
| Boundary Effects | ± 0.8 | Rectangular | $\sqrt{3}$ | 1 | $\pm 0.462 \%$ | ∞ |
| Probe Linearity | ± 4.7 | Rectangular | $\sqrt{3}$ | 1 | $\pm 2.714 \%$ | ∞ |
| Detection limits | ± 0.25 | Rectangular | $\sqrt{3}$ | 1 | $\pm 0.144 \%$ | ∞ |
| Readout Electronics | ± 1.0 | Normal | 1 | 1 | $\pm 1.0 \%$ | ∞ |
| Response time | ± 0.8 | Rectangular | $\sqrt{3}$ | 1 | $\pm 0.462 \%$ | ∞ |
| Integration time | ± 2.6 | Rectangular | $\sqrt{3}$ | 1 | $\pm 1.501 \%$ | ∞ |
| RF Ambient Conditions | ± 3.0 | Rectangular | $\sqrt{3}$ | 1 | $\pm 1.732 \%$ | ∞ |
| Probe Positioner | ± 0.4 | Rectangular | $\sqrt{3}$ | 1 | $\pm 0.231 \%$ | ∞ |
| Probe Positioning | ± 2.9 | Rectangular | $\sqrt{3}$ | 1 | $\pm 1.674 \%$ | ∞ |
| Algorithms for Max. SAR Eval. | ± 1.0 | Rectangular | $\sqrt{3}$ | 1 | $\pm 0.577 \%$ | ∞ |
| Test Sample Related | | | | | | |
| Device Positioning | ± 2.9 | Normal | 1 | 1 | $\pm 2.9 \%$ | 145 |
| Device Holder | ± 3.6 | Normal | 1 | 1 | $\pm 3.6 \%$ | 5 |
| Power Drift | ± 5.0 | Rectangular | $\sqrt{3}$ | 1 | $\pm 2.887 \%$ | ∞ |
| Physical Parameters | | | | | | |
| Phantom Shell | ± 4.0 | Rectangular | $\sqrt{3}$ | 1 | $\pm 2.31 \%$ | ∞ |
| Liquid conductivity (Target) | ± 5.0 | Rectangular | $\sqrt{3}$ | 0.64 | $\pm 2.887 \%$ | ∞ |
| Liquid conductivity (Meas.) | ± 4.2 | Normal | 1 | 0.64 | $\pm 4.2 \%$ | ∞ |
| Liquid permittivity (Target) | ± 5.0 | Rectangular | $\sqrt{3}$ | 0.6 | $\pm 2.887 \%$ | ∞ |
| Liquid permittivity (Meas.) | ± 4.7 | Normal | 1 | 0.6 | $\pm 4.7 \%$ | ∞ |
| Combined Standard Uncertainty | | RSS | | | $\pm 12.4 \%$ | 330 |
| Expanded Uncertainty (k=2) | | | | | $\pm 24.8 \%$ | |

The above measurement uncertainties are according to IEEE P1528 (2003)

5600 MHz Body

| Error Description | Uncertainty value $\pm\%$ | Probability Distribution | Divisor | (Ci) 1g | Standard (1g) | vi 2 or Veff |
|--------------------------------------|---------------------------|--------------------------|------------|---------|---------------------------------|--------------|
| Measurement System | | | | | | |
| Probe calibration | ± 6.55 | Normal | 1 | 1 | $\pm 6.55 \%$ | ∞ |
| Axial isotropy | ± 4.7 | Rectangular | $\sqrt{3}$ | 1 | $\pm 2.714 \%$ | ∞ |
| Hemispherical isotropy | ± 9.6 | Rectangular | $\sqrt{3}$ | 1 | $\pm 5.543 \%$ | ∞ |
| Boundary Effects | ± 0.8 | Rectangular | $\sqrt{3}$ | 1 | $\pm 0.462 \%$ | ∞ |
| Probe Linearity | ± 4.7 | Rectangular | $\sqrt{3}$ | 1 | $\pm 2.714 \%$ | ∞ |
| Detection limits | ± 0.25 | Rectangular | $\sqrt{3}$ | 1 | $\pm 0.144 \%$ | ∞ |
| Readout Electronics | ± 1.0 | Normal | 1 | 1 | $\pm 1.0 \%$ | ∞ |
| Response time | ± 0.8 | Rectangular | $\sqrt{3}$ | 1 | $\pm 0.462 \%$ | ∞ |
| Integration time | ± 2.6 | Rectangular | $\sqrt{3}$ | 1 | $\pm 1.501 \%$ | ∞ |
| RF Ambient Conditions | ± 3.0 | Rectangular | $\sqrt{3}$ | 1 | $\pm 1.732 \%$ | ∞ |
| Probe Positioner | ± 0.4 | Rectangular | $\sqrt{3}$ | 1 | $\pm 0.231 \%$ | ∞ |
| Probe Positioning | ± 2.9 | Rectangular | $\sqrt{3}$ | 1 | $\pm 1.674 \%$ | ∞ |
| Algorithms for Max. SAR Eval. | ± 1.0 | Rectangular | $\sqrt{3}$ | 1 | $\pm 0.577 \%$ | ∞ |
| Test Sample Related | | | | | | |
| Device Positioning | ± 2.9 | Normal | 1 | 1 | $\pm 2.9 \%$ | 145 |
| Device Holder | ± 3.6 | Normal | 1 | 1 | $\pm 3.6 \%$ | 5 |
| Power Drift | ± 5.0 | Rectangular | $\sqrt{3}$ | 1 | $\pm 2.887 \%$ | ∞ |
| Physical Parameters | | | | | | |
| Phantom Shell | ± 4.0 | Rectangular | $\sqrt{3}$ | 1 | $\pm 2.31 \%$ | ∞ |
| Liquid conductivity (Target) | ± 5.0 | Rectangular | $\sqrt{3}$ | 0.64 | $\pm 2.887 \%$ | ∞ |
| Liquid conductivity (Meas.) | ± 4.3 | Normal | 1 | 0.64 | $\pm 4.3 \%$ | ∞ |
| Liquid permittivity (Target) | ± 5.0 | Rectangular | $\sqrt{3}$ | 0.6 | $\pm 2.887 \%$ | ∞ |
| Liquid permittivity (Meas.) | ± 3.8 | Normal | 1 | 0.6 | $\pm 3.8 \%$ | ∞ |
| Combined Standard Uncertainty | | RSS | | | $\pm 12.3 \%$ | 330 |
| Expanded Uncertainty (k=2) | | | | | $\pm 24.6 \%$ | |

The above measurement uncertainties are according to IEEE P1528 (2003)

5800 MHz Head

| Error Description | Uncertainty value $\pm\%$ | Probability Distribution | Divisor | (Ci) 1g | Standard (1g) | vi 2 or Veff |
|--------------------------------------|---------------------------|--------------------------|------------|---------|---------------------------------|--------------|
| Measurement System | | | | | | |
| Probe calibration | ± 6.55 | Normal | 1 | 1 | $\pm 6.55 \%$ | ∞ |
| Axial isotropy | ± 4.7 | Rectangular | $\sqrt{3}$ | 1 | $\pm 2.714 \%$ | ∞ |
| Hemispherical isotropy | ± 9.6 | Rectangular | $\sqrt{3}$ | 1 | $\pm 5.543 \%$ | ∞ |
| Boundary Effects | ± 0.8 | Rectangular | $\sqrt{3}$ | 1 | $\pm 0.462 \%$ | ∞ |
| Probe Linearity | ± 4.7 | Rectangular | $\sqrt{3}$ | 1 | $\pm 2.714 \%$ | ∞ |
| Detection limits | ± 0.25 | Rectangular | $\sqrt{3}$ | 1 | $\pm 0.144 \%$ | ∞ |
| Readout Electronics | ± 1.0 | Normal | 1 | 1 | $\pm 1.0 \%$ | ∞ |
| Response time | ± 0.8 | Rectangular | $\sqrt{3}$ | 1 | $\pm 0.462 \%$ | ∞ |
| Integration time | ± 2.6 | Rectangular | $\sqrt{3}$ | 1 | $\pm 1.501 \%$ | ∞ |
| RF Ambient Conditions | ± 3.0 | Rectangular | $\sqrt{3}$ | 1 | $\pm 1.732 \%$ | ∞ |
| Probe Positioner | ± 0.4 | Rectangular | $\sqrt{3}$ | 1 | $\pm 0.231 \%$ | ∞ |
| Probe Positioning | ± 2.9 | Rectangular | $\sqrt{3}$ | 1 | $\pm 1.674 \%$ | ∞ |
| Algorithms for Max. SAR Eval. | ± 1.0 | Rectangular | $\sqrt{3}$ | 1 | $\pm 0.577 \%$ | ∞ |
| Test Sample Related | | | | | | |
| Device Positioning | ± 2.9 | Normal | 1 | 1 | $\pm 2.9 \%$ | 145 |
| Device Holder | ± 3.6 | Normal | 1 | 1 | $\pm 3.6 \%$ | 5 |
| Power Drift | ± 5.0 | Rectangular | $\sqrt{3}$ | 1 | $\pm 2.887 \%$ | ∞ |
| Physical Parameters | | | | | | |
| Phantom Shell | ± 4.0 | Rectangular | $\sqrt{3}$ | 1 | $\pm 2.31 \%$ | ∞ |
| Liquid conductivity (Target) | ± 5.0 | Rectangular | $\sqrt{3}$ | 0.64 | $\pm 2.887 \%$ | ∞ |
| Liquid conductivity (Meas.) | ± 4.2 | Normal | 1 | 0.64 | $\pm 4.2 \%$ | ∞ |
| Liquid permittivity (Target) | ± 5.0 | Rectangular | $\sqrt{3}$ | 0.6 | $\pm 2.887 \%$ | ∞ |
| Liquid permittivity (Meas.) | ± 4.4 | Normal | 1 | 0.6 | $\pm 4.4 \%$ | ∞ |
| Combined Standard Uncertainty | | RSS | | | $\pm 12.4 \%$ | 330 |
| Expanded Uncertainty (k=2) | | | | | $\pm 24.8 \%$ | |

The above measurement uncertainties are according to IEEE P1528 (2003)

5800 MHz Body

| Error Description | Uncertainty value $\pm\%$ | Probability Distribution | Divisor | (Ci) 1g | Standard (1g) | vi 2 or Veff |
|--------------------------------------|---------------------------|--------------------------|------------|---------|---------------------------------|--------------|
| Measurement System | | | | | | |
| Probe calibration | ± 6.55 | Normal | 1 | 1 | $\pm 6.55 \%$ | ∞ |
| Axial isotropy | ± 4.7 | Rectangular | $\sqrt{3}$ | 1 | $\pm 2.714 \%$ | ∞ |
| Hemispherical isotropy | ± 9.6 | Rectangular | $\sqrt{3}$ | 1 | $\pm 5.543 \%$ | ∞ |
| Boundary Effects | ± 0.8 | Rectangular | $\sqrt{3}$ | 1 | $\pm 0.462 \%$ | ∞ |
| Probe Linearity | ± 4.7 | Rectangular | $\sqrt{3}$ | 1 | $\pm 2.714 \%$ | ∞ |
| Detection limits | ± 0.25 | Rectangular | $\sqrt{3}$ | 1 | $\pm 0.144 \%$ | ∞ |
| Readout Electronics | ± 1.0 | Normal | 1 | 1 | $\pm 1.0 \%$ | ∞ |
| Response time | ± 0.8 | Rectangular | $\sqrt{3}$ | 1 | $\pm 0.462 \%$ | ∞ |
| Integration time | ± 2.6 | Rectangular | $\sqrt{3}$ | 1 | $\pm 1.501 \%$ | ∞ |
| RF Ambient Conditions | ± 3.0 | Rectangular | $\sqrt{3}$ | 1 | $\pm 1.732 \%$ | ∞ |
| Probe Positioner | ± 0.4 | Rectangular | $\sqrt{3}$ | 1 | $\pm 0.231 \%$ | ∞ |
| Probe Positioning | ± 2.9 | Rectangular | $\sqrt{3}$ | 1 | $\pm 1.674 \%$ | ∞ |
| Algorithms for Max. SAR Eval. | ± 1.0 | Rectangular | $\sqrt{3}$ | 1 | $\pm 0.577 \%$ | ∞ |
| Test Sample Related | | | | | | |
| Device Positioning | ± 2.9 | Normal | 1 | 1 | $\pm 2.9 \%$ | 145 |
| Device Holder | ± 3.6 | Normal | 1 | 1 | $\pm 3.6 \%$ | 5 |
| Power Drift | ± 5.0 | Rectangular | $\sqrt{3}$ | 1 | $\pm 2.887 \%$ | ∞ |
| Physical Parameters | | | | | | |
| Phantom Shell | ± 4.0 | Rectangular | $\sqrt{3}$ | 1 | $\pm 2.31 \%$ | ∞ |
| Liquid conductivity (Target) | ± 5.0 | Rectangular | $\sqrt{3}$ | 0.64 | $\pm 2.887 \%$ | ∞ |
| Liquid conductivity (Meas.) | ± 4.5 | Normal | 1 | 0.64 | $\pm 4.5 \%$ | ∞ |
| Liquid permittivity (Target) | ± 5.0 | Rectangular | $\sqrt{3}$ | 0.6 | $\pm 2.887 \%$ | ∞ |
| Liquid permittivity (Meas.) | ± 4.3 | Normal | 1 | 0.6 | $\pm 4.3 \%$ | ∞ |
| Combined Standard Uncertainty | | RSS | | | $\pm 12.4 \%$ | 330 |
| Expanded Uncertainty (k=2) | | | | | $\pm 24.8 \%$ | |

The above measurement uncertainties are according to IEEE P1528 (2003)

15. CONCLUSION

Measurement Conclusion

The SAR measurement indicates that the EUT complies with the RF radiation exposure limits of the FCC. These measurements are taken to simulate the RF effects exposure under the worst-case conditions. Precise laboratory measures were taken to assure repeatability of the tests. The tested device complies with the requirements in respect to all parameters subject to the test. The test results and statements relate only to the item(s) tested.

Please note that the absorption and distribution of electromagnetic energy in the body are very complex phenomena that depend on the mass, shape, and size of the body, the orientation of the body with respect to the field vectors, and the electrical properties of both the body and the environment. Other variables that may play a substantial role impossible biological effect are those that characterize the environment (e.g. ambient temperature, air velocity, relative humidity, and body insulation) and those that characterize the individual (e.g. age, gender, activity level, debilitation, or disease).

Because innumerable factors may interact to determine the specific biological outcome of an exposure to electromagnetic fields, any protection guide shall consider maximal amplification of biological effects as a result of field-body interactions, environmental conditions, and physiological variables.

16. REFERENCES

- [1] Federal Communications Commission, ET Docket 93-62, Guidelines for Evaluating the Environmental Effects of Radio frequency Radiation, Aug. 1996.
- [2] ANSI/IEEE C95.1-2005, American National Standard safety levels with respect to human exposure to radio frequency electromagnetic fields, 3kHz to 300GHz, New York: IEEE, 2006.
- [3] ANSI/IEEE C95.1-1992, American National Standard safety levels with respect to human exposure to radio frequency electromagnetic fields, 3kHz to 300GHz, New York: IEEE, Sept. 1992.
- [4] ANSI/IEEE C95.3-2002, IEEE Recommended Practice for the Measurement of Potentially Hazardous Electromagnetic Fields - RF and Microwave, New York: IEEE, December 2002.
- [5] IEEE Standards Coordinating Committee 39 –Standards Coordinating Committee 34 – IEEE Std. 1528-2003, Recommended Practice for Determining the Peak Spatial-Average Specific Absorption Rate (SAR) in the Human Body Due to Wireless Communications Devices.
- [6] NCRP, National Council on Radiation Protection and Measurements, Biological Effects and Exposure Criteria for Radio Frequency Electromagnetic Fields, NCRP Report No. 86, 1986. Reprinted Feb. 1995.
- [7] T. Schmid, O. Egger, N. Kuster, Automated E-field scanning system for dosimetric assessments, IEEE Transaction on Microwave Theory and Techniques, vol. 44, Jan. 1996, pp. 105-113.
- [8] K. Pokovic, T. Schmid, N. Kuster, Robust setup for precise calibration of E-field probes in tissue simulating liquids at mobile communications frequencies, ICECOM97, Oct. 1997, pp. -124.
- [9] K. Pokovic, T. Schmid, and N. Kuster, E-field Probe with improved isotropy in brain simulating liquids, Proceedings of the ELMAR, Zadar, Croatia, June 23-25, 1996, pp. 172-175.
- [10] Schmid & Partner Engineering AG, Application Note: Data Storage and Evaluation, June 1998, p2.
- [11] V. Hombach, K. Meier, M. Burkhardt, E. Kuhn, N. Kuster, The Dependence of EM Energy Absorption upon Human Modeling at 900 MHz, IEEE Transaction on Microwave Theory and Techniques, vol. 44 no. 10, Oct. 1996, pp. 1865-1873.
- [12] N. Kuster and Q. Balzano, Energy absorption mechanism by biological bodies in the near field of dipole antennas above 300MHz, IEEE Transaction on Vehicular Technology, vol. 41, no. 1, Feb. 1992, pp. 17-23.
- [13] G. Hartsgrrove, A. Kraszewski, A. Surowiec, Simulated Biological Materials for Electromagnetic Radiation Absorption Studies, University of Ottawa, Bioelectromagnetics, Canada: 1987, pp. 29-36.
- [14] Q. Balzano, O. Garay, T. Manning Jr., Electromagnetic Energy Exposure of Simulated Users of Portable Cellular Telephones, IEEE Transactions on Vehicular Technology, vol. 44, no.3, Aug. 1995.
- [15] W. Gander, Computer mathematick, Birkhaeuser, Basel, 1992.
- [16] W.H. Press, S.A. Teukolsky, W.T. Vetterling, and B.P. Flannery, Numerical Recipes in C, The Art of Scientific Computing, Second edition, Cambridge University Press, 1992.
- [17] N. Kuster, R. Kastle, T. Schmid, Dosimetric evaluation of mobile communications equipment with known precision, IEEE Transaction on Communications, vol. E80-B, no. 5, May 1997, pp. 645-652.
- [18] CENELEC CLC/SC111B, European Pre standard (prENV 50166-2), Human Exposure to Electromagnetic Fields High-frequency: 10 kHz-300GHz, Jan. 1995.
- [19] Prof. Dr. Niels Kuster, ETH, Eidgenössische Technische Hochschule Zürich, Dosimetric Evaluation of the Cellular Phone.
- [20] IEC 62209-1, Human exposure to radio frequency fields from hand-held and body-mounted wireless communication devices - Human models, instrumentation, and procedures - Part 1: Procedure to determine the specific absorption rate (SAR) for hand-held devices used in close proximity to the ear (frequency range of 300 MHz to 3 GHz), Feb. 2005.

- [21] Industry Canada RSS-102 Radio Frequency Exposure Compliance of Radio communication Apparatus (All Frequency Bands) Issue 4, March 2010.
- [22] Health Canada Safety Code 6 Limits of Human Exposure to Radio Frequency Electromagnetic Fields in the Frequency Range from 3 kHz – 300 GHz, 2009
- [23] FCC SAR Test Procedures for 2G-3G Devices, Mobile Hotspot and UMPC Devices KDB Publications 941225, D01-D07
- [24] SAR Measurement procedures for IEEE 802.11a/b/g KDB Publication 248227 D01v01r02
- [25] FCC SAR Considerations for Handsets with Multiple Transmitters and Antennas, KDB Publications 648474 D02-D04
- [26] FCC SAR Evaluation Considerations for Laptop, Notebook, Net book and Tablet Computers, FCC KDB Publication 616217 D04
- [27] FCC SAR Measurement and Reporting Requirements for 100MHz – 6 GHz, KDB Publications 865664 D01-D02
- [28] FCC General RF Exposure Guidance and SAR Procedures for Dongles, KDB Publication 447498, D01-D02
- [29] 615223 D01 802 16e WiMax SAR Guidance v01, Nov. 13, 2009
- [30] Anexo à Resolução No. 533, de 10 de Setembro de 2009.
- [31] IEC 62209-2, Human exposure to radio frequency fields from hand-held and body-mounted wireless communication devices - Human models, instrumentation, and procedures - Part 2: Procedure to determine the specific absorption rate (SAR) for wireless communication devices used in close proximity to the human body (frequency range of 30 MHz to 6 GHz), Mar. 2010.

Attachment 1. – Probe Calibration Data

**Calibration Laboratory of
Schmid & Partner
Engineering AG**
Zeughausstrasse 43, 8004 Zurich, Switzerland



S Schweizerischer Kalibrierdienst
C Service suisse d'étalonnage
S Servizio svizzero di taratura
S Swiss Calibration Service

Accredited by the Swiss Accreditation Service (SAS)
The Swiss Accreditation Service is one of the signatories to the EA
Multilateral Agreement for the recognition of calibration certificates

Accreditation No.: **SCS 108**

Client **Digital EMC (Dymstec)**

Certificate No: **EX3-3866_May14**

CALIBRATION CERTIFICATE

Object: **EX3DV4 - SN:3866**

Calibration procedure(s): **QA CAL-01.v9, QA CAL-12.v9, QA CAL-14.v4, QA CAL-23.v5,
QA CAL-25.v6
Calibration procedure for dosimetric E-field probes**

Calibration date: **May 20, 2014**

This calibration certificate documents the traceability to national standards, which realize the physical units of measurements (SI).
The measurements and the uncertainties with confidence probability are given on the following pages and are part of the certificate.

All calibrations have been conducted in the closed laboratory facility: environment temperature (22 ± 3)°C and humidity < 70%.

Calibration Equipment used (M&TE critical for calibration)

| Primary Standards | ID | Cal Date (Certificate No.) | Scheduled Calibration |
|----------------------------|-----------------|-----------------------------------|------------------------|
| Power meter E4419B | GB41293874 | 03-Apr-14 (No. 217-01911) | Apr-15 |
| Power sensor E4412A | MY41498087 | 03-Apr-14 (No. 217-01911) | Apr-15 |
| Reference 3 dB Attenuator | SN: S5054 (3c) | 03-Apr-14 (No. 217-01915) | Apr-15 |
| Reference 20 dB Attenuator | SN: S5277 (20x) | 03-Apr-14 (No. 217-01919) | Apr-15 |
| Reference 30 dB Attenuator | SN: S5129 (30b) | 03-Apr-14 (No. 217-01920) | Apr-15 |
| Reference Probe ES3DV2 | SN: 3013 | 30-Dec-13 (No. ES3-3013_Dec13) | Dec-14 |
| DAE4 | SN: 660 | 13-Dec-13 (No. DAE4-660_Dec13) | Dec-14 |
| Secondary Standards | ID | Check Date (in house) | Scheduled Check |
| RF generator HP 8648C | US3642U01700 | 4-Aug-99 (in house check Apr-13) | In house check: Apr-16 |
| Network Analyzer HP 8753E | US37390585 | 18-Oct-01 (in house check Oct-13) | In house check: Oct-14 |

| | Name | Function | Signature |
|----------------|----------------|-----------------------|-----------|
| Calibrated by: | Jeton Kastrati | Laboratory Technician | |
| Approved by: | Katja Pokovic | Technical Manager | |

Issued: May 20, 2014

This calibration certificate shall not be reproduced except in full without written approval of the laboratory.

Certificate No: EX3-3866_May14

Page 1 of 11

Calibration Laboratory of
Schmid & Partner
Engineering AG
Zeughausstrasse 43, 8004 Zurich, Switzerland



S Schweizerischer Kalibrierdienst
S Service suisse d'étalonnage
S Servizio svizzero di taratura
S Swiss Calibration Service

Accredited by the Swiss Accreditation Service (SAS)

Accreditation No.: SCS 108

The Swiss Accreditation Service is one of the signatories to the EA
Multilateral Agreement for the recognition of calibration certificates

Glossary:

| | |
|--------------------------|---|
| TSL | tissue simulating liquid |
| NORM _{x,y,z} | sensitivity in free space |
| ConvF | sensitivity in TSL / NORM _{x,y,z} |
| DCP | diode compression point |
| CF | crest factor (1/duty_cycle) of the RF signal |
| A, B, C, D | modulation dependent linearization parameters |
| Polarization φ | φ rotation around probe axis |
| Polarization ϑ | ϑ rotation around an axis that is in the plane normal to probe axis (at measurement center), i.e., $\vartheta = 0$ is normal to probe axis |
| Connector Angle | information used in DASY system to align probe sensor X to the robot coordinate system |

Calibration is Performed According to the Following Standards:

- IEEE Std 1528-2013, "IEEE Recommended Practice for Determining the Peak Spatial-Averaged Specific Absorption Rate (SAR) in the Human Head from Wireless Communications Devices: Measurement Techniques", June 2013
- IEC 62209-1, "Procedure to measure the Specific Absorption Rate (SAR) for hand-held devices used in close proximity to the ear (frequency range of 300 MHz to 3 GHz)", February 2005

Methods Applied and Interpretation of Parameters:

- NORM_{x,y,z}**: Assessed for E-field polarization $\vartheta = 0$ ($f \leq 900$ MHz in TEM-cell; $f > 1800$ MHz: R22 waveguide). NORM_{x,y,z} are only intermediate values, i.e., the uncertainties of NORM_{x,y,z} does not affect the E²-field uncertainty inside TSL (see below ConvF).
- NORM(f)_{x,y,z}** = NORM_{x,y,z} * frequency_response (see Frequency Response Chart). This linearization is implemented in DASY4 software versions later than 4.2. The uncertainty of the frequency response is included in the stated uncertainty of ConvF.
- DCP_{x,y,z}**: DCP are numerical linearization parameters assessed based on the data of power sweep with CW signal (no uncertainty required). DCP does not depend on frequency nor media.
- PAR**: PAR is the Peak to Average Ratio that is not calibrated but determined based on the signal characteristics
- A_{x,y,z}; B_{x,y,z}; C_{x,y,z}; D_{x,y,z}; VR_{x,y,z}**: A, B, C, D are numerical linearization parameters assessed based on the data of power sweep for specific modulation signal. The parameters do not depend on frequency nor media. VR is the maximum calibration range expressed in RMS voltage across the diode.
- ConvF and Boundary Effect Parameters**: Assessed in flat phantom using E-field (or Temperature Transfer Standard for $f \leq 800$ MHz) and inside waveguide using analytical field distributions based on power measurements for $f > 800$ MHz. The same setups are used for assessment of the parameters applied for boundary compensation (alpha, depth) of which typical uncertainty values are given. These parameters are used in DASY4 software to improve probe accuracy close to the boundary. The sensitivity in TSL corresponds to NORM_{x,y,z} * ConvF whereby the uncertainty corresponds to that given for ConvF. A frequency dependent ConvF is used in DASY version 4.4 and higher which allows extending the validity from ± 50 MHz to ± 100 MHz.
- Spherical isotropy (3D deviation from isotropy)**: in a field of low gradients realized using a flat phantom exposed by a patch antenna.
- Sensor Offset**: The sensor offset corresponds to the offset of virtual measurement center from the probe tip (on probe axis). No tolerance required.
- Connector Angle**: The angle is assessed using the information gained by determining the NORM_x (no uncertainty required).

EX3DV4 – SN:3866

May 20, 2014

Probe EX3DV4

SN:3866

Manufactured: February 2, 2012
Calibrated: May 20, 2014

Calibrated for DASY/EASY Systems
(Note: non-compatible with DASY2 system!)

EX3DV4- SN:3866

May 20, 2014

DASY/EASY - Parameters of Probe: EX3DV4 - SN:3866**Basic Calibration Parameters**

| | Sensor X | Sensor Y | Sensor Z | Unc (k=2) |
|---|----------|----------|----------|---------------|
| Norm ($\mu\text{V}/(\text{V}/\text{m})^2$) ^A | 0.42 | 0.46 | 0.40 | $\pm 10.1 \%$ |
| DCP (mV) ^B | 99.4 | 99.5 | 102.9 | |

Modulation Calibration Parameters

| UID | Communication System Name | | A dB | B dB $\sqrt{\mu\text{V}}$ | C | D dB | VR mV | Unc ^E (k=2) |
|-----|---------------------------|---|---------|------------------------------|-----|---------|----------|---------------------------|
| 0 | CW | X | 0.0 | 0.0 | 1.0 | 0.00 | 138.3 | $\pm 2.7 \%$ |
| | | Y | 0.0 | 0.0 | 1.0 | | 135.2 | |
| | | Z | 0.0 | 0.0 | 1.0 | | 141.0 | |

The reported uncertainty of measurement is stated as the standard uncertainty of measurement multiplied by the coverage factor $k=2$, which for a normal distribution corresponds to a coverage probability of approximately 95%.

^A The uncertainties of NormX,Y,Z do not affect the E²-field uncertainty inside TSL (see Pages 5 and 6).

^B Numerical linearization parameter: uncertainty not required.

^E Uncertainty is determined using the max. deviation from linear response applying rectangular distribution and is expressed for the square of the field value.

EX3DV4- SN:3866

May 20, 2014

DASY/EASY - Parameters of Probe: EX3DV4 - SN:3866**Calibration Parameter Determined in Head Tissue Simulating Media**

| f (MHz) ^C | Relative Permittivity ^F | Conductivity (S/m) ^F | ConvF X | ConvF Y | ConvF Z | Alpha ^G | Depth (mm) ^G | Unct. (k=2) |
|----------------------|------------------------------------|---------------------------------|---------|---------|---------|--------------------|-------------------------|-------------|
| 300 | 45.3 | 0.87 | 11.26 | 11.26 | 11.26 | 0.08 | 1.10 | ± 13.3 % |
| 450 | 43.5 | 0.87 | 11.97 | 11.97 | 11.97 | 0.16 | 1.25 | ± 13.3 % |
| 600 | 42.7 | 0.88 | 9.84 | 9.84 | 9.84 | 0.10 | 1.20 | ± 13.3 % |
| 750 | 41.9 | 0.89 | 9.62 | 9.62 | 9.62 | 0.30 | 1.10 | ± 12.0 % |
| 835 | 41.5 | 0.90 | 9.22 | 9.22 | 9.22 | 0.21 | 1.19 | ± 12.0 % |
| 900 | 41.5 | 0.97 | 9.17 | 9.17 | 9.17 | 0.43 | 0.77 | ± 12.0 % |
| 1750 | 40.1 | 1.37 | 7.85 | 7.85 | 7.85 | 0.27 | 0.99 | ± 12.0 % |
| 1900 | 40.0 | 1.40 | 7.57 | 7.57 | 7.57 | 0.64 | 0.63 | ± 12.0 % |
| 2300 | 39.5 | 1.67 | 7.25 | 7.25 | 7.25 | 0.58 | 0.65 | ± 12.0 % |
| 2450 | 39.2 | 1.80 | 6.90 | 6.90 | 6.90 | 0.49 | 0.71 | ± 12.0 % |
| 2600 | 39.0 | 1.96 | 6.73 | 6.73 | 6.73 | 0.33 | 0.97 | ± 12.0 % |
| 3500 | 37.9 | 2.91 | 6.79 | 6.79 | 6.79 | 0.40 | 0.98 | ± 13.1 % |
| 5200 | 36.0 | 4.66 | 5.16 | 5.16 | 5.16 | 0.40 | 1.80 | ± 13.1 % |
| 5300 | 35.9 | 4.76 | 4.94 | 4.94 | 4.94 | 0.40 | 1.80 | ± 13.1 % |
| 5500 | 35.6 | 4.96 | 4.60 | 4.60 | 4.60 | 0.40 | 1.80 | ± 13.1 % |
| 5600 | 35.5 | 5.07 | 4.42 | 4.42 | 4.42 | 0.40 | 1.80 | ± 13.1 % |
| 5800 | 35.3 | 5.27 | 4.62 | 4.62 | 4.62 | 0.40 | 1.80 | ± 13.1 % |

^C Frequency validity above 300 MHz of ± 100 MHz only applies for DASY v4.4 and higher (see Page 2), else it is restricted to ± 50 MHz. The uncertainty is the RSS of the ConvF uncertainty at calibration frequency and the uncertainty for the indicated frequency band. Above 5 GHz frequency validity can be extended to ± 110 MHz. Frequency validity below 300 MHz is ± 10, 25, 40, 50 and 70 MHz for ConvF assessments at 30, 64, 128, 150 and 220 MHz respectively.

^F At frequencies below 3 GHz, the validity of tissue parameters (ϵ and σ) can be relaxed to ± 10% if liquid compensation formula is applied to measured SAR values. At frequencies above 3 GHz, the validity of tissue parameters (ϵ and σ) is restricted to ± 5%. The uncertainty is the RSS of the ConvF uncertainty for indicated target tissue parameters.

^G Alpha/Depth are determined during calibration. SPEAG warrants that the remaining deviation due to the boundary effect after compensation is always less than ± 1% for frequencies below 3 GHz and below ± 2% for frequencies between 3-6 GHz at any distance larger than half the probe tip diameter from the boundary.

EX3DV4- SN:3866

May 20, 2014

DASY/EASY - Parameters of Probe: EX3DV4 - SN:3866

Calibration Parameter Determined in Body Tissue Simulating Media

| f (MHz) ^C | Relative Permittivity ^F | Conductivity (S/m) ^F | ConvF X | ConvF Y | ConvF Z | Alpha ^G | Depth (mm) ^G | Unct. (k=2) |
|----------------------|------------------------------------|---------------------------------|---------|---------|---------|--------------------|-------------------------|-------------|
| 300 | 58.2 | 0.92 | 10.88 | 10.88 | 10.88 | 0.08 | 1.10 | ± 13.3 % |
| 450 | 56.7 | 0.94 | 10.83 | 10.83 | 10.83 | 0.10 | 1.20 | ± 13.3 % |
| 600 | 56.1 | 0.95 | 9.99 | 9.99 | 9.99 | 0.05 | 1.15 | ± 13.3 % |
| 750 | 55.5 | 0.96 | 9.17 | 9.17 | 9.17 | 0.30 | 1.05 | ± 12.0 % |
| 835 | 55.2 | 0.97 | 9.07 | 9.07 | 9.07 | 0.32 | 0.97 | ± 12.0 % |
| 900 | 55.0 | 1.05 | 8.93 | 8.93 | 8.93 | 0.46 | 0.79 | ± 12.0 % |
| 1750 | 53.4 | 1.49 | 7.81 | 7.81 | 7.81 | 0.42 | 0.84 | ± 12.0 % |
| 1900 | 53.3 | 1.52 | 7.40 | 7.40 | 7.40 | 0.39 | 0.88 | ± 12.0 % |
| 2300 | 52.9 | 1.81 | 7.20 | 7.20 | 7.20 | 0.51 | 0.74 | ± 12.0 % |
| 2450 | 52.7 | 1.95 | 7.00 | 7.00 | 7.00 | 0.80 | 0.58 | ± 12.0 % |
| 2600 | 52.5 | 2.16 | 6.74 | 6.74 | 6.74 | 0.80 | 0.50 | ± 12.0 % |
| 3500 | 51.3 | 3.31 | 6.32 | 6.32 | 6.32 | 0.40 | 1.06 | ± 13.1 % |
| 5200 | 49.0 | 5.30 | 4.28 | 4.28 | 4.28 | 0.40 | 1.90 | ± 13.1 % |
| 5300 | 48.9 | 5.42 | 4.12 | 4.12 | 4.12 | 0.40 | 1.90 | ± 13.1 % |
| 5500 | 48.6 | 5.65 | 3.72 | 3.72 | 3.72 | 0.50 | 1.90 | ± 13.1 % |
| 5600 | 48.5 | 5.77 | 3.60 | 3.60 | 3.60 | 0.50 | 1.90 | ± 13.1 % |
| 5800 | 48.2 | 6.00 | 3.90 | 3.90 | 3.90 | 0.50 | 1.90 | ± 13.1 % |

^C Frequency validity above 300 MHz of ± 100 MHz only applies for DASY v4.4 and higher (see Page 2), else it is restricted to ± 50 MHz. The uncertainty is the RSS of the ConvF uncertainty at calibration frequency and the uncertainty for the indicated frequency band. Above 5 GHz frequency validity can be extended to ± 110 MHz. Frequency validity below 300 MHz is ± 10 , 25, 40, 50 and 70 MHz for ConvF assessments at 30, 64, 128, 150 and 220 MHz respectively.

^F At frequencies below 3 GHz, the validity of tissue parameters (ϵ and σ) can be relaxed to $\pm 10\%$ if liquid compensation formula is applied to measured SAR values. At frequencies above 3 GHz, the validity of tissue parameters (ϵ and σ) is restricted to $\pm 5\%$. The uncertainty is the RSS of the ConvF uncertainty for indicated target tissue parameters.

^G Alpha/Depth are determined during calibration. SPEAG warrants that the remaining deviation due to the boundary effect after compensation is always less than $\pm 1\%$ for frequencies below 3 GHz and below $\pm 2\%$ for frequencies between 3-6 GHz at any distance larger than half the probe tip diameter from the boundary.

EX3DV4- SN:3866

May 20, 2014

Frequency Response of E-Field (TEM-Cell:ifi110 EXX, Waveguide: R22)

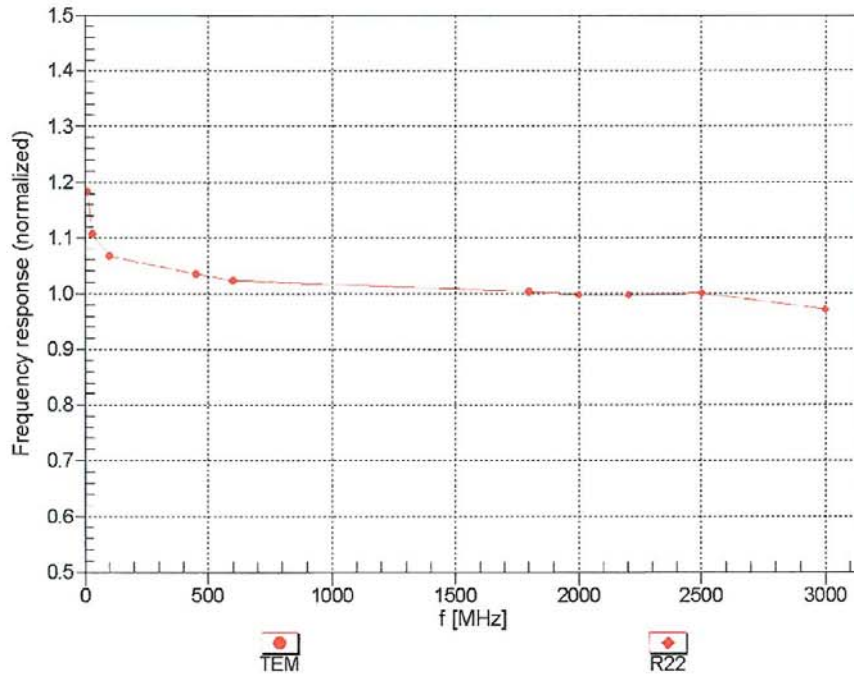

Uncertainty of Frequency Response of E-field: $\pm 6.3\%$ (k=2)

EX3DV4- SN:3866

May 20, 2014

Receiving Pattern (ϕ), $\vartheta = 0^\circ$

f=600 MHz,TEM

f=1800 MHz,R22

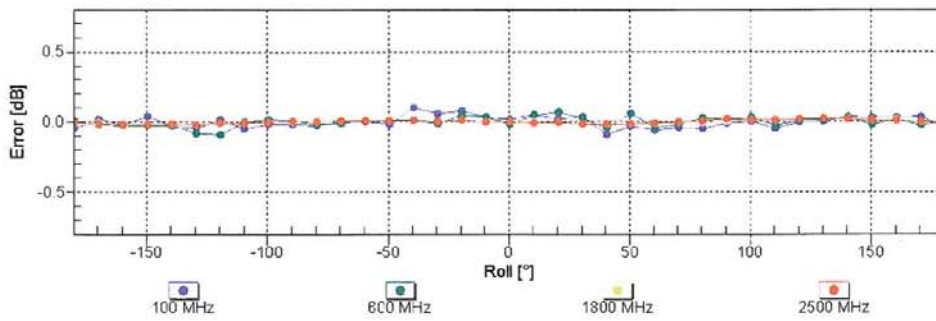
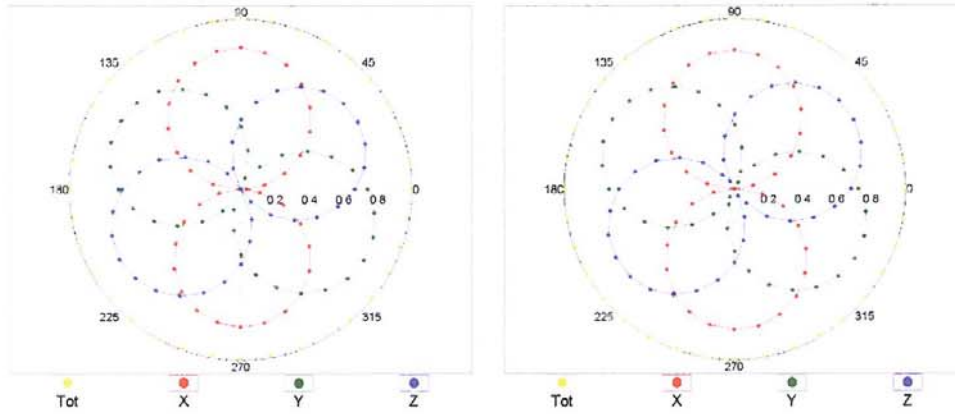

Uncertainty of Axial Isotropy Assessment: $\pm 0.5\%$ (k=2)

EX3DV4- SN:3866

May 20, 2014

Dynamic Range $f(SAR_{head})$ (TEM cell , $f_{eval}= 1900$ MHz)

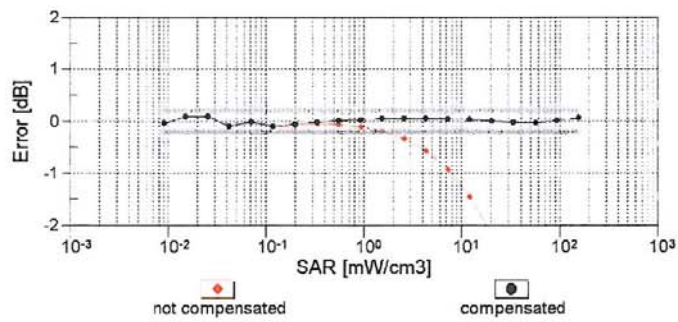
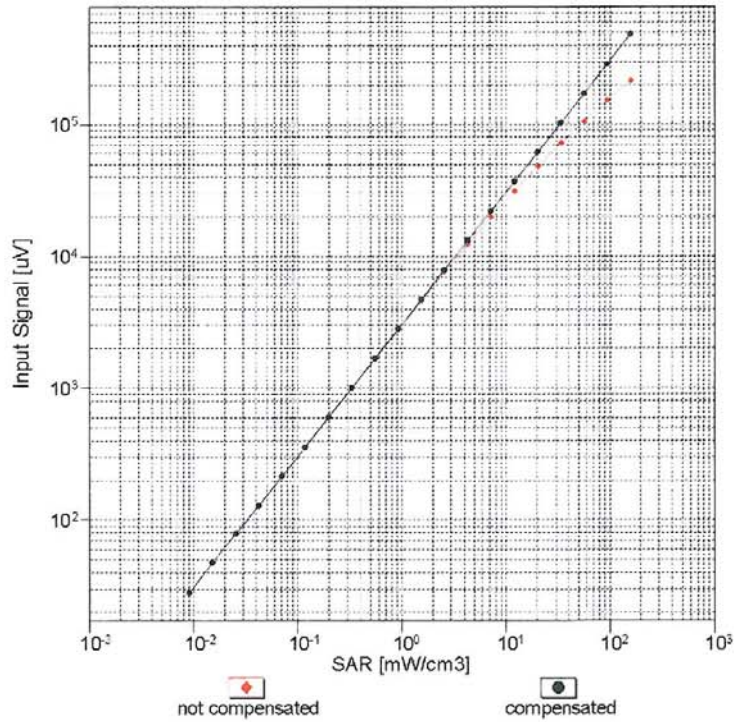

Uncertainty of Linearity Assessment: $\pm 0.6\%$ (k=2)

EX3DV4- SN:3866

May 20, 2014

Conversion Factor Assessment

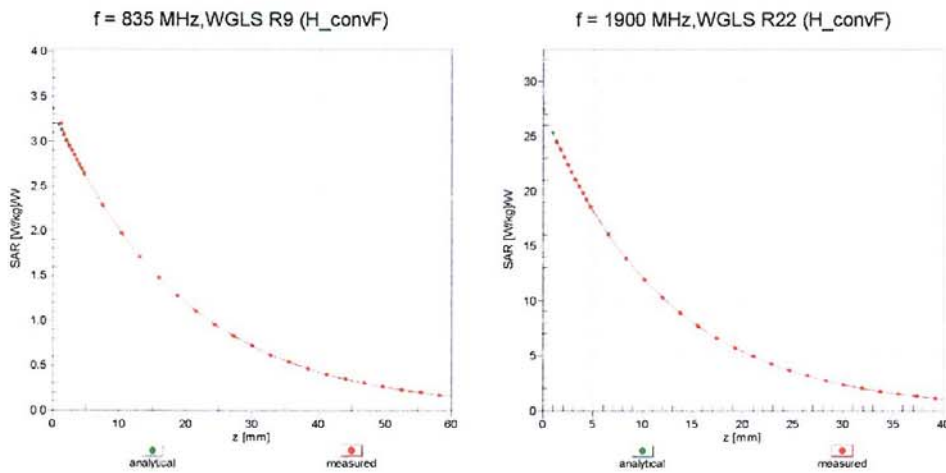

Deviation from Isotropy in Liquid Error (ϕ, θ), f = 900 MHz

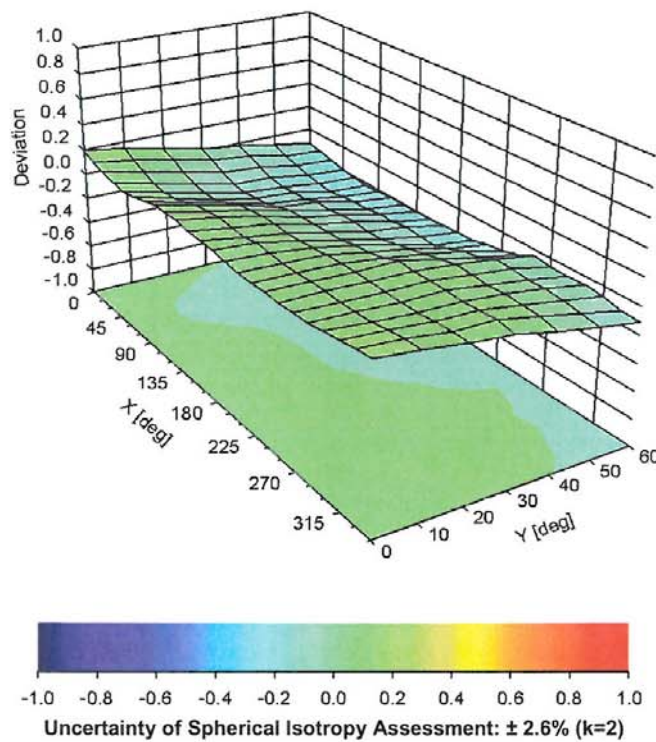

EX3DV4- SN:3866

May 20, 2014

DASY/EASY - Parameters of Probe: EX3DV4 - SN:3866**Other Probe Parameters**

| | |
|---|------------|
| Sensor Arrangement | Triangular |
| Connector Angle (°) | -109.6 |
| Mechanical Surface Detection Mode | enabled |
| Optical Surface Detection Mode | disabled |
| Probe Overall Length | 337 mm |
| Probe Body Diameter | 10 mm |
| Tip Length | 9 mm |
| Tip Diameter | 2.5 mm |
| Probe Tip to Sensor X Calibration Point | 1 mm |
| Probe Tip to Sensor Y Calibration Point | 1 mm |
| Probe Tip to Sensor Z Calibration Point | 1 mm |
| Recommended Measurement Distance from Surface | 2 mm |

Attachment 2. – Dipole Calibration Data

**Calibration Laboratory of
Schmid & Partner
Engineering AG**
Zeughausstrasse 43, 8004 Zurich, Switzerland



S Schweizerischer Kalibrierdienst
C Service suisse d'étalonnage
S Servizio svizzero di taratura
S Swiss Calibration Service

Accredited by the Swiss Accreditation Service (SAS)
The Swiss Accreditation Service is one of the signatories to the EA
Multilateral Agreement for the recognition of calibration certificates

Accreditation No.: **SCS 108**

Client **Digital EMC (Dymstec)**

Certificate No: **D835V2-464_Jan14**

CALIBRATION CERTIFICATE

Object **D835V2 - SN: 464**

Calibration procedure(s) **QA CAL-05.v9
Calibration procedure for dipole validation kits above 700 MHz**

Calibration date: **January 22, 2014**

This calibration certificate documents the traceability to national standards, which realize the physical units of measurements (SI).
The measurements and the uncertainties with confidence probability are given on the following pages and are part of the certificate.

All calibrations have been conducted in the closed laboratory facility: environment temperature (22 ± 3)°C and humidity < 70%.

Calibration Equipment used (M&TE critical for calibration)

| Primary Standards | ID # | Cal Date (Certificate No.) | Scheduled Calibration |
|-----------------------------|--------------------|--------------------------------|-----------------------|
| Power meter EPM-442A | GB37480704 | 09-Oct-13 (No. 217-01827) | Oct-14 |
| Power sensor HP 8481A | US37292783 | 09-Oct-13 (No. 217-01827) | Oct-14 |
| Power sensor HP 8481A | MY41092317 | 09-Oct-13 (No. 217-01828) | Oct-14 |
| Reference 20 dB Attenuator | SN: 5058 (20k) | 04-Apr-13 (No. 217-01736) | Apr-14 |
| Type-N mismatch combination | SN: 5047.3 / 06327 | 04-Apr-13 (No. 217-01739) | Apr-14 |
| Reference Probe ES3DV3 | SN: 3205 | 30-Dec-13 (No. ES3-3205_Dec13) | Dec-14 |
| DAE4 | SN: 601 | 25-Apr-13 (No. DAE4-601_Apr13) | Apr-14 |

| Secondary Standards | ID # | Check Date (in house) | Scheduled Check |
|---------------------------|------------------|-----------------------------------|------------------------|
| RF generator R&S SMT-06 | 100005 | 04-Aug-99 (in house check Oct-13) | In house check: Oct-16 |
| Network Analyzer HP 8753E | US37390585 S4206 | 18-Oct-01 (in house check Oct-13) | In house check: Oct-14 |

| | Name | Function | Signature |
|----------------|----------------|-----------------------|-----------|
| Calibrated by: | Jeton Kastrati | Laboratory Technician | |
| Approved by: | Katja Pokovic | Technical Manager | |

Issued: January 22, 2014

This calibration certificate shall not be reproduced except in full without written approval of the laboratory.

**Calibration Laboratory of
Schmid & Partner
Engineering AG**
Zeughausstrasse 43, 8004 Zurich, Switzerland



S Schweizerischer Kalibrierdienst
C Service suisse d'étalonnage
S Servizio svizzero di taratura
S Swiss Calibration Service

Accredited by the Swiss Accreditation Service (SAS)

Accreditation No.: **SCS 108**

The Swiss Accreditation Service is one of the signatories to the EA
Multilateral Agreement for the recognition of calibration certificates

Glossary:

| | |
|-------|---------------------------------|
| TSL | tissue simulating liquid |
| ConvF | sensitivity in TSL / NORM x,y,z |
| N/A | not applicable or not measured |

Calibration is Performed According to the Following Standards:

- IEEE Std 1528-2013, "IEEE Recommended Practice for Determining the Peak Spatial-Averaged Specific Absorption Rate (SAR) in the Human Head from Wireless Communications Devices: Measurement Techniques", June 2013
- IEC 62209-1, "Procedure to measure the Specific Absorption Rate (SAR) for hand-held devices used in close proximity to the ear (frequency range of 300 MHz to 3 GHz)", February 2005
- KDB 865664, "SAR Measurement Requirements for 100 MHz to 6 GHz"

Additional Documentation:

- DASY4/5 System Handbook

Methods Applied and Interpretation of Parameters:

- Measurement Conditions:* Further details are available from the Validation Report at the end of the certificate. All figures stated in the certificate are valid at the frequency indicated.
- Antenna Parameters with TSL:* The dipole is mounted with the spacer to position its feed point exactly below the center marking of the flat phantom section, with the arms oriented parallel to the body axis.
- Feed Point Impedance and Return Loss:* These parameters are measured with the dipole positioned under the liquid filled phantom. The impedance stated is transformed from the measurement at the SMA connector to the feed point. The Return Loss ensures low reflected power. No uncertainty required.
- Electrical Delay:* One-way delay between the SMA connector and the antenna feed point. No uncertainty required.
- SAR measured:* SAR measured at the stated antenna input power.
- SAR normalized:* SAR as measured, normalized to an input power of 1 W at the antenna connector.
- SAR for nominal TSL parameters:* The measured TSL parameters are used to calculate the nominal SAR result.

The reported uncertainty of measurement is stated as the standard uncertainty of measurement multiplied by the coverage factor $k=2$, which for a normal distribution corresponds to a coverage probability of approximately 95%.

Measurement Conditions

DASY system configuration, as far as not given on page 1.

| | | |
|------------------------------|------------------------|-------------|
| DASY Version | DASY5 | V52.8.7 |
| Extrapolation | Advanced Extrapolation | |
| Phantom | Modular Flat Phantom | |
| Distance Dipole Center - TSL | 15 mm | with Spacer |
| Zoom Scan Resolution | dx, dy, dz = 5 mm | |
| Frequency | 835 MHz \pm 1 MHz | |

Head TSL parameters

The following parameters and calculations were applied.

| | Temperature | Permittivity | Conductivity |
|---|---------------------|----------------|----------------------|
| Nominal Head TSL parameters | 22.0 °C | 41.5 | 0.90 mho/m |
| Measured Head TSL parameters | (22.0 \pm 0.2) °C | 40.6 \pm 6 % | 0.93 mho/m \pm 6 % |
| Head TSL temperature change during test | < 0.5 °C | ---- | ---- |

SAR result with Head TSL

| SAR averaged over 1 cm ³ (1 g) of Head TSL | Condition | |
|---|--------------------|--|
| SAR measured | 250 mW input power | 2.39 W/kg |
| SAR for nominal Head TSL parameters | normalized to 1W | 9.28 W/kg \pm 17.0 % (k=2) |

| SAR averaged over 10 cm ³ (10 g) of Head TSL | condition | |
|---|--------------------|--|
| SAR measured | 250 mW input power | 1.54 W/kg |
| SAR for nominal Head TSL parameters | normalized to 1W | 6.02 W/kg \pm 16.5 % (k=2) |

Body TSL parameters

The following parameters and calculations were applied.

| | Temperature | Permittivity | Conductivity |
|---|---------------------|----------------|----------------------|
| Nominal Body TSL parameters | 22.0 °C | 55.2 | 0.97 mho/m |
| Measured Body TSL parameters | (22.0 \pm 0.2) °C | 53.6 \pm 6 % | 1.01 mho/m \pm 6 % |
| Body TSL temperature change during test | < 0.5 °C | ---- | ---- |

SAR result with Body TSL

| SAR averaged over 1 cm ³ (1 g) of Body TSL | Condition | |
|---|--------------------|--|
| SAR measured | 250 mW input power | 2.42 W/kg |
| SAR for nominal Body TSL parameters | normalized to 1W | 9.35 W/kg \pm 17.0 % (k=2) |

| SAR averaged over 10 cm ³ (10 g) of Body TSL | condition | |
|---|--------------------|--|
| SAR measured | 250 mW input power | 1.57 W/kg |
| SAR for nominal Body TSL parameters | normalized to 1W | 6.12 W/kg \pm 16.5 % (k=2) |

Appendix**Antenna Parameters with Head TSL**

| | |
|--------------------------------------|--------------------------------|
| Impedance, transformed to feed point | 50.8 Ω - 0.6 j Ω |
| Return Loss | - 40.4 dB |

Antenna Parameters with Body TSL

| | |
|--------------------------------------|--------------------------------|
| Impedance, transformed to feed point | 46.3 Ω - 2.9 j Ω |
| Return Loss | - 26.2 dB |

General Antenna Parameters and Design

| | |
|----------------------------------|----------|
| Electrical Delay (one direction) | 1.382 ns |
|----------------------------------|----------|

After long term use with 100W radiated power, only a slight warming of the dipole near the feedpoint can be measured.

The dipole is made of standard semirigid coaxial cable. The center conductor of the feeding line is directly connected to the second arm of the dipole. The antenna is therefore short-circuited for DC-signals. On some of the dipoles, small end caps are added to the dipole arms in order to improve matching when loaded according to the position as explained in the "Measurement Conditions" paragraph. The SAR data are not affected by this change. The overall dipole length is still according to the Standard.

No excessive force must be applied to the dipole arms, because they might bend or the soldered connections near the feedpoint may be damaged.

Additional EUT Data

| | |
|-----------------|----------------|
| Manufactured by | SPEAG |
| Manufactured on | March 27, 2002 |

DASY5 Validation Report for Head TSL

Date: 22.01.2014

Test Laboratory: SPEAG, Zurich, Switzerland

DUT: Dipole 835 MHz; Type: D835V2; Serial: D835V2 - SN: 464

Communication System: UID 0 - CW; Frequency: 835 MHz

Medium parameters used: $f = 835$ MHz; $\sigma = 0.93$ S/m; $\epsilon_r = 40.6$; $\rho = 1000$ kg/m³

Phantom section: Flat Section

Measurement Standard: DASY5 (IEEE/IEC/ANSI C63.19-2007)

DASY52 Configuration:

- Probe: ES3DV3 - SN3205; ConvF(6.22, 6.22, 6.22); Calibrated: 30.12.2013;
- Sensor-Surface: 3mm (Mechanical Surface Detection)
- Electronics: DAE4 Sn601; Calibrated: 25.04.2013
- Phantom: Flat Phantom 4.9L; Type: QD000P49AA; Serial: 1001
- DASY52 52.8.7(1137); SEMCAD X 14.6.10(7164)

Dipole Calibration for Head Tissue/Pin=250 mW, d=15mm/Zoom Scan (7x7x7)/Cube 0:

Measurement grid: dx=5mm, dy=5mm, dz=5mm

Reference Value = 57.642 V/m; Power Drift = -0.07 dB

Peak SAR (extrapolated) = 3.59 W/kg

SAR(1 g) = 2.39 W/kg; SAR(10 g) = 1.54 W/kg

Maximum value of SAR (measured) = 2.79 W/kg

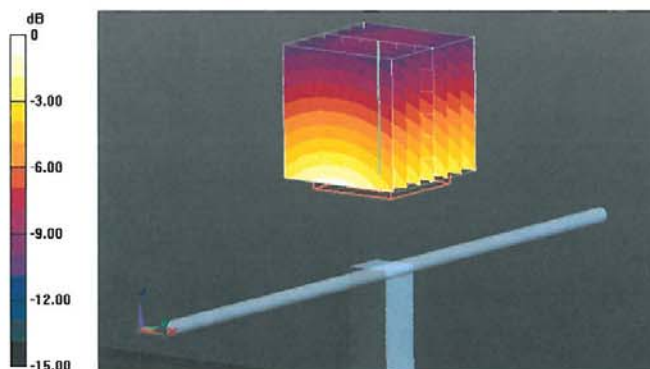

0 dB = 2.79 W/kg = 4.46 dBW/kg

Impedance Measurement Plot for Head TSL

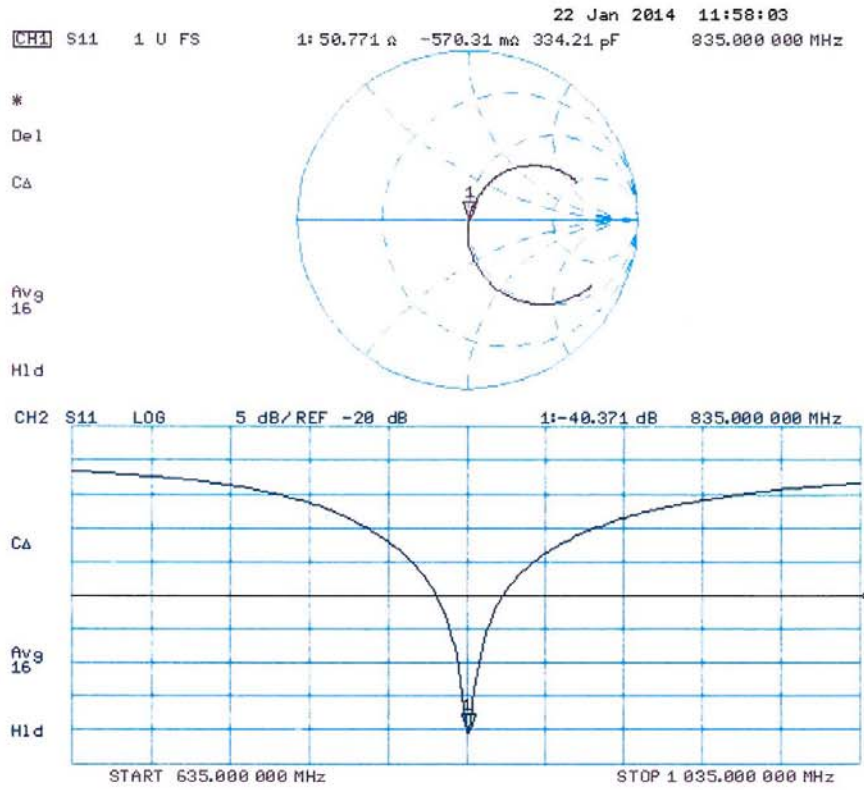

DASY5 Validation Report for Body TSL

Date: 20.01.2014

Test Laboratory: SPEAG, Zurich, Switzerland

DUT: Dipole 835 MHz; Type: D835V2; Serial: D835V2 - SN: 464

Communication System: UID 0 - CW; Frequency: 835 MHz

Medium parameters used: $f = 835$ MHz; $\sigma = 1.007$ S/m; $\epsilon_r = 53.6$; $\rho = 1000$ kg/m³

Phantom section: Flat Section

Measurement Standard: DASY5 (IEEE/IEC/ANSI C63.19-2007)

DASY52 Configuration:

- Probe: ES3DV3 - SN3205; ConvF(6.09, 6.09, 6.09); Calibrated: 30.12.2013;
- Sensor-Surface: 3mm (Mechanical Surface Detection)
- Electronics: DAE4 Sn601; Calibrated: 25.04.2013
- Phantom: Flat Phantom 4.9L; Type: QD000P49AA; Serial: 1001
- DASY52 52.8.7(1137); SEMCAD X 14.6.10(7164)

Dipole Calibration for Body Tissue/Pin=250 mW, d=15mm/Zoom Scan (7x7x7)/Cube 0:

Measurement grid: dx=5mm, dy=5mm, dz=5mm

Reference Value = 54.660 V/m; Power Drift = -0.04 dB

Peak SAR (extrapolated) = 3.61 W/kg

SAR(1 g) = 2.42 W/kg; SAR(10 g) = 1.57 W/kg

Maximum value of SAR (measured) = 2.80 W/kg

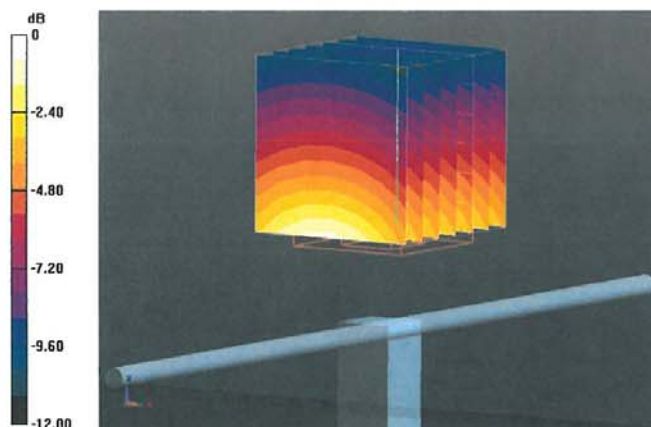

0 dB = 2.80 W/kg = 4.47 dBW/kg

Impedance Measurement Plot for Body TSL

