

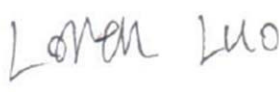

RF TEST REPORT

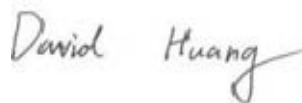

Report No.: 16071058-FCC-R4

Supersede Report No.: N/A

Applicant	Shenzhen Konka Telecommunications Technology Co.,Ltd.	
Product Name	Smart Phone	
Model No.	ADS1	
Serial No.	N/A	
Test Standard	FCC Part 15.247: 2015, ANSI C63.10: 2013	
Test Date	August 31 to September 26, 2016	
Issue Date	September 27, 2016	
Test Result	<input checked="" type="checkbox"/> Pass <input type="checkbox"/> Fail	
Equipment complied with the specification	<input checked="" type="checkbox"/>	
Equipment did not comply with the specification	<input type="checkbox"/>	
		
Loren Luo Test Engineer	David Huang Checked By	
This test report may be reproduced in full only Test result presented in this test report is applicable to the tested sample only		

Issued by:

SIEMIC (SHENZHEN-CHINA) LABORATORIES

Zone A, Floor 1, Building 2 Wan Ye Long Technology Park

South Side of Zhoushi Road, Bao' an District, Shenzhen, Guangdong China 518108

Phone: +86 0755 2601 4629801 Email: China@siemic.com.cn

Laboratories Introduction

SIEMIC, headquartered in the heart of Silicon Valley, with superior facilities in US and Asia, is one of the leading independent testing and certification facilities providing customers with one-stop shop services for Compliance Testing and Global Certifications.



In addition to testing and certification, SIEMIC provides initial design reviews and compliance management throughout a project. Our extensive experience with China, Asia Pacific, North America, European, and International compliance requirements, assures the fastest, most cost effective way to attain regulatory compliance for the global markets.

Accreditations for Conformity Assessment

Country/Region	Scope
USA	EMC, RF/Wireless, SAR, Telecom
Canada	EMC, RF/Wireless, SAR, Telecom
Taiwan	EMC, RF, Telecom, SAR, Safety
Hong Kong	RF/Wireless, SAR, Telecom
Australia	EMC, RF, Telecom, SAR, Safety
Korea	EMI, EMS, RF, SAR, Telecom, Safety
Japan	EMI, RF/Wireless, SAR, Telecom
Singapore	EMC, RF, SAR, Telecom
Europe	EMC, RF, SAR, Telecom, Safety

Test Report No.	16071058-FCC-R4
Page	3 of 41

This page has been left blank intentionally.

CONTENTS

1. REPORT REVISION HISTORY	5
2. CUSTOMER INFORMATION	5
3. TEST SITE INFORMATION.....	5
4. EQUIPMENT UNDER TEST (EUT) INFORMATION	6
5. TEST SUMMARY	8
6. MEASUREMENTS, EXAMINATION AND DERIVED RESULTS	9
6.1 ANTENNA REQUIREMENT.....	9
6.2 DTS (6 DB) CHANNEL BANDWIDTH	10
6.3 MAXIMUM OUTPUT POWER	12
6.4 POWER SPECTRAL DENSITY.....	14
6.5 BAND-EDGE & UNWANTED EMISSIONS INTO RESTRICTED FREQUENCY BANDS	16
6.6 AC POWER LINE CONDUCTED EMISSIONS.....	19
6.7 RADIATED SPURIOUS EMISSIONS & RESTRICTED BAND	25
ANNEX A. TEST INSTRUMENT.....	31
ANNEX B. EUT AND TEST SETUP PHOTOGRAPHS.....	32
ANNEX C. TEST SETUP AND SUPPORTING EQUIPMENT.....	37
ANNEX D. USER MANUAL / BLOCK DIAGRAM / SCHEMATICS / PARTLIST	41

1. Report Revision History

Report No.	Report Version	Description	Issue Date
16071058-FCC-R4	NONE	Original	September 27, 2016

2. Customer information

Applicant Name	Shenzhen Konka Telecommunications Technology Co.,Ltd.
Applicant Add	No.9008 Shennan Road,Overseas Chinese Town,ShenZhen,Guangdong,China
Manufacturer	Shenzhen Konka Telecommunications Technology Co.,Ltd.
Manufacturer Add	No.9008 Shennan Road,Overseas Chinese Town,ShenZhen,Guangdong,China

3. Test site information

Lab performing tests	SIEMIC (Shenzhen-China) LABORATORIES
Lab Address	Zone A, Floor 1, Building 2 Wan Ye Long Technology Park South Side of Zhoushi Road, Bao' an District, Shenzhen, Guangdong China 518108
FCC Test Site No.	718246
IC Test Site No.	4842E-1
Test Software	Radiated Emission Program-To Shenzhen v2.0

4. Equipment under Test (EUT) Information

Description of EUT:	Smart Phone
Main Model:	ADS1
Serial Model:	N/A
Date EUT received:	August 29, 2016
Test Date(s):	August 31 to September 26, 2016
Equipment Category :	DTS
Antenna Gain:	GSM850: -0.20dBi PCS1900: 0.52dBi UMTS-FDD Band V: -0.20dBi UMTS-FDD Band II: 0.52dBi LTE Band 4: 0.51dBi Bluetooth/BLE/WIFI: -0.87dBi GPS: -0.87dBi
Antenna Type:	PIFA antenna
Input Power:	Adapter: Model: HJ-0502000W2-AR Input: AC 100-240V~50/60Hz,0.3A Output: DC 5.0V,2A Battery: Model: KLB245P354 Normal Voltage: 3.8V,2450mAh Charging Of Voltage: DC 4.5V,9.31Wh
Max. Output Power:	-1.869dBm
Type of Modulation:	GSM / GPRS: GMSK EGPRS: GMSK,8PSK UMTS-FDD: QPSK LTE Band: QPSK, 16QAM

Test Report No.	16071058-FCC-R4
Page	7 of 41

802.11b/g/n: DSSS, OFDM
 Bluetooth: GFSK, π /4DQPSK, 8DPSK
 BLE: GFSK
 GPS:BPSK

GSM850 TX: 824.2 ~ 848.8 MHz; RX: 869.2 ~ 893.8 MHz
 PCS1900 TX: 1850.2 ~ 1909.8 MHz; RX: 1930.2 ~ 1989.8 MHz
 UMTS-FDD Band V TX: 826.4 ~ 846.6 MHz; RX: 871.4 ~ 891.6 MHz
 UMTS-FDD Band II TX:1852.4 ~ 1907.6 MHz;
 RX: 1932.4 ~ 1987.6 MHz

RF Operating Frequency (ies):
 LTE Band 4 TX: 1710.7 ~ 1754.3 MHz; RX : 2110.7 ~ 2154.3 MHz
 WIFI: 802.11b/g/n(20M): 2412-2462 MHz
 WIFI: 802.11n(40M): 2422-2452 MHz
 Bluetooth& BLE: 2402-2480 MHz
 GPS: 1575.42 MHz

Number of Channels:
 GSM 850: 124CH
 PCS1900: 299CH
 UMTS-FDD Band V: 102CH
 UMTS-FDD Band II: 277CH
 WIFI :802.11b/g/n(20M): 11CH
 WIFI :802.11n(40M): 7CH
 Bluetooth: 79CH
 BLE: 40CH
 GPS:1CH

Port: Earphone Port, USB Port

Trade Name : ADMIRAL

GPRS/EGPRS Multi-slot class: 8/10/12

FCC ID: UT3ADS1

5. Test Summary

The product was tested in accordance with the following specifications.

All testing has been performed according to below product classification:

FCC Rules	Description of Test	Result
§15.203	Antenna Requirement	Compliance
§15.247 (a)(2)	DTS (6 dB) CHANNEL BANDWIDTH	Compliance
§15.247(b)(3)	Conducted Maximum Output Power	Compliance
§15.247(e)	Power Spectral Density	Compliance
§15.247(d)	Band-Edge & Unwanted Emissions into Restricted Frequency Bands	Compliance
§15.207 (a),	AC Power Line Conducted Emissions	Compliance
§15.205, §15.209, §15.247(d)	Radiated Spurious Emissions & Unwanted Emissions into Restricted Frequency Bands	Compliance

Measurement Uncertainty

Emissions		
Test Item	Description	Uncertainty
Band Edge and Radiated Spurious Emissions	Confidence level of approximately 95% (in the case where distributions are normal), with a coverage factor of 2 (for EUTs < 0.5m X 0.5m X 0.5m)	+5.6dB/-4.5dB
-	-	-

6. Measurements, Examination And Derived Results

6.1 Antenna Requirement

Applicable Standard

According to § 15.203, an intentional radiator shall be designed to ensure that no antenna other than that furnished by the responsible party shall be used with the device. The use of a permanently attached antenna or of an antenna that uses a unique coupling to the intentional radiator shall be considered sufficient to comply with the provisions of this section. The manufacturer may design the unit so that a broken antenna can be replaced by the user, but the user of a standard antenna jack or electrical connector is prohibited. The structure and application of the EUT were analyzed to determine compliance with section §15.203 of the rules. §15.203 state that the subject device must meet the following criteria:

- a. Antenna must be permanently attached to the unit.
- b. Antenna must use a unique type of connector to attach to the EUT.

Unit must be professionally installed, and installer shall be responsible for verifying that the correct antenna is employed with the unit.

And according to FCC 47 CFR section 15.247 (b), if the transmitting antennas of directional gain greater than 6dBi are used, the power shall be reduced by the amount in dB that the directional gain of the antenna exceeds 6 dBi.

Antenna Connector Construction

A permanently attached PIFA antenna for Bluetooth/BLE/WIFI/GPS, the gain is 0dBi for Bluetooth/BLE/WIFI/ GPS.

A permanently attached PIFA antenna for GSM/PCS/UMTS, the gain is -0.20dBi for GSM850, 0.52dBi for PCS1900, -0.20dBi for UMTS-FDD Band V, 0.52dBi for UMTS-FDD Band II.

A permanently attached PIFA antenna for LTE Band 4, the gain is 0.51dBi for LTE Band 4.

The antenna meets up with the ANTENNA REQUIREMENT.

Result: Compliance.

6.2 DTS (6 dB) Channel Bandwidth

Temperature	23°C
Relative Humidity	51%
Atmospheric Pressure	1018mbar
Test date :	September 18, 2016
Tested By :	Loren Luo

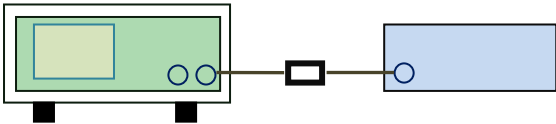
Spec	Item	Requirement	Applicable
§ 15.247(a)(2)	a)	6dB BW ≥ 500kHz;	<input checked="" type="checkbox"/>
RSS Gen(4.6.1)	b)	99% BW: For FCC reference only; required by IC.	<input checked="" type="checkbox"/>
Test Setup	 <p style="text-align: center;">Spectrum Analyzer EUT</p>		
Test Procedure	<p>558074 D01 DTS MEAS Guidance v03r03, 8.1 DTS bandwidth <u>6dB Emission bandwidth measurement procedure</u></p> <ul style="list-style-type: none"> - Set RBW = 100 kHz. - Set the video bandwidth (VBW) ≥ 3 RBW. - Detector = Peak. - Trace mode = max hold. - Sweep = auto couple. - Allow the trace to stabilize. <p>Measure the maximum width of the emission that is constrained by the frequencies associated with the two outermost amplitude points (upper and lower frequencies) that are attenuated by 6 dB relative to the maximum level measured in the fundamental emission.</p>		
Remark			
Result	<input checked="" type="checkbox"/> Pass <input type="checkbox"/> Fail		

Test Data Yes N/A

Test Plot Yes (See below) N/A

6dB Bandwidth measurement result

Test Data

CH	Frequency (MHz)	6dB Bandwidth (kHz)	99% Occupied Bandwidth (MHz)
Low	2402	734.343	1.0382
Mid	2440	737.298	1.0364
High	2480	738.751	1.0408

Test Plots

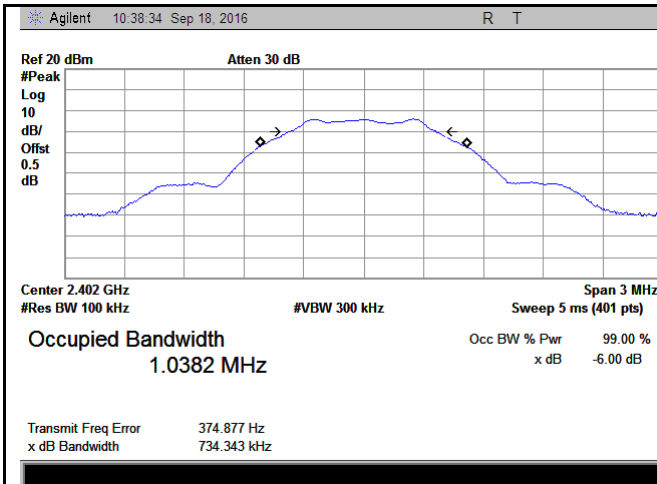

6dB Bandwidth - Low CH 2402

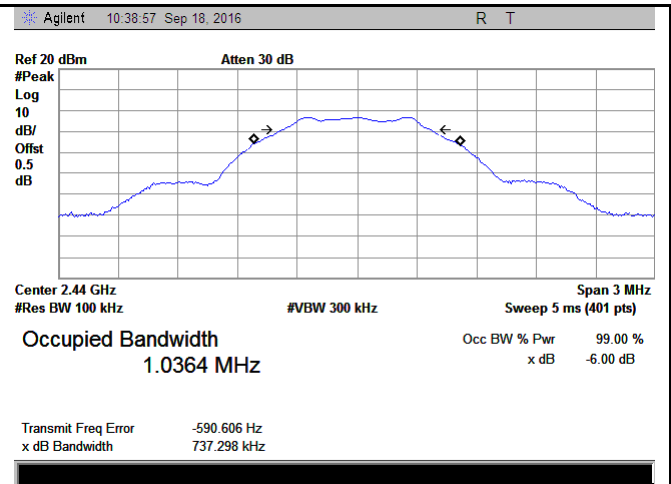

6dB Bandwidth - Mid CH 2440

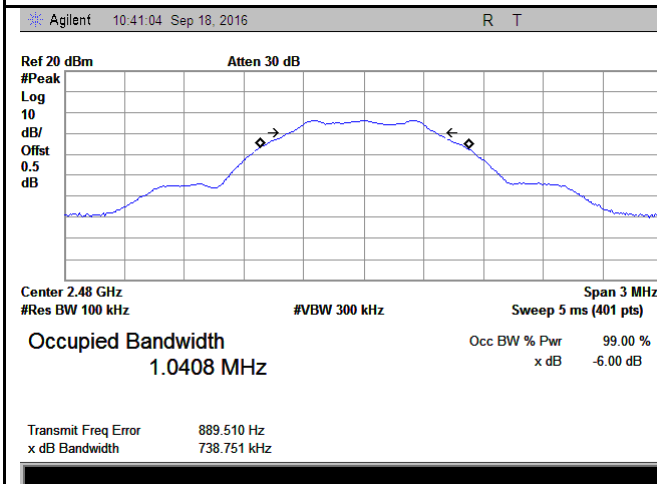

6dB Bandwidth - High CH 2480

6.3 Maximum Output Power

Temperature	23°C
Relative Humidity	51%
Atmospheric Pressure	1018mbar
Test date :	September 18, 2016
Tested By :	Loren Luo

Requirement(s):

Spec	Item	Requirement	Applicable
§15.247(b) (3),RSS210 (A8.4)	a)	FHSS in 2400-2483.5MHz with ≥ 75 channels: ≤ 1 Watt	<input type="checkbox"/>
	b)	FHSS in 5725-5850MHz: ≤ 1 Watt	<input type="checkbox"/>
	c)	For all other FHSS in the 2400-2483.5MHz band: ≤ 0.125 Watt.	<input type="checkbox"/>
	d)	FHSS in 902-928MHz with ≥ 50 channels: ≤ 1 Watt	<input type="checkbox"/>
	e)	FHSS in 902-928MHz with ≥ 25 & <50 channels: ≤ 0.25 Watt	<input type="checkbox"/>
	f)	DTS in 902-928MHz, 2400-2483.5MHz: ≤ 1 Watt	<input checked="" type="checkbox"/>

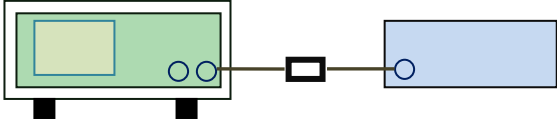
Test Setup	 <p style="text-align: center;">Spectrum Analyzer EUT</p>
------------	--

Test Procedure	<p>558074 D01 DTS MEAS Guidance v03r03, 9.1.2 Integrated band power method Maximum output power measurement procedure</p> <p>a) Set the RBW \geq DTS bandwidth. b) Set VBW $\geq 3 \times$ RBW. c) Set span $\geq 3 \times$ RBW d) Sweep time = auto couple. e) Detector = peak. f) Trace mode = max hold. g) Allow trace to fully stabilize. h) Use peak marker function to determine the peak amplitude level.</p>
----------------	---

Remark	
Result	<input checked="" type="checkbox"/> Pass <input type="checkbox"/> Fail

Test Data Yes N/A
 Test Plot Yes (See below) N/A

Output Power measurement result

Test Data

Type	CH	Frequency (MHz)	Conducted Power (dBm)	Limit (dBm)	Result
Output power	Low	2402	-2.986	30	Pass
	Mid	2440	-1.869	30	Pass
	High	2480	-2.821	30	Pass

Test Plots

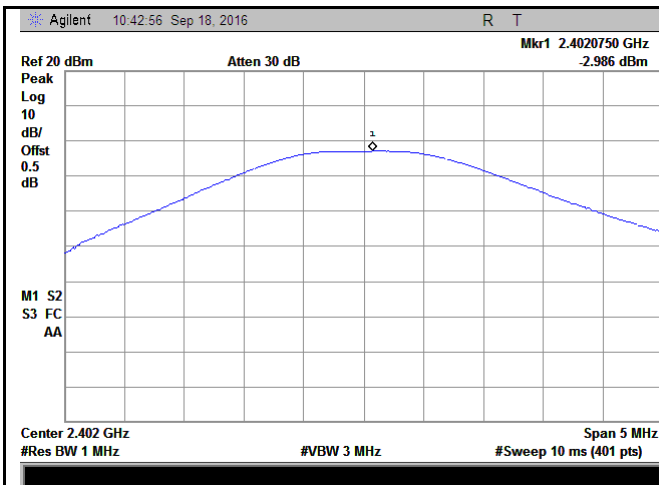

AV Output power - Low CH 2402

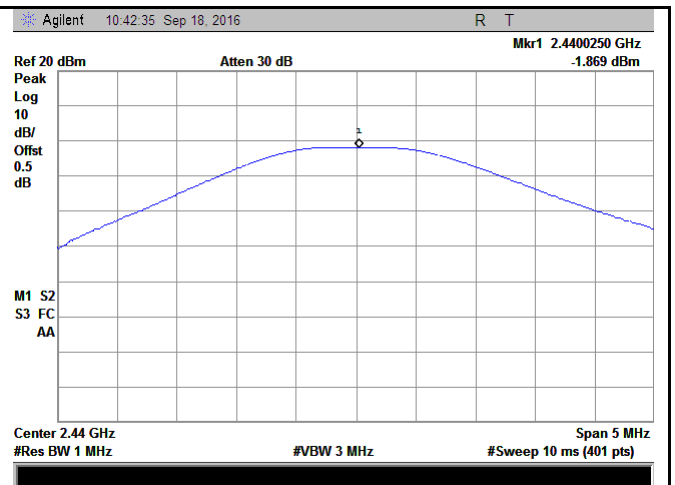

AV Output power - Mid CH 2440

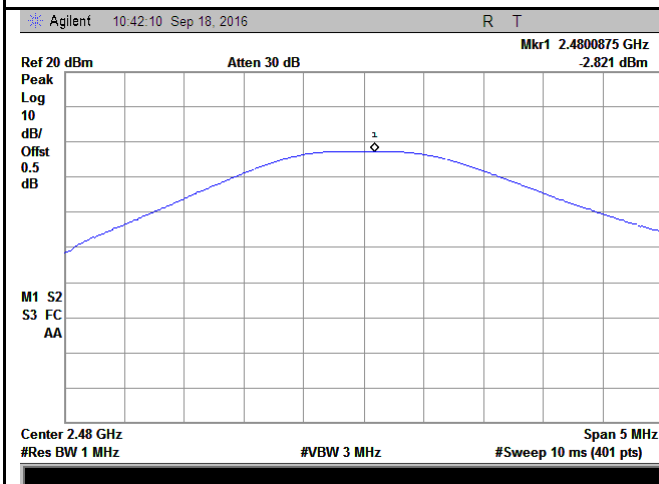

AV Output power - High CH 2480

6.4 Power Spectral Density

Temperature	23°C
Relative Humidity	51%
Atmospheric Pressure	1018mbar
Test date :	September 18, 2016
Tested By :	Loren Luo

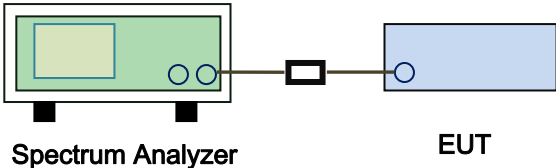
Spec	Item	Requirement	Applicable
§15.247(e)	a)	The power spectral density conducted from the intentional radiator to the antenna shall not be greater than 8 dBm in any 3 kHz band during any time interval of continuous transmission.	<input checked="" type="checkbox"/>
Test Setup	 <p style="text-align: center;">Spectrum Analyzer EUT</p>		
Test Procedure	<p>558074 D01 DTS MEAS Guidance v03r03, 10.2 power spectral density method power spectral density measurement procedure</p> <ul style="list-style-type: none"> - a) Set analyzer center frequency to DTS channel center frequency. - b) Set the span to 1.5 times the DTS bandwidth. - c) Set the RBW to: 3 kHz ≤ RBW ≤ 100 kHz. - d) Set the VBW ≥ 3 × RBW. - e) Detector = peak. - f) Sweep time = auto couple. - g) Trace mode = max hold. - h) Allow trace to fully stabilize. - i) Use the peak marker function to determine the maximum amplitude level within the RBW. - j) If measured value exceeds limit, reduce RBW (no less than 3 kHz) and repeat. 		
Remark			
Result	<input checked="" type="checkbox"/> Pass <input type="checkbox"/> Fail		

Test Data Yes N/A
 Test Plot Yes (See below) N/A

Power Spectral Density measurement result

Test Data

Type	CH	Freq (MHz)	Reading (dBm)	Factor (dB)	Result (dBm)	Limit (dBm)	Result
PSD	Low	2402	-12.31	-5.23	-17.54	8	Pass
	Mid	2440	-11.23	-5.23	-16.46	8	Pass
	High	2480	-12.1	-5.23	-17.33	8	Pass

Note: factor=10log(3/10)=-5.23

Test Plots

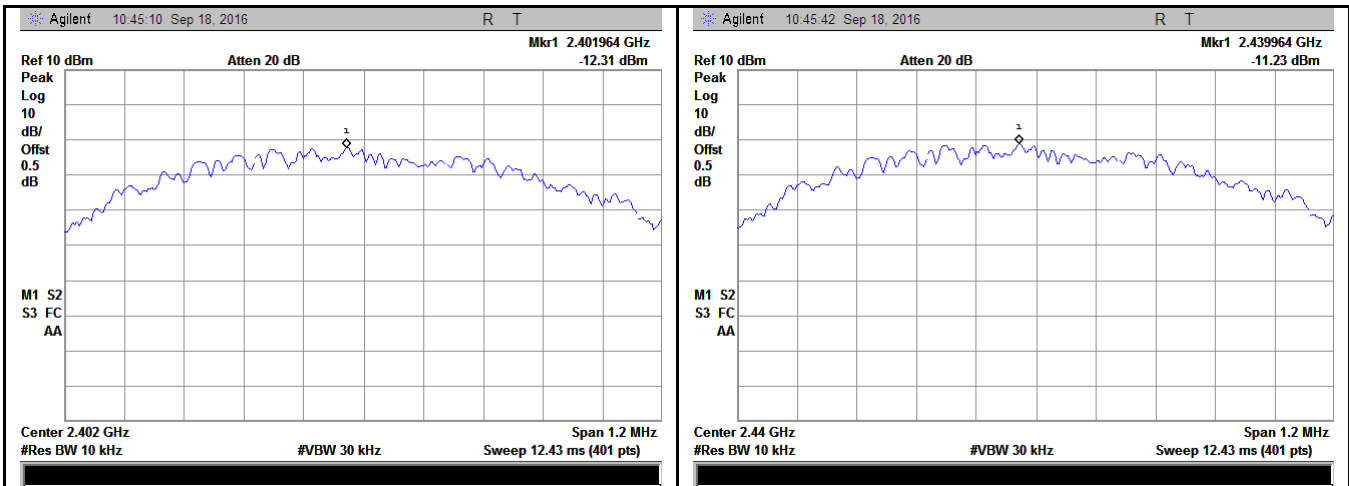

PSD - Low CH 2402

PSD - Mid CH 2440

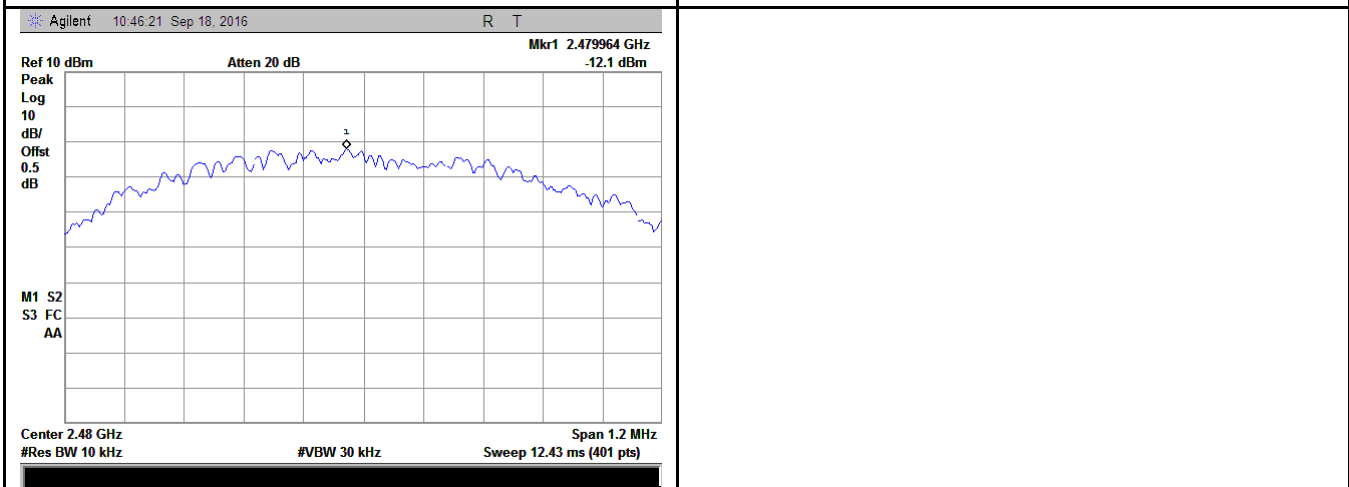

PSD - High CH 2480

6.5 Band-Edge & Unwanted Emissions into Restricted Frequency Bands

Temperature	22°C
Relative Humidity	55%
Atmospheric Pressure	1013mbar
Test date :	September 13, 2016
Tested By :	Loren Luo

Requirement(s):

Spec	Item	Requirement	Applicable
§15.247(d)	a)	In any 100 kHz bandwidth outside the frequency band in which the spread spectrum or digitally modulated intentional radiator is operating, the radio frequency power that is produced by the intentional radiator shall be at least 20 dB below that in the 100 kHz bandwidth within the band that contains the highest level of the desired power, based on either an RF conducted or a radiated measurement, provided the transmitter demonstrates compliance with the peak conducted power limits.	<input checked="" type="checkbox"/>

Test Setup	
------------	--

Test Procedure	<p>Radiated Method Only</p> <ul style="list-style-type: none"> - 1. Check the calibration of the measuring instrument using either an internal calibrator or a known signal from an external generator. - 2. Position the EUT without connection to measurement instrument. Put it on the Rotated table and turn on the EUT and make it operate in transmitting mode. Then set it to Low Channel and High Channel within its operating range, and make sure the instrument is operated in its linear range.
----------------	---

Test Report No.	16071058-FCC-R4
Page	17 of 41

	<ul style="list-style-type: none"> - 3. First, set both RBW and VBW of spectrum analyzer to 100 kHz with a convenient frequency span including 100kHz bandwidth from band edge, check the emission of EUT, if pass then set Spectrum Analyzer as below: <ul style="list-style-type: none"> a. The resolution bandwidth and video bandwidth of test receiver/spectrum analyzer is 120 kHz for Quasiy Peak detection at frequency below 1GHz. b. The resolution bandwidth of test receiver/spectrum analyzer is 1MHz and video bandwidth is 3MHz with Peak detection for Peak measurement at frequency above 1GHz. c. The resolution bandwidth of test receiver/spectrum analyzer is 1MHz and the video bandwidth is 10Hz with Peak detection for Average Measurement as below at frequency above 1GHz. - 4. Measure the highest amplitude appearing on spectral display and set it as a reference level. Plot the graph with marking the highest point and edge frequency. - 5. Repeat above procedures until all measured frequencies were complete.
Remark	
Result	<input checked="" type="checkbox"/> Pass <input type="checkbox"/> Fail

Test Data Yes N/A
 Test Plot Yes (See below) N/A

Test Plots

Band Edge measurement result

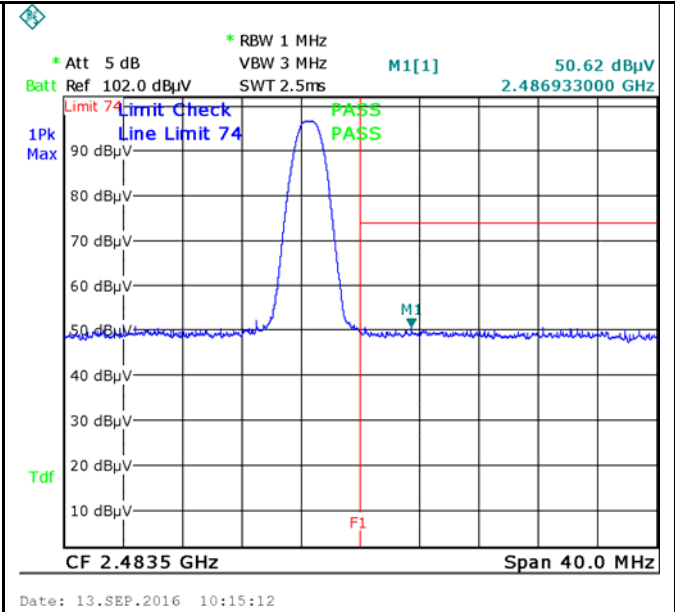
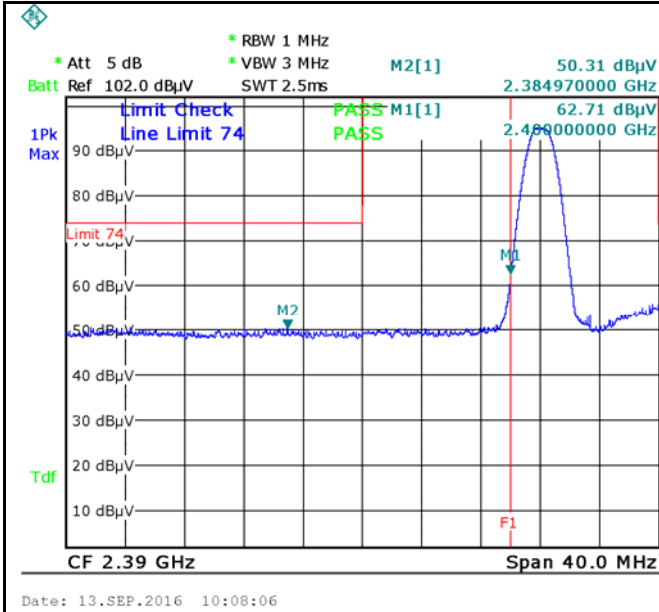

Band Edge, Left Side (Peak)

Note: F1 is frequency 2390MHz; F2 is frequency 2400MHz

Band Edge, Right Side (Peak)

Note: F1 is frequency 2483.5MHz

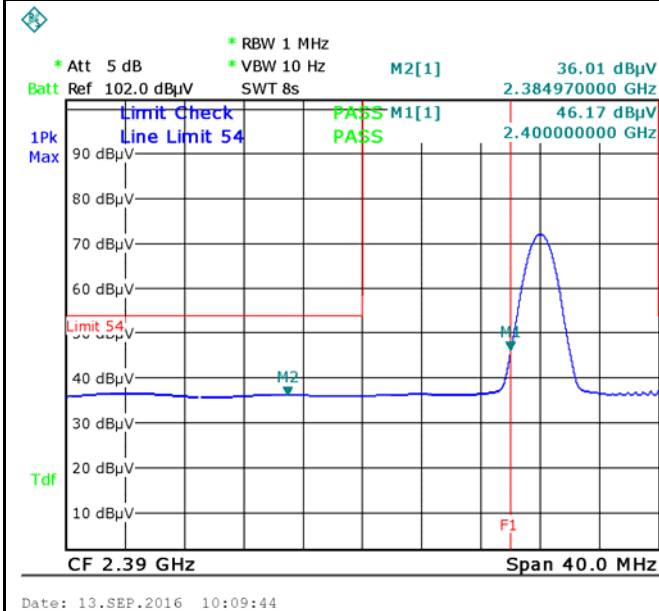

Note: (no need if PK value less than the AV limit)

Band Edge, Left Side-AV

Band Edge, Right Side-AV

6.6 AC Power Line Conducted Emissions

Temperature	23°C
Relative Humidity	55%
Atmospheric Pressure	1031mbar
Test date :	August 31, 2016
Tested By :	Loren Luo

Requirement(s):

Spec	Item	Requirement	Applicable														
47CFR§15.207, RSS210 (A8.1)	a)	For Low-power radio-frequency devices that is designed to be connected to the public utility (AC) power line, the radio frequency voltage that is conducted back onto the AC power line on any frequency or frequencies, within the band 150 kHz to 30 MHz, shall not exceed the limits in the following table, as measured using a 50 [μ] H/50 ohms line impedance stabilization network (LISN). The lower limit applies at the boundary between the frequencies ranges.	<input checked="" type="checkbox"/>														
		<table border="1"> <thead> <tr> <th rowspan="2">Frequency ranges (MHz)</th> <th colspan="2">Limit (dBμV)</th> </tr> <tr> <th>QP</th> <th>Average</th> </tr> </thead> <tbody> <tr> <td>0.15 ~ 0.5</td> <td>66 – 56</td> <td>56 – 46</td> </tr> <tr> <td>0.5 ~ 5</td> <td>56</td> <td>46</td> </tr> <tr> <td>5 ~ 30</td> <td>60</td> <td>50</td> </tr> </tbody> </table>		Frequency ranges (MHz)	Limit (dBμV)		QP	Average	0.15 ~ 0.5	66 – 56	56 – 46	0.5 ~ 5	56	46	5 ~ 30	60	50
		Frequency ranges (MHz)			Limit (dBμV)												
				QP	Average												
0.15 ~ 0.5	66 – 56	56 – 46															
0.5 ~ 5	56	46															
5 ~ 30	60	50															

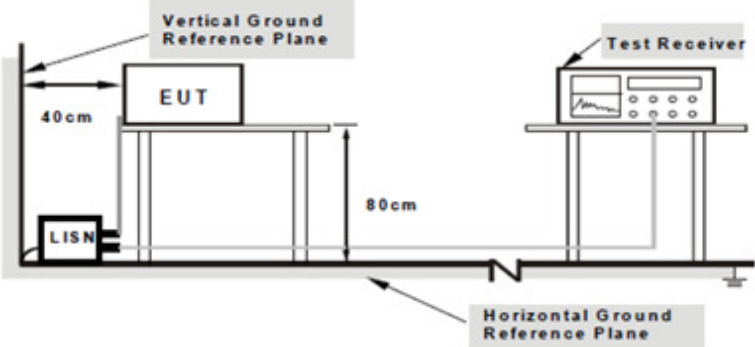
Test Setup	 <p>Note: 1. Support units were connected to second LISN. 2. Both of LISNs (AMN) are 80cm from EUT and at least 80cm from other units and other metal planes support units.</p>
------------	---

Procedure	<ol style="list-style-type: none"> The EUT and supporting equipment were set up in accordance with the requirements of the standard on top of a 1.5m x 1m x 0.8m high, non-metallic table. The power supply for the EUT was fed through a 50W/50mH EUT LISN, connected to filtered mains. The RF OUT of the EUT LISN was connected to the EMI test receiver via a low-loss
-----------	---

Test Report No.	16071058-FCC-R4
Page	20 of 41

	<p>coaxial cable.</p> <ol style="list-style-type: none"> 4. All other supporting equipment were powered separately from another main supply. 5. The EUT was switched on and allowed to warm up to its normal operating condition. 6. A scan was made on the NEUTRAL line (for AC mains) or Earth line (for DC power) over the required frequency range using an EMI test receiver. 7. High peaks, relative to the limit line, The EMI test receiver was then tuned to the selected frequencies and the necessary measurements made with a receiver bandwidth setting of 10 kHz. 8. Step 7 was then repeated for the LIVE line (for AC mains) or DC line (for DC power).
Remark	
Result	<input checked="" type="checkbox"/> Pass <input type="checkbox"/> Fail

Test Data Yes N/A

Test Plot Yes (See below) N/A

Test Mode: Transmitting Mode

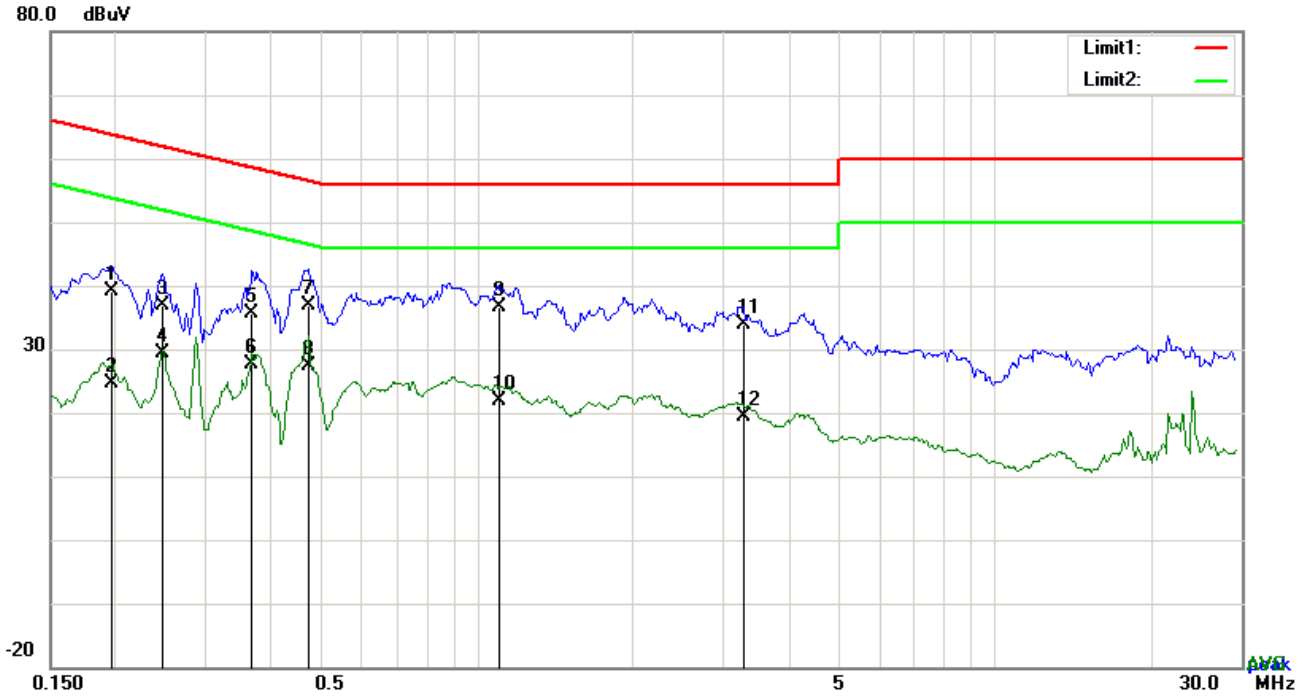

Test Data

Phase Line Plot at 120Vac, 60Hz

No.	P/L	Frequency (MHz)	Reading (dBµV)	Detector	Corrected (dB)	Result (dBµV)	Limit (dBµV)	Margin (dB)
1	L1	0.1968	29.04	QP	10.03	39.07	63.74	-24.67
2	L1	0.1968	14.66	AVG	10.03	24.69	53.74	-29.05
3	L1	0.2475	26.81	QP	10.03	36.84	61.84	-25.00
4	L1	0.2475	19.23	AVG	10.03	29.26	51.84	-22.58
5	L1	0.3684	25.50	QP	10.03	35.53	58.54	-23.01
6	L1	0.3684	17.58	AVG	10.03	27.61	48.54	-20.93
7	L1	0.4737	26.89	QP	10.03	36.92	56.45	-19.53
8	L1	0.4737	17.39	AVG	10.03	27.42	46.45	-19.03
9	L1	1.1016	26.55	QP	10.03	36.58	56.00	-19.42
10	L1	1.1016	11.85	AVG	10.03	21.88	46.00	-24.12
11	L1	3.2769	23.91	QP	10.06	33.97	56.00	-22.03
12	L1	3.2769	9.34	AVG	10.06	19.40	46.00	-26.60

Test Mode:	Transmitting Mode
-------------------	--------------------------

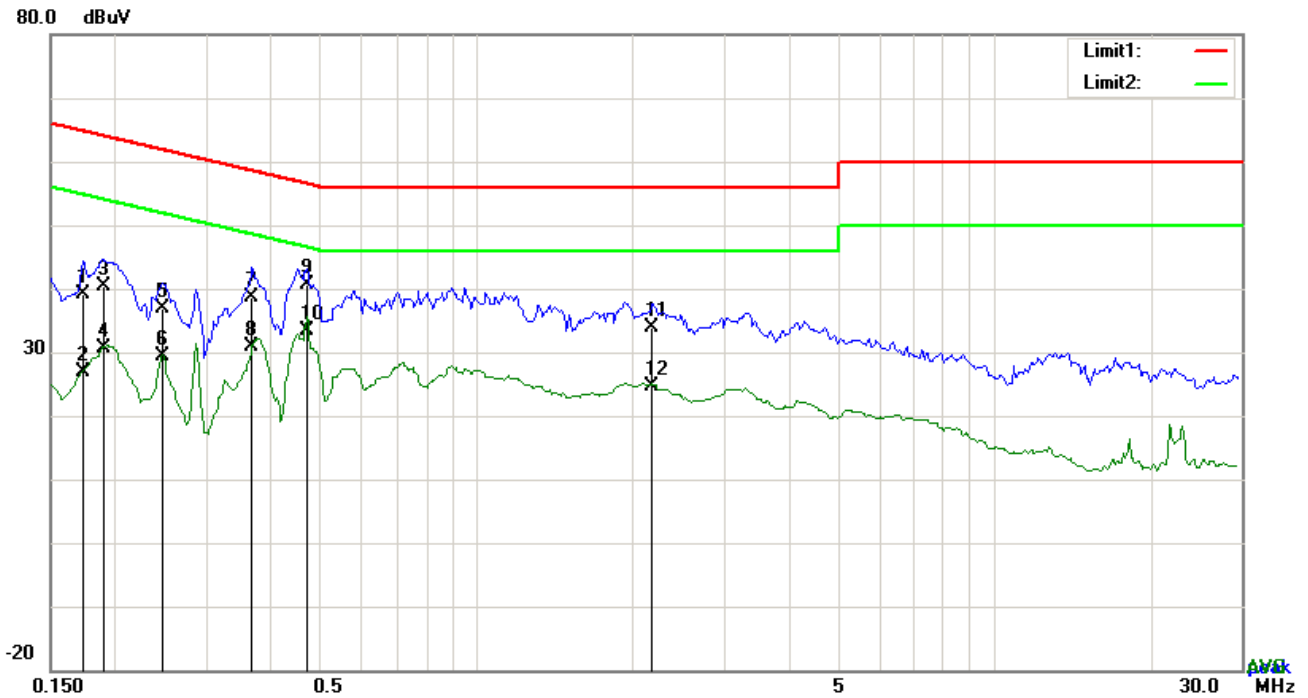

Test Data

Phase Neutral Plot at 120Vac, 60Hz

No.	P/L	Frequency (MHz)	Reading (dBμV)	Detector	Corrected (dB)	Result (dBμV)	Limit (dBμV)	Margin (dB)
1	N	0.1734	29.20	QP	10.02	39.22	64.80	-25.58
2	N	0.1734	16.96	AVG	10.02	26.98	54.80	-27.82
3	N	0.1904	30.47	QP	10.02	40.49	64.02	-23.53
4	N	0.1904	20.51	AVG	10.02	30.53	54.02	-23.49
5	N	0.2475	26.96	QP	10.02	36.98	61.84	-24.86
6	N	0.2475	19.40	AVG	10.02	29.42	51.84	-22.42
7	N	0.3684	28.62	QP	10.02	38.64	58.54	-19.90
8	N	0.3684	20.87	AVG	10.02	30.89	48.54	-17.65
9	N	0.4698	30.57	QP	10.02	40.59	56.52	-15.93
10	N	0.4698	23.48	AVG	10.02	33.50	46.52	-13.02
11	N	2.1858	23.95	QP	10.04	33.99	56.00	-22.01
12	N	2.1858	14.60	AVG	10.04	24.64	46.00	-21.36

Test Mode: Transmitting Mode

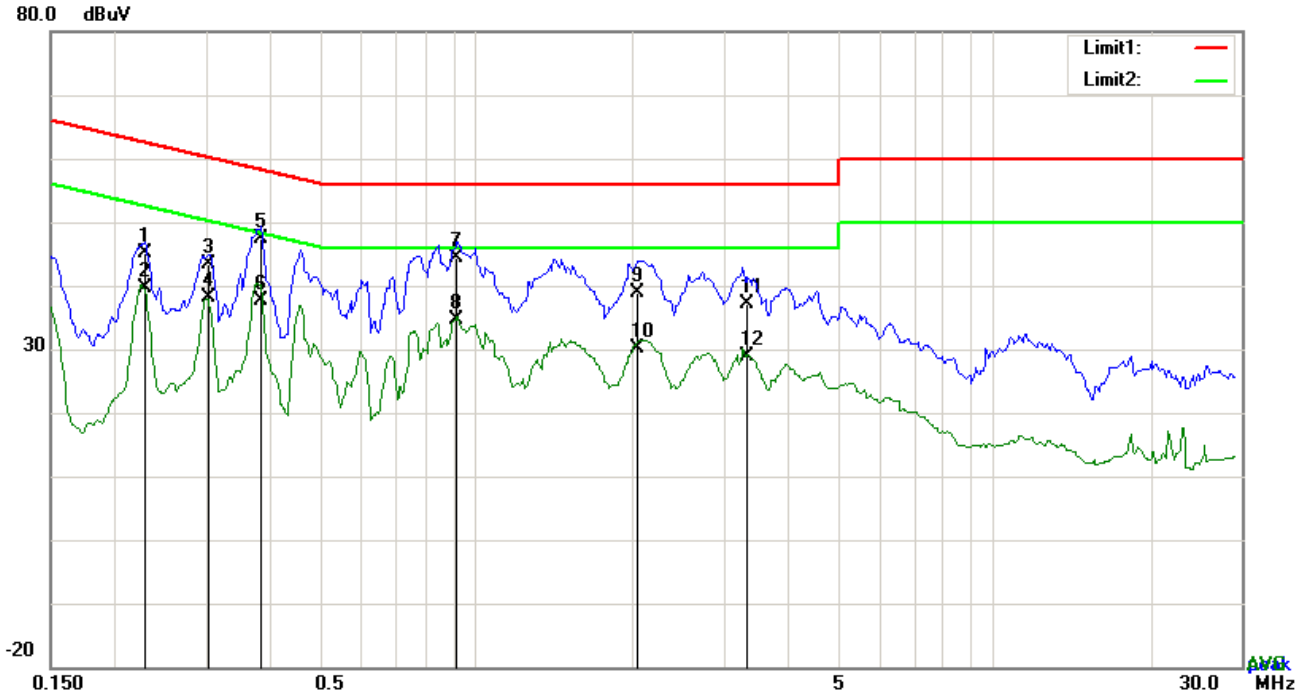

Test Data

Phase Line Plot at 240Vac, 60Hz

No.	P/L	Frequency (MHz)	Reading (dBµV)	Detector	Corrected (dB)	Result (dBµV)	Limit (dBµV)	Margin (dB)
1	L1	0.2280	35.11	QP	10.03	45.14	62.52	-17.38
2	L1	0.2280	29.65	AVG	10.03	39.68	52.52	-12.84
3	L1	0.3021	33.44	QP	10.03	43.47	60.18	-16.71
4	L1	0.3021	28.00	AVG	10.03	38.03	50.18	-12.15
5	L1	0.3840	37.32	QP	10.03	47.35	58.19	-10.84
6	L1	0.3840	27.64	AVG	10.03	37.67	48.19	-10.52
7	L1	0.9183	34.26	QP	10.03	44.29	56.00	-11.71
8	L1	0.9183	24.52	AVG	10.03	34.55	46.00	-11.45
9	L1	2.0337	28.95	QP	10.04	38.99	56.00	-17.01
10	L1	2.0337	20.01	AVG	10.04	30.05	46.00	-15.95
11	L1	3.3432	26.95	QP	10.06	37.01	56.00	-18.99
12	L1	3.3432	18.83	AVG	10.06	28.89	46.00	-17.11

Test Mode:	Transmitting Mode
-------------------	--------------------------

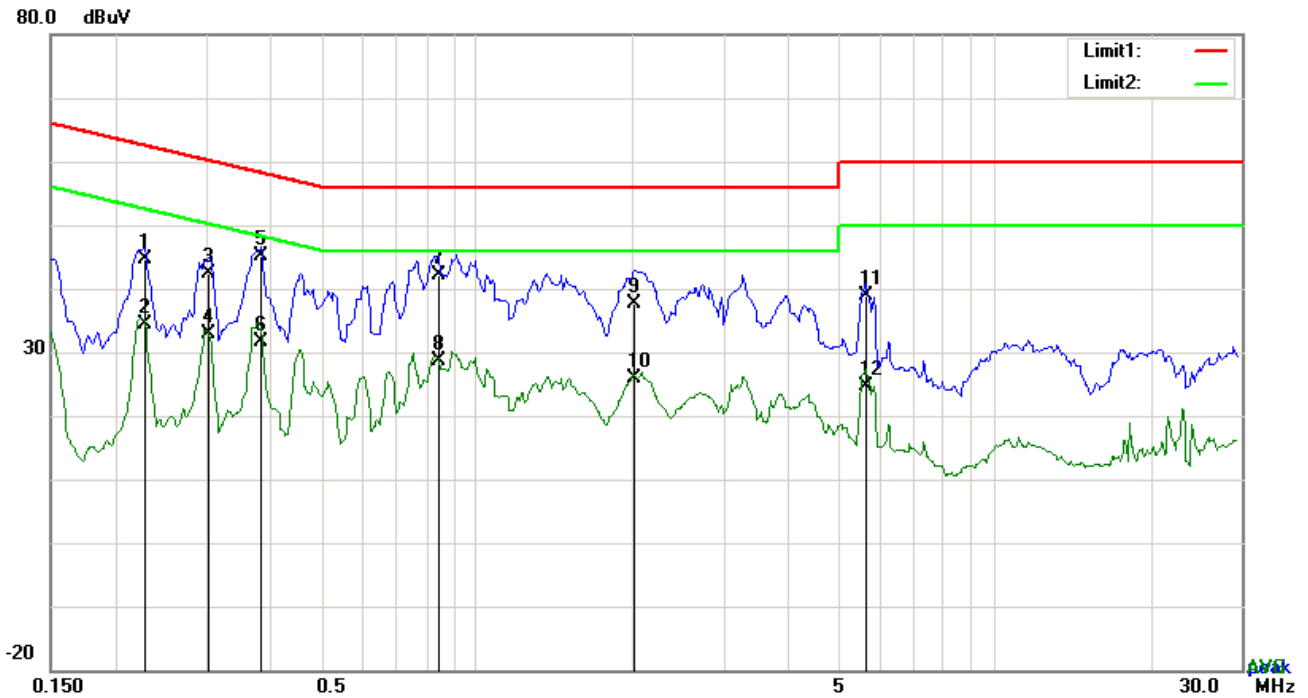

Test Data

Phase Neutral Plot at 240Vac, 60Hz

No.	P/L	Frequency (MHz)	Reading (dBμV)	Detector	Corrected (dB)	Result (dBμV)	Limit (dBμV)	Margin (dB)
1	N	0.2280	34.66	QP	10.02	44.68	62.52	-17.84
2	N	0.2280	24.34	AVG	10.02	34.36	52.52	-18.16
3	N	0.3021	32.25	QP	10.02	42.27	60.18	-17.91
4	N	0.3021	22.75	AVG	10.02	32.77	50.18	-17.41
5	N	0.3840	35.01	QP	10.02	45.03	58.19	-13.16
6	N	0.3840	21.56	AVG	10.02	31.58	48.19	-16.61
7	N	0.8442	32.00	QP	10.03	42.03	56.00	-13.97
8	N	0.8442	18.72	AVG	10.03	28.75	46.00	-17.25
9	N	2.0142	27.60	QP	10.04	37.64	56.00	-18.36
10	N	2.0142	15.96	AVG	10.04	26.00	46.00	-20.00
11	N	5.6247	28.75	QP	10.08	38.83	60.00	-21.17
12	N	5.6247	14.53	AVG	10.08	24.61	50.00	-25.39

6.7 Radiated Spurious Emissions & Restricted Band

Temperature	23°C
Relative Humidity	55%
Atmospheric Pressure	1031mbar
Test date :	August 31, 2016
Tested By :	Loren Luo

Requirement(s):

Spec	Item	Requirement	Applicable										
47CFR§15.247(d), RSS210 (A8.5)	a)	<p>Except higher limit as specified elsewhere in other section, the emissions from the low-power radio-frequency devices shall not exceed the field strength levels specified in the following table and the level of any unwanted emissions shall not exceed the level of the fundamental emission. The tighter limit applies at the band edges</p> <table border="1"> <thead> <tr> <th>Frequency range (MHz)</th> <th>Field Strength (µV/m)</th> </tr> </thead> <tbody> <tr> <td>30 – 88</td> <td>100</td> </tr> <tr> <td>88 – 216</td> <td>150</td> </tr> <tr> <td>216 960</td> <td>200</td> </tr> <tr> <td>Above 960</td> <td>500</td> </tr> </tbody> </table>	Frequency range (MHz)	Field Strength (µV/m)	30 – 88	100	88 – 216	150	216 960	200	Above 960	500	<input checked="" type="checkbox"/>
	Frequency range (MHz)	Field Strength (µV/m)											
	30 – 88	100											
88 – 216	150												
216 960	200												
Above 960	500												
b)	<p>For non-restricted band, In any 100 kHz bandwidth outside the frequency band in which the spread spectrum or digitally modulated intentional radiator is operating, the radio frequency power that is produced by the intentional radiator shall be at least 20 dB or 30dB below that in the 100 kHz bandwidth within the band that contains the highest level of the desired power, determined by the measurement method on output power to be used. Attenuation below the general limits specified in § 15.209(a) is not required</p> <p><input checked="" type="checkbox"/> 20 dB down <input type="checkbox"/> 30 dB down</p>	<input checked="" type="checkbox"/>											
c)	<p>or restricted band, emission must also comply with the radiated emission limits specified in 15.209</p>	<input checked="" type="checkbox"/>											

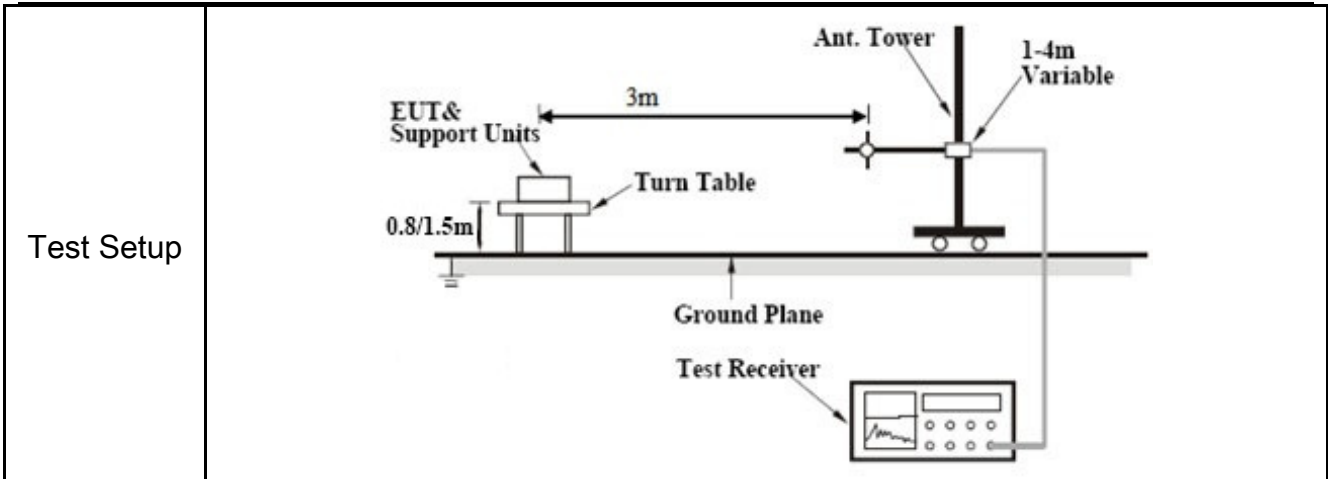

- Procedure**
1. The EUT was switched on and allowed to warm up to its normal operating condition.
 2. The test was carried out at the selected frequency points obtained from the EUT characterization. Maximization of the emissions, was carried out by rotating the EUT, changing the antenna polarization, and adjusting the antenna height in the following manner:
 - a. Vertical or horizontal polarization (whichever gave the higher emission level over a full rotation of the EUT) was chosen.
 - b. The EUT was then rotated to the direction that gave the maximum emission.
 - c. Finally, the antenna height was adjusted to the height that gave the maximum emission.
 3. The resolution bandwidth and video bandwidth of test receiver/spectrum analyzer is 120 kHz for Quasiy Peak detection at frequency below 1GHz.
 4. The resolution bandwidth of test receiver/spectrum analyzer is 1MHz and video bandwidth is 3MHz with Peak detection for Peak measurement at frequency above 1GHz.
 The resolution bandwidth of test receiver/spectrum analyzer is 1MHz and the video bandwidth is 10Hz with Peak detection for Average Measurement as below at frequency above 1GHz.
 5. Steps 2 and 3 were repeated for the next frequency point, until all selected frequency points were measured.

Remark Different RF configuration has been evaluated but not much difference was found. The data presented here is the worst case data with EUT under 802.11n – HT20-2437MHz mode.

Result Pass Fail

Test Data Yes N/A

Test Plot Yes (See below) N/A

Test Mode:	Transmitting Mode
-------------------	--------------------------

Below 1GHz

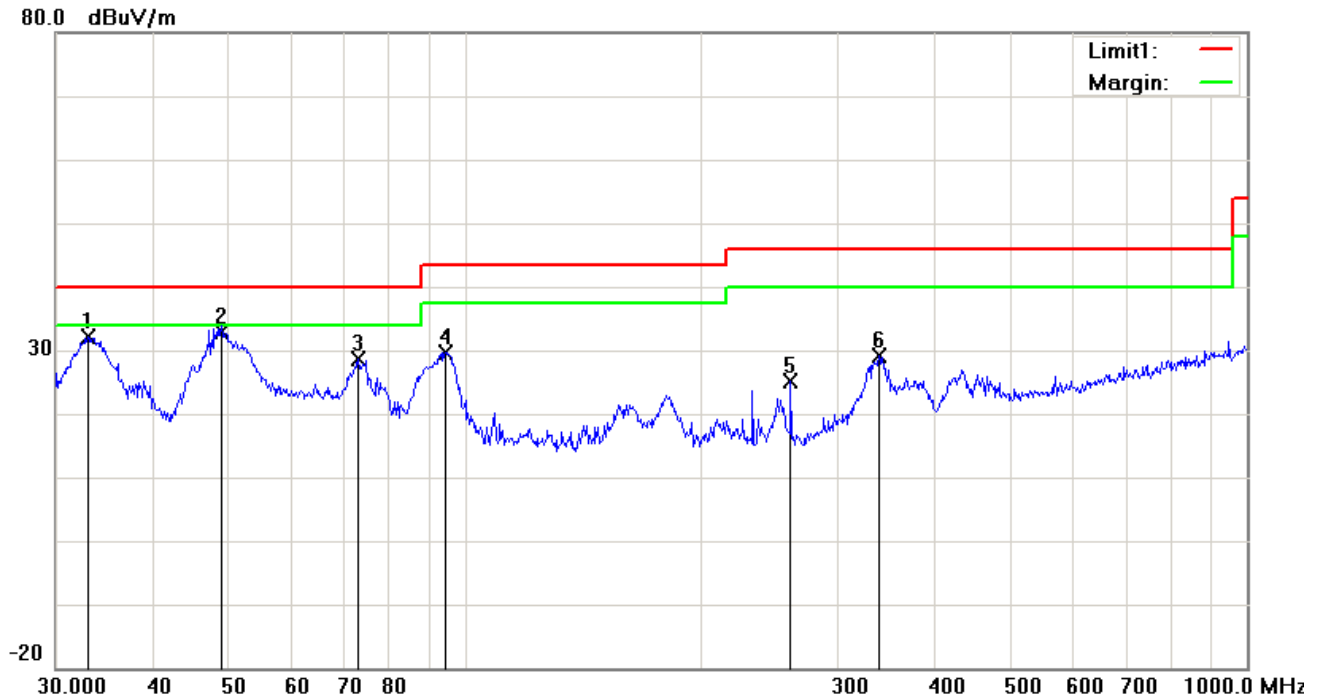

Test Data

Vertical Polarity Plot @3m

No	P/L	Frequency (MHz)	Reading (dBμV)	Detector	Corrected (dB)	Result (dBμV)	Limit (dBμV)	Margin (dB)	Height	Degree
1	V	32.9791	34.52	peak	-2.45	32.07	40.00	-7.93	100	231
2	V	48.8429	45.57	QP	-12.66	32.91	40.00	-7.09	100	256
3	V	73.1025	42.20	peak	-13.68	28.52	40.00	-11.48	100	360
4	V	94.4284	41.93	peak	-12.27	29.66	43.50	-13.84	100	198
5	V	261.0583	33.92	peak	-8.68	25.24	46.00	-20.76	100	56
6	V	338.4001	34.94	peak	-5.79	29.15	46.00	-16.85	100	278

Below 1GHz

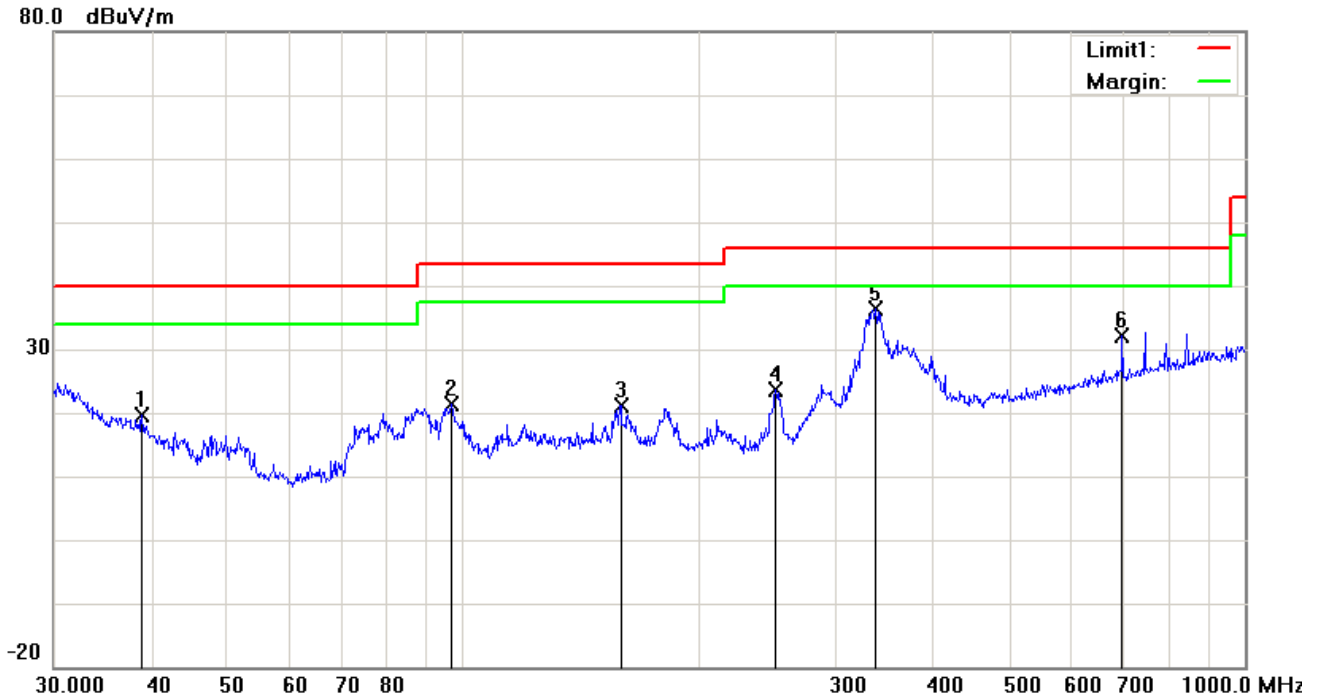

Test Data

Horizontal Polarity Plot @3m

No	P/L	Frequency (MHz)	Reading (dBμV)	Detector	Corrected (dB)	Result (dBμV)	Limit (dBμV)	Margin (dB)	Height	Degree
1	H	38.8879	26.48	peak	-6.78	19.70	40.00	-20.30	100	148
2	H	96.7749	33.00	peak	-11.65	21.35	43.50	-22.15	100	79
3	H	159.2251	29.46	peak	-8.29	21.17	43.50	-22.33	100	21
4	H	251.1804	32.66	peak	-9.14	23.52	46.00	-22.48	100	65
5	H	337.2155	42.10	peak	-5.83	36.27	46.00	-9.73	100	49
6	H	696.8567	30.70	peak	1.35	32.05	46.00	-13.95	100	103

Above 1GHz

Test Mode:	Transmitting Mode
-------------------	--------------------------

Low Channel (2402 MHz)

Frequency (MHz)	S.A. Reading (dB μ V)	Detector (PK/AV)	Polarity (H/V)	Ant. Factor (dB/m)	Cable Loss (dB)	Pre-Amp. Gain (dB)	Cord. Amp. (dB μ V/m)	Limit (dB μ V/m)	Margin (dB)
4804	38.62	AV	V	33.83	6.86	31.72	47.59	54	-6.41
4804	38.33	AV	H	33.83	6.86	31.72	47.3	54	-6.7
4804	48.17	PK	V	33.83	6.86	31.72	57.14	74	-16.86
4804	47.85	PK	H	33.83	6.86	31.72	56.82	74	-17.18
17782	24.61	AV	V	45.03	11.21	32.38	48.47	54	-5.53
17782	24.13	AV	H	45.03	11.21	32.38	47.99	54	-6.01
17782	41.02	PK	V	45.03	11.21	32.38	64.88	74	-9.12
17782	40.73	PK	H	45.03	11.21	32.38	64.59	74	-9.41

Middle Channel (2440 MHz)

Frequency (MHz)	S.A. Reading (dB μ V)	Detector (PK/AV)	Polarity (H/V)	Ant. Factor (dB/m)	Cable Loss (dB)	Pre-Amp. Gain (dB)	Cord. Amp. (dB μ V/m)	Limit (dB μ V/m)	Margin (dB)
4880	38.84	AV	V	33.86	6.82	31.82	47.7	54	-6.3
4880	38.42	AV	H	33.86	6.82	31.82	47.28	54	-6.72
4880	48.23	PK	V	33.86	6.82	31.82	57.09	74	-16.91
4880	47.98	PK	H	33.86	6.82	31.82	56.84	74	-17.16
17824	24.35	AV	V	45.15	11.18	32.41	48.27	54	-5.73
17824	24.08	AV	H	45.15	11.18	32.41	48	54	-6
17824	41.11	PK	V	45.15	11.18	32.41	65.03	74	-8.97
17824	40.82	PK	H	45.15	11.18	32.41	64.74	74	-9.26

High Channel (2480 MHz)

Frequency (MHz)	S.A. Reading (dB μ V)	Detector (PK/AV)	Polarity (H/V)	Ant. Factor (dB/m)	Cable Loss (dB)	Pre-Amp. Gain (dB)	Cord. Amp. (dB μ V/m)	Limit (dB μ V/m)	Margin (dB)
4960	38.71	AV	V	33.9	6.76	31.92	47.45	54	-6.55
4960	38.34	AV	H	33.9	6.76	31.92	47.08	54	-6.92
4960	48.21	PK	V	33.9	6.76	31.92	56.95	74	-17.05
4960	47.86	PK	H	33.9	6.76	31.92	56.6	74	-17.4
17806	24.76	AV	V	45.22	11.35	32.38	48.95	54	-5.05
17806	24.51	AV	H	45.22	11.35	32.38	48.7	54	-5.3
17806	41.32	PK	V	45.22	11.35	32.38	65.51	74	-8.49
17806	41.04	PK	H	45.22	11.35	32.38	65.23	74	-8.77

Note:

- 1, The testing has been conformed to 10*2480MHz=24,800MHz
- 2, All other emissions more than 30 dB below the limit
- 3, X-Axis, Y-Axis and Z-Axis were investigated. The results above show only the worst case.

Annex A. TEST INSTRUMENT

Instrument	Model	Serial #	Cal Date	Cal Due	In use
AC Line Conducted					
EMI test receiver	ESCS30	8471241027	09/17/2015	09/16/2016	<input checked="" type="checkbox"/>
Line Impedance	LI-125A	191106	09/25/2015	09/24/2016	<input checked="" type="checkbox"/>
Line Impedance	LI-125A	191107	09/25/2015	09/24/2016	<input checked="" type="checkbox"/>
LISN	ISN T800	34373	09/25/2015	09/24/2016	<input checked="" type="checkbox"/>
Double Ridge Horn Antenna (1 ~18GHz)	AH-118	71283	09/24/2015	09/23/2016	<input checked="" type="checkbox"/>
Transient Limiter	LIT-153	531118	08/31/2016	08/30/2017	<input checked="" type="checkbox"/>
RF conducted test					
Agilent ESA-E SERIES	E4407B	MY45108319	09/16/2016	09/15/2017	<input checked="" type="checkbox"/>
Power Splitter	1#	1#	08/31/2016	08/30/2017	<input checked="" type="checkbox"/>
DC Power Supply	E3640A	MY40004013	09/16/2016	09/15/2017	<input checked="" type="checkbox"/>
Radiated Emissions					
EMI test receiver	ESL6	100262	09/17/2015	09/16/2016	<input checked="" type="checkbox"/>
Positioning Controller	UC3000	MF780208282	11/19/2015	11/18/2016	<input checked="" type="checkbox"/>
OPT 010 AMPLIFIER (0.1-1300MHz)	8447E	2727A02430	08/31/2016	08/30/2017	<input checked="" type="checkbox"/>
Microwave Preamplifier (1 ~ 26.5GHz)	8449B	3008A02402	03/24/2016	03/23/2017	<input checked="" type="checkbox"/>
Bilog Antenna (30MHz~6GHz)	JB6	A110712	09/21/2015	09/20/2016	<input checked="" type="checkbox"/>
Double Ridge Horn Antenna (1 ~18GHz)	AH-118	71283	09/24/2015	09/23/2016	<input checked="" type="checkbox"/>
Universal Radio Communication Tester	CMU200	121393	09/25/2015	09/24/2016	<input checked="" type="checkbox"/>

Annex B. EUT And Test Setup Photographs

Annex B.i. Photograph: EUT External Photo

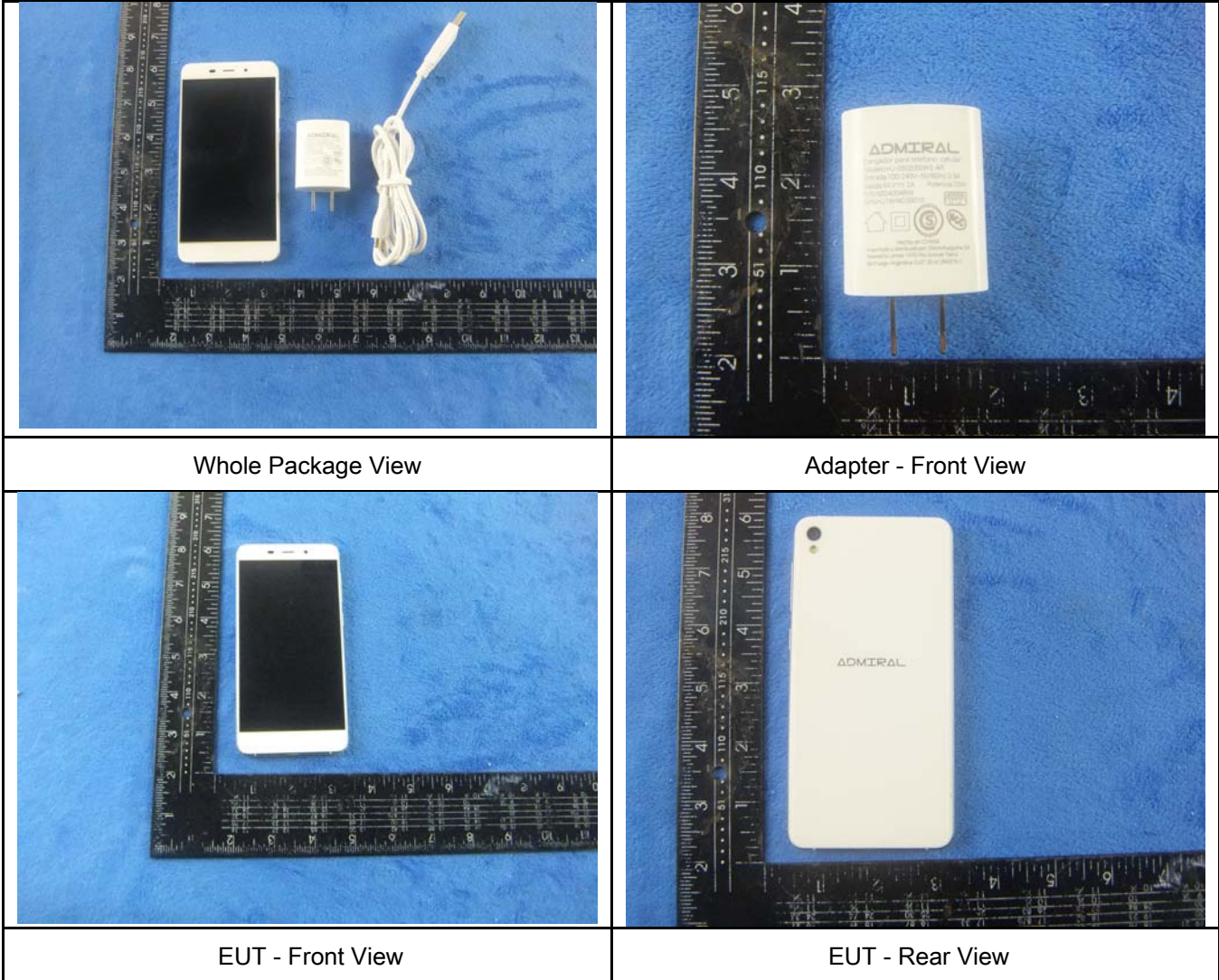

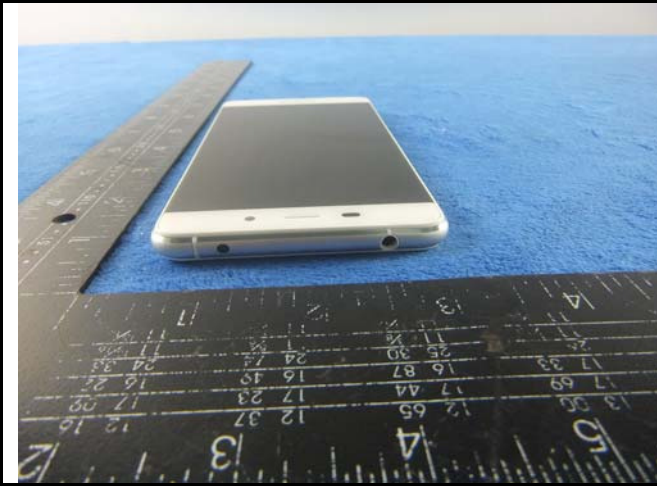

EUT - Top View

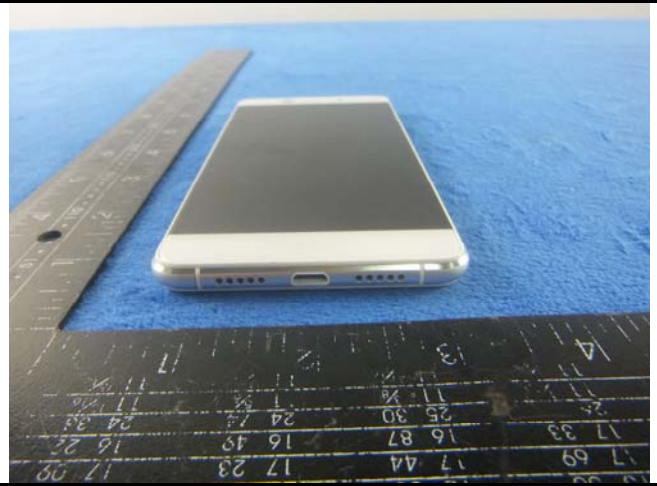

EUT - Bottom View

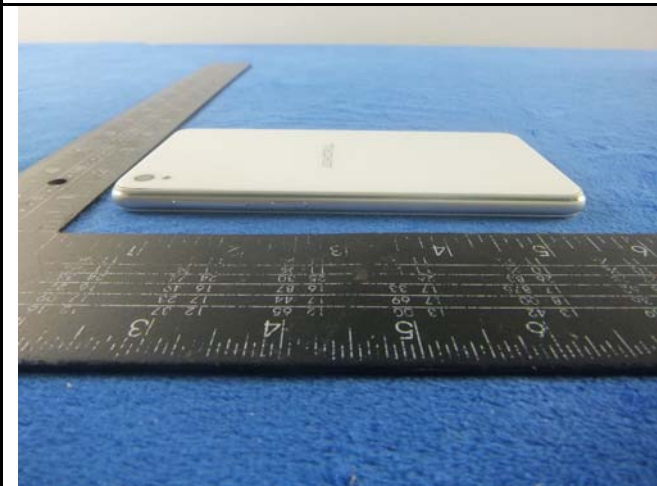

EUT - Left View

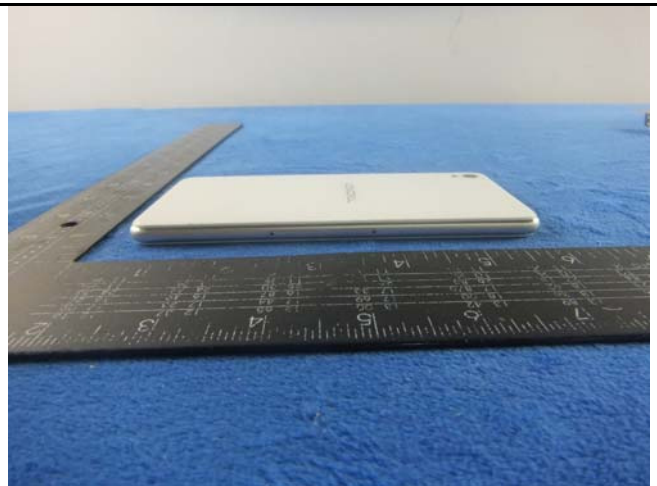

EUT - Right View

Annex B.ii. Photograph: EUT Internal Photo



Cover Off - Top View 1



Cover Off - Top View 2



Battery - Front View

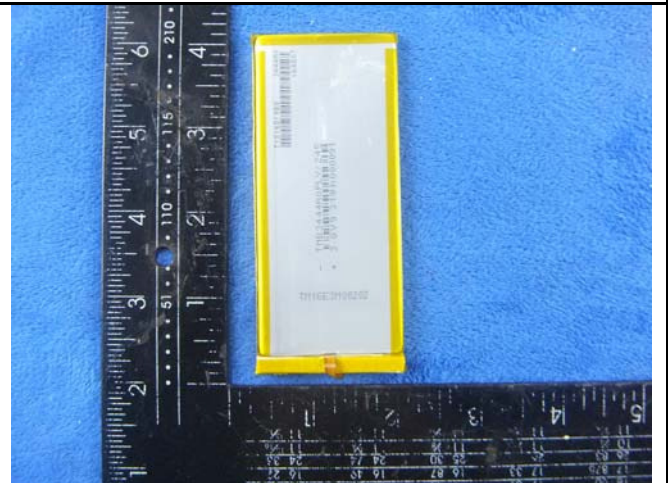

Battery - Rear View

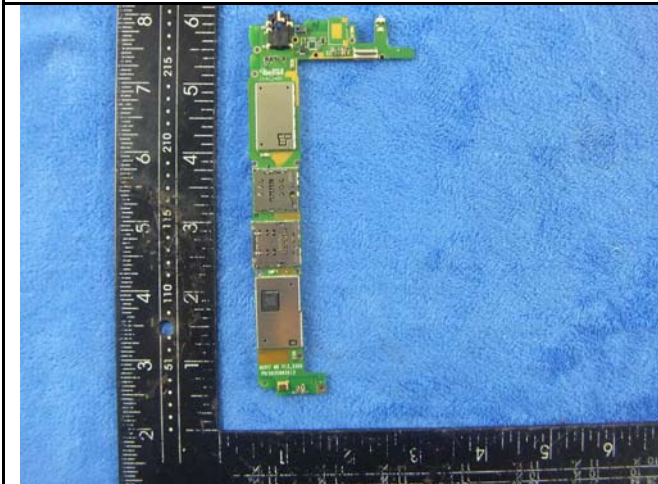

Mainboard with Shielding - Front View

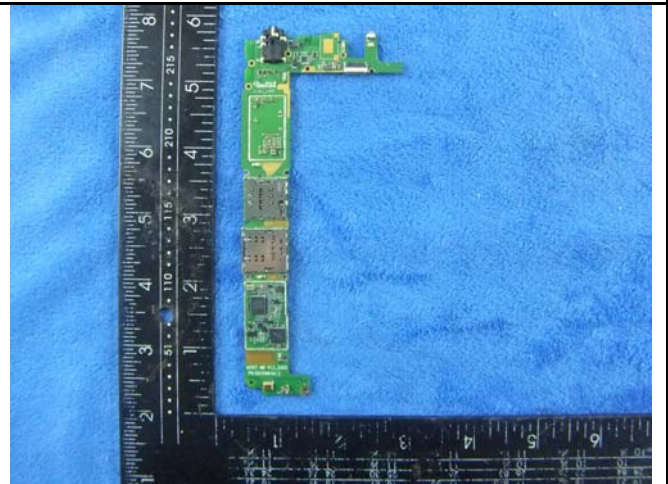

Mainboard without Shielding - Front View

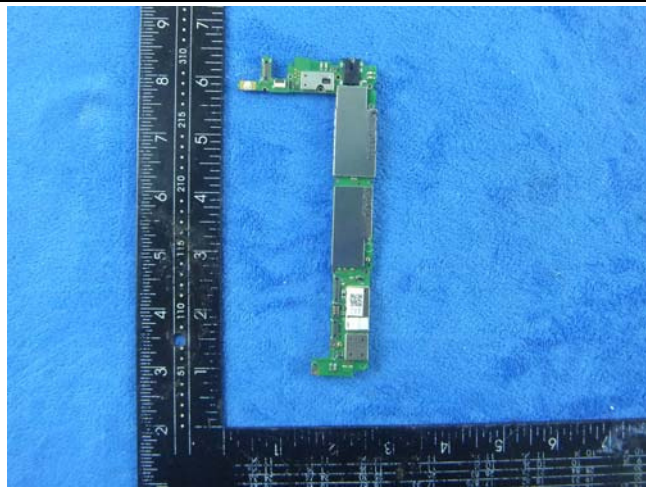

Mainboard with Shielding - Rear View

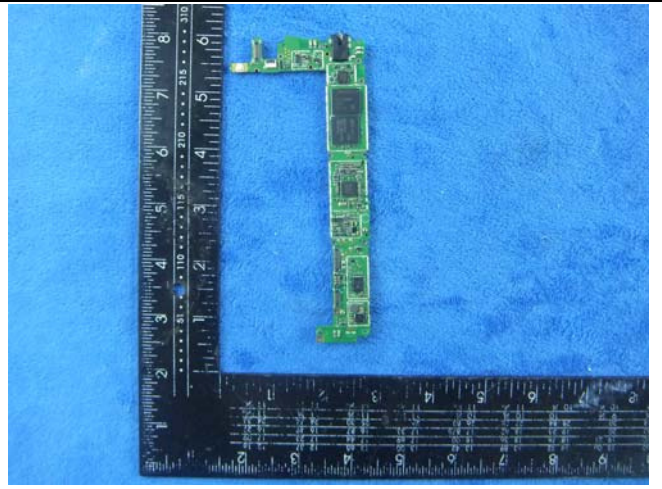

Mainboard without Shielding - Rear View



LCD – Front View



LCD – Rear View

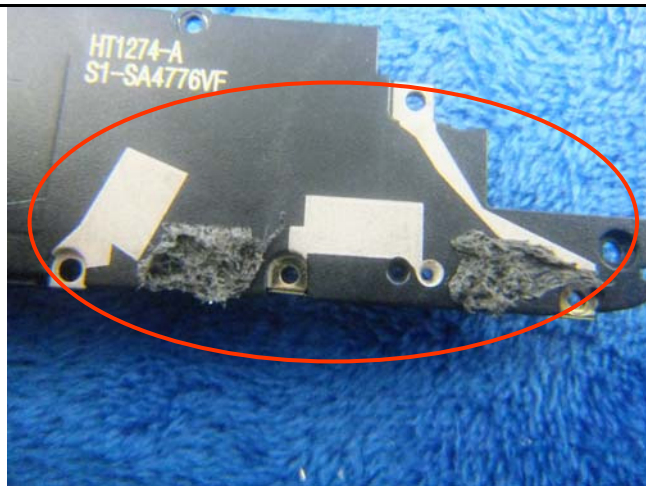

GSM/PCS/UMTS-FDD/ LTE -Antenna View

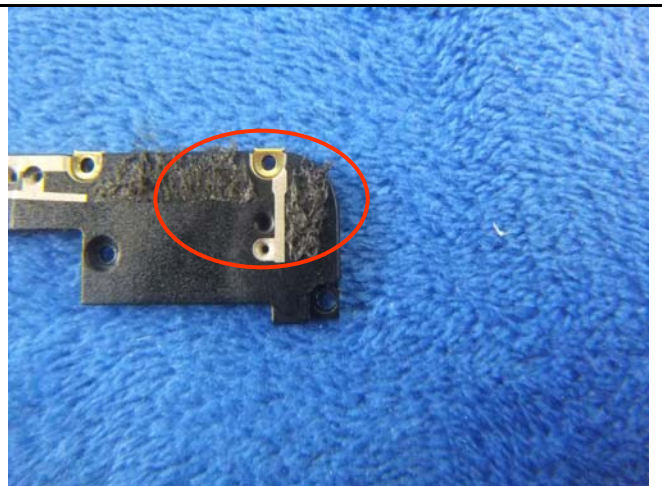

WIFI/BT/BLE/GPS - Antenna View

Annex B.iii. Photograph: Test Setup Photo



Conducted Emissions Test Setup Front View



Conducted Emissions Test Setup Side View



Radiated Spurious Emissions Test Setup Below 1GHz

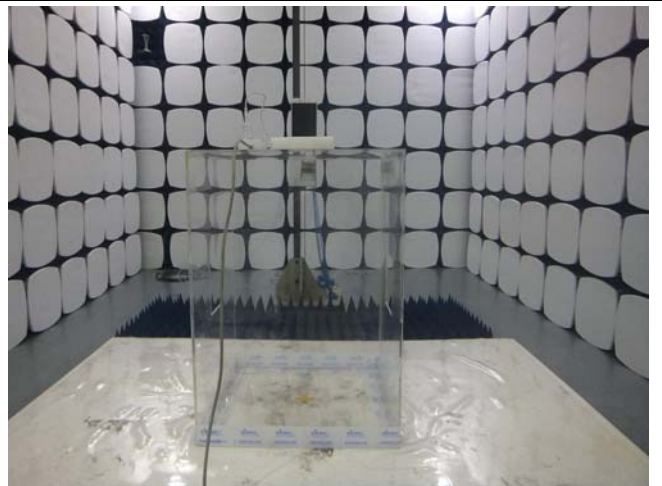

Radiated Spurious Emissions Test Setup Above 1GHz

Annex C. TEST SETUP AND SUPPORTING EQUIPMENT

Annex C.ii. TEST SET UP BLOCK

Block Configuration Diagram for AC Line Conducted Emissions

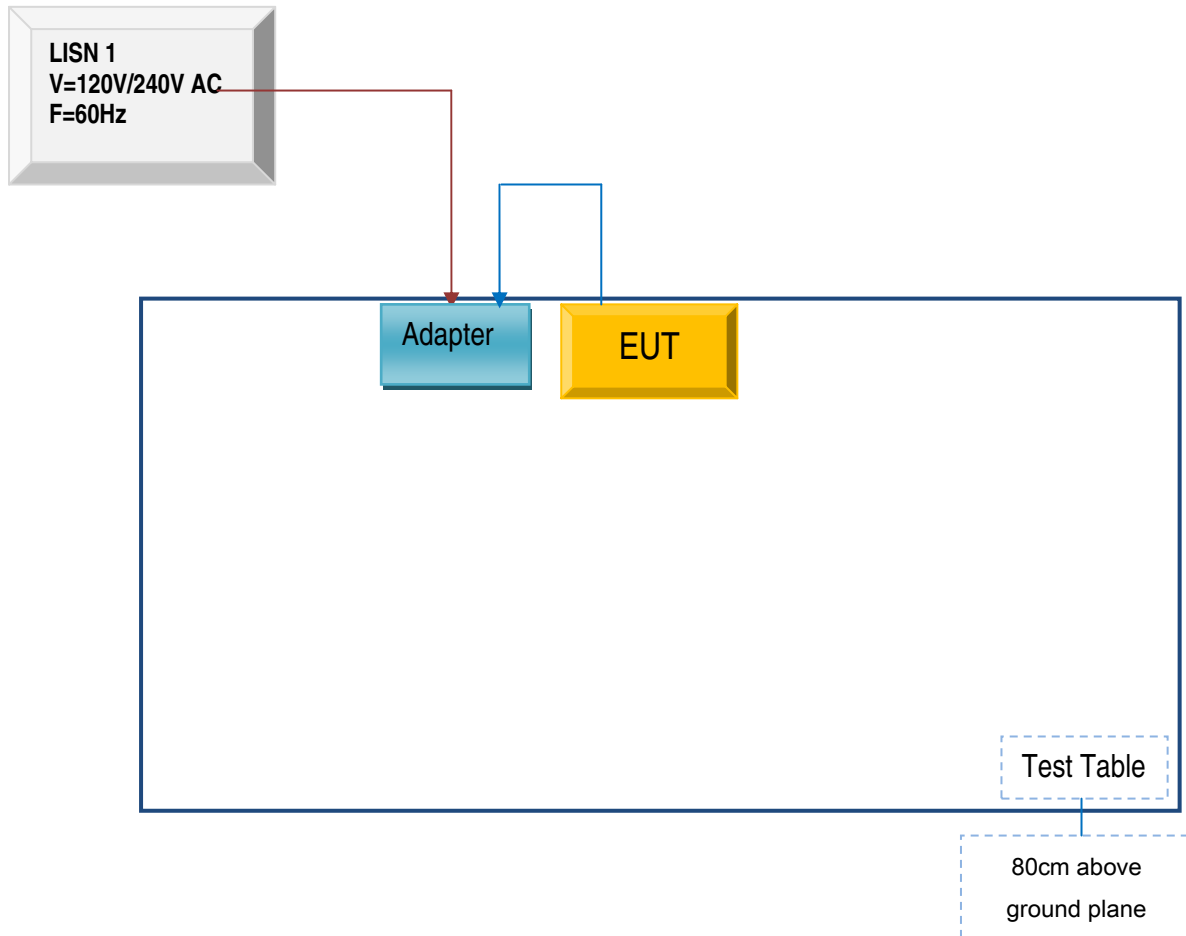

Block Configuration Diagram for Radiated Emissions (Below 1GHz) .

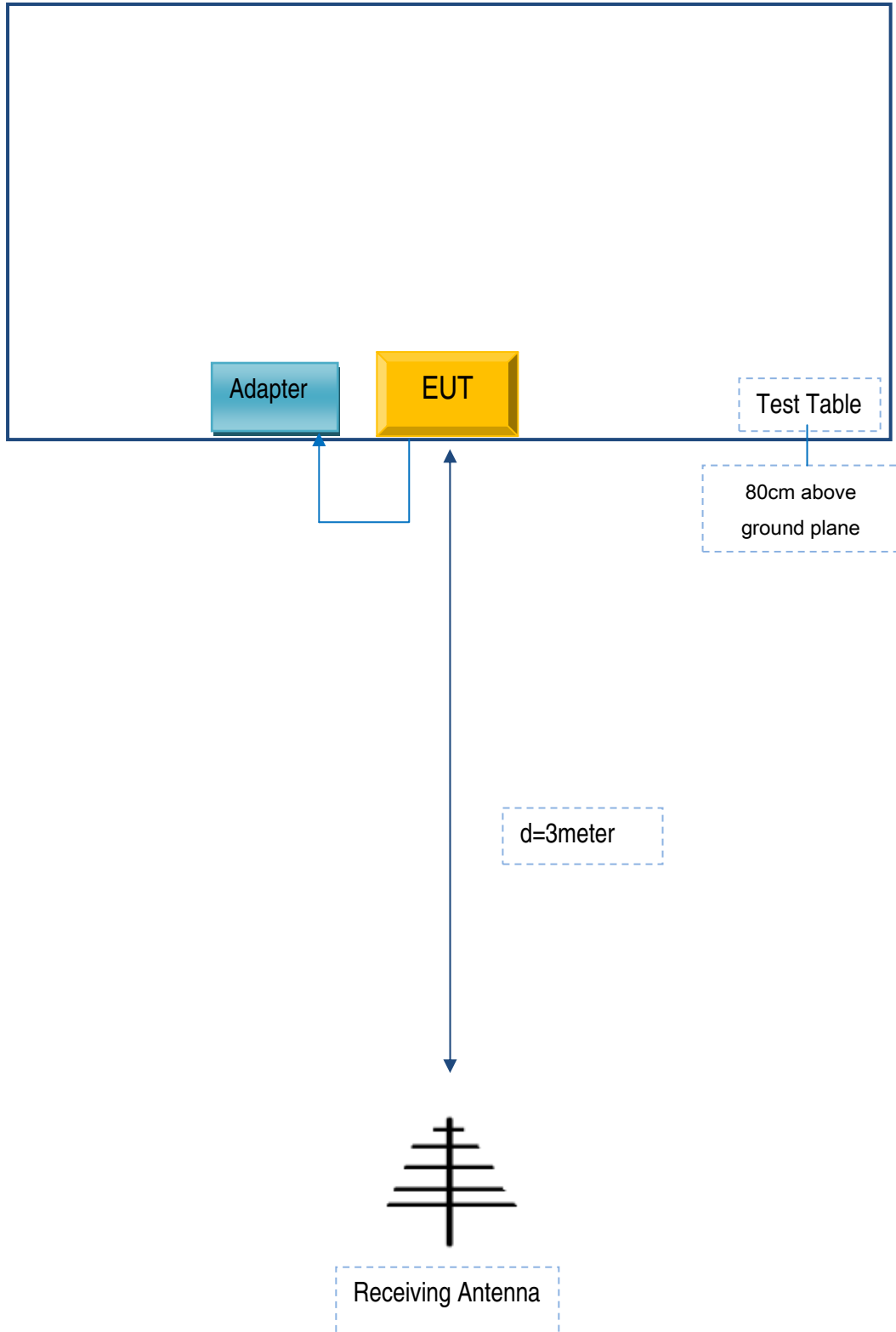

Block Configuration Diagram for Radiated Emissions (Above 1GHz) .

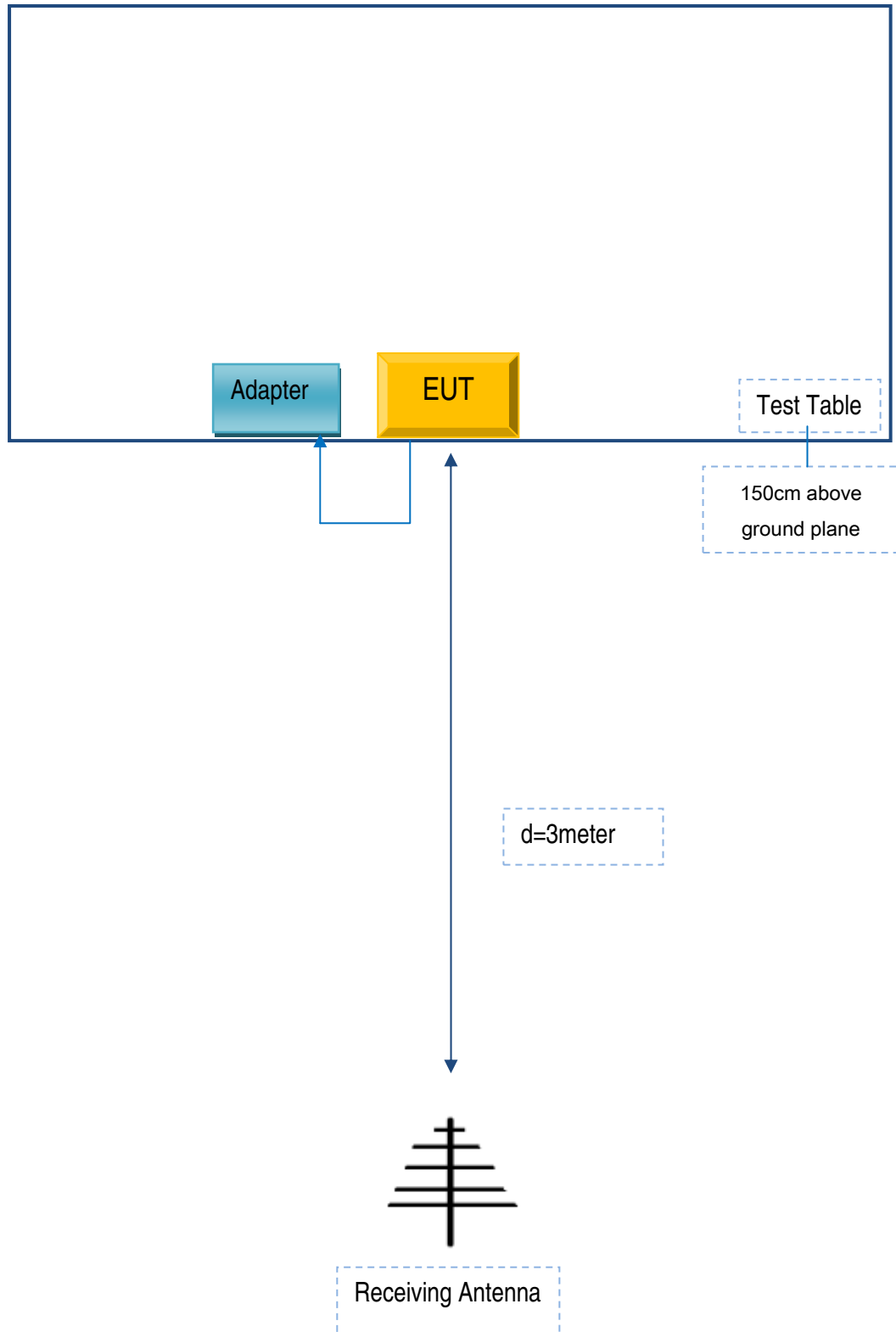

Annex C. ii. SUPPORTING EQUIPMENT DESCRIPTION

The following is a description of supporting equipment and details of cables used with the EUT.

Supporting Equipment:

Manufacturer	Equipment Description	Model	Serial No
Shenzhen Konka Telecommunications Technology Co.,Ltd.	Adapter	HJ-0502000W2-AR	HJ16H4C00010

Supporting Cable:

Cable type	Shield Type	Ferrite Core	Length	Serial No
USB Cable	Un-shielding	No	0.8m	HJ16H4C00010

Test Report No.	16071058-FCC-R4
Page	41 of 41

Annex D. User Manual / Block Diagram / Schematics / Partlist

Please see attachment