

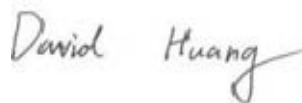

# RF TEST REPORT



Report No.: 16070595-FCC-R4

Supersede Report No.: N/A

Applicant	Shenzhen Konka Telecommunications Technology Co., Ltd.	
Product Name	Smart Phone	
Model No.	AD570	
Serial No.	N/A	
Test Standard	FCC Part 15.247: 2015, ANSI C63.10: 2013	
Test Date	May 26 to June 06, 2016	
Issue Date	June 07, 2016	
Test Result	<input checked="" type="checkbox"/> Pass <input type="checkbox"/> Fail	
Equipment complied with the specification	<input checked="" type="checkbox"/>	
Equipment did not comply with the specification	<input type="checkbox"/>	
		
Loren Luo Test Engineer	David Huang Checked By	
This test report may be reproduced in full only Test result presented in this test report is applicable to the tested sample only		

Issued by:

**SIEMIC (SHENZHEN-CHINA) LABORATORIES**

Zone A, Floor 1, Building 2 Wan Ye Long Technology Park

South Side of Zhoushi Road, Bao' an District, Shenzhen, Guangdong China 518108

Phone: +86 0755 2601 4629801 Email: [China@siemic.com.cn](mailto:China@siemic.com.cn)

## Laboratories Introduction

SIEMIC, headquartered in the heart of Silicon Valley, with superior facilities in US and Asia, is one of the leading independent testing and certification facilities providing customers with one-stop shop services for Compliance Testing and Global Certifications.



In addition to testing and certification, SIEMIC provides initial design reviews and compliance management throughout a project. Our extensive experience with China, Asia Pacific, North America, European, and International compliance requirements, assures the fastest, most cost effective way to attain regulatory compliance for the global markets.

### Accreditations for Conformity Assessment

Country/Region	Scope
USA	EMC, RF/Wireless, SAR, Telecom
Canada	EMC, RF/Wireless, SAR, Telecom
Taiwan	EMC, RF, Telecom, SAR, Safety
Hong Kong	RF/Wireless, SAR, Telecom
Australia	EMC, RF, Telecom, SAR, Safety
Korea	EMI, EMS, RF, SAR, Telecom, Safety
Japan	EMI, RF/Wireless, SAR, Telecom
Singapore	EMC, RF, SAR, Telecom
Europe	EMC, RF, SAR, Telecom, Safety

Test Report No.	16070595-FCC-R4
Page	3 of 43

This page has been left blank intentionally.

# CONTENTS

1. REPORT REVISION HISTORY .....	5
2. CUSTOMER INFORMATION .....	5
3. TEST SITE INFORMATION.....	5
4. EQUIPMENT UNDER TEST (EUT) INFORMATION .....	6
5. TEST SUMMARY .....	9
6. MEASUREMENTS, EXAMINATION AND DERIVED RESULTS .....	10
6.1 ANTENNA REQUIREMENT.....	10
6.2 DTS (6 DB) CHANNEL BANDWIDTH .....	11
6.3 MAXIMUM OUTPUT POWER .....	13
6.4 POWER SPECTRAL DENSITY.....	15
6.5 BAND-EDGE & UNWANTED EMISSIONS INTO RESTRICTED FREQUENCY BANDS .....	17
6.6 AC POWER LINE CONDUCTED EMISSIONS.....	20
6.7 RADIATED SPURIOUS EMISSIONS & RESTRICTED BAND .....	26
ANNEX A. TEST INSTRUMENT.....	32
ANNEX B. EUT AND TEST SETUP PHOTOGRAPHS.....	33
ANNEX C. TEST SETUP AND SUPPORTING EQUIPMENT.....	38
ANNEX D. USER MANUAL / BLOCK DIAGRAM / SCHEMATICS / PARTLIST .....	42
ANNEX E. DECLARATION OF SIMILARITY.....	43

## 1. Report Revision History

Report No.	Report Version	Description	Issue Date
16070595-FCC-R4	NONE	Original	June 07, 2016

## 2. Customer information

Applicant Name	Shenzhen Konka Telecommunications Technology Co., Ltd.
Applicant Add	No.9008 Shennan Road,Overseas Chinese Town, ShenZhen, Guangdong,China
Manufacturer	Shenzhen Konka Telecommunications Technology Co., Ltd.
Manufacturer Add	No.9008 Shennan Road,Overseas Chinese Town, ShenZhen, Guangdong,China

## 3. Test site information

Lab performing tests	SIEMIC (Shenzhen-China) LABORATORIES
Lab Address	Zone A, Floor 1, Building 2 Wan Ye Long Technology Park South Side of Zhoushi Road, Bao' an District, Shenzhen, Guangdong China 518108
FCC Test Site No.	718246
IC Test Site No.	4842E-1
Test Software	Radiated Emission Program-To Shenzhen v2.0

## 4. Equipment under Test (EUT) Information

Description of EUT:	Smart Phone
Main Model:	AD570
Serial Model:	N/A
Date EUT received:	May 25, 2016
Test Date(s):	May 26 to June 06, 2016
Equipment Category :	DTS
Antenna Gain:	GSM850: -0.11dBi PCS1900: 0.92dBi UMTS-FDD Band 5: -0.05dBi UMTS-FDD Band 2: 0.81dBi LTE Band 4: 0.81dBi Bluetooth/BLE/WIFI: 1.36dBi GPS: 1.36dBi
Type of Modulation:	GSM / GPRS: GMSK EGPRS: GMSK,8PSK UMTS-FDD: QPSK LTE Band: QPSK, 16QAM 802.11b/g/n: DSSS, OFDM Bluetooth: GFSK, $\pi$ /4DQPSK, 8DPSK BLE: GFSK GPS:BPSK

Test Report No.	16070595-FCC-R4
Page	7 of 43

GSM850 TX: 824.2 ~ 848.8 MHz; RX: 869.2 ~ 893.8 MHz  
 PCS1900 TX: 1850.2 ~ 1909.8 MHz; RX: 1930.2 ~ 1989.8 MHz  
 UMTS-FDD Band 5 TX: 826.4 ~ 846.6 MHz; RX: 871.4 ~ 891.6 MHz  
 UMTS-FDD Band 2 TX:1852.4 ~ 1907.6 MHz;  
 RX: 1932.4 ~ 1987.6 MHz  
 RF Operating Frequency (ies):  
 LTE Band 4 TX: 1712.5 ~ 1752.5 MHz; RX : 2112.5 ~ 2152.5 MHz  
 WIFI: 802.11b/g/n(20M): 2412-2462 MHz  
 WIFI: 802.11n(40M): 2422-2452 MHz  
 Bluetooth& BLE: 2402-2480 MHz  
 GPS: 1575.42 MHz

Max. Output Power: -11.642dBm

GSM 850: 124CH  
 PCS1900: 299CH  
 UMTS-FDD Band 5: 102CH  
 UMTS-FDD Band 2: 277CH  
 Number of Channels:  
 WIFI :802.11b/g/n(20M): 11CH  
 WIFI :802.11n(40M): 7CH  
 Bluetooth: 79CH  
 BLE: 40CH  
 GPS:1CH

Port: Power Port, Earphone Port, USB Port

Trade Name : ADMIRAL

Adapter:  
 Model: HJ-050100-AR  
 Input: AC 100-240V~50/60Hz;0.15A  
 Output: DC 5.0V,1A  
 Input Power: Potencia: 5W  
 Battery:  
 Model: KLB270P350  
 Spec: 3.8V,2700mAh(10.26Wh)  
 Charge limited voltage: 4.35V

Test Report No.	16070595-FCC-R4
Page	8 of 43

---

GPRS/EGPRS Multi-slot class: 8/10/12

FCC ID: UT3AD570

## 5. Test Summary

The product was tested in accordance with the following specifications.

All testing has been performed according to below product classification:

FCC Rules	Description of Test	Result
§15.203	Antenna Requirement	Compliance
§15.247 (a)(2)	DTS (6 dB) CHANNEL BANDWIDTH	Compliance
§15.247(b)(3)	Conducted Maximum Output Power	Compliance
§15.247(e)	Power Spectral Density	Compliance
§15.247(d)	Band-Edge & Unwanted Emissions into Restricted Frequency Bands	Compliance
§15.207 (a),	AC Power Line Conducted Emissions	Compliance
§15.205, §15.209, §15.247(d)	Radiated Spurious Emissions & Unwanted Emissions into Restricted Frequency Bands	Compliance

### Measurement Uncertainty

Emissions		
Test Item	Description	Uncertainty
Band Edge and Radiated Spurious Emissions	Confidence level of approximately 95% (in the case where distributions are normal), with a coverage factor of 2 (for EUTs < 0.5m X 0.5m X 0.5m)	+5.6dB/-4.5dB
-	-	-

## 6. Measurements, Examination And Derived Results

### 6.1 Antenna Requirement

#### Applicable Standard

According to § 15.203, an intentional radiator shall be designed to ensure that no antenna other than that furnished by the responsible party shall be used with the device. The use of a permanently attached antenna or of an antenna that uses a unique coupling to the intentional radiator shall be considered sufficient to comply with the provisions of this section. The manufacturer may design the unit so that a broken antenna can be replaced by the user, but the user of a standard antenna jack or electrical connector is prohibited. The structure and application of the EUT were analyzed to determine compliance with section §15.203 of the rules. §15.203 state that the subject device must meet the following criteria:

- a. Antenna must be permanently attached to the unit.
- b. Antenna must use a unique type of connector to attach to the EUT.

Unit must be professionally installed, and installer shall be responsible for verifying that the correct antenna is employed with the unit.

And according to FCC 47 CFR section 15.247 (b), if the transmitting antennas of directional gain greater than 6dBi are used, the power shall be reduced by the amount in dB that the directional gain of the antenna exceeds 6 dBi.

#### Antenna Connector Construction

The EUT has 3 antennas:

A permanently attached PIFA antenna for Bluetooth/BLE/WIFI/GPS, the gain is 1.36dBi for Bluetooth/BLE/WIFI/GP.

A permanently attached PIFA antenna for GSM/PCS/UMTS, the gain is -0.11dBi for GSM850, 0.92dBi for PCS1900, -0.05dBi for UMTS-FDD Band V, 0.81dBi for UMTS-FDD Band II.

A permanently attached PIFA antenna for LTE Band 4, the gain is 0.81dBi for LTE Band 4.

**The antenna meets up with the ANTENNA REQUIREMENT.**

**Result:** Compliance.

## 6.2 DTS (6 dB) Channel Bandwidth

Temperature	25°C
Relative Humidity	54%
Atmospheric Pressure	1002mbar
Test date :	June 02, 2016
Tested By :	Loren Luo

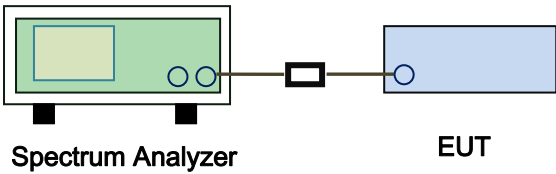
Spec	Item	Requirement	Applicable
§ 15.247(a)(2)	a)	6dB BW ≥ 500kHz;	<input checked="" type="checkbox"/>
RSS Gen(4.6.1)	b)	99% BW: For FCC reference only; required by IC.	<input checked="" type="checkbox"/>
Test Setup	 <p style="text-align: center;">Spectrum Analyzer                      EUT</p>		
Test Procedure	<p>558074 D01 DTS MEAS Guidance v03r03, 8.1 DTS bandwidth <u>6dB Emission bandwidth measurement procedure</u></p> <ul style="list-style-type: none"> <li>- Set RBW = 100 kHz.</li> <li>- Set the video bandwidth (VBW) ≥ 3 RBW.</li> <li>- Detector = Peak.</li> <li>- Trace mode = max hold.</li> <li>- Sweep = auto couple.</li> <li>- Allow the trace to stabilize.</li> </ul> <p>Measure the maximum width of the emission that is constrained by the frequencies associated with the two outermost amplitude points (upper and lower frequencies) that are attenuated by 6 dB relative to the maximum level measured in the fundamental emission.</p>		
Remark			
Result	<input checked="" type="checkbox"/> Pass <input type="checkbox"/> Fail		

Test Data     Yes                       N/A

Test Plot     Yes (See below)                       N/A

## 6dB Bandwidth measurement result

### Test Data

CH	Frequency (MHz)	6dB Bandwidth (kHz)	99% Occupied Bandwidth (MHz)
Low	2402	680.3	1.0364
Mid	2440	680.7	1.0353
High	2480	680.5	1.0362

### Test Plots

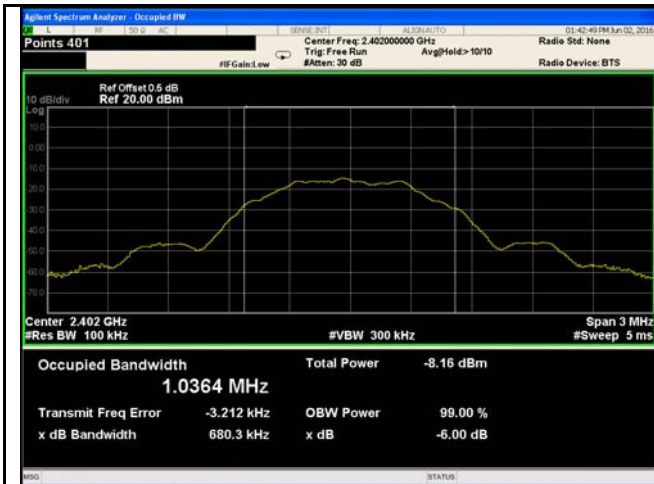

6dB Bandwidth - Low CH 2402



6dB Bandwidth - Mid CH 2440

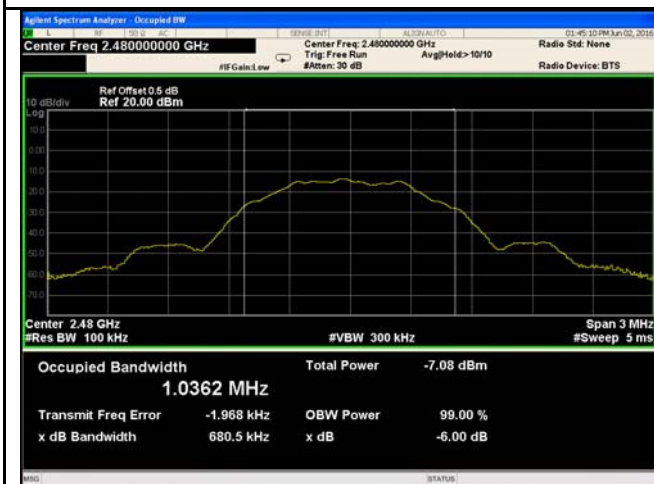

6dB Bandwidth - High CH 2480

### 6.3 Maximum Output Power

Temperature	25°C
Relative Humidity	54%
Atmospheric Pressure	1002mbar
Test date :	June 02, 2016
Tested By :	Loren Luo

#### Requirement(s):

Spec	Item	Requirement	Applicable
§15.247(b) (3),RSS210 (A8.4)	a)	FHSS in 2400-2483.5MHz with $\geq 75$ channels: $\leq 1$ Watt	<input type="checkbox"/>
	b)	FHSS in 5725-5850MHz: $\leq 1$ Watt	<input type="checkbox"/>
	c)	For all other FHSS in the 2400-2483.5MHz band: $\leq 0.125$ Watt.	<input type="checkbox"/>
	d)	FHSS in 902-928MHz with $\geq 50$ channels: $\leq 1$ Watt	<input type="checkbox"/>
	e)	FHSS in 902-928MHz with $\geq 25$ & $<50$ channels: $\leq 0.25$ Watt	<input type="checkbox"/>
	f)	DTS in 902-928MHz, 2400-2483.5MHz: $\leq 1$ Watt	<input checked="" type="checkbox"/>

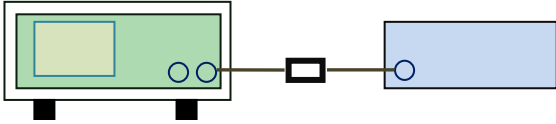
Test Setup	 <p style="text-align: center;">Spectrum Analyzer                      EUT</p>
------------	--

Test Procedure	<p>558074 D01 DTS MEAS Guidance v03r03, 9.1.2 Integrated band power method Maximum output power measurement procedure</p> <ol style="list-style-type: none"> <li>Set the RBW <math>\geq</math> DTS bandwidth.</li> <li>Set VBW <math>\geq 3 \times</math> RBW.</li> <li>Set span <math>\geq 3 \times</math> RBW</li> <li>Sweep time = auto couple.</li> <li>Detector = peak.</li> <li>Trace mode = max hold.</li> <li>Allow trace to fully stabilize.</li> <li>Use peak marker function to determine the peak amplitude level.</li> </ol>
----------------	---

Remark	
--------	--

Result	<input checked="" type="checkbox"/> Pass <input type="checkbox"/> Fail
--------	--

Test Data  Yes  N/A  
 Test Plot  Yes (See below)  N/A

### Output Power measurement result

#### Test Data

Type	CH	Frequency (MHz)	Conducted Power (dBm)	Limit (dBm)	Result
Output power	Low	2402	-12.870	30	Pass
	Mid	2440	-11.642	30	Pass
	High	2480	-11.728	30	Pass

#### Test Plots

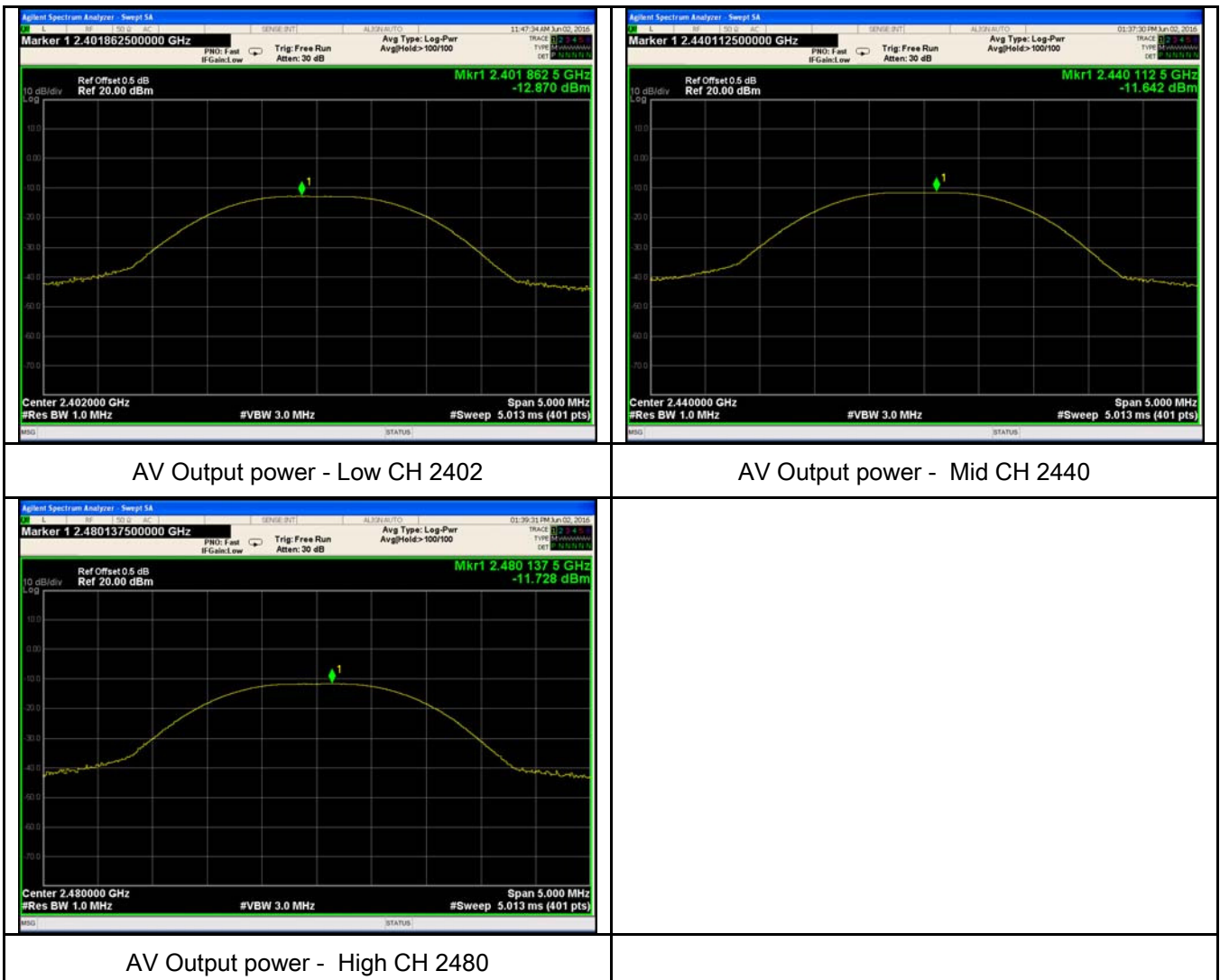

AV Output power - Low CH 2402

AV Output power - Mid CH 2440

AV Output power - High CH 2480

## 6.4 Power Spectral Density

Temperature	25°C
Relative Humidity	54%
Atmospheric Pressure	1002mbar
Test date :	June 02, 2016
Tested By :	Loren Luo

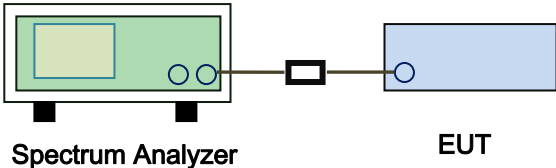
Spec	Item	Requirement	Applicable
§15.247(e)	a)	The power spectral density conducted from the intentional radiator to the antenna shall not be greater than 8 dBm in any 3 kHz band during any time interval of continuous transmission.	<input checked="" type="checkbox"/>
Test Setup	 <p style="text-align: center;">Spectrum Analyzer                      EUT</p>		
Test Procedure	<p>558074 D01 DTS MEAS Guidance v03r03, 10.2 power spectral density method power spectral density measurement procedure</p> <ul style="list-style-type: none"> <li>- a) Set analyzer center frequency to DTS channel center frequency.</li> <li>- b) Set the span to 1.5 times the DTS bandwidth.</li> <li>- c) Set the RBW to: 3 kHz ≤ RBW ≤ 100 kHz.</li> <li>- d) Set the VBW ≥ 3 × RBW.</li> <li>- e) Detector = peak.</li> <li>- f) Sweep time = auto couple.</li> <li>- g) Trace mode = max hold.</li> <li>- h) Allow trace to fully stabilize.</li> <li>- i) Use the peak marker function to determine the maximum amplitude level within the RBW.</li> <li>- j) If measured value exceeds limit, reduce RBW (no less than 3 kHz) and repeat.</li> </ul>		
Remark			
Result	<input checked="" type="checkbox"/> Pass <input type="checkbox"/> Fail		

Test Data     Yes                       N/A  
 Test Plot     Yes (See below)                       N/A

## Power Spectral Density measurement result

### Test Data

Type	CH	Freq (MHz)	Reading (dBm)	Factor (dB)	Result (dBm)	Limit (dBm)	Result
PSD	Low	2402	-23.012	-5.23	-28.242	8	Pass
	Mid	2440	-21.927	-5.23	-27.157	8	Pass
	High	2480	-22.135	-5.23	-27.365	8	Pass

Note: factor= $10\log(3/10)=-5.23$

### Test Plots

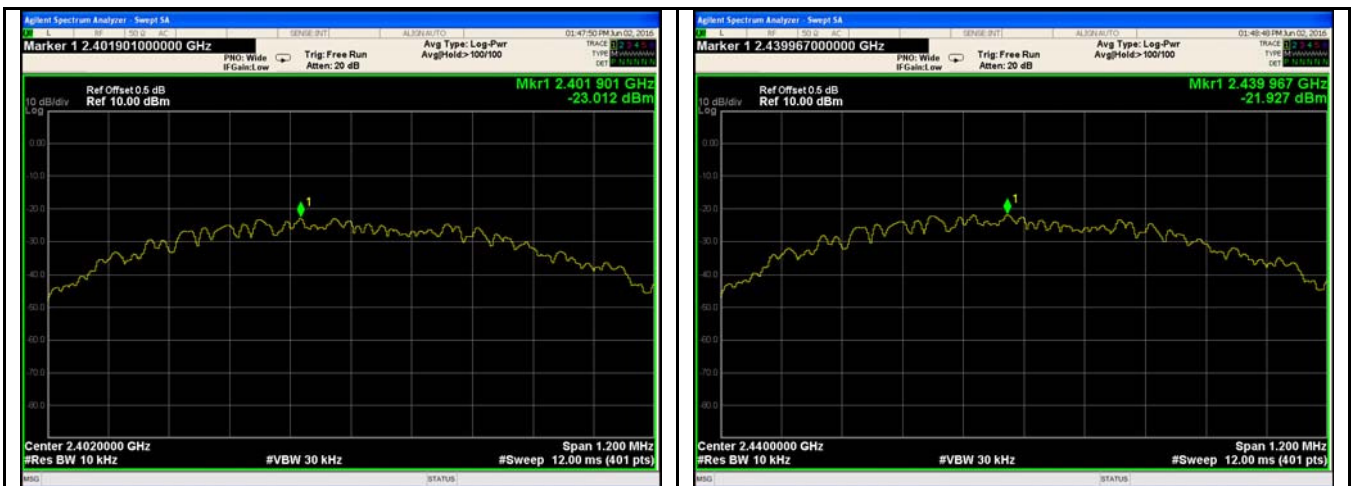

PSD - Low CH 2402

PSD - Mid CH 2440



PSD - High CH 2480

## 6.5 Band-Edge & Unwanted Emissions into Restricted Frequency Bands

Temperature	23°C
Relative Humidity	58%
Atmospheric Pressure	1006mbar
Test date :	June 06, 2016
Tested By :	Loren Luo

### Requirement(s):

Spec	Item	Requirement	Applicable
§15.247(d)	a)	In any 100 kHz bandwidth outside the frequency band in which the spread spectrum or digitally modulated intentional radiator is operating, the radio frequency power that is produced by the intentional radiator shall be at least 20 dB below that in the 100 kHz bandwidth within the band that contains the highest level of the desired power, based on either an RF conducted or a radiated measurement, provided the transmitter demonstrates compliance with the peak conducted power limits.	<input checked="" type="checkbox"/>

Test Setup	
------------	--

Test Procedure	<p>Radiated Method Only</p> <ul style="list-style-type: none"> <li>- 1. Check the calibration of the measuring instrument using either an internal calibrator or a known signal from an external generator.</li> <li>- 2. Position the EUT without connection to measurement instrument. Put it on the Rotated table and turn on the EUT and make it operate in transmitting mode. Then set it to Low Channel and High Channel within its operating range, and make sure the instrument is operated in its linear range.</li> </ul>
----------------	---

Test Report No.	16070595-FCC-R4
Page	18 of 43

	<ul style="list-style-type: none"> <li>- 3. First, set both RBW and VBW of spectrum analyzer to 100 kHz with a convenient frequency span including 100kHz bandwidth from band edge, check the emission of EUT, if pass then set Spectrum Analyzer as below:           <ul style="list-style-type: none"> <li>a. The resolution bandwidth and video bandwidth of test receiver/spectrum analyzer is 120 kHz for Quasiy Peak detection at frequency below 1GHz.</li> <li>b. The resolution bandwidth of test receiver/spectrum analyzer is 1MHz and video bandwidth is 3MHz with Peak detection for Peak measurement at frequency above 1GHz.</li> <li>c. The resolution bandwidth of test receiver/spectrum analyzer is 1MHz and the video bandwidth is 10Hz with Peak detection for Average Measurement as below at frequency above 1GHz.</li> </ul> </li> <li>- 4. Measure the highest amplitude appearing on spectral display and set it as a reference level. Plot the graph with marking the highest point and edge frequency.</li> <li>- 5. Repeat above procedures until all measured frequencies were complete.</li> </ul>
Remark	
Result	<input checked="" type="checkbox"/> Pass <input type="checkbox"/> Fail

Test Data     Yes                       N/A  
 Test Plot      Yes (See below)             N/A

**Test Plots**

**Band Edge measurement result**

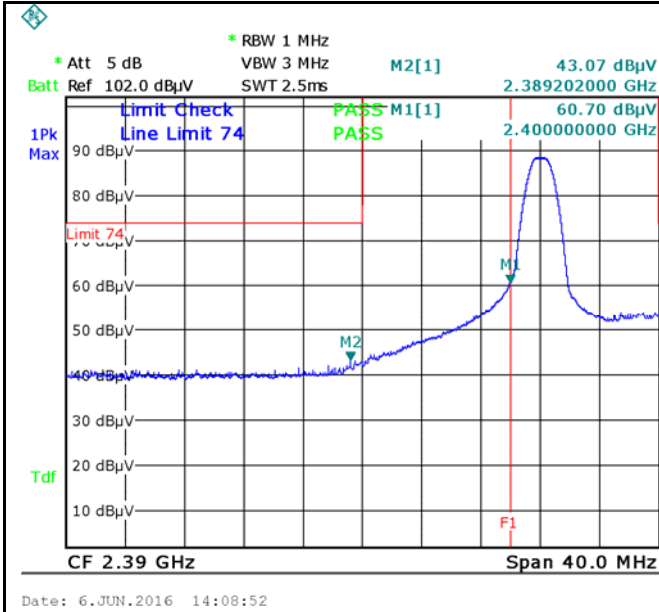

Band Edge, Left Side (Peak)

Note: F1 is frequency 2390MHz; F2 is frequency 2400MHz

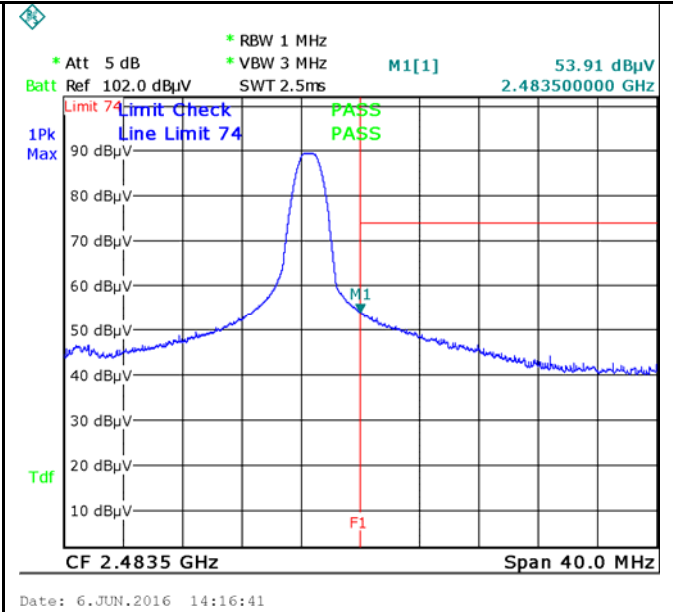

Band Edge, Right Side (Peak)

Note: F1 is frequency 2483.5MHz

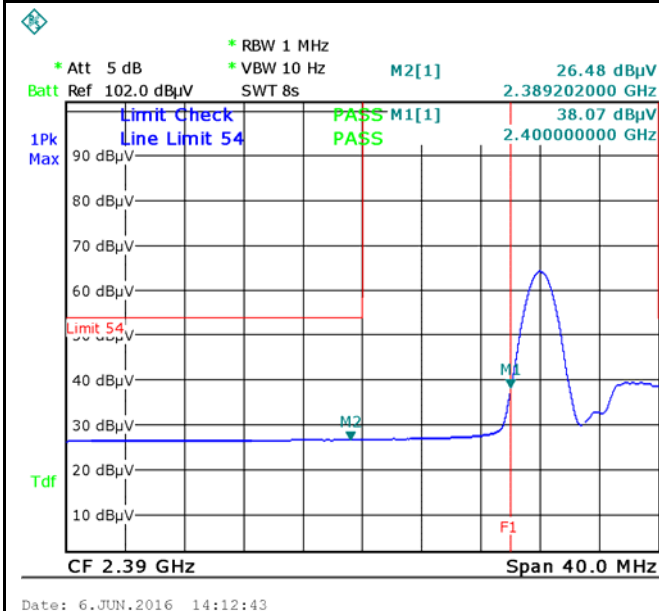

Band Edge, Left Side-AV

Note: (no need if PK value less than the AV limit)

Band Edge, Right Side-AV

## 6.6 AC Power Line Conducted Emissions

Temperature	23°C
Relative Humidity	58%
Atmospheric Pressure	1006mbar
Test date :	June 06, 2016
Tested By :	Loren Luo

### Requirement(s):

Spec	Item	Requirement	Applicable														
47CFR§15.207, RSS210 (A8.1)	a)	For Low-power radio-frequency devices that is designed to be connected to the public utility (AC) power line, the radio frequency voltage that is conducted back onto the AC power line on any frequency or frequencies, within the band 150 kHz to 30 MHz, shall not exceed the limits in the following table, as measured using a 50 [μ] H/50 ohms line impedance stabilization network (LISN). The lower limit applies at the boundary between the frequencies ranges.	<input checked="" type="checkbox"/>														
		<table border="1"> <thead> <tr> <th rowspan="2">Frequency ranges (MHz)</th> <th colspan="2">Limit (dBμV)</th> </tr> <tr> <th>QP</th> <th>Average</th> </tr> </thead> <tbody> <tr> <td>0.15 ~ 0.5</td> <td>66 – 56</td> <td>56 – 46</td> </tr> <tr> <td>0.5 ~ 5</td> <td>56</td> <td>46</td> </tr> <tr> <td>5 ~ 30</td> <td>60</td> <td>50</td> </tr> </tbody> </table>		Frequency ranges (MHz)	Limit (dBμV)		QP	Average	0.15 ~ 0.5	66 – 56	56 – 46	0.5 ~ 5	56	46	5 ~ 30	60	50
		Frequency ranges (MHz)			Limit (dBμV)												
				QP	Average												
0.15 ~ 0.5	66 – 56	56 – 46															
0.5 ~ 5	56	46															
5 ~ 30	60	50															

Test Setup	<p>Note: 1. Support units were connected to second LISN. 2. Both of LISNs (AMN) are 80cm from EUT and at least 80cm from other units and other metal planes support units.</p>
------------	--

Procedure	<ol style="list-style-type: none"> <li>The EUT and supporting equipment were set up in accordance with the requirements of the standard on top of a 1.5m x 1m x 0.8m high, non-metallic table.</li> <li>The power supply for the EUT was fed through a 50W/50mH EUT LISN, connected to filtered mains.</li> <li>The RF OUT of the EUT LISN was connected to the EMI test receiver via a low-loss</li> </ol>
-----------	---

Test Report No.	16070595-FCC-R4
Page	21 of 43

	<p>coaxial cable.</p> <ol style="list-style-type: none"> <li>4. All other supporting equipment were powered separately from another main supply.</li> <li>5. The EUT was switched on and allowed to warm up to its normal operating condition.</li> <li>6. A scan was made on the NEUTRAL line (for AC mains) or Earth line (for DC power) over the required frequency range using an EMI test receiver.</li> <li>7. High peaks, relative to the limit line, The EMI test receiver was then tuned to the selected frequencies and the necessary measurements made with a receiver bandwidth setting of 10 kHz.</li> <li>8. Step 7 was then repeated for the LIVE line (for AC mains) or DC line (for DC power).</li> </ol>
Remark	
Result	<input checked="" type="checkbox"/> Pass <input type="checkbox"/> Fail

Test Data     Yes                       N/A

Test Plot      Yes (See below)             N/A

**Test Mode:** Transmitting Mode

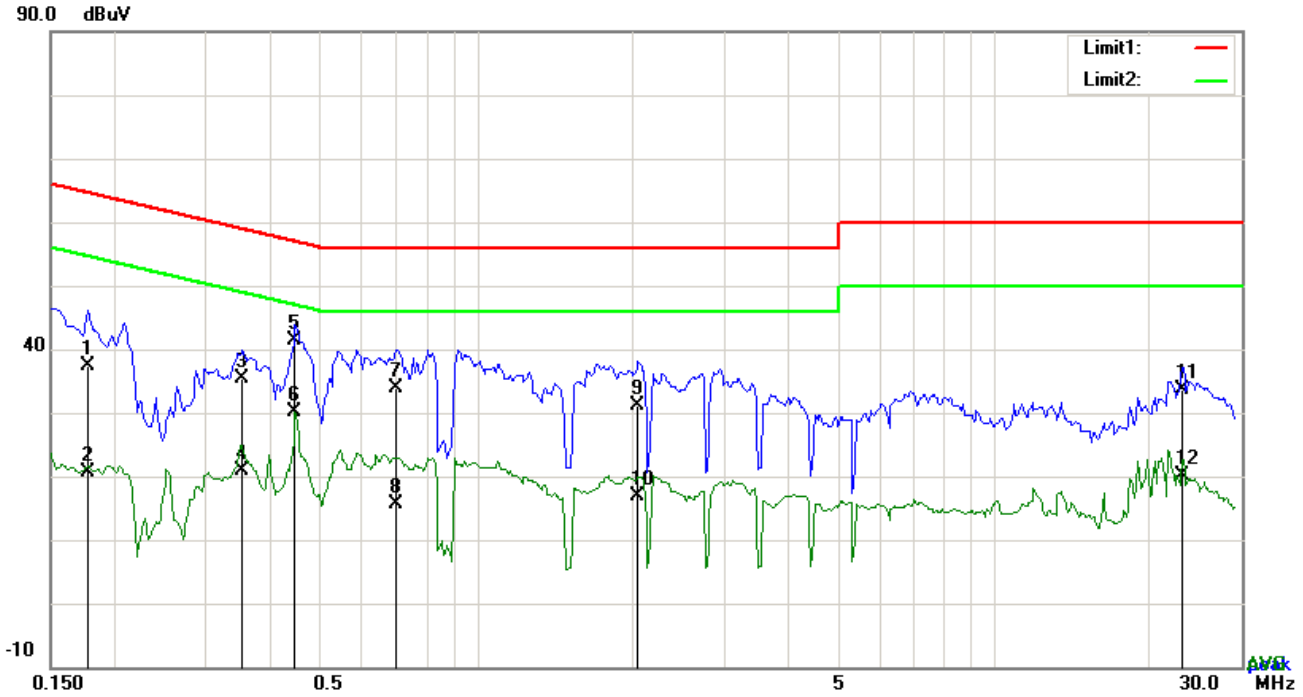

**Test Data**

Phase Line Plot at 120Vac, 60Hz

No.	P/L	Frequency (MHz)	Reading (dBµV)	Detector	Corrected (dB)	Result (dBµV)	Limit (dBµV)	Margin (dB)
1	L1	0.1773	27.34	QP	10.03	37.37	64.61	-27.24
2	L1	0.1773	10.48	AVG	10.03	20.51	54.61	-34.10
3	L1	0.3528	25.40	QP	10.03	35.43	58.90	-23.47
4	L1	0.3528	10.95	AVG	10.03	20.98	48.90	-27.92
5	L1	0.4464	31.43	QP	10.03	41.46	56.94	-15.48
6	L1	0.4464	20.18	AVG	10.03	30.21	46.94	-16.73
7	L1	0.6999	23.88	QP	10.03	33.91	56.00	-22.09
8	L1	0.6999	5.64	AVG	10.03	15.67	46.00	-30.33
9	L1	2.0493	21.17	QP	10.04	31.21	56.00	-24.79
10	L1	2.0493	6.82	AVG	10.04	16.86	46.00	-29.14
11	L1	23.1318	23.17	QP	10.36	33.53	60.00	-26.47
12	L1	23.1318	9.84	AVG	10.36	20.20	50.00	-29.80

**Test Mode:** Transmitting Mode

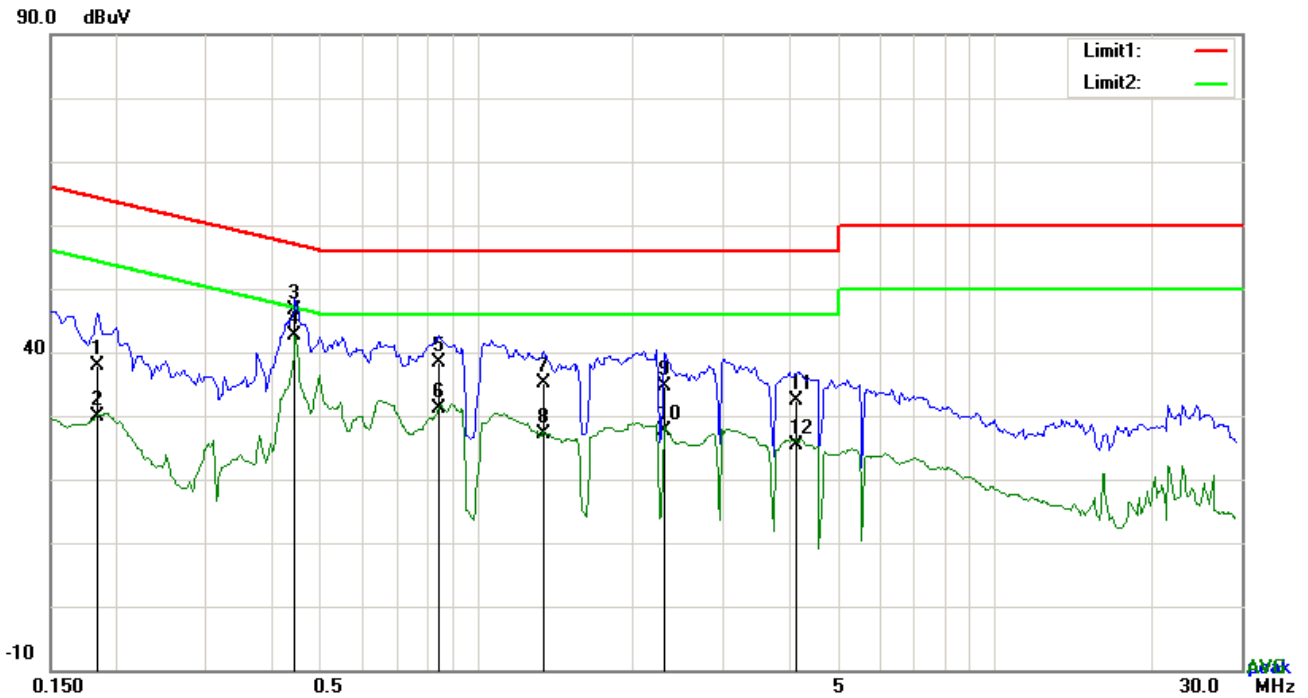

**Test Data**

**Phase Neutral Plot at 120Vac, 60Hz**

No.	P/L	Frequency (MHz)	Reading (dBμV)	Detector	Corrected (dB)	Result (dBμV)	Limit (dBμV)	Margin (dB)
1	N	0.1851	27.92	QP	10.02	37.94	64.25	-26.31
2	N	0.1851	19.87	AVG	10.02	29.89	54.25	-24.36
3	N	0.4464	36.51	QP	10.02	46.53	56.94	-10.41
4	N	0.4464	32.52	AVG	10.02	42.54	46.94	-4.40
5	N	0.8481	28.26	QP	10.03	38.29	56.00	-17.71
6	N	0.8481	21.06	AVG	10.03	31.09	46.00	-14.91
7	N	1.3512	25.11	QP	10.03	35.14	56.00	-20.86
8	N	1.3512	17.05	AVG	10.03	27.08	46.00	-18.92
9	N	2.2989	24.65	QP	10.04	34.69	56.00	-21.31
10	N	2.2989	17.63	AVG	10.04	27.67	46.00	-18.33
11	N	4.1356	22.40	QP	10.06	32.46	56.00	-23.54
12	N	4.1356	15.44	AVG	10.06	25.50	46.00	-20.50

**Test Mode:** Transmitting Mode

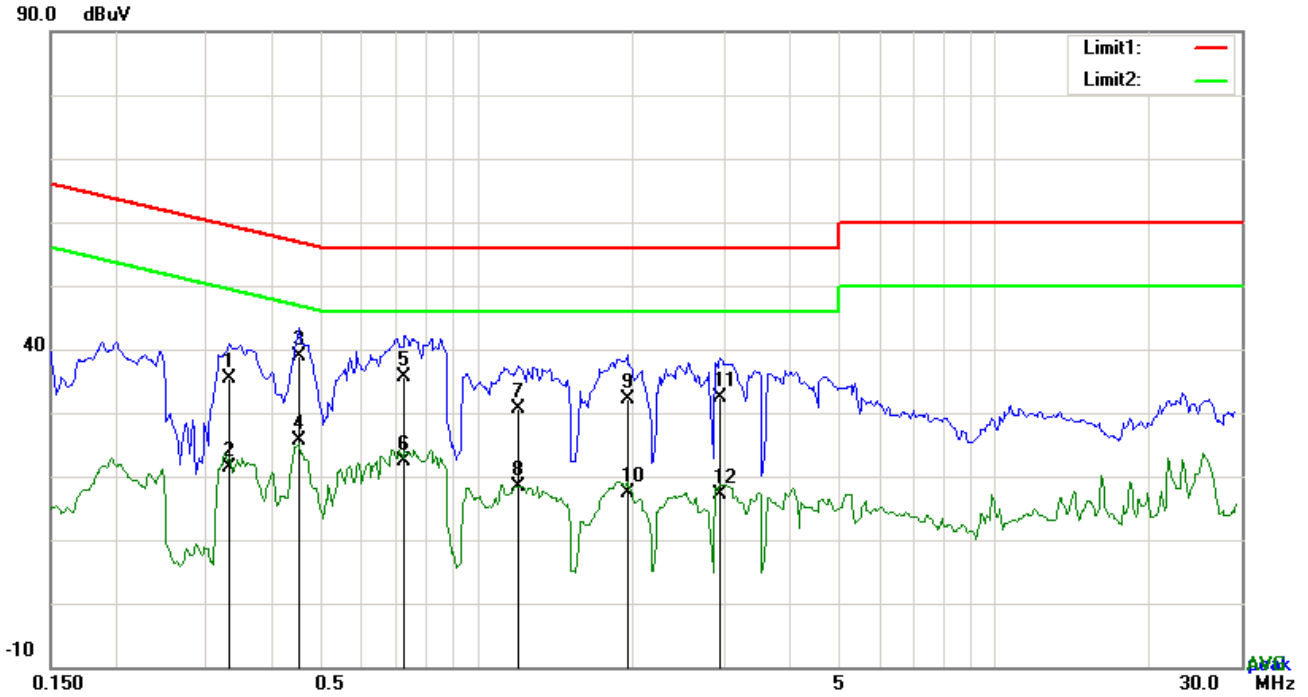

**Test Data**

**Phase Line Plot at 240Vac, 60Hz**

No.	P/L	Frequency (MHz)	Reading (dBµV)	Detector	Corrected (dB)	Result (dBµV)	Limit (dBµV)	Margin (dB)
1	L1	0.3333	25.28	QP	10.03	35.31	59.37	-24.06
2	L1	0.3333	11.41	AVG	10.03	21.44	49.37	-27.93
3	L1	0.4542	28.81	QP	10.03	38.84	56.80	-17.96
4	L1	0.4542	15.64	AVG	10.03	25.67	46.80	-21.13
5	L1	0.7272	25.53	QP	10.03	35.56	56.00	-20.44
6	L1	0.7272	12.32	AVG	10.03	22.35	46.00	-23.65
7	L1	1.2030	20.69	QP	10.03	30.72	56.00	-25.28
8	L1	1.2030	8.26	AVG	10.03	18.29	46.00	-27.71
9	L1	1.9557	22.00	QP	10.04	32.04	56.00	-23.96
10	L1	1.9557	7.45	AVG	10.04	17.49	46.00	-28.51
11	L1	2.9580	22.31	QP	10.05	32.36	56.00	-23.64
12	L1	2.9580	7.02	AVG	10.05	17.07	46.00	-28.93

**Test Mode:** Transmitting Mode

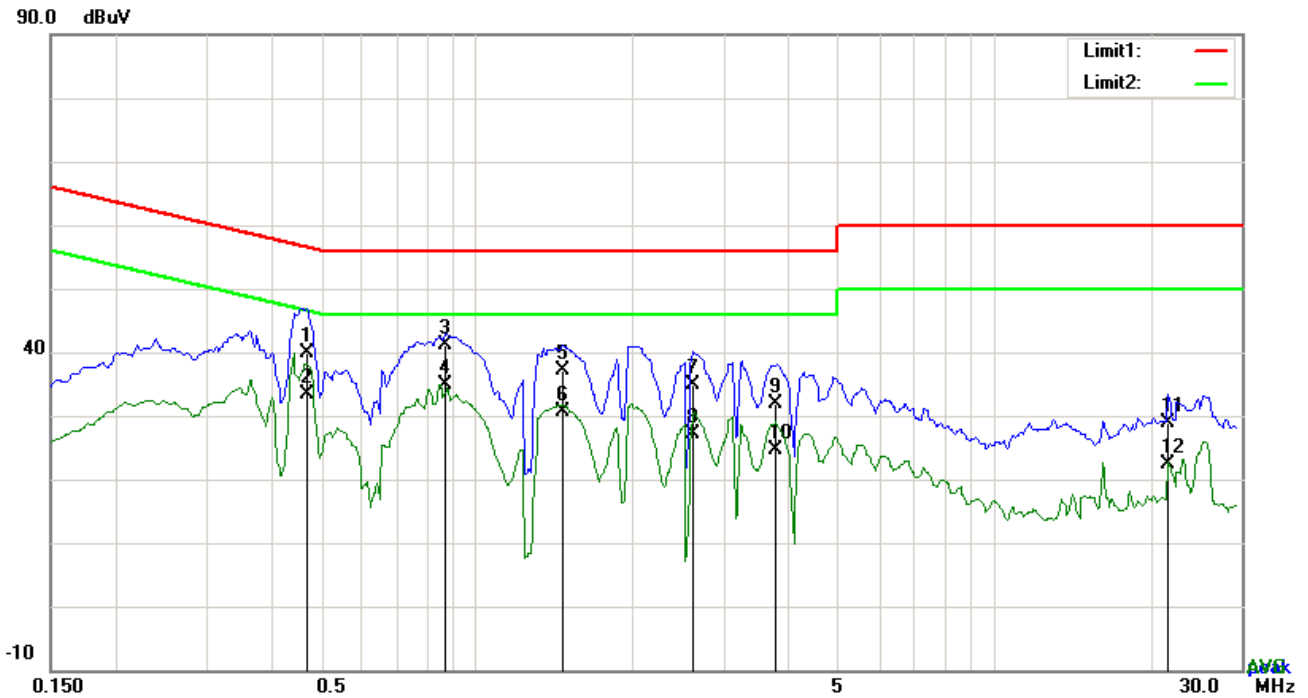

**Test Data**

**Phase Neutral Plot at 240Vac, 60Hz**

No.	P/L	Frequency (MHz)	Reading (dBμV)	Detector	Corrected (dB)	Result (dBμV)	Limit (dBμV)	Margin (dB)
1	N	0.4698	29.76	QP	10.02	39.78	56.52	-16.74
2	N	0.4698	23.28	AVG	10.02	33.30	46.52	-13.22
3	N	0.8676	31.15	QP	10.03	41.18	56.00	-14.82
4	N	0.8676	24.84	AVG	10.03	34.87	46.00	-11.13
5	N	1.4643	27.00	QP	10.03	37.03	56.00	-18.97
6	N	1.4643	20.57	AVG	10.03	30.60	46.00	-15.40
7	N	2.6187	24.81	QP	10.05	34.86	56.00	-21.14
8	N	2.6187	17.11	AVG	10.05	27.16	46.00	-18.84
9	N	3.7917	21.71	QP	10.06	31.77	56.00	-24.23
10	N	3.7917	14.45	AVG	10.06	24.51	46.00	-21.49
11	N	21.6654	18.64	QP	10.29	28.93	60.00	-31.07
12	N	21.6654	12.09	AVG	10.29	22.38	50.00	-27.62

## 6.7 Radiated Spurious Emissions & Restricted Band

Temperature	23°C
Relative Humidity	58%
Atmospheric Pressure	1006mbar
Test date :	June 06, 2016
Tested By :	Loren Luo

### Requirement(s):

Spec	Item	Requirement	Applicable										
47CFR§15.247(d), RSS210 (A8.5)	a)	<p>Except higher limit as specified elsewhere in other section, the emissions from the low-power radio-frequency devices shall not exceed the field strength levels specified in the following table and the level of any unwanted emissions shall not exceed the level of the fundamental emission. The tighter limit applies at the band edges</p> <table border="1"> <thead> <tr> <th>Frequency range (MHz)</th> <th>Field Strength (µV/m)</th> </tr> </thead> <tbody> <tr> <td>30 – 88</td> <td>100</td> </tr> <tr> <td>88 – 216</td> <td>150</td> </tr> <tr> <td>216 960</td> <td>200</td> </tr> <tr> <td>Above 960</td> <td>500</td> </tr> </tbody> </table>	Frequency range (MHz)	Field Strength (µV/m)	30 – 88	100	88 – 216	150	216 960	200	Above 960	500	<input checked="" type="checkbox"/>
	Frequency range (MHz)	Field Strength (µV/m)											
	30 – 88	100											
88 – 216	150												
216 960	200												
Above 960	500												
b)	<p>For non-restricted band, In any 100 kHz bandwidth outside the frequency band in which the spread spectrum or digitally modulated intentional radiator is operating, the radio frequency power that is produced by the intentional radiator shall be at least 20 dB or 30dB below that in the 100 kHz bandwidth within the band that contains the highest level of the desired power, determined by the measurement method on output power to be used. Attenuation below the general limits specified in § 15.209(a) is not required</p> <p><input checked="" type="checkbox"/> 20 dB down      <input type="checkbox"/> 30 dB down</p>	<input checked="" type="checkbox"/>											
c)	<p>or restricted band, emission must also comply with the radiated emission limits specified in 15.209</p>	<input checked="" type="checkbox"/>											

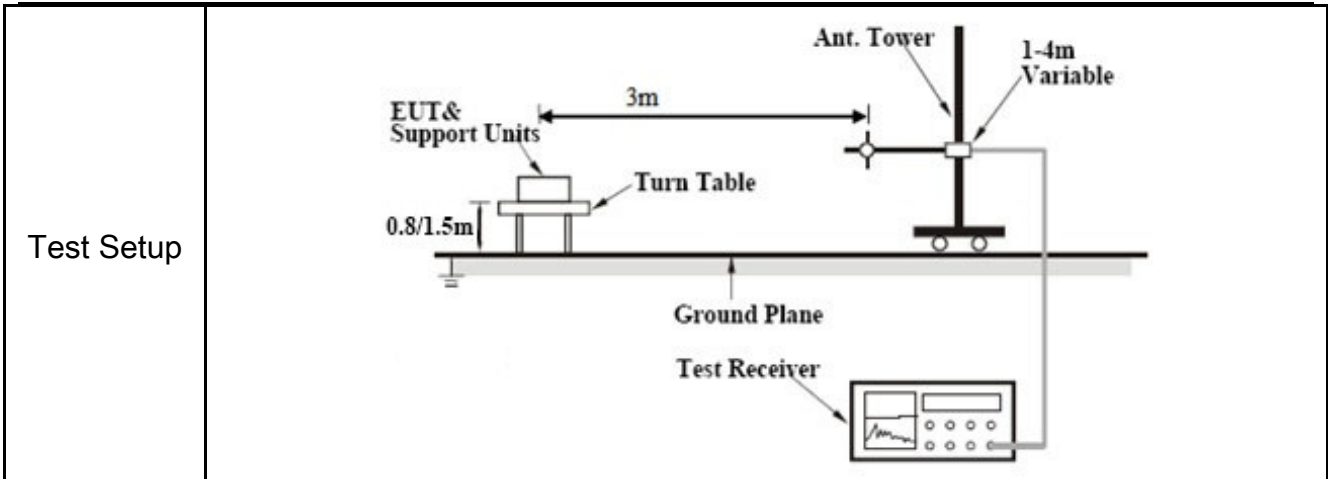

- Procedure**
- The EUT was switched on and allowed to warm up to its normal operating condition.
  - The test was carried out at the selected frequency points obtained from the EUT characterization. Maximization of the emissions, was carried out by rotating the EUT, changing the antenna polarization, and adjusting the antenna height in the following manner:
    - Vertical or horizontal polarization (whichever gave the higher emission level over a full rotation of the EUT) was chosen.
    - The EUT was then rotated to the direction that gave the maximum emission.
    - Finally, the antenna height was adjusted to the height that gave the maximum emission.
  - The resolution bandwidth and video bandwidth of test receiver/spectrum analyzer is 120 kHz for Quasiy Peak detection at frequency below 1GHz.
  - The resolution bandwidth of test receiver/spectrum analyzer is 1MHz and video bandwidth is 3MHz with Peak detection for Peak measurement at frequency above 1GHz.  
 The resolution bandwidth of test receiver/spectrum analyzer is 1MHz and the video bandwidth is 10Hz with Peak detection for Average Measurement as below at frequency above 1GHz.
  - Steps 2 and 3 were repeated for the next frequency point, until all selected frequency points were measured.

**Remark** Different RF configuration has been evaluated but not much difference was found. The data presented here is the worst case data with EUT under 802.11n – HT20-2437MHz mode.

**Result**  Pass  Fail

**Test Data**  Yes  N/A

**Test Plot**  Yes (See below)  N/A

<b>Test Mode:</b>	<b>Transmitting Mode</b>
-------------------	--------------------------

**Below 1GHz**

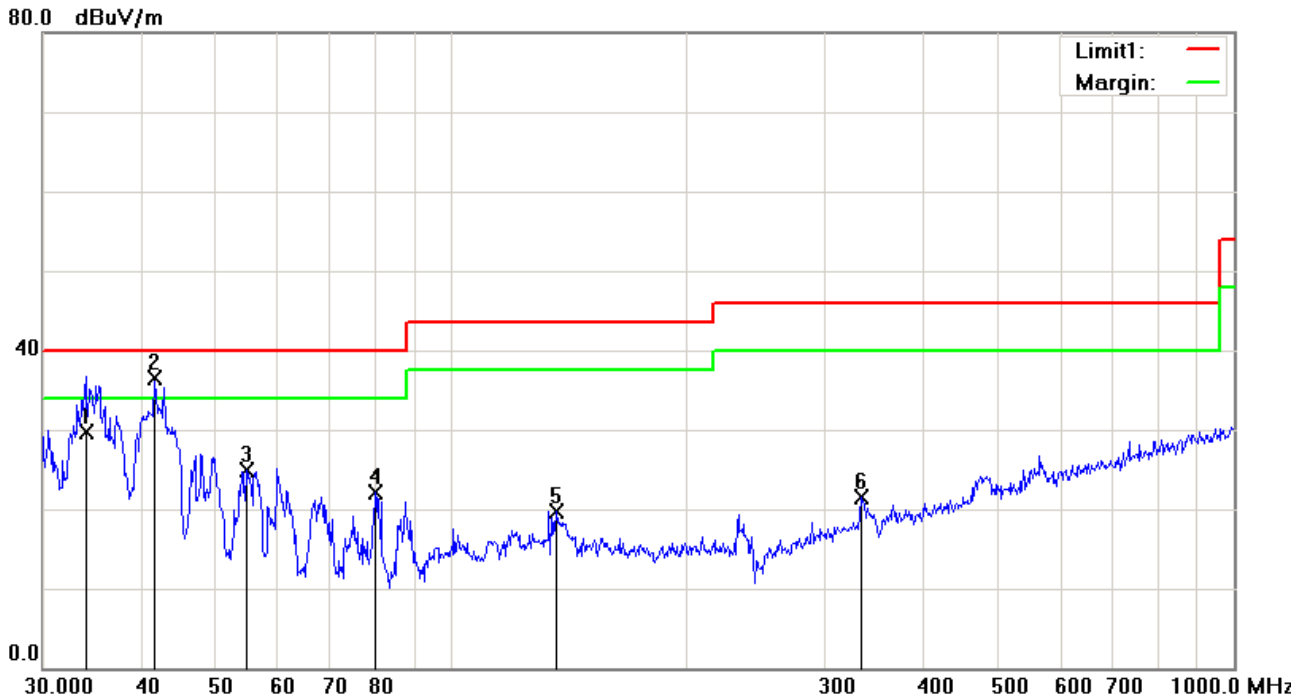

*Test Data*

**Vertical Polarity Plot @3m**

No	P/L	Frequency (MHz)	Reading (dBμV)	Detector	Corrected (dB)	Result (dBμV)	Limit (dBμV)	Margin (dB)	Height	Degree
1	V	34.0365	32.87	QP	-3.24	29.63	40.00	-10.37	100	346
2	V	41.7130	45.20	QP	-8.73	36.47	40.00	-3.53	100	24
3	V	54.6429	38.56	peak	-13.72	24.84	40.00	-15.16	100	54
4	V	79.8003	35.86	peak	-13.77	22.09	40.00	-17.91	100	317
5	V	135.9822	28.03	peak	-8.30	19.73	43.50	-23.77	100	179
6	V	333.6867	27.42	peak	-5.93	21.49	46.00	-24.51	100	62

**Below 1GHz**

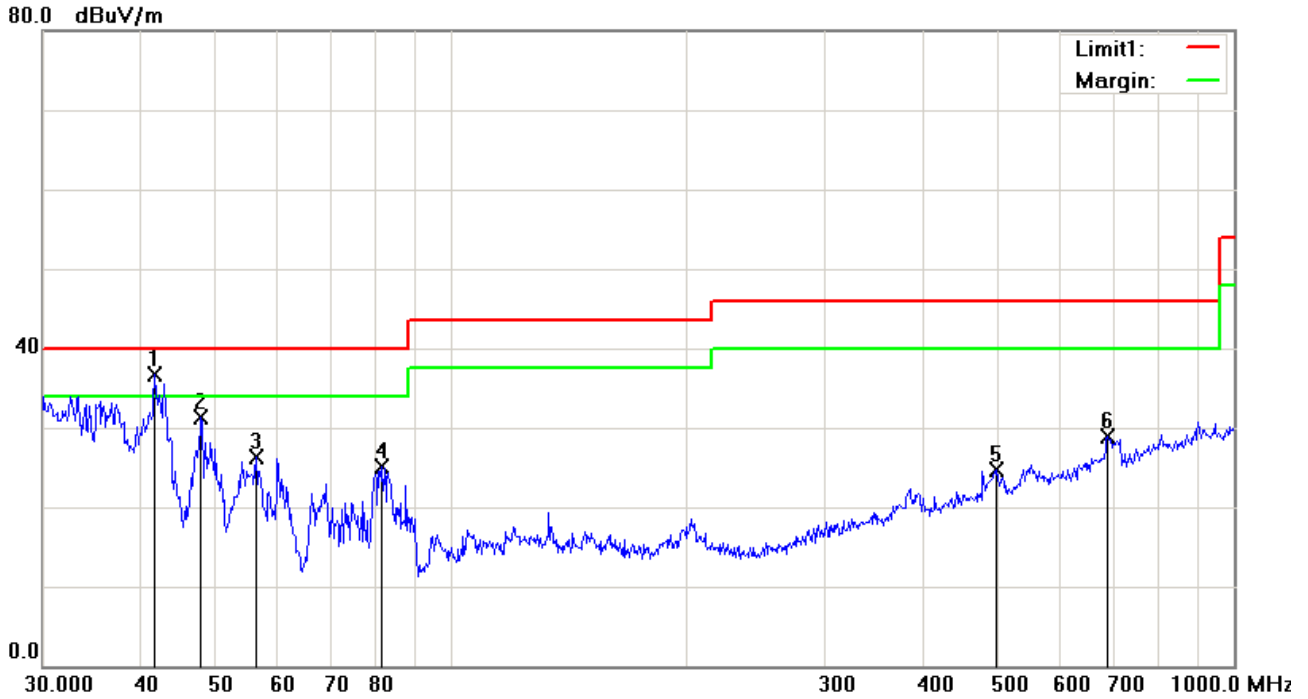

**Test Data**

**Horizontal Polarity Plot @3m**

No	P/L	Frequency (MHz)	Reading (dBμV)	Detector	Corrected (dB)	Result (dBμV)	Limit (dBμV)	Margin (dB)	Height	Degree
1	H	41.7130	45.40	QP	-8.73	36.67	40.00	-3.33	100	289
2	H	47.8260	43.59	peak	-12.20	31.39	40.00	-8.61	100	214
3	H	56.1974	40.25	peak	-13.91	26.34	40.00	-13.66	100	156
4	H	81.2117	38.80	peak	-13.71	25.09	40.00	-14.91	100	80
5	H	497.6765	26.37	peak	-1.75	24.62	46.00	-21.38	100	151
6	H	689.5644	27.62	peak	1.27	28.89	46.00	-17.11	100	255

### Above 1GHz

<b>Test Mode:</b>	<b>Transmitting Mode</b>
-------------------	--------------------------

#### Low Channel (2402 MHz)

Frequency (MHz)	S.A. Reading (dB $\mu$ V)	Detector (PK/AV)	Polarity (H/V)	Ant. Factor (dB/m)	Cable Loss (dB)	Pre-Amp. Gain (dB)	Cord. Amp. (dB $\mu$ V/m)	Limit (dB $\mu$ V/m)	Margin (dB)
4804	38.85	AV	V	33.83	6.86	31.72	47.82	54	-6.18
4804	38.41	AV	H	33.83	6.86	31.72	47.38	54	-6.62
4804	48.29	PK	V	33.83	6.86	31.72	57.26	74	-16.74
4804	47.83	PK	H	33.83	6.86	31.72	56.8	74	-17.2
17793	24.53	AV	V	44.45	10.27	31.28	47.97	54	-6.03
17793	24.29	AV	H	44.45	10.27	31.28	47.73	54	-6.27
17793	34.91	PK	V	44.45	10.27	31.28	58.35	74	-15.65
17793	34.65	PK	H	44.45	10.27	31.28	58.09	74	-15.91

#### Middle Channel (2440 MHz)

Frequency (MHz)	S.A. Reading (dB $\mu$ V)	Detector (PK/AV)	Polarity (H/V)	Ant. Factor (dB/m)	Cable Loss (dB)	Pre-Amp. Gain (dB)	Cord. Amp. (dB $\mu$ V/m)	Limit (dB $\mu$ V/m)	Margin (dB)
4880	38.93	AV	V	33.86	6.82	31.82	47.79	54	-6.21
4880	38.55	AV	H	33.86	6.82	31.82	47.41	54	-6.59
4880	48.36	PK	V	33.86	6.82	31.82	57.22	74	-16.78
4880	47.92	PK	H	33.86	6.82	31.82	56.78	74	-17.22
17807	24.16	AV	V	44.45	10.29	31.3	47.6	54	-6.4
17807	24.02	AV	H	44.45	10.29	31.3	47.46	54	-6.54
17807	35.25	PK	V	44.45	10.29	31.3	58.69	74	-15.31
17807	34.79	PK	H	44.45	10.29	31.3	58.23	74	-15.77

### High Channel (2480 MHz)

Frequency (MHz)	S.A. Reading (dB $\mu$ V)	Detector (PK/AV)	Polarity (H/V)	Ant. Factor (dB/m)	Cable Loss (dB)	Pre-Amp. Gain (dB)	Cord. Amp. (dB $\mu$ V/m)	Limit (dB $\mu$ V/m)	Margin (dB)
4960	38.67	AV	V	33.9	6.76	31.92	47.41	54	-6.59
4960	38.52	AV	H	33.9	6.76	31.92	47.26	54	-6.74
4960	48.33	PK	V	33.9	6.76	31.92	57.07	74	-16.93
4960	47.98	PK	H	33.9	6.76	31.92	56.72	74	-17.28
17797	24.72	AV	V	44.45	10.27	31.28	48.16	54	-5.84
17797	24.48	AV	H	44.45	10.27	31.28	47.92	54	-6.08
17797	35.36	PK	V	44.45	10.27	31.28	58.8	74	-15.2
17797	35.09	PK	H	44.45	10.27	31.28	58.53	74	-15.47

**Note:**

- 1, The testing has been conformed to 10\*2480MHz=24,800MHz
- 2, All other emissions more than 30 dB below the limit
- 3, X-Axis, Y-Axis and Z-Axis were investigated. The results above show only the worst case.

## Annex A. TEST INSTRUMENT

Instrument	Model	Serial #	Cal Date	Cal Due	In use
<b>AC Line Conducted</b>					
EMI test receiver	ESCS30	8471241027	09/17/2015	09/16/2016	<input checked="" type="checkbox"/>
Line Impedance	LI-125A	191106	09/25/2015	09/24/2016	<input checked="" type="checkbox"/>
Line Impedance	LI-125A	191107	09/25/2015	09/24/2016	<input checked="" type="checkbox"/>
LISN	ISN T800	34373	09/25/2015	09/24/2016	<input checked="" type="checkbox"/>
Double Ridge Horn Antenna (1 ~18GHz)	AH-118	71283	09/24/2015	09/23/2016	<input checked="" type="checkbox"/>
Transient Limiter	LIT-153	531118	09/01/2015	08/31/2016	<input checked="" type="checkbox"/>
<b>RF conducted test</b>					
Agilent ESA-E SERIES	E4407B	MY45108319	09/17/2015	09/16/2016	<input checked="" type="checkbox"/>
Power Splitter	1#	1#	09/01/2015	08/31/2016	<input checked="" type="checkbox"/>
DC Power Supply	E3640A	MY40004013	09/17/2015	09/16/2016	<input checked="" type="checkbox"/>
<b>Radiated Emissions</b>					
EMI test receiver	ESL6	100262	09/17/2015	09/16/2016	<input checked="" type="checkbox"/>
Positioning Controller	UC3000	MF780208282	11/19/2015	11/18/2016	<input checked="" type="checkbox"/>
OPT 010 AMPLIFIER (0.1-1300MHz)	8447E	2727A02430	09/01/2015	08/31/2016	<input checked="" type="checkbox"/>
Microwave Preamplifier (1 ~ 26.5GHz)	8449B	3008A02402	03/24/2016	03/23/2017	<input checked="" type="checkbox"/>
Bilog Antenna (30MHz~6GHz)	JB6	A110712	09/21/2015	09/20/2016	<input checked="" type="checkbox"/>
Double Ridge Horn Antenna (1 ~18GHz)	AH-118	71283	09/24/2015	09/23/2016	<input checked="" type="checkbox"/>
Universal Radio Communication Tester	CMU200	121393	09/25/2015	09/24/2016	<input checked="" type="checkbox"/>

## Annex B. EUT And Test Setup Photographs

### Annex B.i. Photograph: EUT External Photo



Whole Package View



Adapter - Front View



EUT - Front View



EUT - Rear View

Test Report No.	16070595-FCC-R4
Page	34 of 43



EUT - Top View



EUT - Bottom View

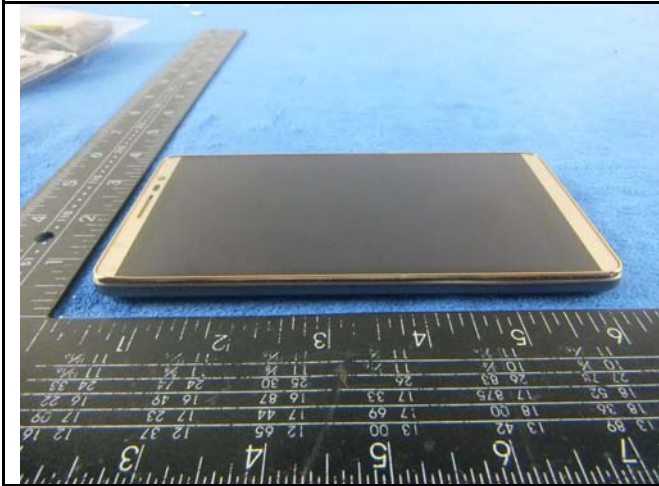

EUT - Left View

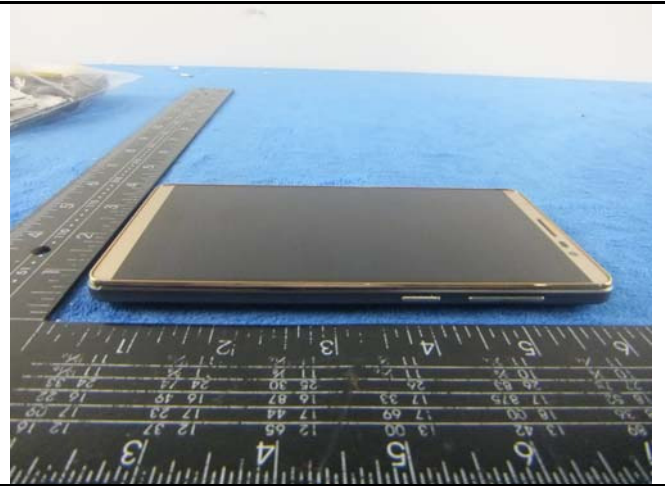

EUT - Right View

**Annex B.ii. Photograph: EUT Internal Photo**



Cover Off - Top View 1



Battery - Front View



Battery - Rear View

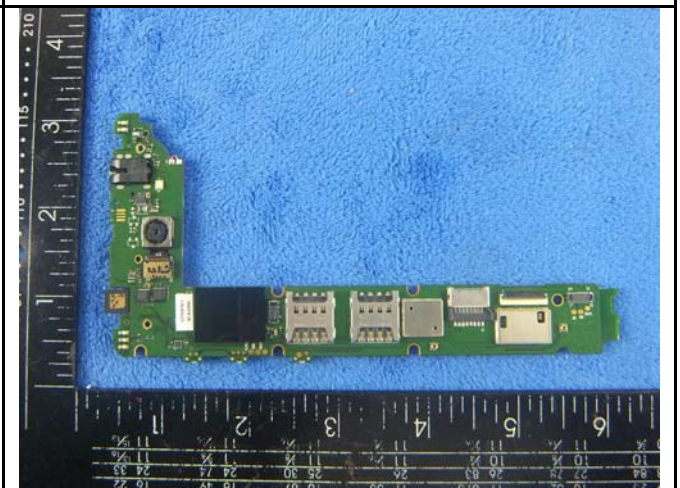

Mainboard with Shielding - Front View

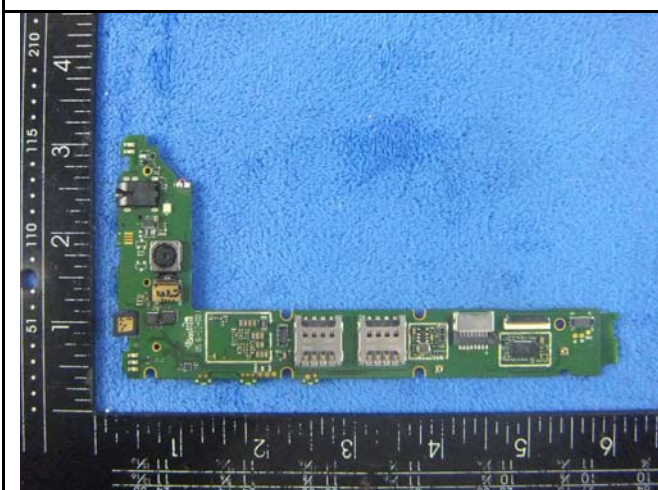

Mainboard without Shielding - Front View

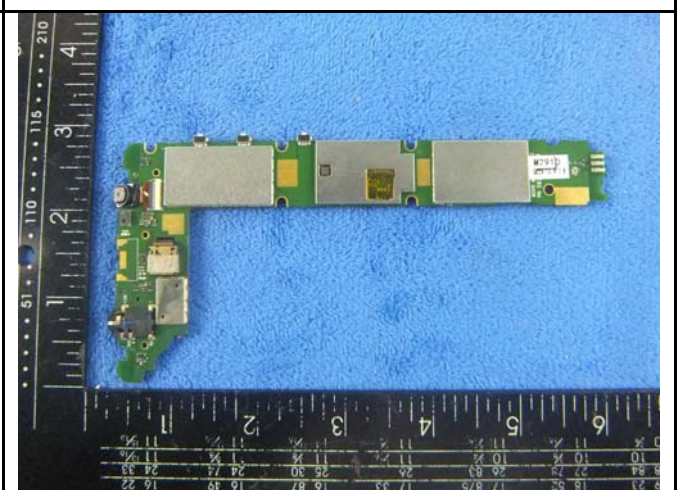

Mainboard - Rear View

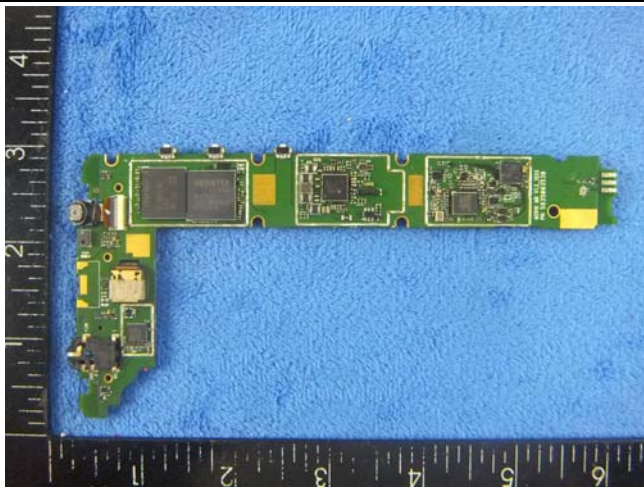

LCD – Front View



LCD – Rear View

GSM/PCS/UMTS-FDD Antenna View



LTE - Antenna View

WIFI/BT/BLE/GPS - Antenna View

**Annex B.iii. Photograph: Test Setup Photo**



Conducted Emissions Test Setup Front View



Conducted Emissions Test Setup Side View

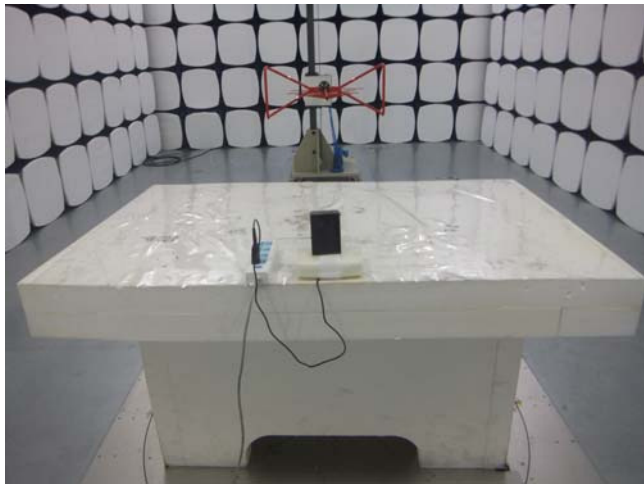

Radiated Spurious Emissions Test Setup Below 1GHz

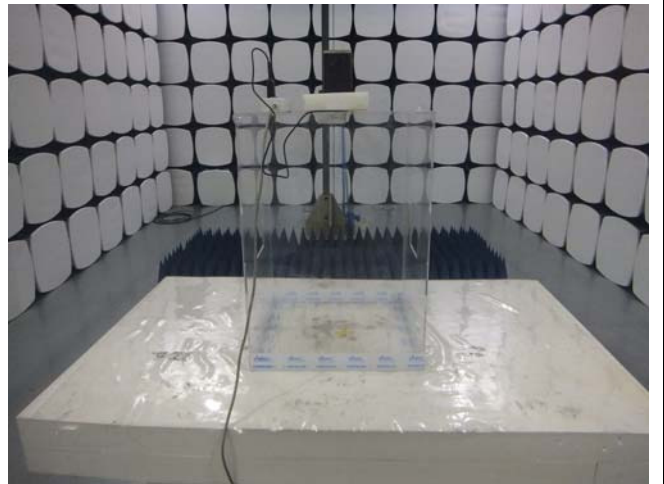

Radiated Spurious Emissions Test Setup Above 1GHz

## Annex C. TEST SETUP AND SUPPORTING EQUIPMENT

### Annex C.ii. TEST SET UP BLOCK

#### Block Configuration Diagram for AC Line Conducted Emissions

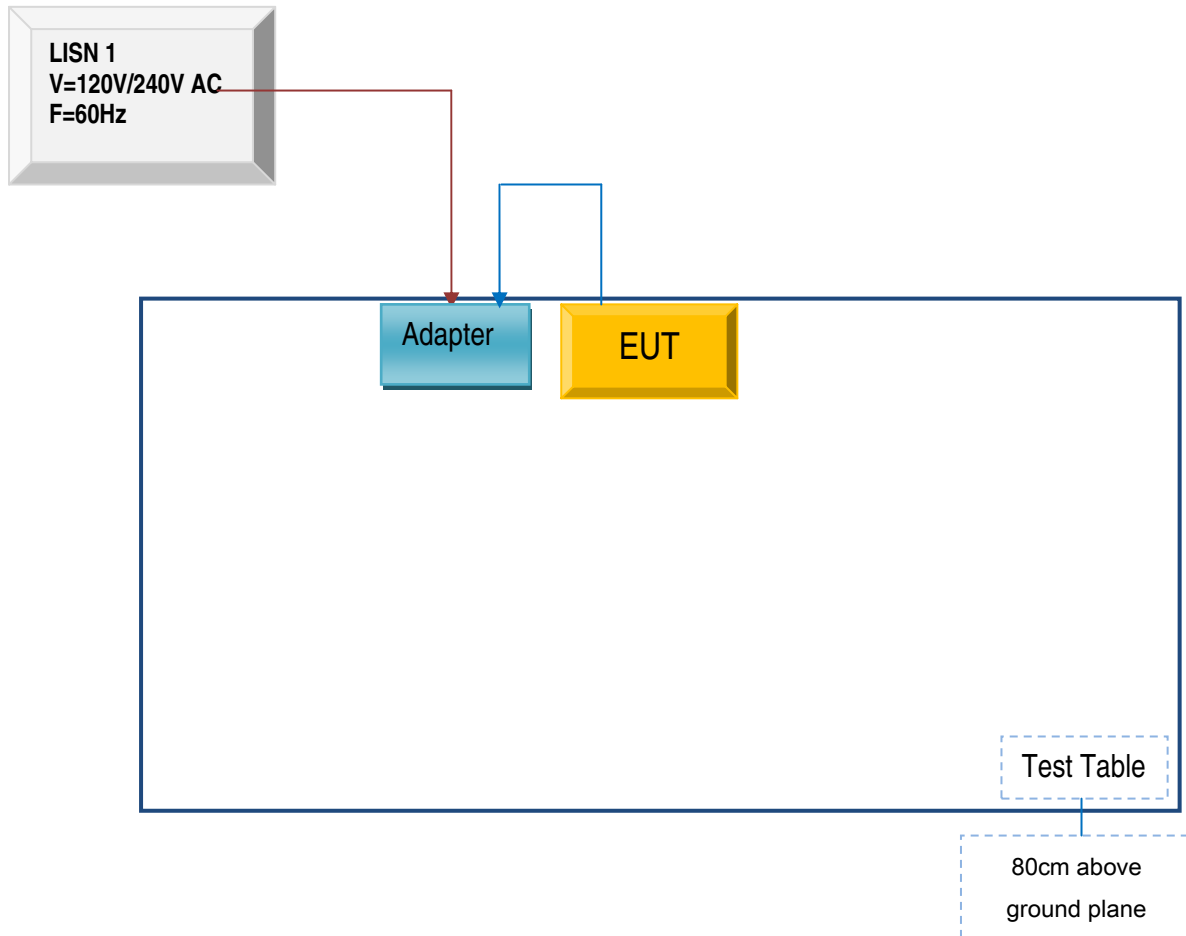

**Block Configuration Diagram for Radiated Emissions ( Below 1GHz ) .**

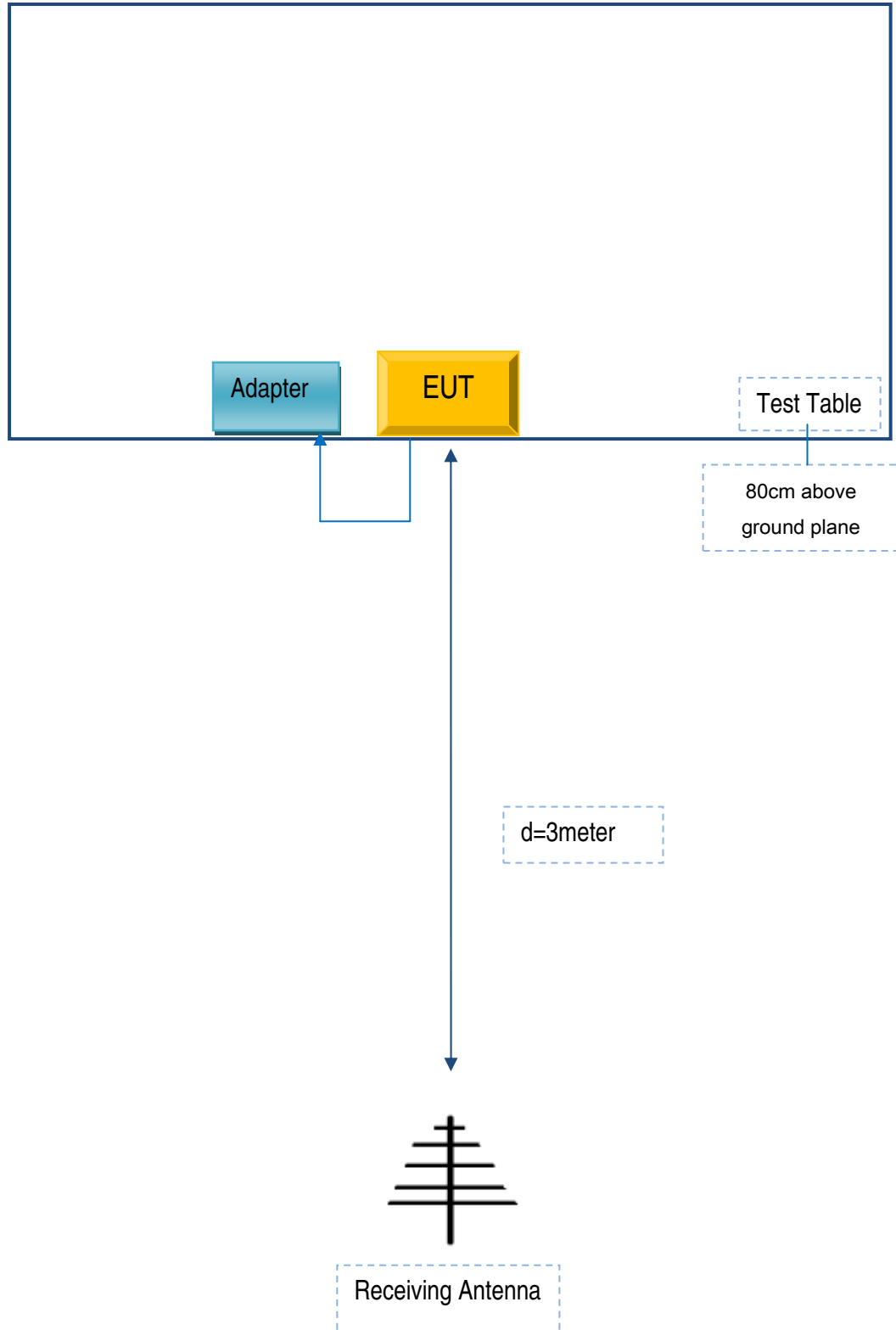

**Block Configuration Diagram for Radiated Emissions ( Above 1GHz ) .**

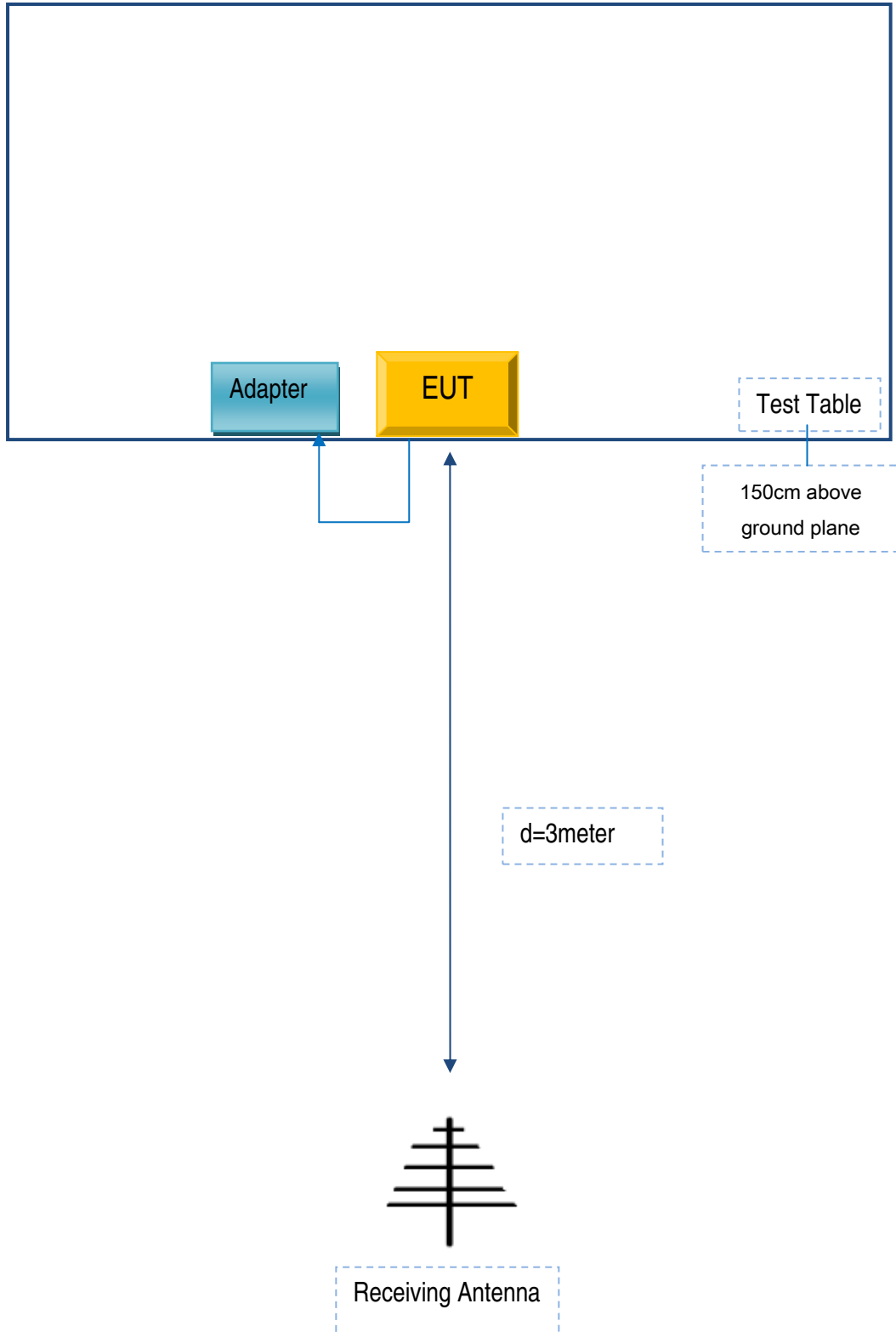

## Annex C. ii. SUPPORTING EQUIPMENT DESCRIPTION

The following is a description of supporting equipment and details of cables used with the EUT.

### Supporting Equipment:

Manufacturer	Equipment Description	Model	Serial No
Shenzhen Konka Telecommunications Technology Co., Ltd.	Adapter	HJ-050100-AR	HJ16C1C00004

### Supporting Cable:

Cable type	Shield Type	Ferrite Core	Length	Serial No
USB Cable	Un-shielding	No	0.8m	HJ16C1C00004

Test Report No.	16070595-FCC-R4
Page	42 of 43

**Annex D. User Manual / Block Diagram / Schematics / Partlist**

**See attachment**

Test Report No.	16070595-FCC-R4
Page	43 of 43

## Annex E. DECLARATION OF SIMILARITY

N/A