

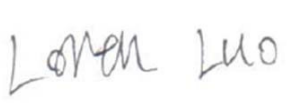

RF TEST REPORT

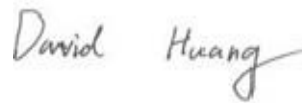

Report No.: 16070595-FCC-R5

Supersede Report No.: N/A

Applicant	Shenzhen Konka Telecommunications Technology Co., Ltd.	
Product Name	Smart Phone	
Model No.	AD570	
Serial No.	N/A	
Test Standard	FCC Part 27: 2015; ANSI/TIA-603-D: 2010	
Test Date	May 26 to June 06, 2016	
Issue Date	June 07, 2016	
Test Result	<input checked="" type="checkbox"/> Pass <input type="checkbox"/> Fail	
Equipment complied with the specification	<input checked="" type="checkbox"/>	
Equipment did not comply with the specification	<input type="checkbox"/>	
		
Loren Luo Test Engineer	David Huang Checked By	
This test report may be reproduced in full only Test result presented in this test report is applicable to the tested sample only		

Issued by:

SIEMIC (SHENZHEN-CHINA) LABORATORIES

Zone A, Floor 1, Building 2 Wan Ye Long Technology Park

South Side of Zhoushi Road, Bao' an District, Shenzhen, Guangdong China 518108

Phone: +86 0755 2601 4629801 Email: China@siemic.com.cn

Laboratories Introduction

SIEMIC, headquartered in the heart of Silicon Valley, with superior facilities in US and Asia, is one of the leading independent testing and certification facilities providing customers with one-stop shop services for Compliance Testing and Global Certifications.



In addition to testing and certification, SIEMIC provides initial design reviews and compliance management throughout a project. Our extensive experience with China, Asia Pacific, North America, European, and International compliance requirements, assures the fastest, most cost effective way to attain regulatory compliance for the global markets.

Accreditations for Conformity Assessment

Country/Region	Scope
USA	EMC, RF/Wireless, SAR, Telecom
Canada	EMC, RF/Wireless, SAR, Telecom
Taiwan	EMC, RF, Telecom, SAR, Safety
Hong Kong	RF/Wireless, SAR, Telecom
Australia	EMC, RF, Telecom, SAR, Safety
Korea	EMI, EMS, RF, SAR, Telecom, Safety
Japan	EMI, RF/Wireless, SAR, Telecom
Singapore	EMC, RF, SAR, Telecom
Europe	EMC, RF, SAR, Telecom, Safety

Test Report	16070595-FCC-R5
Page	3 of 60

This page has been left blank intentionally.

CONTENTS

1. REPORT REVISION HISTORY	5
2. CUSTOMER INFORMATION	5
3. TEST SITE INFORMATION.....	5
4. EQUIPMENT UNDER TEST (EUT) INFORMATION.....	6
5. TEST SUMMARY	8
6. MEASUREMENTS, EXAMINATION AND DERIVED RESULTS	9
6.1 RF EXPOSURE (SAR).....	9
6.2 RF OUTPUT POWER.....	10
6.3 PEAK-AVERAGE RATIO.....	21
6.4 OCCUPIED BANDWIDTH.....	24
6.5 SPURIOUS EMISSIONS AT ANTENNA TERMINALS.....	33
6.6 SPURIOUS RADIATED EMISSIONS.....	35
6.7 BAND EDGE.....	38
6.8 BAND EDGE 27.53(M).....	45
6.9 FREQUENCY STABILITY	46
ANNEX A. TEST INSTRUMENT.....	49
ANNEX B. EUT AND TEST SETUP PHOTOGRAPHS.....	51
ANNEX C. TEST SETUP AND SUPPORTING EQUIPMENT.....	56
ANNEX C.II. EUT OPERATING CONKITIONS.....	58
ANNEX D. USER MANUAL / BLOCK DIAGRAM / SCHEMATICS / PARTLIST.....	59
ANNEX E. DECLARATION OF SIMILARITY.....	60

1. Report Revision History

Report No.	Report Version	Description	Issue Date
16070595-FCC-R5	NONE	Original	June 07, 2016

2. Customer information

Applicant Name	Shenzhen Konka Telecommunications Technology Co., Ltd.
Applicant Add	No.9008 Shennan Road,Overseas Chinese Town, ShenZhen, Guangdong,China
Manufacturer	Shenzhen Konka Telecommunications Technology Co., Ltd.
Manufacturer Add	No.9008 Shennan Road,Overseas Chinese Town, ShenZhen, Guangdong,China

3. Test site information

Lab performing tests	SIEMIC (Shenzhen-China) LABORATORIES
Lab Address	Zone A, Floor 1, Building 2 Wan Ye Long Technology Park South Side of Zhoushi Road, Bao' an District, Shenzhen, Guangdong China 518108
FCC Test Site No.	718246
IC Test Site No.	4842E-1
Test Software	Radiated Emission Program-To Shenzhen v2.0

4. Equipment under Test (EUT) Information

Description of EUT:	Smart Phone
Main Model:	AD570
Serial Model:	N/A
Date EUT received:	May 25, 2016
Test Date(s):	May 26 to June 06, 2016
Equipment Category :	PCE
Antenna Gain:	GSM850: -0.11dBi PCS1900: 0.92dBi UMTS-FDD Band 5: -0.05dBi UMTS-FDD Band 2: 0.81dBi LTE Band 4: 0.81dBi Bluetooth/BLE/WIFI: 1.36dBi GPS: 1.36dBi
Type of Modulation:	GSM / GPRS: GMSK EGPRS: GMSK,8PSK UMTS-FDD: QPSK LTE Band: QPSK, 16QAM 802.11b/g/n: DSSS, OFDM Bluetooth: GFSK, π /4DQPSK, 8DPSK BLE: GFSK GPS:BPSK

GSM850 TX: 824.2 ~ 848.8 MHz; RX: 869.2 ~ 893.8 MHz
 PCS1900 TX: 1850.2 ~ 1909.8 MHz; RX: 1930.2 ~ 1989.8 MHz
 UMTS-FDD Band 5 TX: 826.4 ~ 846.6 MHz; RX: 871.4 ~ 891.6 MHz
 UMTS-FDD Band 2 TX: 1852.4 ~ 1907.6 MHz;
 RX: 1932.4 ~ 1987.6 MHz
 RF Operating Frequency (ies):
 LTE Band 4 TX: 1712.5 ~ 1752.5 MHz; RX : 2112.5 ~ 2152.5 MHz
 WIFI: 802.11b/g/n(20M): 2412-2462 MHz
 WIFI: 802.11n(40M): 2422-2452 MHz
 Bluetooth& BLE: 2402-2480 MHz
 GPS: 1575.42 MHz

Maximum Conducted
 AV Power to Antenna: LTE Band 4: 23.23 dBm

ERP/EIRP: LTE Band 4: 23.92 dBm / EIRP

Port: Power Port, Earphone Port, USB Port

Adapter:
 Model: HJ-050100-AR
 Input: AC 100-240V~50/60Hz;0.15A
 Output: DC 5.0V,1A

Input Power: Potencia: 5W
 Battery:
 Model: KLB270P350
 Spec: 3.8V,2700mAh(10.26Wh)
 Charge limited voltage: 4.35V

Trade Name : ADMIRAL

GPRS/EGPRS Multi-slot class 8/10/12

FCC ID: UT3AD570

5. Test Summary

The product was tested in accordance with the following specifications.

All testing has been performed according to below product classification:

FCC Rules	Description of Test	Result
§ 1.1307; § 2.1093	RF Exposure (SAR)	Compliance
§2.1046; § 22.913(a); § 24.232(c); § 27.50(c.10); § 27.50(d.4)	RF Output Power	Compliance
§ 24.232 (d); § 27.50(d)	Peak-Average Ratio	Compliance
§ 2.1047	Modulation Characteristics	N/A
§ 2.1049; § 22.905; § 22.917; § 24.238; § 27.53(a.5)	99% & -26 dB Occupied Bandwidth	Compliance
§ 2.1051; § 22.917(a); § 24.238(a); § 27.53(h)	Spurious Emissions at Antenna Terminal	Compliance
§ 2.1053; § 22.917(a); § 24.238(a); § 27.53(h)	Field Strength of Spurious Radiation	Compliance
§ 22.917(a); § 24.238(a); § 27.53(m)	Out of band emission, Band Edge Band Edge 27.53(m)	Compliance N/A
§ 2.1055; § 22.355; § 24.235; § 27.5(h); § 27.54	Frequency stability vs. temperature Frequency stability vs. voltage	Compliance

Note: Testing was performed by configuring EUT to maximum output power status, the declared output power class for different

Measurement Uncertainty

Emissions		
Test Item	Description	Uncertainty
Band Edge and Radiated Spurious Emissions	Confidence level of approximately 95% (in the case where distributions are normal), with a coverage factor of 2 (for EUTs < 0.5m X 0.5m X 0.5m)	+5.6dB/-4.5dB
-	-	-

6. MEASUREMENTS, EXAMINATION AND DERIVED RESULTS

6.1 RF Exposure (SAR)

Test Result: Pass

The EUT is a portable device, thus requires SAR evaluation;

Please refer to RF Exposure Evaluation Report: 16070595-FCC-H.

6.2 RF Output Power

Temperature	25°C
Relative Humidity	54%
Atmospheric Pressure	1002mbar
Test date :	June 02, 2016
Tested By :	Loren Luo

Requirement(s):

Spec	Item	Requirement	Applicable
§22.913 (a)	a)	ERP:38.45dBm	<input checked="" type="checkbox"/>
§24.232 (c)	b)	EIRP:33dBm	<input checked="" type="checkbox"/>
§27.50 (c)	c)	EIRP: 30dBm	<input checked="" type="checkbox"/>

Test Setup

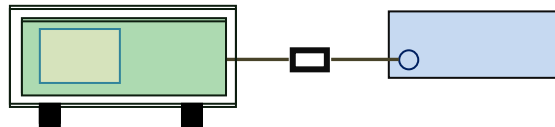

Test Procedure

For Conducted Power:

- The transmitter output port was connected to base station.
- Set EUT at maximum power through base station.
- Select lowest, middle, and highest channels for each band and different test mode.

For ERP/EIRP:

- The transmitter was placed on a wooden turntable, and it was transmitting into a non-radiating load which was also placed on the turntable.
- The measurement antenna was placed at a distance of 3 meters from the EUT. During the tests, the antenna height and polarization as well as EUT azimuth were varied in order to identify the maximum level of emissions from the EUT. The test was performed by placing the EUT on 3-orthogonal axis.
- The frequency range up to tenth harmonic of the fundamental frequency was investigated.

Test Report	16070595-FCC-R5
Page	11 of 60

	<ul style="list-style-type: none"> - Remove the EUT and replace it with substitution antenna. A signal generator was connected to the substitution antenna by a non-radiating cable. The absolute levels of the spurious emissions were measured by the substitution. - Spurious emissions in dB = 10 log (TX power in Watts/0.001) – the absolute level - Spurious attenuation limit in dB = 43 + 10 Log10 (power out in Watts).
Remark	
Result	<input checked="" type="checkbox"/> Pass <input type="checkbox"/> Fail

Test Data Yes N/A
Test Plot Yes (See below) N/A

Conducted Power

LTE Band 4:

BW (MHz)	Ch	Freq. (MHz)	Mode	UL RB Allocation	UL RB Offset	MPR	Average power (dBm)	Tune up Power tolerant
20MHz	20050	1720.0	QPSK	1	0	0	23.23	23±1
				1	49	0	23.20	23±1
				1	99	0	23.19	23±1
				50	0	1	22.59	23±1
				50	24	1	22.54	23±1
				50	49	1	22.53	23±1
			100	0	1	22.63	23±1	
			16QAM	1	0	1	22.52	22±1
				1	49	1	22.51	22±1
				1	99	1	22.13	22±1
				50	0	2	21.56	22±1
				50	24	2	21.51	22±1
				50	49	2	21.58	22±1
				100	0	2	21.17	22±1
	20175	1732.5		QPSK	1	0	0	22.67
			1		49	0	22.69	22.5±1
			1		99	0	22.71	22.5±1
			50		0	1	22.57	22.5±1
			50		24	1	22.68	22.5±1
			50		49	1	22.60	22.5±1
			100	0	1	22.60	22.5±1	
			16QAM	1	0	1	21.57	22±1
				1	49	1	21.63	22±1
				1	99	1	21.73	22±1
				50	0	2	21.25	22±1
				50	24	2	21.26	22±1
				50	49	2	21.24	22±1
				100	0	2	21.05	22±1
	20300	1745.0		QPSK	1	0	0	22.50
			1		49	0	22.51	22±1
1			99		0	22.53	22±1	
50			0		1	21.61	22±1	
50			24		1	21.53	22±1	
50			49		1	21.62	22±1	
100			0	1	21.59	22±1		
16QAM			1	0	1	21.81	21.5±1	
			1	49	1	21.81	21.5±1	
			1	99	1	21.85	21.5±1	
			50	0	2	21.57	21.5±1	
			50	24	2	21.53	21.5±1	
			50	49	2	21.56	21.5±1	
			100	0	2	21.19	21.5±1	

BW (MHz)	Ch	Freq. (MHz)	Mode	UL RB Allocation	UL RB Offset	MPR	Average power (dBm)	Tune up Power tolerant
15MHz	20025	1717.5	QPSK	1	0	0	23.14	22.5 ± 1
				1	37	0	23.06	22.5 ± 1
				1	74	0	22.98	22.5 ± 1
				36	0	1	22.09	22.5 ± 1
				36	16	1	22.06	22.5 ± 1
				36	35	1	22.04	22.5 ± 1
				75	0	1	22.00	22.5 ± 1
			16QAM	1	0	1	22.64	22 ± 1
				1	37	1	22.38	22 ± 1
				1	74	1	22.18	22 ± 1
				36	0	2	21.31	22 ± 1
				36	16	2	21.38	22 ± 1
				36	35	2	21.29	22 ± 1
				75	0	2	21.20	22 ± 1
	20175	1732.5	QPSK	1	0	0	22.65	22 ± 1
				1	37	0	22.63	22 ± 1
				1	74	0	22.61	22 ± 1
				36	0	1	21.58	22 ± 1
				36	16	1	21.51	22 ± 1
				36	35	1	21.59	22 ± 1
				75	0	1	21.59	22 ± 1
			16QAM	1	0	1	21.47	21.3 ± 1
				1	37	1	21.40	21.3 ± 1
				1	74	1	21.39	21.3 ± 1
				36	0	2	21.25	21.3 ± 1
				36	16	2	21.24	21.3 ± 1
				36	35	2	21.27	21.3 ± 1
				75	0	2	20.64	21.3 ± 1
	20325	1747.5	QPSK	1	0	0	22.51	22 ± 1
				1	37	0	22.53	22 ± 1
1				74	0	22.50	22 ± 1	
36				0	1	21.69	22 ± 1	
36				16	1	21.57	22 ± 1	
36				35	1	21.62	22 ± 1	
75				0	1	21.64	22 ± 1	
16QAM			1	0	1	21.85	21.3 ± 1	
			1	37	1	21.82	21.3 ± 1	
			1	74	1	21.83	21.3 ± 1	
			36	0	2	21.59	21.3 ± 1	
			36	16	2	21.55	21.3 ± 1	
			36	35	2	21.57	21.3 ± 1	
			75	0	2	21.18	21.3 ± 1	

BW (MHz)	Ch	Freq. (MHz)	Mode	UL RB Allocation	UL RB Offset	MPR	Average power (dBm)	Tune up Power tolerant
10MHz	20000	1715.0	QPSK	1	0	0	22.45	22±1
				1	24	0	22.31	22±1
				1	49	0	22.06	22±1
				25	0	1	21.51	22±1
				25	12	1	21.47	22±1
				25	24	1	21.49	22±1
				50	0	1	21.51	22±1
			16QAM	1	0	1	21.99	21.3±1
				1	24	1	21.96	21.3±1
				1	49	1	21.97	21.3±1
				25	0	2	21.82	21.3±1
				25	12	2	21.71	21.3±1
				25	24	2	21.65	21.3±1
				50	0	2	20.55	21.3±1
	20175	1732.5	QPSK	1	0	0	22.64	22±1
				1	24	0	22.51	22±1
				1	49	0	22.55	22±1
				25	0	1	21.38	22±1
				25	12	1	21.37	22±1
				25	24	1	21.49	22±1
				50	0	1	21.51	22±1
			16QAM	1	0	1	21.54	21.3±1
				1	24	1	21.53	21.3±1
				1	49	1	21.52	21.3±1
				25	0	2	21.47	21.3±1
				25	12	2	21.36	21.3±1
				25	24	2	21.33	21.3±1
50				0	2	21.16	21.3±1	
20350	1750.0	QPSK	1	0	0	22.95	22±1	
			1	24	0	22.65	22±1	
			1	49	0	22.59	22±1	
			25	0	1	22.08	22±1	
			25	12	1	22.11	22±1	
			25	24	1	22.14	22±1	
			50	0	1	22.15	22±1	
		16QAM	1	0	1	22.12	22±1	
			1	24	1	22.11	22±1	
			1	49	1	22.09	22±1	
			25	0	2	21.26	22±1	
			25	12	2	21.23	22±1	
			25	24	2	21.29	22±1	
			50	0	2	21.20	22±1	

BW (MHz)	Ch	Freq. (MHz)	Mode	UL RB Allocation	UL RB Offset	MPR	Average power (dBm)	Tune up Power tolerant
5MHz	20000	1715.0	QPSK	1	0	0	22.36	22±1
				1	12	0	22.31	22±1
				1	24	0	22.26	22±1
				12	0	1	21.95	22±1
				12	6	1	21.94	22±1
				12	11	1	21.98	22±1
				25	0	1	21.29	22±1
			16QAM	1	0	1	21.27	21.3±1
				1	12	1	21.26	21.3±1
				1	24	1	21.24	21.3±1
				12	0	2	21.16	21.3±1
				12	6	2	21.14	21.3±1
				12	11	2	21.13	21.3±1
				25	0	2	20.35	21.3±1
	20175	1732.5	QPSK	1	0	0	22.99	22±1
				1	12	0	22.75	22±1
				1	24	0	22.59	22±1
				12	0	1	21.96	22±1
				12	6	1	21.85	22±1
				12	11	1	21.98	22±1
				25	0	1	21.93	22±1
			16QAM	1	0	1	22.30	22±1
				1	12	1	22.25	22±1
				1	24	1	22.32	22±1
				12	0	2	21.68	22±1
				12	6	2	21.64	22±1
				12	11	2	21.67	22±1
				25	0	2	21.14	22±1
20350	1750.0	QPSK	1	0	0	23.11	22.5±1	
			1	12	0	22.85	22.5±1	
			1	24	0	22.56	22.5±1	
			12	0	1	22.11	22.5±1	
			12	6	1	22.07	22.5±1	
			12	11	1	22.02	22.5±1	
			25	0	1	22.13	22.5±1	
		16QAM	1	0	1	22.19	22±1	
			1	12	1	22.16	22±1	
			1	24	1	22.13	22±1	
			12	0	2	21.69	22±1	
			12	6	2	21.67	22±1	
			12	11	2	21.59	22±1	
			25	0	2	21.23	22±1	

BW (MHz)	Ch	Freq. (MHz)	Mode	UL RB Allocation	UL RB Offset	MPR	Average power (dBm)	Tune up Power tolerant
3MHz	19965	1711.5	QPSK	1	0	0	22.03	22±1
				1	7	0	22.01	22±1
				1	14	0	22.00	22±1
				8	0	1	21.17	22±1
				8	4	1	21.40	22±1
				8	7	1	21.15	22±1
				15	0	1	21.20	22±1
			16QAM	1	0	1	21.63	21.3±1
				1	7	1	21.61	21.3±1
				1	14	1	21.55	21.3±1
				8	0	2	20.34	21.3±1
				8	4	2	20.33	21.3±1
				8	7	2	20.34	21.3±1
				15	0	2	20.41	21.3±1
	20175	1732.5	QPSK	1	0	0	22.48	22±1
				1	7	0	22.45	22±1
				1	14	0	22.44	22±1
				8	0	1	21.41	22±1
				8	4	1	21.35	22±1
				8	7	1	21.40	22±1
				15	0	1	21.49	22±1
			16QAM	1	0	1	21.33	21.3±1
				1	7	1	21.30	21.3±1
				1	14	1	21.29	21.3±1
				8	0	2	20.42	21.3±1
				8	4	2	20.39	21.3±1
				8	7	2	20.41	21.3±1
				15	0	2	20.47	21.3±1
	20385	1753.5	QPSK	1	0	0	23.18	22.3±1
				1	7	0	23.14	22.3±1
1				14	0	23.09	22.3±1	
8				0	1	22.17	22.3±1	
8				4	1	22.16	22.3±1	
8				7	1	22.10	22.3±1	
15				0	1	22.17	22.3±1	
16QAM			1	0	1	22.14	21.3±1	
			1	7	1	22.12	21.3±1	
			1	14	1	22.10	21.3±1	
			8	0	2	21.08	21.3±1	
			8	4	2	21.07	21.3±1	
			8	7	2	21.01	21.3±1	
			15	0	2	21.21	21.3±1	

BW (MHz)	Ch	Freq. (MHz)	Mode	UL RB Allocation	UL RB Offset	MPR	Average power (dBm)	Tune up Power tolerant
1.4MHz	19957	1710.7	QPSK	1	0	0	21.18	21.3±1
				1	2	0	21.18	21.3±1
				1	5	0	21.17	21.3±1
				3	0	0	21.25	21.3±1
				3	1	0	21.24	21.3±1
				3	2	0	21.26	21.3±1
			6	0	1	20.40	21.3±1	
			16QAM	1	0	1	20.79	21.3±1
				1	2	1	20.80	21.3±1
				1	5	1	20.80	21.3±1
				3	0	1	21.48	21.3±1
				3	1	1	21.41	21.3±1
	3	2		1	20.45	21.3±1		
	20175	1732.5	QPSK	1	0	0	22.64	22±1
				1	2	0	22.65	22±1
				1	5	0	22.65	22±1
				3	0	0	22.78	22±1
				3	1	0	22.73	22±1
				3	2	0	22.71	22±1
			6	0	1	21.55	22±1	
			16QAM	1	0	1	21.49	21.3±1
				1	2	1	21.51	21.3±1
				1	5	1	21.51	21.3±1
				3	0	1	21.24	21.3±1
				3	1	1	21.25	21.3±1
	3	2		1	21.23	21.3±1		
	20393	1754.3	QPSK	1	0	0	23.10	22.3±1
				1	2	0	23.10	22.3±1
				1	5	0	23.09	22.3±1
				3	0	0	23.20	22.3±1
3				1	0	23.21	22.3±1	
3				2	0	23.12	22.3±1	
6			0	1	22.05	22.3±1		
16QAM			1	0	1	22.04	21.3±1	
			1	2	1	22.07	21.3±1	
			1	5	1	22.08	21.3±1	
			3	0	1	21.72	21.3±1	
			3	1	1	21.71	21.3±1	
	3	2	1	21.68	21.3±1			
6	0	2	21.02	21.3±1				

ERP & EIRP

EIRP for LTE Band 4 (Part 27)

Frequency (MHz)	BW (MHz)	Modulation	RB Size/Offset	Substituted level (dBm)	Antenna Polarization	Antenna Gain correction (dBi)	Cable Loss (dB)	Absolute Level (dBm)	Limit (dBm)
1710.7	1.4	QPSK	1/0	15.17	V	7.95	0.79	22.33	30
1732.5	1.4	QPSK	1/0	15.19	V	7.95	0.79	22.35	30
1754.3	1.4	QPSK	1/0	15.23	V	7.95	0.79	22.39	30
1710.7	1.4	QPSK	1/0	14.56	H	7.95	0.79	21.72	30
1732.5	1.4	QPSK	1/0	14.58	H	7.95	0.79	21.74	30
1754.3	1.4	QPSK	1/0	14.6	H	7.95	0.79	21.76	30
1710.7	1.4	16-QAM	1/5	15.32	V	7.95	0.79	22.48	30
1732.5	1.4	16-QAM	1/0	15.35	V	7.95	0.79	22.51	30
1754.3	1.4	16-QAM	1/0	15.37	V	7.95	0.79	22.53	30
1710.7	1.4	16-QAM	1/5	14.17	H	7.95	0.79	21.33	30
1732.5	1.4	16-QAM	1/0	14.19	H	7.95	0.79	21.35	30
1754.3	1.4	16-QAM	1/0	14.23	H	7.95	0.79	21.39	30
1711.5	3	QPSK	1/0	15.66	V	7.95	0.79	22.82	30
1732.5	3	QPSK	1/0	15.68	V	7.95	0.79	22.84	30
1753.5	3	QPSK	1/0	15.71	V	7.95	0.79	22.87	30
1711.5	3	QPSK	1/0	14.82	H	7.95	0.79	21.98	30
1732.5	3	QPSK	1/0	14.83	H	7.95	0.79	21.99	30
1753.5	3	QPSK	1/0	14.85	H	7.95	0.79	22.01	30
1711.5	3	16-QAM	1/0	15.28	V	7.95	0.79	22.44	30
1732.5	3	16-QAM	1/0	15.3	V	7.95	0.79	22.46	30
1753.5	3	16-QAM	1/0	15.32	V	7.95	0.79	22.48	30
1711.5	3	16-QAM	1/0	14.62	H	7.95	0.79	21.78	30
1732.5	3	16-QAM	1/0	14.65	H	7.95	0.79	21.81	30
1753.5	3	16-QAM	1/0	14.68	H	7.95	0.79	21.84	30
1712.5	5	QPSK	1/0	16.05	V	7.95	0.79	23.21	30
1732.5	5	QPSK	1/0	16.07	V	7.95	0.79	23.23	30
1752.5	5	QPSK	1/24	16.09	V	7.95	0.79	23.25	30
1712.5	5	QPSK	1/0	15.26	H	7.95	0.79	22.42	30
1732.5	5	QPSK	1/0	15.28	H	7.95	0.79	22.44	30
1752.5	5	QPSK	1/24	15.32	H	7.95	0.79	22.48	30
1712.5	5	16-QAM	1/0	14.94	V	7.95	0.79	22.10	30
1732.5	5	16-QAM	1/0	14.95	V	7.95	0.79	22.11	30

1752.5	5	16-QAM	1/24	14.98	V	7.95	0.79	22.14	30
1712.5	5	16-QAM	1/0	14.02	H	7.95	0.79	21.18	30
1732.5	5	16-QAM	1/0	13.99	H	7.95	0.79	21.15	30
1752.5	5	16-QAM	1/24	14.05	H	7.95	0.79	21.21	30
1715	10	QPSK	1/0	15.18	V	7.95	0.79	22.34	30
1732.5	10	QPSK	1/49	15.15	V	7.95	0.79	22.31	30
1750	10	QPSK	1/0	15.17	V	7.95	0.79	22.33	30
1715	10	QPSK	1/0	14.38	H	7.95	0.79	21.54	30
1732.5	10	QPSK	1/49	14.42	H	7.95	0.79	21.58	30
1750	10	QPSK	1/0	14.45	H	7.95	0.79	21.61	30
1715	10	16-QAM	1/0	15.58	V	7.95	0.79	22.74	30
1732.5	10	16-QAM	1/49	15.62	V	7.95	0.79	22.78	30
1750	10	16-QAM	1/0	15.6	V	7.95	0.79	22.76	30
1715	10	16-QAM	1/0	14.76	H	7.95	0.79	21.92	30
1732.5	10	16-QAM	1/49	14.72	H	7.95	0.79	21.88	30
1750	10	16-QAM	1/0	14.78	H	7.95	0.79	21.94	30
1717.5	15	QPSK	1/0	16.74	V	7.95	0.79	23.90	30
1732.5	15	QPSK	1/74	16.71	V	7.95	0.79	23.87	30
1747.5	15	QPSK	1/0	16.76	V	7.95	0.79	23.92	30
1717.5	15	QPSK	1/0	15.88	H	7.95	0.79	23.04	30
1732.5	15	QPSK	1/74	15.82	H	7.95	0.79	22.98	30
1747.5	15	QPSK	1/0	15.79	H	7.95	0.79	22.95	30
1717.5	15	16-QAM	1/0	16.28	V	7.95	0.79	23.44	30
1732.5	15	16-QAM	1/74	16.26	V	7.95	0.79	23.42	30
1747.5	15	16-QAM	1/0	16.2	V	7.95	0.79	23.36	30
1717.5	15	16-QAM	1/0	15.88	H	7.95	0.79	23.04	30
1732.5	15	16-QAM	1/74	15.79	H	7.95	0.79	22.95	30
1747.5	15	16-QAM	1/0	15.8	H	7.95	0.79	22.96	30
1720	20	QPSK	1/99	17.01	V	7.95	0.79	24.17	30
1732.5	20	QPSK	1/99	16.95	V	7.95	0.79	24.11	30
1745	20	QPSK	1/0	16.98	V	7.95	0.79	24.14	30
1720	20	QPSK	1/99	16.05	H	7.95	0.79	23.21	30
1732.5	20	QPSK	1/99	15.97	H	7.95	0.79	23.13	30
1745	20	QPSK	1/0	15.94	H	7.95	0.79	23.10	30
1720	20	16-QAM	1/99	16.23	V	7.95	0.79	23.39	30
1732.5	20	16-QAM	1/99	16.28	V	7.95	0.79	23.44	30
1745	20	16-QAM	1/0	16.31	V	7.95	0.79	23.47	30
1720	20	16-QAM	1/99	15.66	H	7.95	0.79	22.82	30

Test Report	16070595-FCC-R5
Page	20 of 60

1732.5	20	16-QAM	1/99	15.71	H	7.95	0.79	22.87	30
1745	20	16-QAM	1/0	15.65	H	7.95	0.79	22.81	30

6.3 Peak-Average Ratio

Temperature	25°C
Relative Humidity	54%
Atmospheric Pressure	1002mbar
Test date :	June 02, 2016
Tested By :	Loren Luo

Requirement(s):

Spec	Item	Requirement	Applicable
§24.232(d) § 27.50(d)	a)	The peak-to-average ratio (PAR) of the transmission may not exceed 13 dB.	<input checked="" type="checkbox"/>

Test Setup	
------------	--

Test Procedure	<p>According with KDB 971168 v02r02</p> <p>5.7.2 Alternate procedure for PAPR</p> <p>5.1.2 Peak power measurements with a peak power meter</p> <p>The total peak output power may be measured using a broadband peak RF power meter. The power meter must have a video bandwidth that is greater than or equal to the emission bandwidth and utilize a fast-responding diode detector.</p> <p>5.2.3 Average power measurement with average power meter</p> <p>As an alternative to the use of a spectrum/signal analyzer or EMI receiver to perform a measurement of the total in-band average output power, a wideband RF average power meter with a thermocouple detector or equivalent can be used under certain conditions</p> <p>If the EUT can be configured to transmit continuously (i.e., the burst duty</p>
----------------	---------------------------------------------------------------------------------------------------------------------------------------------------------------------------------------------------------------------------------------------------------------------------------------------------------------------------------------------------------------------------------------------------------------------------------------------------------------------------------------------------------------------------------------------------------------------------------------------------------------------------------------------------------------------------------------------------------------------------------------------------------------------------------------------------------------------------------------------------

Test Report	16070595-FCC-R5
Page	22 of 60

	<p>cycle \geq 98%) and at all times the EUT is transmitting at its maximum output power level, then a conventional wide-band RF power meter can be used. If the EUT cannot be configured to transmit continuously (i.e., the burst duty cycle $<$ 98%), then there are two options for the use of an average power meter. First, a gated average power meter can be used to perform the measurement if the gating parameters can be adjusted such that the power is measured only over active transmission bursts at maximum output power levels. A conventional average power meter can also be used if the measured burst duty cycle is constant (i.e., duty cycle variations are less than \pm 2 percent) by performing the measurement over the on/off burst cycles and then correcting (increasing) the measured level by a factor equal to $10\log(1/\text{duty cycle})$</p>
Remark	
Result	<input checked="" type="checkbox"/> Pass <input type="checkbox"/> Fail

Test Data Yes N/A
 Test Plot Yes (See below) N/A

LTE Band 4 (part 27)

BW(MHz)	Frequency (MHz)	Mode	Modulation	Conducted Power (dBm)		Peak-Average Ratio (PAR)
				Peak	Average	
1.4	1732.5	RB 1/0	QPSK	23.68	22.64	1.04
			16QAM	22.98	21.49	1.49
3	1732.5	RB 1/0	QPSK	23.47	22.48	0.99
			16QAM	22.59	21.33	1.26
5	1732.5	RB 1/0	QPSK	23.45	22.99	0.46
			16QAM	22.77	22.3	0.47
10	1732.5	RB 1/0	QPSK	23.64	22.64	1
			16QAM	22.38	21.54	0.84
15	1732.5	RB 1/0	QPSK	23.88	22.65	1.23
			16QAM	22.79	21.47	1.32
20	1732.5	RB 1/0	QPSK	23.68	22.67	1.01
			16QAM	23.15	21.57	1.58

6.4 Occupied Bandwidth

Temperature	24°C
Relative Humidity	56%
Atmospheric Pressure	1004mbar
Test date :	June 04, 2016
Tested By :	Loren Luo

Requirement(s):

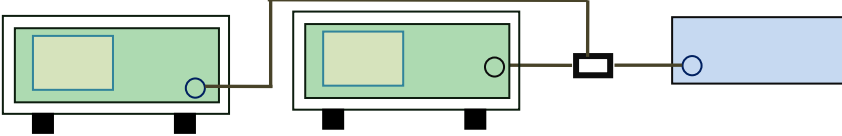
Spec	Item	Requirement	Applicable
§2.1049, §22.917, §22.905 §24.238 §27.53(a)	a)	99% Occupied Bandwidth(kHz)	<input checked="" type="checkbox"/>
	b)	26 dB Bandwidth(kHz)	<input checked="" type="checkbox"/>
Test Setup			
Test Procedure	<ul style="list-style-type: none"> - The EUT was connected to Spectrum Analyzer and Base Station via power divider. - The 99% and 26 dB occupied bandwidth (BW) of the middle channel for the highest RF powers. 		
Remark			
Result	<input checked="" type="checkbox"/> Pass <input type="checkbox"/> Fail		

Test Data Yes N/A

Test Plot Yes (See below) N/A

LTE Band 4 (Part 27)

BW(MHz)	Channel	Frequency (MHz)	Modulation	99% Occupied Bandwidth (MHz)	26 dB Bandwidth (MHz)
1.4	19957	1710.7	16QAM	1.1040	1.301
			QPSK	1.0995	1.296
1.4	20175	1732.5	16QAM	1.1054	1.282
			QPSK	1.1069	1.279
1.4	20393	1754.3	16QAM	1.1010	1.279
			QPSK	1.1096	1.287
3	19965	1711.5	16QAM	2.7421	3.123
			QPSK	2.7517	3.111
3	20175	1732.5	16QAM	2.7429	3.099
			QPSK	2.7528	3.094
3	20385	1753.5	16QAM	2.7513	3.100
			QPSK	2.7484	3.116
5	19975	1712.5	16QAM	4.5136	5.071
			QPSK	4.5364	5.081
5	20175	1732.5	16QAM	4.5433	5.097
			QPSK	4.5264	5.112
5	20375	1752.5	16QAM	4.5482	5.114
			QPSK	4.5270	5.092
10	20000	1715	16QAM	9.1018	10.337
			QPSK	9.0957	10.250
10	20175	1732.5	16QAM	9.0851	10.387
			QPSK	9.0706	10.265
10	20350	1750	16QAM	9.0642	10.273
			QPSK	9.0908	10.431
15	20025	1717.5	16QAM	13.5206	15.091
			QPSK	13.5424	15.118
15	20175	1732.5	16QAM	13.4877	15.082
			QPSK	13.4752	15.033
15	20325	1747.5	16QAM	13.4996	15.062
			QPSK	13.4852	15.103

20	20050	1720	16QAM	17.9573	19.709
			QPSK	17.9129	19.430
20	20175	1732.5	16QAM	17.9644	19.618
			QPSK	17.8986	19.664
20	20300	1745	16QAM	17.9111	19.728
			QPSK	17.9400	19.785

Test Plots

LTE Band 4 (Part 27)

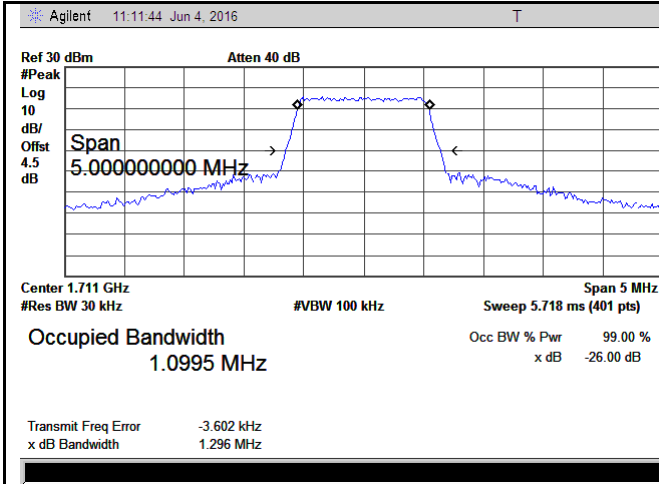

LTE band 4 - Low CH QPSK-1.4

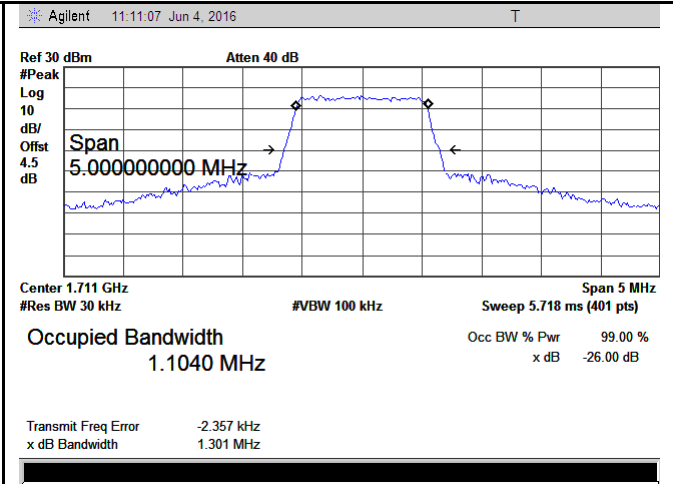

LTE band 4 - Low CH 16QAM-1.4

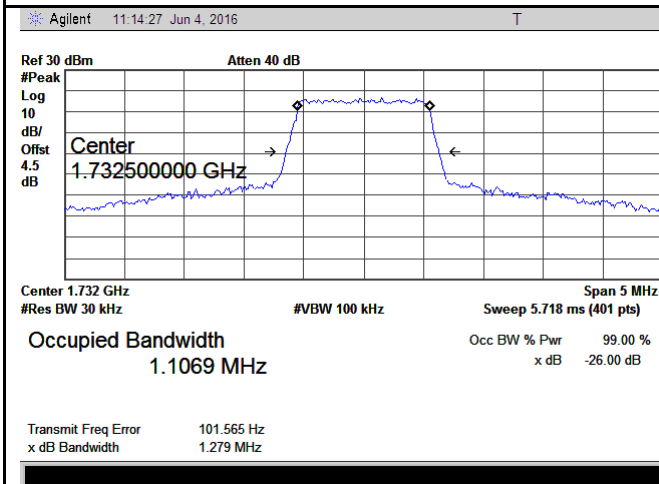

LTE band 4 - Middle CH QPSK-1.4

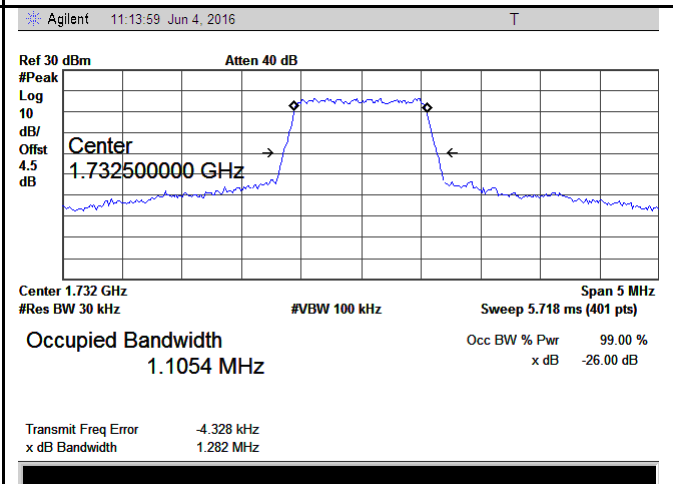

LTE band 4 - Middle CH 16QAM-1.4

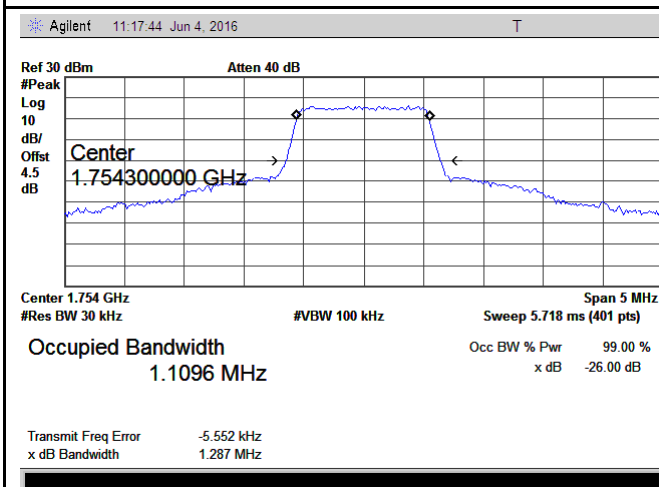

LTE band 4 - High CH QPSK-1.4

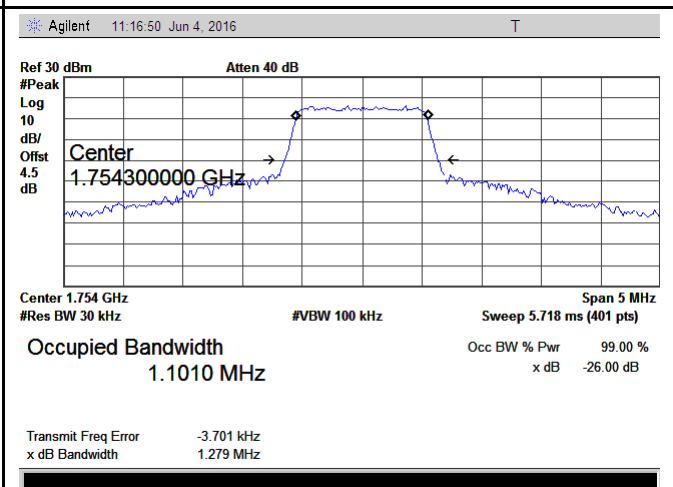

LTE band 4 - High CH 16QAM-1.4

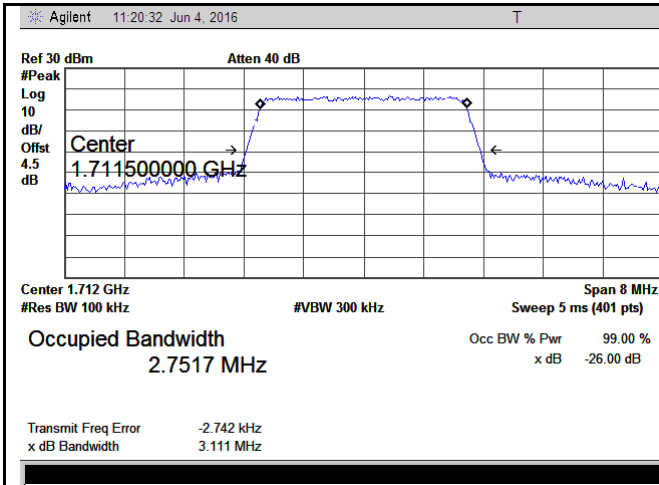

LTE band 4 - Low CH QPSK-3

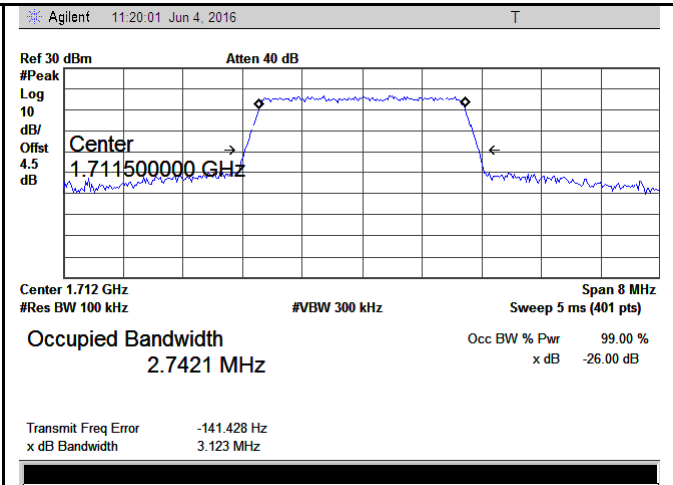

LTE band 4 - Low CH 16QAM-3

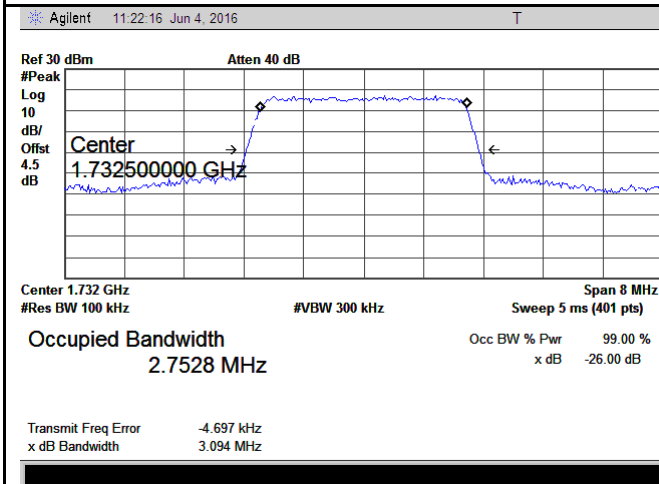

LTE band 4 - Middle CH QPSK-3

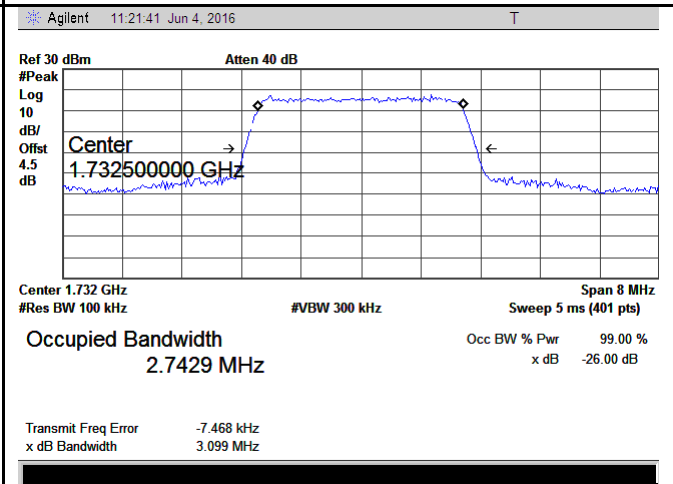

LTE band 4 - Middle CH 16QAM-3

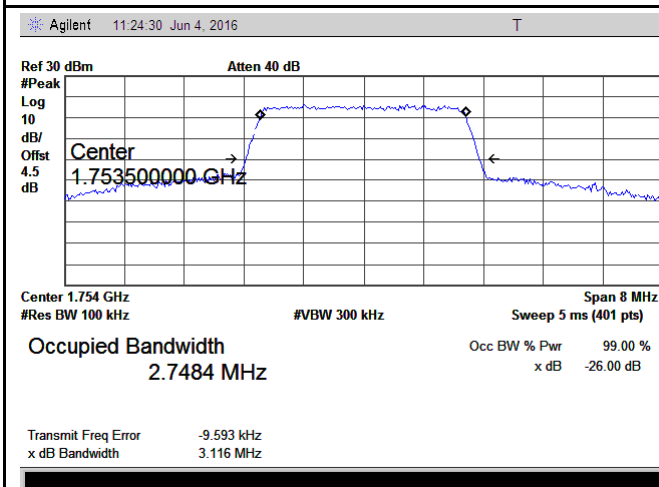

LTE band 4 - High CH QPSK-3

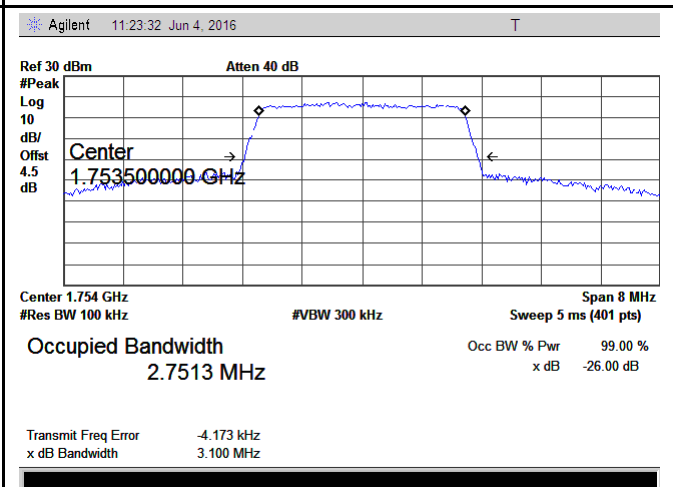

LTE band 4 - High CH 16QAM-3

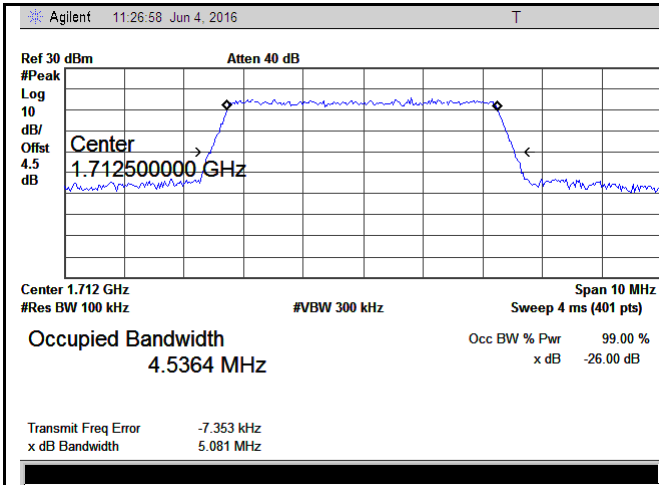

LTE band 4 - Low CH QPSK-5

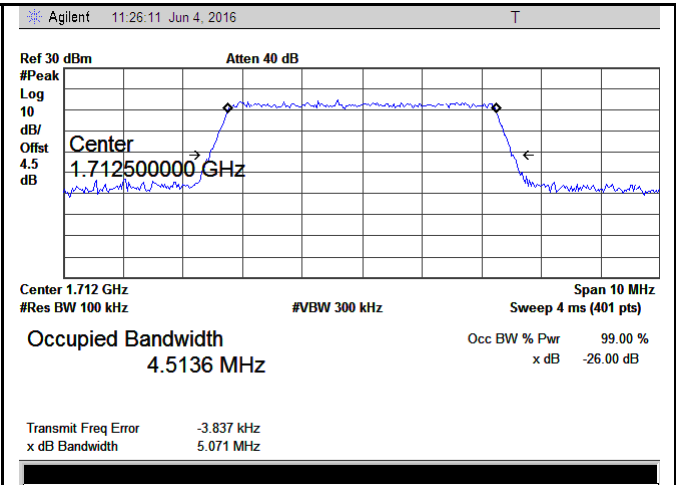

LTE band 4 - Low CH 16QAM-5

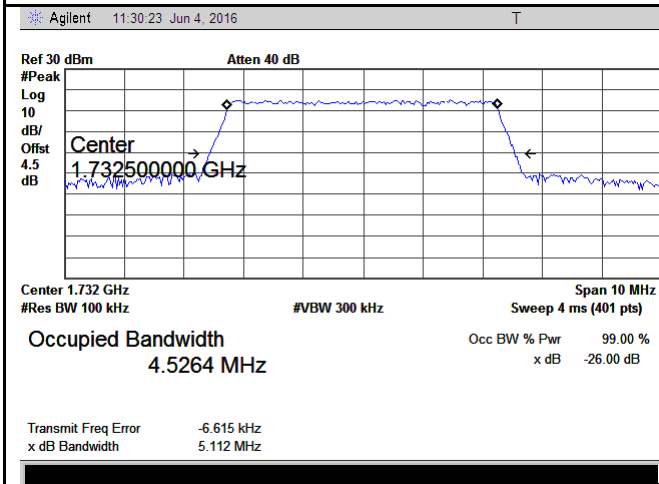

LTE band 4 - Middle CH QPSK-5

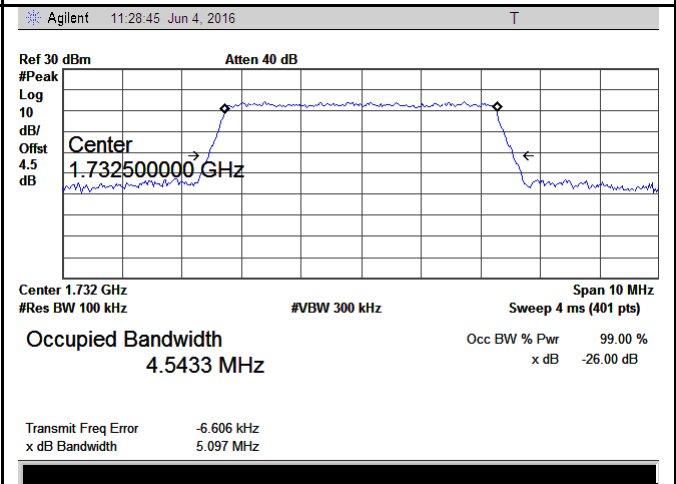

LTE band 4 - Middle CH 16QAM-5

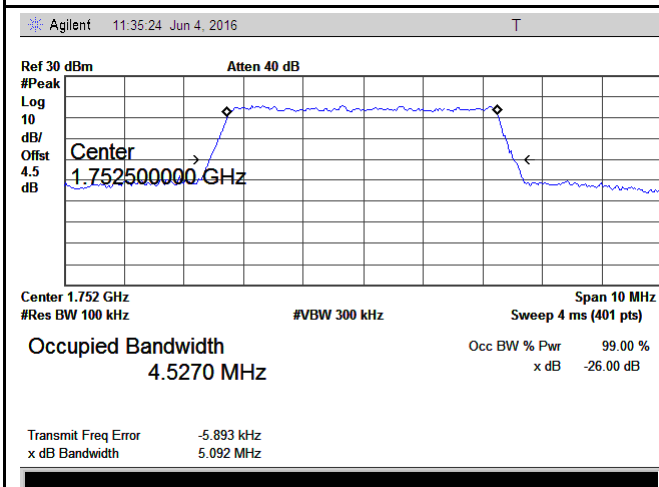

LTE band 4 - High CH QPSK-5

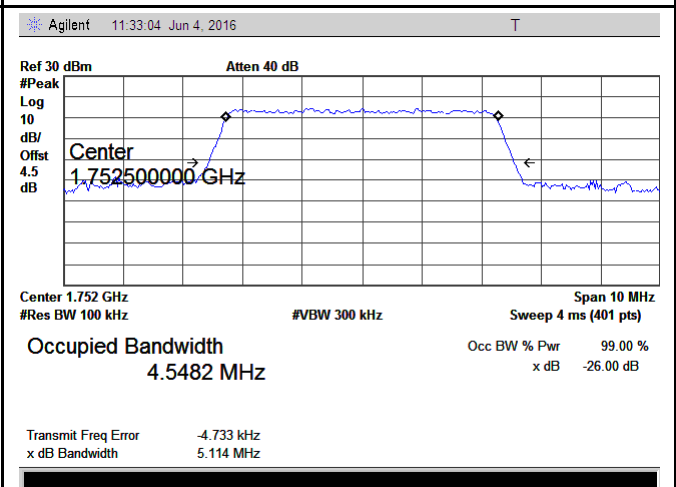

LTE band 4 - High CH 16QAM-5

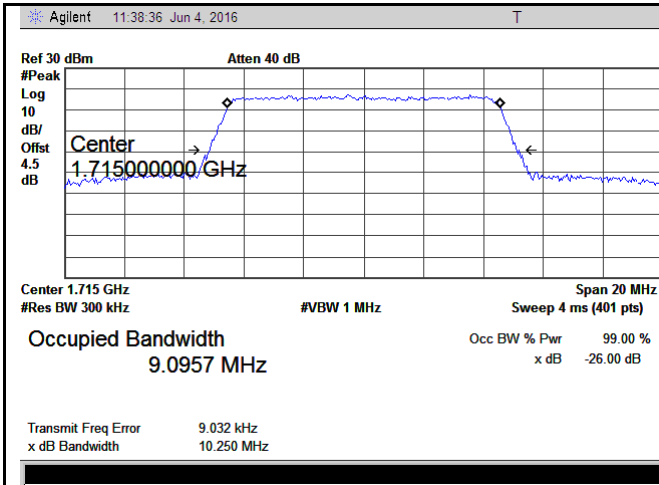

LTE band 4 - Low CH QPSK-10

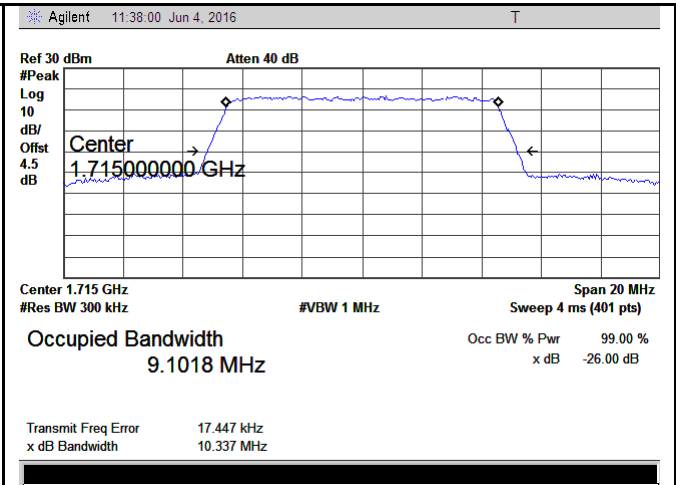

LTE band 4 - Low CH 16QAM-10

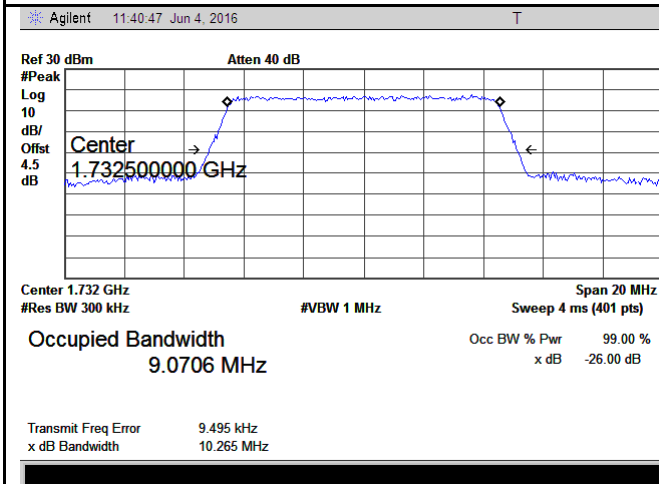

LTE band 4 - Middle CH QPSK-10

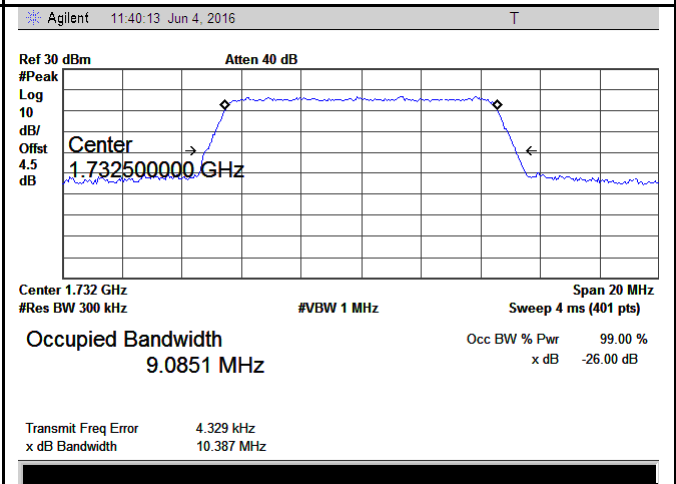

LTE band 4 - Middle CH 16QAM-10

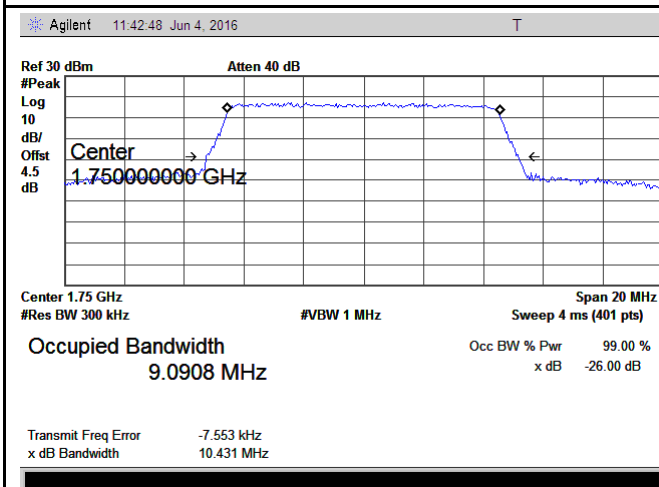

LTE band 4 - High CH QPSK-10

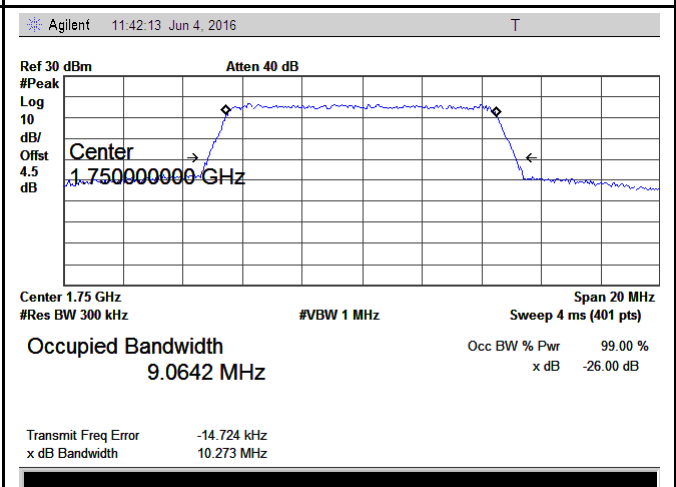

LTE band 4 - High CH 16QAM-10

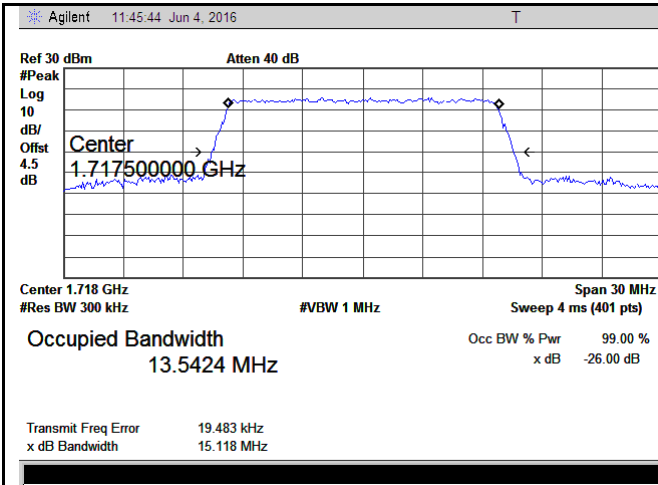

LTE band 4 - Low CH QPSK-15

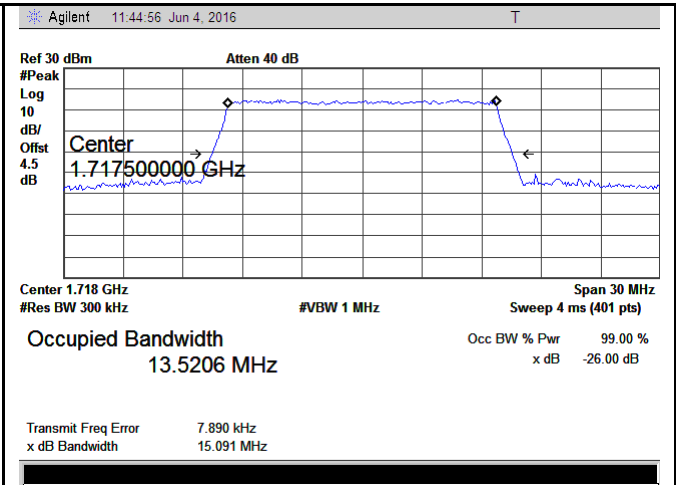

LTE band 4 - Low CH 16QAM-15

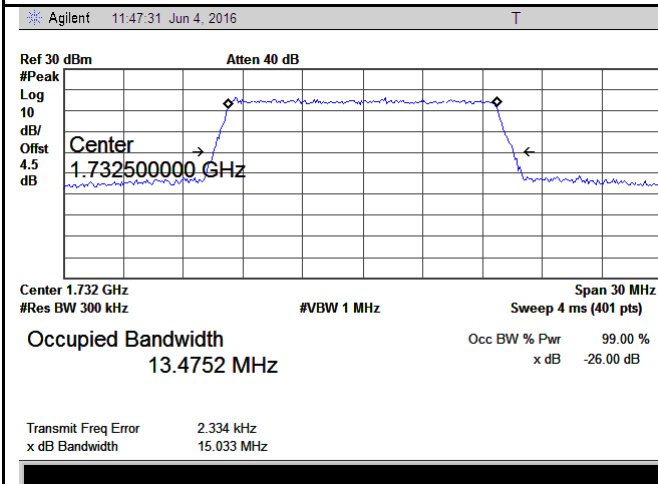

LTE band 4 - Middle CH QPSK-15

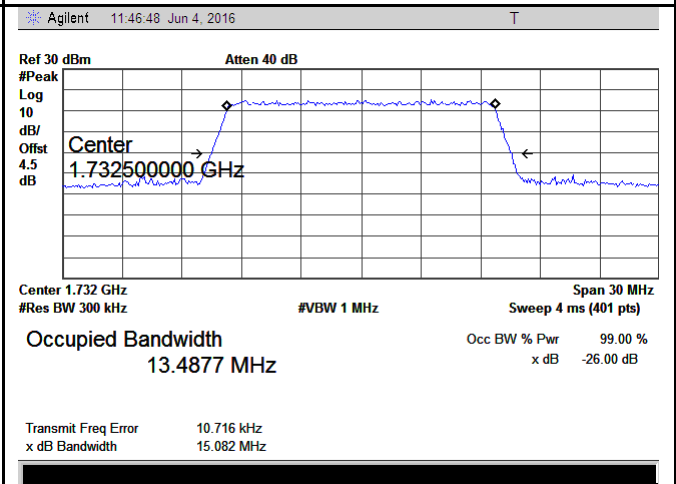

LTE band 4 - Middle CH 16QAM-15

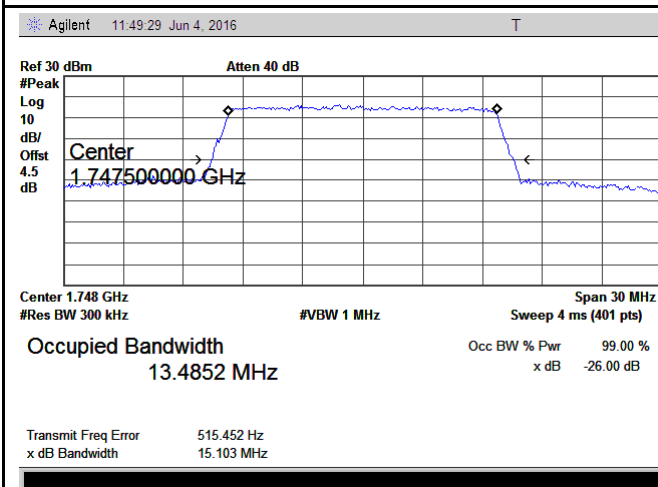

LTE band 4 - High CH QPSK-15

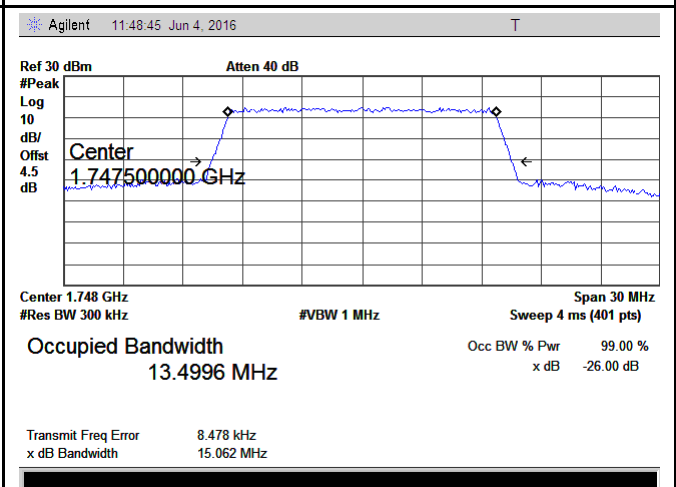

LTE band 4 - High CH 16QAM-15

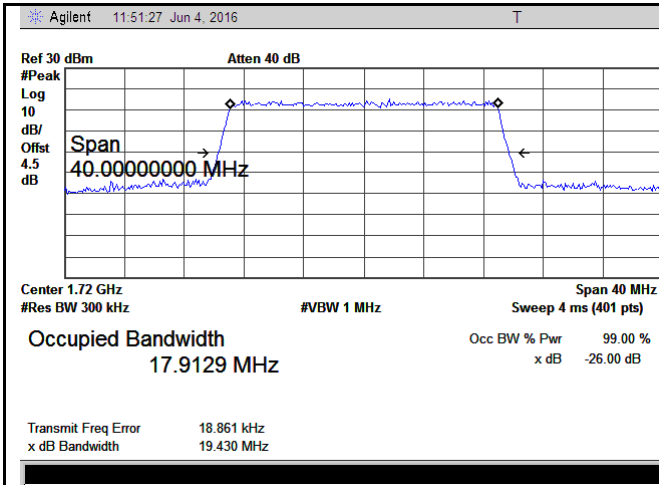

LTE band 4 - Low CH QPSK-20

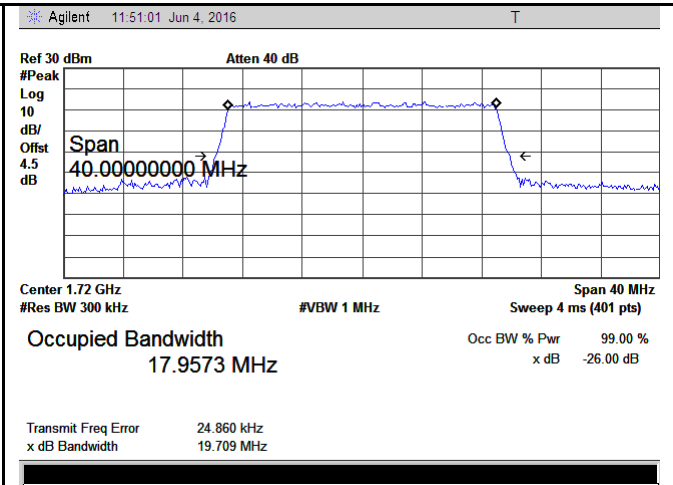

LTE band 4 - Low CH 16QAM-20

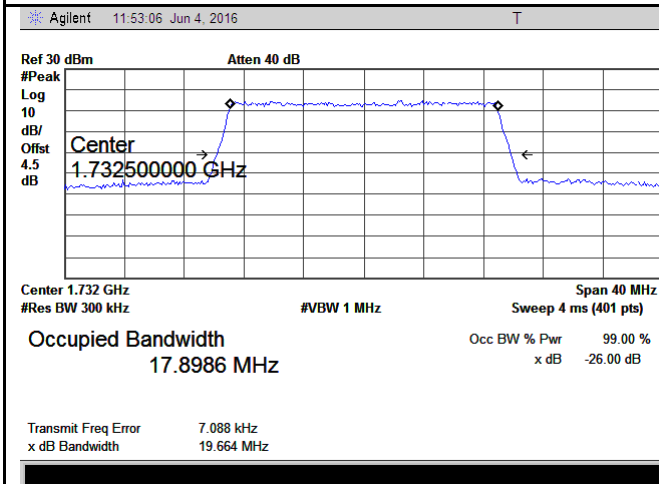

LTE band 4 - Middle CH QPSK-20

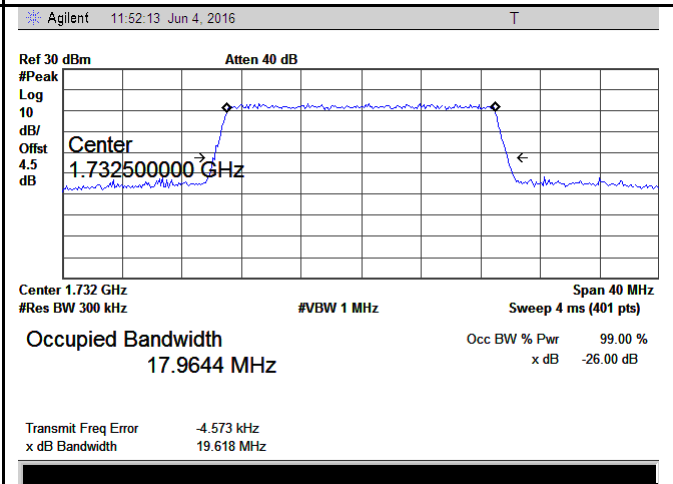

LTE band 4 - Middle CH 16QAM-20

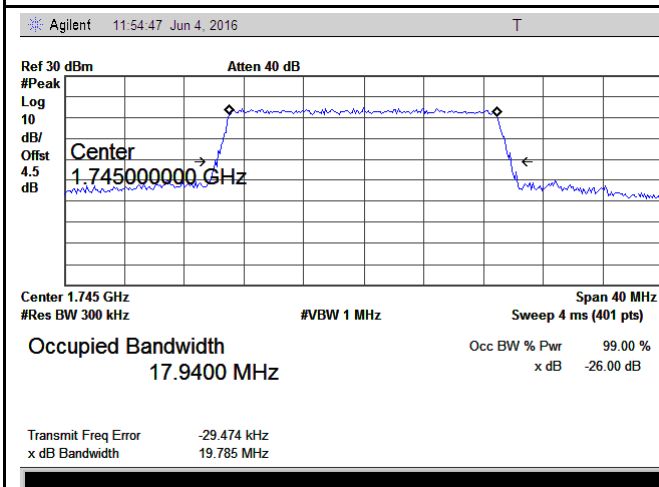

LTE band 4 - High CH QPSK-20

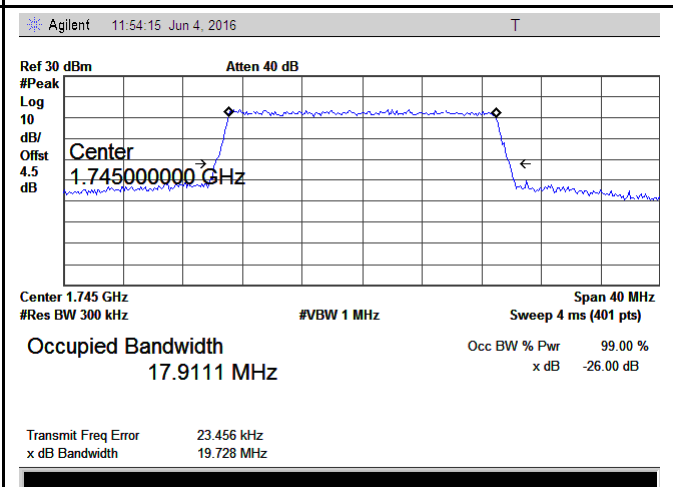

LTE band 4 - High CH 16QAM-20

6.5 Spurious Emissions at Antenna Terminals

Temperature	23°C
Relative Humidity	58%
Atmospheric Pressure	1006mbar
Test date :	June 06, 2016
Tested By :	Loren Luo

Requirement(s):

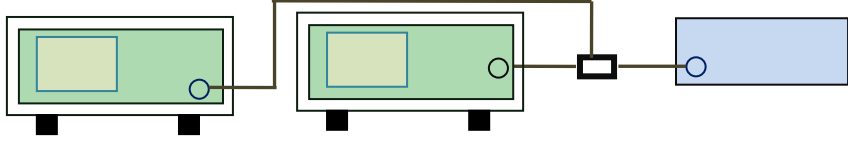
Spec	Item	Requirement	Applicable
§2.1051, §22.917(a)& §24.238(a) § 27.53(h)	a)	The power of any emission outside of the authorized operating frequency ranges must be lower than the transmitter power (P) by a factor of at least $43 + 10 \log(P)$ dB	<input checked="" type="checkbox"/>
Test Setup			
Test Procedure	<ul style="list-style-type: none"> - The EUT was connected to Spectrum Analyzer and Base Station via power divider. - The Band Edges of low and high channels for the highest RF powers were measured. - Setting RBW as roughly BW/100. 		
Remark			
Result	<input checked="" type="checkbox"/> Pass <input type="checkbox"/> Fail		

Test Data Yes N/A
 Test Plot Yes (See below) N/A

Test Plots 30MHz-5GHz
LTE Band 4 (Part27) result

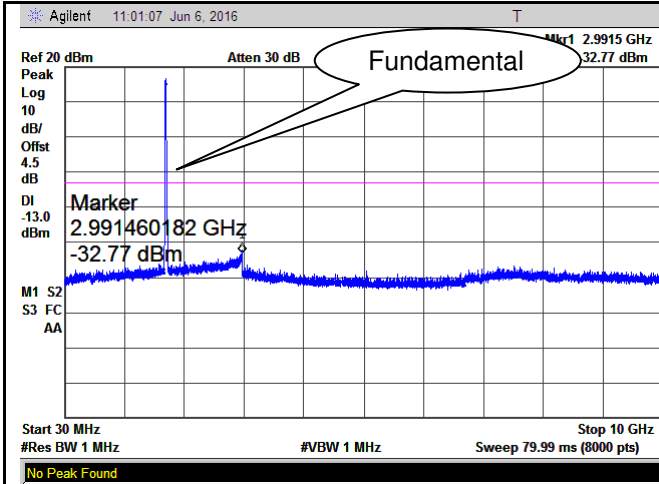

LTE Band 4 - Low Channel-1

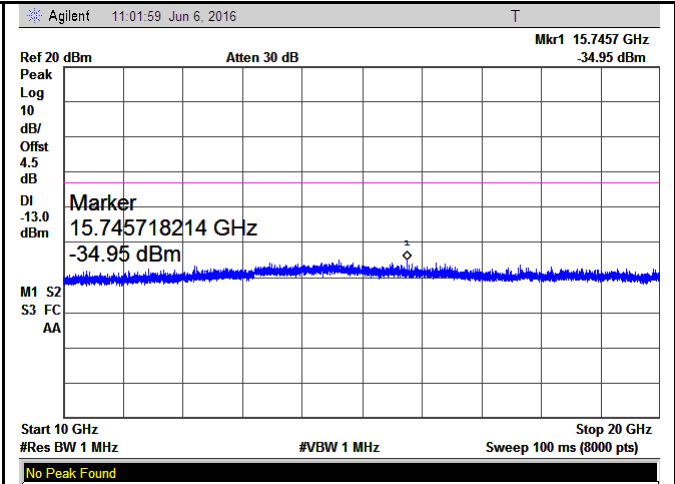

LTE Band 4 - Low Channel-2

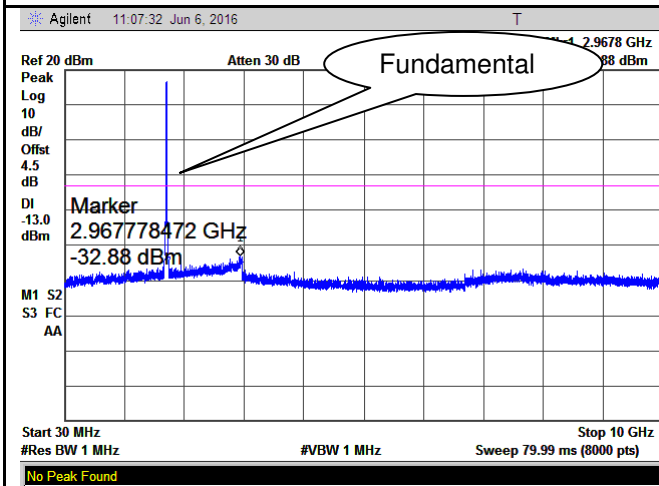

LTE Band 4 - Middle Channel-1

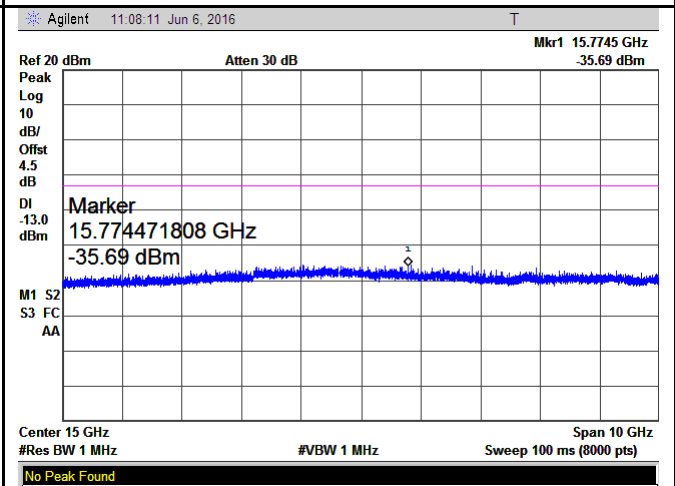

LTE Band 4 - Middle Channel-2

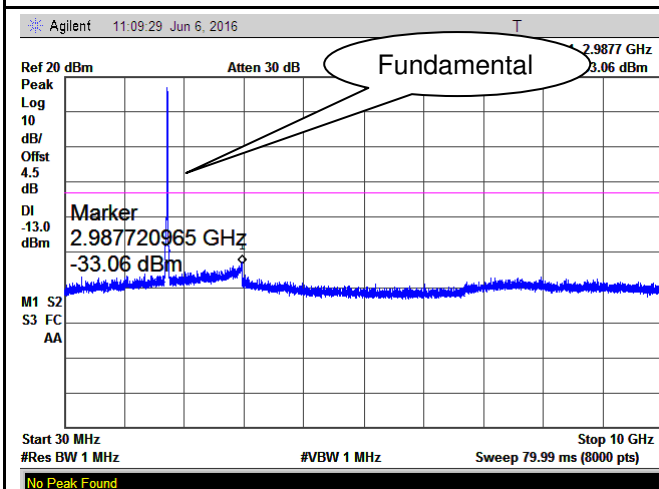

LTE Band 4 - High Channel-1

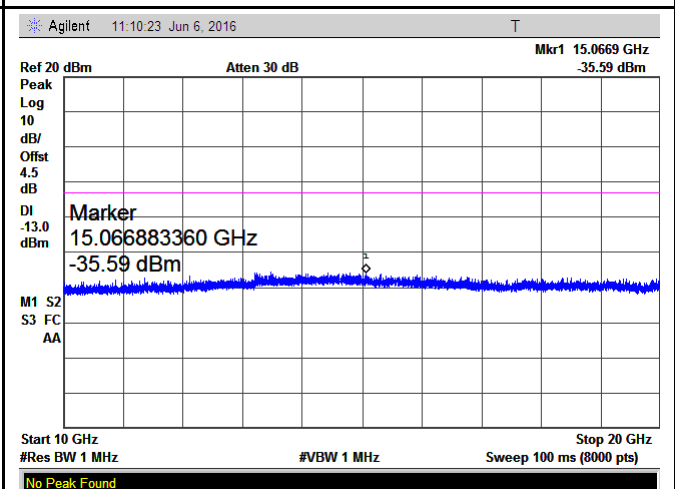

LTE Band 4 - High Channel-2

6.6 Spurious Radiated Emissions

Temperature	23°C
Relative Humidity	58%
Atmospheric Pressure	1006mbar
Test date :	June 06, 2016
Tested By :	Loren Luo

Requirement(s):

Spec	Item	Requirement	Applicable
§2.1053, §22.917 & §24.238 § 27.53(h)	a)	The power of any emission outside of the authorized operating frequency ranges must be attenuated below the transmitter power (P) by a factor of at least $43 + 10 \log (P)$ dB. The spectrum is scanned from 30 MHz up to a frequency including its 10th harmonic.	<input checked="" type="checkbox"/>

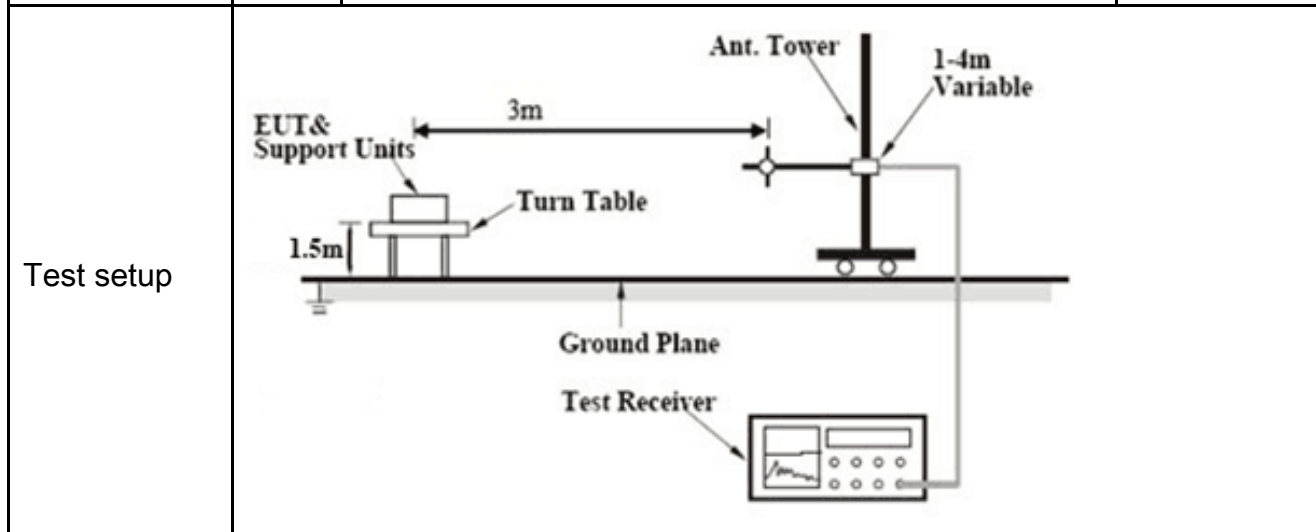

Test Procedure	<ol style="list-style-type: none"> The transmitter was placed on a wooden turntable, and it was transmitting into a non-radiating load which was also placed on the turntable. The measurement antenna was placed at a distance of 3 meters from the EUT. During the tests, the antenna height and polarization as well as EUT azimuth were varied in order to identify the maximum level of emissions from the EUT. The test was performed by placing the EUT on 3-orthogonal axis. Remove the EUT and replace it with substitution antenna. A signal generator was connected to the substitution antenna by a non-radiating cable. The absolute levels of the spurious emissions were measured by the substitution. Sample Calculation: EUT Field Strength = Raw Amplitude (dBμV/m) – Amplifier Gain (dB) + Antenna Factor (dB) + Cable Loss (dB) + Filter Attenuation (dB, if used)
----------------	------------------------------------------------------------------------------------------------------------------------------------------------------------------------------------------------------------------------------------------------------------------------------------------------------------------------------------------------------------------------------------------------------------------------------------------------------------------------------------------------------------------------------------------------------------------------------------------------------------------------------------------------------------------------------------------------------------------------------------------------------------------------------------------------------------------------------------------------------------------------------------------------------------------------------------------------

Test Report	16070595-FCC-R5
Page	36 of 60

Remark	
Result	<input checked="" type="checkbox"/> Pass <input type="checkbox"/> Fail

Test Data Yes N/A

Test Plot Yes (See below) N/A

LTE Band 4(Part27) result

Low channel

Frequency (MHz)	Substituted level (dBm)	Polarity (H/V)	Antenna Gain Correction (dB)	Cable Loss (dB)	Corrected Reading (dBm)	Limit (dBm)	Margin (dB)
3440	-46.85	V	10.06	2.52	-39.31	-13	-26.31
3440	-47.26	H	10.06	2.52	-39.72	-13	-26.72
572.8	-48.91	V	6.5	0.36	-42.77	-13	-29.77
843.1	-49.89	H	6.8	0.44	-43.53	-13	-30.53

Middle channel

Frequency (MHz)	Substituted level (dBm)	Polarity (H/V)	Antenna Gain Correction (dB)	Cable Loss (dB)	Corrected Reading (dBm)	Limit (dBm)	Margin (dB)
3465	-47.11	V	10.09	2.52	-39.54	-13	-26.54
3465	-47.65	H	10.09	2.52	-40.08	-13	-27.08
570.6	-50.29	V	6.5	0.36	-44.15	-13	-31.15
843.5	-50.33	H	6.8	0.44	-43.97	-13	-30.97

High channel

Frequency (MHz)	Substituted level (dBm)	Polarity (H/V)	Antenna Gain Correction (dB)	Cable Loss (dB)	Corrected Reading (dBm)	Limit (dBm)	Margin (dB)
3490	-46.91	V	10.09	2.52	-39.34	-13	-26.34
3490	-46.82	H	10.09	2.52	-39.25	-13	-26.25
572.2	-49.86	V	6.5	0.36	-43.72	-13	-30.72
843.7	-50.31	H	6.8	0.44	-43.95	-13	-30.95

Note:

- 1, The testing has been conformed to $10 \times 1752.5 \text{ MHz} = 17,525 \text{ MHz}$
- 2, All other emissions more than 30 dB below the limit
- 3, X-Axis, Y-Axis and -Axis were investigated. The results above show only the worst case.

6.7 Band Edge

Temperature	23°C
Relative Humidity	58%
Atmospheric Pressure	1006mbar
Test date :	June 06, 2016
Tested By :	Loren Luo

Requirement(s):

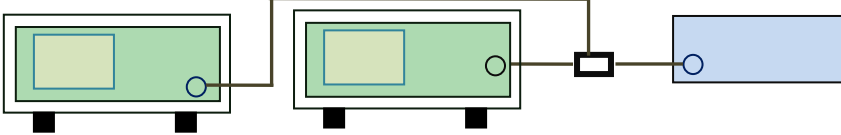
Spec	Item	Requirement	Applicable
§22.917(a) §24.238(a) § 27.53(h)	a)	The power of any emission outside of the authorized operating frequency ranges must be lower than the transmitter power (P) by a factor of at least $43 + 10 \log (P)$ dB.	<input checked="" type="checkbox"/>
Test setup			
Procedure	<ul style="list-style-type: none"> - The EUT was connected to Spectrum Analyzer and Base Station via power divider. - The Band Edges of low and high channels for the highest RF powers were measured. Setting RBW as roughly BW/100. 		
Remark			
Result	<input checked="" type="checkbox"/> Pass <input type="checkbox"/> Fail		

Test Data Yes N/A

Test Plot Yes (See below) N/A

LTE Band 4 (Part 27) result

BW(MHz)	Channel	Frequency (MHz)	Mode	Emission (dBm)	Limit (dBm)
1.4	19957	1710.7	QPSK	-26.90	-13
			16QAM	-25.34	-13
1.4	20393	1754.3	QPSK	-25.53	-13
			16QAM	-27.57	-13
3	19965	1711.5	QPSK	-19.21	-13
			16QAM	-22.26	-13
3	20385	1753.5	QPSK	-22.73	-13
			16QAM	-22.47	-13
5	19975	1712.5	QPSK	-19.92	-13
			16QAM	-20.81	-13
5	20375	1752.5	QPSK	-22.07	-13
			16QAM	-24.77	-13
10	20000	1715	QPSK	-30.00	-13
			16QAM	-30.13	-13
10	20350	1750	QPSK	-29.35	-13
			16QAM	-30.45	-13
15	20025	1717.5	QPSK	-21.63	-13
			16QAM	-23.60	-13
15	20325	1747.5	QPSK	-23.08	-13
			16QAM	-25.74	-13
20	20050	1720	QPSK	-25.92	-13
			16QAM	-23.18	-13
20	20300	1745	QPSK	-25.41	-13
			16QAM	-26.06	-13

Test Plots

LTE Band 4 (Part 27)

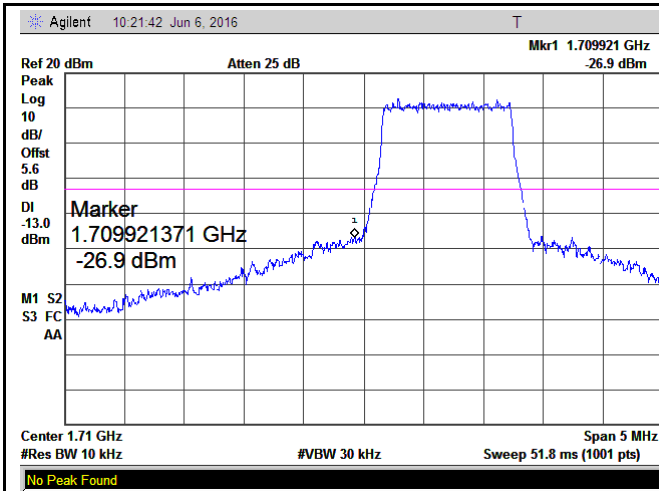

LTE Band 4 - Low Channel QPSK-1.4

Note: Offset=Cable loss (4.5) + 10log
(12.96/10)=4.5+1.1=5.6 dB

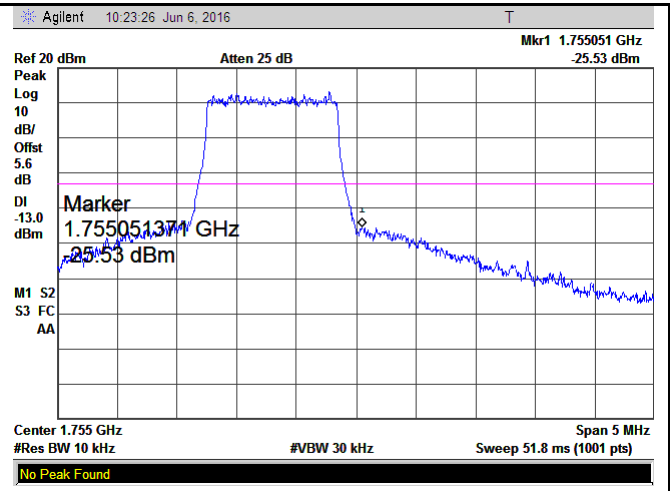

LTE Band 4 - High Channel QPSK-1.4

Note: Offset=Cable loss (4.5) + 10log
(12.87/10)=4.5+1.1=5.6 dB

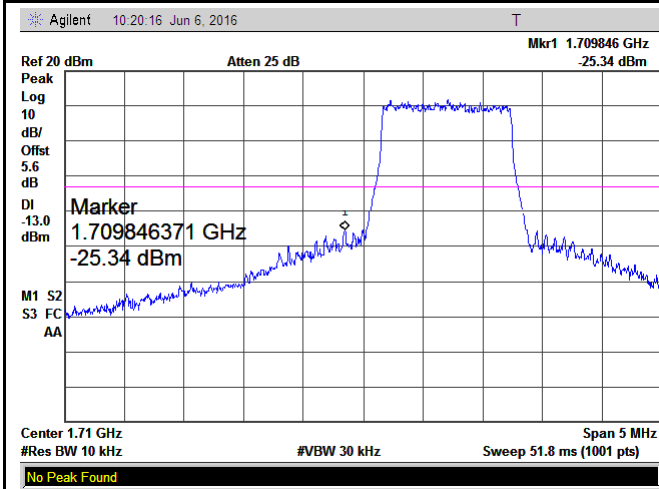

LTE Band 4 - Low Channel 16QAM-1.4

Note: Offset=Cable loss (4.5) + 10log
(13.01/10)=4.5+1.1=5.6 dB

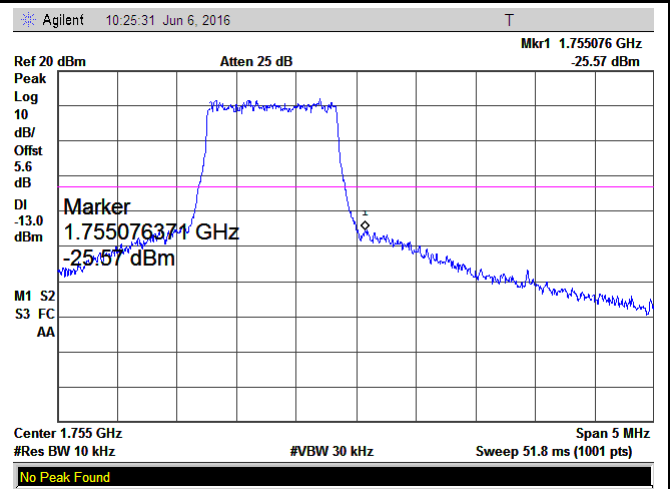

LTE Band 4 - High Channel 16QAM-1.4

Note: Offset=Cable loss (4.5) + 10log
((12.79/10)=4.5+1.1=5.6. dB

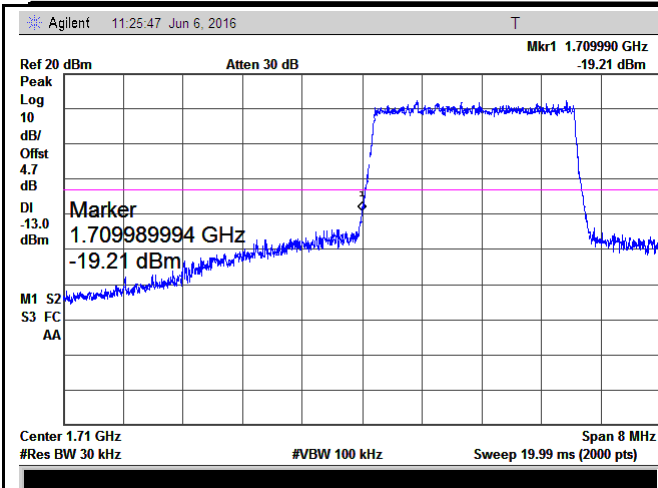

LTE Band 4 - Low Channel QPSK-3

Note: Offset=Cable loss (4.5) + 10log
(31.11/30)=4.5+0.2=4.7 dB

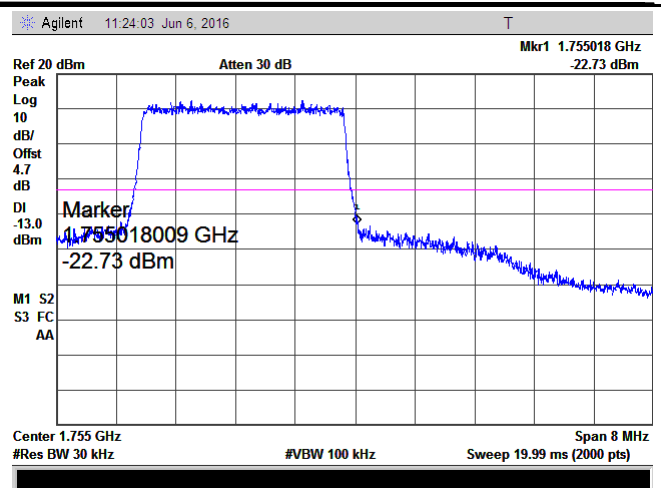

LTE Band 4 - High Channel QPSK-3

Note: Offset=Cable loss (4.5) + 10log
(31.16/30)=4.5+0.2=4.7 dB

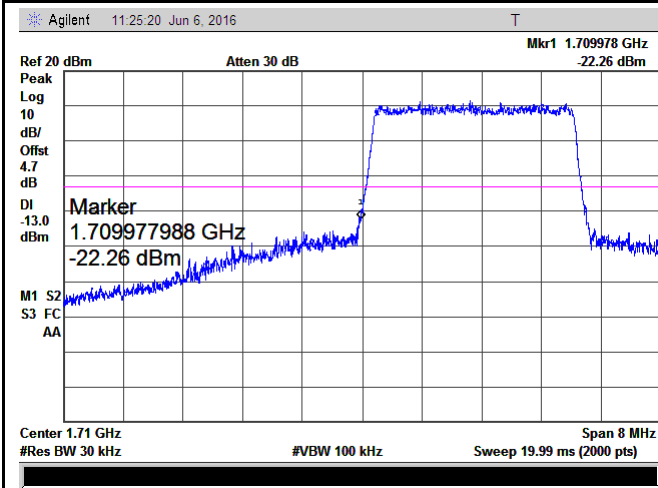

LTE Band 4 - Low Channel 16QAM-3

Note: Offset=Cable loss (4.5) + 10log
(31.23/30)=4.5+0.2=4.7 dB

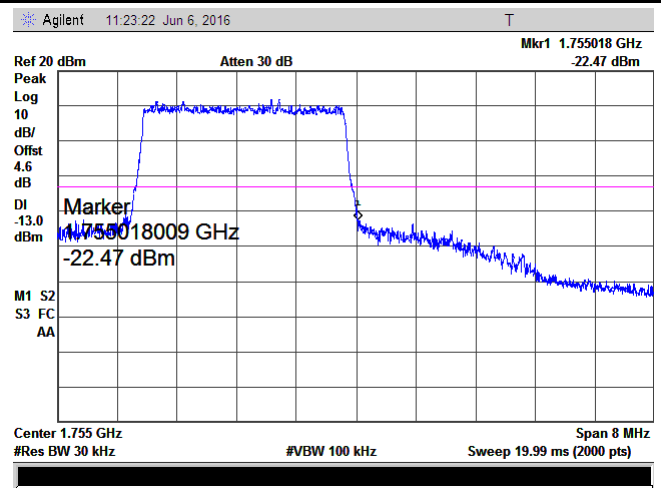

LTE Band 4 - High Channel 16QAM-3

Note: Offset=Cable loss (4.5) + 10log
(31/30)=4.5+0.1=4.6 dB

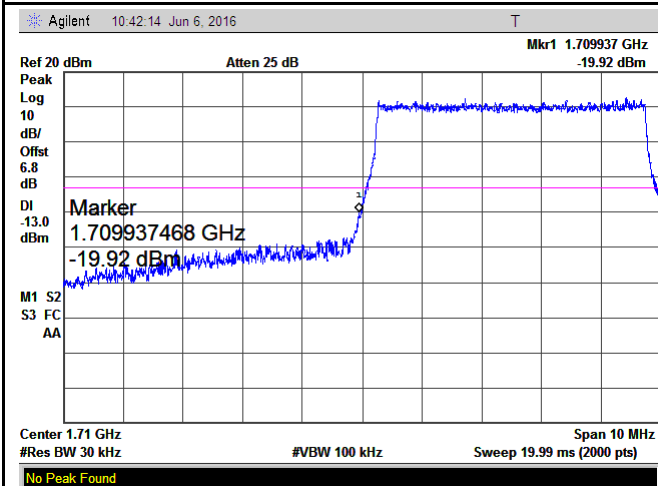

LTE Band 4 - Low Channel QPSK-5

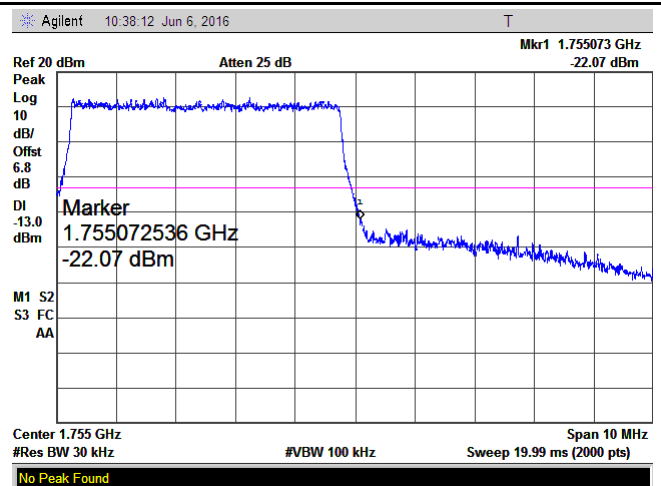

LTE Band 4 - High Channel QPSK-5

Note: Offset=Cable loss (4.5) + 10log
(50.81/30)=4.5+2.3=6.8 dB

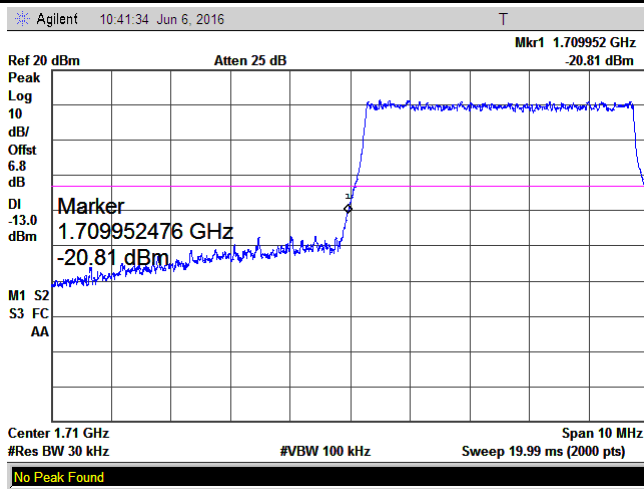

LTE Band 4 - Low Channel 16QAM-5

Note: Offset=Cable loss (4.5) + 10log
(50.92/30)=4.5+2.3=6.8 dB

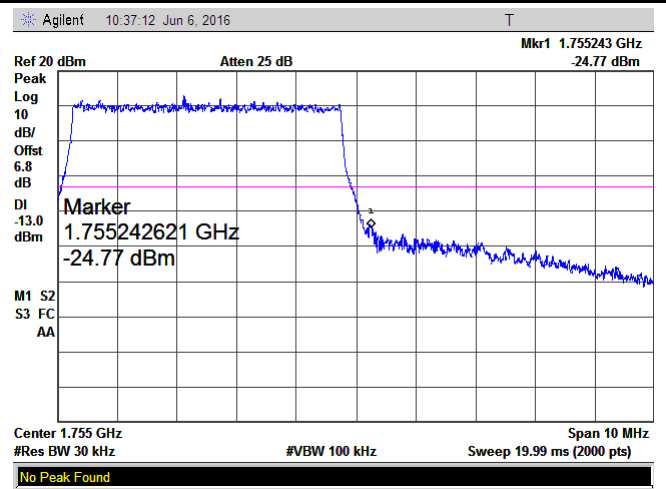

LTE Band 4 - High Channel 16QAM-5

Note: Offset=Cable loss (4.5) + 10log
(50.71/30)=4.5+2.3=6.8 dB

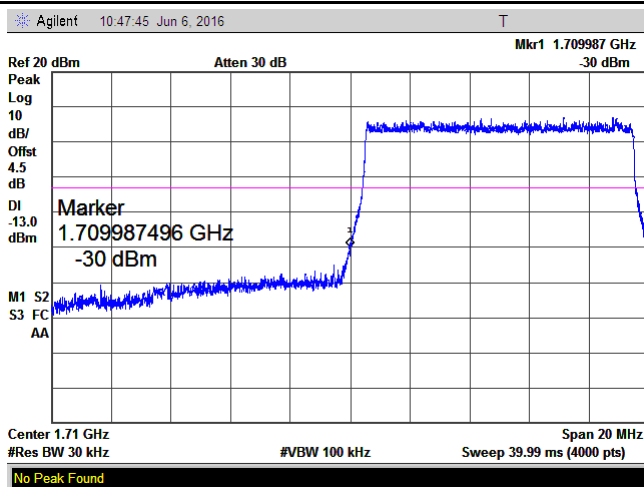

LTE Band 4 - Low Channel QPSK-10

Note: Offset=Cable loss (4.5) + 10log
(51.14/30)=4.5+2.3=6.8 dB

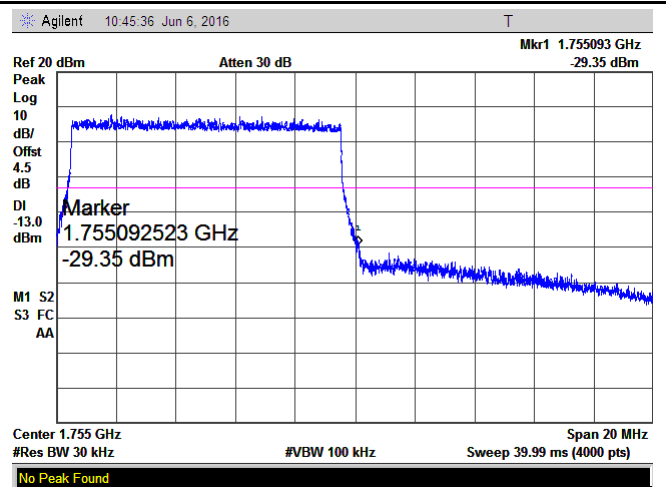

LTE Band 4 - High Channel QPSK-10

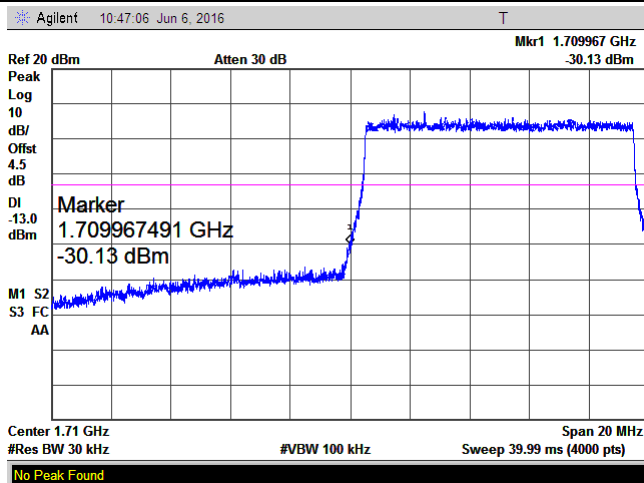

LTE Band 4 - Low Channel 16QAM-10

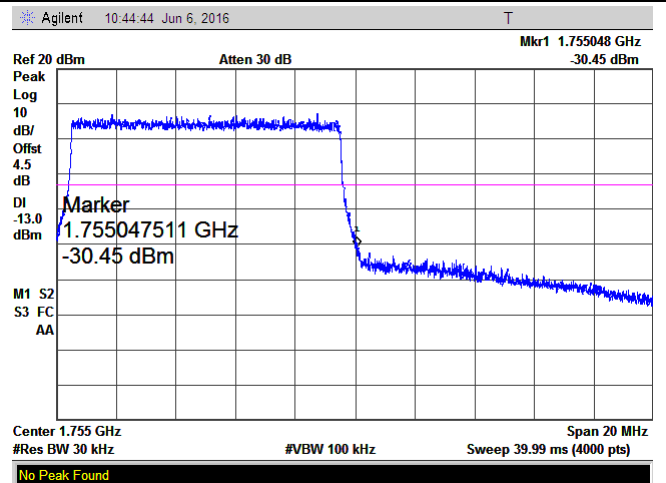

LTE Band 4 - High Channel 16QAM-10

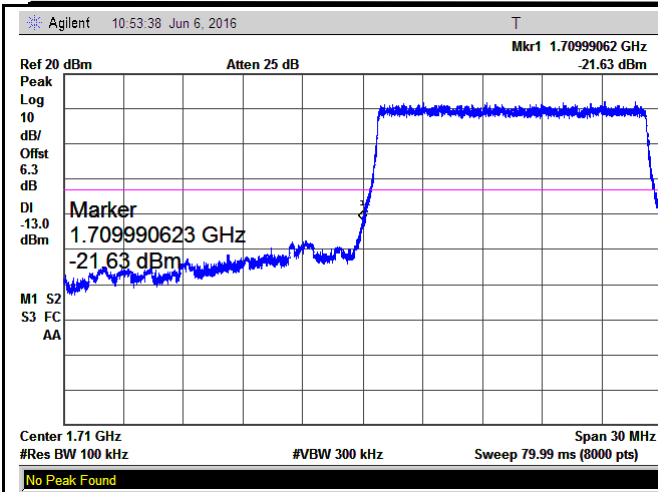

LTE Band 4 - Low Channel QPSK-15

Note: Offset=Cable loss (4.5) + 10log
(151.18/100)=4.5+1.8=6.3 dB

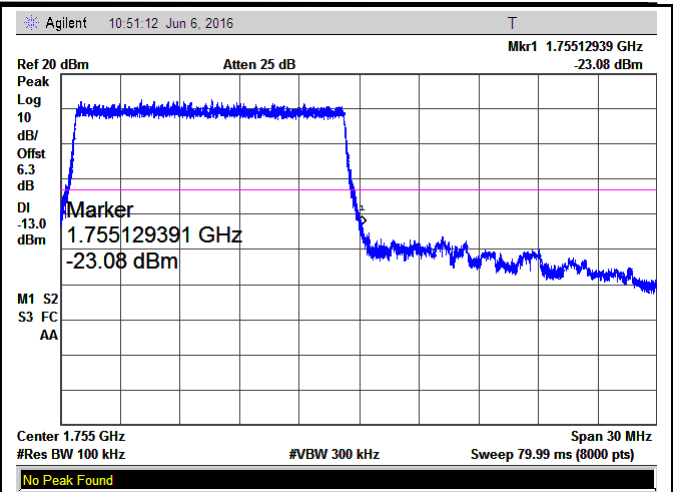

LTE Band 4 - High Channel QPSK-15

Note: Offset=Cable loss (4.5) + 10log
(151.03/100)=4.5+1.8=6.3 dB

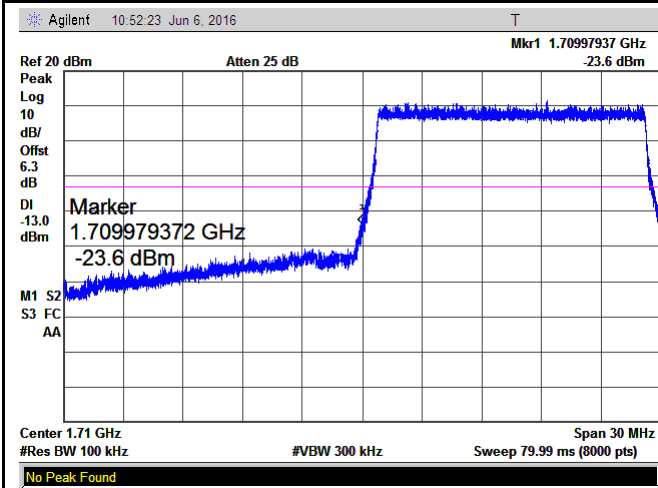

LTE Band 4 - Low Channel 16QAM-15

Note: Offset=Cable loss (4.5) + 10log
(150.91/100)=4.5+1.8=6.3 dB

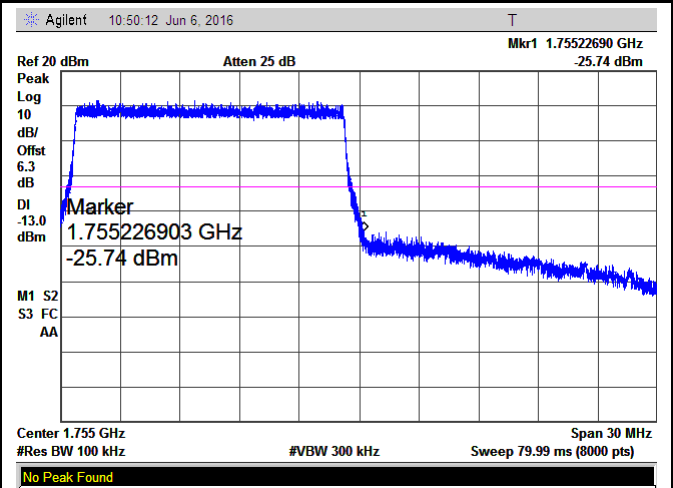

LTE Band 4 - High Channel 16QAM-15

Note: Offset=Cable loss (4.5) + 10log
(150.62/100)=4.5+1.8=6.3 dB

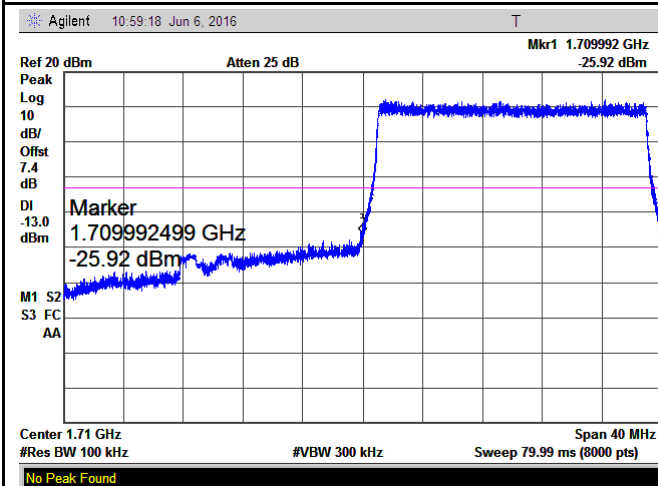

LTE Band 4 - Low Channel QPSK-20

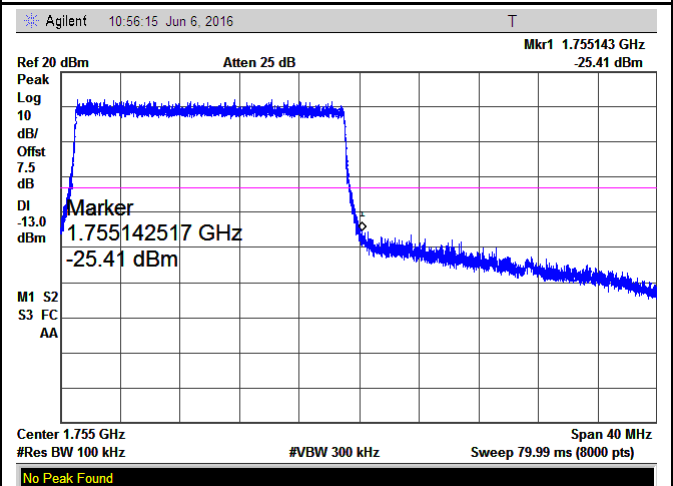

LTE Band 4 - High Channel QPSK-20

Note: Offset=Cable loss (4.5) + 10log
(194.3/100)=4.5+2.9=7.4 dB

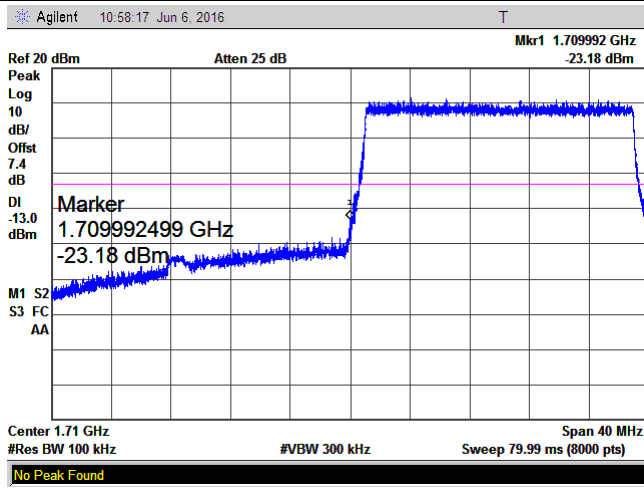

LTE Band 4 - Low Channel 16QAM-20

Note: Offset=Cable loss (4.5) + 10log
(197.09/100)=4.5+2.9=7.4dB

Note: Offset=Cable loss (4.5) + 10log
(197.85/100)=4.5+3.0=7.5 dB

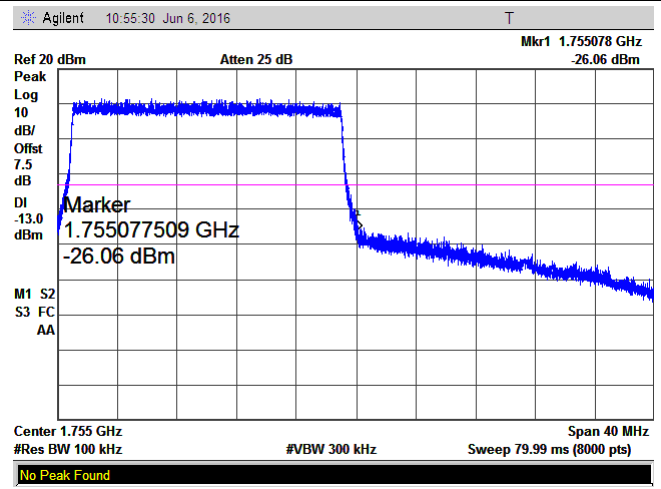

LTE Band 4 - High Channel 16QAM-20

Note: Offset=Cable loss (4.5) + 10log
(197.28/100)=4.5+3.0=7.5 dB

6.8 Band Edge 27.53(m)

Temperature	23°C
Relative Humidity	58%
Atmospheric Pressure	1006mbar
Test date :	-----
Tested By :	Loren Luo

Requirement(s):

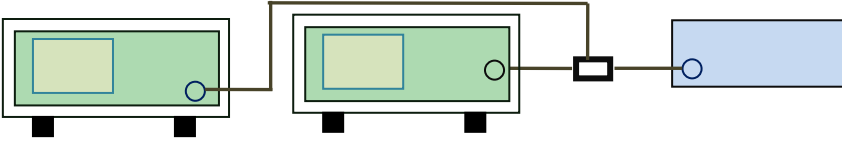
Spec	Requirement	Applicable
§27.53(m)	According to FCC 27.53(m)(4) specified that power of any emission outside of the channel edge must be attenuated below the transmitting power(P) by a factor shall be not less than $43+10\log(P)$ dB at the channel edge, the limit of emission equal to -13dBm. And $55+10\log(P)$ dB at 5.5MHz from the channel edges, the limit of emission equal to -25dBm. In the 1MHz bands immediately outside and adjacent to the frequency block a resolution bandwidth of at least one percent of the emission bandwidth of the fundamental emission of the transmitter may be employed.	<input type="checkbox"/>
Test Setup		
Test Procedure	<ul style="list-style-type: none"> - The EUT was connected to Spectrum Analyzer and Base Station via power divider. - The 99% and 26 dB occupied bandwidth (BW) of the middle channel for the highest RF powers. 	
Remark		
Result	<input type="checkbox"/> Pass <input type="checkbox"/> Fail <input checked="" type="checkbox"/> N/A	

Test Data Yes N/A
 Test Plot Yes (See below) N/A

6.9 Frequency Stability

Temperature	23°C
Relative Humidity	58%
Atmospheric Pressure	1006mbar
Test date :	June 06, 2016
Tested By :	Loren Luo

Requirement(s):

Spec	Item	Requirement	Applicable																																
§2.1055, §22.355 & §24.235 § 27.5(h); § 27.54	a)	According to §22.355, the carrier frequency of each transmitter in the Public Mobile Services must be maintained within the tolerances given in Table below: Frequency Tolerance for Transmitters in the Public Mobile Services	<input checked="" type="checkbox"/>																																
		<table border="1"> <thead> <tr> <th>Frequency Range (MHz)</th> <th>Base, fixed (ppm)</th> <th>Mobile ≤ 3 watts (ppm)</th> <th>Mobile ≤ 3 watts (ppm)</th> </tr> </thead> <tbody> <tr> <td>25 to 50</td> <td>20.0</td> <td>20.0</td> <td>50.0</td> </tr> <tr> <td>to 450</td> <td>5.0</td> <td>5.0</td> <td>50.0</td> </tr> <tr> <td>450 to 512</td> <td>2.5</td> <td>5.0</td> <td>5 0</td> </tr> <tr> <td>821 to 896</td> <td>1.5</td> <td>2.5</td> <td>2.5</td> </tr> <tr> <td>928 to 929.</td> <td>5.0</td> <td>N/A</td> <td>N/A</td> </tr> <tr> <td>929 to 960.</td> <td>1.5</td> <td>N/A</td> <td>N/A</td> </tr> <tr> <td>2110 to 2220</td> <td>10.0</td> <td>N/A</td> <td>N/A</td> </tr> </tbody> </table>		Frequency Range (MHz)	Base, fixed (ppm)	Mobile ≤ 3 watts (ppm)	Mobile ≤ 3 watts (ppm)	25 to 50	20.0	20.0	50.0	to 450	5.0	5.0	50.0	450 to 512	2.5	5.0	5 0	821 to 896	1.5	2.5	2.5	928 to 929.	5.0	N/A	N/A	929 to 960.	1.5	N/A	N/A	2110 to 2220	10.0	N/A	N/A
		Frequency Range (MHz)		Base, fixed (ppm)	Mobile ≤ 3 watts (ppm)	Mobile ≤ 3 watts (ppm)																													
		25 to 50		20.0	20.0	50.0																													
		to 450		5.0	5.0	50.0																													
		450 to 512		2.5	5.0	5 0																													
		821 to 896		1.5	2.5	2.5																													
		928 to 929.		5.0	N/A	N/A																													
		929 to 960.		1.5	N/A	N/A																													
2110 to 2220	10.0	N/A	N/A																																
According to §24.235, the frequency stability shall be sufficient to ensure that the fundamental emissions stay within the authorized frequency block.																																			
According to §27.54, The frequency stability shall be sufficient to ensure that the fundamental emissions stay within the authorized bands of operation.																																			

Test setup	
Procedure	<p>A communication link was established between EUT and base station. The frequency error was monitored and measured by base station under variation of ambient temperature and variation of primary supply voltage.</p> <p>Limit: The frequency stability of the transmitter shall be maintained within $\pm 0.00025\%$ ($\pm 2.5\text{ppm}$) of the center frequency.</p>
Remark	<p>Frequency Stability versus Temperature: The Frequency tolerance of the carrier signal shall be maintained within 2.5ppm of the operating frequency over a temperature variation of -10°C to $+55^{\circ}\text{C}$ at normal supply voltage.</p>
Result	<input checked="" type="checkbox"/> Pass <input type="checkbox"/> Fail

Test Data Yes N/A

Test Plot Yes (See below) N/A

LTE Band 4 (Part 27) result

Middle Channel, $f_0 = 1732.5$ MHz				
Temperature (°C)	Power Supplied (V _{DC})	Frequency Error (Hz)	Frequency Error (ppm)	Limit (ppm)
-10	3.7	17	0.0098	2.5
0		15	0.0087	2.5
10		10	0.0058	2.5
20		8	0.0046	2.5
30		11	0.0063	2.5
40		13	0.0075	2.5
50		17	0.0098	2.5
55		19	0.0110	2.5
25	4.2	11	0.0063	2.5
	3.5	13	0.0075	2.5

Annex A. TEST INSTRUMENT

Instrument	Model	Serial #	Cal Date	Cal Due	In use
RF Conducted Test					
Agilent ESA-E SERIES SPECTRUM ANALYZER	E4407B	MY45108319	09/16/2015	09/15/2016	<input checked="" type="checkbox"/>
Power Splitter	1#	1#	09/01/2015	08/31/2016	<input checked="" type="checkbox"/>
Universal Radio Communication Tester	CMU200	121393	09/25/2015	09/24/2016	<input checked="" type="checkbox"/>
Wideband Radio Communication Tester	CMW500	120906	03/27/2016	03/26/2017	<input checked="" type="checkbox"/>
Temperature/Humidity Chamber	UHL-270	001	10/09/2015	10/08/2016	<input checked="" type="checkbox"/>
DC Power Supply	E3640A	MY40004013	09/17/2015	09/16/2016	<input checked="" type="checkbox"/>
RF Power Sensor	Dare RPR3006C/P/W	AY554013	09/17/2015	09/16/2016	<input checked="" type="checkbox"/>
Radiated Emissions					
EMI test receiver	ESL6	100262	09/17/2015	09/16/2016	<input checked="" type="checkbox"/>
OPT 010 AMPLIFIER (0.1-1300MHz)	8447E	2727A02430	09/01/2015	08/31/2016	<input checked="" type="checkbox"/>
Microwave Preamplifier (0.5 ~ 18GHz)	PAM-118	443008	09/01/2015	08/31/2016	<input checked="" type="checkbox"/>
Bilog Antenna (30MHz~6GHz)	JB6	A110712	09/21/2015	09/20/2016	<input checked="" type="checkbox"/>
Bilog Antenna (30MHz~2GHz)	JB1	A112017	09/21/2015	09/20/2016	<input checked="" type="checkbox"/>
Double Ridge Horn Antenna (1 ~18GHz)	AH-118	71259	09/24/2015	09/23/2016	<input checked="" type="checkbox"/>
Double Ridge Horn Antenna (1 ~18GHz)	AH-118	71283	09/24/2015	09/23/2016	<input checked="" type="checkbox"/>
SYNTHESIZED SIGNAL GENERATOR	8665B	3744A01293	09/17/2015	09/16/2016	<input checked="" type="checkbox"/>
Tunable Notch Filter	3NF-800/1000-S	AA4	09/01/2015	08/31/2016	<input checked="" type="checkbox"/>

Test Report	16070595-FCC-R5
Page	50 of 60

Tunable Notch Filter	3NF- 1000/2000-S	AM 4	09/01/2015	08/31/2016	<input checked="" type="checkbox"/>
----------------------	---------------------	------	------------	------------	-------------------------------------

Annex B. EUT And Test Setup Photographs

Annex B.i. Photograph: EUT External Photo



Whole Package View



Adapter - Front View



EUT - Front View



EUT - Rear View



EUT - Top View



EUT - Bottom View

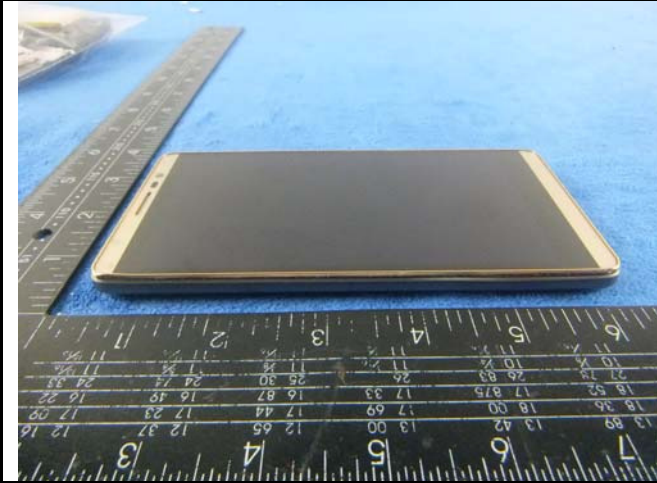

EUT - Left View

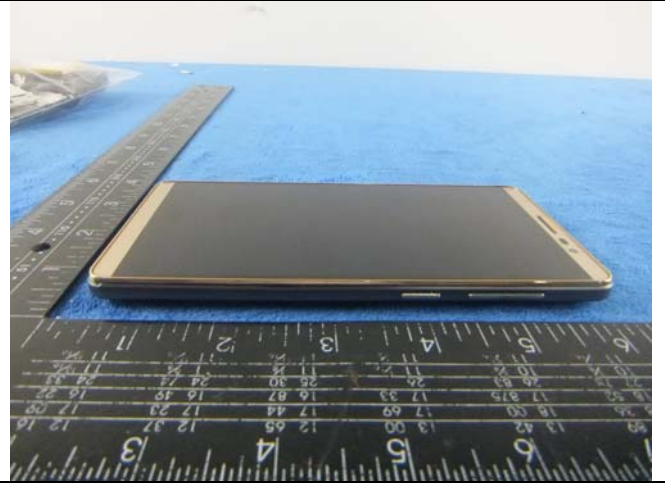

EUT - Right View

Annex B.ii. Photograph: EUT Internal Photo



Cover Off - Top View 1



Battery - Front View



Battery - Rear View

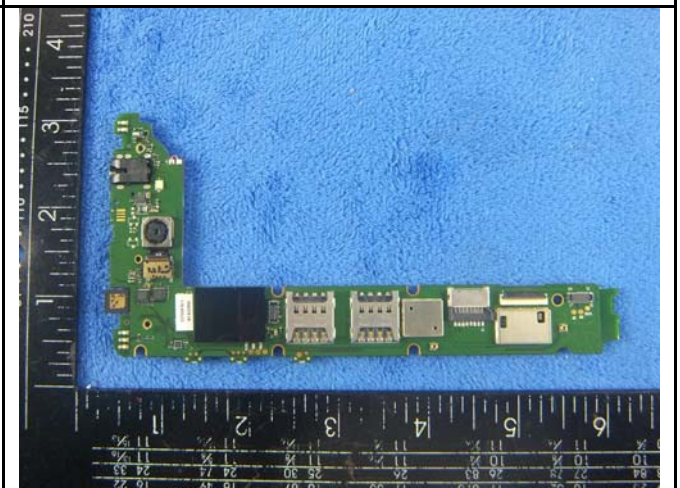

Mainboard with Shielding - Front View

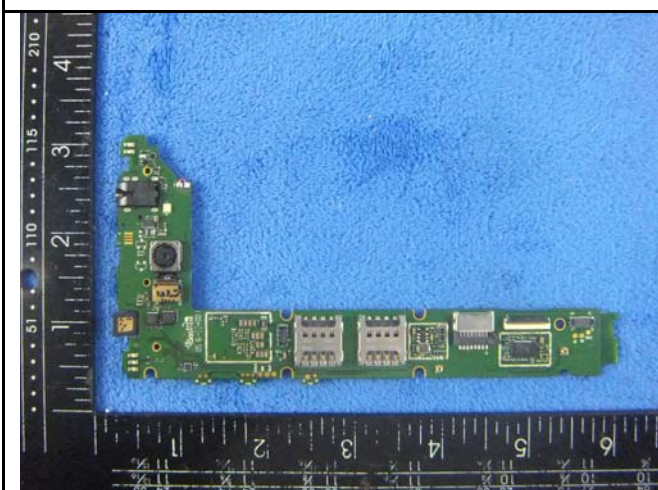

Mainboard without Shielding - Front View

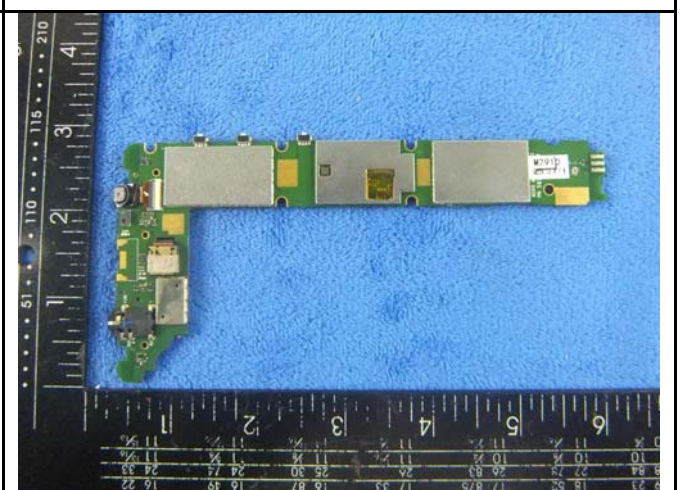

Mainboard - Rear View

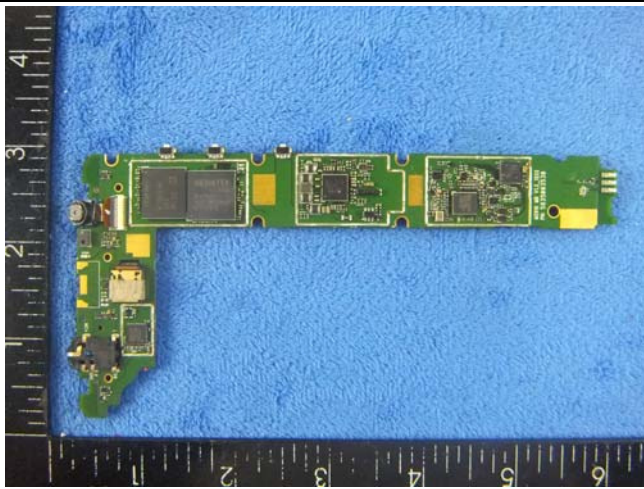

LCD – Front View



LCD – Rear View



GSM/PCS/UMTS-FDD Antenna View



LTE - Antenna View



WIFI/BT/BLE/GPS - Antenna View

Annex B.iii. Photograph: Test Setup Photo

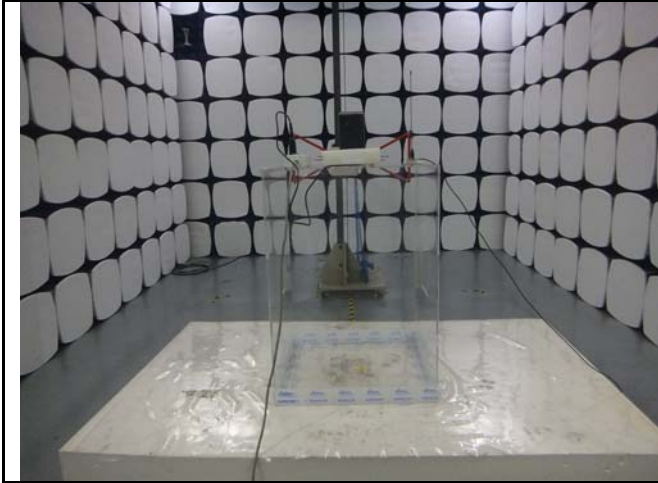

Radiated Spurious Emissions Test Setup Below 1GHz

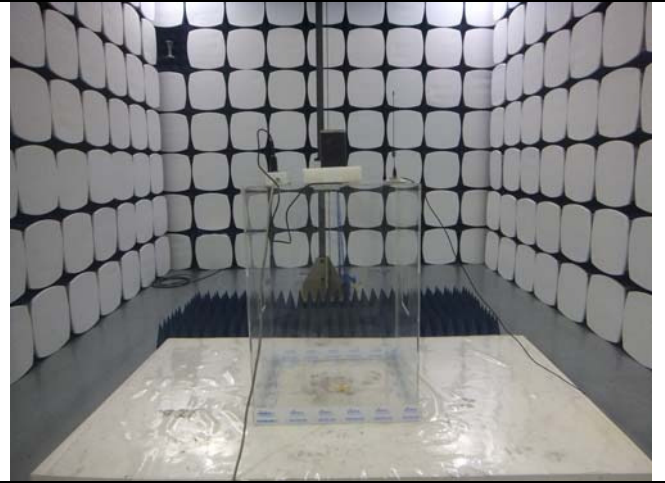

Radiated Spurious Emissions Test Setup Above
1GHz

Annex C. TEST SETUP AND SUPPORTING EQUIPMENT

Annex C.ii. TEST SET UP BLOCK

Block Configuration Diagram for Radiated Emissions

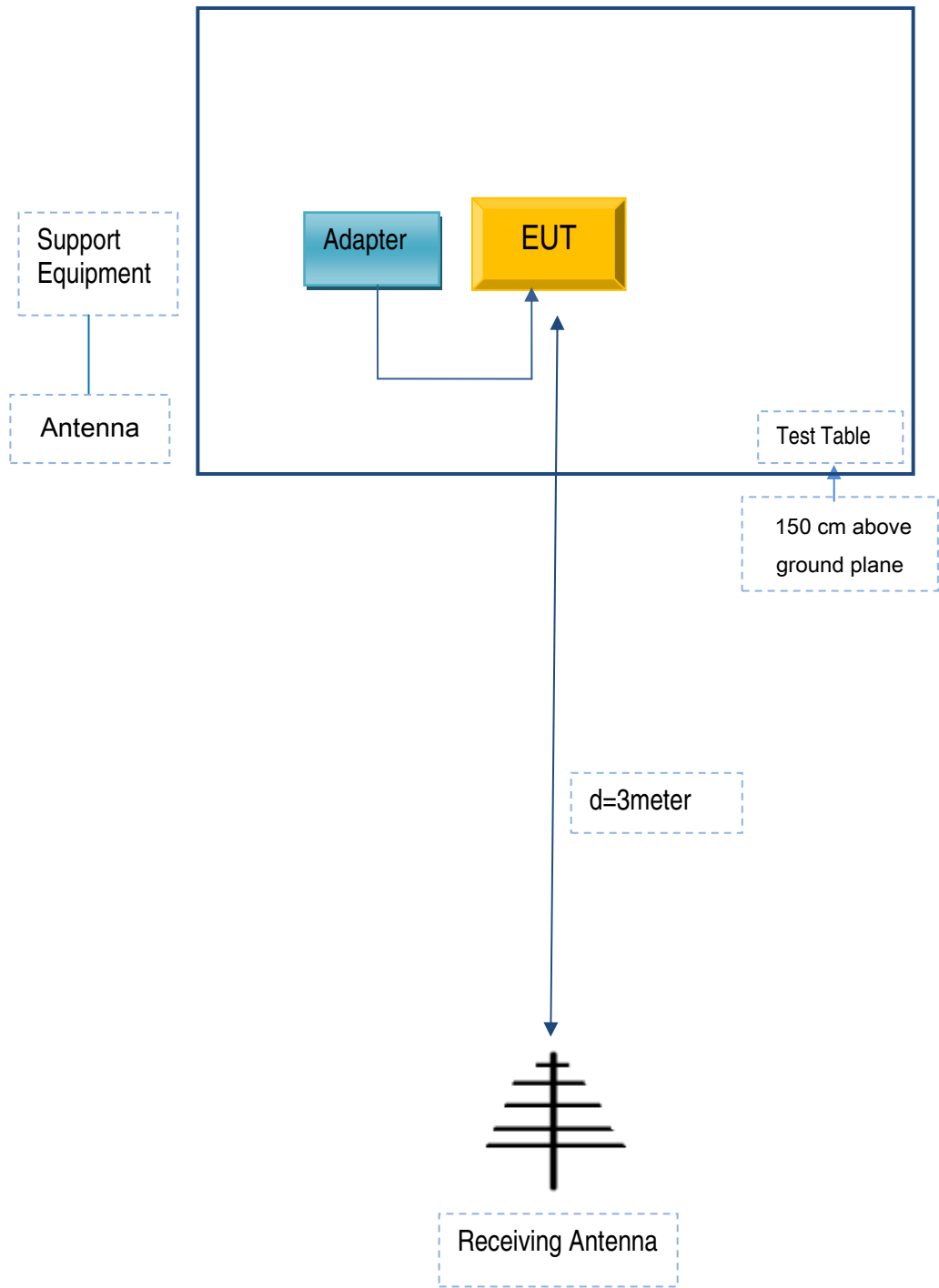

Annex C. ii. SUPPORTING EQUIPMENT DESCRIPTION

The following is a description of supporting equipment and details of cables used with the EUT.

Supporting Equipment:

Manufacturer	Equipment Description	Model	Serial No
Shenzhen Konka Telecommunications Technology Co., Ltd.	Adapter	HJ-050100-AR	HJ16C1C00004

Supporting Cable:

Cable type	Shield Type	Ferrite Core	Length	Serial No
USB Cable	Un-shielding	No	0.8m	HJ16C1C00004

Test Report	16070595-FCC-R5
Page	58 of 60

Annex C.ii. EUT OPERATING CONKITIONS

N/A

Test Report	16070595-FCC-R5
Page	59 of 60

Annex D. User Manual / Block Diagram / Schematics / Partlist

See attachment

Test Report	16070595-FCC-R5
Page	60 of 60

Annex E. DECLARATION OF SIMILARITY

N/A