



HCT CO., LTD.

Product Compliance Division

TEL : +82 31 639 8518 FAX : +82 31 639 8525

CERTIFICATE OF COMPLIANCE

FCC Part 27 & 24 & 22 Certification

Applicant Name: Cal-Comp Electronics & Communications Company Limited	Date of Testing: October 28, 2008
Address: 3F., No.99, NAN-KING E.RD.,SEC.5, Taipei 105, Taiw, Taipei, 105, Taiwan	Test Site/Location: HCT.CO., LTD., San 136-1 Ami-ri, Bubal-eup, Icheon-si, Kyungki-do, Korea
	Test Report No.: HCT-R08-200
	HCT FRN: 0005866421

FCC ID : US7-A600

APPLICANT : Cal-Comp Electronics & Communications Company Limited

Application Type:	Certification
FCC Classification:	PCS Licensed Transmitter (PCB)
FCC Rule Part(s):	§22, §24, §27, §2
EUT Type:	Tri-Band CDMA/EVDO USB Modem(CDMA/ PCS CDMA/ AWS CDMA)
Model(s):	A600
Tx Frequency:	824.70 — 848.31 MHz (CDMA) 1 851.25 — 1 908.75 MHz (PCS CDMA) 1 711.25 — 1 753.75 MHz (AWS CDMA)
Rx Frequency:	869.70 — 893.31 MHz (CDMA) 1 931.25 — 1 988.75 MHz (PCS CDMA) 2 111.25 — 2 153.75 MHz (AWS CDMA)
Max. RF Output Power:	0.296 W ERP CDMA (24.71 dBm) / 0.708 W EIRP PCS CDMA (28.50 dBm) 0.346 W ERP CDMA EVDO (25.39 dBm) / 0.736 W EIRP PCS EVDO (28.67 dBm) 0.278 W EIRP AWS CDMA (24.44 dBm) / 0.317 W EIRP AWS EVDO (25.02 dBm)
Emission Designator(s):	1M28F9W (CDMA), 1M28F9W (PCS CDMA), 1M28F9W(AWS CDMA) 1M28F9W (CDMA EVDO), 1M28F9W (PCS EVDO), 1M27F9W(AWS EVDO)

The measurements shown in this report were made in accordance with the procedures specified in §2.947. I assume full responsibility for the accuracy and completeness of these measurements, and for the qualifications of all persons taking them.

HCT.CO., LTD. Certifies that no party to this application has been denied FCC benefits pursuant to section 5301 of the Anti-Drug Abuse Act of 1998,21 U.S. C.853(a)

Report prepared by

: Jong Seok Lee

Test engineer of RF Part

Approved by

: Sang Jun Lee

Manager of RF Part

This report only responds to the tested sample and may not be reproduced, except in full, without written approval of the HCT Co., Ltd.

FCC CERTIFICATION REPORT				www.hct.co.kr
Test Report No. HCT-R08-200	Test Dates: October 28, 2008	EUT Type: Tri-Band CDMA/EVDO USB Modem(CDMA/ PCS CDMA/ AWS CDMA)	FCC ID: US7-A600	Page 1 of 39



Table of Contents

1. GENERAL INFORMATION	3
2. INTRODUCTION	4
2.1. EUT DESCRIPTION.....	4
2.2. MEASURING INSTRUMENT CALIBRATION.....	4
2.3. TEST FACILITY	4
3. DESCRIPTION OF TESTS	5
3.1 Effective Radiated Power/Equivalent Isotropic Radiated Power.....	5
3.2 Occupied bandwidth.	6
3.3 Spurious and Harmonic Emissions at Antenna Terminal.....	6
3.4 Radiated Spurious and Harmonic Emissions	7
3.5 Frequency stability / variation of ambient temperature	8
4. LIST OF TEST EQUIPMENT	9
5. SUMMARY OF TEST RESULTS	10
6. SAMPLE CALCULATION.....	11
7. TEST DATA	12
7.1 Conducted Output Power	12
7.2 Effective Radiated Power Output(CDMA)	14
7.3 Equivalent Isotropic Radiated Power (E.I.R.P.) (PCS/AWS CDMA).....	15
7.4 Radiated Spurious Emissions(CDMA Mode).....	16
7.5 Radiated Spurious Emissions(PCS CDMA Mode)	17
7.6 Radiated Spurious Emissions(AWS CDMA Mode)	18
7.8 Frequency stability / variation of ambient temperature	19
7.8.1 FREQUENCY STABILITY (CDMA).....	19
7.8.2 FREQUENCY STABILITY (PCS CDMA).....	20
7.8.3 FREQUENCY STABILITY (AWS CDMA)	21
8. TEST PLOTS.....	22



MEASUREMENT REPORT

1. GENERAL INFORMATION

Applicant Name: Cal-Comp Electronics & Communications Company Limited

Address: 3F., No.99, NAN-KING E.RD.,SEC.5, Taipei 105, Taiw,
Taipei, 105, Taiwan

Contact: TEL : 02-2662-2660#7532 / FAX : 02-8913-2001#7573

FCC ID: US7-A600

Application Type: Certification

FCC Classification: PCS Licensed Transmitter (PCB)

FCC Rule Part(s): §22, §24, §27, §2

EUT Type: Tri-Band CDMA/EVDO USB Modem(CDMA/ PCS CDMA/ AWS CDMA)

Model(s): A600

Tx Frequency: 824.70 — 848.31 MHz (CDMA)
1 851.25 — 1 908.75 MHz (PCS CDMA)
1 711.25 — 1 753.75 MHz (AWS CDMA)

Rx Frequency: 869.70 — 893.31 MHz (CDMA)
1 931.25 — 1 988.75 MHz (PCS CDMA)
2 111.25 — 2 153.75 MHz (AWS CDMA)

Max. RF Output Power: 0.296 W ERP CDMA (24.71 dBm) / 0.708 W EIRP PCS CDMA (28.50 dBm)
0.346 W ERP CDMA EVDO(25.39 dBm) / 0.736 W EIRP PCS EVDO(28.67 dBm)
0.278 W EIRP AWS CDMA(24.44 dBm)/ 0.317 W EIRP AWS EVDO(25.02 dBm)

Emission Designator(s): 1M28F9W (CDMA), 1M28F9W (PCS CDMA), 1M28F9W(AWS CDMA)
1M28F9W (CDMA EVDO), 1M28F9W (PCS EVDO), 1M27F9W(AWS EVDO)

Antenna Specification Manufacturer: SB TELCOM CO., LTD
Antenna type: Internal Antenna
Peak Gain: -6.12 dBi

Date(s) of Tests: October 28, 2008

Place of Tests: HCT.CO., LTD.
San 136-1 Ami-ri, Bubal-eup, Icheon-si,

Report Serial No HCT-R08-200

FCC CERTIFICATION REPORT				www.hct.co.kr
Test Report No. HCT-R08-200	Test Dates: October 28, 2008	EUT Type: Tri-Band CDMA/EVDO USB Modem(CDMA/ PCS CDMA/ AWS CDMA)	FCC ID: US7-A600	Page 3 of 39



2. INTRODUCTION

2.1. EUT DESCRIPTION

The A600 Tri-Band CDMA/EVDO USB Modem consists of Cellular CDMA, PCS CDMA, AWS CDMA and 1xEvDO Rev.A.

2.2. MEASURING INSTRUMENT CALIBRATION

The measuring equipment, which was utilized in performing the tests documented herein, has been calibrated in accordance with the manufacturer's recommendations for utilizing calibration equipment, which is traceable to recognized national standards.

2.3. TEST FACILITY

The open area test site and conducted measurement facility used to collect the radiated data are located at the 254-1, Maekok-Ri, Hobup-Myun, Ichon-Si, Kyoungki-Do, 467-701, KOREA. The site is constructed in conformance with the requirements of ANSI C63.4 and CISPR Publication 22. Detailed description of test facility was submitted to the Commission and accepted dated July 6, 2006(Registration Number: 90661)

FCC CERTIFICATION REPORT				www.hct.co.kr
Test Report No. HCT-R08-200	Test Dates: October 28, 2008	EUT Type: Tri-Band CDMA/EVDO USB Modem(CDMA/ PCS CDMA/ AWS CDMA	FCC ID: US7-A600	Page 4 of 39

3. DESCRIPTION OF TESTS

The EUT was connected to the host device using a USB cable (possibly a ferrite core) during the Test.

3.1 Effective Radiated Power/Equivalent Isotropic Radiated Power

Test Set-up

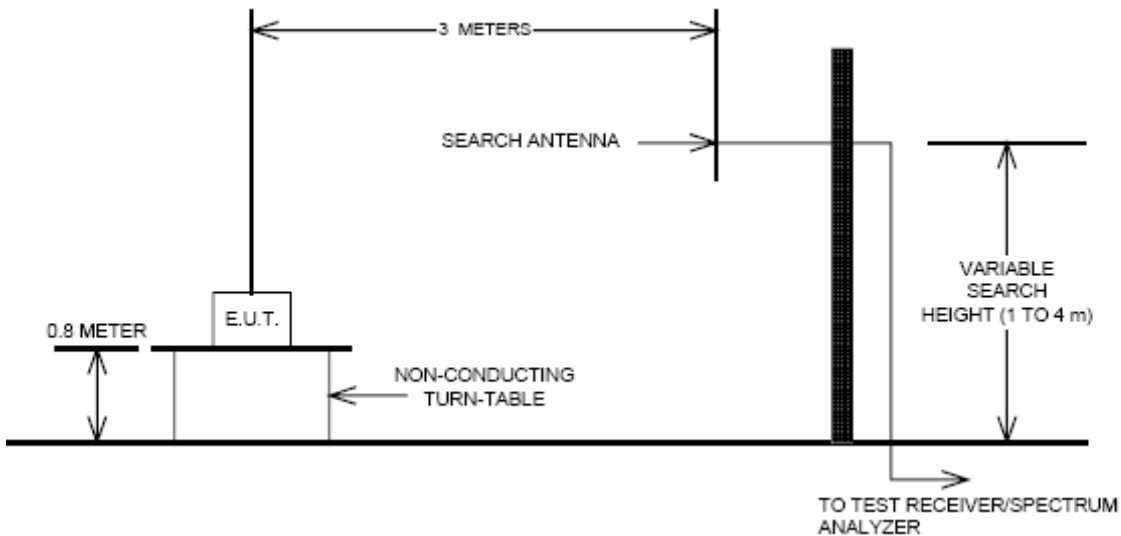

Test Procedure

Radiated emission measurements were performed at an open Site.

The equipment under test is placed on a wooden turntable 3-meters from the receive antenna.

A wooden turntable was rotated 360° and the receiving antenna scanned from 1-4m in order to capture the maximum emission. A half wave dipole was substituted in place of the EUT. This dipole antenna was driven by a signal generator and the previously recorded signal was duplicated.

The maximum EIRP was calculated by adding the forward power to the calibrated source plus its appropriate gain value. These steps were carried out with the receiving antenna in both vertical and horizontal polarization. For readings above 1GHz, the above procedure is repeated using horn antennas and the difference between the gain of the horn and an isotropic antenna are taken into consideration.

Note : This device was tested under all R.C.s and S.O.s and worst case is reported with RC3/SO55, with 'All Up' power control bits.

FCC CERTIFICATION REPORT				www.hct.co.kr
Test Report No. HCT-R08-200	Test Dates: October 28, 2008	EUT Type: Tri-Band CDMA/EVDO USB Modem(CDMA/ PCS CDMA/ AWS CDMA	FCC ID: US7-A600	Page 5 of 39

3.2 Occupied bandwidth.

Test set-up

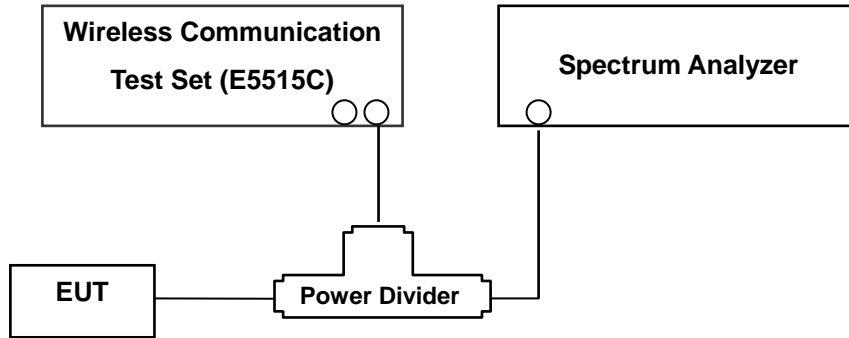

(Configuration of conducted Emission measurement)
Test Procedure

The EUT was setup to maximum output power at its lowest channel. The occupied bandwidth was measured using a spectrum analyzer. The measurements are repeated for the highest and a middle channel. The EUT's occupied bandwidth is measured as the width of the signal between two points, one below the carrier center frequency and one above the carrier frequency, outside of which all emissions are attenuated at least 26 dB below the transmitter power. Plots of the EUT's occupied bandwidth are shown herein.

Note : This device was tested under all R.C.s and S.O.s and worst case is reported with RC3/SO55, with 'All Up' power control bits.

3.3 Spurious and Harmonic Emissions at Antenna Terminal.

Test Procedure

The level of the carrier and the various conducted spurious and harmonic frequencies is measured by means of a calibrated spectrum analyzer.

The EUT was setup to maximum output power at its lowest channel. The Resolution BW of the analyzer is set to 1 % of the emission bandwidth to show compliance with the – 13 dBm limit, in the 1 MHz bands immediately outside and adjacent to the edge of the frequency block. The 1 MHz RBW was used to scan from 30 MHz to 10 GHz. (PCS CDMA Mode: 30 MHz to 20 GHz). A display line was placed at – 13 dBm to show compliance. The high, lowest and a middle channel were tested for out of band measurements.

Note : This device was tested under all R.C.s and S.O.s and worst case is reported with RC3/SO55, with 'All Up' power control bits.

FCC CERTIFICATION REPORT				www.hct.co.kr
Test Report No. HCT-R08-200	Test Dates: October 28, 2008	EUT Type: Tri-Band CDMA/EVDO USB Modem(CDMA/ PCS CDMA/ AWS CDMA	FCC ID: US7-A600	Page 6 of 39

3.4 Radiated Spurious and Harmonic Emissions

Test Set-up

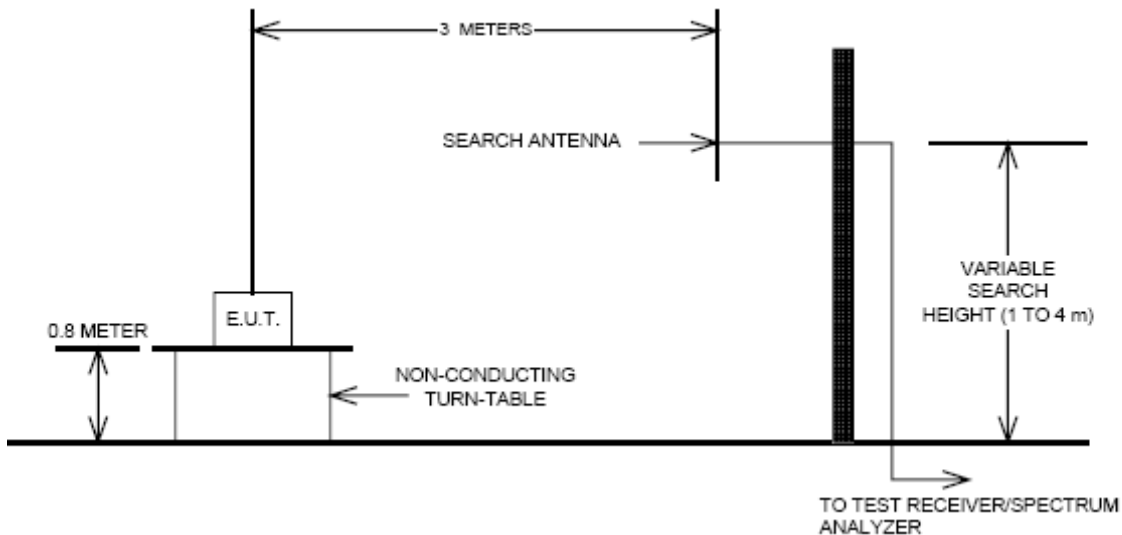

The measurement facilities used for this test have been documented in previous filings with the commission pursuant to section § 2.948. The open field test site is situated in open field with ground screen whose site attenuation characteristics meet ANSI C63.4 –2003. A mast capable of lifting the receiving antenna from a height of one to four meters is used together with a rotatable wooden platform mounted at three from the antenna mast.

- 1) The unit mounted on a wooden table 1.5 m × 1.0 m × 0.80 m is 0.8 meter above test site ground level.
- 2) During the emission test, the turntable is rotated and the EUT is manipulated to find the configuration resulting in maximum emission under normal condition of installation and operation.
- 3) The antenna height and polarization are also varied from 1 to 4 meters until the maximum signal is found.
- 4) The spectrum shall be scanned up to the 10th harmonic of the fundamental frequency.

Test Procedure

The equipment under test is placed on a wooden turntable 3-meters from the receive antenna.

A wooden turntable was rotated 360° and the receiving antenna scanned from 1-4m in order to capture the maximum emission. A half wave dipole was substituted in place of the EUT. This dipole antenna was driven by a signal generator and the previously recorded signal was duplicated.

The maximum EIRP was calculated by adding the forward power to the calibrated source plus its appropriate gain value. These steps were carried out with the receiving antenna in both vertical and horizontal polarization. For readings above 1GHz, the above procedure is repeated using horn antennas and the difference between the gain of the horn and an isotropic antenna are taken into consideration.

Note : This device was tested under all R.C.s and S.O.s and worst case is reported with RC3/SO55, with 'All Up' power control bits.

FCC CERTIFICATION REPORT				www.hct.co.kr
Test Report No. HCT-R08-200	Test Dates: October 28, 2008	EUT Type: Tri-Band CDMA/EVDO USB Modem(CDMA/ PCS CDMA/ AWS CDMA	FCC ID: US7-A600	Page 7 of 39

3.5 Frequency stability / variation of ambient temperature

Test Set-up

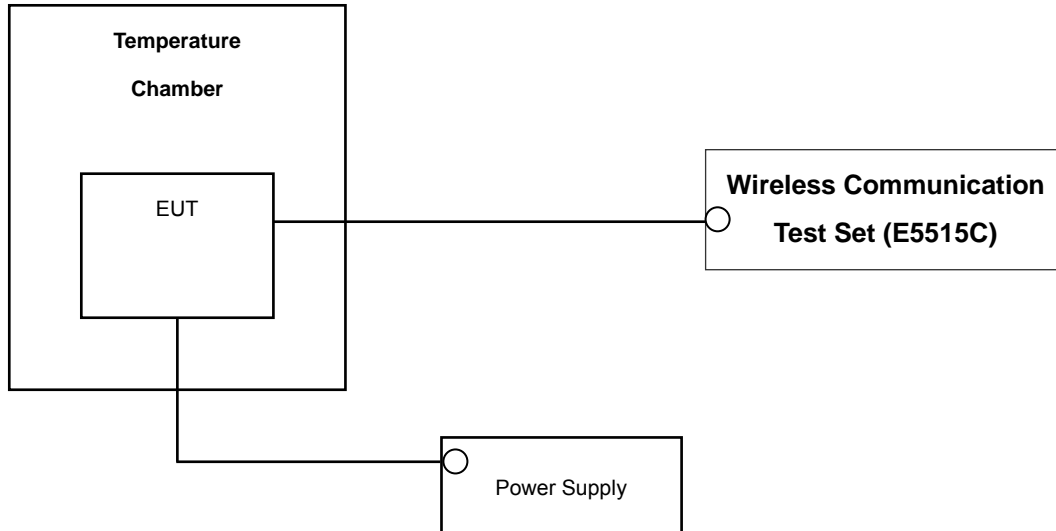

* Nominal Operating Voltage

Test Procedure

The frequency stability of the transmitter is measured by:

- a.) **Temperature:** The temperature is varied from - 30 °C to + 50 °C using an environmental chamber.
- b.) **Primary Supply Voltage:** The primary supply voltage is varied from battery end point to 115 % of the voltage normally at the input to the device or at the power supply terminals if cables are not normally supplied.

Specification — the frequency stability shall be sufficient to ensure that the fundamental emission stays within the authorized frequency block. The frequency stability of the transmitter shall be maintained within $\pm 0.00025\%$ (± 2.5 ppm) of the center frequency.

Time Period and Procedure:

The carrier frequency of the transmitter is measured at room temperature (20°C to provide a reference).

1. The equipment is turned on in a “standby” condition for one minute before applying power to the transmitter. Measurement of the carrier frequency of the transmitter is made within one minute after applying power to the transmitter.
2. Frequency measurements are made at 10°C intervals ranging from -30°C to +50°C. A period of at least one half-hour is provided to allow stabilization of the equipment at each temperature level.

NOTE: The EUT is tested down to the battery endpoint.

FCC CERTIFICATION REPORT				www.hct.co.kr
Test Report No. HCT-R08-200	Test Dates: October 28, 2008	EUT Type: Tri-Band CDMA/EVDO USB Modem(CDMA/ PCS CDMA/ AWS CDMA)	FCC ID: US7-A600	Page 8 of 39



4. LIST OF TEST EQUIPMENT

Manufacture	Model/ Equipment	Serial Number	Calibration Interval	Calibration Due
R&S	ESI40/ Spectrum Analyzer	831564/003	Annual	11/06/2008
Agilent	E4419B/ Power Meter	MY41291386	Annual	11/05/2008
Agilent	8481A/ Power Sensor	MY41090870	Annual	11/05/2008
Agilent	8960 (E5515C)/ Base Station	GB444400269	Annual	02/11/2009
Tescom	TC-3000/ Bluetooth Simulator	3000A4900112	Annual	01/11/2009
MITEQ	AMF-60-0010 1800-35-20P / AMP	1200937	Annual	01/15/2009
Wainwright	WHK1.2/15G-10EF/H.P.F	2	Annual	06/28/2009
Wainwright	WHK3.3/18G-10EF/H.P.F	1	Annual	06/28/2009
Agilent	778D/ Dual Directional Coupler	16072	Annual	11/09/2008
Agilent	1506A/ Power Divider	99441	Annual	11/10/2008
Digital	EP-3010/ Power Supply	3110117	Annual	12/29/2008
Schwarzbeck	UHAP/ Dipole Antenna	630	Annual	11/13/2008
Schwarzbeck	UHAP/ Dipole Antenna	605	Annual	11/13/2008
R&S	HFH2-Z2/ Loop Antenna	881056/070	Annual	12/11/2008
Korea Engineering	KR-1005L / Chamber	KRAB07063-2CH	Annual	01/05/2009
Schwarzbeck	VULB9160/ TRILOG Antenna	3150	Biennial	04/20/2009
Schwarzbeck	VULB9160/ TRILOG Antenna	3125	Biennial	05/16/2009
Schwarzbeck	BBHA 9120D/ Horn Antenna	147	Biennial	03/26/2010
Schwarzbeck	BBHA 9120D/ Horn Antenna	1201	Biennial	05/02/2009
Agilent	E4440A/Spectrum Analyzer	US45303008	Annual	01/08/2009

FCC CERTIFICATION REPORT				www.hct.co.kr
Test Report No. HCT-R08-200	Test Dates: October 28, 2008	EUT Type: Tri-Band CDMA/EVDO USB Modem(CDMA/ PCS CDMA/ AWS CDMA	FCC ID: US7-A600	Page 9 of 39



5. SUMMARY OF TEST RESULTS

FCC Part Section(s)	Test Description	Test Limit	Test Condition	Test Result
2.1049, 22.917(a), 24.238(a), 27.53(g)(1)	Occupied Bandwidth	N/A	CONDUCTED	PASS
2.1051, 22.917(a), 24.238(a), 27.53(g)	Band Edge / Spurious and Harmonic Emissions at Antenna Terminal.	< 43 + log ₁₀ (P[Watts]) at Band Edge and for all out-of-band emissions		PASS
2.1046	Conducted Output Power	N/A		PASS
2.1055, 22.355, 24.235, 27.54	Frequency stability / variation of ambient temperature	< 2.5 ppm		PASS
22.913(a)(2) 24.232(c), 27.50(d)(2)	Effective Radiated Power	< 7 Watts max. ERP	RADIATED	PASS
	Equivalent Isotropic Radiated Power	< 2 Watts max. EIRP(PCS) < 1 Watts max. EIRP(AWS)		PASS
2.1053, 22.917(a), 24.238(a), 27.53(g)	Radiated Spurious and Harmonic Emissions	< 43 + log ₁₀ (P[Watts]) for all out-of band emissions		PASS

FCC CERTIFICATION REPORT				www.hct.co.kr
Test Report No. HCT-R08-200	Test Dates: October 28, 2008	EUT Type: Tri-Band CDMA/EVDO USB Modem(CDMA/ PCS CDMA/ AWS CDMA)	FCC ID: US7-A600	Page 1 0 of 39



6. SAMPLE CALCULATION

A. ERP Sample Calculation

Mode	Ch./ Freq.		Measured Level(dBm)	Substitute LEVEL(dBm)	Ant. Gain	C.L	Pol.	ERP	
	channel	Freq.(MHz)						W	dBm
CDMA	384	836.52	-10.96	24.81	2.50	1.19	H	0.41	26.12

ERP = SubstituteLEVEL(dBm) + Ant. Gain – CL(Cable Loss)

- 1) The EUT mounted on a wooden tripod is 0.8 meter above test site ground level.
- 2) During the test , the turn table is rotated and the antenna height is also varied from 1 to 4 meters until the maximum signal is found.
- 3) Record the field strength meter's level.
- 4) Replace the EUT with dipole/Horn antenna that is connected to a calibrated signal generator.
- 5) Increase the signal generator output till the field strength meter's level is equal to the item (3).
- 6) The signal generator output level with Ant. Gain and cable loss are the rating of effective radiated power (ERP).

B. Emission Designator

CDMA Emission Designator

Emission Designator = 1M27F9W

CDMA BW = 1.27 MHz (Measured at the 99% power bandwidth)

F = Frequency Modulation

9 = Composite Digital Info

W = Combination (Audio/Data)

FCC CERTIFICATION REPORT				www.hct.co.kr
Test Report No. HCT-R08-200	Test Dates: October 28, 2008	EUT Type: Tri-Band CDMA/EVDO USB Modem(CDMA/ PCS CDMA/ AWS CDMA	FCC ID: US7-A600	Page 11 of 39

7. TEST DATA

7.1 Conducted Output Power

A base station simulator was used to establish communication with The Dual-Band CDMA/PCS Phone with Bluetooth. The base station simulator parameters were set to produce the maximum power from the EUT. This device was tested under all configurations and the highest power is reported. Conducted Output Powers of EUT are reported below.

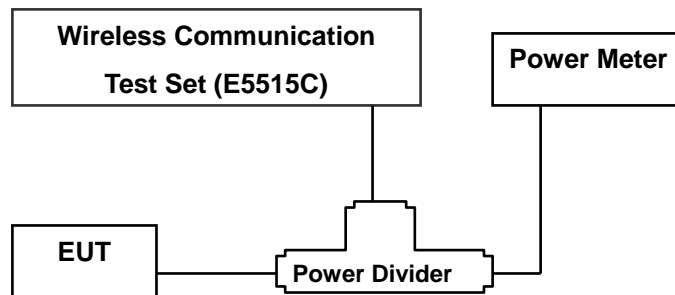

Band	Channel	SO2	SO2	SO55	SO55	TDSO	1xEVDO	1xEVDO	1xEVD	1xEVD
		RC1/1 (dBm)	RC3/3 (dBm)	RC1/1 (dBm)	RC3/3 (dBm)	SO32 (dBm)	Rev.0 (FTAP) (dBm)	Rev.0 (RTAP) (dBm)	O (FETA P)	O (RETA P)
CDMA	1013	23.65	23.59	23.66	23.61	23.48	23.35	23.40	23.49	23.48
	384	23.77	23.55	23.79	23.69	23.55	23.54	23.66	23.74	23.56
	777	23.36	23.18	23.35	23.28	23.16	23.19	23.21	23.46	23.32
PCS	25	23.36	23.48	23.37	23.44	23.27	23.48	23.52	23.40	23.42
	600	23.80	23.66	23.76	23.65	23.51	23.43	23.62	23.52	23.73
	1175	23.70	23.57	23.83	23.67	23.92	23.59	23.55	23.72	23.67
AWS	25	23.98	23.78	23.95	23.84	23.81	23.73	23.70	23.72	23.81
	450	23.78	23.66	23.72	23.77	23.44	23.45	23.45	23.62	23.56
	875	23.79	23.87	23.77	23.79	23.82	23.43	23.52	23.64	23.66

(Maximum Conducted Output Powers - without the USB Y-cable)



Band	Channel	SO2	SO2	SO55	SO55	TDSO SO32	1xEVDO Rev.0	1xEVDO Rev.0	1xEVDO Rev.A	1xEVDO Rev.A
		RC1/1 (dBm)	RC3/3 (dBm)	RC1/1 (dBm)	RC3/3 (dBm)	RC3/3 (dBm)	(FTAP) (dBm)	(RTAP) (dBm)	(FETAP) (dBm)	(RETAP) (dBm)
CDMA	1013	23.65	23.69	23.73	23.71	23.52	23.46	23.52	23.50	23.52
	384	23.84	23.68	23.69	23.75	23.58	23.49	23.51	23.70	23.44
	777	23.46	23.24	23.41	23.29	23.18	23.16	23.20	23.36	23.40
PCS	25	23.69	23.81	23.69	23.80	23.54	23.41	23.42	23.77	23.48
	600	23.72	23.85	23.79	23.86	23.46	23.56	23.58	23.53	23.80
	1175	23.89	23.80	23.88	23.87	23.78	23.64	23.77	23.74	23.67
AWS	25	23.99	24.06	24.04	24.00	23.83	23.90	23.96	24.00	23.96
	450	23.61	23.54	23.60	23.58	23.53	23.52	23.53	23.65	23.41
	875	23.85	23.81	23.86	23.78	23.69	23.67	23.76	23.64	23.71

(Maximum Conducted Output Powers - with the USB Y-cable)

FCC CERTIFICATION REPORT				www.hct.co.kr
Test Report No. HCT-R08-200	Test Dates: October 28, 2008	EUT Type: Tri-Band CDMA/EVDO USB Modem(CDMA/ PCS CDMA/ AWS CDMA	FCC ID: US7-A600	Page 13 of 39



7.2 Effective Radiated Power Output(CDMA)

(CDMA Mode)

Mode	Ch./ Freq.		Measured Level(dBm)	Substitute LEVEL (dBm)	Ant. Gain	C.L	Pol.	ERP	
	channel	Freq.(MHz)						W	dBm
CDMA	1013	824.70	-16.66	29.17	-8.31	1.17	V	0.09	19.69
	384	836.52	-16.66	29.83	-8.22	1.19	V	0.11	20.42
	777	848.31	-13.09	34.04	-8.13	1.20	V	0.30	24.71
EVDO	777	848.31	-12.41	34.72	-8.13	1.20	V	0.35	25.39

Note: Standard batteries are the only options for this phone

NOTES:

Effective Radiated Power Output Measurements by Substitution Method
according to ANSI/TIA/EIA-603-C-2004, Aug. 17, 2004:

The EUT was placed on a wooden turn table 3-meters from the receive antenna. The receive antenna height and turntable rotation was adjusted for the highest reading on the receive spectrum analyzer. For CDMA signals, a peak detector is used, with RBW = VBW = 3 MHz. For WCDMA signals, a peak detector is used, with RBW = VBW = 5MHz. For AMPS, GSM, and NADC TDMA signals, a peak detector is used, with RBW = VBW = 1 MHz. A half-wave dipole was substituted in place of the EUT. This dipole antenna was driven by a signal generator and the level of the signal generator was adjusted to obtain the same receive spectrum analyzer reading. The conducted power at the terminals of the dipole is measured. The ERP is recorded.

This device was tested under all configurations and the highest power is reported.

FCC CERTIFICATION REPORT				www.hct.co.kr
Test Report No. HCT-R08-200	Test Dates: October 28, 2008	EUT Type: Tri-Band CDMA/EVDO USB Modem(CDMA/ PCS CDMA/ AWS CDMA	FCC ID: US7-A600	Page 1 4 of 39



7.3 Equivalent Isotropic Radiated Power (E.I.R.P.) (PCS/AWS CDMA)

(PCS CDMA Mode)

Mode	Ch./ Freq.		Measured Level(dBm)	Substitute LEVEL (dBm)	Ant. Gain	C.L	Pol.	EIRP	
	channel	Freq.(MHz)						W	dBm
PCS	25	1,851.25	-11.24	20.37	10.05	1.91	V	0.71	28.50
	600	1,880.00	-12.50	19.32	10.05	1.95	V	0.55	27.42
	1175	1,908.75	-13.39	18.51	10.06	1.97	V	0.46	26.60
EVDO	25	1,851.25	-11.07	20.54	10.05	1.91	V	0.74	28.67

(AWS CDMA Mode)

Mode	Ch./ Freq.		Measured Level(dBm)	Substitute LEVEL (dBm)	Ant. Gain	C.L	Pol.	EIRP	
	channel	Freq.(MHz)						W	dBm
AWS	25	1,711.25	-14.81	16.56	9.61	1.86	V	0.27	24.32
	450	1,732.50	-14.76	16.60	9.70	1.87	V	0.28	24.44
	875	1,753.75	-15.55	15.80	9.80	1.88	V	0.24	23.72
EVDO	450	1,732.50	-14.18	17.18	9.70	1.87	v	0.32	25.02

Note: Standard batteries are the only options for this phone

NOTES:

Equivalent Isotropic Radiated Power Measurements by Substitution Method according to ANSI/TIA/EIA-603-C-2004, Aug. 17, 2004:

The EUT was placed on a wooden turn table 3-meters from the receive antenna. The receive antenna height and turntable rotation was adjusted for the highest reading on the receive spectrum analyzer. For CDMA signals, a peak detector is used, with RBW = VBW = 3 MHz. For WCDMA signals, a peak detector is used, with RBW = VBW = 5MHz. For AMPS, GSM, and NADC TDMA signals, a peak detector is used, with RBW = VBW = 1 MHz. A Horn antenna was substituted in place of the EUT. This Horn antenna was driven by a signal generator and the level of the signal generator was adjusted to obtain the same receive spectrum analyzer reading. The conducted power at the terminals of the Horn antenna is measured. The difference between the gain of the horn and an isotropic antenna is taken into consideration and the EIRP is recorded.

This device was tested under all configurations and the highest power is reported.

FCC CERTIFICATION REPORT				www.hct.co.kr
Test Report No. HCT-R08-200	Test Dates: October 28, 2008	EUT Type: Tri-Band CDMA/EVDO USB Modem(CDMA/ PCS CDMA/ AWS CDMA	FCC ID: US7-A600	Page 1 5 of 39



7.4 Radiated Spurious Emissions(CDMA Mode)

- MEASURED OUTPUT POWER: 24.71 dBm =0.5296W
- MODULATION SIGNAL: CDMA
- DISTANCE: 3 meters
- LIMIT: - (43 + 10 log₁₀ (W)) = -37.71 dBc

Ch.	Freq.(MHz)	Measured Level [dBm]	Ant. Gain	Substitute Level [dBm]	C.L	Pol.	ERP (dBm)	dBc
1013	1,649.40	-40.66	7.09	-51.19	1.73	H	-45.83	-70.54
	2,474.10	-53.84	8.12	-60.95	2.28	H	-55.11	-79.82
	3,298.80	-49.75	9.72	-57.33	2.57	H	-50.18	-74.89
384	1,673.04	-38.91	7.23	-49.67	1.79	H	-44.23	-68.94
	2,509.56	-52.83	8.14	-59.96	2.33	H	-54.15	-78.86
	3,346.08	-51.03	9.99	-59.06	2.66	H	-51.73	-76.44
777	1,696.62	-38.56	7.41	-49.17	1.83	H	-43.59	-68.30
	2,544.93	-50.45	8.21	-57.73	2.34	H	-51.86	-76.57
	3,393.24	-49.64	9.91	-57.27	2.85	H	-50.21	-74.92

NOTES: Radiated Spurious Emission Measurements at 3 meters by Substitution Method
according to ANSI/TIA/EIA-603-C-2004, Aug. 17, 2004:

FCC CERTIFICATION REPORT				www.hct.co.kr
Test Report No. HCT-R08-200	Test Dates: October 28, 2008	EUT Type: Tri-Band CDMA/EVDO USB Modem(CDMA/ PCS CDMA/ AWS CDMA	FCC ID: US7-A600	Page 16 of 39



7.5 Radiated Spurious Emissions(PCS CDMA Mode)

- MEASURED OUTPUT POWER: 28.50 dBm = 0.708 W
- MODULATION SIGNAL: PCS CDMA
- DISTANCE: 3 meters
- LIMIT: - (43 + 10 log₁₀(W)) = - 41.50 dBc

Ch.	Freq.(MHz)	Measured Level [dBm]	Ant. Gain	Substitute Level [dBm]	C.L	Pol.	ERP (dBm)	dBc
25	3,702.50	-45.48	10.31	-51.75	2.73	H	-44.17	-72.67
	5,553.75	-51.16	10.55	-52.74	3.60	H	-45.79	-74.29
	7,405.00	-56.26	9.21	-47.38	3.88	H	-42.05	-70.55
600	3,760.00	-39.59	10.32	-45.56	2.73	H	-37.97	-66.47
	5,640.00	-53.31	10.60	-54.96	3.60	H	-47.96	-76.46
	7,520.00	-55.57	9.18	-46.47	3.88	H	-41.17	-69.67
1175	3,817.50	-29.22	10.34	-35.10	2.73	H	-27.49	-55.99
	5,726.25	-50.70	10.65	-52.01	3.60	H	-44.96	-73.46
	7,635.00	-57.23	9.15	-47.90	3.88	H	-42.63	-71.13

NOTES: Radiated Spurious Emission Measurements at 3 meters by Substitution Method
according to ANSI/TIA/EIA-603-C-2004, Aug. 17, 2004:

FCC CERTIFICATION REPORT				www.hct.co.kr
Test Report No. HCT-R08-200	Test Dates: October 28, 2008	EUT Type: Tri-Band CDMA/EVDO USB Modem(CDMA/ PCS CDMA/ AWS CDMA	FCC ID: US7-A600	Page 17 of 39



7.6 Radiated Spurious Emissions(AWS CDMA Mode)

- MEASURED OUTPUT POWER: 24.44 dBm = 0.278 W
- MODULATION SIGNAL: AWS CDMA
- DISTANCE: 3 meters
- LIMIT: - (43 + 10 log₁₀(W)) = - 37.44 dBc

Ch.	Freq.(MHz)	Measured Level [dBm]	Ant. Gain	Substitute Level [dBm]	C.L	Pol.	ERP (dBm)	dBc
25	3,422.50	-39.29	9.94	-46.95	2.68	H	-39.69	-64.13
	5,133.75	-55.89	10.00	-55.88	3.38	H	-49.26	-73.70
	6,845.00	-56.62	10.86	-52.48	3.50	H	-45.12	-69.56
450	3,465.00	-38.78	10.10	-46.08	2.68	H	-38.66	-63.10
	5,197.50	-56.61	10.00	-56.81	3.55	H	-50.36	-74.80
	6,930.00	-55.15	11.39	-51.17	3.50	H	-43.28	-67.72
875	3,507.50	-34.46	10.30	-41.40	2.66	H	-33.76	-58.20
	5,261.25	-56.53	10.00	-57.20	3.60	H	-50.80	-75.24
	7,015.00	-56.86	11.56	-51.38	3.50	H	-43.32	-67.76

NOTES: Radiated Spurious Emission Measurements at 3 meters by Substitution Method
according to ANSI/TIA/EIA-603-C-2004, Aug. 17, 2004:

FCC CERTIFICATION REPORT				www.hct.co.kr
Test Report No. HCT-R08-200	Test Dates: October 28, 2008	EUT Type: Tri-Band CDMA/EVDO USB Modem(CDMA/ PCS CDMA/ AWS CDMA	FCC ID: US7-A600	Page 18 of 39



7.8 Frequency stability / variation of ambient temperature

7.8.1 FREQUENCY STABILITY (CDMA)

OPERATING FREQUENCY: 836,520,000 Hz
 CHANNEL: 384
 REFERENCE VOLTAGE: 3.7 VDC
 DEVIATION LIM IT: ± 0.000 25 % or 2.5 ppm

Voltage (%)	Power (VDC)	Temp. (°C)	Frequency (Hz)	Frequency Error (Hz)	Deviation (%)	ppm
100%	3.700	+20(Ref)	836 520 001	1.12	0.000 000	0.001
100%		-30	836 520 002	2	0.000 000	0.002
100%		-20	836 520 005	4.71	0.000 001	0.006
100%		-10	836 520 003	2.89	0.000 000	0.003
100%		0	836 519 997	-2.79	0.000 000	-0.003
100%		+10	836 519 996	-3.53	0.000 000	-0.004
100%		+20	836 520 001	1.34	0.000 000	0.002
100%		+30	836 520 002	2.39	0.000 000	0.003
100%		+40	836 519 997	-2.93	0.000 000	-0.004
100%		+50	836 520 001	1.44	0.000 000	0.002
115%	4.255	+20	836 520 002	2.08	0.000 000	0.002
Batt. Endpoint	3.400	+20	836 519 998	-1.82	0.000 000	-0.002

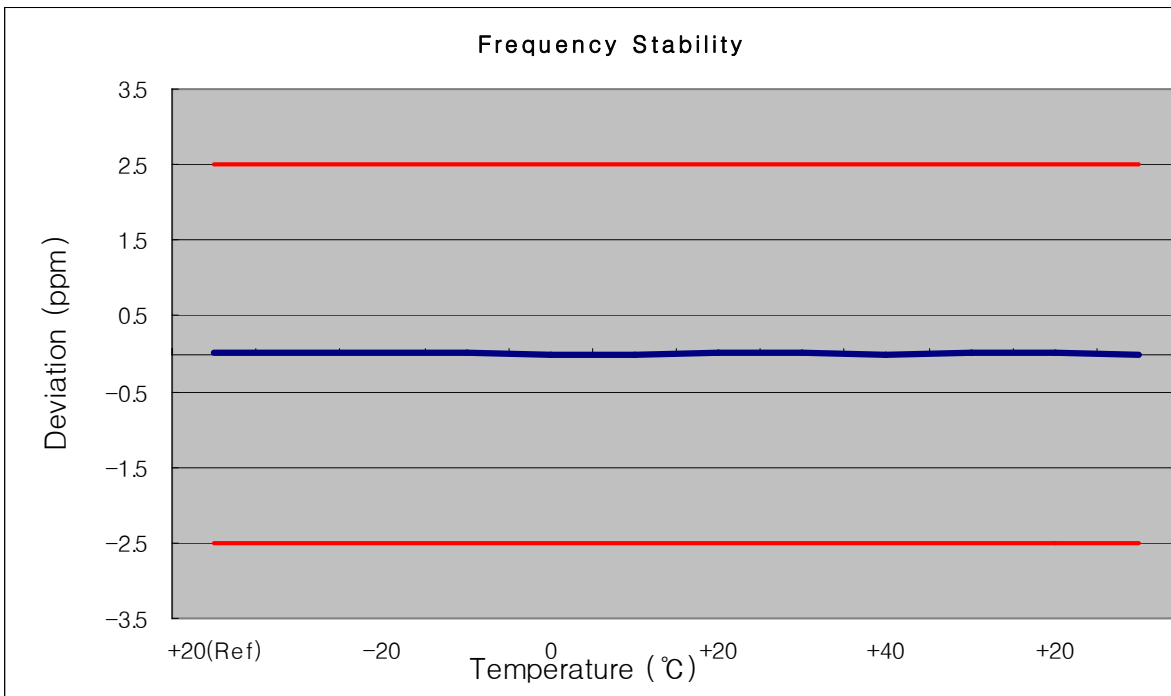



7.8.2 FREQUENCY STABILITY (PCS CDMA)

OPERATING FREQUENCY: 1880,000,000 Hz
 CHANNEL: 600
 REFERENCE VOLTAGE: 3.7 VDC
 DEVIATION LIM IT: ± 0.000 25 % or 2.5 ppm

Voltage (%)	Power (VDC)	Temp. (°C)	Frequency (Hz)	Frequency Error (Hz)	Deviation (%)	ppm
100%	3.700	+20(Ref)	1879 999 998	-2.16	0.000 000	-0.001
100%		-30	1879 999 995	-5.33	0.000 000	-0.003
100%		-20	1879 999 994	-6.16	0.000 000	-0.003
100%		-10	1879 999 997	-3.33	0.000 000	-0.002
100%		0	1879 999 994	-6.12	0.000 000	-0.003
100%		+10	1880 000 004	3.63	0.000 000	0.002
100%		+20	1880 000 014	14.44	0.000 001	0.008
100%		+30	1880 000 005	5.3	0.000 000	0.003
100%		+40	1880 000 011	10.62	0.000 001	0.006
100%		+50	1879 999 997	-2.72	0.000 000	-0.001
115%	4.255	+20	1879 999 992	-8.25	0.000 000	-0.004
Batt. Endpoint	3.400	+20	1880 000 012	11.8	0.000 001	0.006

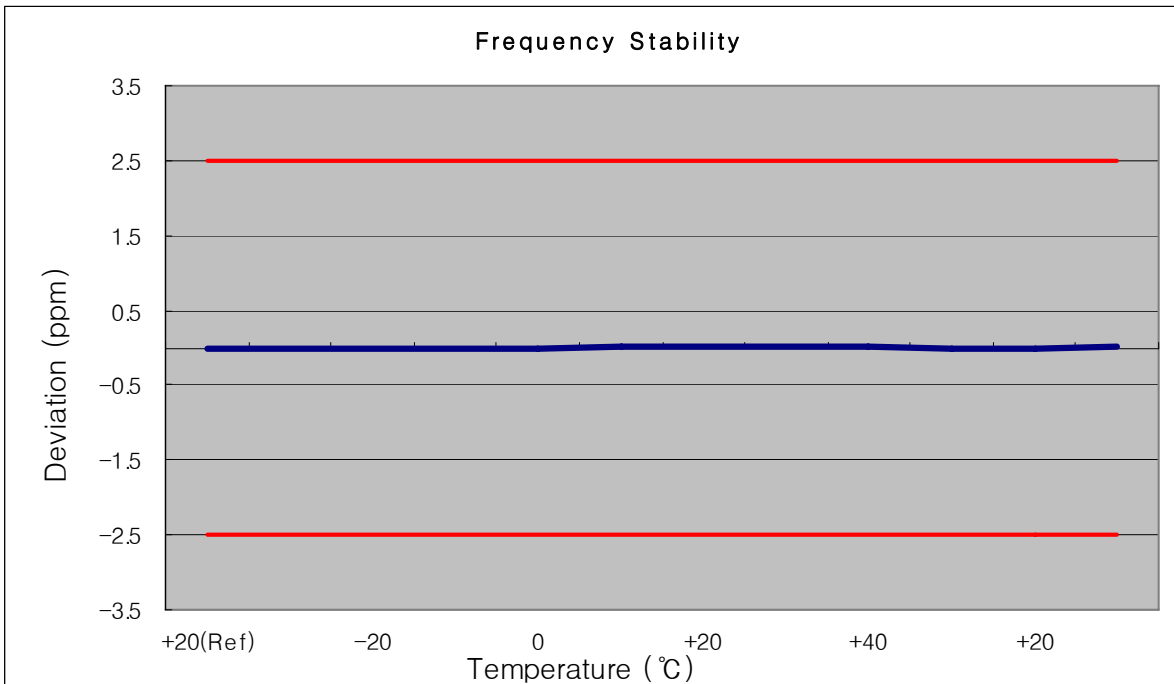



7.8.3 FREQUENCY STABILITY (AWS CDMA)

OPERATING FREQUENCY: 1732,500,000 Hz
 CHANNEL: 450
 REFERENCE VOLTAGE: 3.7 VDC
 DEVIATION LIM IT: ± 0.000 25 % or 2.5 ppm

Voltage (%)	Power (VDC)	Temp. (°C)	Frequency (Hz)	Frequency Error (Hz)	Deviation (%)	ppm
100%	3.700	+20(Ref)	1732 499 992	-7.83	0.000 000	-0.004
100%		-30	1732 499 995	-5.49	0.000 000	-0.003
100%		-20	1732 500 010	9.89	0.000 001	0.005
100%		-10	1732 499 993	-7.45	0.000 000	-0.004
100%		0	1732 499 995	-5.45	0.000 000	-0.003
100%		+10	1732 499 995	-4.75	0.000 000	-0.003
100%		+20	1732 499 996	-3.6	0.000 000	-0.002
100%		+30	1732 499 994	-6.09	0.000 000	-0.003
100%		+40	1732 500 006	6.01	0.000 000	0.003
100%		+50	1732 499 996	-4.23	0.000 000	-0.002
115%	4.255	+20	1732 499 994	-6.27	0.000 000	-0.003
Batt. Endpoint	3.400	+20	1732 499 994	-6.18	0.000 000	-0.003

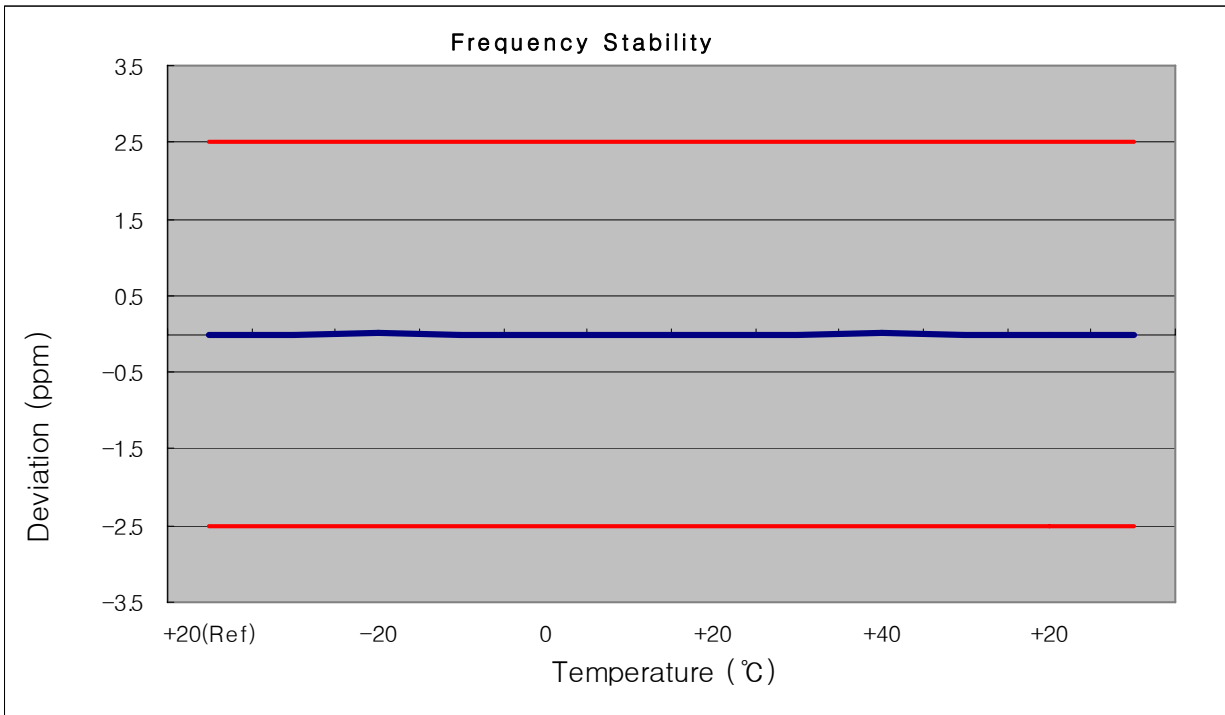



8. TEST PLOTS

FCC CERTIFICATION REPORT			www.hct.co.kr
Test Report No. HCT-R08-200	Test Dates: October 28, 2008	EUT Type: Tri-Band CDMA/EVDO USB Modem(CDMA/ PCS CDMA/ AWS CDMA	FCC ID: US7-A600
			Page 2 2 of 39



■ CDMA MODE (1013 CH.) Occupied Bandwidth

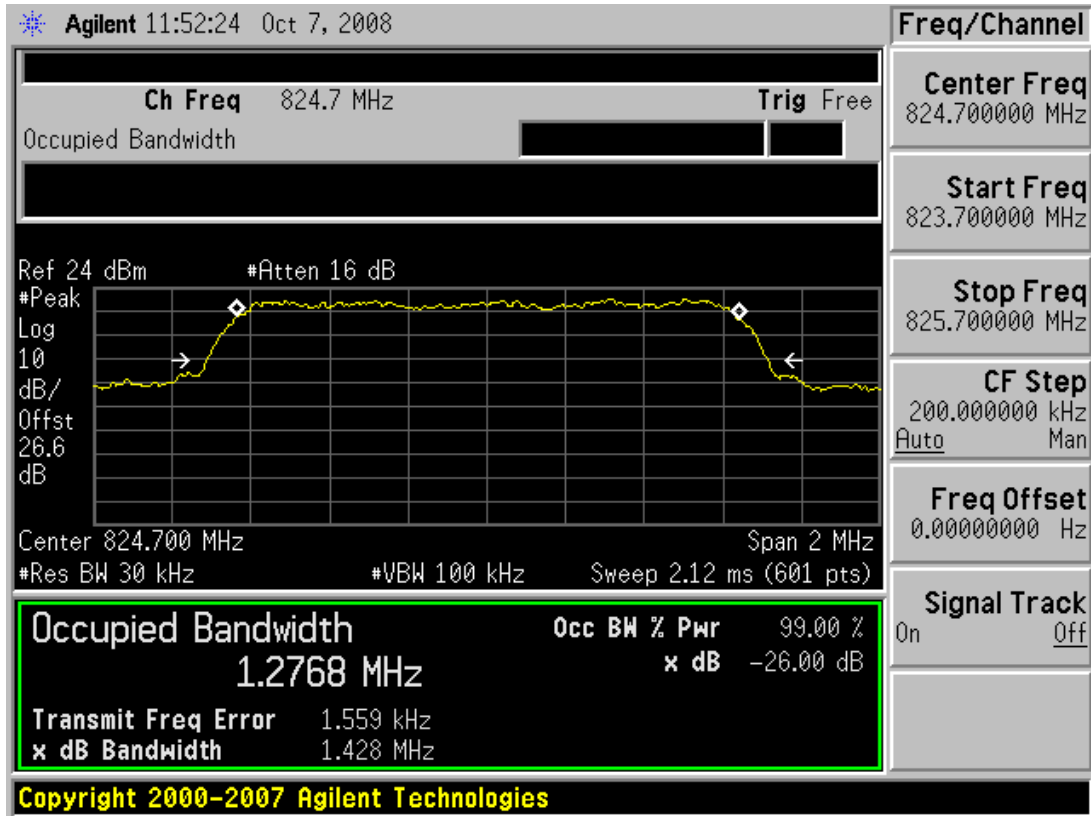

■ CDMA MODE (384 CH.) Occupied Bandwidth

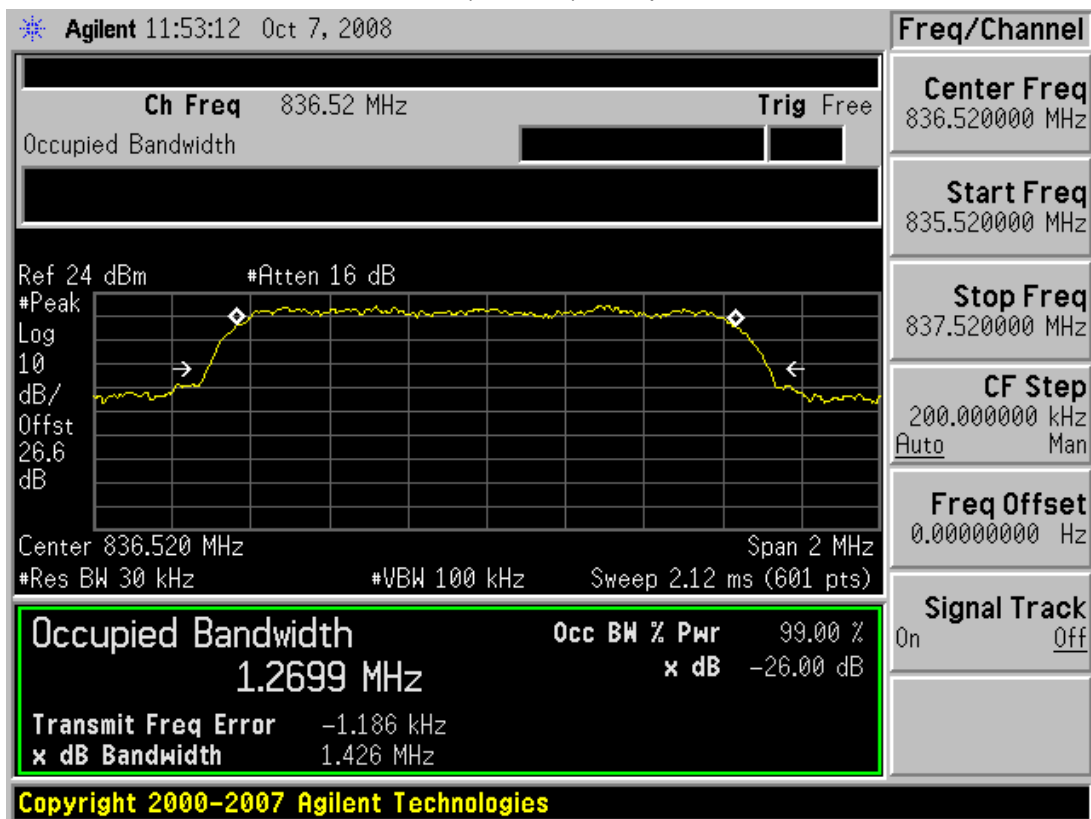

FCC CERTIFICATION REPORT			www.hct.co.kr
Test Report No. HCT-R08-200	Test Dates: October 28, 2008	EUT Type: Tri-Band CDMA/EVDO USB Modem(CDMA/ PCS CDMA/ AWS CDMA)	FCC ID: US7-A600
			Page 2 3 of 39



■ CDMA MODE (777 CH.) Occupied Bandwidth

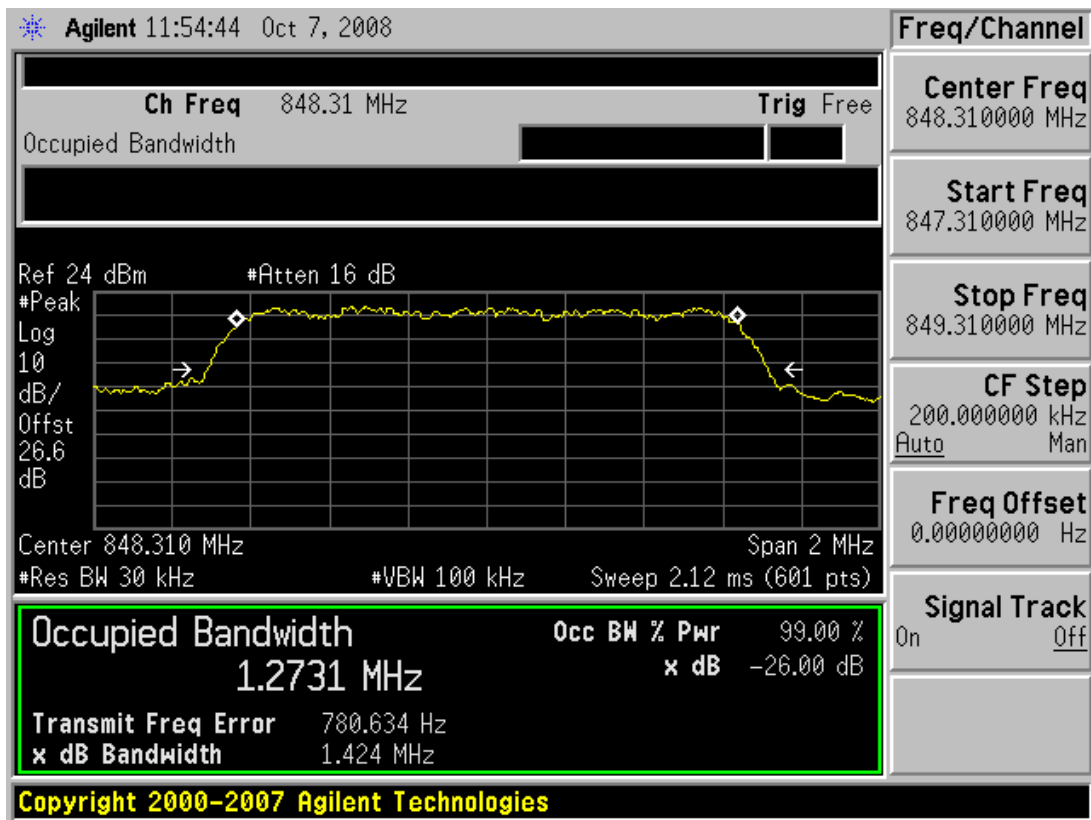

■ CDMA EVDO (1013 CH.) Occupied Bandwidth

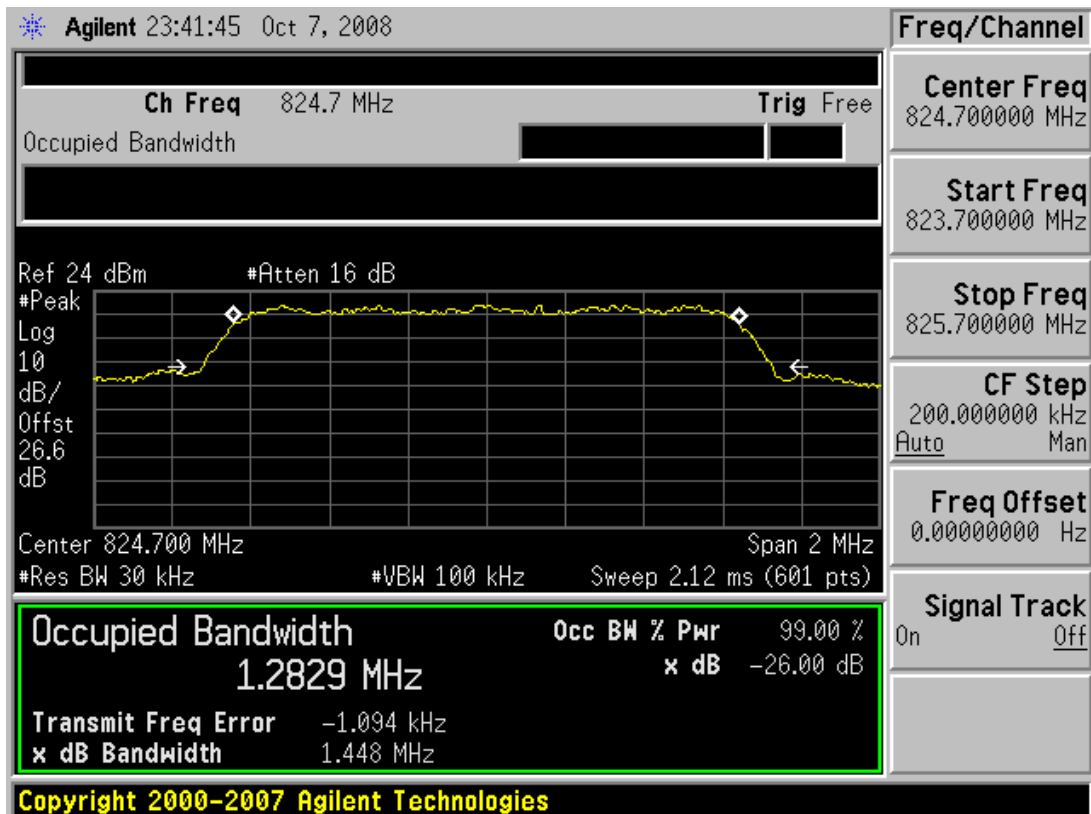

FCC CERTIFICATION REPORT			www.hct.co.kr
Test Report No. HCT-R08-200	Test Dates: October 28, 2008	EUT Type: Tri-Band CDMA/EVDO USB Modem(CDMA/ PCS CDMA/ AWS CDMA)	FCC ID: US7-A600 Page 24 of 39



■ PCS CDMA MODE (25 CH.) Occupied Bandwidth

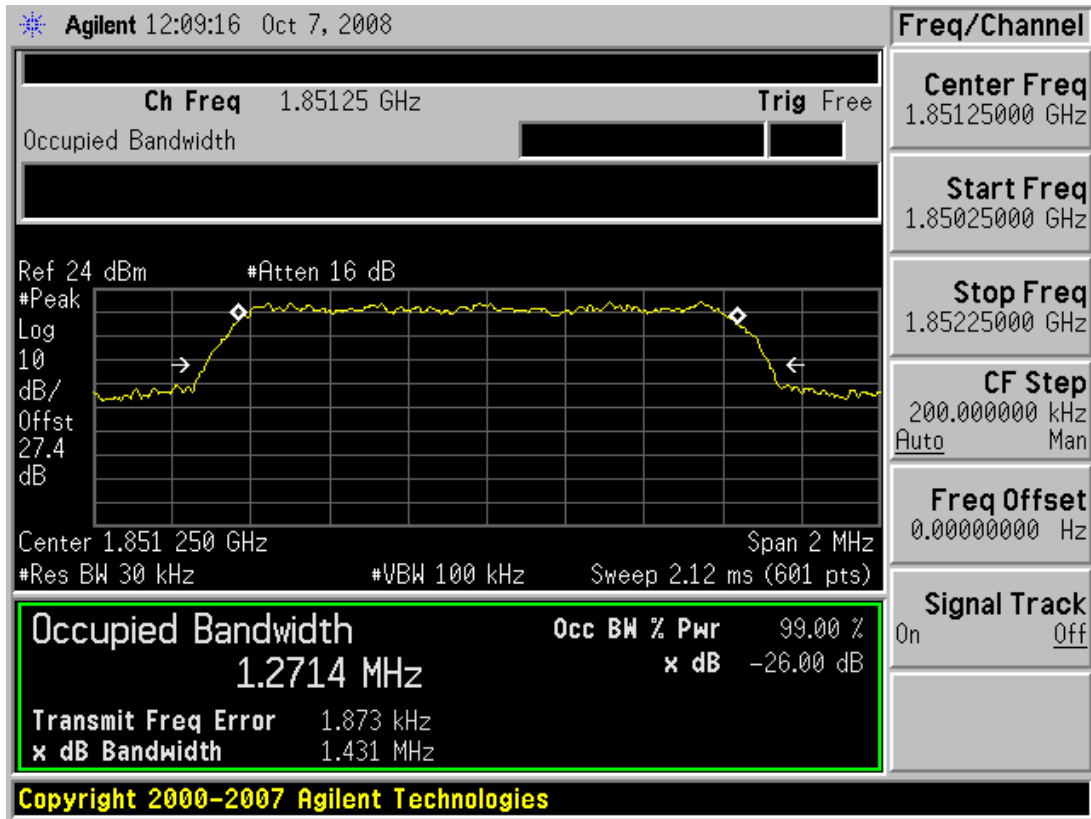

■ PCS CDMA MODE (600 CH.) Occupied Bandwidth

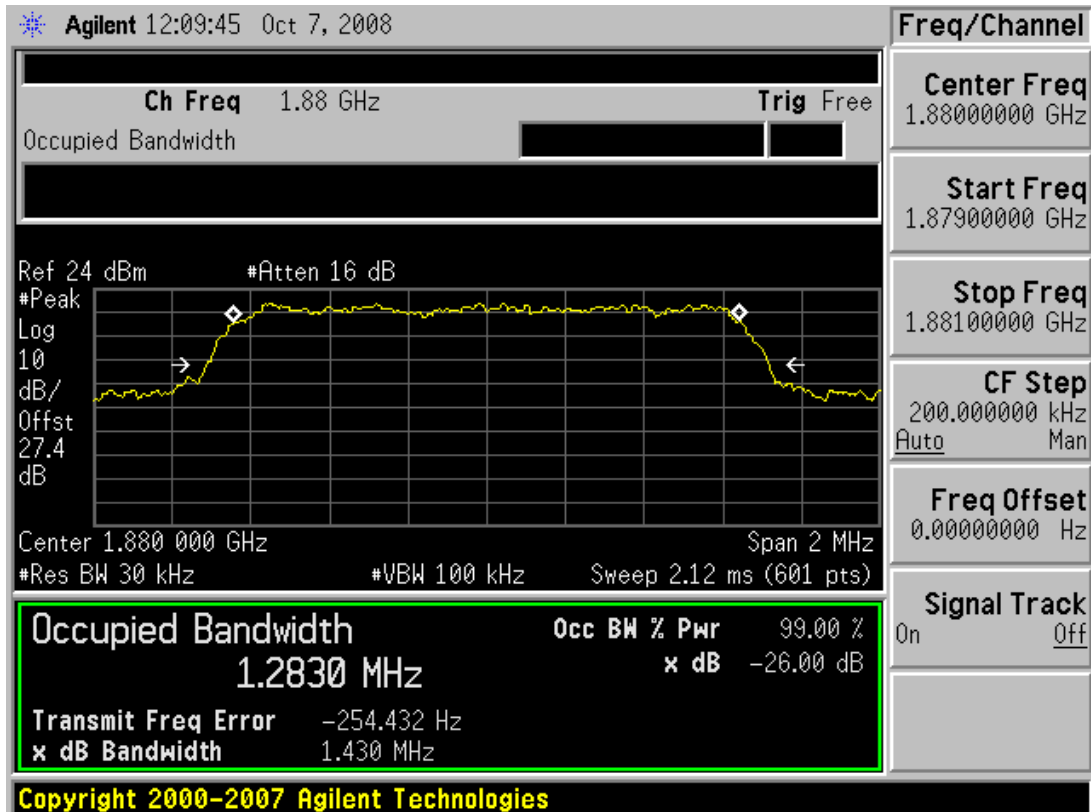

FCC CERTIFICATION REPORT			www.hct.co.kr
Test Report No. HCT-R08-200	Test Dates: October 28, 2008	EUT Type: Tri-Band CDMA/EVDO USB Modem(CDMA/ PCS CDMA/ AWS CDMA)	FCC ID: US7-A600 Page 25 of 39



■ PCS CDMA MODE (1175 CH.) Occupied Bandwidth

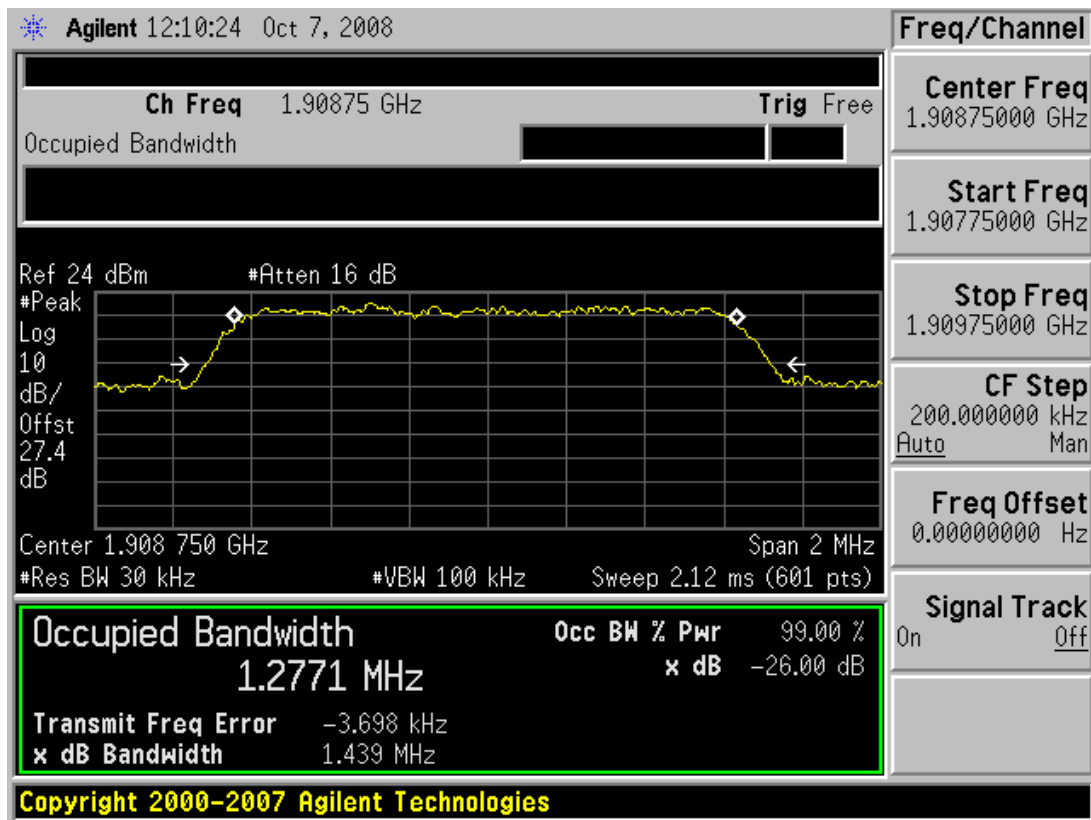

■ PCS EVDO MODE (600 CH.) Occupied Bandwidth

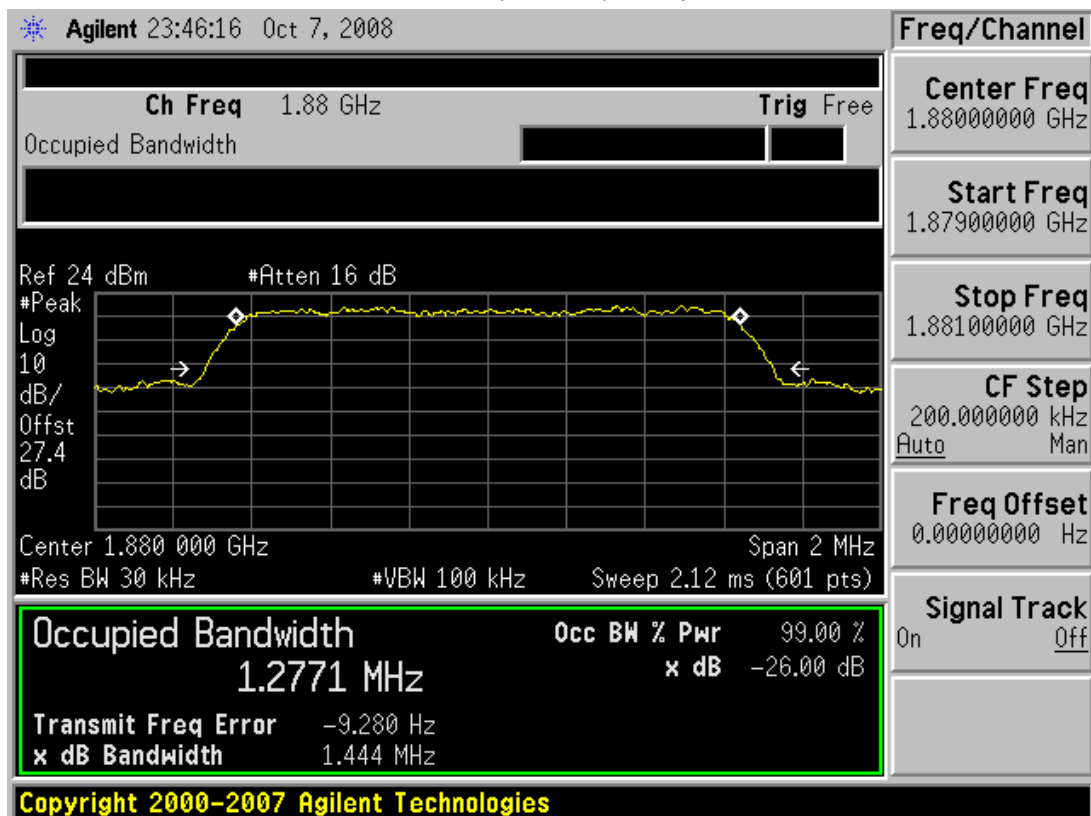

FCC CERTIFICATION REPORT

www.hct.co.kr

Test Report No. HCT-R08-200	Test Dates: October 28, 2008	EUT Type: Tri-Band CDMA/EVDO USB Modem(CDMA/ PCS CDMA/ AWS CDMA)	FCC ID: US7-A600	Page 26 of 39
--------------------------------	---------------------------------	---	---------------------	---------------



■ AWS CDMA MODE (25 CH.) Occupied Bandwidth

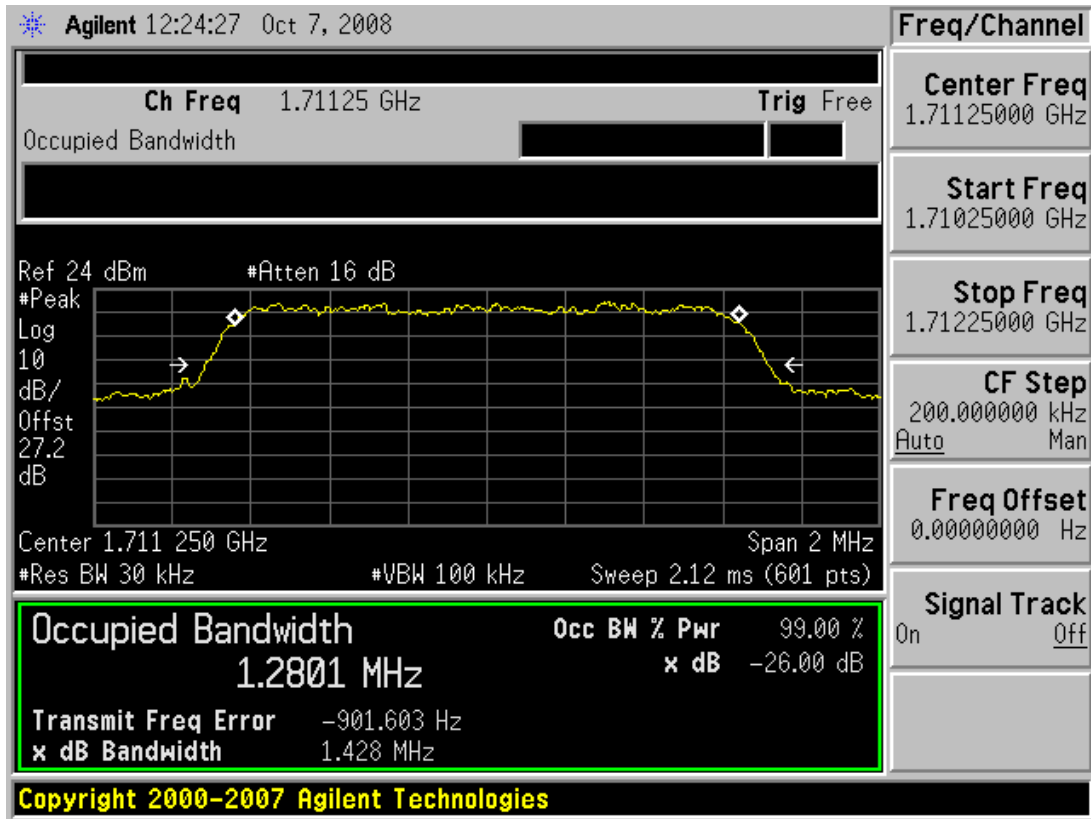

■ AWS CDMA MODE (450 CH.) Occupied Bandwidth

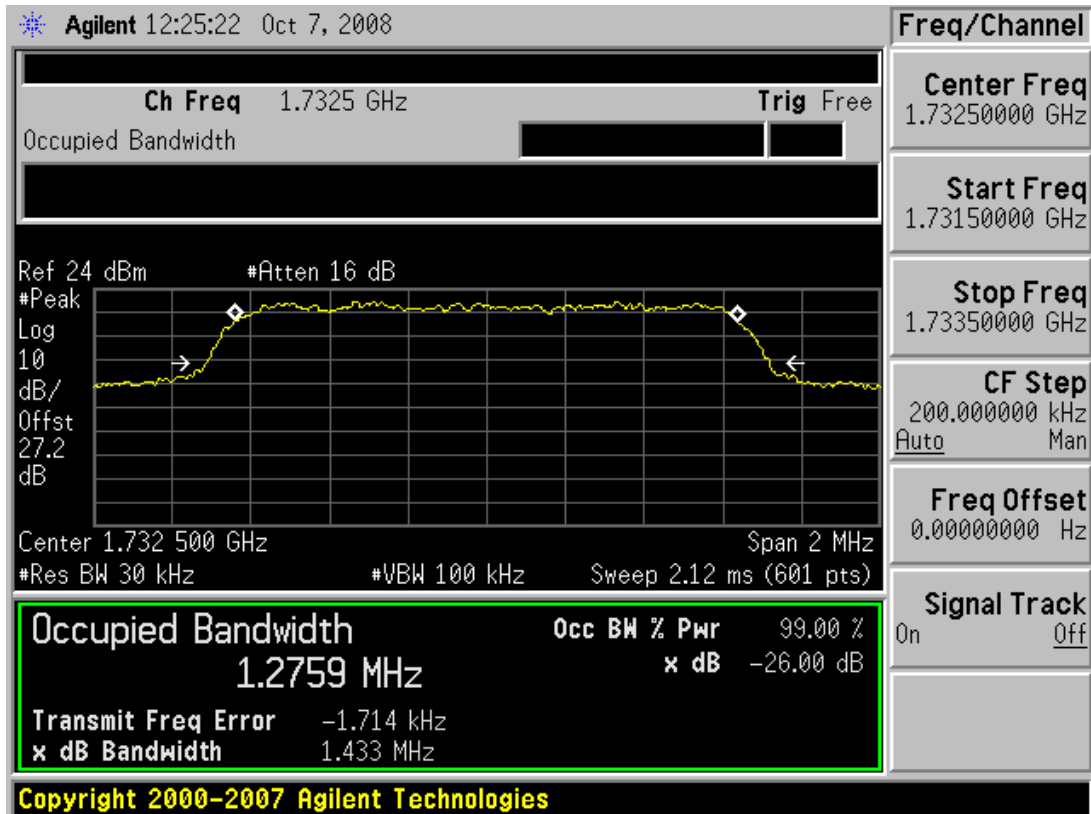

FCC CERTIFICATION REPORT			www.hct.co.kr
Test Report No. HCT-R08-200	Test Dates: October 28, 2008	EUT Type: Tri-Band CDMA/EVDO USB Modem(CDMA/ PCS CDMA/ AWS CDMA)	FCC ID: US7-A600 Page 27 of 39



■ AWS CDMA MODE (875 CH.) Occupied Bandwidth

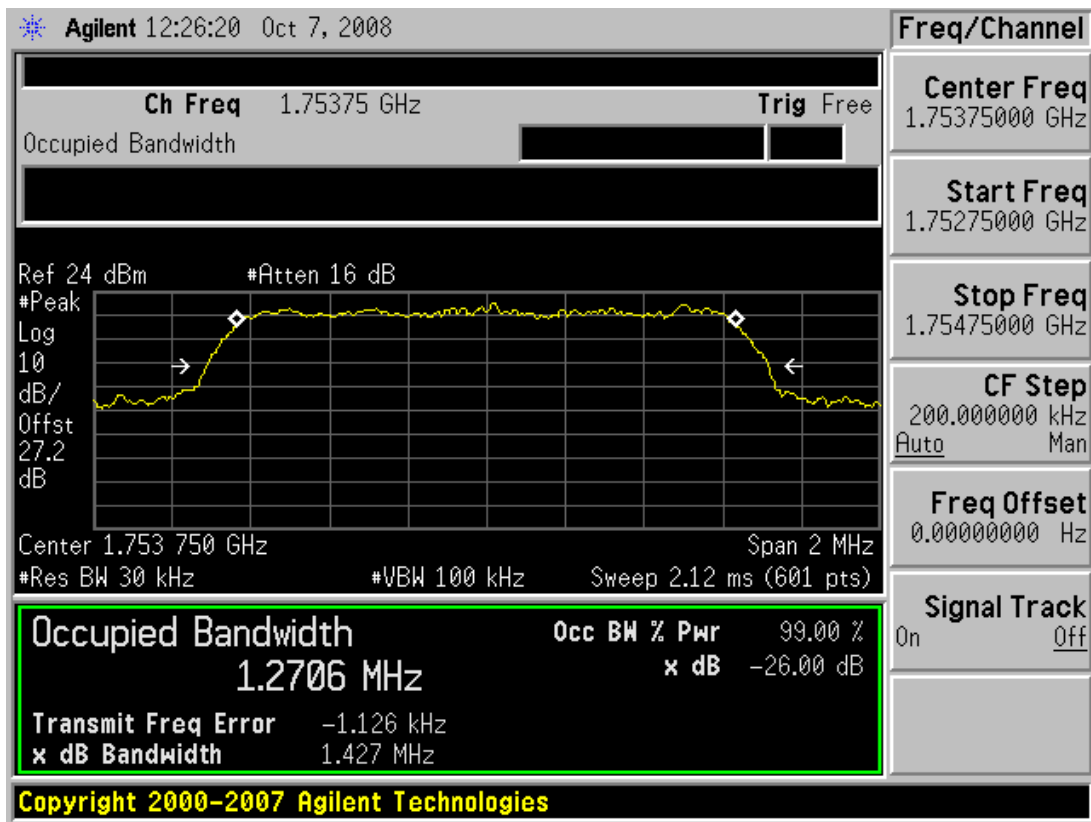

■ AWS EVDO MODE (25 CH.) Occupied Bandwidth

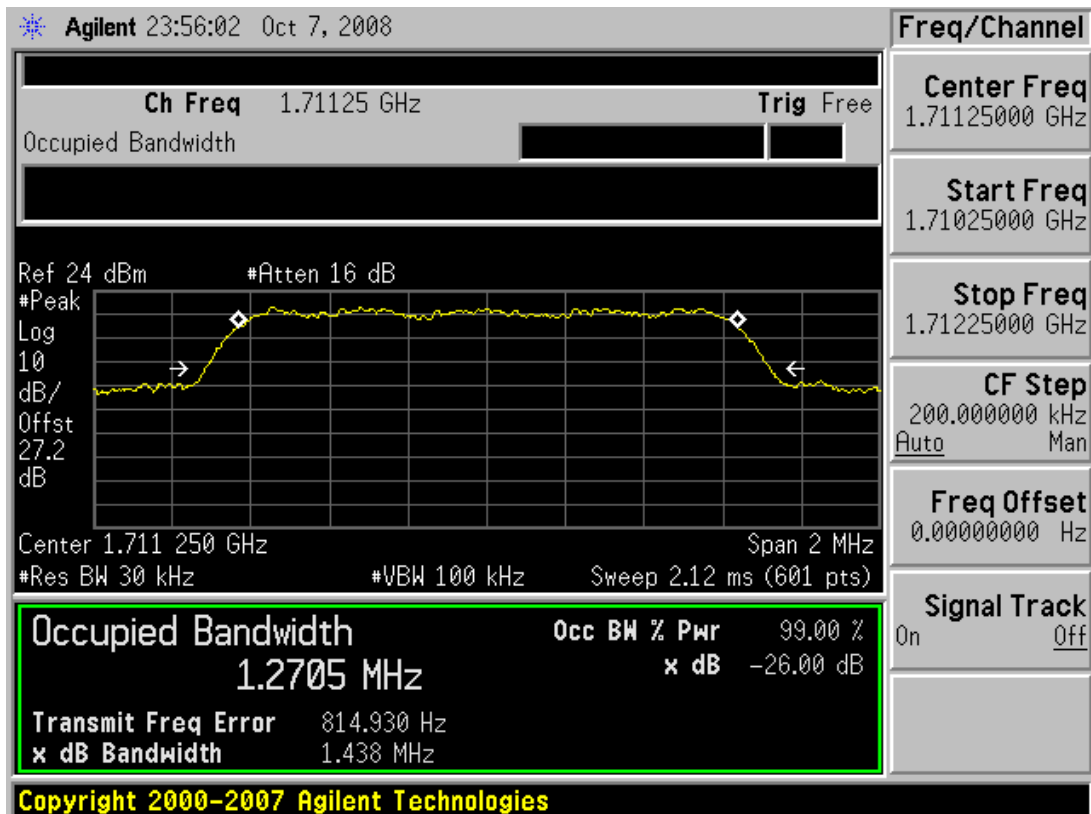

FCC CERTIFICATION REPORT			www.hct.co.kr
Test Report No. HCT-R08-200	Test Dates: October 28, 2008	EUT Type: Tri-Band CDMA/EVDO USB Modem(CDMA/ PCS CDMA/ AWS CDMA)	FCC ID: US7-A600 Page 28 of 39



■ CDMA MODE (1013 CH.) Block Edge

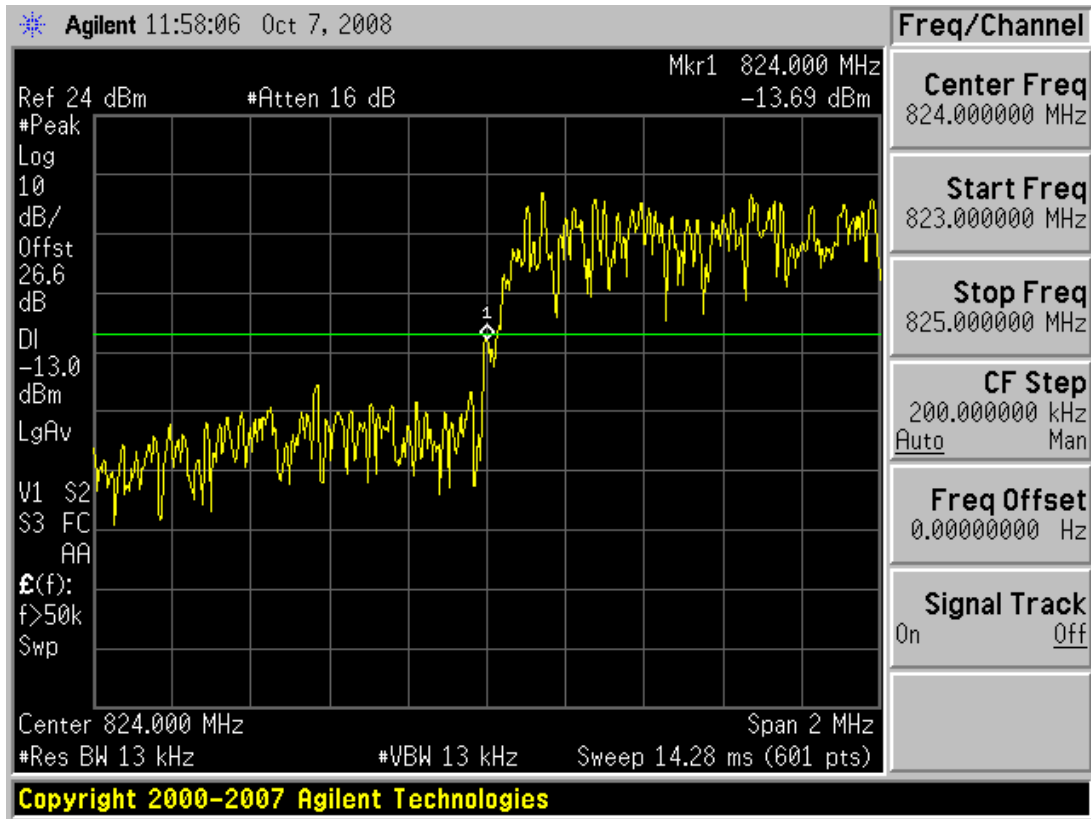

■ CDMA MODE (777 CH.) Block Edge

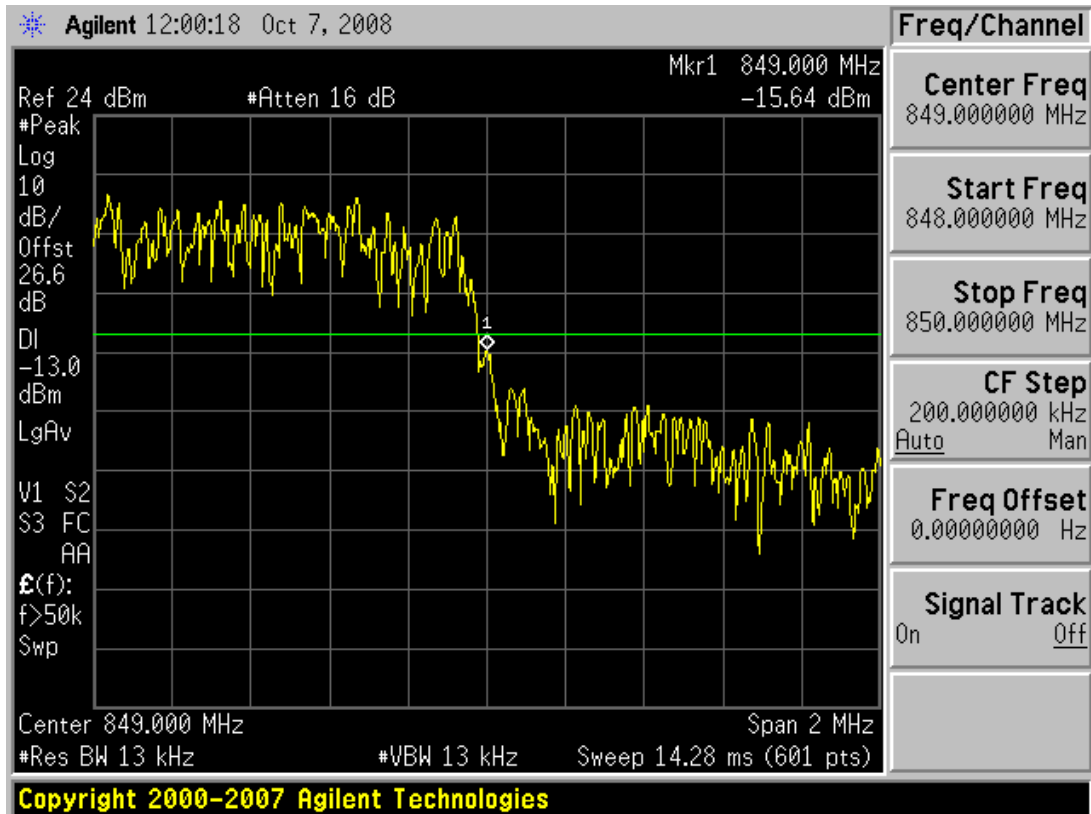

FCC CERTIFICATION REPORT			www.hct.co.kr
Test Report No. HCT-R08-200	Test Dates: October 28, 2008	EUT Type: Tri-Band CDMA/EVDO USB Modem(CDMA/ PCS CDMA/ AWS CDMA)	FCC ID: US7-A600 Page 29 of 39



■ CDMA EVDO MODE (1013 CH.) Block Edge

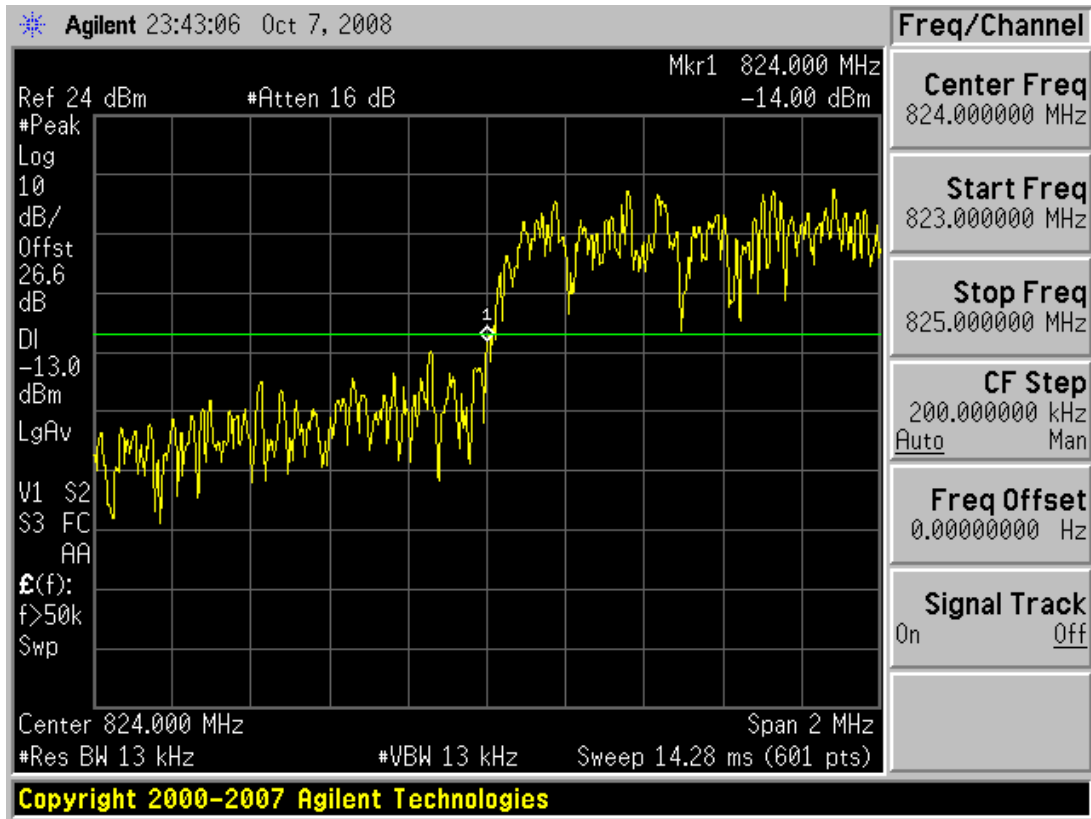

■ CDMA EVDO MODE (777 CH.) Block Edge

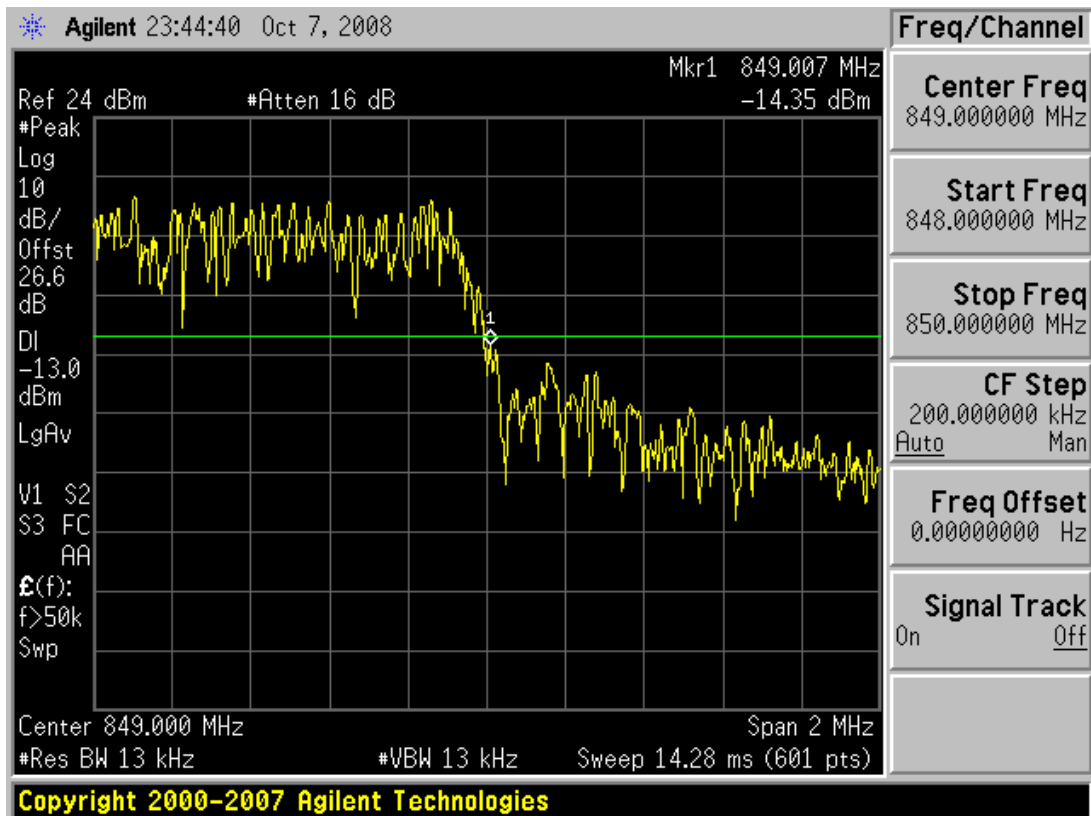

FCC CERTIFICATION REPORT			www.hct.co.kr	
Test Report No. HCT-R08-200	Test Dates: October 28, 2008	EUT Type: Tri-Band CDMA/EVDO USB Modem(CDMA/ PCS CDMA/ AWS CDMA)	FCC ID: US7-A600	Page 3 0 of 39



■ PCS CDMA MODE (25 CH.) Block Edge

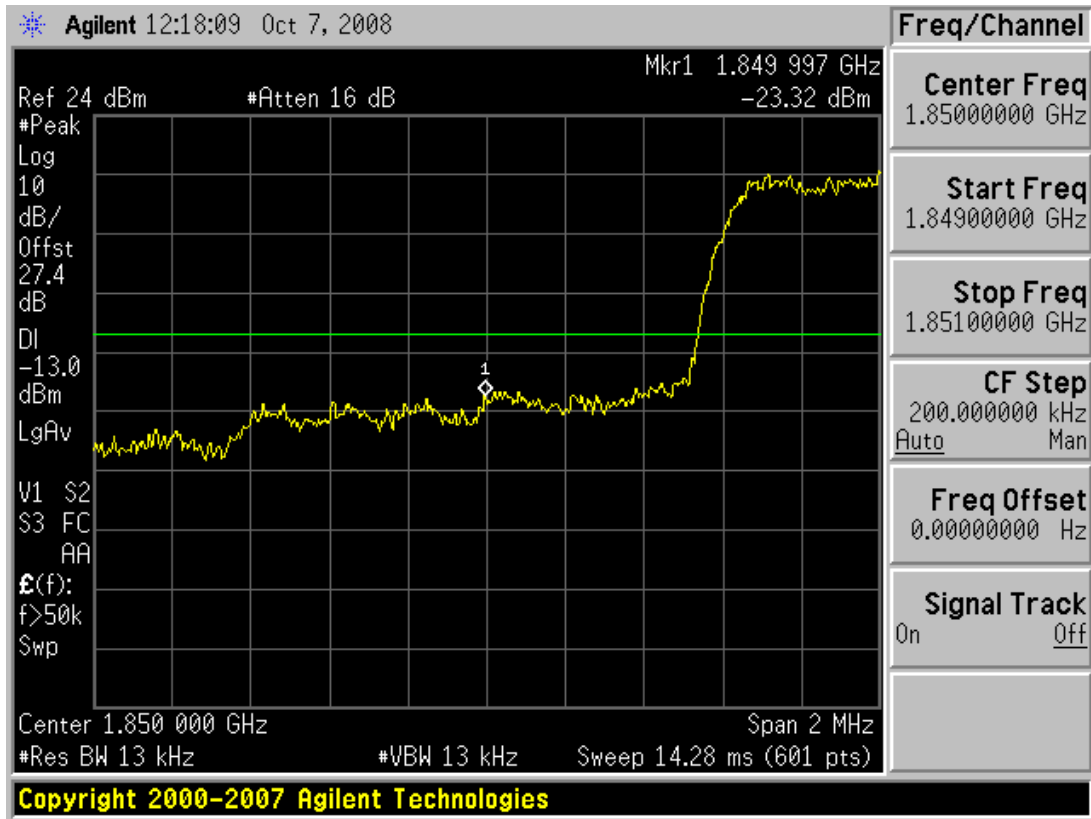

■ PCS CDMA MODE (1175 CH.) Block Edge

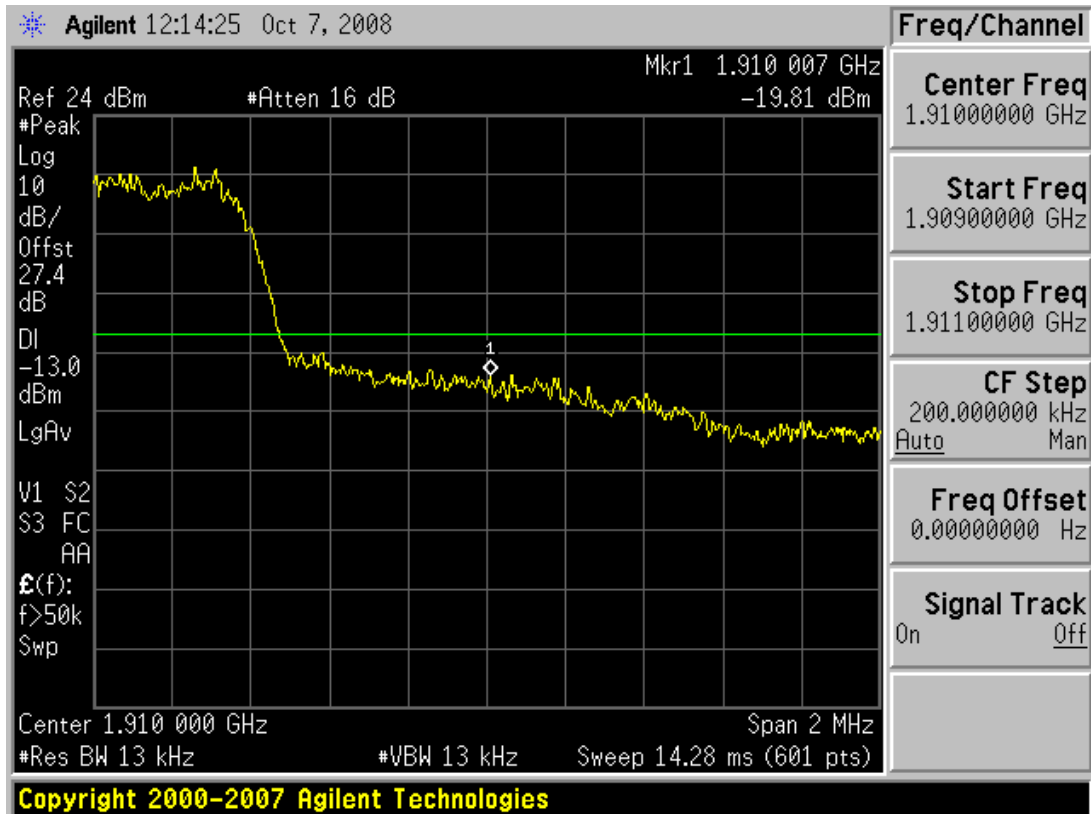

FCC CERTIFICATION REPORT				www.hct.co.kr
Test Report No. HCT-R08-200	Test Dates: October 28, 2008	EUT Type: Tri-Band CDMA/EVDO USB Modem(CDMA/ PCS CDMA/ AWS CDMA)	FCC ID: US7-A600	Page 3 1 of 39



■ PCS CDMA EVDO MODE (25 CH.) Block Edge

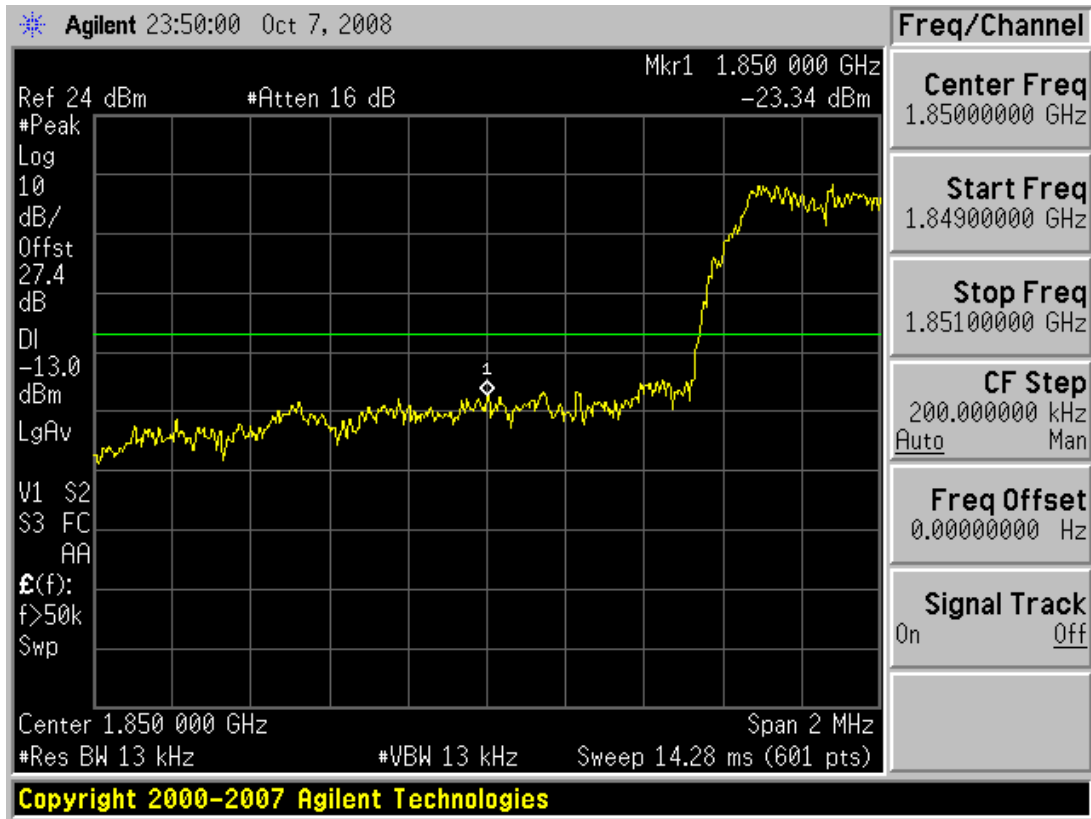

■ PCS CDMA EVDO MODE (1175 CH.) Block Edge

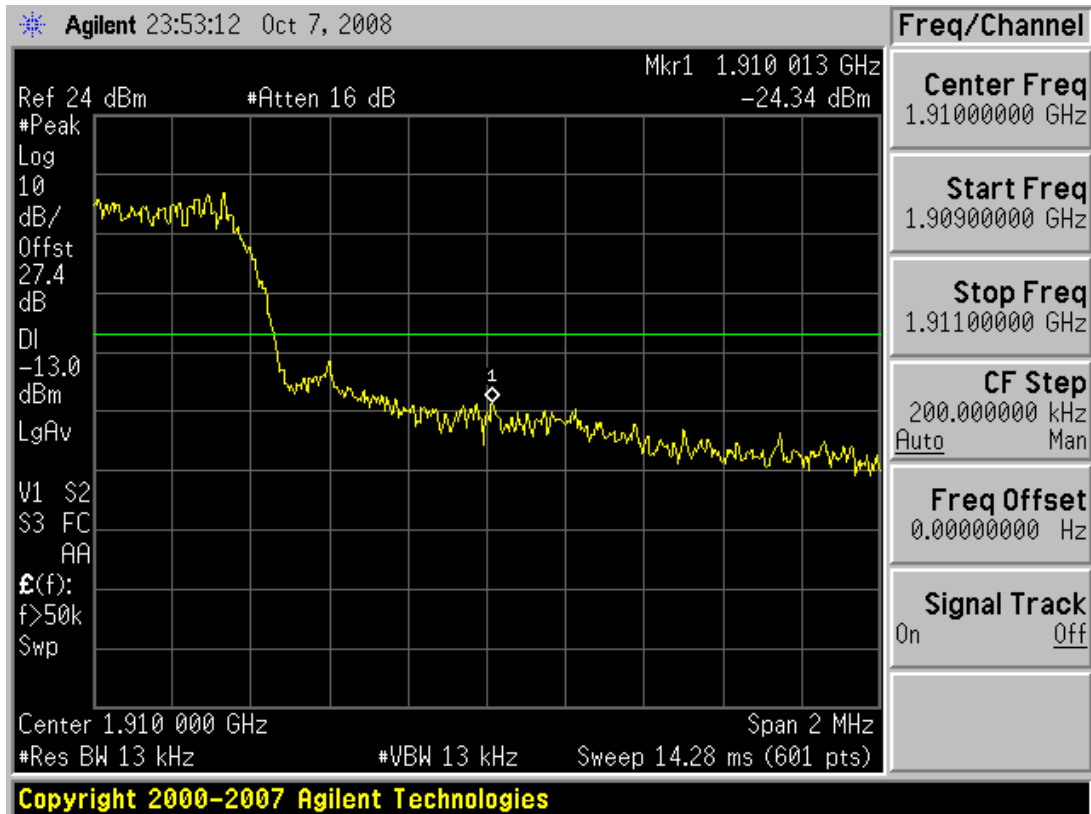

FCC CERTIFICATION REPORT				www.hct.co.kr
Test Report No. HCT-R08-200	Test Dates: October 28, 2008	EUT Type: Tri-Band CDMA/EVDO USB Modem(CDMA/ PCS CDMA/ AWS CDMA)	FCC ID: US7-A600	Page 3 2 of 39



■ AWS CDMA MODE (25 CH.) Block Edge

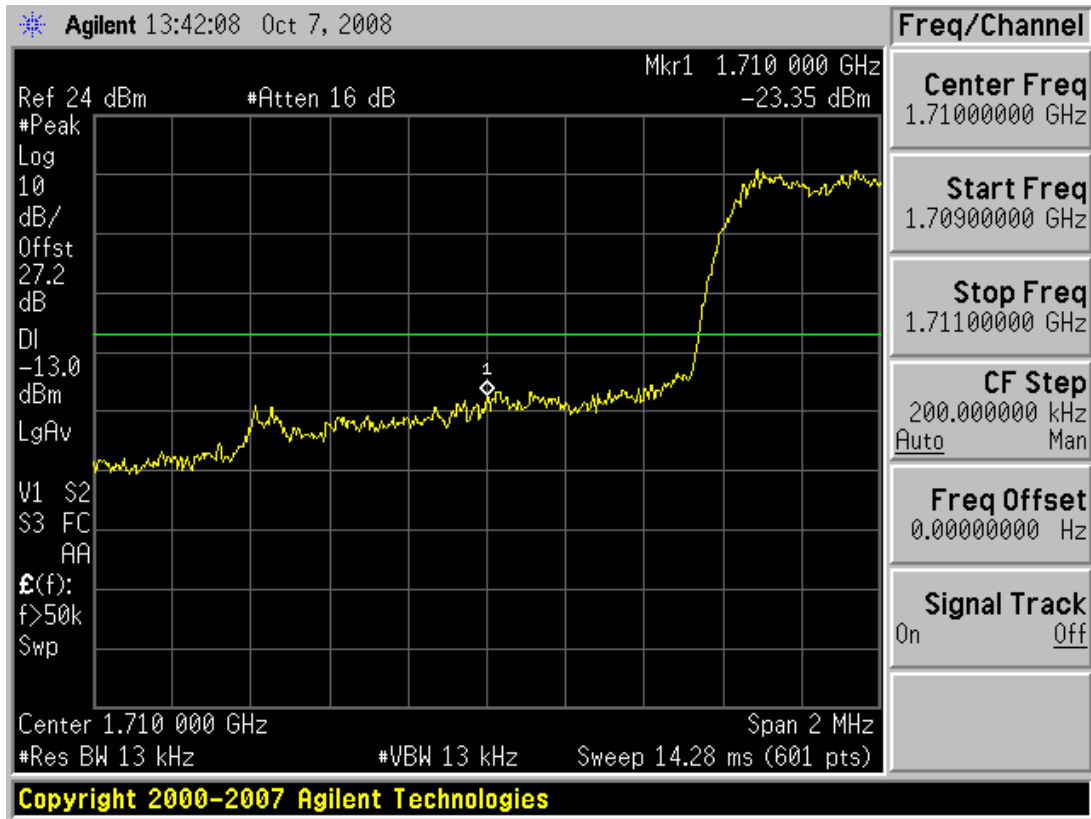

■ AWS CDMA MODE (875 CH.) Block Edge

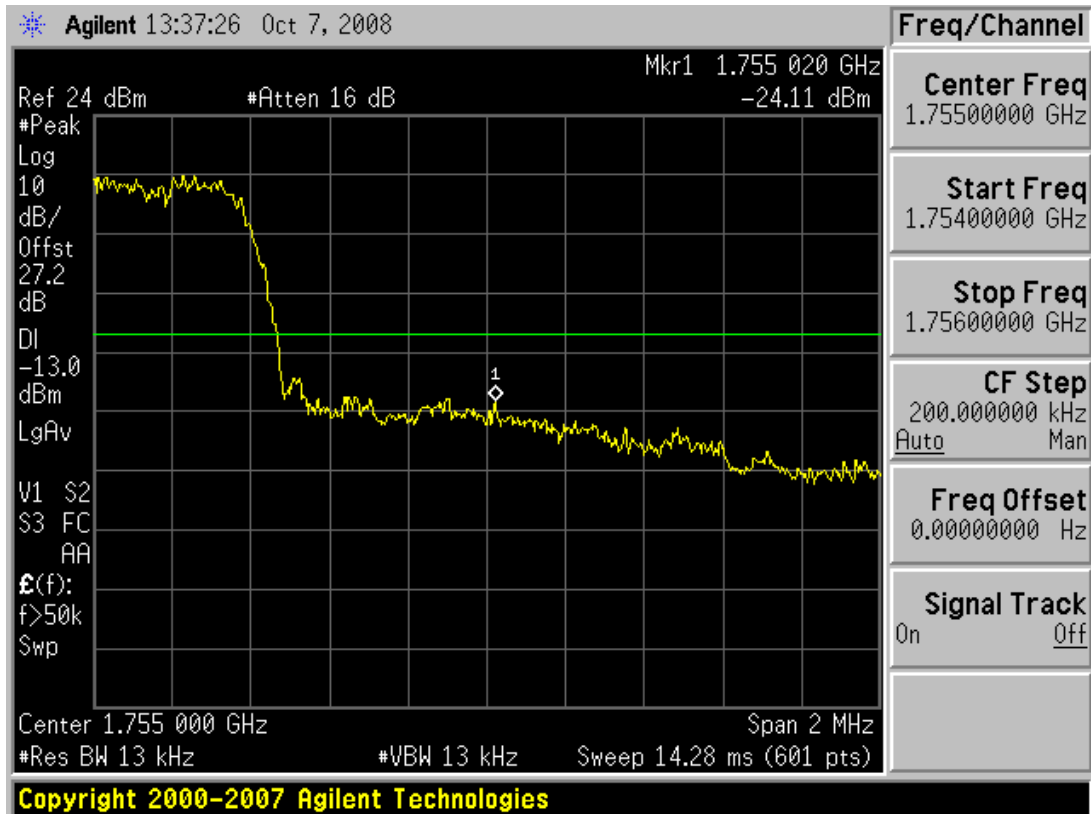

FCC CERTIFICATION REPORT				www.hct.co.kr
Test Report No. HCT-R08-200	Test Dates: October 28, 2008	EUT Type: Tri-Band CDMA/EVDO USB Modem(CDMA/ PCS CDMA/ AWS CDMA)	FCC ID: US7-A600	Page 3 3 of 39



■ AWS CDMA EVDO MODE (25 CH.) Block Edge

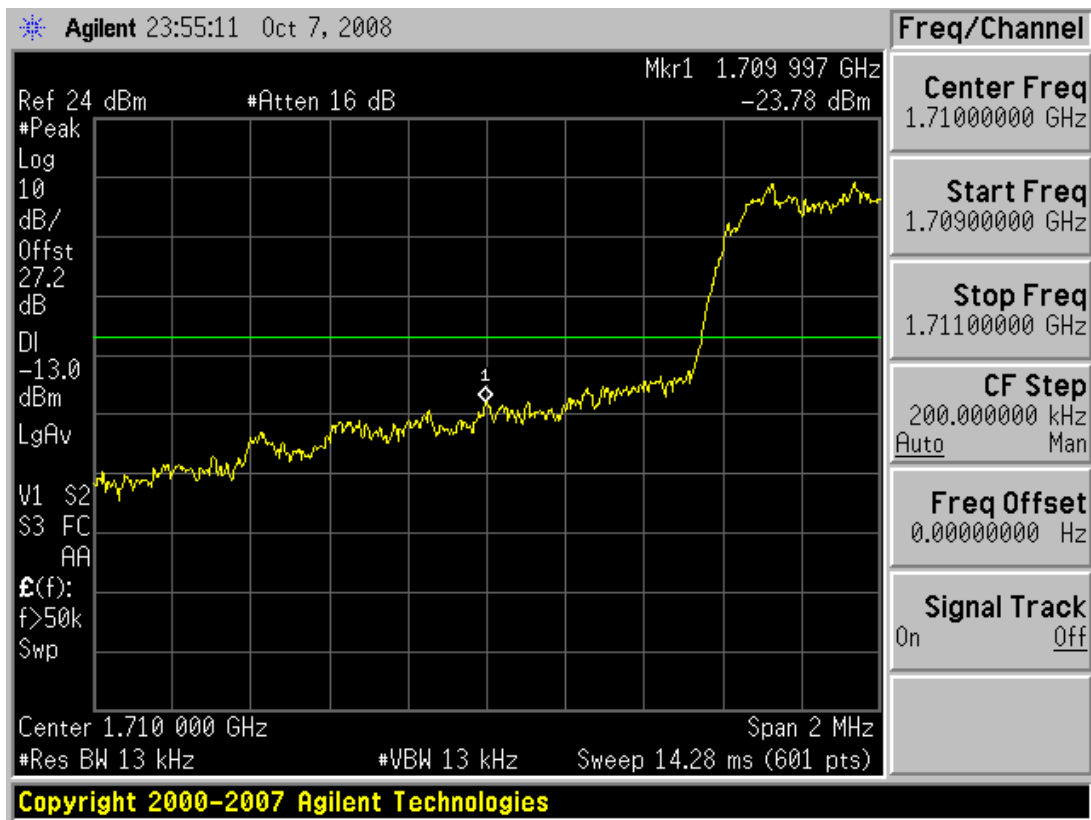

■ AWS CDMA EVDO MODE (875 CH.) Block Edge

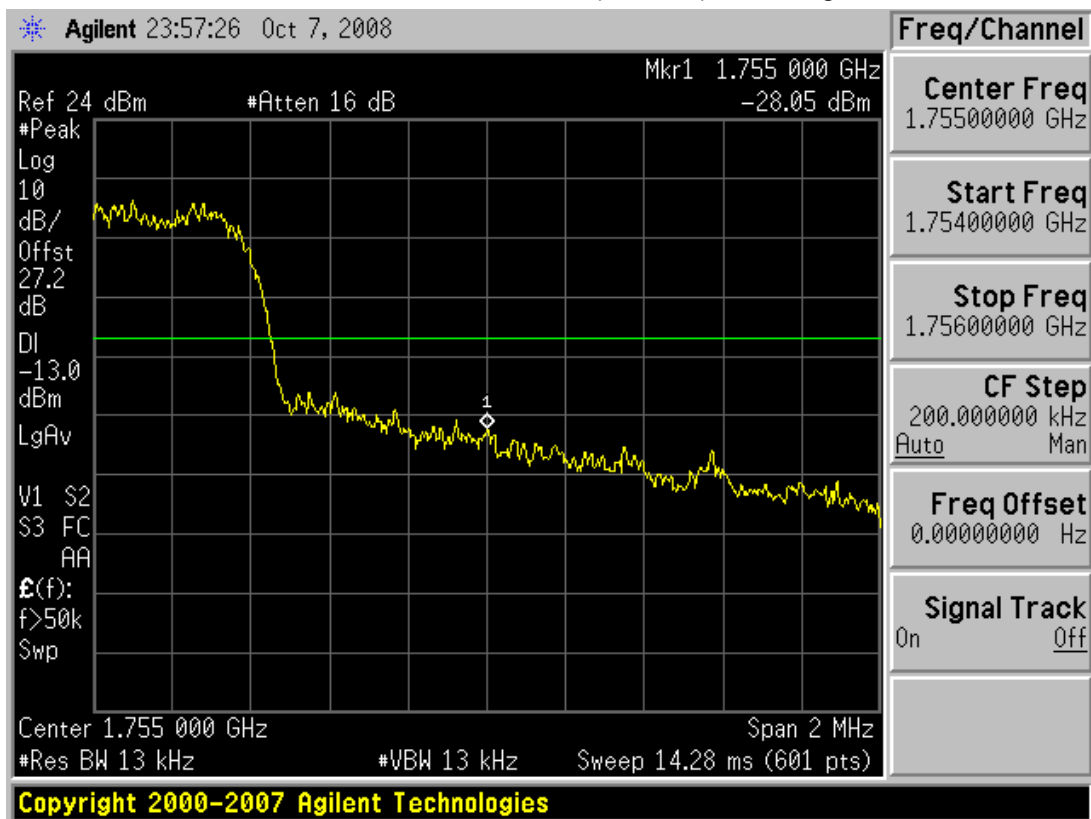

FCC CERTIFICATION REPORT				www.hct.co.kr
Test Report No. HCT-R08-200	Test Dates: October 28, 2008	EUT Type: Tri-Band CDMA/EVDO USB Modem(CDMA/ PCS CDMA/ AWS CDMA)	FCC ID: US7-A600	Page 3 4 of 39



■ CDMA MODE (1013 CH.) Conducted Spurious Emissions

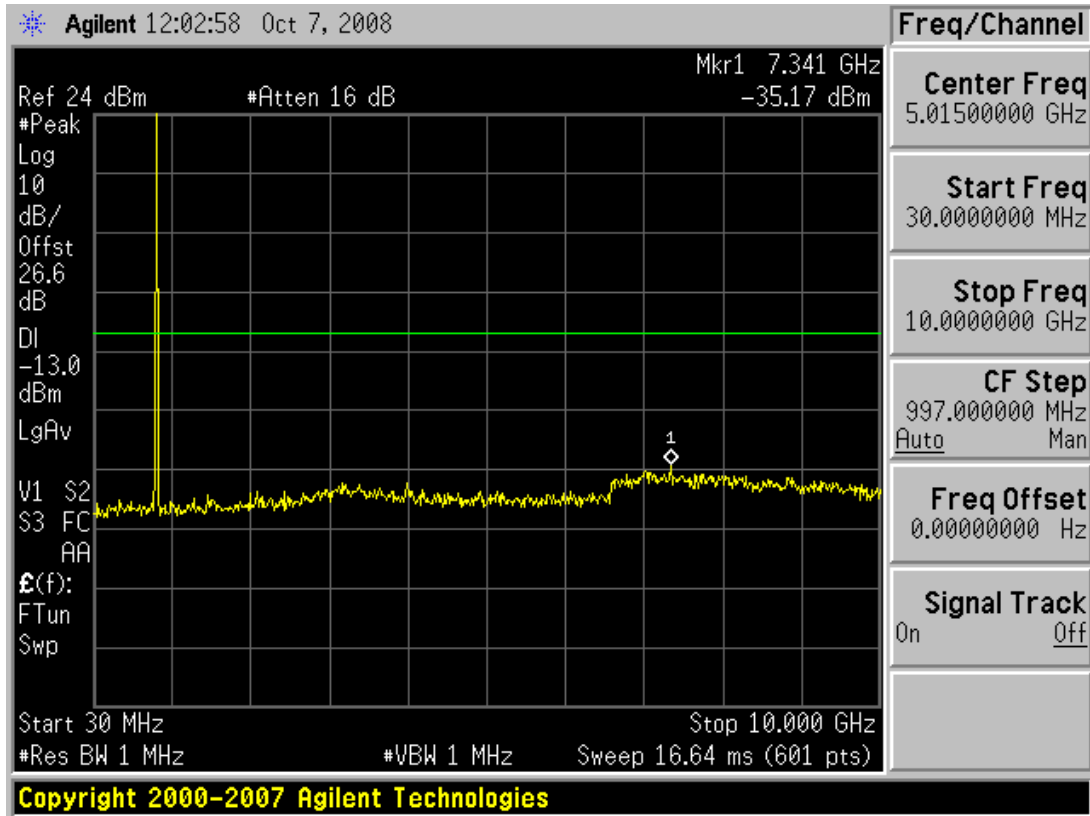

■ CDMA MODE (384 CH.) Conducted Spurious Emissions

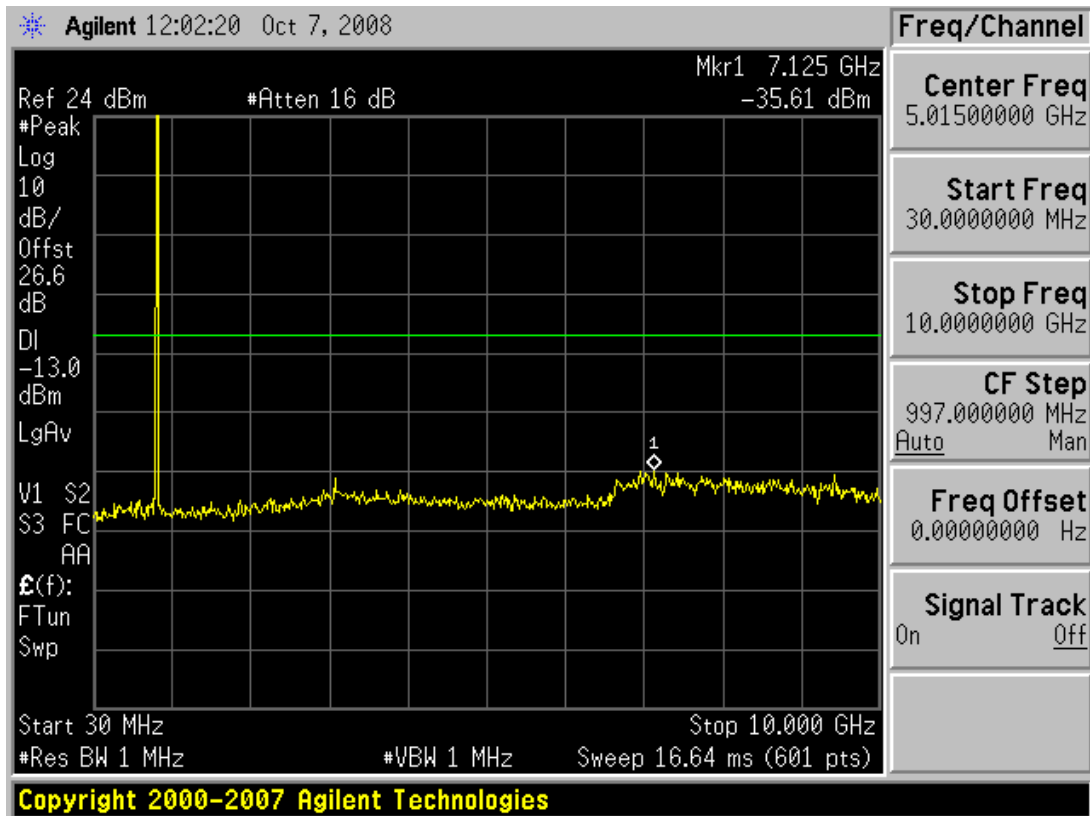

FCC CERTIFICATION REPORT				www.hct.co.kr
Test Report No. HCT-R08-200	Test Dates: October 28, 2008	EUT Type: Tri-Band CDMA/EVDO USB Modem(CDMA/ PCS CDMA/ AWS CDMA)	FCC ID: US7-A600	Page 3 5 of 39



■ CDMA MODE (777 CH.) Conducted Spurious Emissions

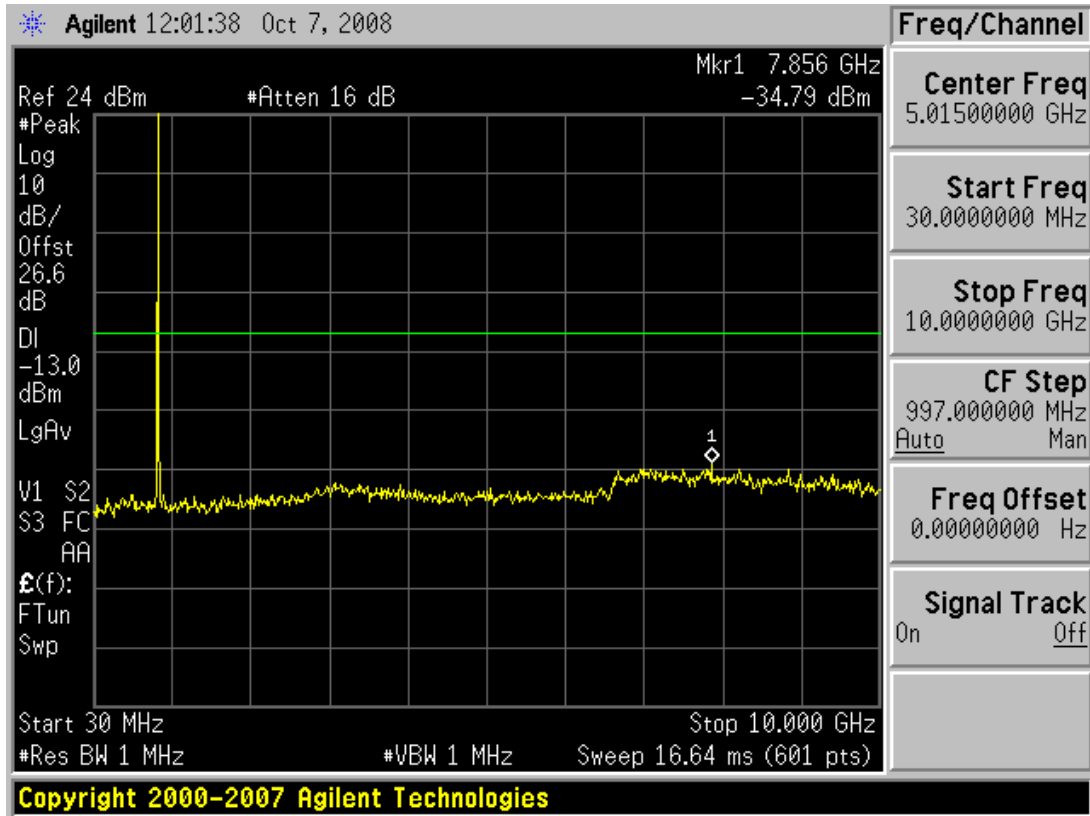

■ PCS CDMA MODE (25 CH.) Conducted Spurious Emissions

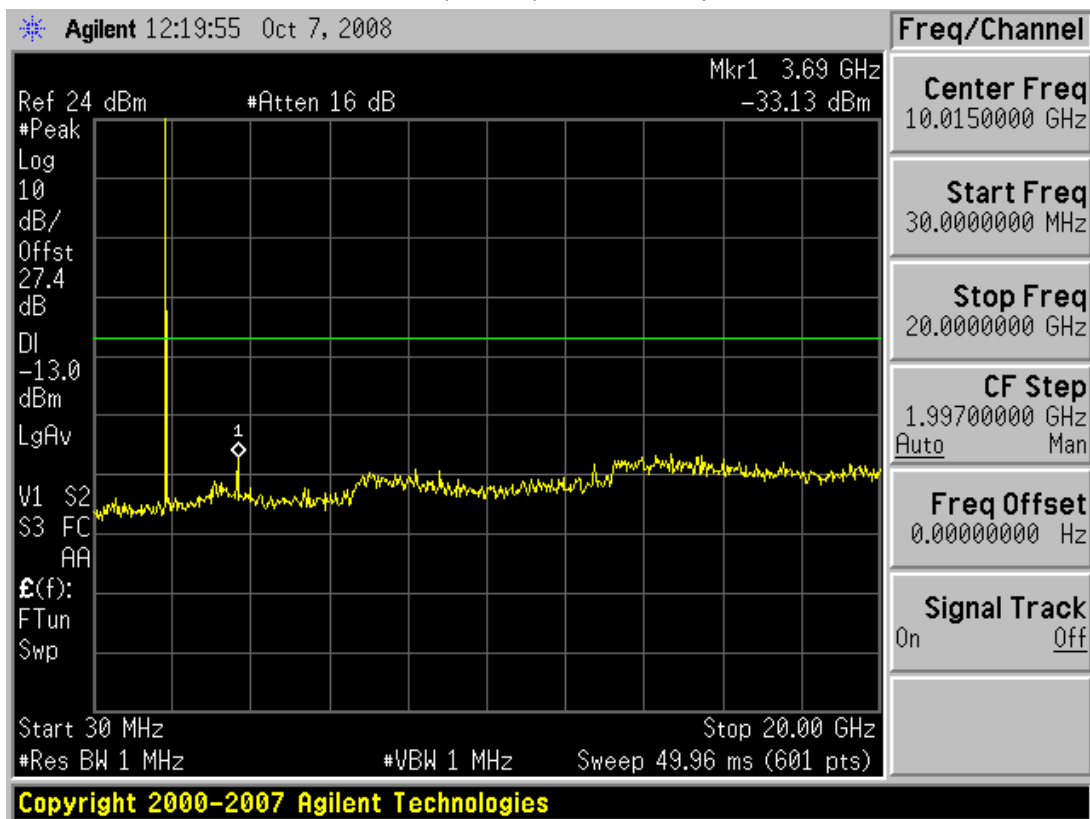

FCC CERTIFICATION REPORT			www.hct.co.kr	
Test Report No. HCT-R08-200	Test Dates: October 28, 2008	EUT Type: Tri-Band CDMA/EVDO USB Modem(CDMA/ PCS CDMA/ AWS CDMA)	FCC ID: US7-A600	Page 3 6 of 39



■ PCS CDMA MODE (600 CH.) Conducted Spurious Emissions

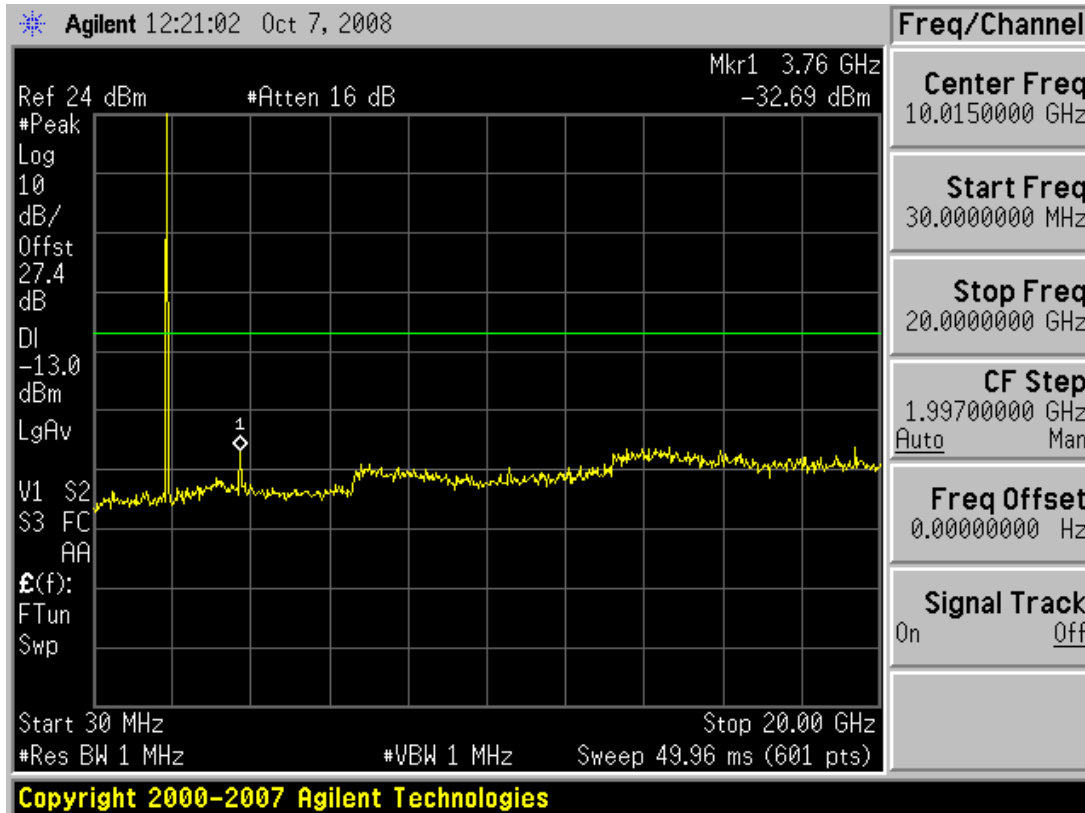

■ PCS CDMA MODE (1175 CH.) Conducted Spurious Emissions

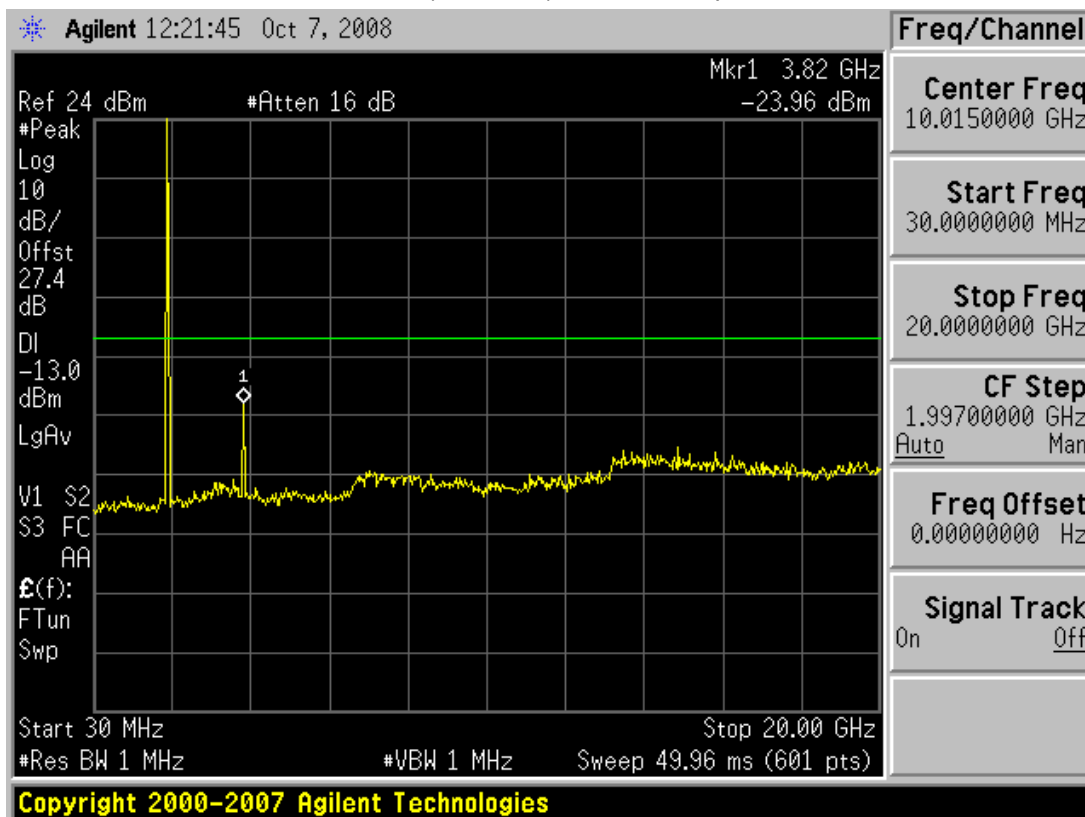

FCC CERTIFICATION REPORT			www.hct.co.kr	
Test Report No. HCT-R08-200	Test Dates: October 28, 2008	EUT Type: Tri-Band CDMA/EVDO USB Modem(CDMA/ PCS CDMA/ AWS CDMA)	FCC ID: US7-A600	Page 37 of 39



■ AWS CDMA MODE (25 CH.) Conducted Spurious Emissions

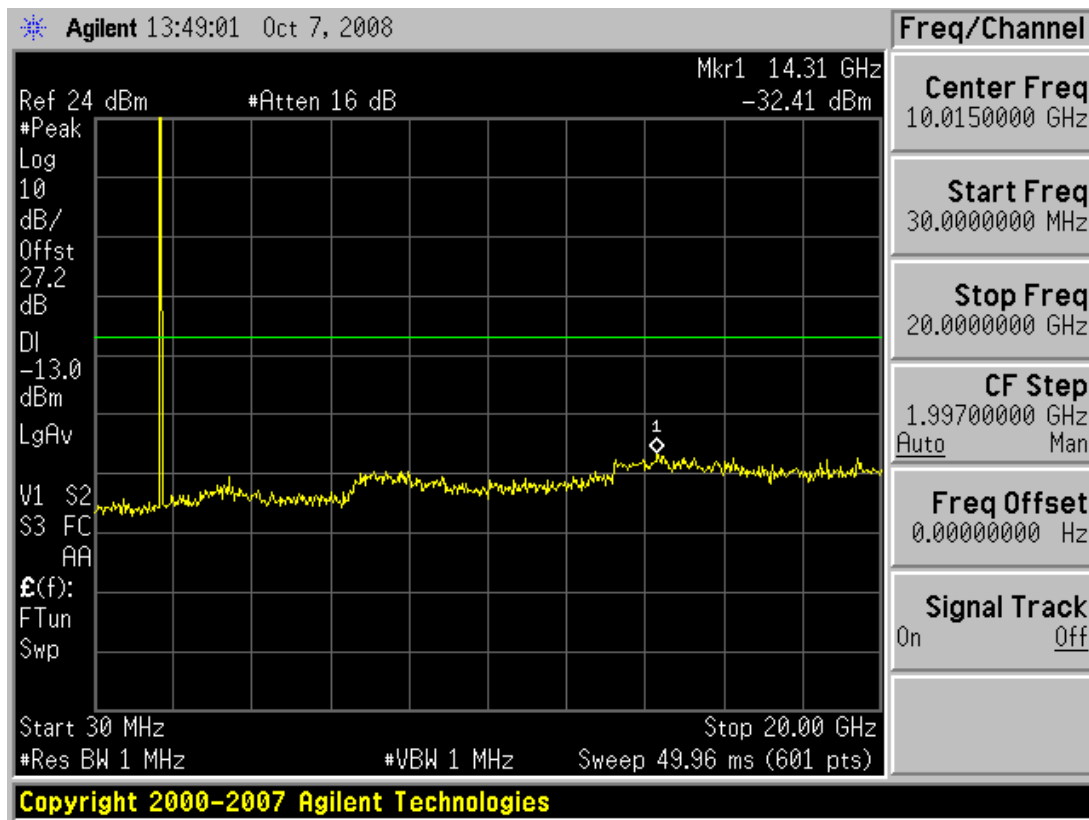

■ AWS CDMA MODE (450 CH.) Conducted Spurious Emissions

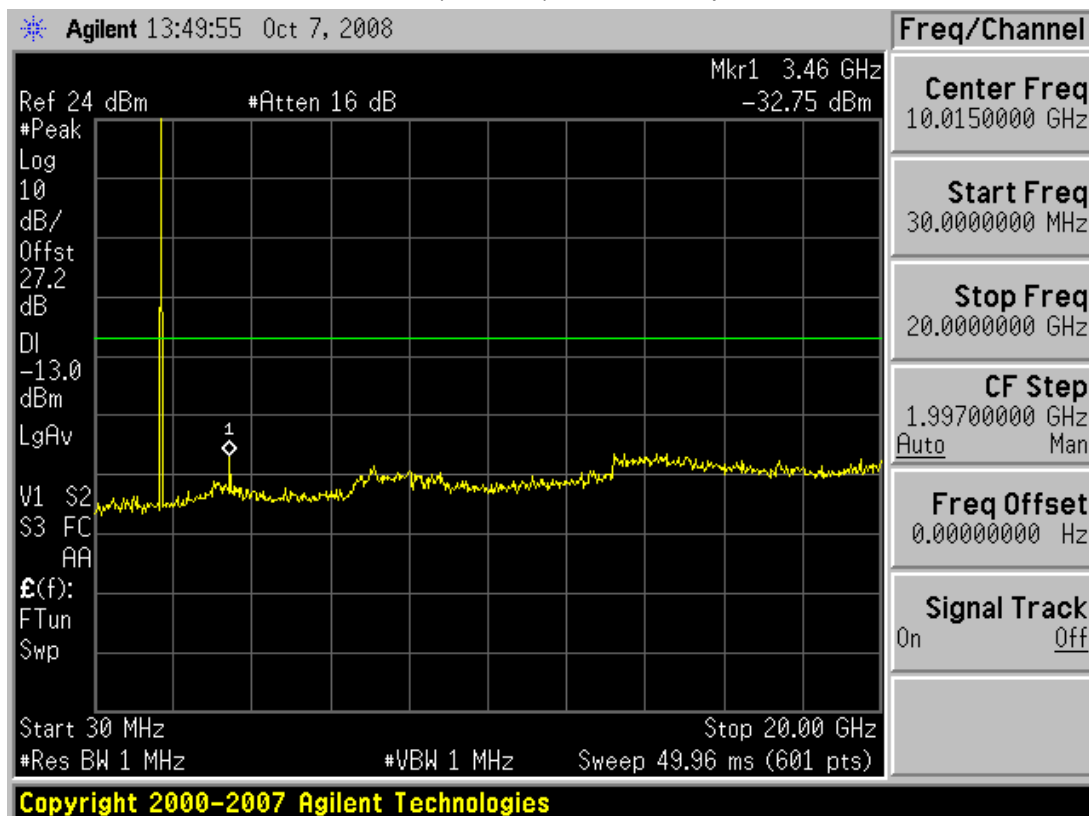

FCC CERTIFICATION REPORT				www.hct.co.kr
Test Report No. HCT-R08-200	Test Dates: October 28, 2008	EUT Type: Tri-Band CDMA/EVDO USB Modem(CDMA/ PCS CDMA/ AWS CDMA)	FCC ID: US7-A600	Page 3 8 of 39



■ AWS CDMA MODE (875 CH.) Conducted Spurious Emissions

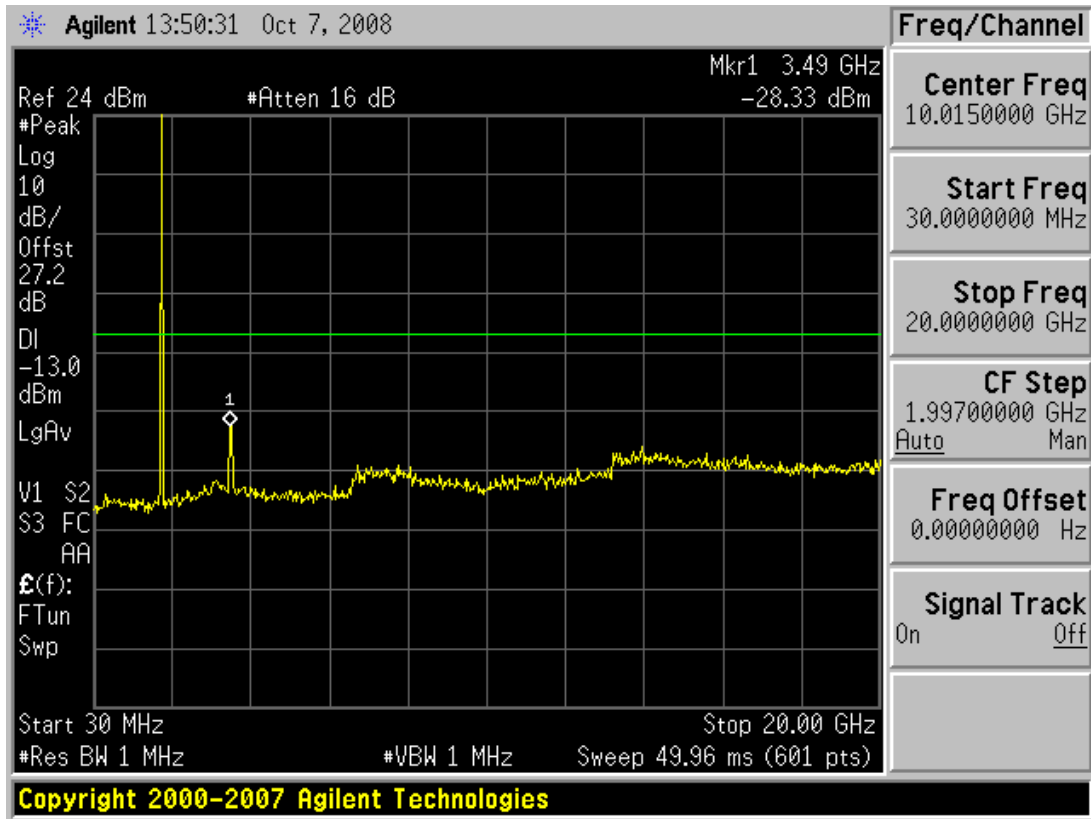

FCC CERTIFICATION REPORT				www.hct.co.kr
Test Report No. HCT-R08-200	Test Dates: October 28, 2008	EUT Type: Tri-Band CDMA/EVDO USB Modem(CDMA/ PCS CDMA/ AWS CDMA)	FCC ID: US7-A600	Page 39 of 39