



HCT CO., LTD.

Product Compliance Division

TEL : +82 31 639 8518 FAX : +82 31 639 8535

CERTIFICATE OF COMPLIANCE

FCC Certification

Applicant Name:
Cal-Comp Electronics & Communications Company Limited

Address:
3F., No.99, NAN-KING E.RD.,SEC.5, Taipei 105, Taiwan

Date of Issue:

May 29, 2009

Location:

HCT CO., LTD., San 136-1 Ami-ri, Bubal-eup, Icheon-si,
Kyungki-do, Korea

Test Report No.: HCT-RF09-0527

HCT FRN: 0005866421

IC Recognition No.: IC 5944A-1

FCC ID: US7-A200

APPLICANT: Cal-Comp Electronics & Communications Company Limited

Model(s): A200

EUT Type: Tri-Band CDMA Phone (CDMA/PCS CDMA/AWS CDMA) with Bluetooth

Tx Frequency:
824.70 — 848.31 MHz (CDMA)
1 851.25 — 1 908.75 MHz (PCS CDMA)
1 711.25 — 1 753.75 MHz (AWS CDMA)

Rx Frequency:
869.70 — 893.31 MHz (CDMA)
1 931.25 — 1 988.75 MHz (PCS CDMA)
2 111.25 — 2 153.75 MHz (AWS CDMA)

Max. RF Output Power: 0.364 W ERP CDMA (25.61 dBm) / 0.619 W EIRP PCS CDMA (27.92 dBm) /
0.554 W EIRP AWS CDMA (27.44 dBm)

Emission Designator(s): 1M28F9W (CDMA) / 1M28F9W (PCS CDMA) / 1M28F9W(AWS CDMA)

FCC Classification: Licensed Portable Transmitter Held to Ear (PCE)

FCC Rule Part(s): §22, §24, §27, §2

The measurements shown in this report were made in accordance with the procedures specified in §2.947. I assume full responsibility for the accuracy and completeness of these measurements, and for the qualifications of all persons taking them.

HCT CO., LTD. Certifies that no party to this application has been denied FCC benefits pursuant to section 5301 of the Anti-Drug Abuse Act of 1998, 21 U.S. C.853(a)

Report prepared by

: Jong Seok Lee

Test engineer of RF Team

Approved by

: Sang Jun Lee

Manager of RF Team

This report only responds to the tested sample and may not be reproduced, except in full, without written approval of the HCT Co., Ltd.

FCC CERTIFICATION REPORT				www.hct.co.kr
Test Report No. HCT-RF09-0527	Date of Issue: May 29, 2009	EUT Type: Tri-Band CDMA Phone (CDMA/PCS CDMA/AWS CDMA) with Bluetooth	FCC ID: US7-A200	Page 1 of 45



Table of Contents

1. GENERAL INFORMATION	3
2. INTRODUCTION.....	4
2.1. EUT DESCRIPTION.....	4
2.2. MEASURING INSTRUMENT CALIBRATION	4
2.3. TEST FACILITY	4
3. DESCRIPTION OF TESTS.....	5
3.1 Effective Radiated Power/Equivalent Isotropic Radiated Power.....	5
3.2 Peak- to- Average Ratio	6
3.3 Occupied bandwidth.....	7
3.4 Spurious and Harmonic Emissions at Antenna Terminal.....	8
3.5 Radiated Spurious and Harmonic Emissions	9
3.6 Frequency stability / variation of ambient temperature.....	10
4. LIST OF TEST EQUIPMENT	11
5. SUMMARY OF TEST RESULTS	12
6. SAMPLE CALCULATION.....	13
7. TEST DATA	14
7.1 Conducted Output Power.....	14
7.2 Peak-to-Average Ratio	14
7.3 Occupied Bandwidth.....	15
7.4 Conducted Spurious Emissions.....	15
7.4.1 Band Edge	15
7.5 Effective Radiated Power Output(CDMA)	16
7.6 Equivalent Isotropic Radiated Power (E.I.R.P.) (PCS CDMA).....	17
7.7 Radiated Spurious Emissions	18
7.7.1 Radiated Spurious Emissions(CDMA Mode).....	18
7.7.2 Radiated Spurious Emissions(PCS CDMA Mode).....	19
7.7.3 Radiated Spurious Emissions(AWS CDMA Mode)	20
7.8 Frequency stability / variation of ambient temperature.....	21
7.8.1 FREQUENCY STABILITY (CDMA).....	21
7.8.2 FREQUENCY STABILITY (PCS CDMA).....	22
7.8.3 FREQUENCY STABILITY (AWS CDMA).....	23
8. TEST PLOTS.....	24



MEASUREMENT REPORT

1. GENERAL INFORMATION

Applicant Name: Cal-Comp Electronics & Communications Company Limited

Address: 3F., No.99, NAN-KING E.RD.,SEC.5, Taipei 105, Taiwan

Contact Person: Name: Jong Ho, Kim
Phone #: +82 2 2662 2660 #7532/ Fax #: +82 2 8913 2001 #7573

FCC ID: US7-A200

Application Type: Certification

FCC Classification: Licensed Portable Transmitter Held to Ear (PCE)

FCC Rule Part(s): §22, §24, §27, §2

EUT Type: Tri-Band CDMA Phone (CDMA/PCS CDMA/AWS CDMA) with Bluetooth

Model(s): A200

Model Name: BT950009200

Battery Power Rating: 3.7 Vdc, 900 mAh/3.4 Wh

Type: Lithium-Ion Battery

Tx Frequency: 824.70 — 848.31 MHz (CDMA)
1 851.25 — 1 908.75 MHz (PCS CDMA)
1 711.25 — 1 753.75 MHz (AWS CDMA)

Rx Frequency: 869.70 — 893.31 MHz (CDMA)
1 931.25 — 1 988.75 MHz (PCS CDMA)
2 111.25 — 2 153.75 MHz (AWS CDMA)

Max. RF Output Power: 0.364 W ERP CDMA (25.61 dBm) / 0.619 W EIRP PCS CDMA (27.92 dBm) /
0.554 W EIRP AWS CDMA (27.44 dBm)

Emission Designator(s): 1M28F9W (CDMA) / 1M28F9W (PCS CDMA) / 1M28F9W(AWS CDMA)

Antenna Specification Manufacturer: SB TELECOM CO., LTD.
Antenna type: Internal Antenna
Peak Gain: 0.66 dBi

Date(s) of Tests: May 21, 2009 ~ May 27, 2009

FCC CERTIFICATION REPORT				www.hct.co.kr
Test Report No. HCT-RF09-0527	Test Dates: May 29, 2009	EUT Type: Tri-Band CDMA Phone (CDMA/PCS CDMA/AWS CDMA) with Bluetooth	FCC ID: US7-A200	Page 3 of 45



2. INTRODUCTION

2.1. EUT DESCRIPTION

The A200 Tri-Band CDMA Phone consists of Cellular CDMA, PCS CDMA and AWS CDMA.

2.2. MEASURING INSTRUMENT CALIBRATION

The measuring equipment, which was utilized in performing the tests documented herein, has been calibrated in accordance with the manufacturer's recommendations for utilizing calibration equipment, which is traceable to recognized national standards.

2.3. TEST FACILITY

The open area test site and conducted measurement facility used to collect the radiated data are located at the 254-1, Maekok-Ri, Hobup-Myun, Ichon-Si, Kyoungki-Do, 467-701, KOREA. The site is constructed in conformance with the requirements of ANSI C63.4 and CISPR Publication 22. Detailed description of test facility was submitted to the Commission and accepted dated July 6, 2006(Registration Number: 90661)

FCC CERTIFICATION REPORT				www.hct.co.kr
Test Report No. HCT-RF09-0527	Test Dates: May 29, 2009	EUT Type: Tri-Band CDMA Phone (CDMA/PCS CDMA/AWS CDMA) with Bluetooth	FCC ID: US7-A200	Page 4 of 45

3. DESCRIPTION OF TESTS

3.1 Effective Radiated Power/Equivalent Isotropic Radiated Power

Test Set-up

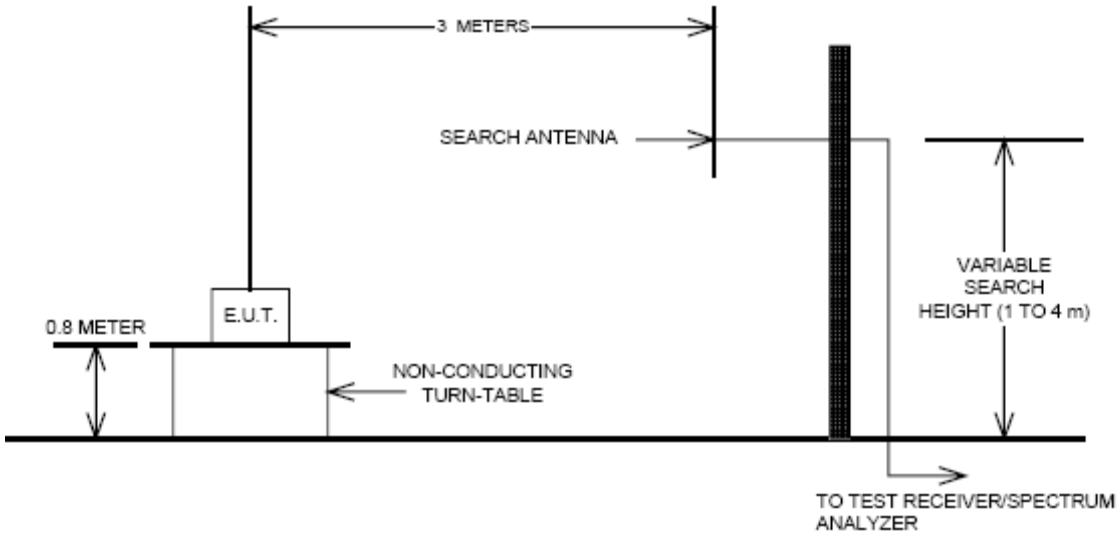

Test Procedure

Radiated emission measurements were performed at an open Site.

The equipment under test is placed on a wooden turntable 3-meters from the receive antenna.

A wooden turntable was rotated 360° and the receiving antenna scanned from 1-4m in order to capture the maximum emission. A half wave dipole was substituted in place of the EUT. This dipole antenna was driven by a signal generator and the previously recorded signal was duplicated.

The maximum EIRP was calculated by adding the forward power to the calibrated source plus its appropriate gain value. These steps were carried out with the receiving antenna in both vertical and horizontal polarization. For readings above 1GHz, the above procedure is repeated using horn antennas and the difference between the gain of the horn and an isotropic antenna are taken into consideration.

Note : This device was tested under all R.C.s and S.O.s and worst case is reported with RC1/SO55, with 'All Up' power control bits.



3.2 Peak- to- Average Ratio

A peak to average ratio measurement is performed at the conducted port of the EUT. For CDMA and WCDMA signals, the spectrum analyzers Complementary Cumulative Distribution Function (CCDF) measurement profile is used to determine the largest deviation between the average and the peak power of the EUT in a given bandwidth. The CCDF curve shows how much time the peak waveform spends at or above a given average power level. The percent of time the signal spends at or above the level defines the probability for that particular power level. For GSM signals, an average and a peak trace are used on a spectrum analyzer to determine the largest deviation between the average and the peak power of the EUT in a bandwidth greater than the emission bandwidth. Plots of the EUT's Peak- to- Average Ratio are shown herein.

Note : This device was tested under all R.C.s and S.O.s and worst case is reported with RC1/SO55, with 'All Up' power control bits.

FCC CERTIFICATION REPORT				www.hct.co.kr
Test Report No. HCT-RF09-0527	Test Dates: May 29, 2009	EUT Type: Tri-Band CDMA Phone (CDMA/PCS CDMA/AWS CDMA) with Bluetooth	FCC ID: US7-A200	Page 6 of 45

3.3 Occupied bandwidth.

Test set-up

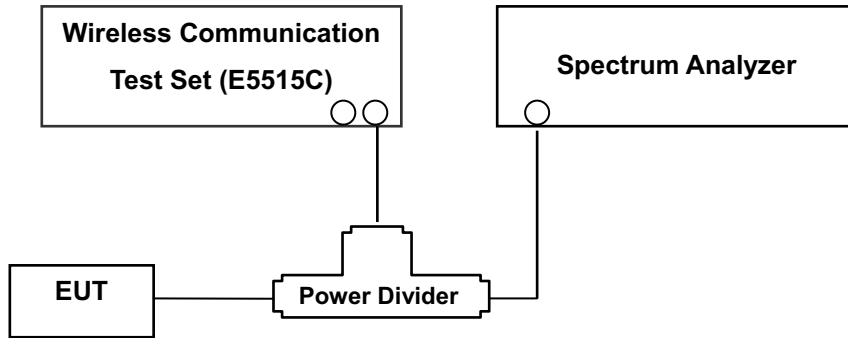

(Configuration of conducted Emission measurement)

Test Procedure

The EUT was setup to maximum output power at its lowest channel. The occupied bandwidth was measured using a spectrum analyzer. The measurements are repeated for the highest and a middle channel. The EUT's occupied bandwidth is measured as the width of the signal between two points, one below the carrier center frequency and one above the carrier frequency, outside of which all emissions are attenuated at least 26 dB below the transmitter power. Plots of the EUT's occupied bandwidth are shown herein.

Note : This device was tested under all R.C.s and S.O.s and worst case is reported with RC1/SO55, with 'All Up' power control bits.



3.4 Spurious and Harmonic Emissions at Antenna Terminal.

Test Procedure

The level of the carrier and the various conducted spurious and harmonic frequencies is measured by means of a calibrated spectrum analyzer.

The EUT was setup to maximum output power at its lowest channel. The Resolution BW of the analyzer is set to 1 % of the emission bandwidth to show compliance with the – 13 dBm limit, in the 1 MHz bands immediately outside and adjacent to the edge of the frequency block. The 1 MHz RBW was used to scan from 30 MHz to 10 GHz. (PCS CDMA Mode: 30 MHz to 20 GHz). A display line was placed at – 13 dBm to show compliance. The high, lowest and a middle channel were tested for out of band measurements.

- Band Edge Requirement : In the 1MHz bands immediately outside and adjacent to the frequency block, a resolution bandwidth of at least 1 percent of the emission bandwidth of the fundamental emission of the transmitter may be employed to measure the out of band Emissions. Limit, -13dBm.

Note : This device was tested under all R.C.s and S.O.s and worst case is reported with RC1/SO55, with 'All Up' power control bits.

FCC CERTIFICATION REPORT				www.hct.co.kr
Test Report No. HCT-RF09-0527	Test Dates: May 29, 2009	EUT Type: Tri-Band CDMA Phone (CDMA/PCS CDMA/AWS CDMA) with Bluetooth	FCC ID: US7-A200	Page 8 of 45

3.5 Radiated Spurious and Harmonic Emissions

Test Set-up

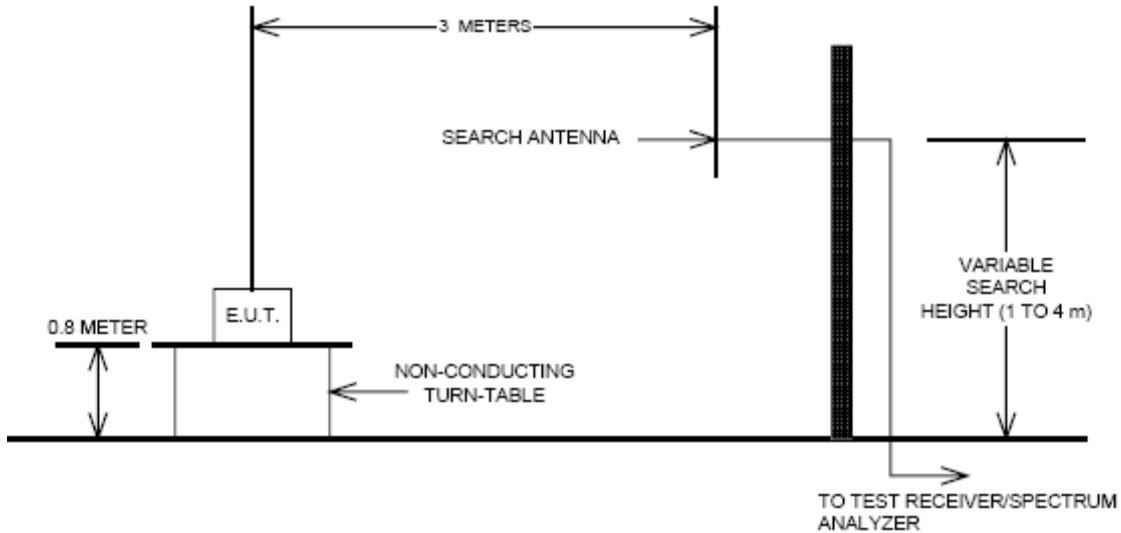

The measurement facilities used for this test have been documented in previous filings with the commission pursuant to section § 2.948. The open field test site is situated in open field with ground screen whose site attenuation characteristics meet ANSI C63.4 –2003. A mast capable of lifting the receiving antenna from a height of one to four meters is used together with a rotatable wooden platform mounted at three from the antenna mast.

- 1) The unit mounted on a wooden table 1.5 m × 1.0 m × 0.80 m is 0.8 meter above test site ground level.
- 2) During the emission test, the turntable is rotated and the EUT is manipulated to find the configuration resulting in maximum emission under normal condition of installation and operation.
- 3) The antenna height and polarization are also varied from 1 to 4 meters until the maximum signal is found.
- 4) The spectrum shall be scanned up to the 10th harmonic of the fundamental frequency.

Test Procedure

The equipment under test is placed on a wooden turntable 3-meters from the receive antenna.

A wooden turntable was rotated 360° and the receiving antenna scanned from 1-4m in order to capture the maximum emission. A half wave dipole was substituted in place of the EUT. This dipole antenna was driven by a signal generator and the previously recorded signal was duplicated.

The maximum EIRP was calculated by adding the forward power to the calibrated source plus its appropriate gain value. These steps were carried out with the receiving antenna in both vertical and horizontal polarization. For readings above 1GHz, the above procedure is repeated using horn antennas and the difference between the gain of the horn and an isotropic antenna are taken into consideration.

Note : This device was tested under all R.C.s and S.O.s and worst case is reported with RC1/SO55, with 'All Up' power control bits.

FCC CERTIFICATION REPORT				www.hct.co.kr
Test Report No. HCT-RF09-0527	Test Dates: May 29, 2009	EUT Type: Tri-Band CDMA Phone (CDMA/PCS CDMA/AWS CDMA) with Bluetooth	FCC ID: US7-A200	Page 9 of 45

3.6 Frequency stability / variation of ambient temperature

Test Set-up

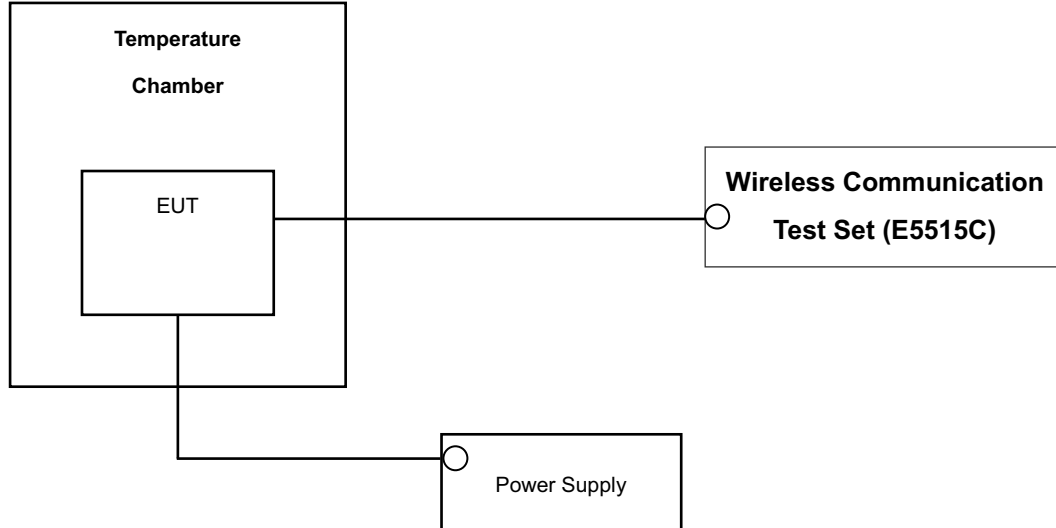

* Nominal Operating Voltage

Test Procedure

The frequency stability of the transmitter is measured by:

- a.) **Temperature:** The temperature is varied from - 30 °C to + 50 °C using an environmental chamber.
- b.) **Primary Supply Voltage:** The primary supply voltage is varied from battery end point to 115 % of the voltage normally at the input to the device or at the power supply terminals if cables are not normally supplied.

Specification — the frequency stability shall be sufficient to ensure that the fundamental emission stays within the authorized frequency block. The frequency stability of the transmitter shall be maintained within $\pm 0.00025\%$ (± 2.5 ppm) of the center frequency.

Time Period and Procedure:

The carrier frequency of the transmitter is measured at room temperature (20°C to provide a reference).

1. The equipment is turned on in a “standby” condition for one minute before applying power to the transmitter. Measurement of the carrier frequency of the transmitter is made within one minute after applying power to the transmitter.
2. Frequency measurements are made at 10°C intervals ranging from -30°C to +50°C. A period of at least one half-hour is provided to allow stabilization of the equipment at each temperature level.

NOTE: The EUT is tested down to the battery endpoint.

Note : This device was tested under all R.C.s and S.O.s and worst case is reported with RC1/SO55, with 'All Up' power control bits.



4. LIST OF TEST EQUIPMENT

Manufacture	Model/ Equipment	Serial Number	Calibration Interval	Calibration Due
R&S	ESI40/ Spectrum Analyzer	831564/003	Annual	10/31/2009
Agilent	E4416A/ Power Meter	GB41291412	Annual	01/21/2010
Agilent	E9327A/ Power Sensor	MY4442009	Annual	07/28/2009
Agilent	8960 (E5515C)/ Base Station	GB44400269	Annual	02/10/2010
MITEQ	AMF-60-0010 1800-35-20P / AMP	1200937	Annual	05/20/2010
Wainwright	WHK1.2/15G-10EF/H.P.F	2	Annual	06/28/2009
Wainwright	WHK3.3/18G-10EF/H.P.F	1	Annual	06/28/2009
Agilent	775D/ Dual Directional Coupler	12922	Annual	12/24/2009
Agilent	11636B/ Power Divider	11377	Annual	12/24/2009
Digital	EP-3010/ Power Supply	3110117	Annual	01/07/2010
Schwarzbeck	UHAP/ Dipole Antenna	585	Annual	02/13/2011
Schwarzbeck	UHAP/ Dipole Antenna	558	Annual	02/13/2011
Korea Engineering	KR-1005L / Chamber	KRAB07063-2CH	Annual	12/31/2009
Schwarzbeck	BBHA 9120D/ Horn Antenna	147	Biennial	03/26/2010
Agilent	E4440A/Spectrum Analyzer	US45303008	Annual	12/23/2009



5. SUMMARY OF TEST RESULTS

FCC Part Section(s)	Test Description	Test Limit	Test Condition	Test Result
2.1049, 22.917(a), 24.238(a), 27.53(g)(1)	Occupied Bandwidth	N/A	CONDUCTED	PASS
2.1051, 22.917(a), 24.238(a), 27.53(g)	Band Edge / Spurious and Harmonic Emissions at Antenna Terminal.	$< 43 + 10\log_{10}(P[\text{Watts}])$ at Band Edge and for all out-of-band emissions		PASS
2.1046	Conducted Output Power	N/A		PASS
24.232(d), 27.50(d)(5)	Peak- to- Average Ratio	< 13 dB		PASS
2.1055, 22.355, 24.235, 27.54	Frequency stability / variation of ambient temperature	< 2.5 ppm		PASS
22.913(a)(2) 24.232(c), 27.50(d)(2)	Effective Radiated Power	< 7 Watts max. ERP	RADIATED	PASS
	Equivalent Isotropic Radiated Power	< 2 Watts max. EIRP(PCS) < 1 Watts max. EIRP(AWS)		PASS
2.1053, 22.917(a), 24.238(a), 27.53(g)	Radiated Spurious and Harmonic Emissions	$< 43 + 10\log_{10}(P[\text{Watts}])$ for all out-of band emissions		PASS



6. SAMPLE CALCULATION

A. ERP Sample Calculation

Mode	Ch./ Freq.		Measured Level(dBm)	Substitute LEVEL(dBm)	Ant. Gain	C.L	Pol.	ERP	
	channel	Freq.(MHz)						W	dBm
CDMA	384	836.52	-10.96	24.81	2.50	1.19	H	0.41	26.12

ERP = SubstituteLEVEL(dBm) + Ant. Gain – CL(Cable Loss)

- 1) The EUT mounted on a wooden tripod is 0.8 meter above test site ground level.
- 2) During the test , the turn table is rotated and the antenna height is also varied from 1 to 4 meters until the maximum signal is found.
- 3) Record the field strength meter's level.
- 4) Replace the EUT with dipole/Horn antenna that is connected to a calibrated signal generator.
- 5) Increase the signal generator output till the field strength meter's level is equal to the item (3).
- 6) The signal generator output level with Ant. Gain and cable loss are the rating of effective radiated power (**ERP**).

B. Emission Designator

CDMA Emission Designator

Emission Designator = 1M27F9W

CDMA BW = 1.27 MHz (Measured at the 99% power bandwidth)

F = Frequency Modulation

9 = Composite Digital Info

W = Combination (Audio/Data)



7. TEST DATA

7.1 Conducted Output Power

A base station simulator was used to establish communication with The EUT. The base station simulator parameters were set to produce the maximum power from the EUT. This device was tested under all configurations and the highest power is reported. Conducted Output Powers of EUT are reported below.

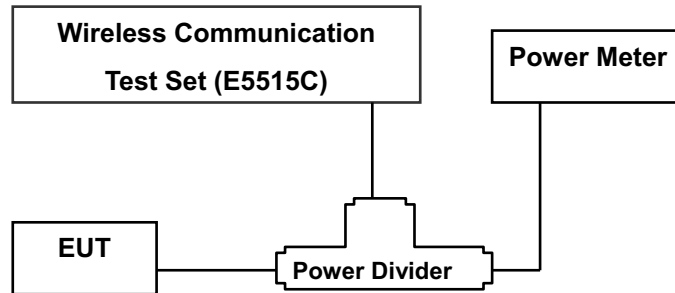

Band	Channel	SO2	SO2	SO55	SO55	TDSO SO32
		RC1/1 (dBm)	RC3/3 (dBm)	RC1/1 (dBm)	RC3/3 (dBm)	RC3/3 (dBm)
CDMA	1013	24.01	23.83	23.97	23.90	24.10
	384	24.08	24.17	24.12	24.19	23.84
	777	23.86	23.97	23.90	23.94	23.97
PCS	25	23.94	23.83	24.02	23.82	24.07
	600	24.01	23.83	24.13	23.87	23.99
	1175	24.02	23.72	23.86	23.74	23.83
AWS	25	24.24	24.25	24.20	24.23	23.87
	450	24.01	23.75	24.02	23.78	23.74
	875	24.25	24.05	24.26	24.05	23.94

(Maximum Conducted Output Powers)

7.2 Peak-to-Average Ratio

- Plots of the EUT's Peak- to- Average Ratio are shown Page 28, 30.



7.3 Occupied Bandwidth

Band	Channel	Frequency(MHz)	Data (kHz)
CDMA	1013	824.70	1.2795
	384	836.52	1.2759
	777	848.31	1.2788
PCS	25	1851.25	1.2760
	600	1880.00	1.2799
	1175	1908.75	1.2806
AWS	25	1711.25	1.2772
	450	1732.50	1.2815
	875	1753.75	1.2813

- Plots of the EUT's Occupied Bandwidth are shown Page 25 ~ 27, 28 ~ 29.

7.4 Conducted Spurious Emissions

Band	Channel	Frequency of Maximum Harmonic (GHz)	Maximum Data (dBm)
CDMA	1013	7.8375	-40.79
	384	7.0125	-41.18
	777	7.6875	-41.62
PCS	25	3.7020	-31.99
	600	3.7620	-26.80
	1175	3.8210	-19.26
AWS	25	3.4240	-33.30
	450	3.4640	-25.33
	875	3.5040	-24.13

- Plots of the EUT's Conducted Spurious Emissions are shown Page 36 ~ 45.

7.4.1 Band Edge

- Plots of the EUT's Band Edge are shown Page 30 ~36.



7.5 Effective Radiated Power Output(CDMA)

(CDMA Mode)

Mode	Ch./ Freq.		Measured Level(dBm)	Substitute LEVEL (dBm)	Ant. Gain	C.L	Pol.	ERP	
	channel	Freq.(MHz)						W	dBm
CDMA	1013	824.70	-12.71	33.12	-8.31	1.17	H	0.23	23.64
	384	836.52	-12.19	34.30	-8.22	1.19	H	0.31	24.89
	777	848.31	-12.19	34.94	-8.13	1.20	H	0.36	25.61

Note: Standard batteries are the only options for this phone

NOTES:

Effective Radiated Power Output Measurements by Substitution Method

according to ANSI/TIA/EIA-603-C-2004, Aug. 17, 2004:

The EUT was placed on a wooden turn table 3-meters from the receive antenna. The receive antenna height and turntable rotation was adjusted for the highest reading on the receive spectrum analyzer. For CDMA signals, a peak detector is used, with RBW = VBW = 3 MHz. For WCDMA signals, a peak detector is used, with RBW = VBW = 5MHz. For AMPS, GSM, and NADC TDMA signals, a peak detector is used, with RBW = VBW = 1 MHz. A half-wave dipole was substituted in place of the EUT. This dipole antenna was driven by a signal generator and the level of the signal generator was adjusted to obtain the same receive spectrum analyzer reading. The conducted power at the terminals of the dipole is measured. The ERP is recorded.

This device was tested under all configurations and the highest power is reported.



7.6 Equivalent Isotropic Radiated Power (E.I.R.P.) (PCS CDMA)

(PCS CDMA Mode)

Mode	Ch./ Freq.		Measured Level(dBm)	Substitute LEVEL (dBm)	Ant. Gain	C.L	Pol.	EIRP	
	channel	Freq.(MHz)						W	dBm
PCS	25	1,851.25	-13.46	18.15	10.05	1.91	H	0.42	26.28
	600	1,880.00	-12.00	19.82	10.05	1.95	H	0.62	27.92
	1175	1,908.75	-13.81	18.09	10.06	1.97	H	0.41	26.18

(AWS CDMA Mode)

Mode	Ch./ Freq.		Measured Level(dBm)	Substitute LEVEL (dBm)	Ant. Gain	C.L	Pol.	EIRP	
	channel	Freq.(MHz)						W	dBm
AWS	25	1,711.25	-13.70	17.67	9.61	1.86	H	0.35	25.43
	450	1,732.50	-14.31	17.05	9.70	1.87	H	0.31	24.89
	875	1,753.75	-11.83	19.52	9.80	1.88	H	0.55	27.44

Note: Standard batteries are the only options for this phone

NOTES:

Equivalent Isotropic Radiated Power Measurements by Substitution Method according to ANSI/TIA/EIA-603-C-2004, Aug. 17, 2004:

The EUT was placed on a wooden turn table 3-meters from the receive antenna. The receive antenna height and turntable rotation was adjusted for the highest reading on the receive spectrum analyzer. For CDMA signals, a peak detector is used, with RBW = VBW = 3 MHz. For WCDMA signals, a peak detector is used, with RBW = VBW = 5MHz. For AMPS, GSM, and NADC TDMA signals, a peak detector is used, with RBW = VBW = 1 MHz. A Horn antenna was substituted in place of the EUT. This Horn antenna was driven by a signal generator and the level of the signal generator was adjusted to obtain the same receive spectrum analyzer reading. The conducted power at the terminals of the Horn antenna is measured. The difference between the gain of the horn and an isotropic antenna is taken into consideration and the EIRP is recorded.

This device was tested under all configurations and the highest power is reported.



7.7 Radiated Spurious Emissions

7.7.1 Radiated Spurious Emissions(CDMA Mode)

- MEASURED OUTPUT POWER: 25.61 dBm = 0.364 W
- MODULATION SIGNAL: CDMA
- DISTANCE: 3 meters
- LIMIT: $-(43 + 10 \log_{10}(W)) =$ - 38.61 dBc

Ch.	Freq.(MHz)	Measured Level [dBm]	Ant. Gain	Substitute Level [dBm]	C.L	Pol.	ERP (dBm)	dBc
1013	1,649.40	-45.00	7.09	-55.53	1.73	H	-50.17	-75.78
	2,474.10	-55.45	8.12	-62.56	2.28	V	-56.72	-82.33
	3,298.80	-54.09	9.72	-61.67	2.57	H	-54.52	-80.13
384	1,673.04	-44.80	7.23	-55.56	1.79	H	-50.12	-75.73
	2,509.56	-57.50	8.14	-64.63	2.33	H	-58.82	-84.43
	3,346.08	-54.35	9.99	-62.38	2.66	H	-55.05	-80.66
777	1,696.62	-43.56	7.41	-54.17	1.83	H	-48.59	-74.20
	2,544.93	-57.02	8.21	-64.30	2.34	H	-58.43	-84.04
	3,393.24	-54.31	9.91	-61.94	2.85	H	-54.88	-80.49

NOTES: 1. Radiated Spurious Emission Measurements at 3 meters by Substitution Method

according to ANSI/TIA/EIA-603-C-2004, Aug. 17, 2004:

2. The magnitude of spurious emissions attenuated more than 20dB below the limit above 5th Harmonic for all channel.



7.7.2 Radiated Spurious Emissions(PCS CDMA Mode)

- MEASURED OUTPUT POWER: 27.92 dBm = 0.619 W
- MODULATION SIGNAL: PCS CDMA
- DISTANCE: 3 meters
- LIMIT: - (43 + 10 log₁₀ (W)) = - 40.92 dBc

Ch.	Freq.(MHz)	Measured Level [dBm]	Ant. Gain	Substitute Level [dBm]	C.L	Pol.	ERP (dBm)	dBc
25	3,702.50	-33.47	12.46	-39.74	2.73	V	-30.01	-57.93
	5,553.75	-29.90	12.70	-31.48	3.60	V	-22.38	-50.30
	7,405.00	-53.66	11.36	-44.78	3.88	V	-37.30	-65.22
600	3,760.00	-31.94	12.47	-37.91	2.73	V	-28.17	-56.09
	5,640.00	-25.56	12.75	-27.21	3.60	V	-18.06	-45.98
	7,520.00	-52.86	11.33	-43.76	3.88	H	-36.31	-64.23
1175	3,817.50	-31.17	12.49	-37.05	2.73	V	-27.29	-55.21
	5,726.25	-30.62	12.80	-31.93	3.60	V	-22.73	-50.65
	7,635.00	-53.14	11.30	-43.81	3.88	H	-36.39	-64.31

- NOTES:** 1. Radiated Spurious Emission Measurements at 3 meters by Substitution Method according to ANSI/TIA/EIA-603-C-2004, Aug. 17, 2004:
2. The magnitude of spurious emissions attenuated more than 20dB below the limit above 5th Harmonic for all channel.



7.7.3 Radiated Spurious Emissions(AWS CDMA Mode)

- MEASURED OUTPUT POWER: 27.44 dBm = 0.554 W
- MODULATION SIGNAL: AWS CDMA
- DISTANCE: 3 meters
- LIMIT: - (43 + 10 log₁₀ (W)) = - 40.44 dBc

Ch.	Freq.(MHz)	Measured Level [dBm]	Ant. Gain	Substitute Level [dBm]	C.L	Pol.	ERP (dBm)	dBc
25	3,422.50	-41.46	12.09	-49.12	2.68	H	-39.71	-67.15
	5,133.75	-49.88	12.15	-49.87	3.38	H	-41.10	-68.54
	6,845.00	-55.66	13.01	-51.52	3.50	V	-42.01	-69.45
450	3,465.00	-29.24	12.25	-36.54	2.68	H	-26.97	-54.41
	5,197.50	-54.54	12.15	-54.74	3.55	H	-46.14	-73.58
	6,930.00	-55.04	13.54	-51.06	3.50	V	-41.02	-68.46
875	3,507.50	-34.12	12.45	-41.06	2.66	H	-31.27	-58.71
	5,261.25	-52.61	12.15	-53.28	3.60	H	-44.73	-72.17
	7,015.00	-55.99	13.71	-50.51	3.50	V	-40.30	-67.74

- NOTES:** 1. Radiated Spurious Emission Measurements at 3 meters by Substitution Method according to ANSI/TIA/EIA-603-C-2004, Aug. 17, 2004:
2. The magnitude of spurious emissions attenuated more than 20dB below the limit above 5th Harmonic for all channel.



7.8 Frequency stability / variation of ambient temperature

7.8.1 FREQUENCY STABILITY (CDMA)

OPERATING FREQUENCY: 836,520,000 Hz
 CHANNEL: 384
 REFERENCE VOLTAGE: 3.7 VDC
 DEVIATION LIMIT: ± 0.000 25 % or 2.5 ppm

Voltage (%)	Power (VDC)	Temp. (°C)	Frequency (Hz)	Frequency Error (Hz)	Deviation (%)	ppm
100%	3.700	+20(Ref)	836 519 999	-1.49	0.000 000	-0.002
100%		-30	836 519 998	-2.08	0.000 000	-0.002
100%		-20	836 520 001	1.24	0.000 000	0.001
100%		-10	836 519 998	-1.77	0.000 000	-0.002
100%		0	836 520 002	1.98	0.000 000	0.002
100%		+10	836 519 997	-2.79	0.000 000	-0.003
100%		+20	836 520 004	3.54	0.000 000	0.004
100%		+30	836 519 998	-2.45	0.000 000	-0.003
100%		+40	836 520 002	2.06	0.000 000	0.002
100%		+50	836 519 998	-1.95	0.000 000	-0.002
115%	4.255	+20	836 520 002	2.16	0.000 000	0.003
Batt. Endpoint	3.400	+20	836 520 002	2.14	0.000 000	0.003

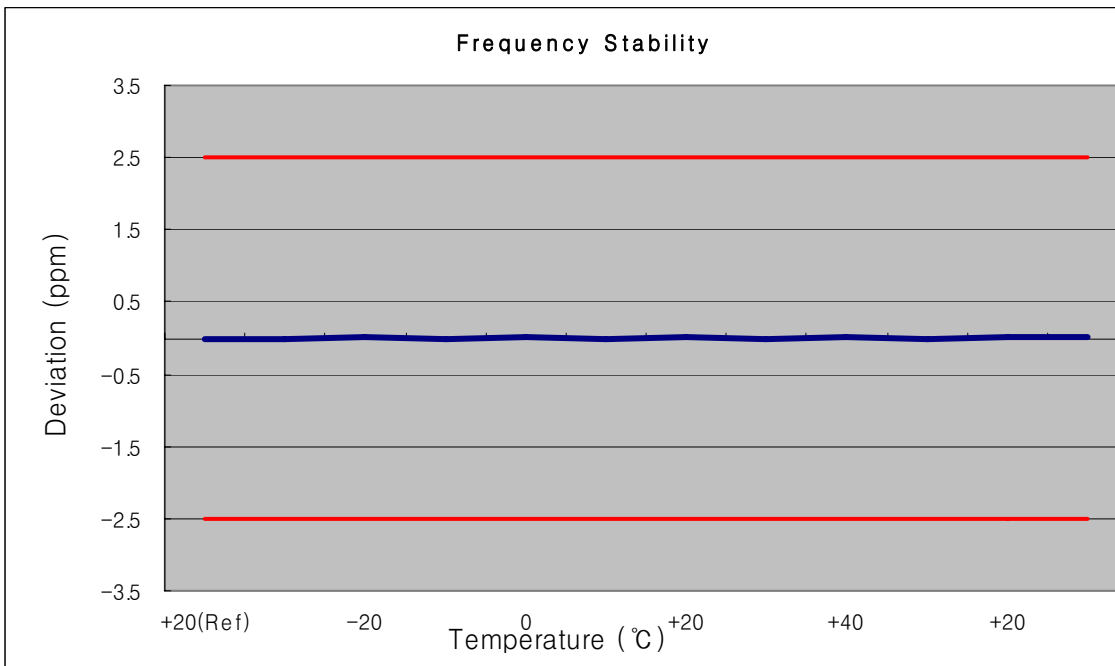



7.8.2 FREQUENCY STABILITY (PCS CDMA)

OPERATING FREQUENCY: 1880,000,000 Hz
 CHANNEL: 600
 REFERENCE VOLTAGE: 3.7 VDC
 DEVIATION LIM IT: ± 0.000 25 % or 2.5 ppm

Voltage (%)	Power (VDC)	Temp. (°C)	Frequency (Hz)	Frequency Error (Hz)	Deviation (%)	ppm
100%	3.700	+20(Ref)	1880 000 004	4.02	0.000 000	0.002
100%		-30	1879 999 996	-3.64	0.000 000	-0.002
100%		-20	1879 999 995	-4.62	0.000 000	-0.002
100%		-10	1880 000 002	2.17	0.000 000	0.001
100%		0	1879 999 994	-5.56	0.000 000	-0.003
100%		+10	1879 999 992	-8.32	0.000 000	-0.004
100%		+20	1880 000 003	3.32	0.000 000	0.002
100%		+30	1879 999 993	-7.26	0.000 000	-0.004
100%		+40	1879 999 997	-2.83	0.000 000	-0.002
100%		+50	1880 000 003	2.92	0.000 000	0.002
115%	4.255	+20	1879 999 994	-6.50	0.000 000	-0.003
Batt. Endpoint	3.400	+20	1879 999 996	-4.41	0.000 000	-0.002

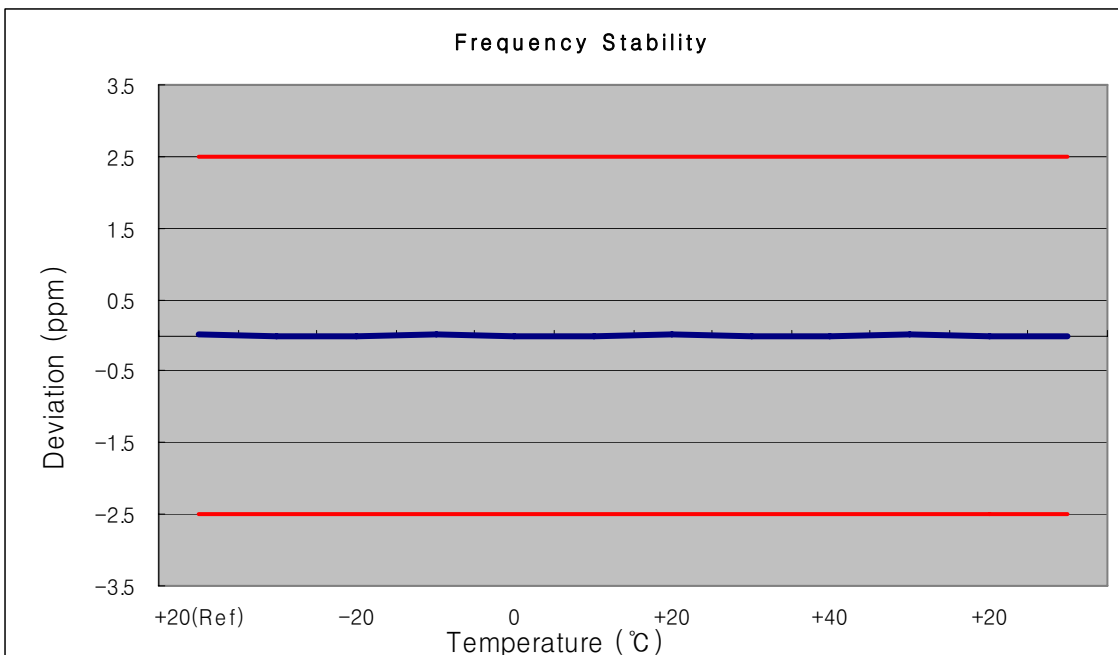



7.8.3 FREQUENCY STABILITY (AWS CDMA)

OPERATING FREQUENCY: 1732,500,000 Hz
 CHANNEL: 450
 REFERENCE VOLTAGE: 3.7 VDC
 DEVIATION LIM IT: ± 0.000 25 % or 2.5 ppm

Voltage (%)	Power (VDC)	Temp. (°C)	Frequency (Hz)	Frequency Error (Hz)	Deviation (%)	ppm
100%	3.700	+20(Ref)	1732 499 992	-8.10	0.000 000	-0.004
100%		-30	1732 499 994	-5.72	0.000 000	-0.003
100%		-20	1732 500 002	1.62	0.000 000	0.001
100%		-10	1732 499 996	-4.01	0.000 000	-0.002
100%		0	1732 499 994	-6.41	0.000 000	-0.003
100%		+10	1732 499 994	-5.60	0.000 000	-0.003
100%		+20	1732 500 003	3.39	0.000 000	0.002
100%		+30	1732 499 995	-4.72	0.000 000	-0.003
100%		+40	1732 500 001	1.11	0.000 000	0.001
100%		+50	1732 499 995	-5.00	0.000 000	-0.003
115%	4.255	+20	1732 500 003	3.09	0.000 000	0.002
Batt. Endpoint	3.400	+20	1732 499 994	-6.42	0.000 000	-0.003

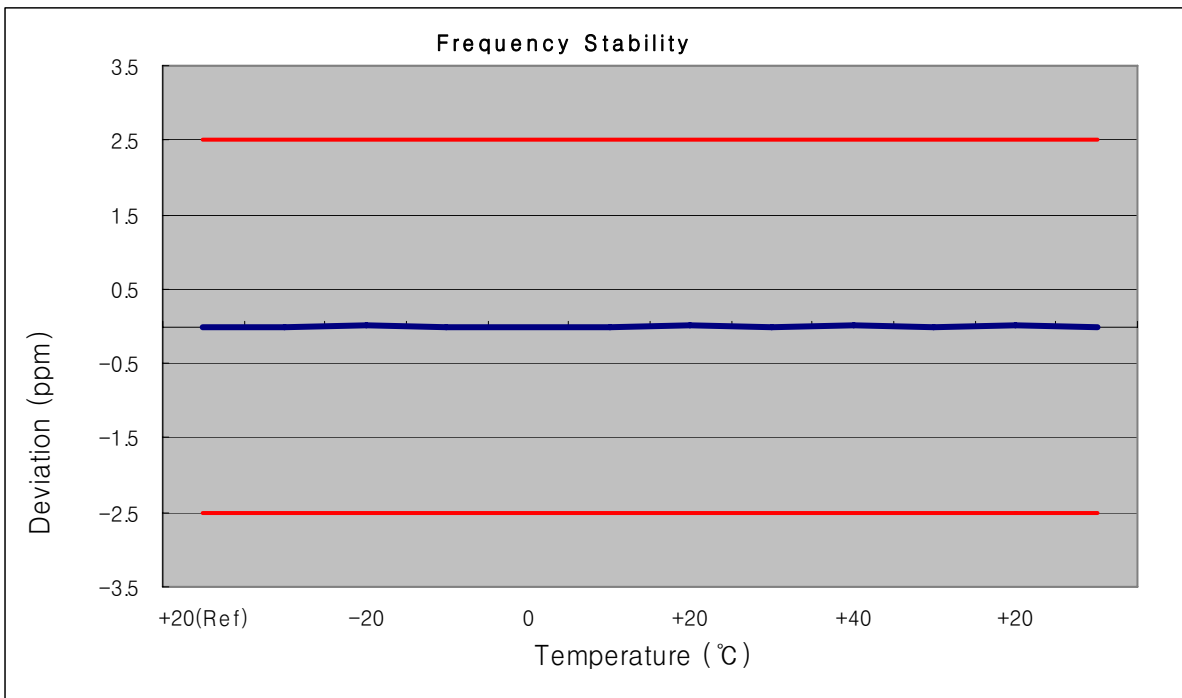



8. TEST PLOTS

FCC CERTIFICATION REPORT				www.hct.co.kr
Test Report No. HCT-RF09-0527	Test Dates: May 29, 2009	EUT Type: Tri-Band CDMA Phone (CDMA/PCS CDMA/AWS CDMA) with Bluetooth	FCC ID: US7-A200	Page 24 of 45



■ CDMA MODE (1013 CH.) Occupied Bandwidth

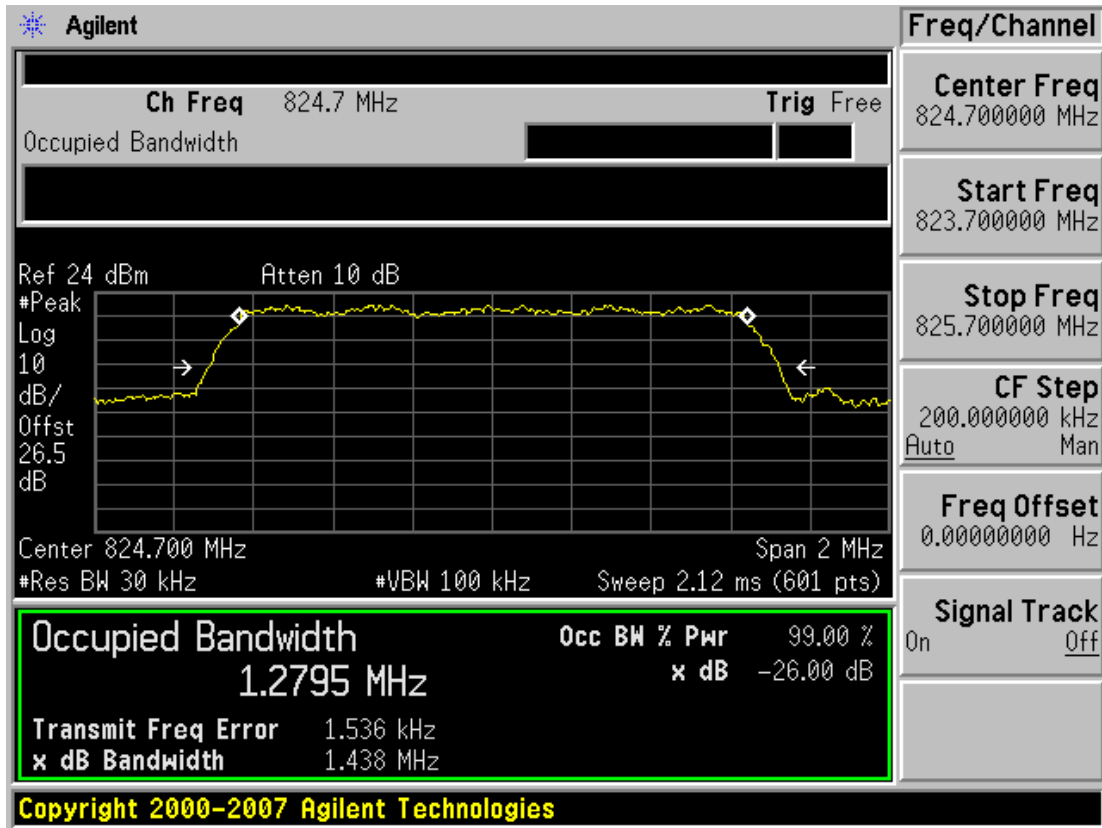

■ CDMA MODE (384 CH.) Occupied Bandwidth

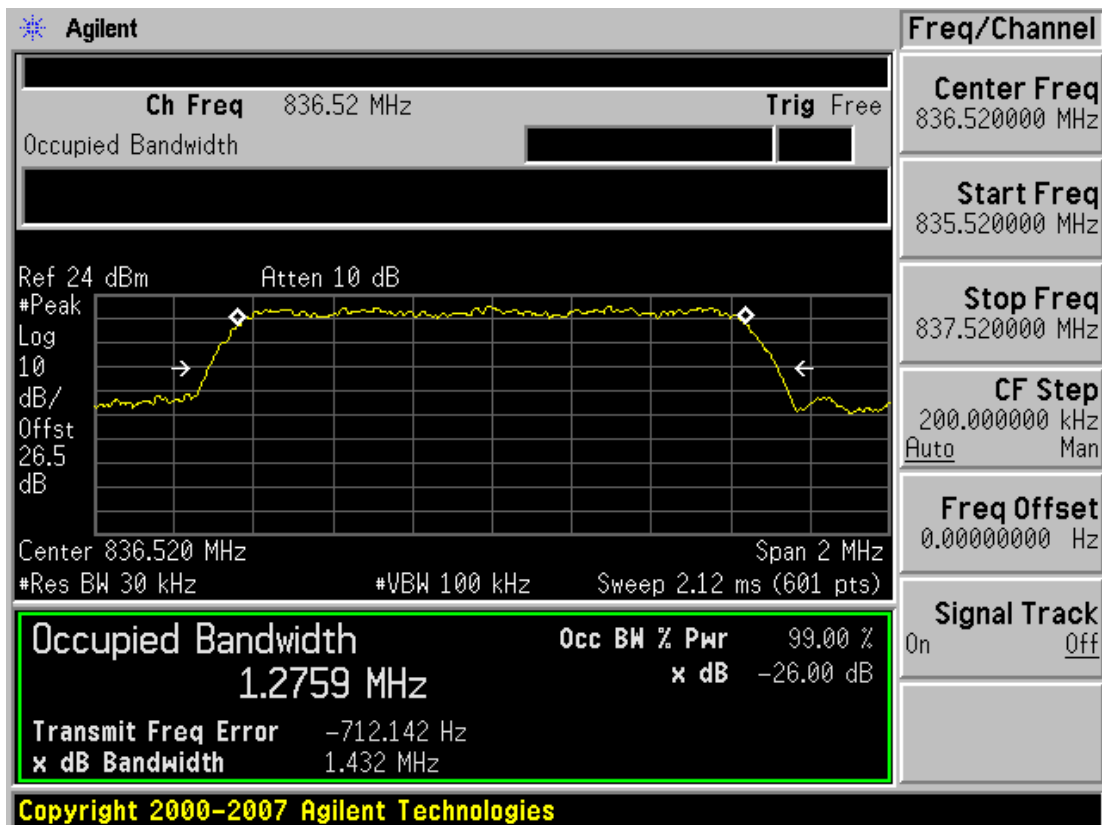

■ CDMA MODE (777 CH.) Occupied Bandwidth

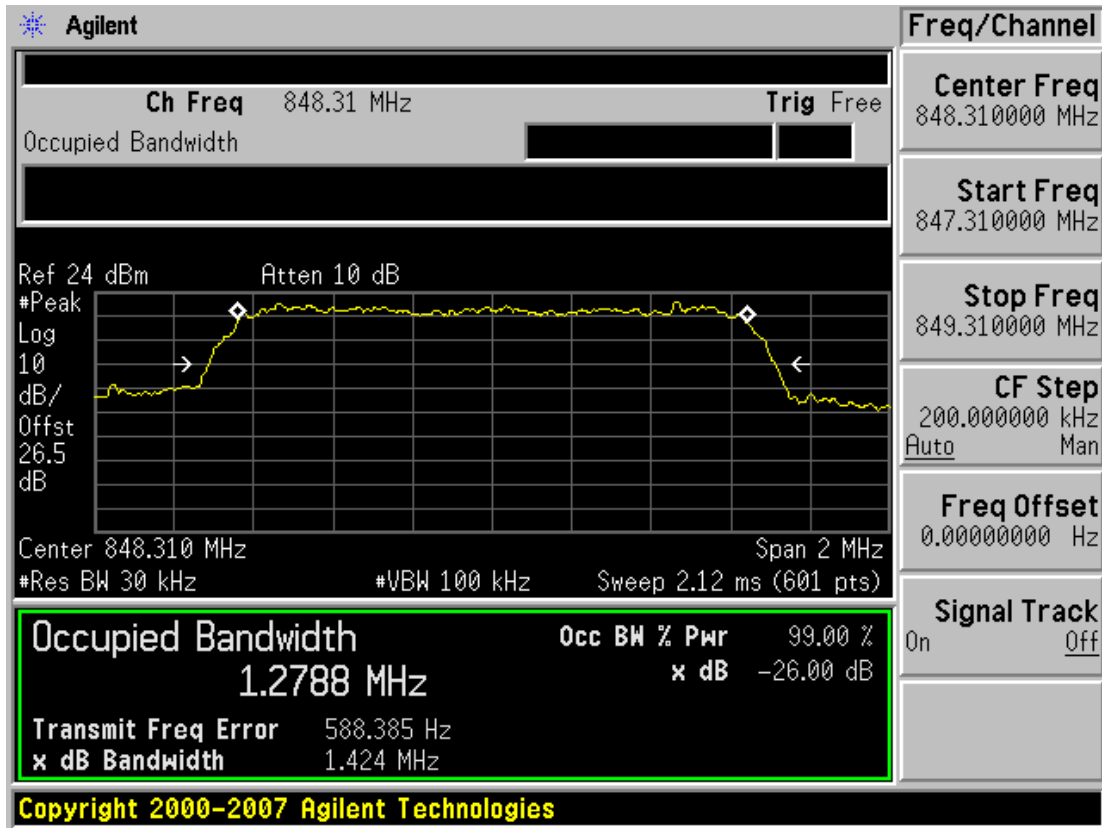

■ PCS CDMA MODE (25 CH.) Occupied Bandwidth

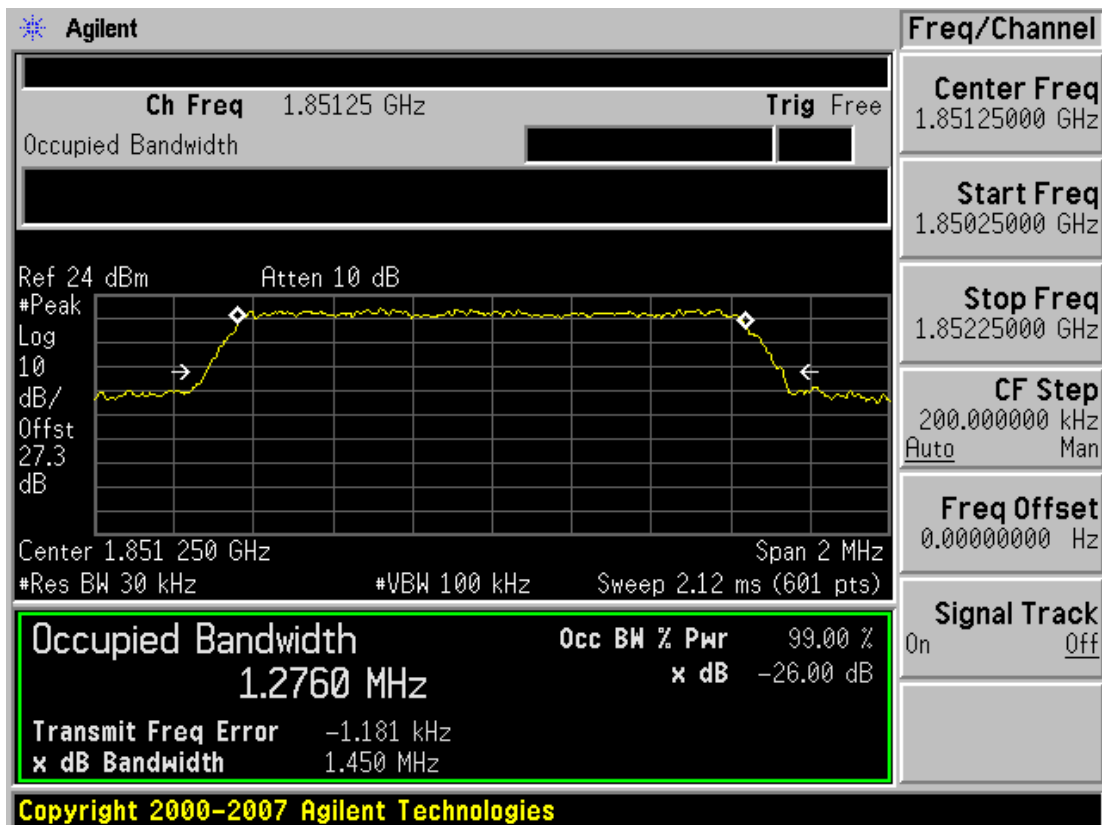



■ PCS CDMA MODE (600 CH.) Occupied Bandwidth

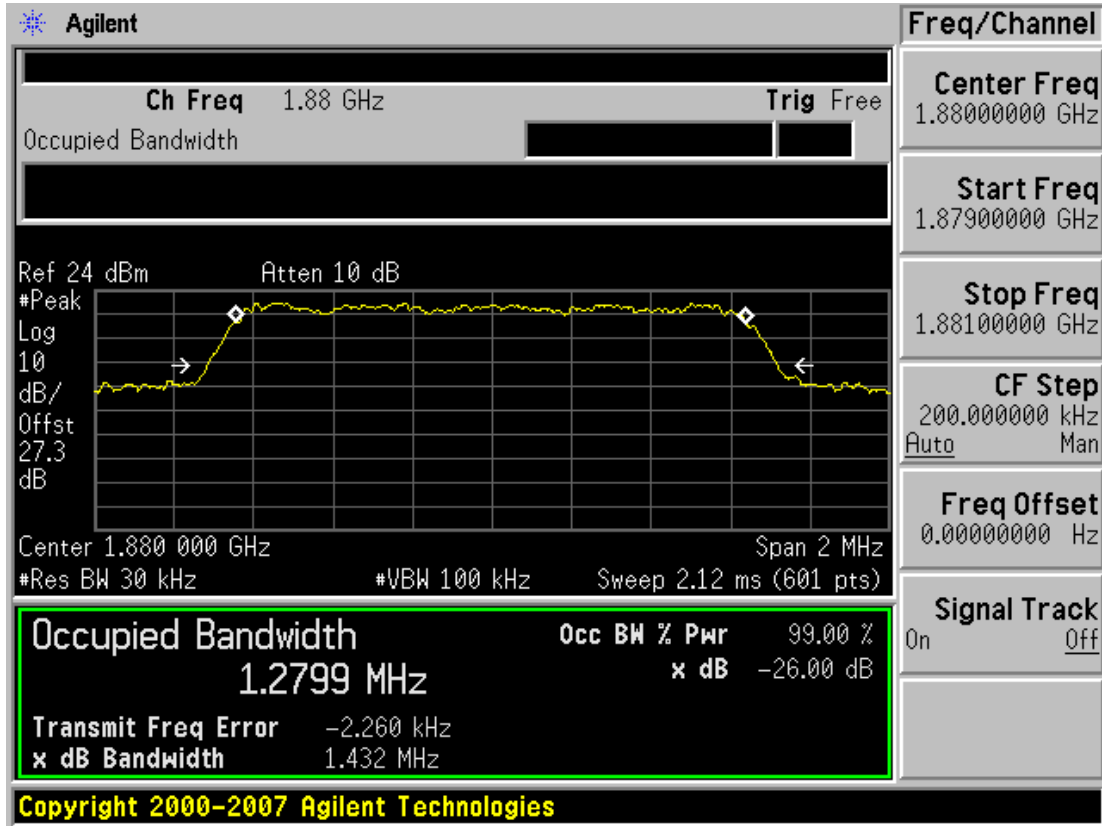

■ PCS CDMA MODE (1175 CH.) Occupied Bandwidth

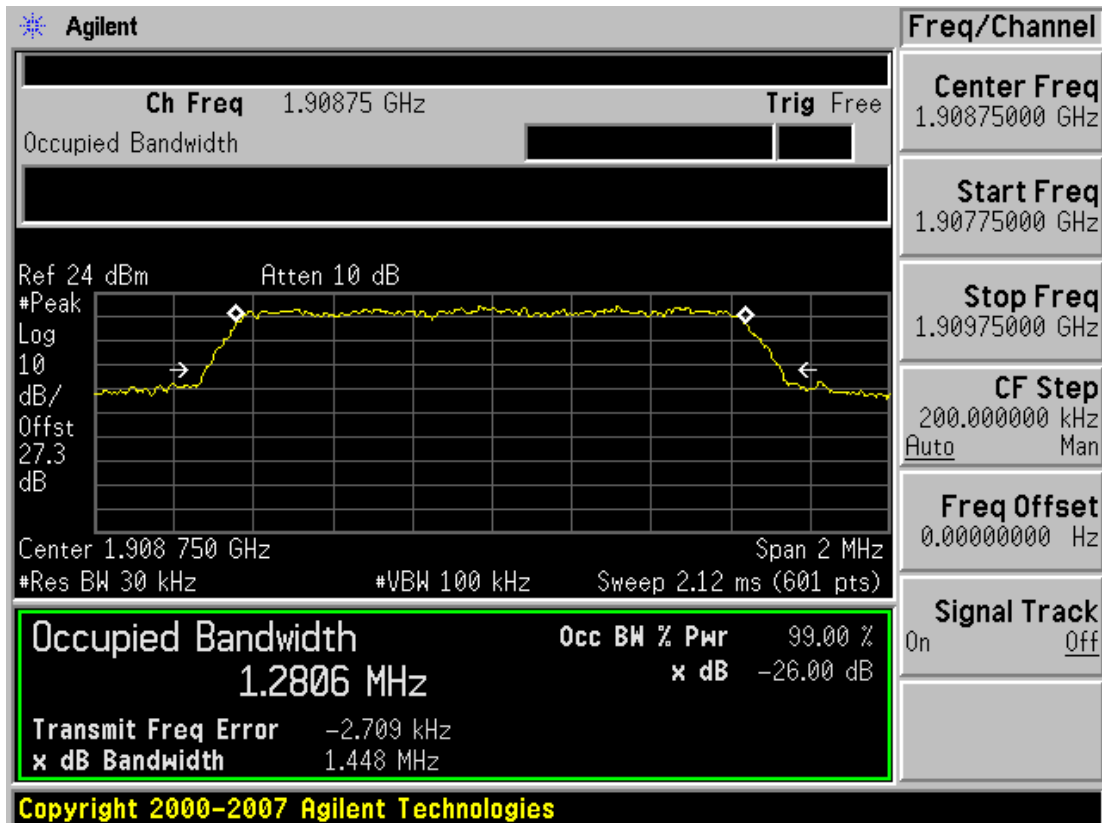



■ PCS CDMA MODE (661 CH.) Peak-to-Average Ratio

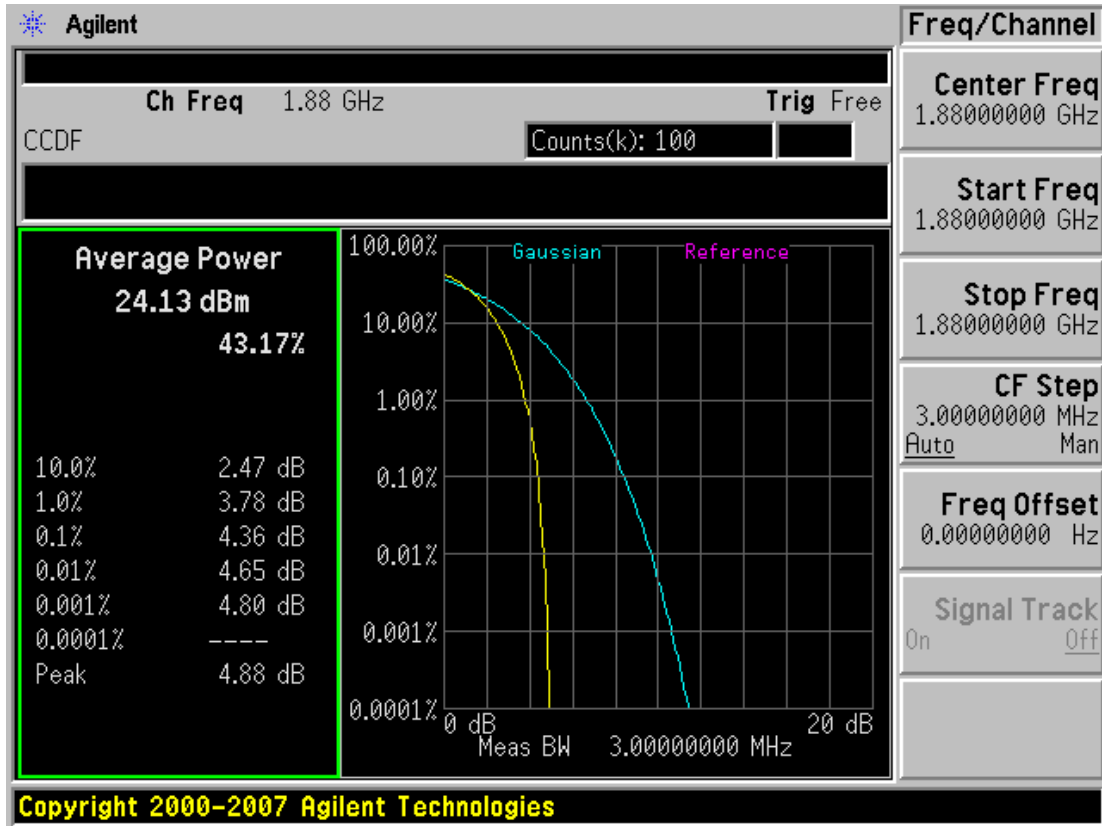

■ AWS CDMA MODE (25 CH.) Occupied Bandwidth

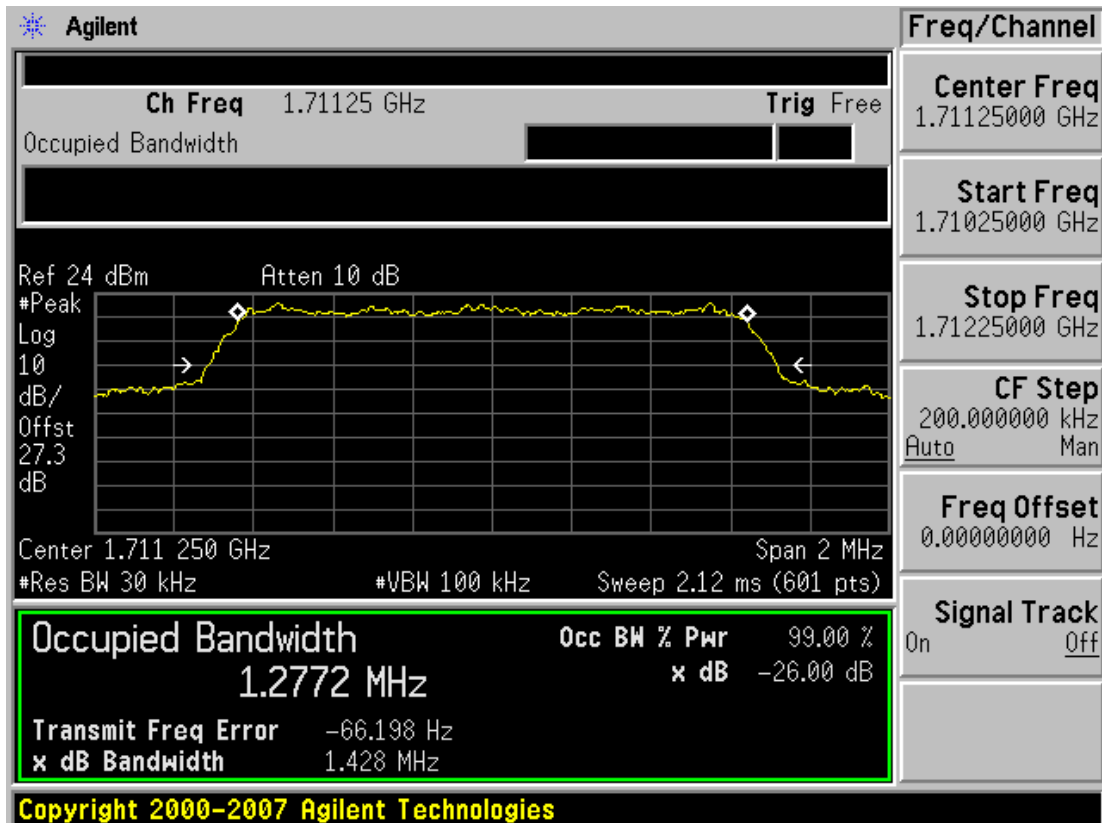



■ AWS CDMA MODE (450 CH.) Occupied Bandwidth

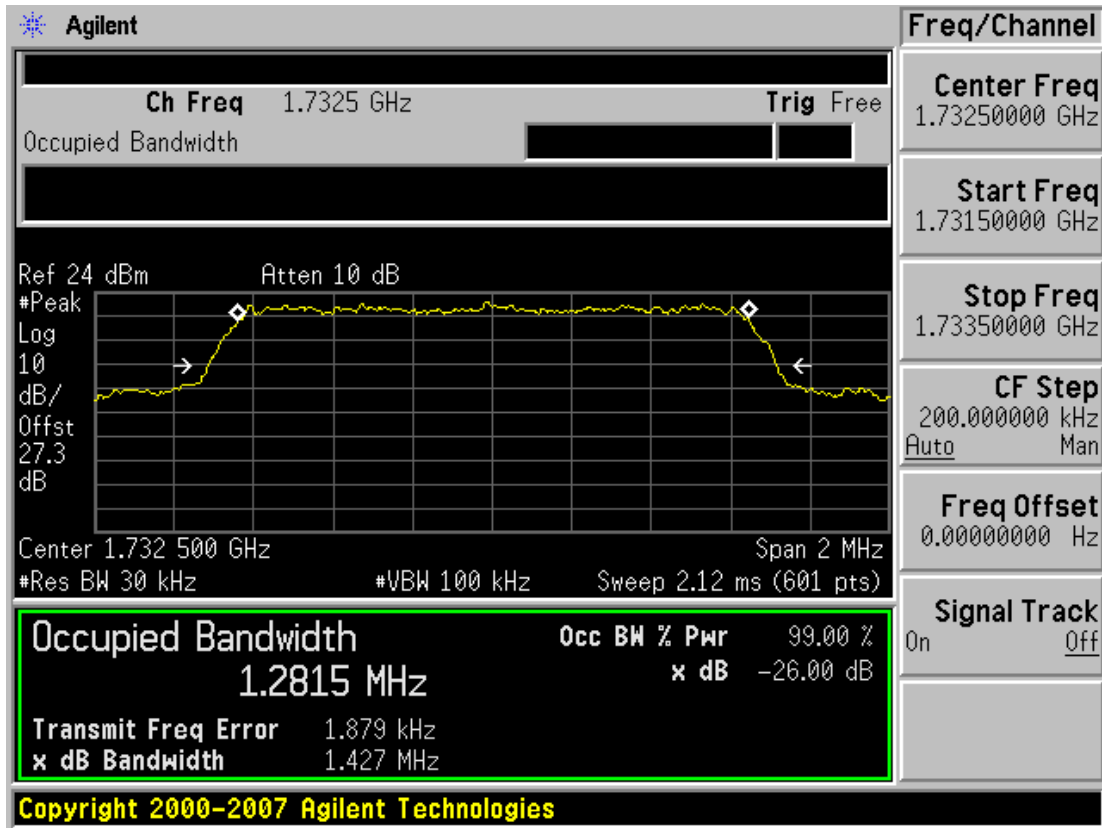

■ AWS CDMA MODE (875 CH.) Occupied Bandwidth

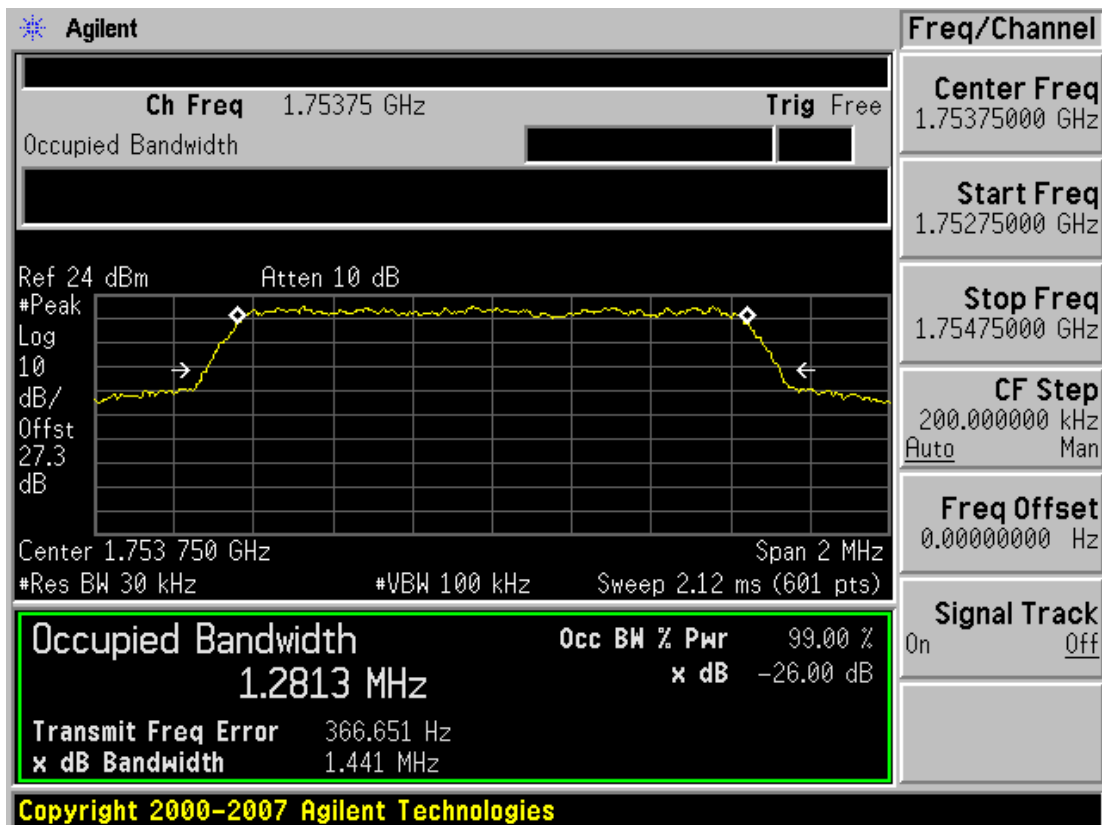



■ AWS CDMA MODE (450 CH.) Peak-to-Average Ratio

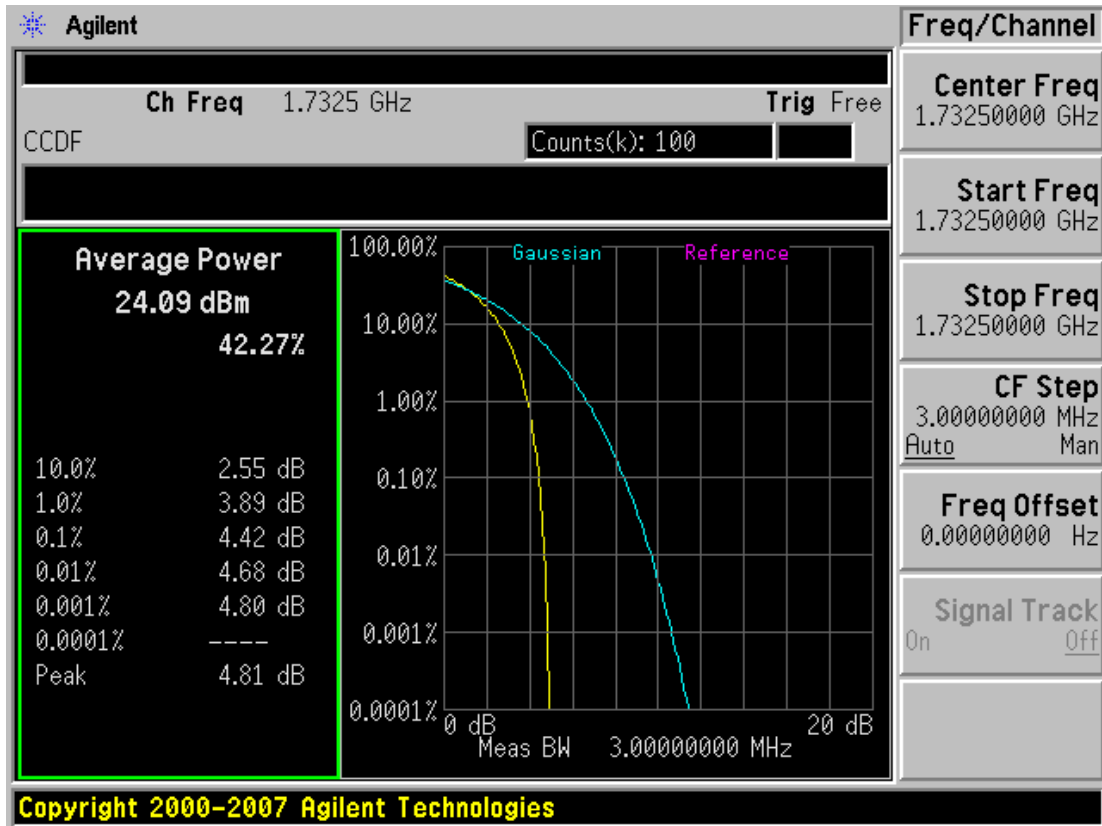

■ CDMA MODE (1013 CH.) Block Edge

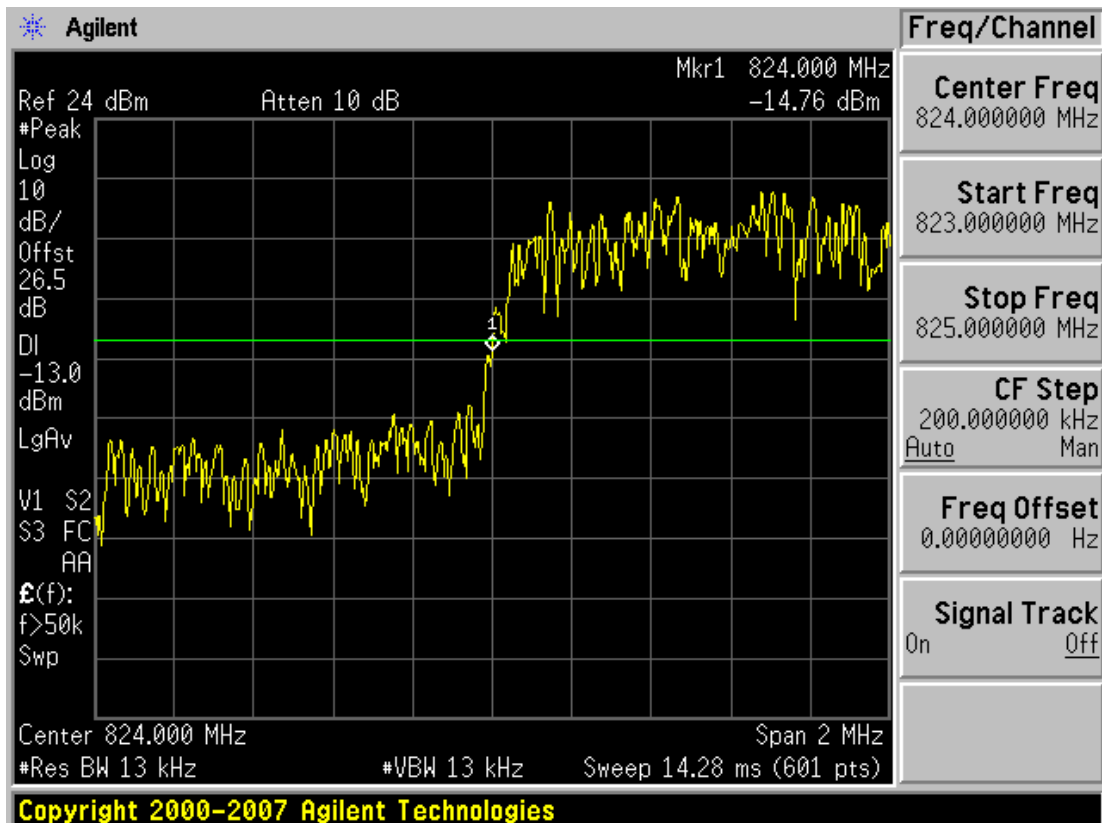

■ CDMA MODE (777 CH.) Block Edge

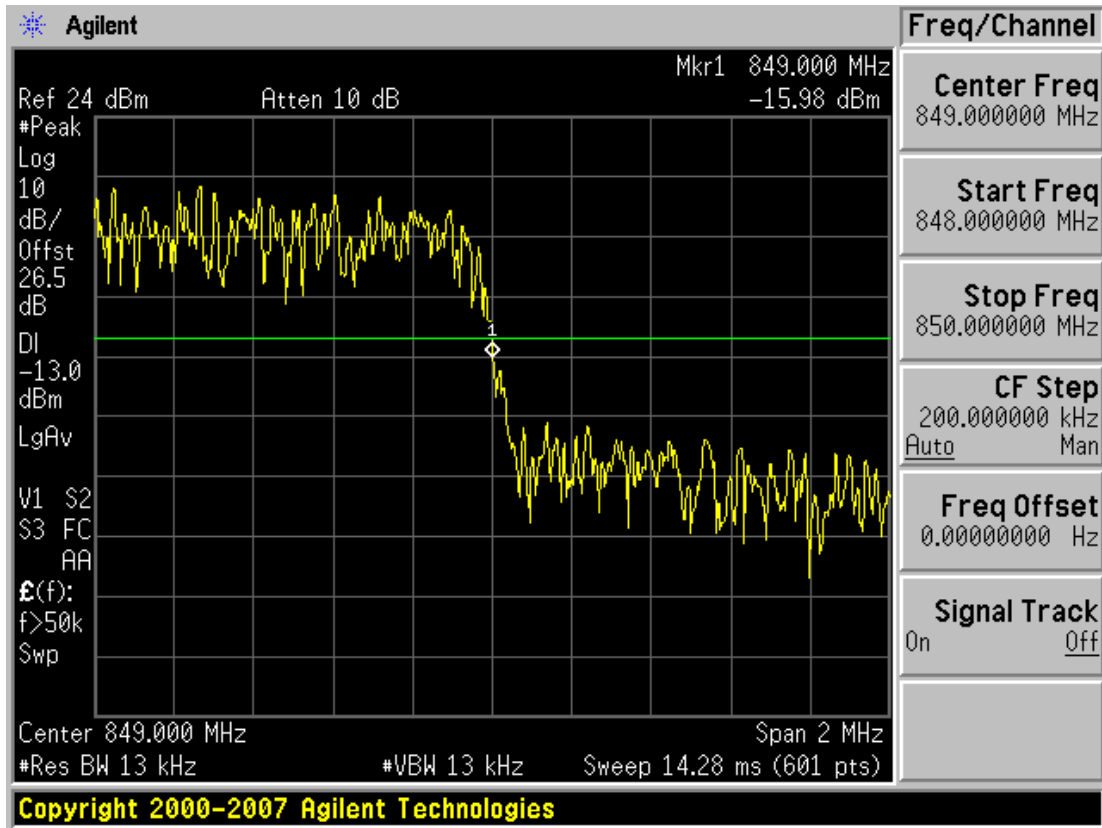

■ CDMA MODE (1013 CH.) 4 MHz Span

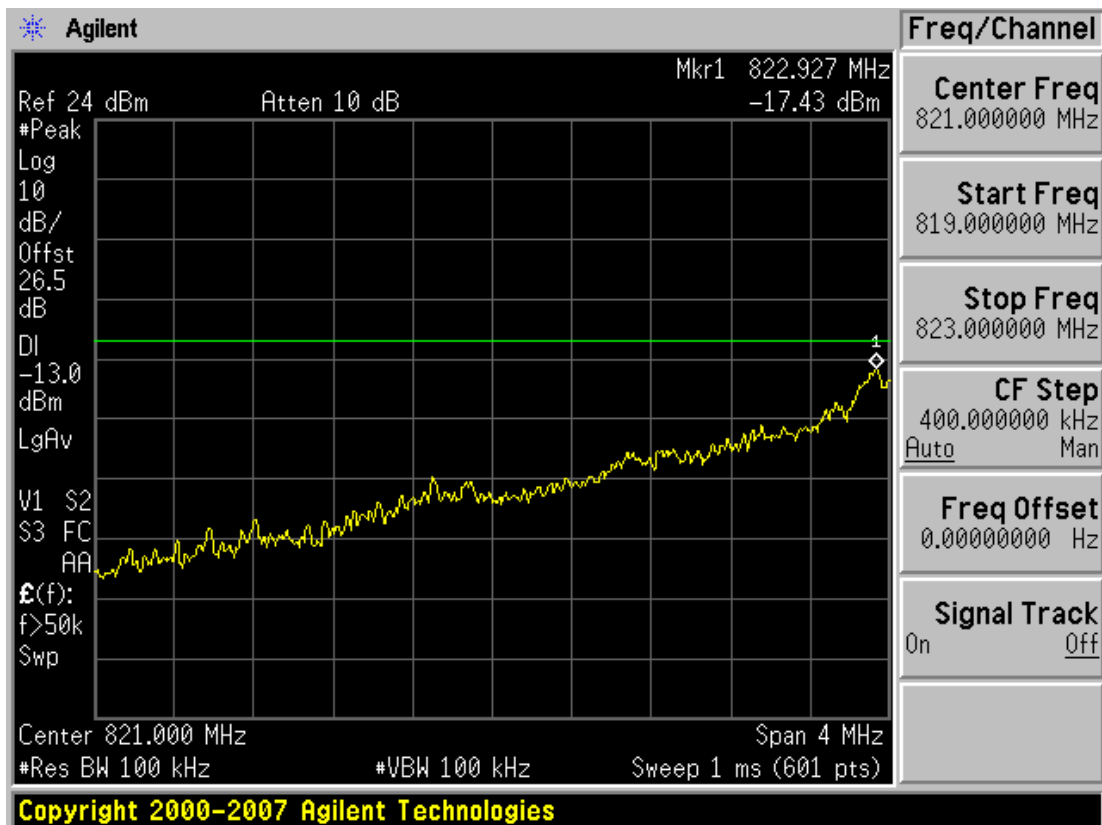



■ CDMA MODE (777 CH.) 4 MHz Span

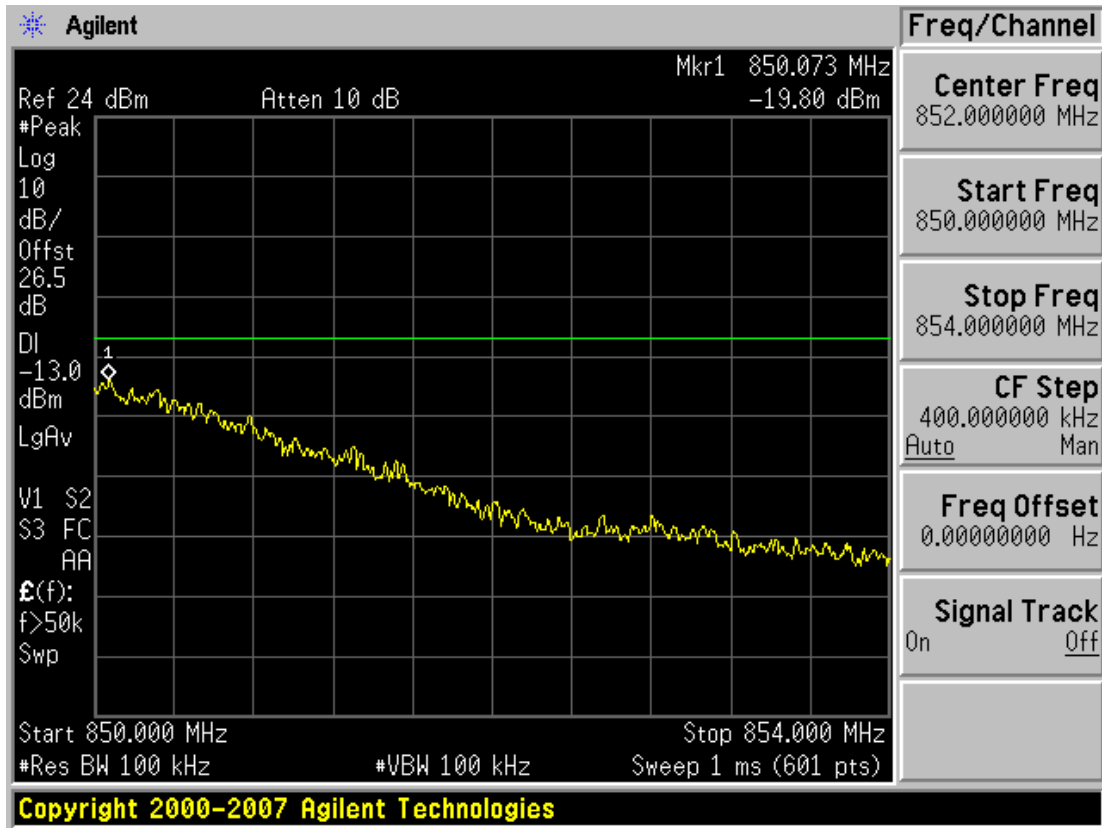

■ PCS CDMA MODE (25 CH.) Block Edge

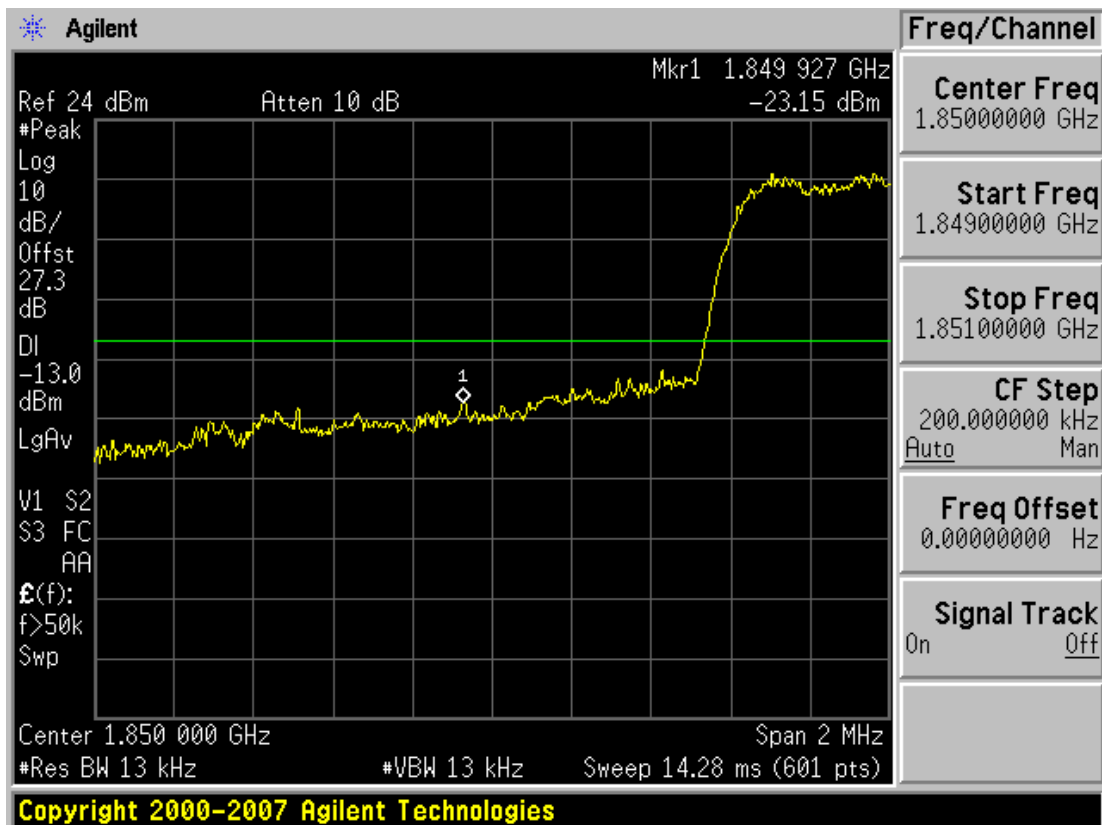



■ PCS CDMA MODE (1175 CH.) Block Edge

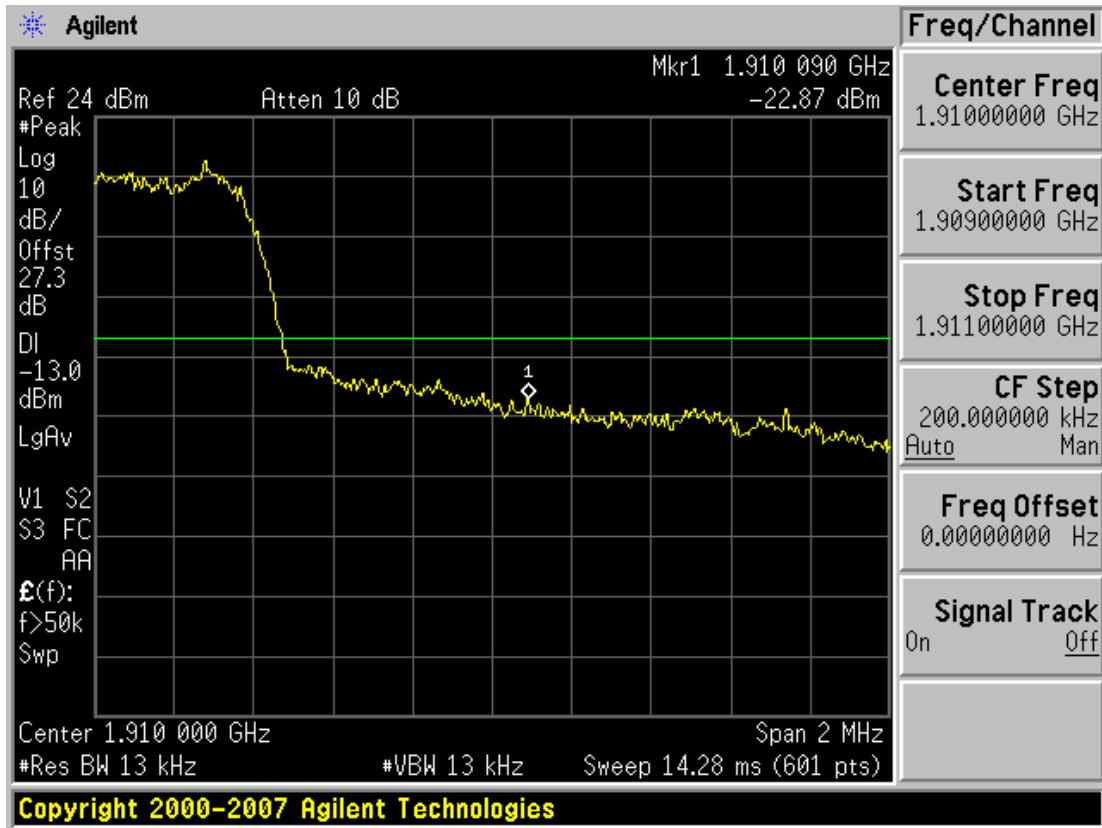

■ PCS CDMA MODE (25 CH.) 4 MHz Span

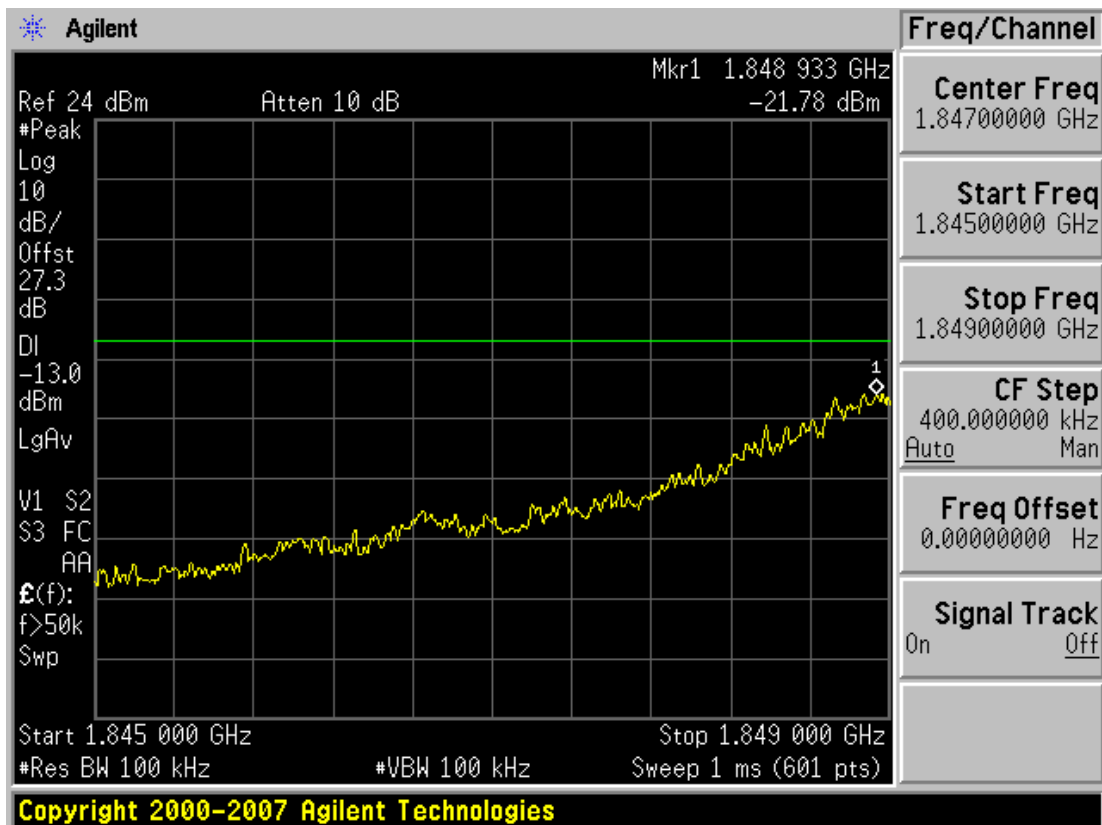



■ PCS CDMA MODE (1175 CH.) 4 MHz Span

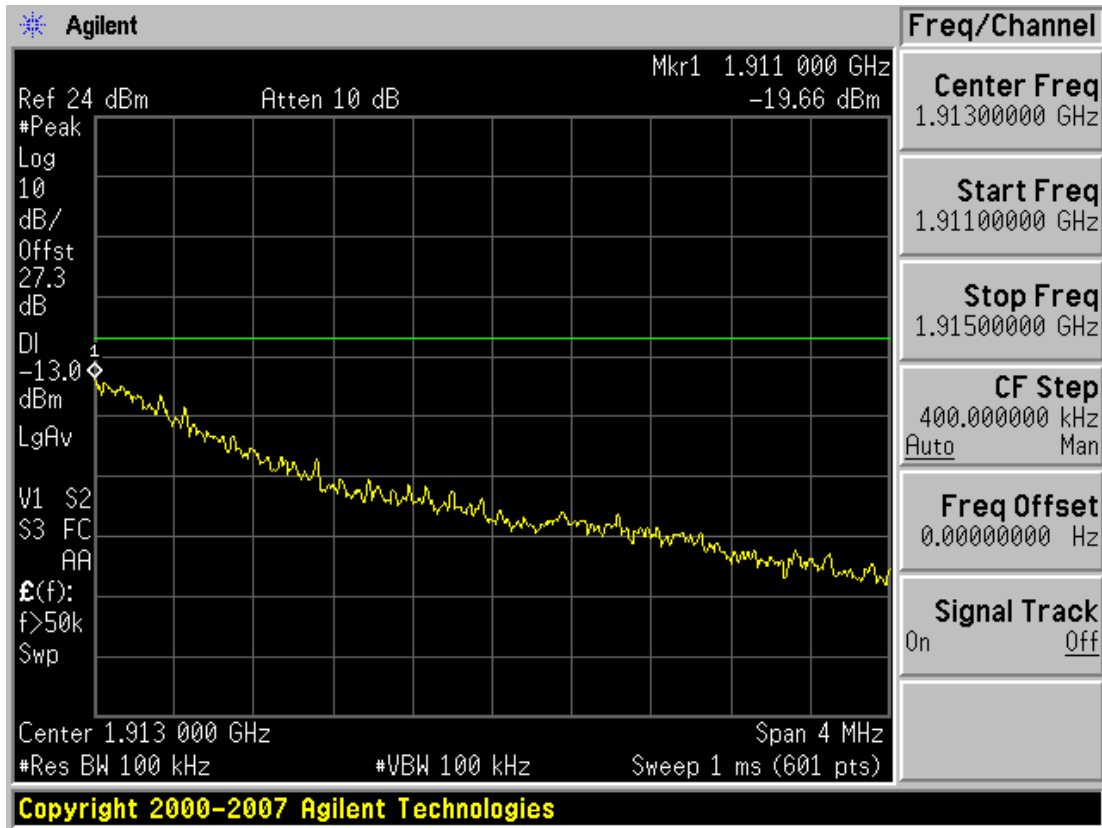

■ AWS CDMA MODE (25 CH.) Block Edge

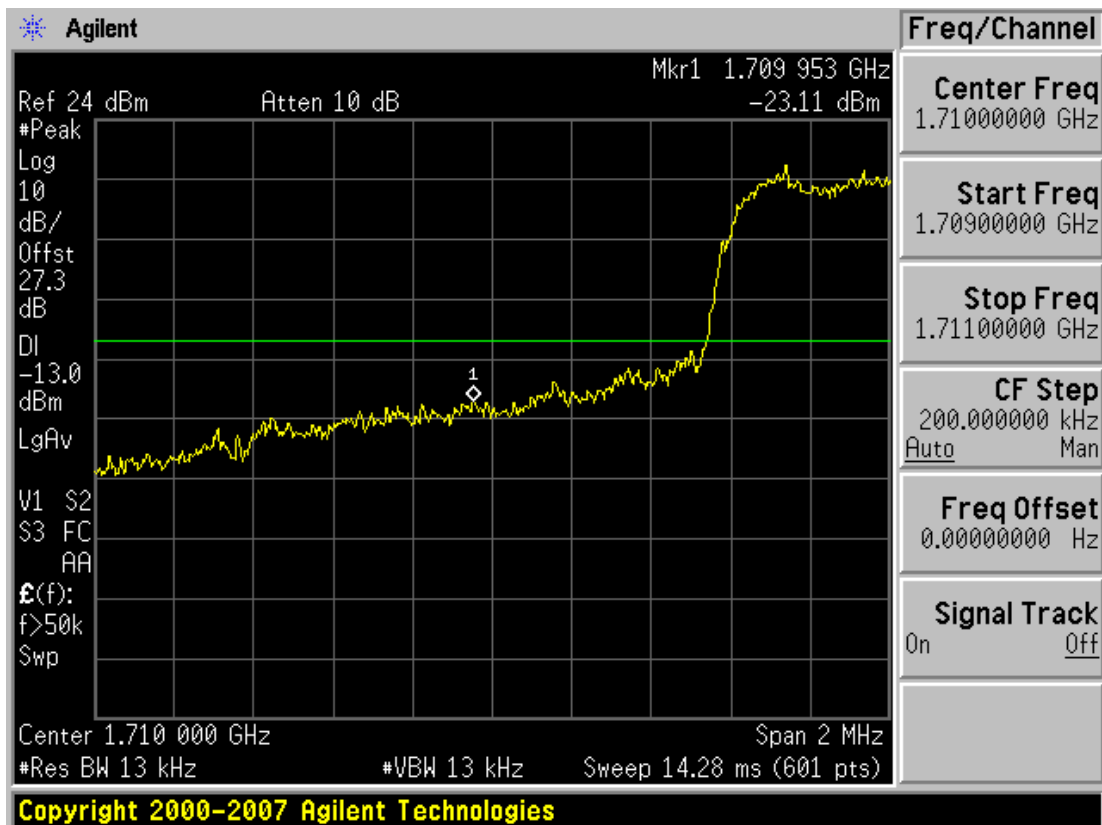



■ AWS CDMA MODE (875 CH.) Block Edge

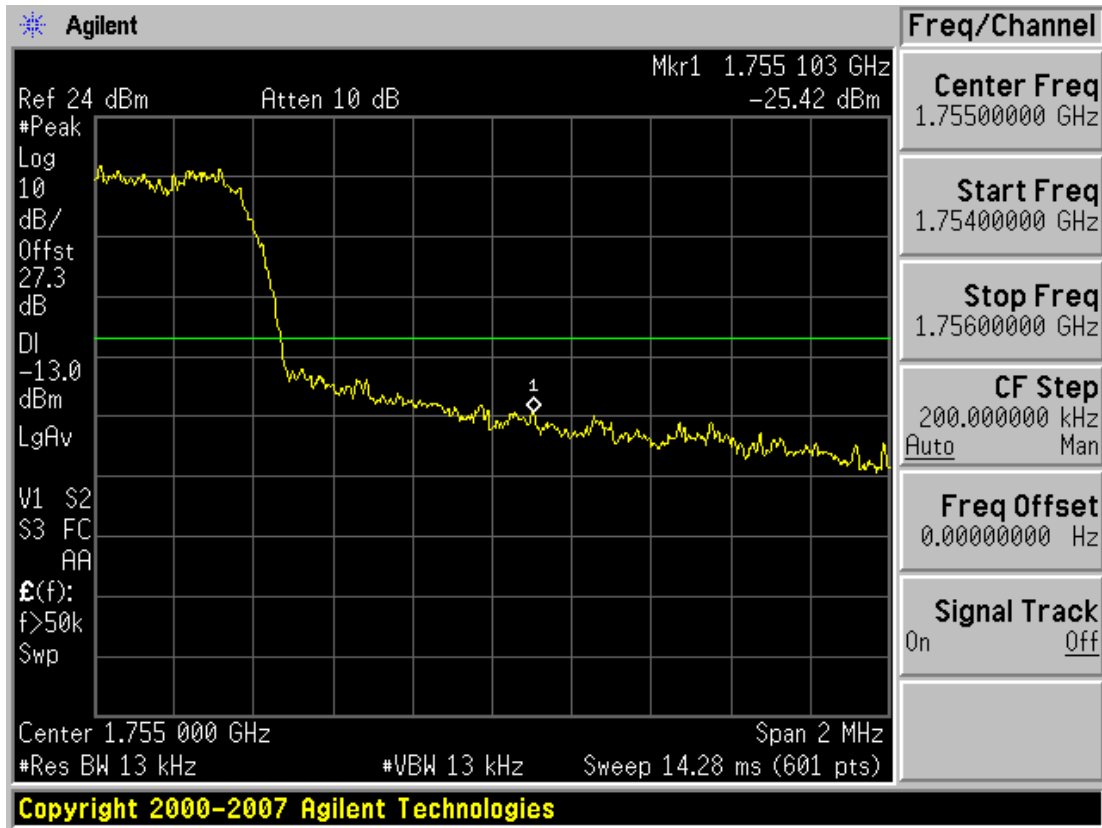

■ AWS CDMA MODE (25 CH.) 4 MHz Span

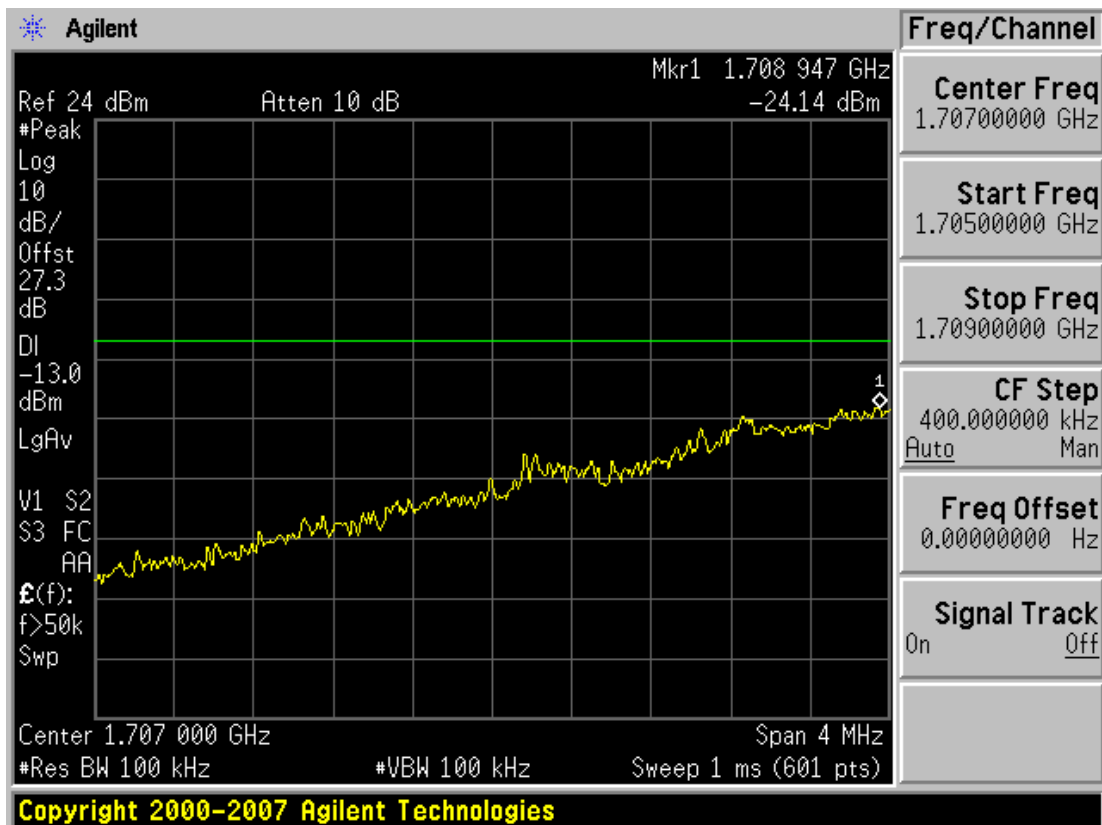



■ AWS CDMA MODE (875 CH.) 4 MHz Span

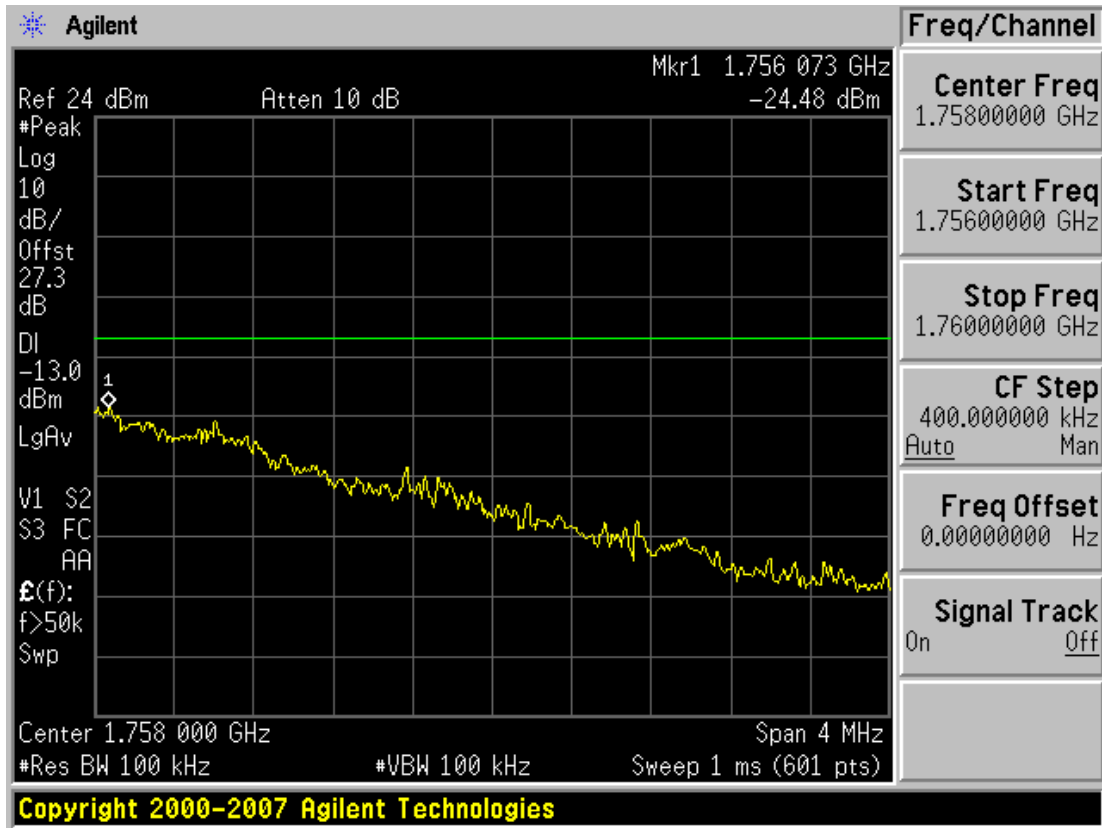

■ CDMA MODE (1013 CH.) Conducted Spurious Emissions - 1

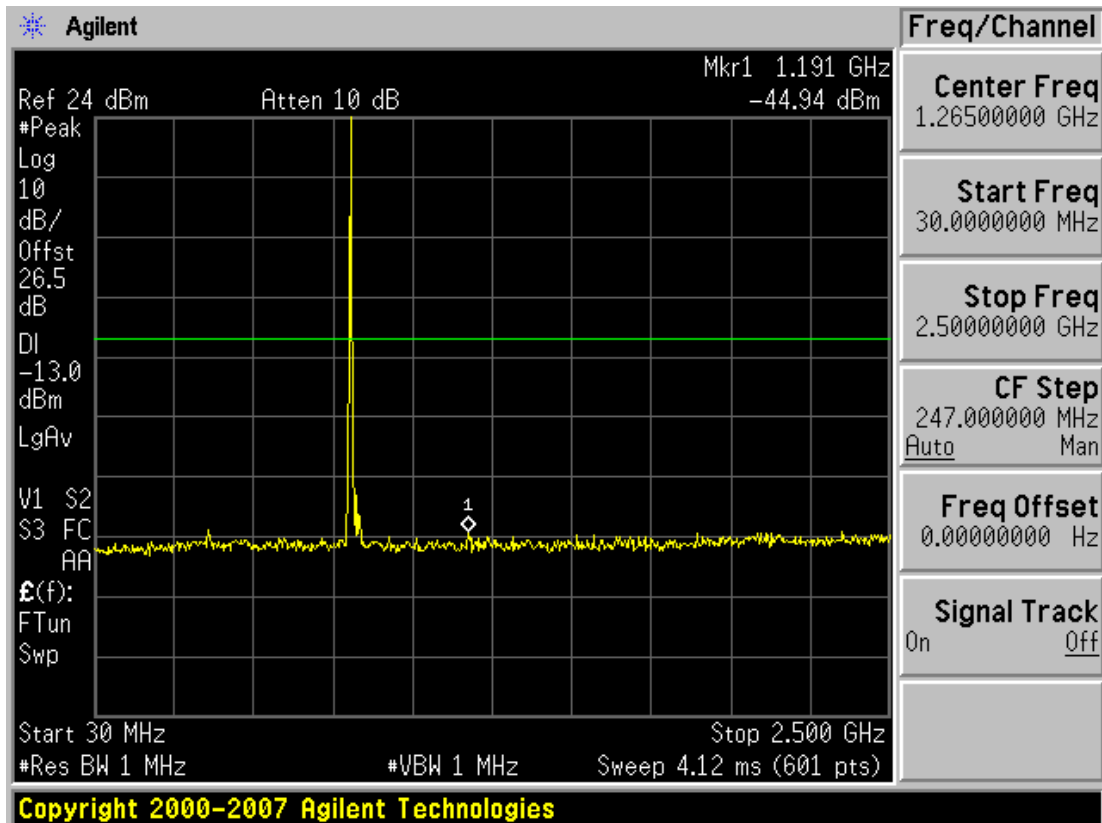



■ CDMA MODE (1013 CH.) Conducted Spurious Emissions - 2

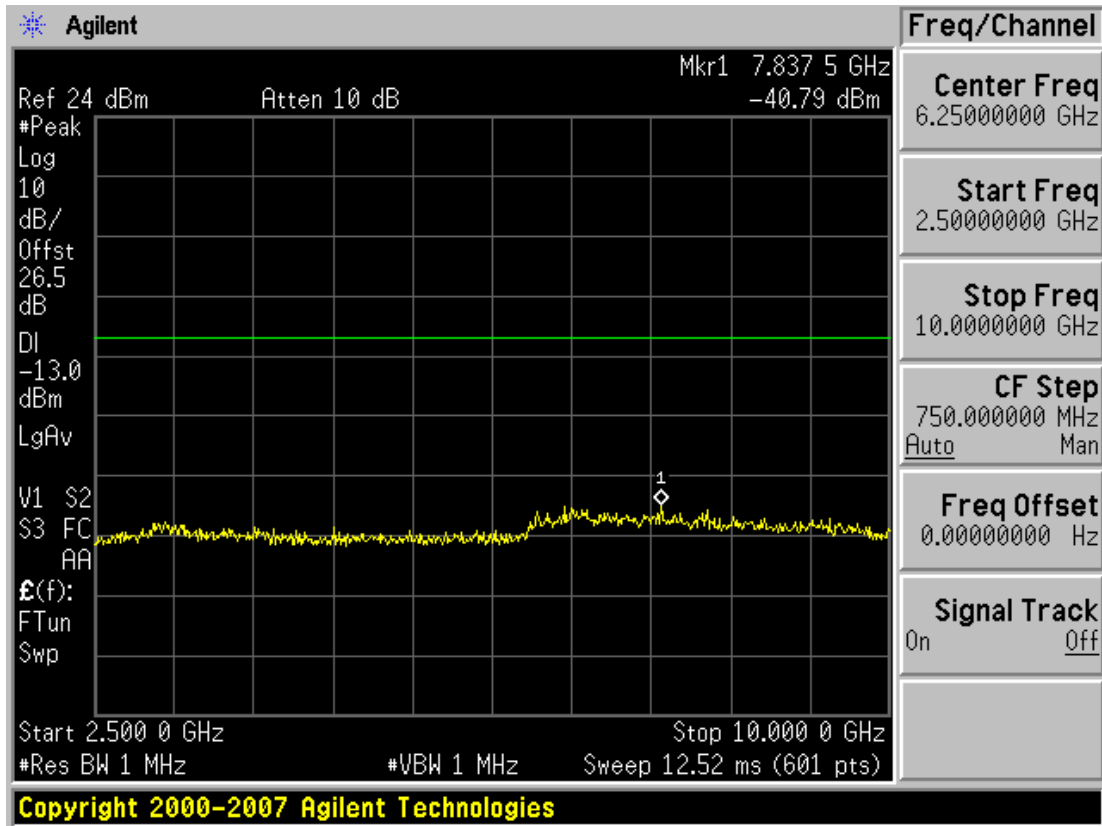

■ CDMA MODE (384 CH.) Conducted Spurious Emissions - 1

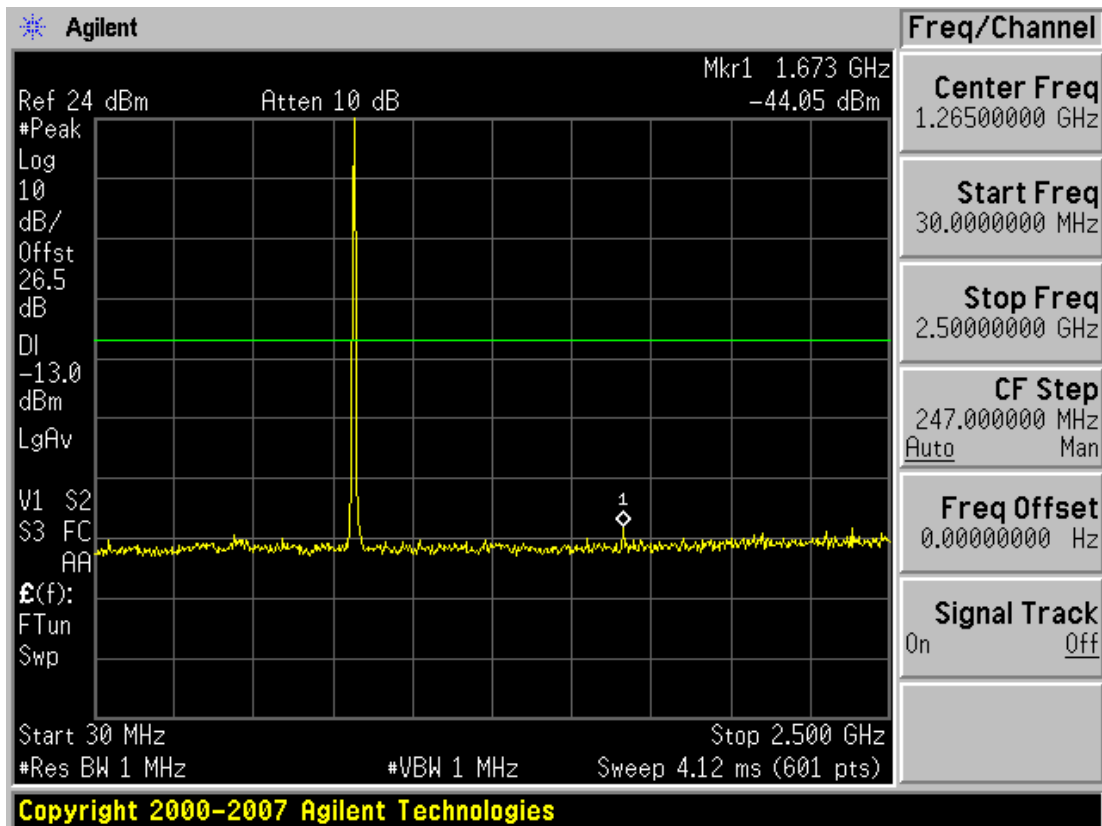

■ CDMA MODE (384 CH.) Conducted Spurious Emissions - 2

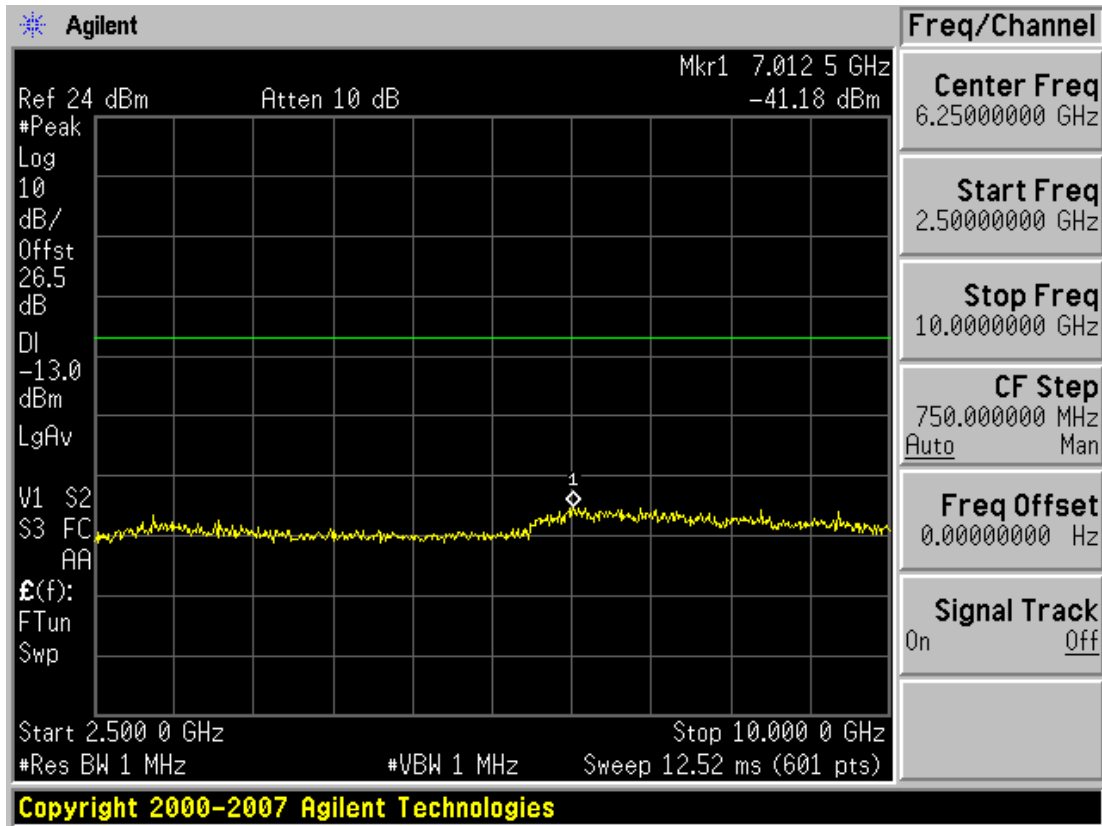

■ CDMA MODE (777 CH.) Conducted Spurious Emissions - 1

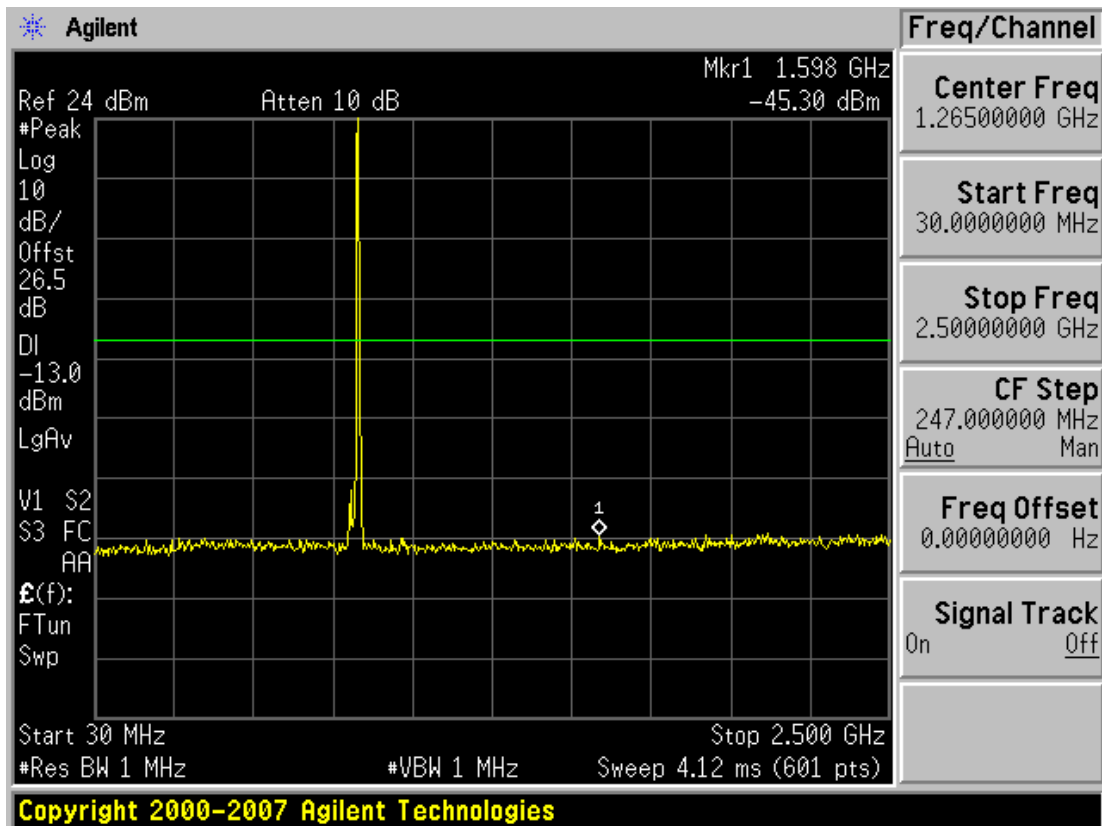

■ CDMA MODE (777 CH.) Conducted Spurious Emissions - 2

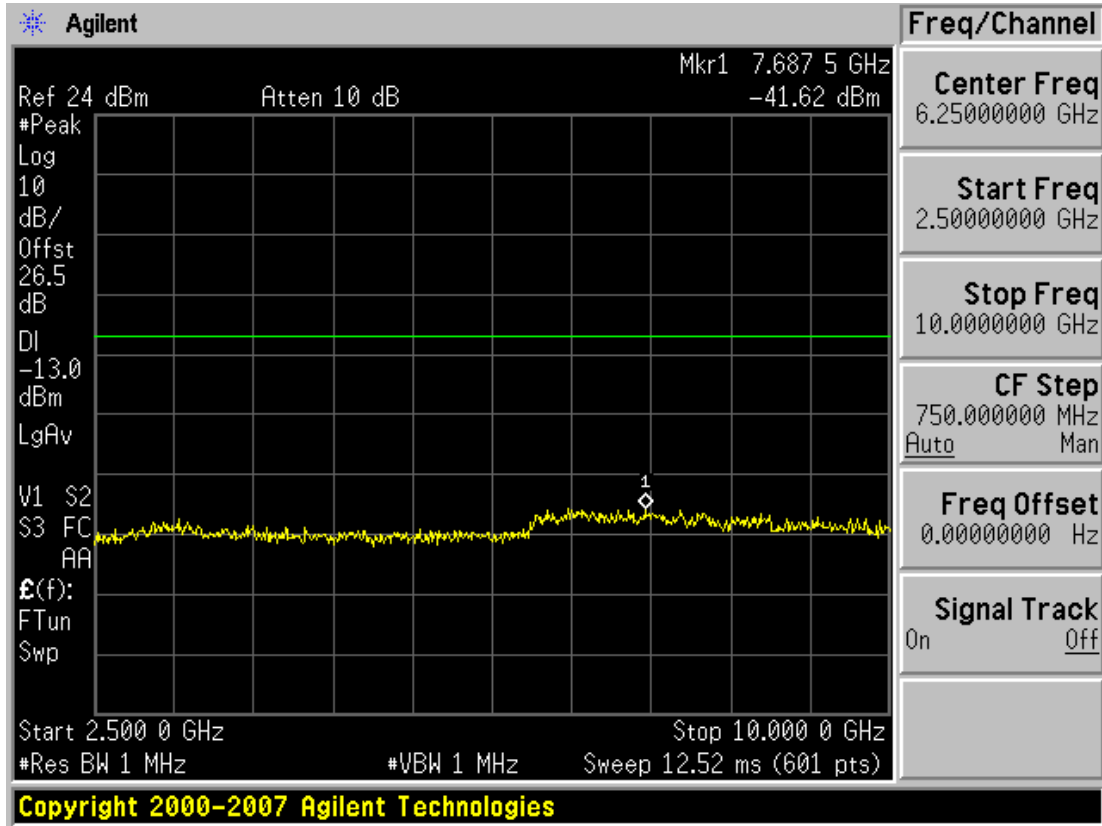

■ PCS CDMA MODE (25 CH.) Conducted Spurious Emissions - 1

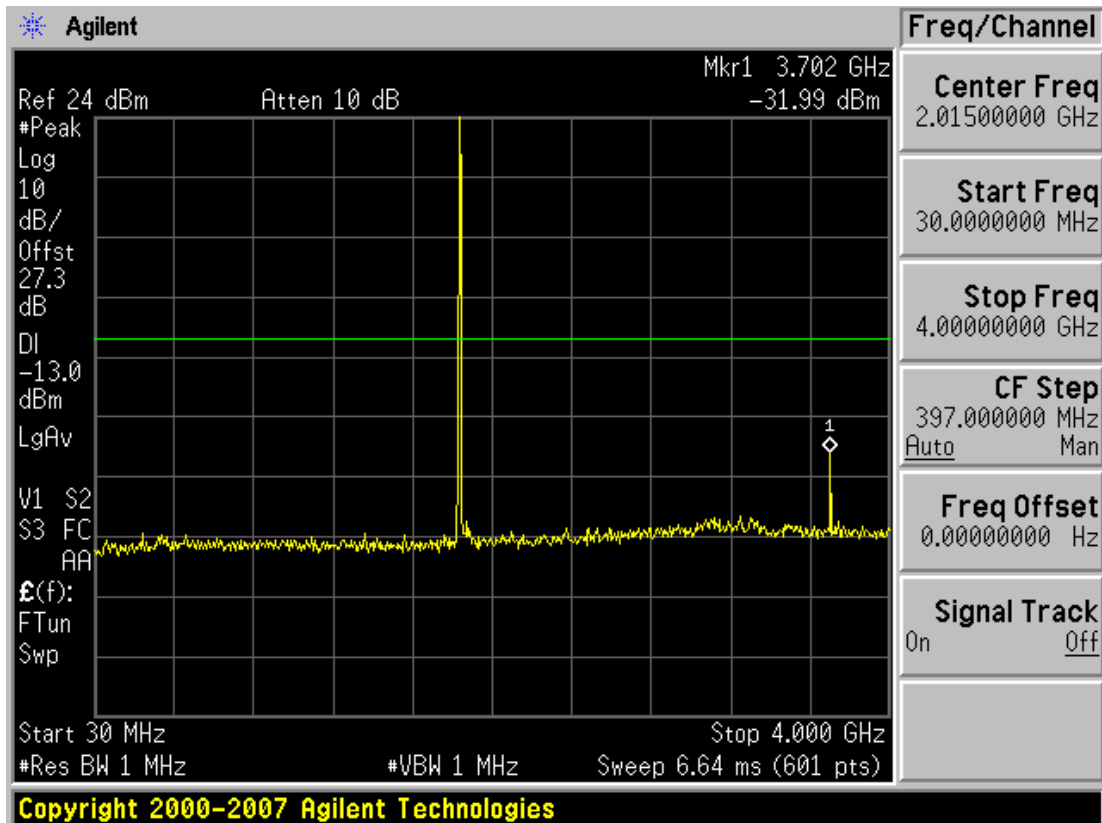



■ PCS CDMA MODE (25 CH.) Conducted Spurious Emissions - 2

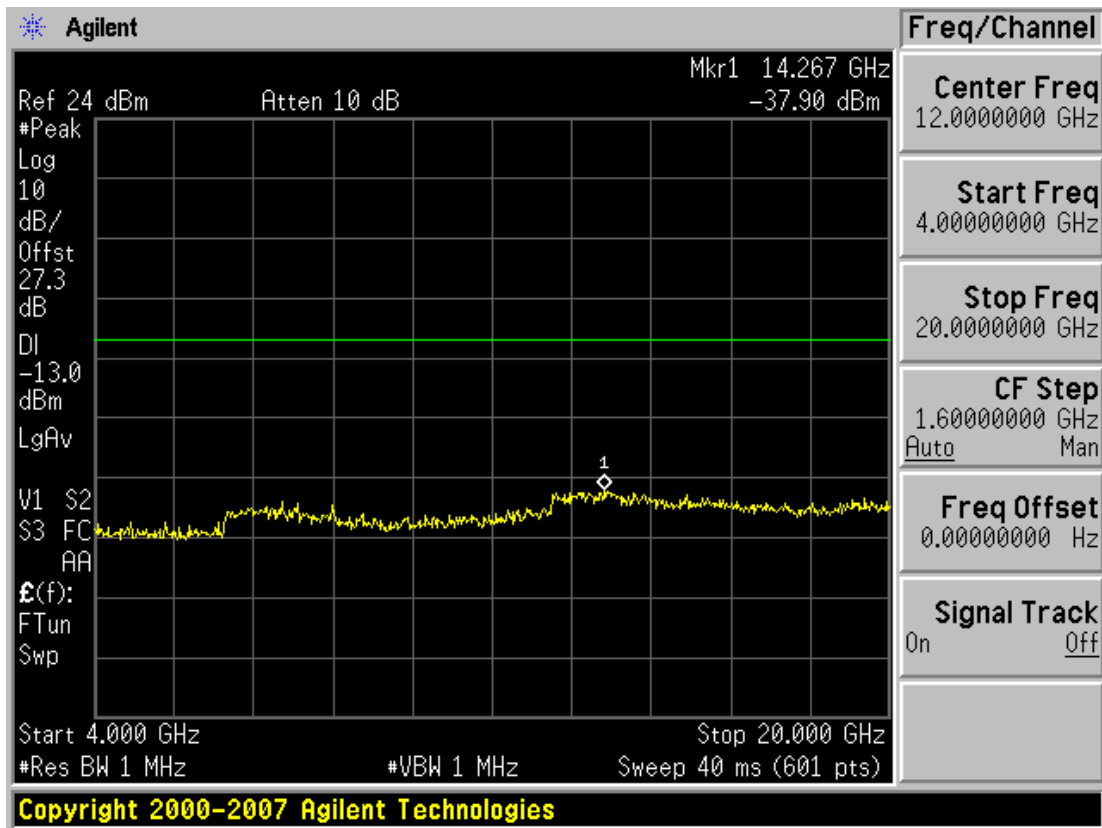

■ PCS CDMA MODE (600 CH.) Conducted Spurious Emissions - 1

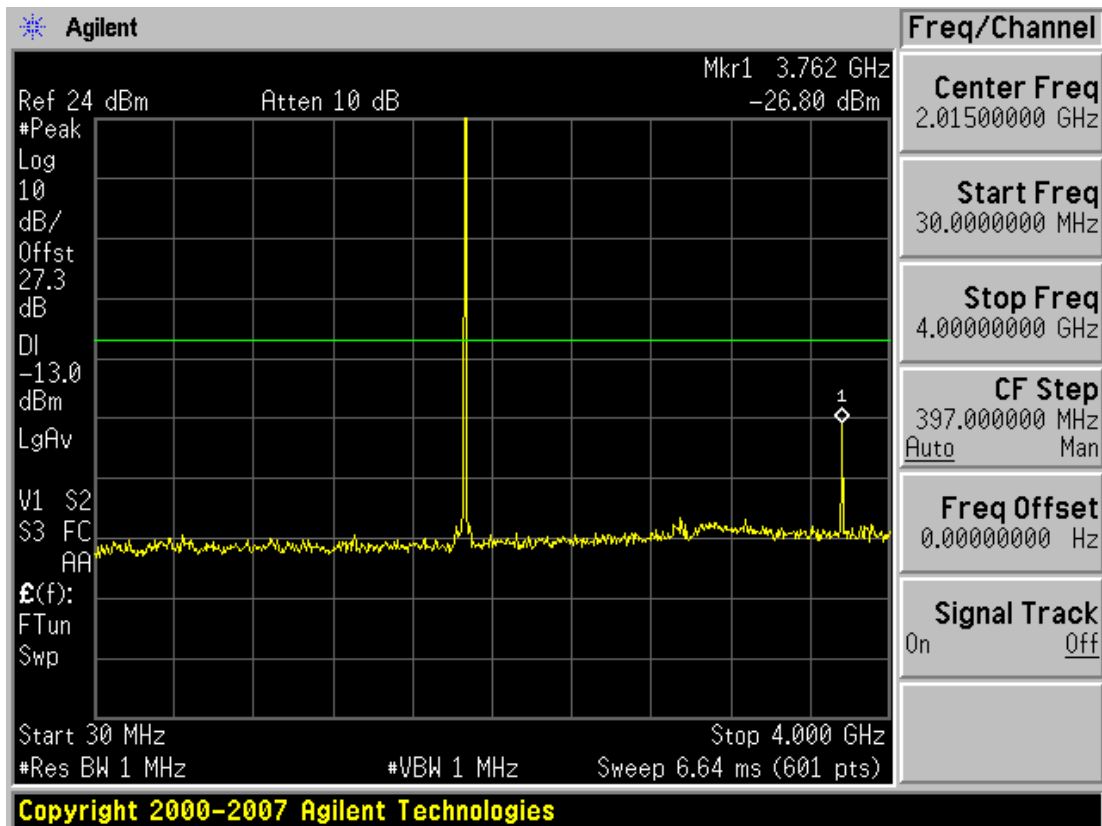



■ PCS CDMA MODE (600 CH.) Conducted Spurious Emissions - 2

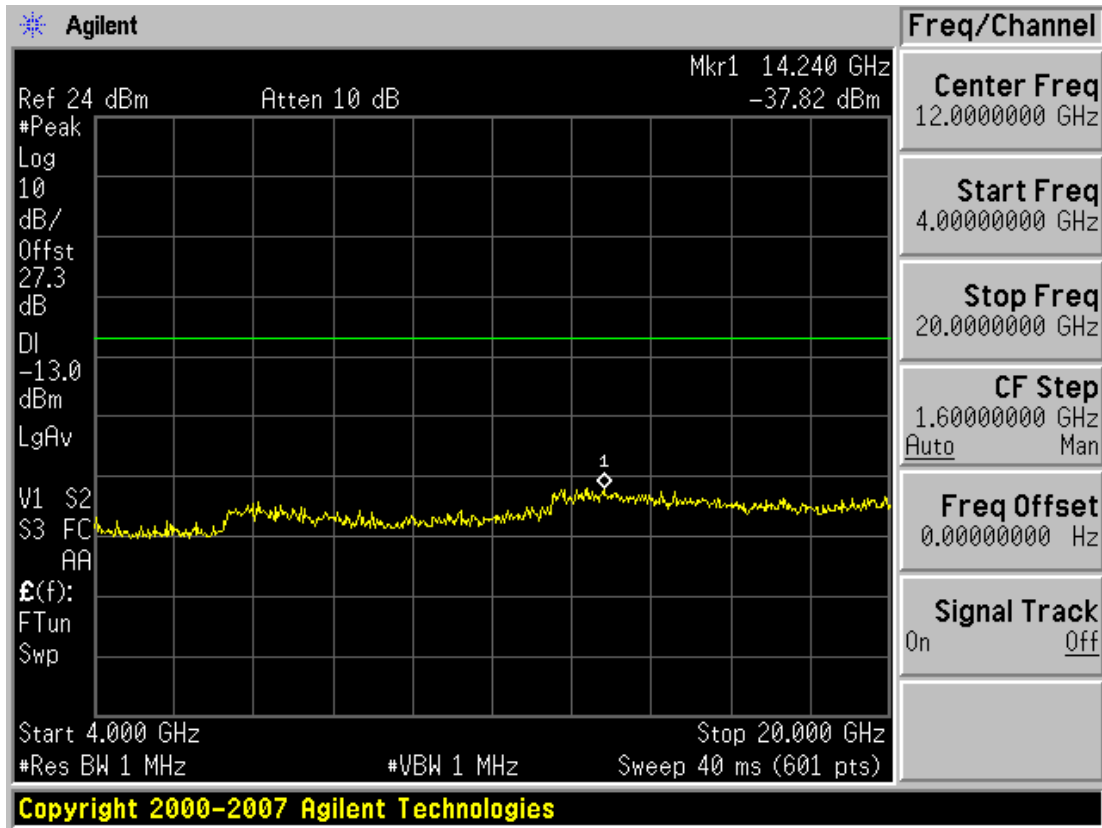

■ PCS CDMA MODE (1175 CH.) Conducted Spurious Emissions - 1

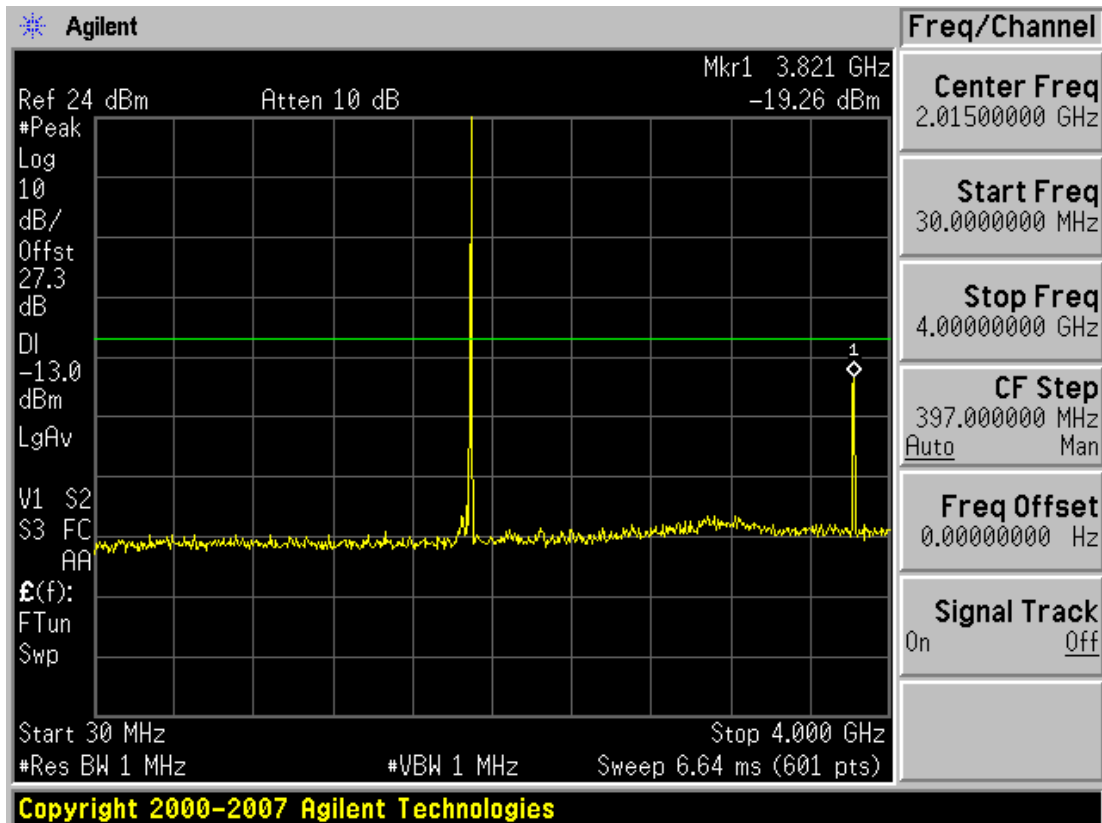

■ PCS CDMA MODE (1175 CH.) Conducted Spurious Emissions - 2

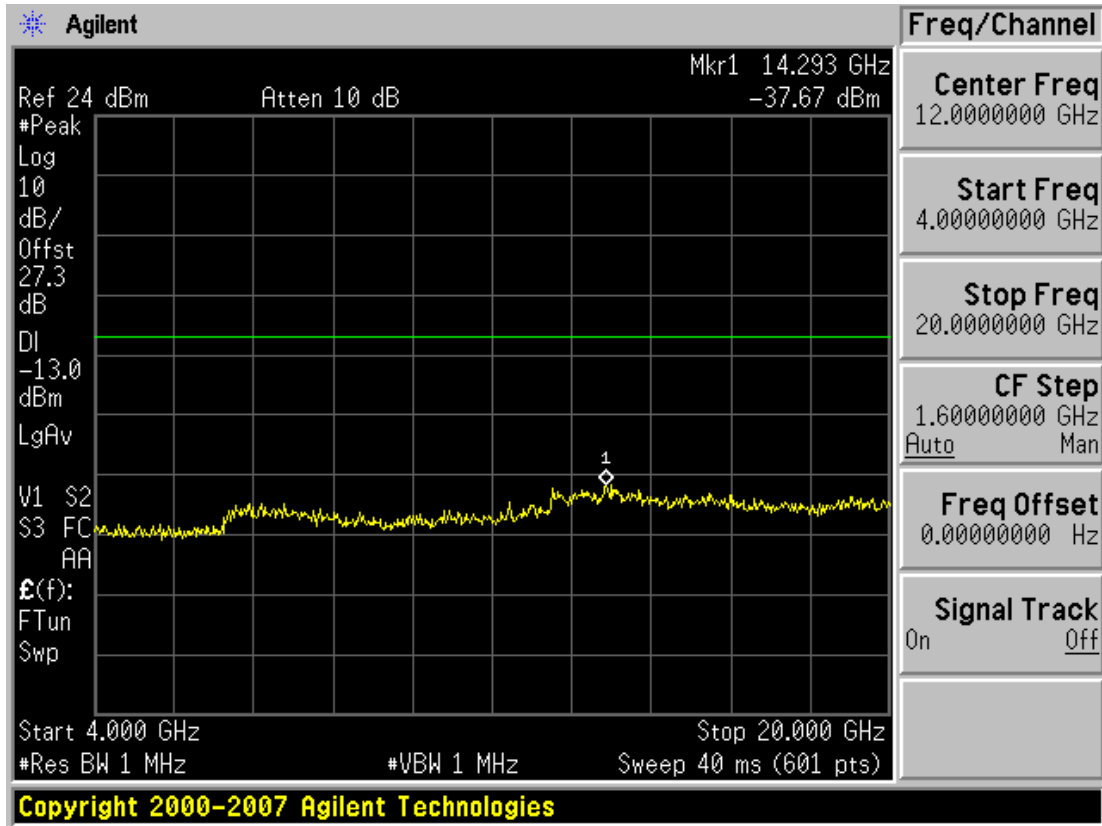

■ AWS CDMA MODE (25 CH.) Conducted Spurious Emissions - 1

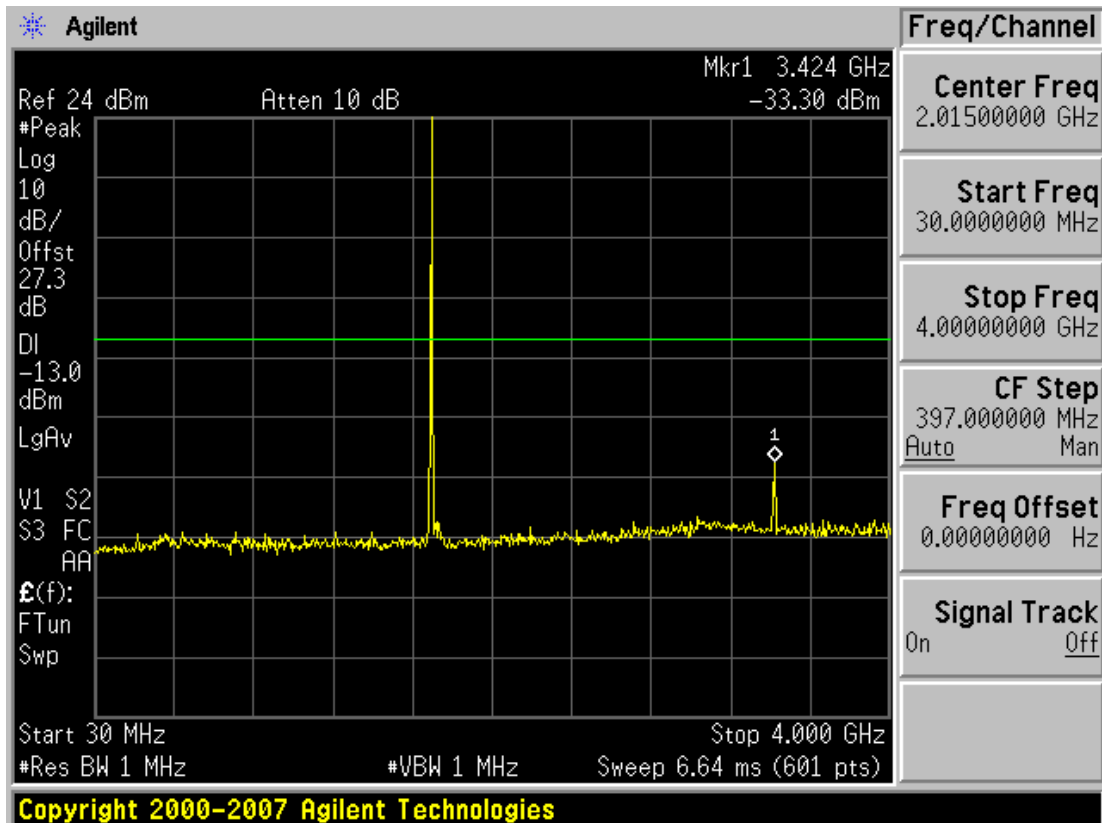

■ AWS CDMA MODE (25 CH.) Conducted Spurious Emissions - 2

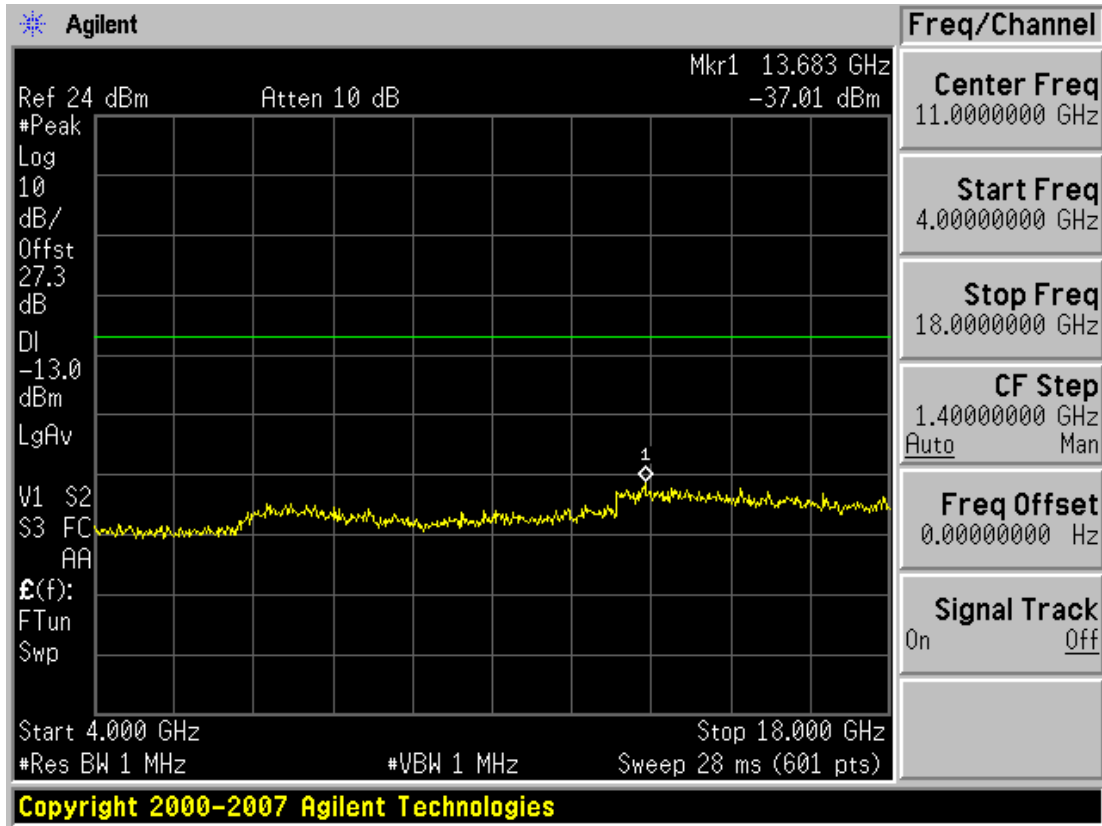

■ AWS CDMA MODE (450 CH.) Conducted Spurious Emissions - 1

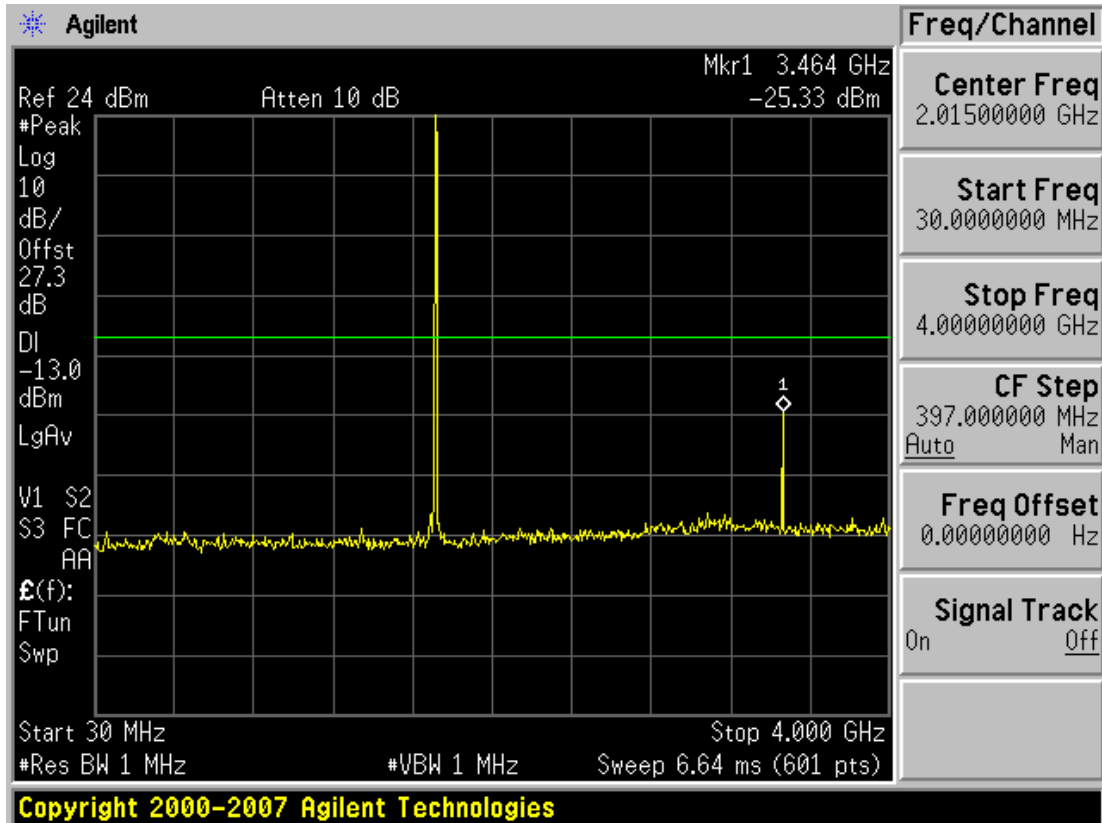



■ AWS CDMA MODE (450 CH.) Conducted Spurious Emissions - 2

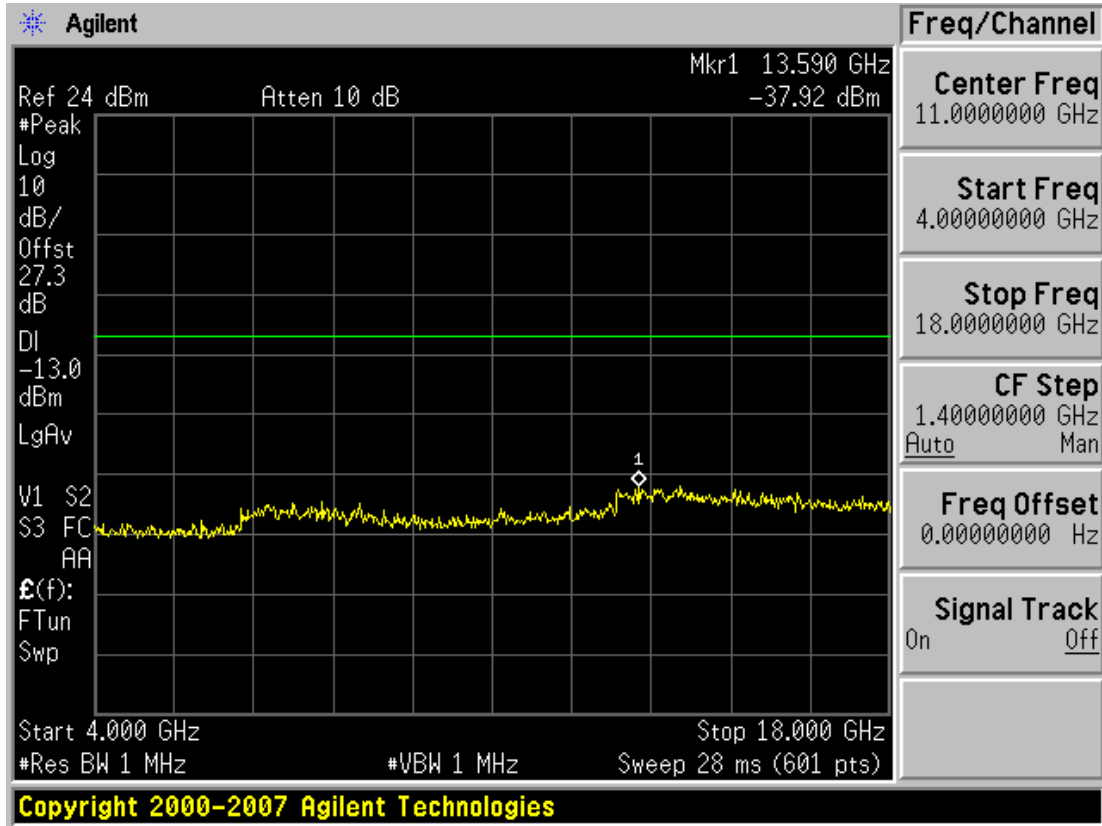

■ AWS CDMA MODE (875 CH.) Conducted Spurious Emissions - 1

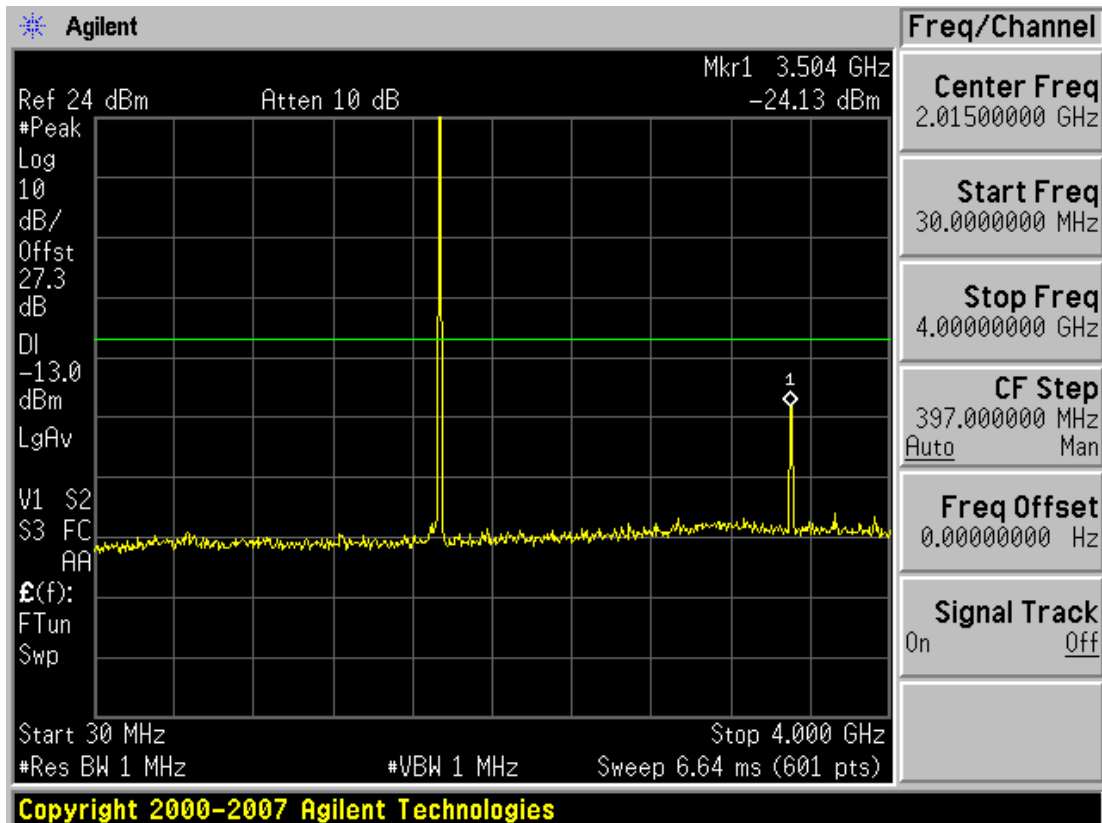



■ AWS CDMA MODE (875 CH.) Conducted Spurious Emissions - 2

